



HAL
open science

Facilitating reuse of planetary spatial research data – Conceptualizing an open map repository as part of a Planetary Research Data Infrastructure

Andrea Nass, Kristine Asch, Stephan van Gasselt, Angelo Pio Rossi, Sebastien Besse, Baptiste Cecconi, Alessandro Frigeri, Trent Hare, Henrik Hargitai, Nicolas Manaud

► To cite this version:

Andrea Nass, Kristine Asch, Stephan van Gasselt, Angelo Pio Rossi, Sebastien Besse, et al.. Facilitating reuse of planetary spatial research data – Conceptualizing an open map repository as part of a Planetary Research Data Infrastructure. *Planetary and Space Science*, 2021, 204, pp.105269. 10.1016/j.pss.2021.105269 . hal-03968734

HAL Id: hal-03968734

<https://hal.science/hal-03968734>

Submitted on 1 Feb 2023

HAL is a multi-disciplinary open access archive for the deposit and dissemination of scientific research documents, whether they are published or not. The documents may come from teaching and research institutions in France or abroad, or from public or private research centers.

L'archive ouverte pluridisciplinaire **HAL**, est destinée au dépôt et à la diffusion de documents scientifiques de niveau recherche, publiés ou non, émanant des établissements d'enseignement et de recherche français ou étrangers, des laboratoires publics ou privés.



Facilitating reuse of planetary spatial research data – Conceptualizing an open map repository as part of a Planetary Research Data Infrastructure



Andrea Nass^{a,*}, Kristine Asch^b, Stephan van Gasselt^c, Angelo Pio Rossi^d, Sebastien Besse^e, Baptiste Cecconi^f, Alessandro Frigeri^g, Trent Hare^h, Henrik Hargitaiⁱ, Nicolas Manaud^j

^a Institute of Planetary Research, German Aerospace Centre (DLR), Berlin, Germany

^b Federal Institute for Geosciences and Natural Resources (BGR), Hannover, Germany

^c Department of Land Economics, National Chengchi University (NCCU), Taipei, Taiwan

^d Department of Physics and Earth Sciences, Jacobs University Bremen, Bremen, Germany

^e Aurora Technology BV for ESA, European Space Agency (ESA), Madrid, Spain

^f Observatoire de Paris, Université Paris Sciences et Lettres (PSL), CNRS, France

^g Istituto Nazionale di Astrofisica (INAF), Istituto di Astrofisica e Planetologia Spaziali (IAPS), Rome, Italy

^h United States Geological Survey, Astrogeology Science Center (USGS), Flagstaff, United States

ⁱ Department of Communication and Media, Eötvös Loránd University (ELTE), Budapest, Hungary

^j SpaceFrog Design, Toulouse, France

ARTICLE INFO

Keywords:

Cartography
Planetary mapping
Research data reuse
Research data infrastructure
SDI
Spatial data models

ABSTRACT

In recent decades, the research community has been dealing with a growing amount and variety of new research data and derived research information. While primary research data, as derived from instruments, are commonly well maintained, derived research data might not always share the same fate. Scientific studies, resulting in further derived data, what we will call here as research data, does not often share the same attention. Fortunately, in the planetary sciences, most primary research data are commonly freely accessible for researchers to use, while research results have commonly not been re-inserted into the research cycle and a discussion about the process has only recently been initiated but there are not concrete methods or efforts to maintain this derived research data. We here discuss the requirements and needs in the planetary sciences to develop and coordinate a platform for research data and develop this idea using planetary cartographic products as an example of a higher-level research product that undergoes various development stages across different organizational levels. We here will visit the current practice and provide a number of scenarios showing how such a research-data life-cycle could look like in the field of planetary research. In order to develop a conceptual framework, experience from established terrestrial research-data frameworks and spatial data infrastructures are integrated into the discussion.

1. Introduction

1.1. Overview

In today's research landscape, data obtained and derived through a controlled process are playing a key role for advancing knowledge and for building foundations for future research. Research data (RD) are described as *factual records (...) used as primary sources for scientific research, and that are commonly accepted in the scientific community as necessary to validate research findings* (OECD, 2007). The amount and variety of raw data and research data that the research community is dealing with on an everyday basis have been increasing exponentially

over the last decades, with unstructured data growing at up to ten times faster rates than structured data (e.g., Zikopoulos et al., 2012; Kitchin, 2014). This development applies to the majority of professional fields targeted at the processing of low-level data to derive meaningful information products for analysis and research.

In order to provide platforms to facilitate use and reuse of RD in a transparent and sustainable way, research initiatives such as the *Research Data Alliance (RDA)* (www.rda-alliance.org), *GoFAIR* (www.go-fair.org), or *CODATA* (www.codata.org) have been established, who have been contributing with recommendation and guidelines. Some of these initiatives' higher-level aims are targeted at responding to requirements related to public research funding as communicated by, e.g., OECD

* Corresponding author.

E-mail address: andrea.nass@dlr.de (A. Nass).

<https://doi.org/10.1016/j.pss.2021.105269>

Received 24 January 2021; Received in revised form 24 April 2021; Accepted 24 May 2021

Available online 4 June 2021

0032-0633/© 2021 The Authors. Published by Elsevier Ltd. This is an open access article under the CC BY license (<http://creativecommons.org/licenses/by/4.0/>).

(2007). These are targeted (1) to provide recommendations and specifications facilitating sustainable research repositories and best practice, (2) to demonstrate examples and use-cases of good practice, (3) to sensitize researchers and research institutions regarding their responsibility to increase re-usability of research data, (4) to create awareness for working with open data, (5) to provide a platform to increase visibility for research results, or (6) to conquer demands of a growing and highly distributed world of research with its provision of research data (e.g., Go FAIR Initiative, 2020; RDA-IWG, 2017; Bahim et al., 2019; Clare et al., 2019; Martinez et al., 2019; Wu et al., 2019).

Due to such activity and the gradual increase of awareness that the research landscape as well as organizations are experiencing, the field of *Research Data Management (RDM)* has been gaining considerable momentum over the last decade. Management of RD for future reuse has become an integral part of the research and publication process and the obligation of fulfilling such management tasks is starting to become hard-wired into proposals and manuscripts submitted to research foundations and publishers, respectively. Repositories, such as *figshare* (www.figshare.com), *zenodo* (www.zenodo.org) or *PANGAEA* (www.pangaea.de) have been set up to respond to the need by providing shareable data products and access to material which remains citable, shareable, and discoverable by institutions, publishers and researchers alike.

In order to accomplish efficient RDM and to provide tools across research domains it is important to develop appropriate and effective structures. In that context, *Research Data Infrastructures (RDI)* have the primary goal of collecting existing data under uniform guidelines and to make data accessible in defined ways. RDI initiatives supports the establishment of research management practices, including adopted metadata standards, research lifecycle and associated infrastructures. E.g. *The European Open Science Cloud (EOSC)* (www.eosc.eu) as RDI undertaking, “aims to federate existing and future RDI - across disciplines - under a single umbrella, and provides (open) services for the European researcher community.” (Latif et al., 2019, p. 2) They are targeted to provide faster and more efficient data access in order to pool resources and avoid duplication where redundancy is technically not needed.

The strategies and developments of RDIs can be assigned to another larger structure that has been established at the end of last century. Due to a rapidly growing need for spatial data management and analysis, and the increasing number of user groups involved in dealing with spatial data, *Spatial Data Infrastructures (SDIs)* have become a major subfield of infrastructure research and development (e.g., Williamson et al., 2003). A SDI “goes far beyond surveying and mapping, it provides an environment within which organizations and/or nations interact with technologies to foster activities for using, managing and producing geographic data. [...] They allow the sharing of data, which is extremely useful, as it enables spatial data users and producers to save their efforts when trying to acquire new datasets.” (Rajabifard and Williamson, 2001, p.3).

In the field of planetary remote sensing, terabytes of data from extra-terrestrial planetary bodies are made available to the scientific community today. With the development of new missions, the volume and variety of these data continue to grow. This development has been largely facilitated through developments leading to higher integrated technology allowing to build compact and efficiently performing platforms and instrumentation. A likely other reason might be an increasing international competitive pressure which motivated new developments in sensor technology and mission designs. Along with the increase of raw data volume, the volume of derived RD continue to grow in parallel, albeit at a slower rate.

A large volume of RD that are derived in the field of planetary research carry an explicit spatial component through an absolute reference, or through relative location information, as inherent characteristics, which can thus be described as spatial data and spatial RD. These spatial (research) data serve as fundamental basis for further cartographic products and maps.

Maps, as one example of RD, have been an essential part of planetary research since the beginning of observation and they have been constantly refined and improved since then. Planetary maps range from

image maps to topographic reference maps, to geologic and to landing-site maps. Their variety, however, is naturally limited due to the lack of anthropogenic overprint and lithologic diversity. In order to re-integrate these maps into the research-data life cycle (Corti et al., 2019)¹ and to make them not only available for a sustainable reuse, but also to improve the associated information, further efforts are necessary which are outlined in the following sections.

1.2. Aims and structure

The overarching goal of this contribution is to develop a practical concept, and to address requirements to enable open, transparent and sustainable access to planetary maps as part of the open planetary spatial research data family.

More specifically, our aims are.

1. To provide a review of available map data and to provide a vocabulary and classification of map products used in the planetary sciences;
2. To provide use cases covering map-making processes in the community, from data collection to data provision including their interfaces;
3. To extract user requirements from a high-level requirement analysis;
4. To dissect established experiences from the terrestrial INSPIRE infrastructure, and to transfer lessons and knowledge to planetary use cases;
5. To develop and demonstrate an optimized use case;
6. To subsequently abstract this development and to transfer its characteristics to a wider range of different research product types.

We here refer to *maps* as conventional cartographic visualization products which contain a classical map layout composed of the main map contents (the topics), map frame, map grid information related to at least one cartographic reference system, map scale information, map title and map legend, as well as other map-related metadata information (e.g., Robinson et al., 1995; Hake et al., 2001). These maps can be provided in different formats on various media. Interactive web-based maps and downloadable map-projected raster data lacking a map layout are therefore not further considered here in detail as they do not constitute a cartographic map product in its conventional sense. Thus, a referenced and map-projected data product, nowadays mainly conducted within Geographic Information Systems (GIS), might become an integral part of a map but in itself it does not serve as a map.

In the following section, we briefly summarize the meaning behind research products in general and that of maps specifically in order to establish a terminological framework and provide an overview of available maps and map types. This section will also discuss initiatives dealing with planetary data and targeting at optimizing RD access in the planetary domain in order to help embedding maps as research products. In that section we will also visit research frameworks dealing with making RD available for re-use. In section 3 we introduce methods and tools that we employ to meet aims discussed earlier and to extract information about the current workflows in order to develop a targeted and more efficient approach. Section 4 presents and discusses results from the development process along with a number of use cases. Section 5 finally concludes with a discussion and recommendation on implementation aspects and the expected gain from this process.

While an encompassing discussion about research data will be needed in the future in order to enable RDM, each research dataset and each discipline have their own data specifications and established workflows. We here therefore concentrate on maps as one of the higher-level research products due to their complexity and nature of integrating various data sources within one research product. In particular when we discuss potential scenarios, the selection of research maps will turn out to be beneficial in the overall process and definition of potential interfaces.

¹ <https://www.ukdataservice.ac.uk/manage-data/lifecycle.aspx>.

2. Background

2.1. Planetary mapping, maps and map use

In order to facilitate our discussion, we need to establish the relationship between research data in general and the concepts of *planetary mapping* and *planetary (geologic) maps*, in particular as the latter are the focus in this investigation.

The concept of RD encompasses a wide range of datasets that have been generated for, or were derived from, a process focused on research and the derivation of data through observation and analysis, and which are intended to be shared for re-use in the research community (e.g., Borgman, 2012). This understanding focuses solely on purpose and shall suffice for the further discussion in this work.

Planetary mapping as a concept is neither well defined nor constrained but its related activity has resulted in a large volume and variety of research data of the last decades. Thematically it refers to a variety of activities related to the collection of information from planetary bodies, i.e. subsurface, surface and atmospheres. Some of these concepts are highlighted in, e.g., Greeley and Batson (1990), and more recently in, e.g., Hargitai (2019). Such mapping activity could be (1) systematic instrument-based data acquisition using imaging sensors, infrared or high-energy spectrometers, altimeters, or radar instruments. At the same time, it could also refer to (2) the systematic development of thematic cartographic products. The major difference between both meanings are within their respective relevance in the light of primary research-data value. Map compilation refers to a higher-level derivative process that builds upon distillation of original map data, and thus both need to be carefully distinguished.

However, not only planetary mapping owns different meanings, also the concept of *spatial products* and *maps* are used differently depending on the context.

We refer to *spatial data* and *spatial products* when data have an inherent geographic, or spatial component. These data can be stored as any spatial data model, e.g., raster or vector, and can be located in space due to their inherent object geometry. Such data can be primary data (base data) or derived, secondary data, e.g., image mosaics or contour line. The thematic contents is unambiguously described through attributes and spatial metadata (e.g., Litwin and Rossa, 2011; ISO, 2014a, 2019a,b). The quality of spatial data is determined through examination of its completeness, logical consistency, positional accuracy, temporal accuracy and thematic accuracy.

When talking about *maps* and *map products* we refer to an abstract visual model which itself refers either partially or completely to entities in space. The abstraction comes partially from simplification in to form a model of reality on which a map can focus. A major motivation in the creation of a map is its specific purpose which governs the selection of objects on display. When presented as map sheet or as a digital map additional map elements, such as a legend (key), scale representation, explanatory text are included (cf. Robinson et al., 1995).

The focus of this work is on this last-named form of the map. These can in turn be divided into the following types:

Classical (ortho-) photo- and image maps and derived products such as albedo and airbrush maps are developed from photos and data obtained by imaging instruments, and are eventually assembled to image mosaics of varying degree of internal control. Image maps and map atlases have been published systematically for a small selection of missions (e.g., Roatsch et al., 2016a; b, 2017, 2018). Map data for these missions are accessible via the central planetary archives PDS and PSA (Besse et al., 2018). More historical examples are maps developed and published in the *Surveyor Lunar Photomap and Map Series* or the *Voyager 1 and 2 Atlas* (Batson, 1984). Maps with uncontrolled but map-projected data form the lowest level of derivation as these constitute visualization of spatially referenced basic measurement data. More common are semi-controlled and controlled image (or photo) mosaics that may be used as raster images in subsequent studies as basemaps. Despite being

mono-thematic in nature, image maps are best described as stand-alone reference base maps and are unsuitable for further development due to inherent limitations associated with the particular format.

A second class of maps constitute topographic maps as well as derived hillshade and contour maps based on terrain data obtained from (1) laser ranging (e.g., Kaula et al., 1974; Smith et al., ; Zuber et al., 2010; Steinbrügge et al., 2018), (2) radar measurements (Johnson, 1991; Ford et al., 1993; Wall et al., 1995), or (3) photogrammetric derivations (e.g., Gwinner et al., 2010, 2016; Liu and Wu, 2017; Hu and Wu, 2018). A large number of topographic maps have been published in the earlier days of planetary exploration in the context of the Apollo program. Systematic approaches such as the planned topographic atlas based on HRSC data (Albertz et al., 2004) have been shown to provide visually pleasing results, their specific long-term research value however seemed limited due to the lack of purpose in environments focusing on GIS analysis. Today, most of these data are made available using readily map-projected raster images for GIS integration. Examples are the global topographic maps of a selection of planetary surfaces, such as the Moon or Mars (USGS, 2002, 2003; Hare et al., 2015).

The third class of maps comprises geologic and geomorphologic thematic maps depicting lithologies, processes, ages, i.e. the chronostratigraphy, structural features as well as major landforms. Planetary geologic maps are usually monothematic, i.e. analytical maps in a classical cartographic sense. This interpretation of geologic information differs considerably from terrestrial geologic maps that are usually complex-analytical, multi-thematic maps synthesizing lithologic and stratigraphic information, topography as well as building and landscape information for orientation purposes.

Planetary geologic maps assemble the visual interpretation of landforms, and to a limited degree that of hyperspectral investigations, in order to reconstruct the volcanic and depositional as well as structural history of an area of interest. As such they may form a synthesis of knowledge acquired over different areas at a given scale or scale range. Their use therefore is primarily concentrated on the investigations related to the geologic and structural history. It would therefore be safe to say, that in particular small-scale large-area geologic and geomorphic maps have the sole purpose to synthesize knowledge published over various areas (either as investigation series map or as stand-alone publication) at various time using different kinds of sensors. They are commonly re-used as reference map in journal publications to establish the stratigraphic context of an investigation area or to introduce larger-scale mapping.

A comparably large amount of geologic maps have been made public and spread over a number of websites, publication platforms, and data archives. Despite an increasing number of maps being made available in digital format, most of them are paper-print publications for historical reasons. Recently, maps are made available in digital format with accompanying GIS project files, albeit often in proprietary formats that do not allow much interchange on the project level yet. Most prominent geologic map publications are the *Scientific Investigations Series* maps published by the *United States Geologic Survey* (USGS) hosted at the *USGS Publication Warehouse* or the websites of the *USGS Astrogeology Branch*. A selection of a few notable publications are given in, e.g., Tanaka et al. (2005); Williams et al. (2011); Collins et al. (2013); Tanaka et al. (2014); Fortezzo et al. (2020), or at the *Lunar and Planetary Institute* website² and at the USGS website.³

Other geologic maps have been published in journals with map supplements. Some of these maps have been created systematically under coordinated guidance, such as the *Geologic Maps of Vesta* based on 15 individual quadrangles and published individually as well as unified with a global scale of 1:1,000,000 (e.g., Yingst et al., 2014; Williams et al., 2014, and references cited therein), or the *Geologic Maps of Ceres* based

² <https://www.lpi.usra.edu/resources/mapcatalog/usgs/>.

³ <https://planetarymapping.wr.usgs.gov/Review>.

on 15 individual quadrangles published individually at map scales of 1:500,000 and 1:1,000,000 (Williams et al., 2018). These efforts are still ongoing, and a clean map compilation is expected within the next few years. Additional to that, a fairly and large, yet un-assessed, share of map publications are spread over topical journals and are found by targeted article searches only (e.g., Pondrelli et al., 2011; Debniaik et al., 2017; Pietro et al., 2018; Murana, 2018; Iqbal et al., 2020). With the advent of mapping journals and a richer data base, one can observe an increase of planetary geologic maps publications over the last ten years.

Additional to that, planetary maps have been produced in a number of countries internationally in the last decades. A catalog that lists both historic and recent planetary maps internationally is a bottom-up initiative *The Digital Museum of Planetary Mapping*⁴ that contains data of 2954 maps (Hargitai and Pitura, 2018).

Talking about *reuse* of maps, from a planetary mapper's point of view, this typically involves only a part of the themes or regions on a previous map. The integration of previous cartographic work is most effective if previously made analog maps are digitized, i.e. *renovated*, and digital maps are provided in separable layers, including raster, vector and annotation layers. This separability of georeferenced layers is essential for both creating new cartographic work and re-using and combining themes from maps in a new study (Hargitai, 2016). From such a practical point of view, feature databases, originally either in map or table formats, should prospectively also be included in a spatial repository because they, such as the databases of valley networks or craters on Mars, serve as additional reference and base layers for new maps (e.g., Chuang and Williams, 2018). Single-themed digital feature databases are also produced through mapping and even if the final product is not a classical map, but a data table, or a point, polyline or polygon file, they are just as important for planetary research, as classical map products.

Making these maps available and searchable are paramount to insert these products into a more efficient research re-use. At the time being, central repositories are missing and therefore much needed.

2.2. Planetary research-data initiatives

The user community benefited from public data holdings since their wide availability (Lee, 1991; McMahon, 1996), also outside experiment teams (e.g., Preheim, 1993), as well as more specific mapping-oriented sub-communities and relevant nodes (e.g., Guinness et al., 1996). The formalisation of planetary data access and distribution systems, such as the *Planetary Data System (PDS)*, have their roots in the 1970s and 1980s, driven by earlier NASA planetary missions (e.g., Dobinson, 1992). The community of data users of early planetary experiments was effectively restricted to experiment team members early on. The share of non-team member scientific data users expanded steadily, especially for orbital missions, and it does hold a substantial part of scientific exploitation of mission archive data. Current NASA efforts and funding programs are described in NASA (2018). Here e.g. the *Planetary Data Archiving, Restoration, and Tools (PDART)* is the program element to support future scientific investigations by increasing the quality and amount of digital data products and information for science research and exploration.

Broader coordination and networking activities exist, such as the *International Planetary Data Alliance (IPDA)* (e.g., Crichton et al., 2018), in which several individuals, typically expressed by national or multi-national space agencies hosting data archives, are present.

Research data-focused groups and initiative in the planetary sciences range from institutional, agency-driven groups such as *NASA/USGS Mapping and Planetary Spatial Infrastructure Team (MAPSIT)* (e.g. Radebaugh et al. (2019) and references cited therein), or the *ESA Planetary Science Archive User Group (PSA-UG)* (e.g., Rossi et al., 2014), to bottom-up approaches (e.g., Hargitai, 2016; Manaud et al., 2018b). Such activities rely on voluntary work of members of the community to a large extent.

Community initiatives of a more bottom-up nature started, including efforts such as *OpenPlanetaryMap* (Manaud et al., 2018a; Nass et al., 2019) or *PlanetaryPy* (Godber et al., 2020), which aims at, within the Python development and user community, doing within planetary science what has been successfully performed by other astronomy and space science sub-communities in the last several years, e.g. with *AstroPy* (Robitaille et al., 2013) or *SunPy* (Mumford et al., 2015).

The development of such bottom-up initiatives might be somewhat related to the dataset availability and technology momentum. For example, the first decade of the 21st century recorded a large number of Solar System missions with extensive, multi-TB datasets, associated with an overall increase of computing power and tool availability (increasingly Open Source) compared to the previous decades, with expensive, non-widespread processing and computing equipment and software, smaller amount of data as well as slightly smaller overall funded community. The planetary science community expanded with a multi-national set of data-producing missions ranging from Japan, India, China, Europe and US.

Direct or indirect advice or feedback from the planetary community exists at different levels. For example, ESA PSA (Besse et al., 2018) had established a series of user groups (PSA-UG) to offer independent advice to the archive in the 2000s, in order to better address the need to the planetary community and to better exploit the growing content of the PSA.

Mapping projects, in addition to long-term institutional agency and survey-supported activities such as the USGS mapping program (e.g., Skinner et al., 2019; Williams, 2016), like EU-funded *iMars* (Muller et al., 2016), *Planmap* (e.g., Rossi et al., 2018; Massironi et al., 2018; Semenzato et al., 2020), an interactive online tools for high-level analysis of planetary data like the *Geoportal of Planetary Data* (Karachevtseva et al., 2018), and first ideas to establish a spatial data infrastructure for planetary science (Laura et al., 2017) have a range of community input injected into their processes.

The last three decades recorded a progressive expansion of planetary data infrastructure from data archives and directories to increasingly powerful and complex services (e.g., Crichton et al., 2020).

Formal groups and community initiatives either top-down or bottom-up are not necessarily representative of the actual diversity of the community itself. Nevertheless, the last decade, thanks to wider, well-documented, well-supported and accessible data discovery (Erard et al., 2020; Law et al., 2019) access, services and tools, the global planetary community is moving towards increasing its diversity and inclusivity (e.g., Baratoux et al., 2017; Campbell et al., 2018).

2.3. Terrestrial geospatial networks and infrastructures

An abundance of spatial data have been collected by different national governmental organizations in Europe over the past decades; first on paper, now digitally since the broader availability of digital mapping software, first based on Computer Aided Design software, and now produced with GI Systems mainly. This information has usually been stored within governmental organizations according to national or even organizational standards, in varying data formats, varying technical and scientific classifications, portrayal rules and – depending on mapping tradition and size of the country – at different scales. Furthermore, spatial data were often hidden in the archives within organizations and sometimes not accessible without financial or organization effort for anybody outside the organization or country, such as researchers working on similar topics, governmental institutions and/or the public.

As a consequence, the European-born *INSPIRE* Directive 2007/2/EC was set up to change this situation. The *Infrastructure for SPatial InfoRmation in Europe* (INSPIRE) aims to “provide a legislative framework that will enhance the accessibility of environmentally relevant thematic data for EC-politicians, economists, scientists, and citizens. Optimally these data must be consistent and comparable and they must be provided in their best validated and most useful form. Integrating the environmental

⁴ planetarymapping.elte.hu.

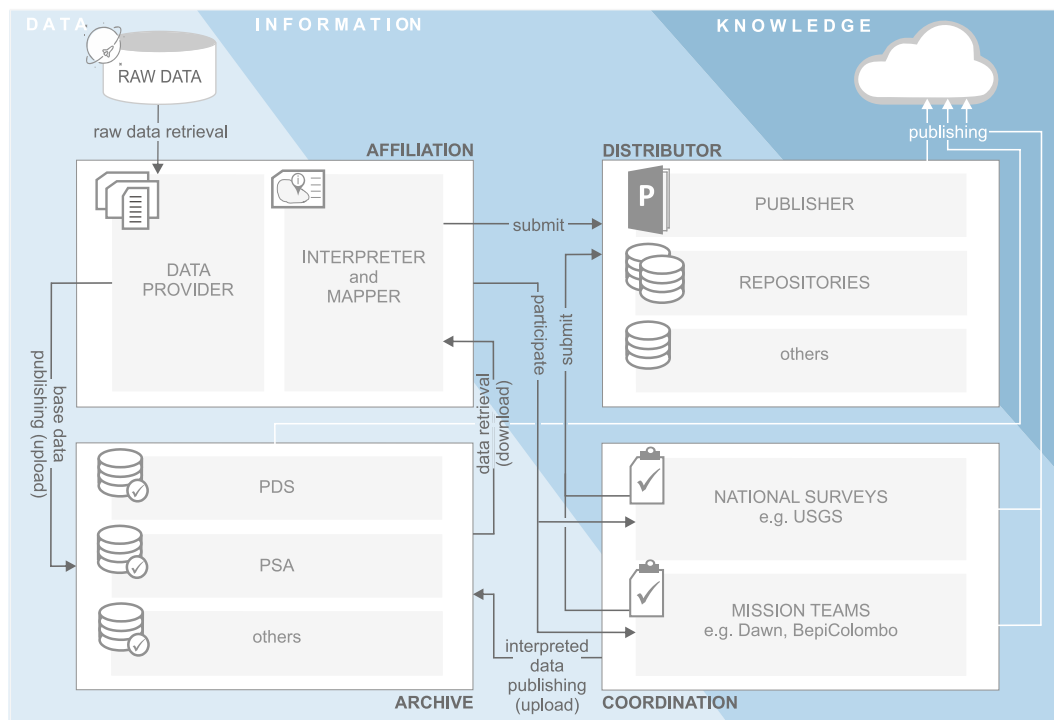

Fig. 1. Visualization of the data refinement process in the Planetary Sciences covering a wide range major elements of the research-data life cycle.

spatial data from all the EC-countries and establishing their interoperability across political boundaries are also essential goals of the EC Directive” (Asch et al., 2011).

The implementation of the Directive 2007/2/EC required the involvement of committees, panels and working groups composed of representatives of the EU Member States, *spatial data interest groups* (SDICs), *legally mandated organizations* (LMOs) and less formal, the participation of numerous stakeholder parties, organizations, task forces, working groups etc. according to the principle of subsidiarity. INSPIRE covers 34 themes which include geology, soil, energy resources, administrative units, land cover, etc. For each of these themes an international *thematic working group* (TWG) created European standards encompassing e.g. technical *implementation rules* (IR) and data specifications which in turn consist of standard data models, vocabularies⁵ with definitions, hierarchies and frequently portrayal rules. Previously, these would have been the map legends or keys; for example, the TWG responsible for the theme of geology developed the INSPIRE Data Specification on Geology (INSPIRE Thematic Working Group Geology, 2013) as an international team. Each EU member state has the obligation to deliver governmental spatial data according to those rules and standards to the INSPIRE Geoportal. By October 2020 already existing spatial datasets had to be provided and transformed according to the INSPIRE Implementation Rules (IR).

Because of the growing importance of marine resources and the environment, in 2008 the European Union *EMODnet* (European Marine Observation and Data Network) Programme was born. Following the INSPIRE GDI which focused at first on the continental part of Europe, EMODnet focusses on spatial data of the European Seas within a topical SDI. For each covered theme a data portal has been created where the users have access to standardized data products and data quality indicators (e.g. reliability maps). All data products are free to the public to access and use. The individual portals will be merged into a central portal in near future.

Also outside of Europe, Spatial Data Infrastructures (SDI) are being

created. In the USA (executive order 12906 from April 11, 1994) the U.S. government started “building a National Spatial Data Infrastructure with the aim to develop the technology, policies, standards, and human resources necessary to acquire, process, store, distribute, and improve utilization of geospatial data.”⁶ The platform offers various national spatial datasets but seems not to aim for the creation of unified standards.⁷ The U.S. Geoscience Information Network (USGIN) “exposes, connects, and opens earth science data to move beyond compliance with the 2009 Open Data Initiative to create an independent data exchange network”.⁸ Canada, as yet another example, has set up a national program called *GeoConnections* to build a *Canadian Geospatial Data Infrastructure* (CGDI) through the use of standard-based technologies and operational policies for data sharing and integration. China is working on the program *GeoCloud* by the China Geological Survey, which aims at efficient data sharing through the internet. It includes repositories for field mapping and project data. GeoCloud 1.0 was released in 2017.

The International Union of Geological Science (IUGS) has started building a global Research Infrastructure of Earth Sciences: *Deep Time Digital Earth* (DDE) as a big science program. The primary goal of the DDE program is to harmonise *deep-time* digital geological data. Through DDE, data will be made available in easy to use hubs providing insights into the distribution and value of Earth resources and materials, as well as Earth hazards.⁹

The *Global Spatial Data Infrastructure* (GSDI) Association, formed in 2004, now comprises of 22 Organisational Members from 16 countries and 25 Individual Members. GSDI is involved in technical cooperation SDI capacity building activities in several ways, has Special Consultative status with UN ECOSOC and supports the *UN Global Geospatial Information Management* (UN UNGGIM) initiative.

As another example, in Germany the *National Research Data Infrastructure* (NFDI) is currently under construction and will provide services

⁶ <https://www.fgdc.gov/nsdi/nsdi.html>.

⁷ <https://www.geoplatform.gov/>.

⁸ <http://usgin.org/>.

⁹ <https://www.iugs.org/dde>.

⁵ <http://inspire.ec.europa.eu/codelist/>.

and consulting services for the management of research data in Germany as a digital, distributed infrastructure. The NFDI aims to provide the German science system with a “nationwide, distributed and growing network” (Rat für Informationsinfrastrukturen, 2016) of services and consulting offerings for research data management.

3. Methodology

In order to identify a practical approach to identify the current situation and to find a strategy to close the planetary research-data cycle, we first need to analyze the main elements along its current research path. The first step is a breakdown of the current situation to find an improved procedure, both in terms of users and the process, using a step-wise analysis of all involved entities (actors, institutes), processes and products. (1) We here first identify how the current situation including users (actors) and data flows is constituted and how main processes are characterized. (2) In a next step, additional as well as potentially alternative roles and data paths, respectively, are identified and further developed through user and system requirements. (3) Finally, based on the assessment of the current situation and a requirement analysis, potential solutions are highlighted that build upon existing developments or which require additional developments.

3.1. Analysis of current status

Historically-grown processes are, despite being established, often not the most efficient solutions or stable with respect to future demands and community needs. Research data cycles have not been a widely-discussed topic when first maps and repositories came into being. We here take a closer look at the overall situation and try to identify products, processes and involvement of entities, such as actors or institutions (cf. Fig. 1), also to identify potential challenges. However, dependencies between actors and products can be complex regarding actual process interaction. We therefore provide a breakdown of (1) processes and sequences, i.e. a process-oriented view, as well as a user-oriented view focusing on (2) actors and institutes as well as the product. The first breakdown is visualized using a modified sequence diagram, the latter one by a modified use-case diagram.

Both sequence and use-case diagrams cover process and interaction of creating planetary geological maps from the viewpoint of different entities. Due to the inherent complexity of geologic maps, these views might be representative of several branches of map making at different institutes. Different entities approach the challenge from different perspectives and thus the breakdown we provide here needs to depict these branches at least on a higher level. In order to accomplish this, discussions with various users and institutes have been established in order to extract information regarding these typical processes.

Lastly, a process classification as commonly employed in Earth-based research data management¹⁰ provides a first connection to established solutions which can potentially be exploited further.

3.2. User and system requirements

The collection of user and system requirements are an essential process in order to provide guidance for developing potential improvements of workflows (e.g., Maiden, 2008; Vickers, 2007). Existing standardization documents such as a *user requirement specification (URS)* (ISO, 2019c) and a *system requirement specification (SyRS)* (ISO, 2014b) provide valuable tools and recommendations to accomplish these aims.

The URS describes the needs and expectations of users regarding the system layout and final product. The analysis of user requirements starts with a definition of the potential user and have the aim to cover as many

users characteristics as possible to provide a representative bottom-up solution. The collection itself is primarily based upon the experiences of the authors, and is complemented by discussions with other users in this field. Questionnaires distributed within mission teams complement the URS data basis. As user requirements focus on the use-case of geological mapping, additional requirements are extracted from surveys as conducted and discussed by Skinner et al. (2019).

The system requirement specification contains major elements on a general level and includes human elements and their interaction (IEEE, 1998; WG LCP, 2018). Within this document requirements mainly specify the system and its functionalities. If other system requirements are needed such as technical or contextual constraints, they are included here as well. The collection of requirements is based on the authors' experience and on results from literature targeting at SDI developments (e.g., Laura et al., 2017, 2018; MAPSIT, 2019).

3.3. Spatial data infrastructures as blueprint

Three approaches are conceivable when building a suitable research-data framework for enabling research data reuse. (1) One approach is based on independent analyses and empirical studies that allow to create a framework from the bottom up by potentially addressing the majority of community requirements a-priori. (2) Another path involves reviewing existing developments regarding their suitability and adapting solutions if needed and possible. (3) The third solution is defined by merging both approaches. The latter is the one that seems most feasible in this case as extensive SDI knowledge and experience exist on the terrestrial side which would provide a beneficial input when discussing user and system requirements gathered in the previous step.

For this contribution a number of different terrestrial frameworks have been investigated in order to find a basis that addresses similar requirements in the planetary community. Upon its selection, the framework can be reviewed in all its technical detail to see how such requirements are implemented, and what needs to be modified in order to address these.

4. Results and discussion

4.1. Current situation

The planetary research data development process can be well represented through the concept of the *Data-Information-Knowledge-Pyramid* (DIK) on one hand, and the concept of the *Visualization Pipeline* on the other (e.g., Haber and McNabb, 1990; dos Santos and Brodlié, 2004). Both concepts are complementary as they describe the knowledge extraction by data abstraction within visualization processes.

Such process developments are commonly defined through a number of different stakeholders and their interests, by various product types and by a number of hierarchical sub-processes involved in the development. In order to start visualizing the process different participants and groups as well as the processes need to be clarified. After completion of the technical and engineering part of a mission, scientific mission teams are responsible for creating data and are responsible for developing data products (Besse et al., 2018). This means, stakeholders are mainly represented by researchers organized in research institutes or as part of a mission team. On the side of processes and sub-processes we refer to the variety of steps involved in processing and data calibration right up to the publication of research products. These comprise, for example, of creation of metadata descriptions for archiving base/image data, publishing and archiving research data. To understand the correlation between the different stakeholders and sub-processes a top view of the refinement process is useful. This way a process timeline can be extracted and this once again helps to separate processes into activities. Such a top view of the process is shown in Fig. 1 and will be explained subsequently.

Raw data, usually collected by an orbiter- or rover-based instrument, undergo a process of calibration, refinement and filtering to become

¹⁰ <http://sudamih.oucs.ox.ac.uk/docs/ResearchDataManagementFactsheet.pdf>

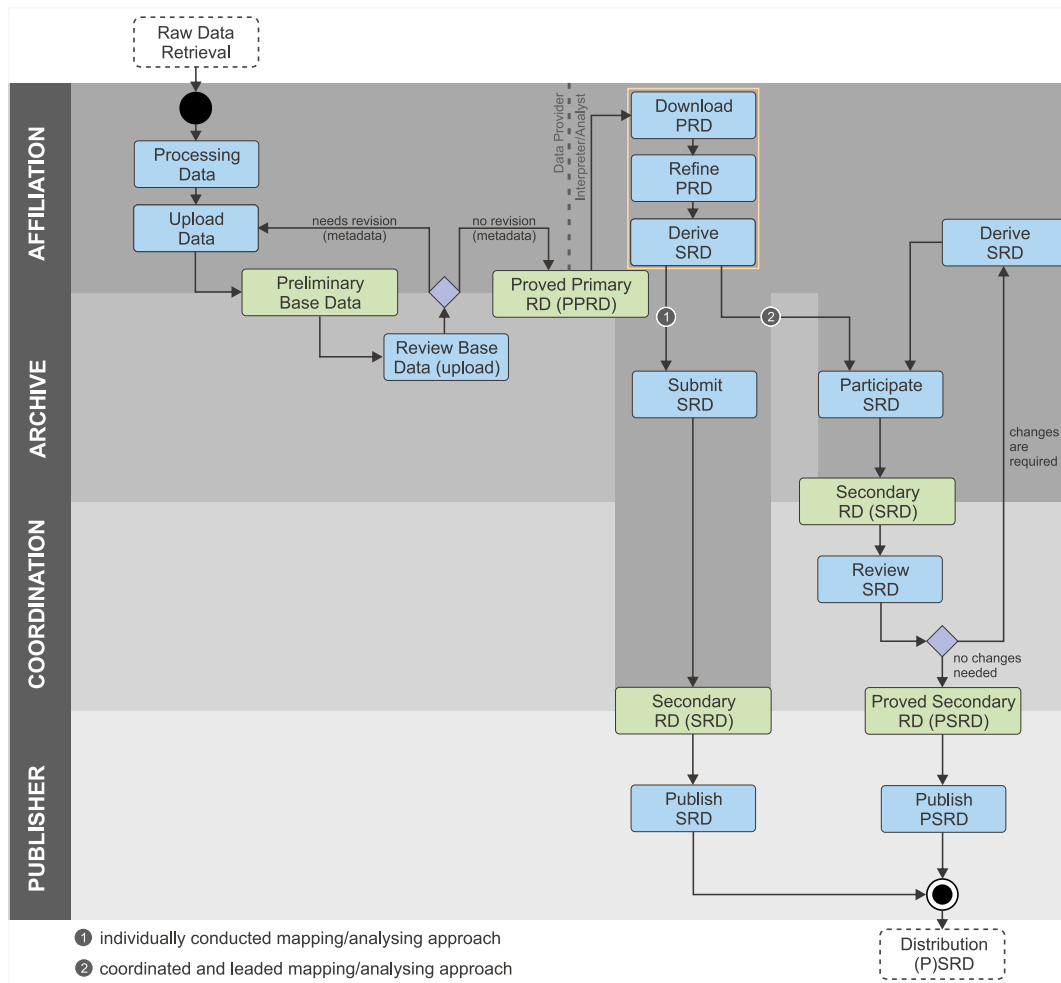

Fig. 2. Correlation between processing steps, participants and responsibilities regarding secondary research data in the Planetary Science (blue boxes show activities, green boxes show interim results or products).

information. The data provider enriches data with essential data description with regards to technical, geometrical and cartographic parameters. As soon as data is represented by valid metadata according to a given standard, such as the PDS standard, they will be uploaded to international archiving or temporary storage systems (e.g., PDS, PSA). At this point, base data have become information which can be queried and used by the community to start compiling individual interpretation and analyses (see Fig. 1). This first part of the process could be understood as transition from *data to information*.

The next step incorporates data refinement, where available information is classified, generalized and analyzed, and results subsequent represent an abstracted view on the data. This step is carried out by researchers individually within a specific discipline or within in a larger team. When the interpreter finalizes analyses, a researcher may submit research results to a publisher in form of a scientific paper opting for peer review, or results may be submitted to a central coordination node such as a topical research portal, a mission-team node or a survey for further use (see Fig. 1). Independent of the exact way, data or a subset thereof will be eventually published and made available to a larger community. At this stage research data can be published and made available to a larger community in order to use these for further research and developments. This could be currently understood as final step in the knowledge generation process as transition from *information to knowledge*.

Different stakeholders produce primary and secondary research data. Fig. 2 shows which stakeholders are responsible for, and involved in,

which activities. Here, the orange rectangle highlights the steps needed to conduct research analysis in general, or geological mapping in particular. These steps represent a common concept referring to data visualization known as *visualization pipeline*. In Fig. 3 a transfer of this meaning to the planetary mapping domain is shown.

Fig. 2 furthermore highlights different researcher (stakeholder) activities. After having produced secondary research data, two different paths can be followed in order to publish data. On the first path results and data are created by researchers individually and are published, e.g., within a scientific journal (Fig. 2 (1)). On the second path results and data are published through a coordinated approach and undergo an additional scientific, methodical and technical review (see Fig. 2 (2)).

4.2. Requirement analysis and target use-case scenario

When trying to conceptualize and eventually establish a framework for inserting (or re-inserting) planetary research data into a research cycle which then passes several levels of refinements and is then returned into the research cycle, a number of stages and interfaces have to be discussed in a more systemic way. New user requirements develop at each subsystem in this process and are separated by an interface at which data is handed through the next level. When focusing on the researcher level, i.e., the stakeholder, the situation becomes more straightforward as researcher needs can be easily summarized in general. User requirements can be readily extracted from a survey that has been launched by the USGS (Skinner et al., 2019) and which reveals some mapper and

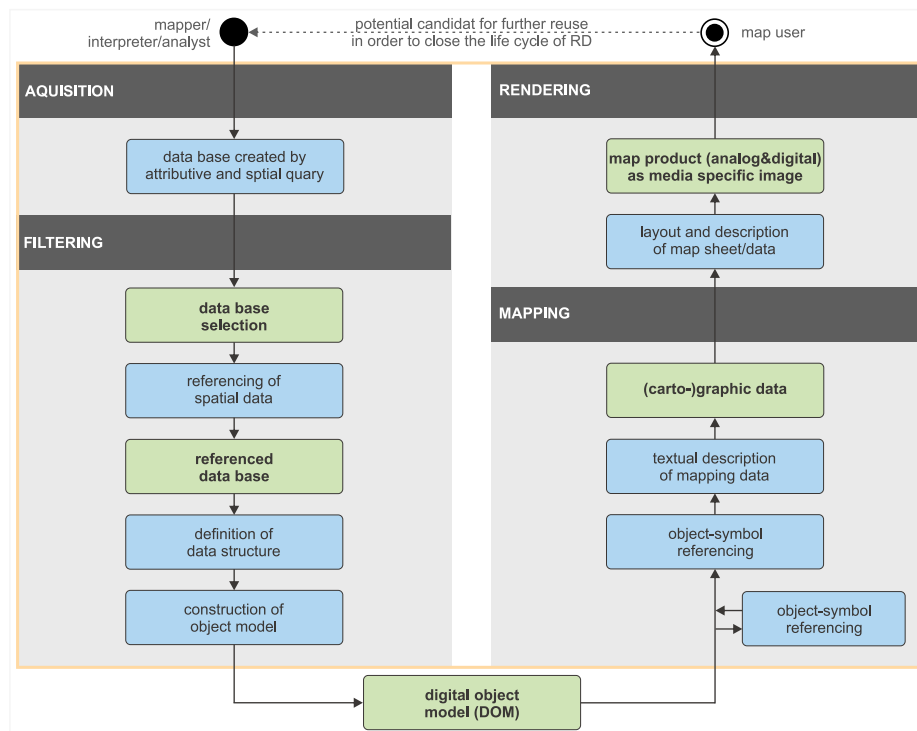

Fig. 3. Scientific mapping process within the domain of planetary geologic mapping. The overall mapping process is subdivided into different process steps. Blue boxes show activities, green boxes show interim results or products. Subheadings indicated to the process steps classified within the visualization pipeline (e.g., Haber and McNabb, 1990; dos Santos and Brodli, 2004).

map-user needs, both being part of the research community itself. However, one could argue at this point, that the majority of participants might have had an inherent interest in map products a-priori and might just reflect the mappers community in a representative way, not the research community at large.

Among map users asked for feedback, a number of responses stand out, with the following statements being direct quotes from Skinner et al. (2019):

1. Control to standard reference frame, objectivity in unit description, and consistent use of symbols are the three most important elements of planetary geoscience maps (finding 5).
2. Standardized and non-standardized geoscience maps are equally valued, though maps that follow cartographic standards are more effective at establishing context for the scientific community (finding 6).
3. A single online repository that enables map makers and (or) map users to search for and access geoscience maps would be an extremely useful resource (finding 10).

As overarching *low-level user requirements* we here define criteria along the following points:

- the data framework needs to be accessible with focus on ease of use and navigation;
- users prefer to access a data system without registration;
- users prefer to have easy access to metadata information and usage information.
- users require clear specifications and templates to work on their mapping projects and to ensure compatibility;
- users want to access actual data products easily and potentially in different formats.

As *high-level user requirements* we could, for example, define the following:

- users prefer to monitor progress and have access to information regarding incorporation of new research data/maps;
- users prefer to have a standard (i.e., a commonly known) graphical user interface when navigating;
- users prefer to be able to mass download information and data using scripts;

With respect to *system requirement* we could derive the following topics among others to be defined in the development process:

- the system framework needs to be built on preferentially free and open-source technology which provides flexible interfaces for access (API);
- the framework needs to be mirrored at nodes of multiple facilities, to provide redundancy;
- mirrors of the framework need to be exact copies with operable interfaces;
- the framework needs to contain integrity checks and validation tools;
- interfaces need to be downward compatible.

It should be noted, that these requirements can only form an initial set of ideas derived from a single survey and authors' experiences over the recent developments. For the implementation of a physical structure, community and organizations need to develop a common understanding and agree on preferences and criteria. It is important to collect and review such requirements by considering their dependencies which increase the complexity of such systems. More in-depth thoughts on this have been spent by Laura et al. (2018), also with reference to work by, e.g., Grus et al. (2010). INSPIRE is one of many SDIs that need to be reviewed in terms of collecting user and system requirements and as dynamic processes, a review of these strategies today is likely outdated tomorrow (e.g., Toth et al., 2012). The ones that have been studied in the course of this work emphasize the need to adhere to ISO and OGC standards and such standards should therefore also be the controlling framework for any planetary infrastructure.

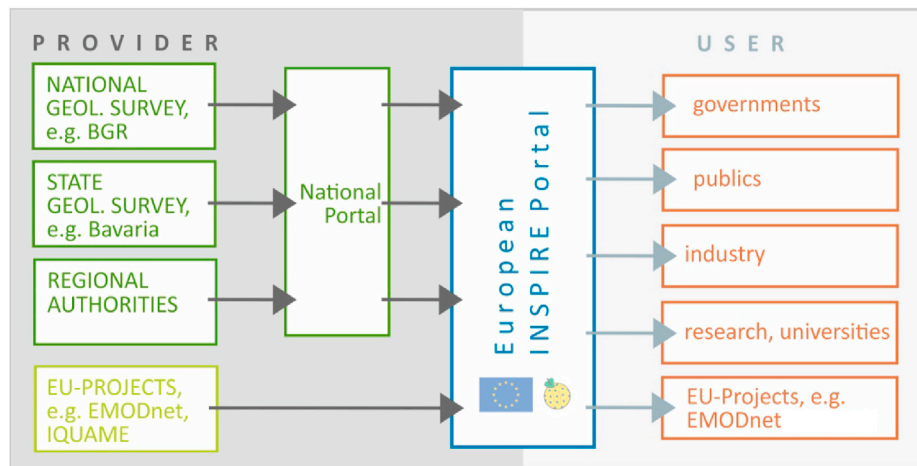

Fig. 4. Scheme of national data provision for the implementation of the European INSPIRE Directive.

Beside requirements on user and system level one further component, an entire inventory of the map products (e.g., Laura and Beyer, 2021), is needed on the path towards an open map repository. To realise this in a first step, a statistical compilation of the *Astropedia*¹¹ planetary data and cartography catalogue hosted by the USGS and e.g. the existing planetary map database conducted by Hargitai (2016) will be valuable contributions.

Earth-based geospatial data has a wide range of licensing system defining the term of use of a data product. The case of planetary data is fairly simple for the long-term archive of mission data, where after a review and a proprietary period, data is available for everyone. This includes raw and processed instrument data and resulting global mosaic published by different space agencies. Besides instrument data, interpretative data as for example geologic maps, have been published either as scientific articles or as official maps, offering a re-use scenario more complex. Since the Apollo era, geologic mapping of the Moon and planets of the solar system have been produced and disseminated by the United States Geologic Survey, Astrogeology Program, funded by NASA. Being both USGS and NASA governmental organization of the same country, the coordination and the production of planetary maps followed a straightforward development from the beginning to the digital-era. In their digital form, the US maps have been made available under the public domain. At the international level, every country has its own space agency or office but no public domain planetary maps have been systematically made available yet in re-useable formats outside the US. In Europe the space programs can be either promoted by European Space Agency or by any one of the participating states' space agencies, which is not necessarily an EU member. This is not ideal for a coordinated work for geoscientific mapping or dissemination of unified planetary mapping products. At the moment possible options that guarantee re-use of geospatial data while still granting proper credits to the authors include *Creative Commons licenses*, *Open DataBase Licenses*. For governmental agencies, the option of the public domain remains the best solution as it represents the more open solution yet.

4.3. Connections to terrestrial infrastructures: INSPIRE and beyond

In this section we highlight the general procedure of inserting geological map data into the INSPIRE process and discuss overarching concepts with respect to the product cycle and institutional participation.

The development of the INSPIRE implementing rules and technical guidance documents, as well as the maintenance and implementation framework, was based on a participatory process which involved

thematic experts from stakeholder organizations in the Member States, the *Spatial Data Interest Communities* (SDICs, such as companies, foundations, agencies such as the EEA, etc) and *Legally Mandated Organisation* (LMOs, such as Geological surveys or other governmental organisation).¹² Today, already numerous thematic spatial data sets can be viewed and downloaded from the INSPIRE Geoportal. To-date Germany's governmental institutions provided 18.881 spatial data sets in scales ranging from 1 : 500 to 1 : 5,000,000 which can be downloaded on the INSPIRE Geoportal.¹³

These are not necessarily provided according the INSPIRE codelists but comprise of national or regional datasets. Apart from these spatial data sets that can be viewed via a web-map service (WMS) and downloaded (download service) from the INSPIRE Geoportal and the national portals, also the codelists, the portrayal rules (colour map key) and the international and national portals offering the spatial data can be considered as products.

Fig. 4 schematically demonstrates how in federally governed countries participating in INSPIRE the spatial data for the Geology theme are provided and it shows that also international projects are providing and using INSPIRE data. The general process applies to all other federally organized countries in Europe participating in INSPIRE but it is highlighted here with the example of Germany.

Before any spatial geology data, i.e., geological maps can be provided they need to be designed and implemented on a national level. This usually happens on the regional level, i.e. almost every State Geological Survey of Germany have or had its state mapping program. Each Geological Survey transforms the regional data along with their regional description in their national language according to the INSPIRE IR using the INSPIRE Geology vocabulary. Descriptions using Local stratigraphic schemes and nomenclature specifics are commonly broken apart and generalized. This kind of generalized map information plus its geographic extent is being provided to the national INSPIRE portal as WMS and download service. Each EU Member State provides their data to their national INSPIRE portals in a similar way.

The European INSPIRE Geoportal collects national spatial data and provides data on-line for everyone who is interested. They can be selected according to countries (EU/EFTA) or themes. During the integration process in INSPIRE not only datasets but also standards and codelists¹⁴ have been created. Those are e.g. of interest for other mapping projects as they provide agreed standards which have been compiled, discussed, amended, and agreed by experts within an international

¹² see <https://inspire.ec.europa.eu/whos-who-inspire/57734>.

¹³ https://inspire-geoportal.ec.europa.eu/tv_home.html.

¹⁴ INSPIRE codelists <http://inspire.ec.europa.eu/codelist/>.

¹¹ <https://astrogeology.usgs.gov/search?pmi-target=mercury>.

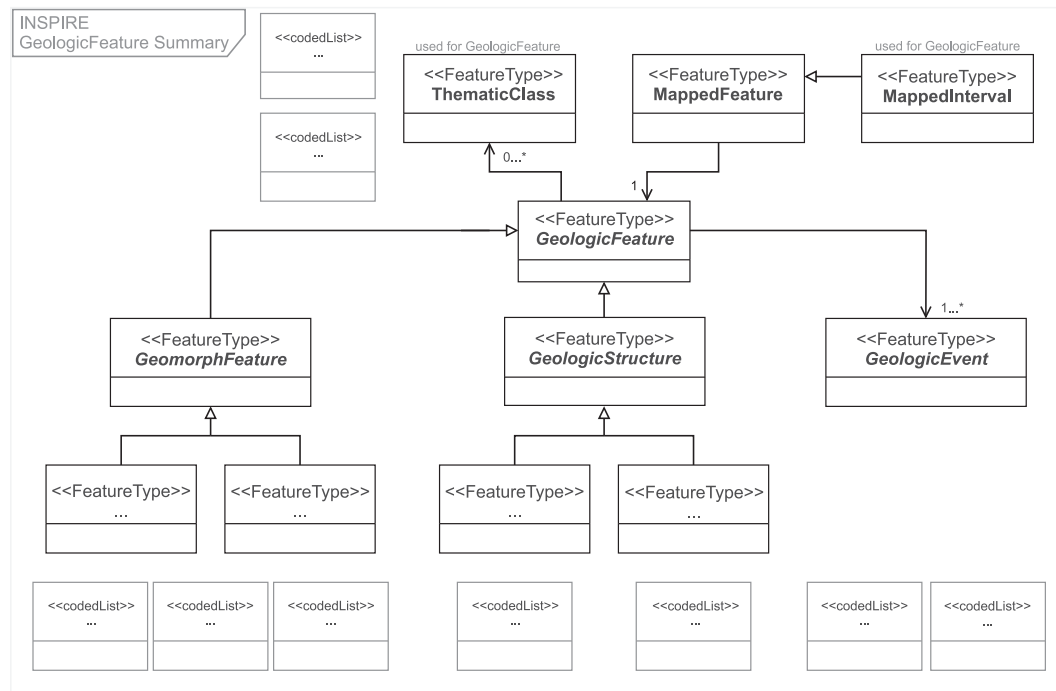

Fig. 5. UML example from the INSPIRE Geologic Feature framework (summarized and edited by the author.).

Thematic Working Group (TWG). The prototype for codelists for the geology theme (Asch et al., 2010) was created within an EU project: One-Geology_Europe¹⁵ where a group of experts agreed on a first, acceptable and useable vocabulary to describe the geological units semantically harmonized across Europe. The later INSPIRE TWG consisted of many experts of that group, and additional ones.

The vocabulary is not static and it is considered as living document standard. The EU project EMODnet Geology¹⁶ and also the international IQAME project¹⁷ make use of the INSPIRE vocabularies and amend it with both new feature types and terms/definitions, if necessary.

If experts of at this time 28 nations are gathering in the discussion about rules and standards, national interests and commonly established national practices might cause intense debates and the result can only be considered to be a compromise. It was realized, however, that initially planned and implemented vocabularies need to be adapted upon demand and deviation from the standards must become part of such a standard.

When taking a closer look at the features that are used in INSPIRE to describe Europe's geology, it seems efficient to take a closer look at the traditional geological and geomorphological (Earth-related) terms to describe the surface and geology of a planet. These are Natural Geomorphologic Feature Type, Geomorphologic Activity, Geochronologic Era, Lithology, Fault type and fold Profile type. INSPIRE Code lists are used to a great extent in all INSPIRE data models. They are subdivided according to their extensibility and their governance:

- not extensible (none)
- extensible with narrower values (narrower)
- extensible with additional values at any level (open)
- any values allowed (any)

Controlled vocabularies have the advantage that descriptions of units

across political boundaries provided by different national geological survey organizations are similar and, when looking at the entirety of Europe, show a more harmonized picture of the Geology of Europe. However, the strict rules mainly only allow generalized information to be provided, larger detail might be lost. This is observed as a disadvantage by numerous LMOs (see Fig. 5).

It remains debatable if the planetary community comprises of as numerous stakeholders as the INSPIRE community, for that the underlying aims of both directions in terms of needs are likely too different. Nevertheless, for interoperability and a common understanding of all mapping agencies of Mars or other planets, it is essential to agree on common set of mapped features and properties and optimally on codelists, which can be extended.

For the time being there are no common INSPIRE portrayal rules for all properties, also not for all geology properties. It is recommendable for the planetary community to create agreed, common portrayal rules for the mapped features, to increase the understanding across the different mapping groups. Furthermore, the extension of codelists and terms if new features are being discovered should be a part of the planetary SDI.

In summary, one could say that the main building blocks of the successfully implemented INSPIRE framework consists of organizational structures built on subsidiarity and a diverse international composition. It shows that it is of utmost importance that national flavours can remain and co-exist among an internationally agreed vocabulary and representation that is based on a common denominator. Furthermore, the existence of international expert groups is required that allows to make and implement decisions based on participatory and democratic process. Finally, standards and codes may need to be adaptable and extendable, and represent living documents that benefit from the input of the community.

The planetary mapping process certainly shows a number of differences, in particular as an international group with individual mapping approaches, experiences and procedures now maps objects that have no representatives within this community. This, however, suggests that the process of finding a common way forward for planetary mapping and for establishing vocabularies should not be as difficult as collecting 28 member states with different historical background under one umbrella.

The actual implementation and role of participating entities can be

¹⁵ <https://www.eurogeosurveys.org/projects/onegeology-europe/>.

¹⁶ https://www.bgr.bund.de/EN/Themen/Sammlungen-Grundlagen/GG_geol_Info/Projekte/laufend/EMODnet4/EMODnet4_en.html?nn=1556482.

¹⁷ https://www.bgr.bund.de/EN/Themen/Sammlungen-Grundlagen/GG_geol_Info/Projekte/laufend/IQUAME/IQUAME2500_en.html?nn=1556482.

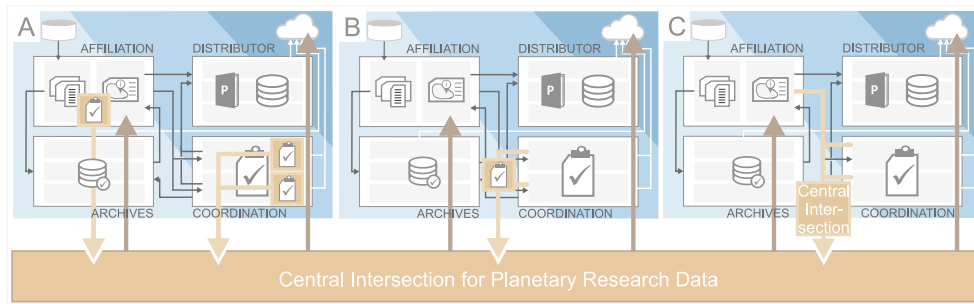

Fig. 6. Possibilities for a central intersection to improve the re-use and research data life cycle in the Planetary Sciences.

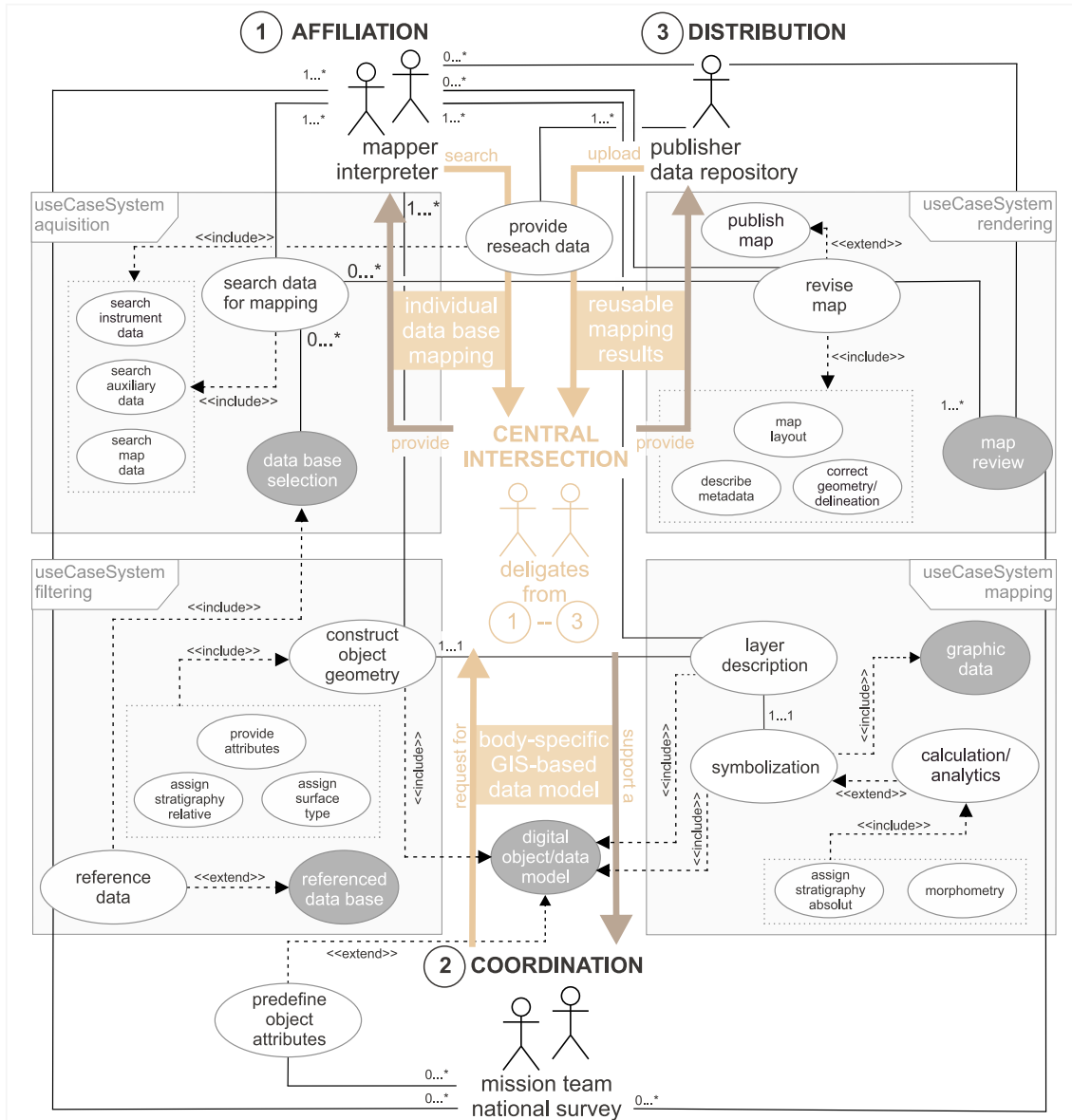

Fig. 7. Use case depicting a potentially improved research data life cycle in the planetary sciences.

discussed in various ways and directions (see Fig. 6). New research results and information can be inserted into a central repository directly which hands the review task over to the central repository, with all its implications for technical and personnel demands (see Fig. 6 A). Central entities would play a participatory role but are otherwise decentralized

units. On the other hand, a fully decentralized approach (see Fig. 6 B), in which local entities, provide the review component and coordination, is conceivable as well. A certainly more balanced but difficult to organize approach would be to merge the role of individuals and coordinating entities who pass on the results to the central repository (see Fig. 6 C).

This process would be heavy on the side of communication but would likely provide best results as both sides, technical realization and author, would work together.

In Fig. 7 we combine the different process- and activity-oriented views within the planetary mapping and refinement process demonstrate how a central intersection responsibility would support the reusability of the products (see Fig. 7).

5. Conclusions

In this contribution we have discussed the status of planetary research data with a focus on planetary maps and map metadata in particular. We consider maps, in contrast to technical plans and charts, as currently belonging to one of the highest levels of research data on their path to becoming information and knowledge at a point by means of human abstraction. Thus, maps can be considered representative of a variety of other information that resides on lower level of abstraction and development. Mapping processes are certainly complex, not only with respect to abstraction, to implementation and to semantics, but also with respect to the publishing process in the Planetary Sciences where a number of actors (users) and their interests, and processes interact. Despite this effort, with a few exemptions, little is being done to re-insert such products in the research cycle in a way that makes accessing them for study and refinement purposes efficient (or even possible). The understanding of that need and requirement is not always a congruent one among funding institutes and researchers on one side and research institutes and universities on the other.

The aim of this study was to characterize the relationships between different interest groups (stakeholders) and products as well as processes and to discuss how processes could potentially be optimized and streamlined in order to re-insert planetary maps (and research information) into a healthy and sustainable research cycle. Developments like this could build a thematic bridge to Earth-based RD repositories like *EOSC*, *Earth cube* und *pangea* in order to push the reuse of planetary maps. One way of realizing an approach targeted at improving the re-use of research data in the planetary sciences is by merging the existing alternatives and to integrate the structural benefits from the INSPIRE (or any other SDI) domain (cf. Fig. 7).

Communication and Participation. Throughout this development process it became clear that one of the most important aspects in this process is continuing and purposeful communication between groups on suitable platforms. And with more diversity developing on this research stage and with more data pouring in and accumulating over the last 15–20 years, this communication is needed soon. While individual groups have always been discussing these topics, a coordinated and participatory approach is much needed. This dialog is, however, not separated from existing efforts, as plenty of experience has been gathered over the decades when terrestrial infrastructures, such as the European INSPIRE SDI, have been built. While needs and particular requirements might be different to a degree, the underlying ideas remain the same and a planetary perspective could easily build upon that experience. In particular when comes to system and user requirements the dialog across the community is needed (see results section), otherwise only isolated solutions are created that might not be fit for today's demands and suit limited purpose only. And yet, such solutions require funding to be maintained for a user base that is reluctant to deal with such implementations.

Coordination. In order to provide a healthy basis for upstreaming local discussion onto the national as well as international stage in order to allow for a coordinative process to develop, continuing and stable funding support on each level must be available to provide a long-lasting national access point. Where these access points are located, and who these access points are remains a matter of national and international discussion in the future. Terrestrial infrastructures and overarching coordinative platforms, such as INSPIRE, went through such processes and have been sharing their experiences in this process.

Technical Implementation. Archiving systems and research data repositories need to be maintained on both national and international levels to provide a service for the community that allows to make efficient use of that data. Efficient use also includes making information available for future decision making. This concept comes close to what is known as *data warehouses* in the business world. The technical maintenance of data and information synchronized over various national entities is a matter that would not pose a major challenge today. The workflow of collection, review and distribution of information and the required data models, however, are a matter that can be complicated in details but has been dealt with in environments dealing with Earth data and information infrastructures. Here, flexibility and being able to adapt to changing demands by allowing growing specifications are key as INSPIRE has shown. User and system requirements as highlighted above are key to provide a basis for growing demands. Agreement on the smallest mutually accepted denominator by also respecting national understandings would be a key to build an environment that has the potential to grow into the future.

Declaration of competing interest

The authors declare that they have no known competing financial interests or personal relationships that could have appeared to influence the work reported in this paper.

Acknowledgement

The part of this research done by the author AN was carried out in part under the projects AP3400 Planetenforschung and Big-Data-Plattform by the German Aerospace Center (DLR).

AN, APR, BC acknowledge support from the Europlanet-2024 Research Infrastructure project, which has received funding from the European Union's Horizon 2020 research and innovation programme under grant agreement No 871149.

References

- Albertz, J., Gehrke, S., Wählich, M., Lehmann, H., Schumacher, T., Neukum, G., 2004. Digital cartography with hrsc 2 on mars express. *Int. Arch. Photogram. Rem. Sens. Spatial Inf. Sci.* XXXV, 869–874.
- Asch, K., Bavec, M., Bergman, S., Cerdan, F.P., Declercq, P., Hennings, S., Janjou, D., Kacer, S., Klicker, M., Laxton, J., Nironen, M., Pantaloni, M., Schubert, C., 2010. *Scientific/Semantic Data Specification and Dictionaries – Generic Specification for Spatial Geological Data in Europe*. OneGeology Europe. Technical Report ECP-2007-GEO-317001.
- Asch, K., Mathers, S., Kessler, H., 2011. Geology. In: Kresse, W.D.D. (Ed.), *Springer Handbook of Geographic Information*. Springer, Berlin, pp. 525–544. https://doi.org/10.1007/978-3-540-72680-7_27.
- Bahim, C., Dekkers, M., Wyns, B., 2019. Results of an Analysis of Existing FAIR Assessment Tools. Technical Report. Research Data Alliance. <https://doi.org/10.15497/RDA00035>.
- Baratoux, D., Chennaoui-Aoudjehane, H., Gibson, R., Lamali, A., Reimold, W., Sapah, M., Chabou, M., Habarulema, J., Jessell, M., Mogessie, A., Benkhalidoun, Z., Nkhonjera, E., Mukosi, N., Kaire, M., Rochette, P., Sickafoose, A., Martínez-Frías, J., Hofmann, A., Folco, L., Rossi, A., Faye, G., Kolenberg, K., Tekle, K., Belhai, D., Elyajouri, M., Koeberl, C., Abdeen, M., 2017. Africa initiative for planetary and space sciences. *Eos*. <https://doi.org/10.1029/2017eo075935>.
- Batson, R.M., 1984. Voyager 1 and 2 Atlas of Six Saturnian Satellites. Special Publication SP-474, Scientific and Technical Information Branch. National Aeronautics and Space Administration, Washington. URL <https://history.nasa.gov/SP-474/sp474.htm>.
- Besse, S., Vallat, C., Barthelemy, M., Coia, D., Costa, M., De Marchi, G., Fraga, D., Grotheer, E., Heather, D., Lim, T., Martinez, S., Arviset, C., Barbarisi, I., Ducasal, R., Macfarlane, A., Rios, C., Saiz, J., Vallejo, F., 2018. Esa's planetary science archive: preserve and present reliable scientific data sets. *Planet. Space Sci.* 150, 131–140. <https://doi.org/10.1016/j.pss.2017.07.013>.
- Borgman, C.L., 2012. The conundrum of sharing research data. *J. Am. Soc. Inf. Sci. Technol.* 63, 1059–1078. <https://doi.org/10.1002/asi.22634> arXiv. <https://asistdl.onlinelibrary.wiley.com/doi/pdf/10.1002/asi.22634>.
- Campbell, J., Heward, A., Losiak, A., Parekh, R., Pearson, V., Rossi, L., 2018. Europlanet diversity working group. available online at. <https://www.europlanet-society.org/diversity-working-group/>.
- Chuang, F.C., Williams, R.M.E., 2018. Valley network morphology in the greater Meridiani Planum region, Mars. *J. Maps* 14, 652–660. <https://doi.org/10.1080/17445647.2018.1530154>.

- Clare, C., Cruz, M., Papadopoulou, E., Savage, J., Teperek, M., Wang, Y., Witkowska, I., Yeomans, J., 2019. Engaging researchers with data management: the cookbook. Technical report. Research Data Alliance. <https://doi.org/10.11647/OBP.0185>.
- Collins, G., Patterson, G., Head, J., Pappalardo, R., Prockter, L., Lucchitta, B., Kay, J., 2013. Global Geologic Map of Ganymede, Scientific Investigations Map 3237, Scale 1:15,000,000. USGS Astrogeology Science Center. <https://doi.org/10.3133/sim3237>. Technical Report.
- Corti, L., van den Eynden, V., Bishop, L., Woollard, M., 2019. Managing and Sharing Research Data: A Guide to Good Practice. SAGE Publishing, New York.
- Crichton, D., Beebe, R., Stein, T., 2018. International Planetary Data Alliance Progress Report. Technical Report. International Planetary Data Alliance (IPDA). URL <https://planetarydata.org/>.
- Crichton, D., Padams, J., Hollins, G., Hughes, J.S., Joyner, R., Law, E., Cayan, M., 2020. PDS data services initiative: evolving towards data-driven capabilities to enable planetary science research. In: Lunar and Planetary Science Conference, p. 2754.
- Debnik, K., Mège, D., Gurgurewicz, J., 2017. Geomorphology of ius chasma, valles marineris, mars. J. Maps 13, 260–269. <https://doi.org/10.1080/17445647.2017.1296790>.
- Dobinson, E.R., 1992. User scientific data systems: experience report. Technical Report. NASA/JPL.
- dos Santos, S., Brodlik, K., 2004. Gaining understanding of multivariate and multidimensional data through visualization. Comput. Graph. 28, 311–325.
- Erard, S., Ceconi, B., Sidaner, P.L., Chauvin, C., Rossi, A.P., Minin, M., Capria, T., Ivanovski, S., Schmitt, B., Genot, V., André, N., Marmo, C., Vandaele, A.C., Trompet, L., Scherf, M., Hueso, R., Määttä, A., Carry, B., Achilleos, N., Soucek, J., Pisa, D., Benson, K., Fernique, P., Millour, E., 2020. Virtual european solar & planetary access (VESPA): a planetary science virtual observatory cornerstone. Data Sci. J. 19 <https://doi.org/10.5334/dsj-2020-022>.
- Ford, J.P., Plaut, J.J., Weitz, C.M., Farr, T.G., Senske, D.A., Stofan, E.R., Michaels, G., Parker, T.J., Fulton, D., 1993. Guide to Magellan Image Interpretation. Jet Propulsion Laboratory. Technical Report JPL-PUBL 93-24. <https://ntrs.nasa.gov/archive/nasa/casi.ntrs.nasa.gov/19940013181.pdf>.
- Fortezzo, C., Spudis, P.D., Harrel, S.L., 2020. Release of the digital unified global geologic map of the moon at 1:5,000,000-scale. In: Abstracts of the 51st Lunar and Planetary Science Conference. Lunar and Planetary Institute, Houston, p. 2760. URL <https://www.hou.usra.edu/meetings/lpsc2020/pdf/2760.pdf>.
- Go Fair Initiative, 2020. FAIR Principles. Go FAIR. Technical Report. <https://www.go-fair.org/fair-principles>. (Accessed 12 August 2020).
- Godber, A., Aye, M., Olson, T., Vargas, P., Slezak, T.J., Beyer, R., 2020. PlanetaryPy: Python Tools for Planetary Science. Github Repository. Technical Report.
- Planetary mapping. In: Greeley, R., Batson, R.M. (Eds.), 1990. Cambridge Planetary Science Series. Cambridge University Press.
- Grus, L., Cromptoets, J., Bregt, A.K., 2010. Spatial data infrastructures as complex adaptive systems. Int. J. Geogr. Inf. Sci. 24, 439–463. <https://doi.org/10.1080/13658810802687319>.
- Guinness, E.A., Arvidson, R.E., Slavney, S., 1996. The planetary data system geosciences node. Planet. Space Sci. 44, 13–22.
- Gwinner, K., Jaumann, R., Hauber, E., Hoffmann, H., Heipke, C., Oberst, J., Neukum, G., Ansan, V., Bostelmann, J., Dumke, A., Elgner, S., Erkeling, G., Fueten, F., Hiesinger, H., Hoekzema, N.M., Kersten, E., Loizeau, D., Matz, K.D., McGuire, P.C., Mertens, V., Michael, G., Pasewald, A., Pinet, P., Preusker, F., Reiss, D., Roatsch, T., Schmidt, R., Scholten, F., Spiegel, M., Stesky, R., 2016. The high resolution stereo camera (HRSC) of mars express and its approach to science analysis and mapping for mars and its satellites. Planet. Space Sci. 126, 93–138. <https://doi.org/10.1016/j.pss.2016.02.014>.
- Gwinner, K., Scholten, F., Preusker, F., Elgner, S., Roatsch, T., Spiegel, M., Schmidt, R., Oberst, J., Jaumann, R., Heipke, C., 2010. Topography of Mars from global mapping by HRSC high-resolution digital terrain models and orthoimages: characteristics and performance. Earth Planet. Sci. Lett. 294, 506–519. <https://doi.org/10.1016/j.epsl.2009.11.007>.
- Haber, R., McNabb, D., 1990. Visualization idioms: a conceptual model for scientific visualization systems. In: Nielson, G., Shriver, B., Rosenblum, L. (Eds.), Visualization in Scientific Computing. IEEE Computer Society, pp. 74–93.
- Hake, G., Grünreich, D., Meng, L., 2001. Kartographie, 8 ed. de Gruyter.
- Hare, T.M., Hayward, R.K., Blue, J.S., Archinal, B.A., Robinson, M.S., Speyerer, E.J., Wagner, R.V., Smith, D.E., Zuber, M.T., Neumann, G.A., Mazarico, E., 2015. Topographic Map of the Moon, Scientific Investigations Map 3316. USGS Astrogeology Science Center. Technical Report.
- Hargitai, H., 2016. Metacatalog of planetary surface features for multicriteria evaluation of surface evolution: the integrated planetary feature database. In: AAS/Division for Planetary Sciences Meeting Abstracts #48, p. 426.23.
- Planetary cartography and GIS. In: Hargitai, H. (Ed.), 2019. Lecture Notes in Geoinformation and Cartography. Springer.
- Hargitai, H., Pitura, M., 2018. International catalog of planetary maps, 1600-2017. In: Abstracts of the 49th Lunar and Planetary Science Conference, p. 2608. The Woodlands, US.
- Hu, H., Wu, B., 2018. Block adjustment and coupled epipolar rectification of LROC NAC images for precision lunar topographic mapping. Planet. Space Sci. 160, 26–38. <https://doi.org/10.1016/j.pss.2018.03.002>.
- IEEE, 1998. IEEE guide for developing system requirements specification. In: Software Engineering Standards Committee of the IEEE Computer Society. Technical Report.
- INSPIRE Thematic Working Group Geology, 2013. D2.8.II.4 Data Specification on Geology-Technical Guidelines. Identifier D2.8.II.4.v3.0. European Commission Joint Research Centre. <https://inspire.ec.europa.eu/id/document/tg/ge>.
- Iqbal, W., Hiesinger, H., van der Bogert, C., 2020. Geological mapping and chronology of lunar landing sites: Apollo 12. Icarus 352, 113991. <https://doi.org/10.1016/j.icarus.2020.113991>. URL <http://www.sciencedirect.com/science/article/pii/S0019103520303572>.
- ISO, 2014a. Geographic Information – Metadata – Part 1: Fundamentals. International Standardization Organization. Technical Report ISO 19115-1:2014.
- ISO, 2014b. Systems and Software Engineering – Systems and Software Quality Requirements and Evaluation (SQuARE) – Planning and Management. International Standardization Organization. Technical Report ISO/IEC 25001:2014, ISO/IEC JTC 1/SC 7.
- ISO, 2019a. Geographic Information – Metadata – Part 2: Extensions for Acquisition and Processing. International Standardization Organization. Technical Report ISO 19115-2:2019.
- ISO, Technical Report ISO/Ts 19139-1:2019, 2019b. Geographic Information – XML Schema Implementation – Part 1: Encoding Rules. International Standardization Organization.
- ISO, Technical Report 25065:2019, ISO/TC 159/SC 4, 2019c. Systems and Software Engineering – Software Product Quality Requirements and Evaluation (SQuARE) – Common Industry Format (CIF) for Usability: User Requirements Specification. International Standardization Organization.
- Johnson, W.T.K., 1991. Magellan imaging radar mission to venus. Proc. IEEE 79, 777–790. <https://doi.org/10.1109/5.90157>.
- Karachetseva, L., Garov, A., Zubarev, A., Matveev, E., Kokhanov, A., Zharkova, A., 2018. Geoportal of Planetary Data: Concept, Methods and Implementations, pp. 315–329. <https://doi.org/10.1201/9780429505997-21>.
- Kaula, W.M., Schubert, G., Lingenfelter, R.E., Sjogren, W.L., Wollenhaupt, W.R., 1974. Apollo laser altimetry and inferences as to lunar structure. Lunar Planet. Sci. Conf. Proc. 3, 3049–3058.
- Kitchin, R., 2014. The Data Revolution – Big Data, Open Data, Data Infrastructures and Their Consequences. Sage, Los Angeles.
- Latif, A., Limani, F., Tochtermann, K., 2019. A generic research data infrastructure for long tail research data management. Data Sci. J. 18 <https://doi.org/10.5334/dsj-2019-017>.
- Laura, J.R., Beyer, R.A., 2021. Knowledge inventory of foundational data products in planetary science. Planet. Sci. J. 2 <https://doi.org/10.3847/PSJ/abc94>.
- Laura, J.R., Bland, M.T., Ferguson, R.L., Hare, T.M., Archinal, B.A., 2018. Framework for the development of planetary spatial data infrastructures: a europa case study. Earth Space Sci. 5, 486–502. <https://doi.org/10.1029/2018EA000411>.
- Laura, J.R., Hare, T.M., Gaddis, L.R., Ferguson, R.L., Skinner, J.A., Hagerly, J.J., Archinal, B.A., 2017. Towards a planetary spatial data infrastructure. ISPRS J. Geo-Info. 6, 181.
- Law, E., Cayan, M., Crichton, D., Hollins, G., Hughes, S., Padams, J., 2019. Planetary data system (PDS) tools and tool registry. In: EPSC-DPS Joint Meeting 2019. EPSC-DPS2019-170.
- Lee, S.W., 1991. The planetary data system. Rev. Geophys. 29, 337–340.
- Litwin, L., Rossa, M., 2011. Geoinformation Metadata in INSPIRE and SDI. Springer, Berlin.
- Liu, W.C., Wu, B., 2017. Photometric stereo shape-and for pixel-level resolution lunar surface reconstruction. ISPRS - Int. Arch. Photogr. Remote Sens. Spat. Info. Sci. 62W1, 91–97. <https://doi.org/10.5194/isprs-archives-XLII-3-W1-91-2017>.
- Maiden, N., 2008. User requirements and system requirements. IEEE Softw. 25, 90–91. <https://doi.org/10.1109/ms.2008.54>.
- Manaud, N., Nass, A., van Gassel, S., Lewand, O., Rossi, A.P., Hare, T., Carter, J., Hargitai, H., 2018a. OpenPlanetaryMap: building the first Open Planetary Mapping and Social platform for researchers, educators, storytellers, and the general public. In: European Planetary Science Congress, pp. EPSC2018-E2078.
- Manaud, N., Rossi, A.P., Million, C., 2018b. OpenPlanetary: an open science community and framework for planetary scientists and developers. In: European Planetary Science Congress, pp. EPSC2018-E2089.
- MAPSIT, 2019. Mapping and Planetary Spatial Infrastructure Team, Mapping and Planetary Spatial Data Infrastructure Roadmap 2019–2023. URL <https://www.lpi.usra.edu/mapsit/roadmap/MAPSIT-Roadmap-2019-06-19.pdf>.
- Martinez, P.A., Erdmann, C., Simons, N., Otsuji, R., Labou, S., Johnson, R., Castelao, G., 2019. Top 10 FAIR Data & Software Things. Research Data Alliance. <https://doi.org/10.5281/zenodo.2555497>. Technical Report.
- Massironi, M., Altieri, F., Hiesinger, H., Mangold, N., Rothery, D., Rossi, A.P., Balme, M., Carli, C., Capaccioni, F., Cremonese, G., Filacchione, G., Le Mouélic, S., Unnikhan, V., Van Der Bogert, C., 2018. Towards integrated geological maps and 3D geo-models of planetary surfaces: the H2020 PLANetary MAPping project. In: EGU General Assembly Conference Abstracts, p. 18106.
- McMahon, S.K., 1996. Overview of the planetary data system. Planet. Space Sci. 44, 3–12. [https://doi.org/10.1016/0032-0633\(95\)00101-8](https://doi.org/10.1016/0032-0633(95)00101-8).
- Muller, J.P., Tao, Y., Sidiropoulos, P., Gwinner, K., Willner, K., Fanara, L., Waehlich, M., van Gassel, S., Walter, S., Steikert, R., Schreiner, B., Ivanov, A., Cantini, F., Wardlaw, J., Morley, J., Sprinks, J., Giordano, M., Marsh, S., Kim, J., Houghton, R., Bamford, S., 2016. EU-FP7-iMARS: analysis of mars multi-resolution images using auto-coregistration data mining and crowd source techniques: processed results - a first look. ISPRS - international archives of the photogrammetry. Remote Sens. Spat. Info. Sci. 41B4, 453–458. <https://doi.org/10.5194/isprs-archives-XLI-B4-453-2016>.
- Mumford, S.J., Christe, S., Pérez-Suárez, D., Ireland, J., Shih, A.Y., Inglis, A.R., Liedtke, S., Hewett, R.J., Mayer, F., Hughitt, K., Freij, N., Meszaros, T., Bennett, S.M., Malocha, M., Evans, J., Agrawal, A., Leonard, A.J., Robitaille, T.P., Mampae, B., Campos-Rozo, J.I., Kirk, M.S., 2015. SunPy – python for solar physics. Comput. Sci. Discov. 8, 014009 <https://doi.org/10.1088/1749-4699/8/1/014009>.
- Murana, A., 2018. Geology of danielson crater, mars. J. Maps 14, 161–172. <https://doi.org/10.1080/17445647.2018.1443029>.
- NASA, 2018. Research Opportunities in Space and Earth Sciences – 2018 (ROSES-2018) – NASA Research Announcement (NRA) Soliciting Basic and Applied Research

- Proposals. National Aeronautics and Space Administration. Technical Report Number NHH18ZDA001N.
- Nass, A., Manaud, N., van Gassel, S., Hare, T., 2019. Towards a new face for planetary maps: Design and web-based implementation of planetary basemaps. In: *Advances in Cartography and GIScience of the International Cartographic Association*, pp. 1–8. <https://doi.org/10.5194/ica-adv-1-15-2>.
- OECD, 2007. *Principles and Guidelines for Access to Research Data from Public Funding*. OECD Publications, Paris.
- Pietro, I.D., Ori, G.G., Pondrelli, M., Salese, F., 2018. Geology of aeolis dorsa alluvial sedimentary basin, mars. *J. Maps* 14, 212–218. <https://doi.org/10.1080/17445647.2018.1454350>.
- Pondrelli, M., Rossi, A.P., Platz, T., Ivanov, A., Marinangeli, L., Baliva, A., 2011. Geological, geomorphological, facies and allostratigraphic maps of the Eberswalde fan delta. *Planet. Space Sci.* 59, 1166–1178. <https://doi.org/10.1016/j.jps.2010.10.009>.
- Preheim, L., 1993. Supporting multidisciplinary science within NASA's discipline data systems. In: *9th Computing in Aerospace Conference*. American Institute of Aeronautics and Astronautics, p. 102. <https://doi.org/10.2514/6.1993-4478>.
- Radebaugh, J., Thomson, B.J., Archinal, B., Beyer, R., DellaGuistina, D., Fassett, C., Gaddis, L., Hagerty, J., Hare, T., Laura, J., Lawrence, S., Mazarico, E., Nass, A., Pathoff, A., Skinner, J., Sutton, S., Williams, D., 2019. A roadmap for planetary spatial data infrastructure. In: *Lunar and Planetary Science Conference*, p. 1667.
- Rajabifard, A., Williamson, I., 2001. Spatial data infrastructures: concept, SDI hierarchy and future directions. In: *GEOMATICS'80 Conference*.
- RDA-IWG, 2017. Research data repository interoperability primer – report by the members of the RDA research data repository interoperability working group. Research Data Alliance. <https://doi.org/10.15497/RDA00020>. Technical Report.
- Roatsch, T., Kersten, E., Matz, K.D., Bland, M.T., Becker, T.L., Patterson, G.W., Porco, C.C., 2018. Final mimas and enceladus atlases derived from cassini-ISS images. *Planet. Space Sci.* 164, 13–18. <https://doi.org/10.1016/j.jps.2018.05.021>.
- Roatsch, T., Kersten, E., Matz, K.D., Preusker, F., Scholten, F., Jaumann, R., Raymond, C.A., Russell, C.T., 2016a. Ceres survey atlas derived from dawn framing camera images. *Planet. Space Sci.* 121, 115–120. <https://doi.org/10.1016/j.jps.2015.12.005>.
- Roatsch, T., Kersten, E., Matz, K.D., Preusker, F., Scholten, F., Jaumann, R., Raymond, C.A., Russell, C.T., 2016b. High-resolution ceres high altitude mapping orbit atlas derived from dawn framing camera images. *Planet. Space Sci.* 129, 103–107. <https://doi.org/10.1016/j.jps.2016.05.011>.
- Roatsch, T., Kersten, E., Matz, K.D., Preusker, F., Scholten, F., Jaumann, R., Raymond, C.A., Russell, C.T., 2017. High-resolution ceres low altitude mapping orbit atlas derived from dawn framing camera images. *Planet. Space Sci.* 140, 74–79. <https://doi.org/10.1016/j.jps.2017.04.008>.
- Robinson, A.H., Morrison, J.L., Muehrcke, P.C., Kimerling, A.J., Guptill, S.C., 1995. *Elements of Cartography*, 6 ed. Wiley, New York.
- Robitaille, T.P., Tollerud, E.J., Greenfield, P., Droettboom, M., Bray, E., Aldcroft, T., Davis, M., Ginsburg, A., Price-Whelan, A.M., Kerzendorf, W.E., Conley, A., Crighton, N., Barbary, K., Muna, D., Ferguson, H., Grollier, F., Parikh, M.M., Nair, P.H., Günther, H.M., Deil, C., Woillez, J., Conseil, S., Kramer, R., Turner, J.E.H., Singer, L., Fox, R., Weaver, B.A., Zabalza, V., Edwards, Z.L., Bostroem, K.A., Burke, D.J., 2013. Astropy: a community python package for astronomy. *Astron. Astrophys.* 558, A33. <https://doi.org/10.1051/0004-6361/201322068>.
- Rossi, A.P., Cecconi, B., Fraenz, M., Hagermann, A., Heather, D., Rosenblatt, P., Svedhem, H., Widemann, T., 2014. The ESA planetary science archive user group (PSA-UG). In: *European Planetary Science Congress*, pp. EPSC2014–E2435.
- Rossi, A.P., Massironi, M., Altieri, F., van der Bogert, C., Hiesinger, H., Mangold, N., Rothery, D., Balme, M., Carli, C., Pozzobon, R., Semenzato, A., Pesce, D., Zambon, F., Le Mouelic, S., Penasa, L., Luzzi, E., Unnithan, V., Ferrari, S., 2018. Planmap: geological mapping supporting the exploration of the moon, mars and mercury. In: *Abstracts of the 69th International Astronautical Congress (IAC) 2018*. #IAC-18,A3,1,12,x47635.
- Semenzato, A., Massironi, M., Ferrari, S., Galluzzi, V., Rothery, D., Pegg, D., Pozzobon, R., Marchi, S., 2020. An integrated geologic map of the rembrandt basin, on mercury, as a starting point for stratigraphic analysis. *Rem. Sens.* 12, 3213.
- Skinner, J.A., Huff, A.E., Fortezzo, C.M., Gaither, T., Hare, T.M., Hunter, M.A., Buban, H., 2019. Planetary geologic mapping—program status and future needs. <https://doi.org/10.3133/ofr20191012>.
- Smith, D.E., Zuber, M.T., Frey, H.V., Garvin, J.B., Head, J.W., Muhleman, D.O., Pettengill, G.H., Phillips, R.J., Solomon, S.C., Zwally, H.J., Banerdt, W.B., Duxbury, T.C., Golombek, M.P., Lemoine, F.G., Neumann, G.A., Rowlands, D.D., Aharonson, O., Ford, P.G., Ivanov, A.B., Johnson, C.L., McGovern, P.J., Abshire, J.B., Afzal, R.S., Sun, X., . Mars orbiter laser altimeter: experiment summary after the first year of global mapping of mars. *J. Geophys. Res.: Planets* 106, 23689–23722. URL: <https://agupubs.onlinelibrary.wiley.com/doi/abs/10.1029/2000JE001364>, doi:10.1029/2000JE001364.
- Steinbrügge, G., Stark, A., Hussmann, H., Wickhusen, K., Oberst, J., 2018. The performance of the BepiColombo Laser Altimeter (BELA) prior launch and prospects for Mercury orbit operations. *Planet. Space Sci.* 159, 84–92. <https://doi.org/10.1016/j.jps.2018.04.017>.
- Tanaka, K., Skinner, J., Dohm, J., Irwin, R., Kolb, E., Fortezzo, C., Platz, T., Michael, G., Hare, T., 2014. Geologic Map of Mars: U.S. Geological Survey Scientific Investigations Map 3292, Scale 1:20,000,000. USGS Astrogeology Science Center. <https://doi.org/10.3133/sim3292>. Technical Report SIM 3292.
- Tanaka, K.L., Skinner, J.A., Hare, T.M., 2005. Geologic Map of the Northern Plains of Mars, Scientific Investigations Map 2888. USGS Astrogeology Science Center. Technical Report.
- Toth, K., Portele, C., Illert, A., Lutz, M., Nunes de Lima, M., 2012. A conceptual model for developing interoperability specifications in spatial infrastructures. In: *Technical Report EUR 25280 EN*. European Commission Joint Research Centre. Publications Office of the European Union. <https://doi.org/10.2788/20697>.
- USGS, 2002. *Color-Coded Topography and Shaded Relief Map of the Lunar Near Side and Far Side Hemispheres*, Geologic Investigation Series I-2769. USGS Astrogeology Science Center. Technical Report I 10M 0/0 180 RTK.
- USGS, 2003. *Topographic Map of Mars*, Geologic Investigation Series I-2782. USGS Astrogeology Science Center. Technical Report M 25M RKN.
- Vickers, A., 2007. Satisfying business problems. *IEEE Softw.* 24, 18–20.
- Wall, S.D., McConnell, S.L., Left, C.E., Austin, R.S., Beratan, K.K., Rokey, M.J., 1995. Magellan synthetic aperture radar images. Technical Report NASA Reference Publication 1356. Jet Propulsion Laboratory. URL: <https://core.ac.uk/download/pdf/42781597.pdf>.
- WG LCP, 2018. *Systems and Software Engineering – Life Cycle Processes – Requirements Engineering*. IEEE. Technical Report ISO/IEC/IEEE 29148:2018(E). ISO/IEC.
- Williams, D., Keszthelyi, L., Crown, D., Yff, J., Jaeger, W., Schenk, P., Geissler, P., Becker, T., 2011. Geologic Map of Io, Scientific Investigations Map 3168, Scale 1:15,000,000. USGS Astrogeology Science Center. Technical Report.
- Williams, D.A., 2016. Nasa's planetary geologic mapping program: overview. *Int. Arch. Photogram. Rem. Sens. Spatial Inf. Sci.* 41, 519.
- Williams, D.A., Buczkowski, D.L., Mest, S.C., Scully, J.E., Platz, T., Kneissl, T., 2018. Introduction: the geologic mapping of ceres. *Icarus* 316, 1–13. <https://doi.org/10.1016/j.icarus.2017.05.004>.
- Williams, D.A., Yingst, R.A., Garry, W.B., 2014. Introduction: the geologic mapping of vesta. *Icarus* 244, 1–12. <https://doi.org/10.1016/j.icarus.2014.03.001>.
- Williamson, I., Rajabifard, A., Feeney, M.E., 2003. *Developing Spatial Data Infrastructures – from Concept to Reality*. CRC Press, London.
- Wu, M., Psomopoulos, F., Khalsa, S., de Waard, A., 2019. Data discovery paradigms: user requirements and recommendations for data repositories. *Data Sciene J.* 18 <https://doi.org/10.5334/dsj-2019-003>.
- Yingst, R.A., Mest, S.C., Berman, D.C., Garry, W., Williams, D., Buczkowski, D., Jaumann, R., Pieters, C., De Sanctis, M., Frigeri, A., Le Corre, L., Preusker, F., Raymond, C., Reddy, V., Russell, C., Roatsch, T., Schenk, P., 2014. Geologic mapping of vesta. *Planet. Space Sci.* 103, 2–23. <https://doi.org/10.1016/j.jps.2013.12.014>.
- Zikopoulos, P., Eaton, C., de Roos, D., Deutsch, T., Lapis, G., 2012. *Understanding Big Data*. McGraw Hill, New York.
- Zuber, M.T., Smith, D.E., Zellar, R.S., Neumann, G.A., Sun, X., Katz, R.B., Kleyner, I., Matuszski, A., McGarry, J.F., Ott, M.N., Ramos-Izquierdo, L.A., Rowlands, D.D., Torrence, M.H., Zagwodzki, T.W., 2010. The lunar reconnaissance orbiter laser ranging investigation. *Space Sci. Rev.* 150, 63–80. <https://doi.org/10.1007/s11214-009-9511-z>.