



HAL
open science

Enhanced bowtie method for industrial risk analysis with uncertainties

Thibaud de Barnier, Nelly Olivier-Maget, Nadine Gabas, Iddir Olivier,
Florent Bourgeois

► **To cite this version:**

Thibaud de Barnier, Nelly Olivier-Maget, Nadine Gabas, Iddir Olivier, Florent Bourgeois. Enhanced bowtie method for industrial risk analysis with uncertainties. 23ème Congrès de Maîtrise des Risques et de Sécurité de Fonctionnement : “ Innovations et maîtrise des risques pour un avenir durable (Lambda Mu 23), IMdR: Institut pour la Maîtrise des Risques, Oct 2022, Paris Saclay, France. hal-03966668

HAL Id: hal-03966668

<https://hal.science/hal-03966668>

Submitted on 31 Jan 2023

HAL is a multi-disciplinary open access archive for the deposit and dissemination of scientific research documents, whether they are published or not. The documents may come from teaching and research institutions in France or abroad, or from public or private research centers.

L'archive ouverte pluridisciplinaire **HAL**, est destinée au dépôt et à la diffusion de documents scientifiques de niveau recherche, publiés ou non, émanant des établissements d'enseignement et de recherche français ou étrangers, des laboratoires publics ou privés.

Enhanced bowtie method for industrial risk analysis with uncertainties

Méthode bowtie améliorée pour l'analyse des risques industriels avec incertitudes

de BARNIER Thibaud
Technip Energies / LGC
Nanterre / Toulouse, France
thibaud.debarnier@technipenergies.com

OLIVIER-MAGET Nelly
LGC
Toulouse, France
nelly.olivier@ensiacet.fr

GABAS Nadine
LGC
Toulouse, France
nadine.gabas@ensiacet.fr

IDDIR Olivier
Technip Energies
Nanterre, France
olivier.iddir@technipenergies.com

BOURGEOIS Florent
LGC
Toulouse, France
florent.bourgeois@ensiacet.fr

Résumé — Dans le domaine des risques industriels, l'évaluation quantitative de l'occurrence des événements redoutés et des phénomènes dangereux est devenue incontournable. La méthode du nœud-papillon, combinaison des arbres de défaillances et d'événements, est largement utilisée et constitue un outil pour la prise de décisions. Cette technique, dans sa déclinaison actuelle, ne considère pas les incertitudes liées aux paramètres d'entrée qui déterminent cependant la variabilité des résultats. Notre étude propose une méthodologie d'analyse probabiliste du nœud-papillon prenant en compte les incertitudes sur les taux de défaillance d'équipements et les erreurs humaines. Cette approche est présentée et est appliquée à un cas d'étude industriel simple. L'intérêt de la prise en compte des incertitudes dans la quantification des risques est démontré en ce qui concerne les prises de décisions notamment pour les investissements en matière de barrières de sécurité.

Mots-clefs — *méthode du nœud-papillon, incertitudes, risque industriel, probabilités, simulation Monte-Carlo*

Abstract — In the field of industrial risks, the quantitative evaluation of the occurrence of critical events and hazardous phenomena has become essential. The bowtie method, a combination of fault and event trees, is widely used and constitutes a tool for decision making. This technique, in its current form, does not take into account the uncertainties related to the input parameters which nevertheless determine the variability of the results. Our study proposes a probabilistic analysis methodology for the bowtie that considers uncertainties in equipment failure rates and human errors. This approach is presented and applied to a simple industrial case study. The interest of considering uncertainties in the quantification of risks is demonstrated with regard to decision-making, particularly for investments in safety barriers.

Keywords — *bowtie method, uncertainties, industrial risk, probabilities, Monte-Carlo simulation*

I. INTRODUCTION

Bowtie risk analysis method was first introduced by the Imperial Chemical Industries Company. Following the 1988

Piper Alpha oil platform accident, the Royal Dutch Shell Company developed this technique to improve safety of such facilities. Nowadays, the bowtie method is widely used in industry and recommended by regulatory bodies for studying major hazard scenarios [1] [2]. It is a valuable tool for performing a detailed quantitative risk assessment, making decisions and communicating in industrial risk management [3].

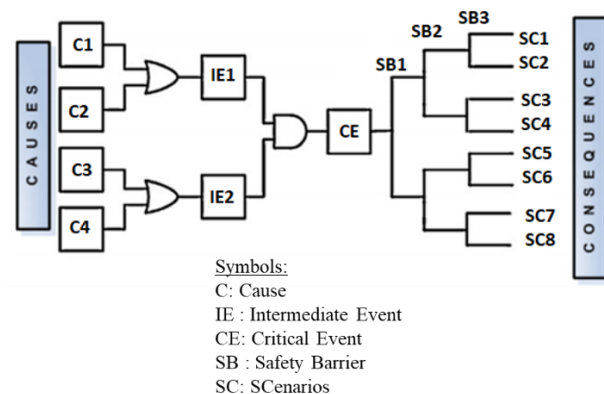

Fig. 1. Schematic of a bowtie

Fig. 1 shows a representation of a bowtie which combines a fault tree and an event tree that are on both sides of a Critical Event (CE). There are several causes (C) of a CE, for example, equipment failures or human error. The fault tree describes all the scenarios that lead to the CE. Intermediate events (IE) are defined to clarify the scenarios. The consequence scenarios depend on the success or failure of the safety barriers (SB). The quantification of the bowtie requires relevant input data relative to the occurrence of causes and to the reliability of safety barriers. Such data come from industrial databases, feedback or from expert's judgement. In all the cases, the data

include sources of uncertainties, qualified as epistemic or aleatoric, that should be considered using appropriate methods.

In the current practice, quantification of a risk consists of allocating an estimator related to its “occurrence”. This estimator is a probability or a frequency that can be determined by various risk analysis methods (including the quantified bowtie). It is then compared with threshold values, which makes it possible to decide on the risk acceptability. This approach is generally implemented through a risk acceptability matrix that couples probability of occurrence and severity levels (an example of this matrix used in French regulatory studies is represented in Fig. 2). Regardless of the chosen occurrence assessment method, the previous comparison goes through the evaluation of a point estimator (single value of probability or frequency of occurrence). This approach facilitates decision-making since it is then relatively easy to compare it to the threshold values (the estimator being either less than or greater than the threshold value). In such processes, uncertainties are implicitly taken into account through a supposed conservatism on the input data that feeds the estimator calculation.

		Probability (P)				
		E	D	C	B	A
		10 ⁻⁵	10 ⁻⁴	10 ⁻³	10 ⁻²	
Severity	Disastrous					
	Major	INTERMEDIATE RISK			HIGH RISK	
	Significant	(AI, ARP)				
	Serious					
	Moderate	MINOR RISK				

Fig. 2. Example of acceptability matrix used in French regulatory studies

In recent years, risk assessment methods have improved. It is now possible to deal with the input data uncertainties and to propagate them on the output data. Moreover, functional safety standards, such as IEC 61511, recommend accounting for uncertainties in the management of safety instrumented systems in the process industry sector. Some papers have presented various approaches of how to deal with uncertainties in a quantitative risk assessment and the follow-on decision process [4] [5]. They paid special attention to the highly uncertain aspect of human reliability influenced by organizational factors and working conditions.

The overall objective of our work is to examine the possibilities of modelling uncertainties associated with bowtie events on risk assessment and associated decision-making. Section II is a brief overview of the types of uncertainty models encountered in risk assessment. Section III presents a case study used for the assessment of risk propagation with uncertainties, whose results are discussed in Section IV. The paper ends with a set of conclusion statements and perspectives.

II. UNCERTAINTY MODELS

A. Types of uncertainties

In the risk assessment framework, quantification requires assessing occurrence of causes and reliability or availability of safety barriers. The data used in quantitative risk analysis, by their very nature, are necessarily subject to uncertainty. In addition, some values are based on assumptions to fill a knowledge gap in the system. The literature distinguishes two types of uncertainties, aleatoric and epistemic [6]. Aleatoric

uncertainties relate to the inherent stochastic nature of the system behavior, hence the common term random uncertainty. This type of uncertainty is statistical in nature and is quantified by probability distributions. Epistemic uncertainties are caused by a lack or incompleteness of knowledge of some data in the context of risk analysis. Such uncertainty relates to the ignorance of the user about the data rather than the underlying randomness of the data. Often little is known about human errors, which is one possible occurrence of epistemic uncertainties in bowtie risk analysis.

B. Models relevant in industrial risk analysis

Industry practices for risk assessment have evolved over time as shown in Fig. 3. The Piper Alpha disaster (1988) led to the widespread use of quantitative risk assessments (QRA) in decision support within the North Sea oil and gas industry. In France, AZF accident (2001) was a turning point in the development of the quantitative approaches in the safety studies framework. We moved from a qualitative analysis, to a quantitative single-point analysis and then to an analysis with uncertainties. However, even today there is still a step to take into account random and epistemic uncertainties with the appropriate models. This step, which would make it possible to obtain an accurate risk analysis, would correspond to a major change in industrial practices, as the commercial tools are not available today. This development will be, however, essential if rational decisions and investments are to be made on process safety. Today, the "best" compromise might be to apply the probabilistic method to all types of causes.

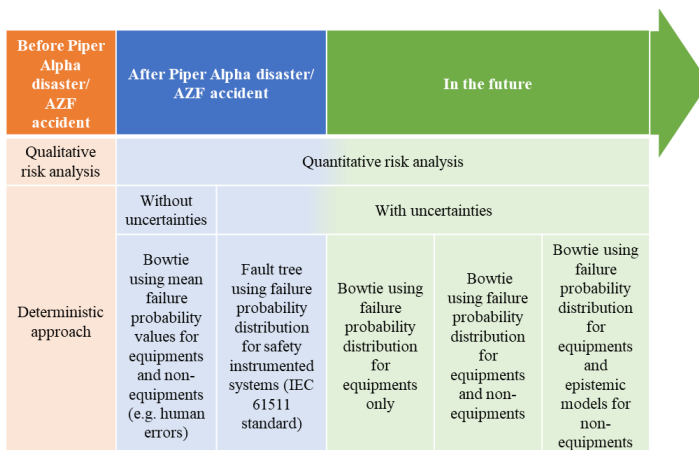

Fig. 3. Evolution over time of industrial risk assessment methods

Let’s present the uncertainty models relevant in risk analysis: those that apply to aleatoric uncertainties and those specific to epistemic uncertainties

C. Probabilistic models

Aleatoric uncertainties can be quantified by precise or imprecise probability distributions whose propagation through the bowtie is carried out using Bayesian rules and Monte Carlo simulation [7].

Precise probabilities apply typically to the failure rate of an equipment. Gamma and lognormal distributions often apply to these uncertainties, with well-documented parameters found in databases, such as OREDA database.

Imprecise probabilities also apply to random uncertainties, but they carry an uncertainty about parameters of the probability distribution used to model random uncertainties [8]. These parameters are themselves random variables that are quantified by a precise probability. Imprecise probabilities

yield a family of distributions that includes the precise probability as its most probable value.

D. Specific models for epistemic uncertainties

Possibility models are one means of dealing with epistemic uncertainties [9] [10]. A possibility measure can be computed from a set of nested confidence intervals. The knowledge about the data is therefore divided into a finite number of intervals with given degrees of possibility called α -cuts. The greater the number of α -cuts, the more precise the results. A confidence level is attached to each interval. A distribution of possibilities is then represented by two cumulative distributions, which bracket the lower and upper limits of occurrence of the event of interest. The distance between the two distributions is a direct measure of how imprecise the data is [11].

Belief functions apply to epistemic uncertainties defined by intervals that are not nested [12]. It is based on the definition of belief and plausibility functions that characterise the value of the variable. The number of α -cuts is limited to the number of intervals available.

The intervals model is applicable when the level of knowledge about failure rate data is low, one may only know that a given variable lies inside a single interval, defined by 2 observations. It is possible to know the minimum and maximum bounds of the probability of occurrence without being able to say anything about the distribution of this probability within this interval [13]. Interval arithmetic can be used to dealing with variables defined by a single interval.

III. CASE STUDY

To illustrate our methodology, a didactic case study is considered.

A. General description

Fig. 4 represents a semi-batch reactor in which an exothermic reaction is carried out. First, reactant A is introduced at the lower part of the reactor, then reactant B is pumped into the reactor. The catalyst is added by the operator. The temperature of the reactor is controlled by a cooling system (TIC). The critical event studied is thermal runaway.

The reactor is instrumented with two prevention barriers:

- an alarm set at high temperature (TAH) alerting the operator to stop the dosing and open the cooling valve fully.
- a Safety Instrumented System (SIS) at high high temperature (TSHH) stops the dosing and opens the cooling valve fully automatically (by an independent pilot valve bypassing the valve controller).

In addition, two mitigation barriers are implemented:

- an emergency dump which stops the reaction by emptying the overheating reactor into a tank containing a cold liquid.
- a pressure relief valve designed for the runaway scenario.

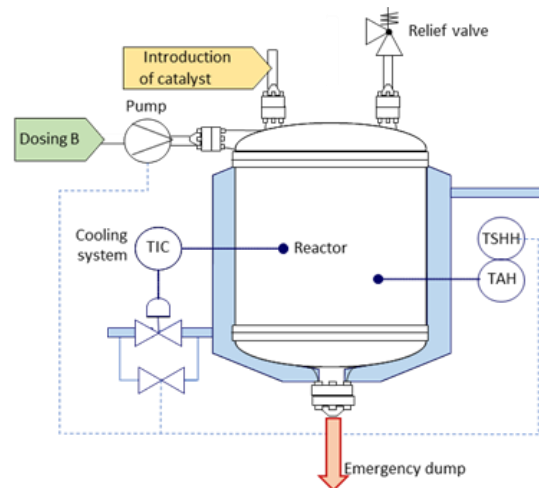

Fig. 4. Schematic representation of the case study

B. Bowtie of the case study

The corresponding bowtie of the case study is shown in Fig. 5.

Six causes (C_1 to C_6) and two safety barriers (SB_1 and SB_2) are considered. C_1 , C_3 , C_4 , C_6 and SB_1 and SB_2 deviation are relative to equipment failures. Two causes (C_2 and C_5) are due to human errors. This results in the occurrence of 3 consequence scenarios:

- Consequence scenario 1 (SC_1): explosion of the reactor due to the thermal runaway

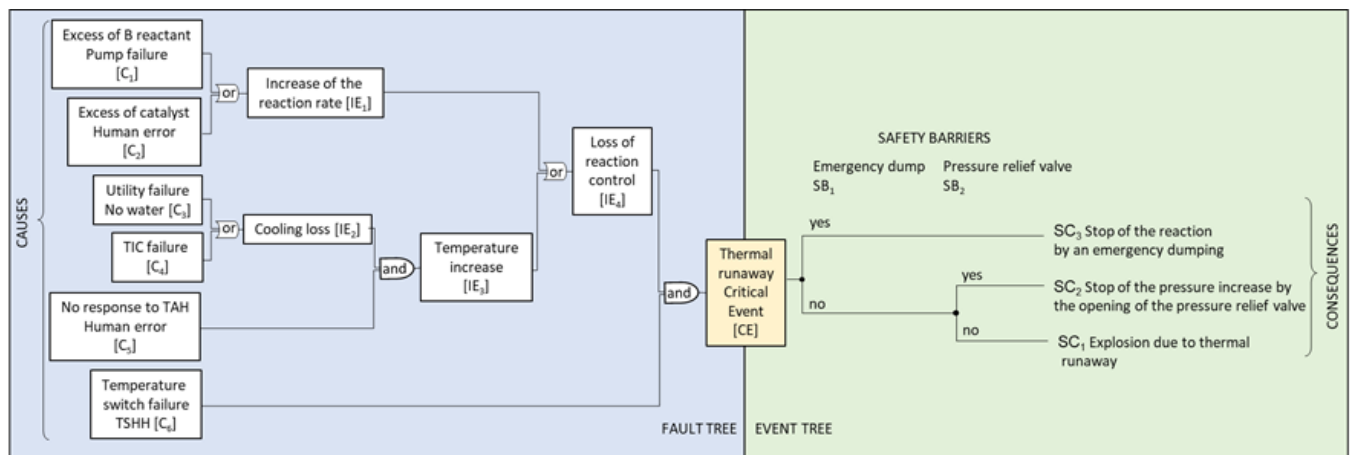

Fig. 5. Bowtie of the case study

- Consequence scenario 2 (SC₂): stop of the pressure increase by the opening of the pressure relief valve
- Consequence scenario 3 (SC₃): stop of the reaction thanks to the emergency dump.

C. Methodology of quantifying uncertainties

The objective of this paper is to propose a method of quantifying uncertainties in risk analysis using precise probabilities whether the uncertainties associated with failure rate values are epistemic or aleatoric. In consequence the bowtie is entirely probabilistic.

It should be noted that the probability of occurrence of an equipment failure follows the exponential distribution according the equation (1):

$$P(t)=1-e^{-\lambda t} \quad (1)$$

where λ is the equipment failure rate

Usually probability distribution functions are calculated from values taken in OREDA type database for equipment failures.

Concerning human errors, the data are from expert judgement or literature or methods like TESEO. An analyst is able to provide a max probability value (P_{max}), a mean probability value (P_{mean}) and a "most likely" value (P_{mode}).

The distributions are then propagated along the bowtie using Bayesian rules and Monte Carlo simulation. In output we obtain probability distributions of the probability of occurrence of the critical event and consequence scenarios.

This technique has a number of advantages for the analysts and decision makers:

- Possible implementation with currently available tools used in risk analysis (for example GRIF, package simulation developed by and proprietary to TotalEnergies.)
- Provides a range of uncertainties in the risk analysis results that allows for confidence in decision making.
- Allows investments in safety barriers to be made without further analysis.
- In some cases, provides quantitative evidence of the need to complete the bowtie sequences.

In our case study, two causes (C₂ and C₅), corresponding to human errors whose uncertainty is epistemic in nature, are treated with a probabilistic calculation identical to that used for other events intrinsically aleatoric (C₁, C₃, C₄, C₆, SB₁ and SB₂).

TABLE 1. EQUIPMENT FAILURE RATE VALUES AND TYPE OF DISTRIBUTION

Cause / Safety Barrier	λ_{min} per 10 ⁶ hr	λ_{mean} per 10 ⁶ hr	λ_{max} per 10 ⁶ hr	Source of data	Type of distribution
C ₁	0.79	4.13	9.61	Based on reliability data bases	Lognormal
C ₃	0.02	0.25	0.68	Based on reliability data bases	Lognormal
C ₄	0.71	1.87	3.48	Based on reliability data bases	Lognormal
C ₆	1.16	1.88	2.76	Based on reliability data bases	Lognormal
SB ₁	0.02	4.52	17.35	Based on reliability data bases	Lognormal

SB ₂	0.01	3.65	14	Based on reliability data bases	Lognormal
-----------------	------	------	----	---------------------------------	-----------

Table 1 presents the set of equipment failure rate values (for C₁, C₃, C₄, C₆, SB₁ and SB₂) and the type of distribution. For an equipment failure, databases such as OREDA handbook [14] report the mean failure rate at a set reference time t_{ref} , as well as the min and max confidence bounds of the failure rate, at a specified confidence, typically 90%. From these data, the parameters of truncated lognormal probability distribution are calculated.

TABLE 2. HUMAN ERROR PROBABILITY VALUES AND TYPE OF DISTRIBUTION

Cause	P _{min} × 10 ⁴	P _{mode} × 10 ⁴	P _{max} × 10 ⁴	Source of data	Type of distribution
C ₂	9.63	53.3	99.4	Expert judgement	Triangular Truncated lognormal Uniform
C ₅	99.4	424	951	Expert judgement	Triangular Truncated lognormal Uniform

The probability of human error is constant over time. The parameters of the chosen distribution are calculated at the reference time. For the triangular distribution, three values are initially defined: the minimal value (P_{min}), the maximal value (P_{max}) and the most probable value (P_{mode}). In this case, P_{mean} corresponds to the average of the three previous values. For the truncated lognormal distribution, the parameters are calculated by resolving a system of equations involving P_{max} and P_{mean} . The distribution is then truncated. In order to compare the three proposed distributions, P_{min} and P_{max} values are the same (cf. Fig. 6). P_{mean} and P_{mode} values are the same for triangular and truncated lognormal distributions (cf. Fig. 6).

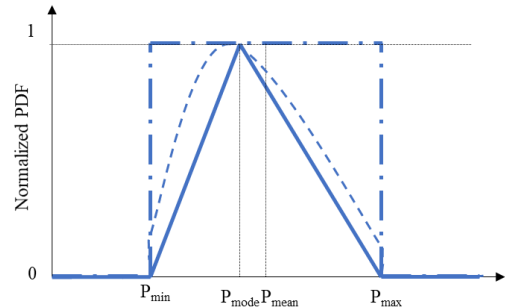

Fig. 6. Probability density functions used for human error

IV- RESULTS AND DISCUSSION

A. Results

The Monte-Carlo simulation (number of simulations runs: 10⁶, duration of simulation around 5 minutes) yields the probability distribution function of the probability of occurrence of the critical event and consequence scenarios 1 to 3 as a function of time (0.5 year ≤ t ≤ 5 years). Fig. 7, Fig. 8, Fig. 9 and Fig. 10 show the distribution of the probability of occurrence of the critical event, and the consequence scenarios 1 to 3 respectively versus time in a form of a boxplot. As the vertical axis is plotted on a log scale, the bounds of the risk acceptability matrix levels (A, B, C, D and E) can be drawn as horizontal lines on the same graph. Therefore, these figures give a direct quantification of the distribution of the risk occurrence of an event as a function of time. In these figures,

the failure rates of C_2 and C_5 have been represented by a triangular distribution.

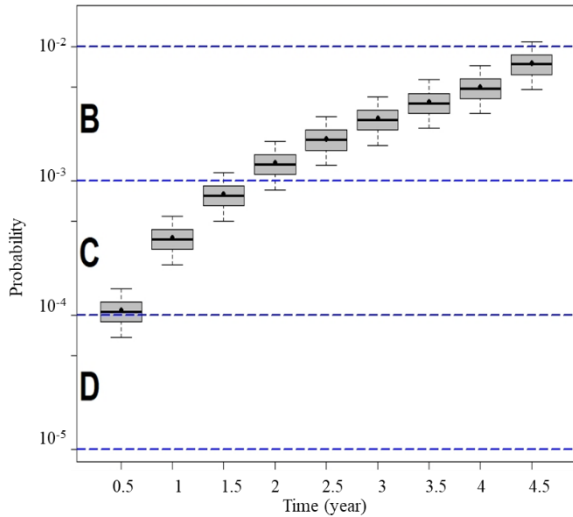

Fig. 7. Boxplot representation of the time variation of the probability of occurrence of the critical event

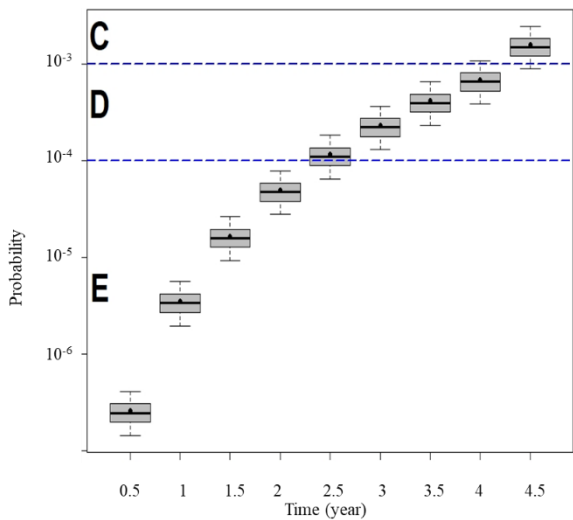

Fig. 8. Boxplot representation of the time variation of the probability of occurrence of the consequence scenario 1

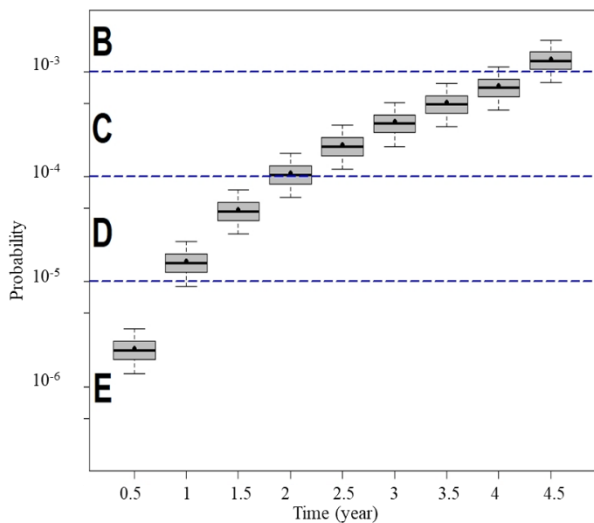

Fig. 9. Boxplot representation of the time variation of the probability of occurrence of the consequence scenario 2

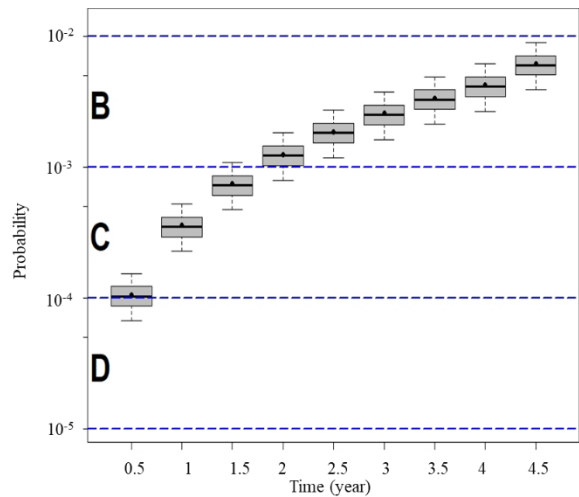

Fig. 10. Boxplot representation of the time variation of the probability of occurrence of the consequence scenario 3

Table 3 to Table 6 show the distribution of the probability of occurrence of the events in the risk classes, represented in Fig. 7 to Fig. 10 respectively, for three times (1 year, 2.5 years, 4 years). The results presented in these tables correspond to the 3 types of distribution chosen to represent human errors.

B. Discussion

Fig. 7 to Fig. 10 provide an understanding of the risk associated with an event that is rather different from the current approach which considers only the mean probability of occurrence.

At a given time t , the probability distribution of an event can spread across several risk classes. This is the case for example, in Table 4 at time $t = 2.5$ years, the explosion scenario occurrence probability spreads across D ($\approx 64\%$) and E ($\approx 36\%$) risk classes. One may wonder what decision to make in this situation.

It is also possible that the probability distribution is evenly split between two classes. This is the case for example, in Fig. 9 at time $t = 2$ years, the critical event occurrence probability spreads across C ($\approx 50\%$) and D ($\approx 50\%$) risk classes. It is therefore legitimate to ask whether it is reasonable to retain only class C corresponding to the median value, particularly with regard to decision making.

We could expect to have a stronger dispersion of the values with the human error uniform distribution law. But in this example, the choice of the distribution laws is not influential. This fact may be due to the combinatorics of the tree. The human error doesn't lead directly to the critical event.

The results between the different laws are approximately the same. And the single point approach gives the same conclusion. But, it is not possible here to draw generalizations. Indeed, this may be due to the large simulation number of the Monte Carlo simulation, but also to the fault tree structure. This fault tree is simplified. It is important here to carry out this study on other industrial cases where the human error would be a minimal cut of order 1 for example.

TABLE 3. DISTRIBUTION OF THE PROBABILITY OF OCCURRENCE OF THE CRITICAL EVENT IN THE RISK CLASSES VERSUS TIME (BOLD VALUES SHOW THE MAIN RISK LEVEL AS DERIVED FROM ITS PROBABILITY DISTRIBUTION)

Risk class (Probability bounds)	Time (year)								
	1			2.5			4		
	Uniform distribution for C ₂ and C ₅	Triangular distribution for C ₂ and C ₅	Truncated lognormal distribution for C ₂ and C ₅	Uniform distribution for C ₂ and C ₅	Triangular distribution for C ₂ and C ₅	Truncated lognormal distribution for C ₂ and C ₅	Uniform distribution for C ₂ and C ₅	Triangular distribution for C ₂ and C ₅	Truncated lognormal distribution for C ₂ and C ₅
A (>10 ⁻²)	< 0.0 5%	< 0.05 %	< 0.05 %	< 0.05 %	< 0.05 %	< 0.05 %	0.1 %	0.1 %	0.1 %
B (10 ⁻³ <P≤10 ⁻²)	< 0.05 %	< 0.05 %	< 0.05 %	99.5 %	99.6 %	99.6 %	99.9 %	99.9 %	99.9 %
C (10 ⁻⁴ <P≤10 ⁻³)	100.0 %	100.0 %	100.0 %	0.5 %	0.4 %	0.4 %	< 0.05 %	< 0.05 %	< 0.05 %
D (10 ⁻⁵ <P≤10 ⁻⁴)	< 0.05 %	< 0.05 %	< 0.05 %	< 0.05 %	< 0.05 %	< 0.05 %	< 0.05 %	< 0.05 %	< 0.05 %
E (P≤10 ⁻⁵)	< 0.05 %	< 0.05 %	< 0.05 %	< 0.05 %	< 0.05 %	< 0.05 %	< 0.05 %	< 0.05 %	< 0.05 %
Mean's probability /Mean's level	3.66 × 10 ⁻⁴ / C			2.03 × 10 ⁻³ / B			4.09 × 10 ⁻³ / B		

TABLE 4. DISTRIBUTION OF THE PROBABILITY OF OCCURRENCE OF THE CONSEQUENCE SCENARIO 1 IN THE RISK CLASSES VERSUS TIME (BOLD VALUES SHOW THE MAIN RISK LEVEL AS DERIVED FROM ITS PROBABILITY DISTRIBUTION)

Risk class (Probability bounds)	Time (year)								
	1			2.5			4		
	Uniform distribution for C ₂ and C ₅	Triangular distribution for C ₂ and C ₅	Truncated lognormal distribution for C ₂ and C ₅	Uniform distribution for C ₂ and C ₅	Triangular distribution for C ₂ and C ₅	Truncated lognormal distribution for C ₂ and C ₅	Uniform distribution for C ₂ and C ₅	Triangular distribution for C ₂ and C ₅	Truncated lognormal distribution for C ₂ and C ₅
A (>10 ⁻²)	< 0.05 %	< 0.05 %	< 0.05 %	< 0.05 %	< 0.05 %	< 0.05 %	< 0.05 %	< 0.05 %	< 0.05 %
B (10 ⁻³ <P≤10 ⁻²)	< 0.05 %	< 0.05 %	< 0.05 %	< 0.05 %	< 0.05 %	< 0.05 %	< 0.05 %	< 0.05 %	< 0.05 %
C (10 ⁻⁴ <P≤10 ⁻³)	< 0.05 %	< 0.05 %	< 0.05 %	< 0.05 %	< 0.05 %	< 0.05 %	8.8 %	8.5 %	8.6 %
D (10 ⁻⁵ <P≤10 ⁻⁴)	< 0.05 %	< 0.05 %	< 0.05 %	63.7 %	63.6 %	63.6 %	91.2 %	91.5 %	91.4 %
E (P≤10 ⁻⁵)	100.0 %	100.0 %	100.0 %	36.3 %	36.4 %	36.4 %	< 0.05 %	< 0.05 %	< 0.05 %
Mean's probability /Mean's level	3.39 × 10 ⁻⁷ / E			1.12 × 10 ⁻⁵ / D			6.59 × 10 ⁻⁵ / D		

TABLE 5. DISTRIBUTION OF THE PROBABILITY OF OCCURRENCE OF THE CONSEQUENCE SCENARIO 2 IN THE RISK CLASSES VERSUS TIME (BOLD VALUES SHOW THE MAIN RISK LEVEL AS DERIVED FROM ITS PROBABILITY DISTRIBUTION)

Risk class (Probability bounds)	Time (year)								
	1			2.5			4		
	Uniform distribution for C ₂ and C ₅	Triangular distribution for C ₂ and C ₅	Truncated lognormal distribution for C ₂ and C ₅	Uniform distribution for C ₂ and C ₅	Triangular distribution for C ₂ and C ₅	Truncated lognormal distribution for C ₂ and C ₅	Uniform distribution for C ₂ and C ₅	Triangular distribution for C ₂ and C ₅	Truncated lognormal distribution for C ₂ and C ₅
A (>10 ⁻²)	< 0.05 %	< 0.05 %	< 0.05 %	< 0.05 %	< 0.05 %	< 0.05 %	< 0.05 %	< 0.05 %	< 0.05 %
B (10 ⁻³ <P≤10 ⁻²)	< 0.05 %	< 0.05 %	< 0.05 %	< 0.05 %	< 0.05 %	< 0.05 %	11.1 %	10.8 %	10.9 %
C (10 ⁻⁴ <P≤10 ⁻³)	< 0.05 %	< 0.05 %	< 0.05 %	98.5 %	98.5 %	98.5 %	88.9 %	89.2 %	89.1 %
D (10 ⁻⁵ <P≤10 ⁻⁴)	90.8 %	91.0 %	91.0 %	1.5 %	1.5 %	1.5 %	< 0.05 %	< 0.05 %	< 0.05 %
E (P≤10 ⁻⁵)	9.2 %	9.0 %	9.0 %	< 0.05 %	< 0.05 %	< 0.05 %	< 0.05 %	< 0.05 %	< 0.05 %
Mean's probability /Mean's level	1.50 × 10 ⁻⁵ / D			1.94 × 10 ⁻⁴ / C			7.05 × 10 ⁻⁴ / C		

TABLE 6. DISTRIBUTION OF THE PROBABILITY OF OCCURRENCE OF THE CONSEQUENCE SCENARIO 3 IN THE RISK CLASSES VERSUS TIME (BOLD VALUES SHOW THE MAIN RISK LEVEL AS DERIVED FROM ITS PROBABILITY DISTRIBUTION)

Risk class (Probability bounds)	Time (year)								
	1			2.5			4		
	Uniform distribution for C ₂ and C ₅	Triangular distribution for C ₂ and C ₅	Truncated lognormal distribution for C ₂ and C ₅	Uniform distribution for C ₂ and C ₅	Triangular distribution for C ₂ and C ₅	Truncated lognormal distribution for C ₂ and C ₅	Uniform distribution for C ₂ and C ₅	Triangular distribution for C ₂ and C ₅	Truncated lognormal distribution for C ₂ and C ₅
A (>10 ⁻²)	< 0.05 %	< 0.05 %	< 0.05 %	< 0.05 %	< 0.05 %	< 0.05 %	< 0.05 %	< 0.05 %	< 0.05 %
B (10 ⁻³ <P≤10 ⁻²)	< 0.05 %	< 0.05 %	< 0.05 %	98.7 %	98.7 %	98.7 %	100.0%	100.0 %	100.0 %
C (10 ⁻⁴ <P≤10 ⁻³)	100.0 %	100.0 %	100.0 %	1.3 %	1.3 %	1.3 %	< 0.05 %	< 0.05 %	< 0.05 %
D (10 ⁻⁵ <P≤10 ⁻⁴)	< 0.05 %	< 0.05 %	< 0.05 %	< 0.05 %	< 0.05 %	< 0.05 %	< 0.05 %	< 0.05 %	< 0.05 %
E (P≤10 ⁻⁵)	< 0.05 %	< 0.05 %	< 0.05 %	< 0.05 %	< 0.05 %	< 0.0 5%	< 0.05%	< 0.05 %	< 0.05 %
Mean's probability /Mean's level	3.05 × 10 ⁻⁴ / C			2.72 × 10 ⁻³ / B			6.15 × 10 ⁻³ / B		

		Probability (P)				
		E	D	C	B	A
		10^{-5}	10^{-4}	10^{-3}	10^{-2}	
Severity	Disastrous					
	Major			← Case 1		
	Significant			← Case 2		
	Serious				← Case 2	
	Moderate					

Fig. 11. Risk acceptability matrix representing cases 1 and 2

To interpret our results to provide guidelines for decision-makers, it is interesting to locate the probabilities in the risk acceptability matrix. We can highlight two cases where considering uncertainties brings a real interest in the decision making. These two cases are represented in Fig. 11.

Case 1 corresponds to a critical situation where a high or very high percentage of the probability is located in the C class and the severity is in “major” class. The event is then mostly or completely located in the “high risk” zone. The positioning is not biased by uncertainties on the input data. So, the decision-maker can be rather confident in this outcome and he is quite convinced that the risk is unacceptable. There is a “real” process safety problem. Faced with this problem, it is possible to consider, as a first step to look back at the bowtie to make sure that the accidental sequences have been correctly transcribed (no missing AND gate events or safety barriers, and/or factors that would decrease the probabilities) and then to consider additional safety barriers implementation.

Case 2 corresponds to the situation where the probability distribution spreads evenly in the red zone and in the ALARP (As Low As Reasonably Practical) zone (*cf.* Fig. 11). One may ask where the probability single-value obtained with the current method lies: either the mean value is in an ALARP cell or in a red cell. In the current practice when the mean value is in the ALARP zone, we should demonstrate that risk reduction is impracticable or if its cost is grossly disproportionate to the improvement gained. When it is in the red zone, there is no choice except to add barriers. On the other hand, taking into account the uncertainties, if the mean value is in the ALARP zone with 50% of the probability distribution being in the red zone, a safe approach would still be to add additional barriers while keeping in mind that the probability is not totally in the red zone. This new information may be useful for calibrating the performance requirements for the additional barriers. This situation is where our approach is the most interesting because it permits a reasonable decision rather than a non-conservative or a too conservative one.

V – CONCLUSIONS

More and more design options are based on the results of quantified risk analysis and the stakes are therefore increasing. Overestimation of probability can lead to unjustified investments. On the contrary, an underestimation can lead to a lack of safety barriers or to a design not adapted to address the risk. The decision risk making based on quantified analysis results may be biased by not taking into account the uncertainties.

The approach proposed in this article is intended to be applicable to quantified risk analysis currently performed. Indeed, a choice was made to move towards a totally probabilistic approach (whatever the type of uncertainties) in

order to facilitate the implementation with regard to current practices.

The case study highlights that taking uncertainties into account does not necessarily lead to a more complex decision making process. In fact, it can provide decision-makers with additional information enabling them to decide with a better knowledge of the confidence that can be placed in the probability values.

To go further, providing guidelines for decision-makers to facilitate the use of uncertainty analysis results seems to be a prerequisite for democratizing approaches to dealing with uncertainties.

The development of new energies will require new processes. To guarantee risk control, risk analyses will remain essential. However, for analysts, it will be more difficult to rely on experience feedback (past accidents, databases, etc.). From this perspective, taking uncertainty into account in risk quantification is a real challenge for a sustainable future.

REFERENCES

- [1] O. Iddir, “Le noeud papillon : une méthode d’analyse des risques,” *Techniques de l’Ingénieur*, Paris, 2015, 0537
- [2] A. de Rujiter and F. Guldenmund, “The bowtie method: a review,” *Safety Science*, 88, 2016, pp. 211-218
- [3] S. Lewis and K. Smith, “Lessons learned from real world application of the bow-tie method,” *6th Global Congress on Process Safety*, San Antonia, USA, 2010
- [4] H. Pasman and W. Rogers, “How trustworthy are risk assessment result, and what can be done about the uncertainties they are plagued with?,” *Journal of Loss Prevention in the Process Industries*, 55, 2018, pp. 162-177
- [5] H. Abdo and J.M. Flaus, “Uncertainty quantification in dynamic system risk assessment: a new approach with randomness and fuzzy theory,” *International Journal of Production Research*, 54, 2016, pp. 5862-5885
- [6] P. Baraldi and E. Zio, “A combined Monte Carlo and possibilistic approach to uncertainty propagation in event tree analysis,” *Risk Analysis*, 28(5), 2008, pp. 1309-1326
- [7] Y. Wu, E. Li., Z.C. He, X.Y. Lin and H.X. Jiang., “Robust concurrent topology optimization of structure and its composite material considering uncertainty with imprecise probability,” *Computer Methods in Applied Mechanics and Engineering*, 364, 2020, 112927
- [8] P. Walley, “Towards a united theory of imprecise probability,” *International Journal of Approximate Reasoning*, 24 (2-3), 2000, pp. 125-148
- [9] G. Shafer, “Perspectives on the theory and practice of belief functions,” *International Journal of Approximate Reasoning*, 4(5-6), 1990, pp. 323-362.
- [10] D. Dubois and H. Prade, “Practical Methods for Constructing Possibility Distributions,” *International Journal of Intelligent Systems*, 31, 2015, pp. 215-239.
- [11] C. Baudrit, D. Guyonnet and D. Dubois, “Joint propagation of variability and imprecision in assessing the risk of groundwater contamination,” *Journal of Contaminant Hydrology*, 93, 2007, pp. 72-84
- [12] G. Shafer, “Perspectives on the theory and practice of belief functions,” *International Journal of Approximate Reasoning*, 4(5-6), 1990, pp. 323-362.
- [13] R.E. Moore, R.E. Kearfott and M.J. Cloud, “Introduction to interval analysis,” *Society for Industrial and Applied Mathematics*, Philadelphia, 2009
- [14] OREDA (Offshore and onshore RELiability DAta handbook, 2020, 8th edition