



HAL
open science

Evaluation of a decision-support tool for part orientation in EBM additive manufacturing

El-Haddi Mechekour, Frédéric Vignat, Christelle Grandvallet, Franck Pourroy,
Philippe René Marin, Jérôme Pailhès, Mouhamadou Mansour Mbow, Guy
Prudhomme

► To cite this version:

El-Haddi Mechekour, Frédéric Vignat, Christelle Grandvallet, Franck Pourroy, Philippe René Marin, et al.. Evaluation of a decision-support tool for part orientation in EBM additive manufacturing. International Journal of Advanced Manufacturing Technology, In press, 10.21203/rs.3.rs-2280855/v1 . hal-03965026

HAL Id: hal-03965026

<https://hal.science/hal-03965026v1>

Submitted on 31 Jan 2023

HAL is a multi-disciplinary open access archive for the deposit and dissemination of scientific research documents, whether they are published or not. The documents may come from teaching and research institutions in France or abroad, or from public or private research centers.

L'archive ouverte pluridisciplinaire **HAL**, est destinée au dépôt et à la diffusion de documents scientifiques de niveau recherche, publiés ou non, émanant des établissements d'enseignement et de recherche français ou étrangers, des laboratoires publics ou privés.

Copyright

Evaluation of a decision-support tool for part orientation in EBM additive manufacturing

El-Haddi Mechekour (✉ elhadi.mechekour@grenoble-inp.fr)

Laboratoire G-SCOP <https://orcid.org/0000-0001-5065-334X>

Frédéric Vignat

Christelle Grandvallet

Franck Pourroy

Philippe René Marin

Jérôme Pailhes

Mouhamadou Mansour Mbow

Guy Prudhomme

Research Article

Keywords: Decision-support, Additive Manufacturing, Part Orientation, EBM, Empirical study, Desirability function, Action rule

Posted Date: November 29th, 2022

DOI: <https://doi.org/10.21203/rs.3.rs-2280855/v1>

License: © ⓘ This work is licensed under a Creative Commons Attribution 4.0 International License.

[Read Full License](#)

Abstract

The activity of part orientation is of crucial importance in terms of impact on the quality of parts in powder bed additive manufacturing. To support the decision-making of Computer Aided Manufacturing (CAM) operators, several knowledge and software models are proposed. Even if they seem to help operators in orientation process, their operational effectiveness still needs to be scientifically assessed. This paper proposes to evaluate the efficiency of a part orientation software in assisting CAM engineers in part orientation choice. The related software is based on the mathematization of action rules issued from a knowledge model. The knowledge involved to carry out the orientation activity is analyzed based on the users' expertise. To do this, an empirical approach based on a case study is made with participants of different levels of skills. Several design scenarios including various part typologies to be oriented are submitted to engineers, before their manufacturing with Electron Beam Melting (EBM) technology. Two means of orientation are thus used for comparison, namely a manual orientation and a computer-aided orientation software. Based on the orientation results, an analysis of the software usage is undertaken. As an underlying result of our study, we have come up with an evaluation approach that can be reused in other contexts and with other software.

I. Introduction

Since decades, Additive Manufacturing (AM) technologies have experienced a growing boom in industries, thanks to the opportunities they provide, such as part shape freedom, lighter parts, customization of medical and orthopedic applications, etc. However, this change of paradigm implies new practices and new knowledge.

In this context, Computer-Aided Manufacturing (CAM) operators must perform new and complex activities to prepare parts fabrication. To assist them in their daily work many software have been developed. For instance, they support the design of innovative products [1][2][3][4] or the generation of support structures [5][6]. In general, these software tend to propose solutions to CAD/CAM users by optimizing multiple parameters so that, in the end, the decision is fully automated and the users do not really know if the proposed solution is the best. Hence the following questions: are these tools effective enough to CAD/CAM users? Which indicators would allow to assess and report how much a software can support these engineers?

Based on the work dedicated to help CAM user to orient part in EBM technology, with aim to include human in the loop of decision making [7], this paper deals with the evaluation of software tool with an empirical approach focusing in the quality of the results obtained using this tool. This evaluation will help us to quantify the contribution of such software to the efficiency and quality of the part orientation results obtained.

The paper is structured as follows. Section 2 presents the background and the research question. In Section 3, our evaluation approach is outlined and positioned according to the classical evaluation

approaches. In Section 4, the experimental protocol that we set up to evaluate the software is detailed. The results of the empirical study are discussed in Section 5, while Section 6 ends the paper with some concluding remarks and prospects.

ii. Background And Research Question

II.1. Additive manufacturing

In recent years, we have seen the evolution of additive manufacturing from a promising technology to one that is mature enough to produce quality parts. The level of maturity is not sufficient to surpass conventional manufacturing processes, but it is the only one currently capable of producing parts with very complex geometries, with the great advantage of going from the CAD model to the manufacturing stage with few steps compared to conventional manufacturing methods. In this context, to describe the process of additive manufacturing Gibson et al. [8] proposed a model with several steps that start from the design phase to the quality control stage of the product. The first steps concern operations related to CAD modelling. The following steps are specific to the task of the CAM operator and are related to the additive manufacturing technology used. Finally, the rest of the steps are necessary for the finishing of the manufactured product with the desired quality.

Among the additive manufacturing technologies, this paper focuses on Powder Bed Fusion (PBF) technology - Electron Beam Melting (EBM), and especially in a specific task of the CAM operator, which is the parts orientation.

II.2. Part orientation

Grandvallet et al. [9] describe the AM process for EBM technology by focusing on the CAM operator activities. From the Fig. 1, the first activity of the CAM operator is the activity of part orientation. Although this action seems simple as only two angles have to be set for orienting the part, it influences the entire additive manufacturing process due to its impact on the part quality, the post-processing time and cost.

Many authors have tackled the problem of calculating the orientation of parts in PBF technology [10][11][12][13][14]. They all mostly focus on the same criteria, namely:

- Surface quality related to roughness and staircase-effect problems;
- Supporting overhanging surfaces and quantity of supports;
- Manufacturing time related to the height of the part.

Grandvallet et al [15] proposed eight action rules to assist EBM engineers in part orientation.

II.3. About action rules

Grandvallet et al [9] has done a work of knowledge elicitation, a technique that helps to capture, integrate, and structure knowledge in order to share it more easily in a community of practice [16]. This work made

it possible to formalize - in the form of eight action rules - the knowledge involved by industrial experts while orienting parts for an EBM-type AM context:

1. Minimize part shadow on start plate
2. Minimize total overhanging non-machined surfaces
3. Orient part priority surfaces close to vertical
4. Orient machining datum surfaces out of horizontal
5. Minimize shape deformation risks
6. Avoid support structures and support removal difficulty on surfaces with potential support difficult to remove (so called SDR)
7. Fit the overall part size into the build envelope size
8. Orientate through holes and thread forms close to vertical

These rules have been integrated into COFFA software (in French “Conception et Optimisation des Formes pour la Fabrication Additive” or “Design and Shape Optimization for Additive Manufacturing”), specially developed to assist EBM part orientation action. This tool is presented in the next section and is the basis of this comparative research work.

II.4. About COFFA software

Mbow et al. [17] proposed an approach to translate these action rules into mathematical functions. To achieve this, a desirability concept is defined to mathematically express each action rule into a dimensionless function providing a value between zero and one. These desirability functions can be calculated according to the orientation of the part. After that, all the desirability functions are aggregated into one desirability function to help CAM operator to choose an orientation providing the best compromise between these height criteria. Due to the number of action rules and the number of parameters related to the part geometry, the evaluation of the desirability functions related to the action rules are difficult to achieve manually and sometimes it is even impossible to make this evaluation. The COFFA software has been developed to help CAM operator to make the evaluation of the desirabilities of the action rules and choose the orientation of the part by trying several possible scenarios.

After the operator has assigned attributes to relevant part’s surfaces, the software computes every set of desirabilities for a series of rotation angles along x and y axes. All of these are presented as a series of heatmaps from which the operator can make his choice of manufacturing orientation.

An example of such result is displayed in Fig. 2. From this point, the users can explore various orientations and see the values of the associated desirabilities, to finally make their choice of the manufacturing orientation.

We take a desirability map generated by COFFA as an example of “Minimize part shadow on start plate” (Fig. 3).

According to the action rule, the evaluation concept “shadow on start plate” is measured with respect to the projected area of the part on the machine plate (this variable is noted A_s), the corresponding relation is given in Eq. 1. By varying the orientation handles (namely x and y rotation angles), the value of the projected shadow area A_s will vary between A_{smin} (the minimum projected area) and A_{smax} (the maximum projected area) found when sweeping the domain.

The relational function is then a growing function bounded by A_{smin} and A_{smax} as shown by Fig. 4.a. Owing to the prescribed action “Minimize”, the resulting desirability function is the negation of the relational function; it is given by Eq. 2 and depicted in Fig. 4.b. In other words, great shadow area is not desirable, while a small one is desirable. No averaging operator is needed, because this applies to the whole volume. In this specific action rule, the users do not need to predefine the threshold values of projected area, because they entirely depend on the geometry of the part. Finally, the calculation is performed for each orientation position and the overall result will be represented in a heatmap (Fig. 2).

$$EC = \frac{A_s - A_{smin}}{A_{smax} - A_{smin}} \quad (1)$$

$$DF(A_s) = 1 - EC(A_s)$$

$$DF(A_s) = 1 - \frac{A_s - A_{smin}}{A_{smax} - A_{smin}} \quad (2)$$

Finally, the software calculates the weighted average desirability (Eq. 3) based on the desirability of the criteria calculated for each position. This operation, also called aggregation, will be used as one of the evaluation criteria in the following.

$$D = \prod_{i=1}^n d_i^{r_i} \quad (3)$$

With $r_1, \dots, r_i, \dots, r_n$ are positive weights $\in [0, 1]$ for which $\sum r_i = 1$, and $d_1, \dots, d_i, \dots, d_n$ are positive real numbers representing local desirability.

II.5. Research question

Based on the previous background and state of the art review, the refined research question is the following: How to evaluate if a decision-making tool allows a CAD/CAM user to make better choices about EBM part orientation? In this article, a “better choice” is defined as an orientation choice close to the reference orientation made by a group of experts.

Since the users do not have the same level of expertise, the decision support tool will not have the same contribution to the results obtained for each of them. It is easy to imagine that an expert has a more or less precise idea of the type of solution he/she is looking for, based on his knowledge, whereas the novice

has no idea of what he/she is looking for. Therefore, we can ask the research question in two different ways:

- In the case of a novice user, will the software help him/her to get closer to the results of an expert?
- In the case of an expert user instead, will the software help him/her to improve his/her results in terms of fabrication time or part's quality?

We consider that the evaluation of part orientation for EBM can be done on two steps of the AM process (see Fig. 5). In Fig. 5, the first level of evaluation is the subject of our paper. This first level concerns the evaluation of the user's choice using the COFFA decision support tool compared to the choice made by a group of expert. This comparison will be based on two parameters, which are the aggregate desirability and the orientation angles around the axes x and y. The following levels of evaluation are grouped together in a second phase, which focuses on the produced part. This second phase of the evaluation is related to the evaluation of the quality of the manufactured parts according to the choice of orientation made with COFFA software. For this second evaluation, we need to take into account many other factors in addition to the part orientation, such as region to support and design of supports, in the evaluation of the quality of the part. This last evaluation is in development stage and therefore will not be covered in this article.

The next section presents, the evaluation approach used for the phase 1.

iii. Evaluation Approach

III.1. Evaluation of usability

When we talk about software evaluation, the literature systematically refers us to the concept of usability which is widely used [18][19][20][21][22]. A definition of usability is provided by ISO9241 as "a system is usable when it enables the user to perform his task effectively, efficiently and satisfactorily in a specified context of use".

Usability evaluation is a qualitative and quantitative analysis of the use of a prototype or system. The aim is to provide user feedback as part of an iterative development process that allows designers to identify and understand problems, find the underlying causes and plan the necessary corrections in the software. The main aspects of usability evaluation such as metrics, audits, automation and standards are addressed by several researchers [23][24][25][26]. These evaluation approaches have different levels of implementation difficulty and expertise depending on the context, hence the need to choose an approach that fits our case study in this article.

On the other hand, there is a more global notion than usability, which is the quality of a software. According to the ISO9126 standard, software quality is represented by the following elements: functionality, reliability, usability, efficiency, maintainability and portability. However, some aspects that we want to evaluate in our study are not included in this list, such as the suitability of the tool to support

the user's approach and the quality of the results obtained. This leads us to use specific evaluation tools that focus on the knowledge mobilised during the use of the software as well as on the technical result obtained during the activity we want to assist. This last point will be dealt with in the next section.

III.2. Decision-making tools and their evaluation

The subject of decision support is widely covered in the scientific literature in a variety of fields. Among the best-known approaches, we can cite Fuzzy Multiple Criteria Decision Making, Multiple Attribute Decision Making, Weighted Sum Method, Weighted Product Method, Analytic Hierarchy Process and Compromise Ranking Method... [27][28][29][30]. However, the common point between these works is the fact that the problem is treated from an automation point of view based on multi-criteria optimization and the human factor is not included in the optimization loop.

When looking to the works on parts orientation in additive manufacturing cited above, we remain in the same spirit of automated multi-criteria optimization where the user chooses from a certain number of criteria and is offered a so-called "optimal" solution. However, in a field such as that of product design and manufacture, we know that the influencing factors and the models used are far from describing the problem in an "exact" way in relation to the complex reality of the problem. The knowledge and experience of the operator or user of the decision support software significantly influences the quality of the result and must be considered in the optimization process or at least in the choice of the best solution.

The evaluation of these decision support tools remains strongly linked to the technical aspect (calculation time, etc.) and we have not found in the bibliography any work that evaluates whether the decision support tool has really helped the user to make the right choice and what are the indicators of this evaluation.

III.3. Our approach

To evaluate the COFFA software, we set up a global evaluation approach of the parts orientation activity in EBM/AM context. The classical evaluation of software in our case does not allow us to see in detail the quality of the result obtained using COFFA software and if the tool had helped the user to make better choices.

We choose to represent the part orientation activity with the simplified activity model of Kuutti [31] from the model of Engeström [32] (Fig. 6). The vertices of the triangle of the activity model were then used as variables of the empirical study to see the influence of these key points on the result obtained by using the COFFA software. Each pair of vertices and the link between them was evaluated with a specific indicator.

Knowing that the orientation activity is a complex activity and its study in an industrial context is a difficult work to implement, the choice of experimentation with a scenario of case study was imposed to

us. An experimental protocol has been set up to implement this empirical study and will be presented in the following section.

The comparison of the results based on the three indicators: desirabilities, orientations plus the reference orientation obtained by a group of experts and the use of action rules, will allow the evaluating of the COFFA software through the quality of the results obtained and to see at the same time if COFFA has allowed the users to make better orientation choices according to the scenarios studied.

IV. Experimental Protocol

The choice of the type of experimentation is based on a situation scenario, which is in adequacy with our objectives of teaching as well as research. On the one hand, to train students in the activity of orienting parts in EBM context. On the other, to observe the actors and their activities in a parameterized and controlled context, in order to evaluate the relevance and quality of the tools made available to them to assist their activity.

IV.1. Objectives

IV.1.1 Teaching point of view

The novice users are engineering students in last year of education cycle. We introduce our empirical study into their training with the following aims:

- Introduce students to new advanced manufacturing techniques and in particular additive manufacturing;
- Introduce students to the activity of orienting parts in additive manufacturing for EBM;
- Train students in the use of specific tools related to their activity and to give them the knowledge necessary to carry out their work;
- Put the students in an additive manufacturing project situation to make them be aware of the problem and to make them think about the different aspects they have to deal with in this type of project.

IV.1.2 Research point of view

Our research is part of the Coffa project. This empirical study focuses on the following aims:

- Evaluate the usability of the COFFA tool to assist the user in his part orientation activity and the help to the choices brought by the desirability-based maps;
- Evaluate the quality of the results obtained with COFFA;
- Evaluate the concordance between good desirability and good part orientation in the case of additive manufacturing by EBM;

- Observe and analyze the use of the concept of action rules derived from the elicitation of expert knowledge by students (novices).
- Evaluate the overall part orientation activity through the use of COFFA software and action rules.

IV.2. Hypotheses

- The “optimal” orientation of the part for EBM is considered to be the most important among CAM operations (Fig. 1). The choice of this orientation is a complex task that has a very large impact on the quality of the part as well as on its manufacturing time and cost [3].
- The situation in our experimental scenario is considered to be similar to an industrial situation for the same type of activity.
- We consider that the students, at the end of their engineering cycle, who participate in this experimentation are similar to novice engineers who can be found in an industrial context at the beginning of their career. The students have already had all the technical education necessary to perform their tasks.
- The part orientation chosen by a group of experts is considered to be the reference orientation for the case studied.
- To avoid time consuming routines, all desirability computations have been performed prior to the experimentation with participants.

IV.3. Scenarios

The main purpose of our experimentation scenario was to put in situation actors, with different levels of expertise, to make the choice of orientation of parts (with different geometries and design criteria) according to the proposed study case, to be realized in additive manufacturing of EBM type. The user had to do this by applying the knowledge acquired through the action rules, using firstly a simple 3D viewer (without assistance) and then the COFFA software.

The participants were each provided with a computer with all the necessary software as well as materials describing the work required, a reminder of the action rules, and the questionnaires which they had to answer.

IV.4. Variable parameters

Following the activity model proposed in the previous section, the vertices of the triangle represent our variables, namely: subject, tool and object.

From there, we can say that the 2D triangle activity model has a more complex 3D shape by introducing the variables at the vertices (see Fig. 7). This will allow to evaluate the COFFA tool, but also to see the influence of the different variables on the part orientation activity in our EBM type additive manufacturing context.

IV.4.1 Subject: students, researchers

The empirical study was conducted with twelve students and seven experts. We performed the experiment with the researchers from our laboratory team. We considered that their expertise on the problem of additive manufacturing and their knowledge of the related physical phenomena give them an expert status compared to the students.

Before we finish on this point, we would like to clarify the term expert that we use in our article, namely that there are three types of experts:

- The experts who enabled the extraction of the EBM part orientation knowledge (CAM operators from industry);
- The experts who worked with the first category of experts to elicit this knowledge and develop the COFFA decision support software (researchers from the AM team of the G-SCOP laboratory);
- And finally the experts who did not participate in the work mentioned above but who regularly use the EBM machine (other members of the AM research team of the G-SCOP laboratory).

Only the last two categories of experts participated in the empirical study presented in this article.

IV.4.2 Tools: Coffa-viewer, COFFA

The Coffa-viewer software has been developed to be used as a simple neutral 3D viewer without any assistance tool for the orientation activity, unlike the COFFA software which includes several functionalities dedicated to the decision support in the orientation choice (Fig. 8).

IV.4.3 Objects: mechanical parts

The Fig. 9 shows the different parts used in the experimentation. The mechanical parts proposed in the experiment have different purposes of use:

- **Discovering part:** The first part has a simple geometric shape but two study cases with conflicting design criteria. This part was firstly used to enable the user to become familiar with the software and secondly to make them feel the difficulty underlying the activity of orienting parts and the difficult choice that the CAM operator has to make
- The students were then asked to orientate their own parts from their course project, to deepen their knowledge and skills regarding the part orientation activity. The parts had different geometries from one group to another and therefore the analysis of the results will not be considered in this article, only comparable results are kept.
- **Evaluating part:** The next part with a geometry close to that of the students' projects was to allow the evaluation the students' learning and to have a comparable result between the different students after a few hours of learning.

- **Mastering parts:** The last two parts were dedicated to the experts to see the influence of the complexity of the geometry on the orientation activity and to see a more in-depth exploitation of the COFFA software. We did not consider it interesting in our experiment to propose these rooms for the students given the level of knowledge they had.

IV.5. Progress of the experiment

The experiment was organized in 4 phases:

- With the students:
 - Phase 1 (1h30): Presentation of the software and reminder of the action rules
 - Phase 2 (4h30 + 3h): Part orientation activity with and without COFFA software
- With the experts:
 - Phase 3 (1h30 ~ 2h): Part orientation activity with and without COFFA software
 - Phase 4 (2h): Group work for reference orientations

During the part orientation activity phases, the participants had to orientate the parts with the Coffa-viewer in the first instance, following the order of the parts as presented above (Fig. 9). Each time they completed an orientation, the students had to record the oriented part and fill in the associated action rules questionnaire.

In the second phase, they had to repeat the orientation work with the COFFA software in the same way, and in addition fill in the usability questionnaire on the first and last use of the software.

An additional session was added to debrief and discuss with the students the results they had obtained and the answers they had given in the different questionnaires. This session allowed to clarify some of the answers given and to have a direct feedback on their experience of using the software.

In the last phase, all the experts who took part to the experimentation were grouped together to determine the optimal orientation for each part and each case study by comparing their points of view. These so-called reference orientations allow us to compare the results obtained by the students and the experts individually and to have the corresponding desirabilities to see if they confirm our initial hypotheses.

Finally, the usage sequence of COFFA software after COFFA-viewer has been chosen to accentuate the learning and appropriation of the concept of action rules. In the case of COFFA-viewer, the user must understand the action rules and use them by mentally visualizing their influence on the study case. This mental work facilitates the comprehension of the action rules, and consequently the use of decision support by COFFA software becomes more efficient by being less impacted by comprehension difficulties.

V. Results And Discussions

V.1. Aggregation of the desirabilities

To compare the orientation results, we used two criteria: the aggregation of the desirabilities of the different action rules for a given orientation, and the reference orientation values determined by the expert group. The following graphs in Fig. 10 were obtained.

For the experts, we gave them two additional parts with complex geometry. (see Fig. 11)

Overall, the aggregation scores of the desirability of the orientations made with COFFA are higher than those obtained with Coffa-viewer, which is a simple 3D viewer. This result is the same in general for the students and for the experts with some exceptions.

Moreover, COFFA avoids the choice of too bad orientation, even in the case of experts. Knowing that the aggregation is a product with similar points, if a desirability value is equal to zero for a criterion (example support difficult to remove or maximum risk of deformation) the aggregation value will be equal to zero too. According to the questionnaire given to experts, one exception has been noted for the Discovering - part 1 oriented with COFFA, where two experts judged that the orientation they chose, even if "deformation risks" were equal to zero, would not affect the result in a significant way with regard to the given design criteria. This experimentation allowed highlighting the fact that some experts do not use the action rules because they consider that there are other rules, coming from their own experience and knowledge, which have priority. This makes it possible to enrich the action rules and consequently the associated decision support tool.

Figure 12 shows the average gain provided by COFFA, which is calculated by averaging the difference between the aggregation score obtained with COFFA and with Coffa-viewer for all the parts oriented by the participants. Overall, it can be said that COFFA brings more help to a novice like the students in comparison to the experts, who tended to make some choices that did not correspond to the higher desirability values but that better corresponded to their expectations in terms of orientation and their knowledge of the EBM manufacturing process.

V.2. Use of the Action Rules

Figure 13 shows the use of action rules to orientate the parts during the experimentation. The first remark that can be made is the fact that the experts mobilize more action rules to orientate their parts than the students, which is perfectly normal, if we consider that an expert can consider several factors at the same time in his orientation activity that a novice will not necessarily do.

On the other hand, action rule 7 relating to the part envelope was not used much because of the given scenarios, and more precisely because they had only one part to orientate each time and the dimensions were not very large.

It can also be said that action rule n°1 relating to the silhouette of the projection of the part on the machine table was not used much because of the proposed scenarios and the context which did not

impose a high level of productivity on the participants in the experiment.

Concerning the action rule n°5 relating to the risk of deformation, there is a contrast between its use by the experts and the students. The problem of incomprehension and difficulty of use raised by the students during the debriefing reflects their low use of this action rule, which is not the case for the experts, who used it in a much more significant way.

We also see that whatever the case, the experts almost always use action rules 3 and 6 (Priority surfaces and SSSDR). This shows that they tend to prioritize certain action rules over others.

On the other hand, the use of action rules with COFFA is more massive for the experts than for the students, who did not exploit the software's full potential.

Finally, we can also observe that the students did a good job of appropriating the action rules for orienting the parts, based on the very similar results of using the action rules with Coffa-viewer and COFFA. Regardless of the use of the COFFA software, this shows that the action rules are simple and clear enough for beginners who have only had basic training in these concepts to be able to mobilize them to carry out the activity of orienting parts for the EBM.

V.3. Comparative analysis of results

V.4. 1. Decisions made by Coffa-viewer vs. COFFA

From the graphs in Fig. 14, the following remarks can be made:

- The choices made with the COFFA tool are much more clustered, and symmetrical orientations, with respect to the X and Y axes, appear to be the choices of most participants (students and experts).
- The choice proposed by the COFFA software with the highest value of aggregation of desirability, with the same coefficients, was chosen several times by the experts individually and collectively as being a good orientation, and in some cases as the reference orientation. For the pieces where this choice was not retained, we found that by aggregating only the action rules used by the experts, we found a very close result, or even the same reference choice. This shows us that the choice of indicator from the aggregation is a good indicator of orientation based on desirabilities.
- Sometimes the choices are very close to the reference orientation, which shows that an orientation of a few degrees around a user's choice can further improve the overall desirability value and thus have a better orientation of the part being manufactured. This is in line with a need expressed by the experts during the experimentation to have a zoom tool on the heatmap to better explore the results around a given orientation to help them in their decision.

For the experts, we have two additional parts with complex geometry: (see Fig. 15)

For parts with complex geometry, the experts were able to avoid very bad orientation choices thanks to the use of the COFFA tool, as can be seen in the graphs of the Fig. 11. On the other hand, the experts

underlined the difficulty of evaluating certain criteria (e.g. supports that are difficult to remove) for parts with complex geometry, which, according to them, require the improvement of the decision-support tool by adding some features related to the exploitation of the result (zoom in the heatmap, exploring tool, etc.).

To answer our initial research question, we implemented indicators during the empirical study, namely: aggregated desirability, part orientation in the solution space and the use of action rules. In addition, the comparison of the use of COFFA software versus Coffa-viewer highlights the usefulness of using a decision support tool for part orientation in EBM.

The use of the COFFA software allows better choices to be made in most cases and sometimes avoids making a bad choice for both novice and expert users. The other usefulness observed during the empirical study concerns more the expert users who used the software to verify certain orientations and were able to justify their choices based on the desirability graphs, which represents a particularly interesting use in an industrial context.

V.5. 2. Decisions made by students vs. experts

We observed that students exclusively base their choices on what the software proposes to them in terms of heatmap desirabilities, while the experts make their choices by integrating in their reflection a phenomenological aspect of the additive manufacturing process as well as their experience of manufacturing on an EBM machine for some of them. In all case, even if the strategies of use change completely between the students and the experts the result is finally very close. We find symmetrical orientations, which emerge in the choice of the students and the experts, while avoiding the bad choices that they could have made with the 3D visualizer.

The Fig. 16 shows that the choice of orientation made by students, even if it is different from that of experts, still has a good desirability value.

The last point we will address is related to the question: does the COFFA software allow a novice user to approach the result of an expert in EBM parts orientation? According to the indicators set up, even if the choice is not exactly the same between the two categories of users, the choice made by the students is still very good in relation to the hypothesis that a good orientation corresponds to a good desirability.

Vi. Conclusion

This paper proposes to assess a decision-support software called COFFA for part orientation in the context of EBM additive manufacturing. We set up an empirical approach that allowed us to observe the use of the software in different situations and to collect data related to our indicators in order to answer our research question. The confrontation of the results obtained using the COFFA software and a simple 3D viewer as well as the results obtained by the students and the experts leads to the following conclusion:

- COFFA software prevents the user from making the wrong choice regarding the criteria related to the evaluation concepts (let us recall that these concepts were established by the elicitation of the knowledge of trade experts);
- The aggregation of the desirabilities for a given orientation of the part represents a good indicator of the user's choice. This partially confirms our hypothesis that a good desirability corresponds to a good choice of orientation of the part;
- COFFA software allows experts to verify the orientations of parts in terms of desirability and thus to confirm their choices and even justify them.

As an underlying result, the overall approach undertaken for the evaluation of the COFFA software can be generalized for application to other software in other contexts, with the following steps:

1. Preparation phase :

1.1 Identify the activity and the different elements of the associated activity model;

1.2 Identify the indicators associated with the expected results;

1.3 Choose the evaluation tools according to the indicators.

2. Experimentation phase :

2.1 Set up an empirical study based on the elements of the preparation phase;

2.2 Collect data from the experiment.

3. Analysis and recommendation phase:

3.1 Formatting the collected data;

3.2 Analyzing the results;

3.3 Make conclusions and recommendations based on the cross-analysis of the results.

As a perspective to this work, we propose to see the implications of the orientation choices on the rest of the additive manufacturing process, going up to the parts made with the EBM machine. As already indicated, there is another level of evaluation that needs to be explored in more depth by trying to pay attention to other elements that can influence the final result of the manufacturing process (choice of areas to be supported, design of supports, post-processing...). New indicators should be put in place, such as volume of supports and time of removing supports, to compare the results as independently as possible from the CAM operator, so that the results remain comparable.

Declarations

Funding

The authors declare that no funds, grants, or other support were received during the preparation of this manuscript.

Competing Interests

The authors have no relevant financial or non-financial interests to disclose.

Author Contributions

All authors contributed to the study conception and design. The first draft of the manuscript was written by El-Haddi Mechekour and all authors commented on previous versions of the manuscript. All authors read and approved the final manuscript.

Acknowledgements

This work benefited from the support of the project COFFA ANR-17-CE10-0008 of the French National Research Agency (ANR) and DP Research Institute KAM Lab project.

References

1. Perez, K. B., 2018, "Design Innovation with Additive Manufacturing (AM): An AM-Centric Design Innovation Process," PhD thesis Dissertation, Singapore University of Technology and Design.
2. Boyard, N., Rivette, M., Christmann, O., and Richir, S., 2013, "A Design Methodology for Parts Using Additive Manufacturing," 6th International Conference on Advanced Research in Virtual and Rapid Prototyping, pp. 399–404.
3. Frédéric Segonds. Design By Additive Manufacturing: an application in aeronautics and defence. Virtual and Physical Prototyping, 2018, 13 (14), pp.237-245.
4. Jihong ZHU, Han ZHOU, Chuang WANG, Lu ZHOU, Shangqin YUAN, Weihong ZHANG, A review of topology optimization for additive manufacturing: Status and challenges, Chinese Journal of Aeronautics, Volume 34, Issue 1, 2021, Pages 91-110, ISSN 1000-9361, <https://doi.org/10.1016/j.cja.2020.09.020>
5. Jiang, Jingchao & Xu, Xun & Stringer, Jonathan. (2018). Support Structures for Additive Manufacturing: A Review. Journal of Manufacturing and Materials Processing. 2. <https://doi.org/10.3390/jmmp2040064>
6. Rohan Vaidya, Sam Anand, Optimum Support Structure Generation for Additive Manufacturing Using Unit Cell Structures and Support Removal Constraint, Procedia Manufacturing, Volume 5, 2016, Pages 1043-1059, ISSN 2351-9789, <https://doi.org/10.1016/j.promfg.2016.08.072>
7. Turner, C.J., Ma, R., Chen, J. et al. (1 more author) (2021) Human in the loop: industry 4.0 technologies and scenarios for worker mediation of automated manufacturing. IEEE Access, 9. pp.

103950-103966. ISSN 2169-3536, <https://doi.org/10.1109/access.2021.3099311>

8. Gibson, I., Rosen, D.W., Stucker, B.: Design for additive manufacturing. *Addit. Manuf. Technol.* (2015). https://doi.org/10.1007/978-1-4939-2113-3_17
9. Grandvallet, C., Pourroy, F., Prudhomme, G., & Vignat, F. (2017). From elicitation to structuration of additive manufacturing knowledge. In 21st international conference on engineering design ICED17, Vol. 6: design information and knowledge, Vancouver, Canada 21–25.08.2017.
10. Pandey, P. M., Reddy, N. V., & Dhande, S. G. (2007). Part deposition orientation studies in layered manufacturing. *Journal of Materials Processing Technology*, 185, 125–131.
11. Das, P., Chandran, R., Samant, R., & Anand, S. (2015). Optimum part build orientation in additive manufacturing for minimizing part errors and support structures. *Procedia Manufacturing*, 1, 343–354.
12. Delfs, P., Tows, M., & Schmid, H.-J. (2016). Optimized build orientation of additive manufactured parts for improved surface quality and build time. *Additive Manufacturing*, 12, 314–320.
13. Zhang, Y., Bernard, A., Harik, R., & Karunakaran, K. P. (2017). Build orientation optimization for multi-part production in additive manufacturing. *Journal of Intelligent Manufacturing*, 28, 1393–1407.
14. Qin, Y., Qi, Q., Scott, P. J., & Jiang, X. (2019). Determination of optimal build orientation for additive manufacturing using Muirhead mean and prioritised average operators. *Journal of Intelligent Manufacturing*, 30, 3015–3034.
15. Grandvallet, C., Mbow, M. M., Mainwaring, T., Vignat, F., Pourroy, F., & Marin, P. R.: Eight action rules for the orientation of additive manufacturing parts in powder bed fusion: an industry practice. *International Journal on Interactive Design and Manufacturing*, 14, 1159-1170. (2020)
16. Cooke, N. J. (1994). Varieties of knowledge elicitation techniques. *International Journal Human-Computer Studies*, 41, 801–849.
17. Mbow M. M., Grandvallet C., Vignat F., Marin Ph. R., Perry N., et al.. Mathematization of experts knowledge: example of part orientation in additive manufacturing. *Journal of Intelligent Manufacturing*, Springer Verlag (Germany), 2021, pp.1-19.
18. S. Charlton and T. O'Brien. *Handbook of Human Factors Testing and Evaluation*. John Wiley and Sons, 2001.
19. Rubin, J., & Chisnell, D. (2008). *Handbook of usability testing*. (2nd ed., pp. 9-20). Indianapolis, IN: Wiley Publishing, Inc.
20. R. Bias and D. Mayhew. *Cost Justifying Usability*. Morgan Kaufmann, 2005.
21. Brooke, J., 1996. SUS: A “quick and dirty” usability scale. In: Jordan, P.W., Thomas, B., Weerdmeester, B.A., McClelland, A.L. (Eds.), *Usability Evaluation in Industry*. Taylor and Francis, London.
22. James R. Lewis (2018): The System Usability Scale: Past, Present, and Future, *International Journal of Human–Computer Interaction*, <https://doi.org/10.1080/10447318.2018.1455307>

23. Bangor, A., Kortum, P. T., & Miller, J. T. (2008). An empirical evaluation of the System Usability Scale. *International Journal of Human-Computer Interaction*, 6, 574-594.
24. Seffah, Ahmed & Donyaee, Mohammad & Kline, Rex & Padda, Harkirat. (2006). Usability measurement and metrics: A consolidated model. *Software Quality Journal*. 14. 159-178. <https://doi.org/10.1007/s11219-006-7600-8>
25. Sivaji, A. & Soo, Shi-Tzuaan & Abdullah, Mohamed. (2011). Enhancing the Effectiveness of Usability Evaluation by Automated Heuristic Evaluation System. 48 - 53. <https://doi.org/10.1109/CICSyN.2011.23>
26. Melody Y. Ivory & Marti A. Hearst. (2001). The State of the Art in Automating Usability Evaluation of User Interfaces. *ACM Computing Surveys*, Vol. 33, No. 4, December 2001, pp. 470–516.
27. Hwang, C.L., and Yoon, K. (1981), *Multiple Attribute Decision Making Methods and Applications: A State-of-the-Art Survey*, Springer-Verlag, New York.
28. Saaty TL (1980) *The analytic hierarchy process*. McGraw Hill, New York
29. Mardani, A., Jusoh, A., Zavadskas, E.K., *Fuzzy multiple criteria decision-making techniques and applications – Two decades review from 1994 to 2014*, *Expert Systems with Applications* (2015), <http://dx.doi.org/10.1016/j.eswa.2015.01.003>
30. R. Venkata Rao. (2007). *Decision Making in the Manufacturing Environment: Using Graph Theory and Fuzzy Multiple Attribute Decision Making Methods*. Springer Series in Advanced Manufacturing. Springer London. 374 pp. <https://doi.org/10.1007/978-1-84628-819-7>
31. Kari Kuutti. *Context and Consciousness: Activity Theory and Human Computer Interaction*, chapter Activity Theory as a potential framework for humancomputer interaction research, pages 17–44. Published in B.A. Nardi (ed.), Cambridge: MIT Press, 1996.
32. Y. Engeström. *Learning by expanding : an activity-theoretical approach to developmental research*. Orienta-Konsultit Oy, Helsinki, 1987.

Figures

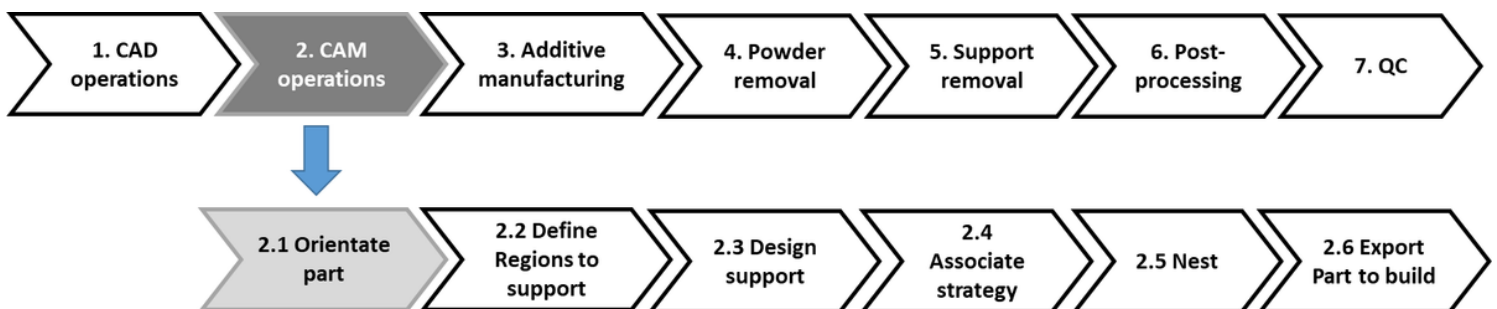

Figure 1

AM Process from [9]

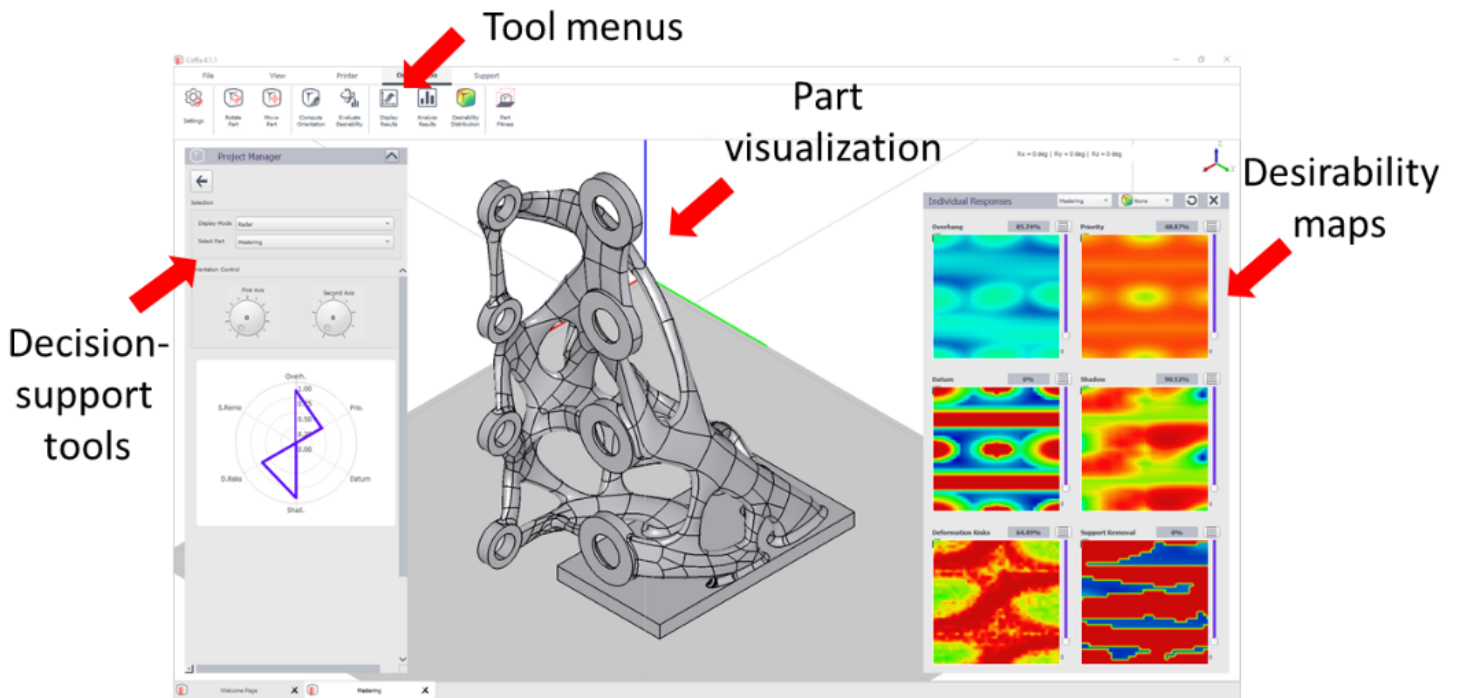

Figure 2

COFFA software interface

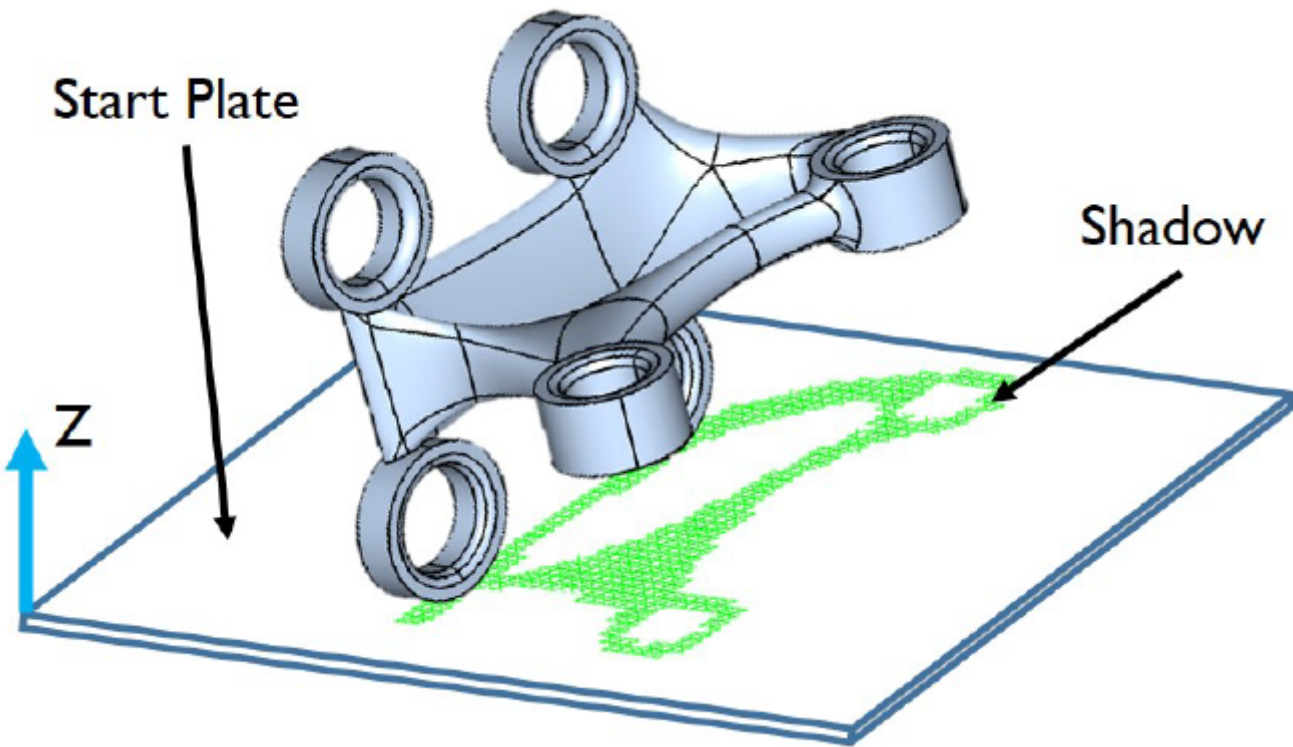

Figure 3

Illustration of part shadow projection on start plate (COFFA software)

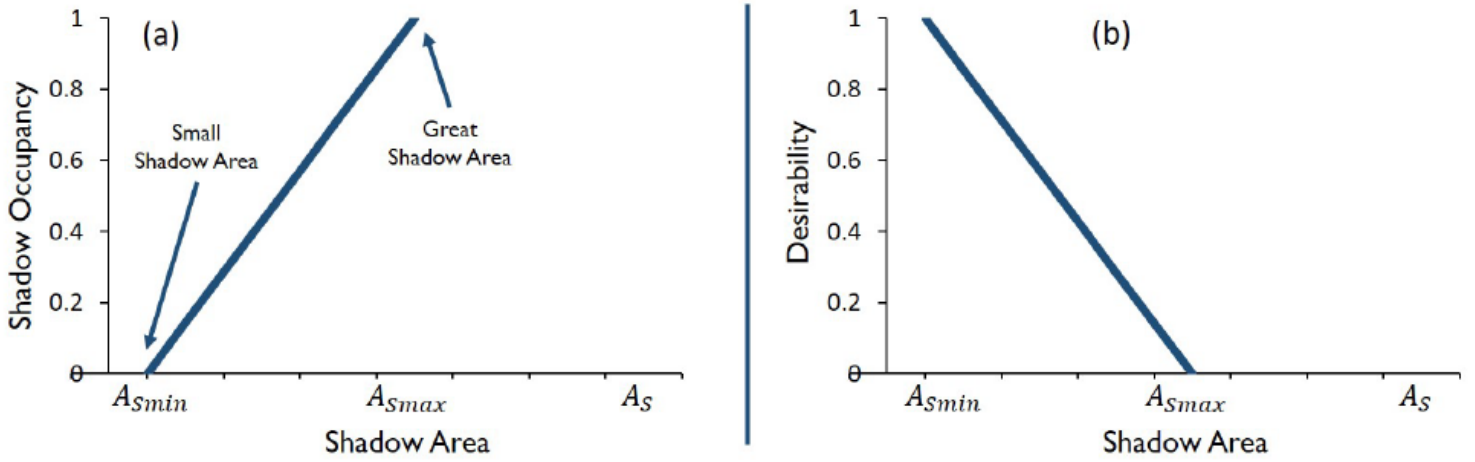

Figure 4

Action rule « shadow » quantitative representation model: (a) Relational function; (b) Desirability function

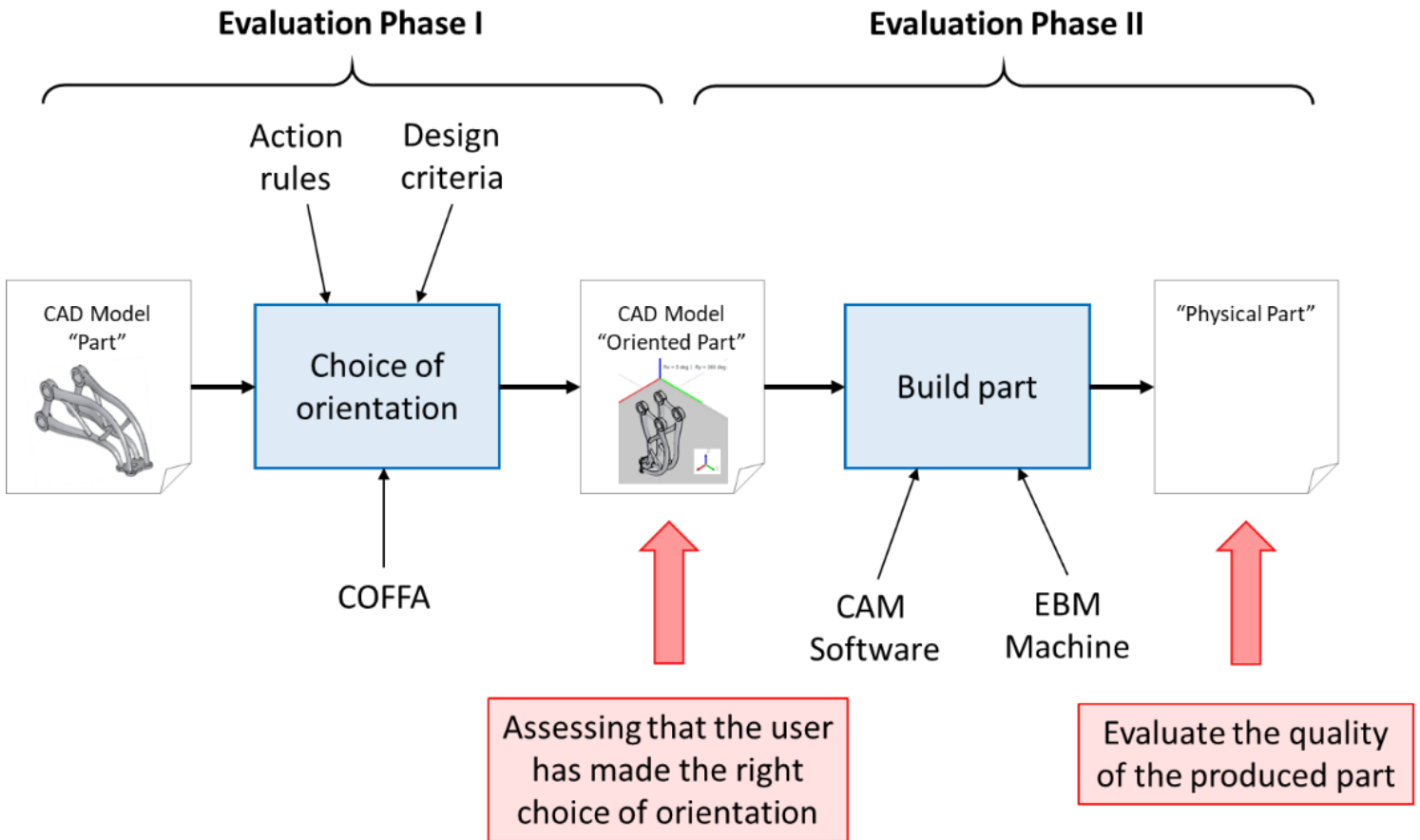

Figure 5

Empirical approach of our study

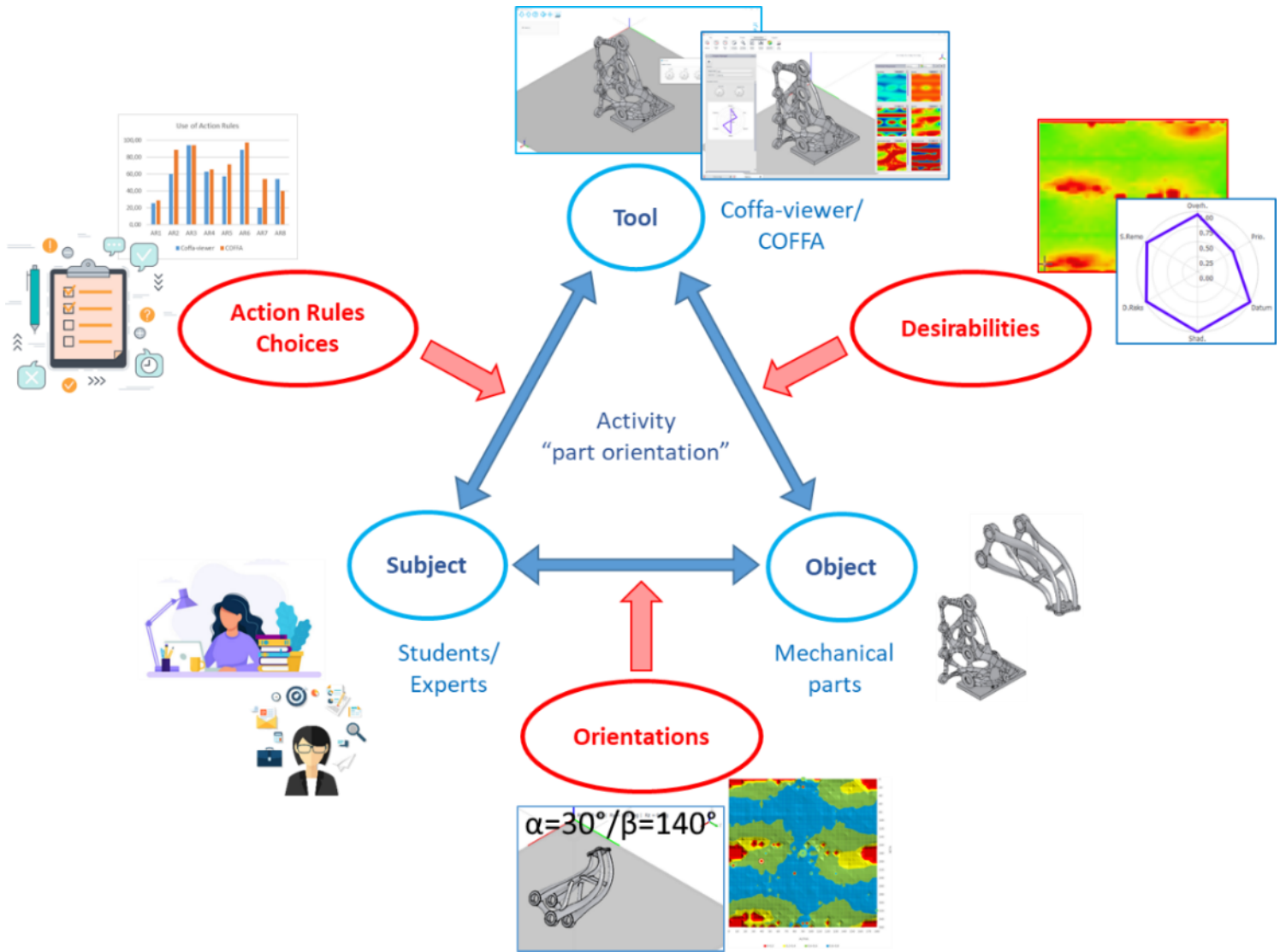

Figure 6

Proposed empirical approach

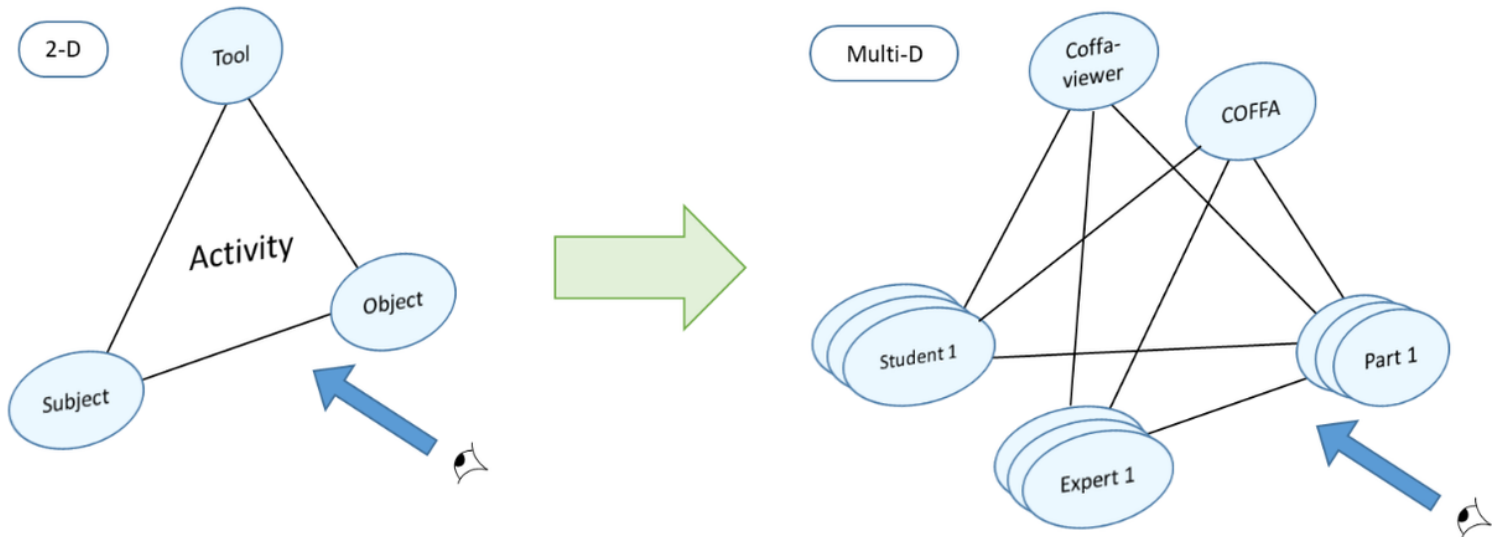

Figure 7

Multi-dimensional activity model

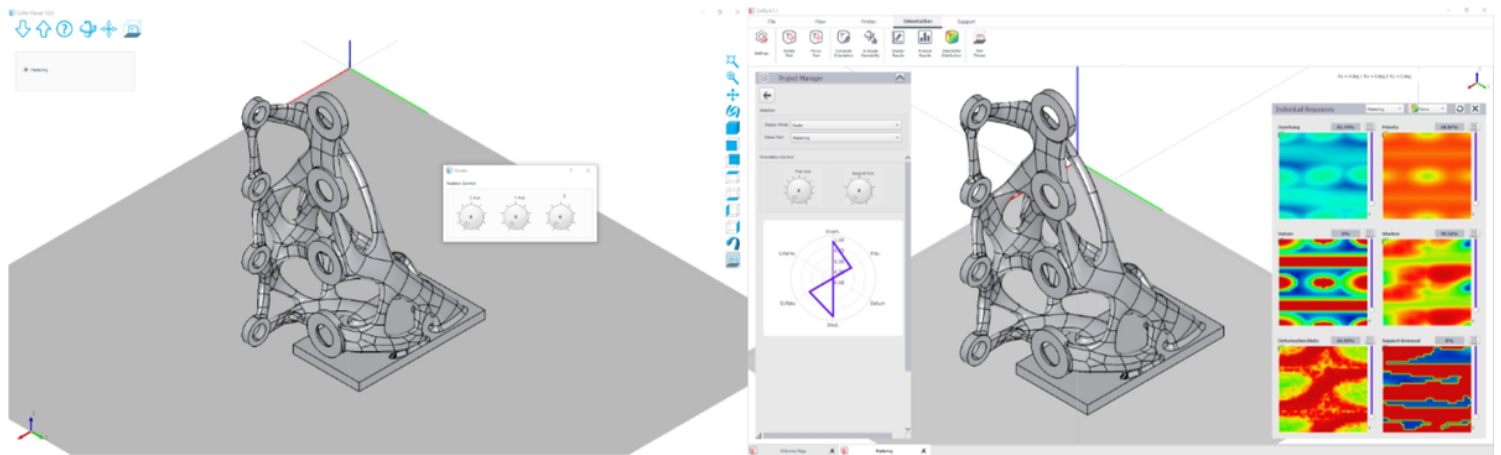

Figure 8

GUI of Coffa-viewer (left) and COFFA (right)

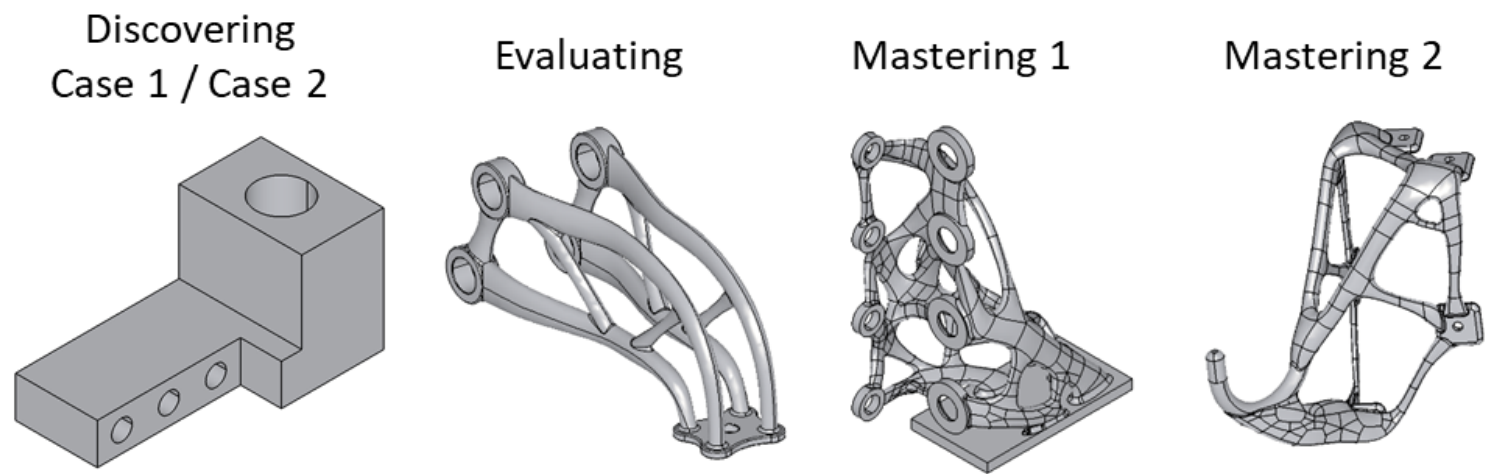

Figure 9

Mechanical parts to orient



Figure 10

Aggregation of desirabilities of common parts (students & experts)

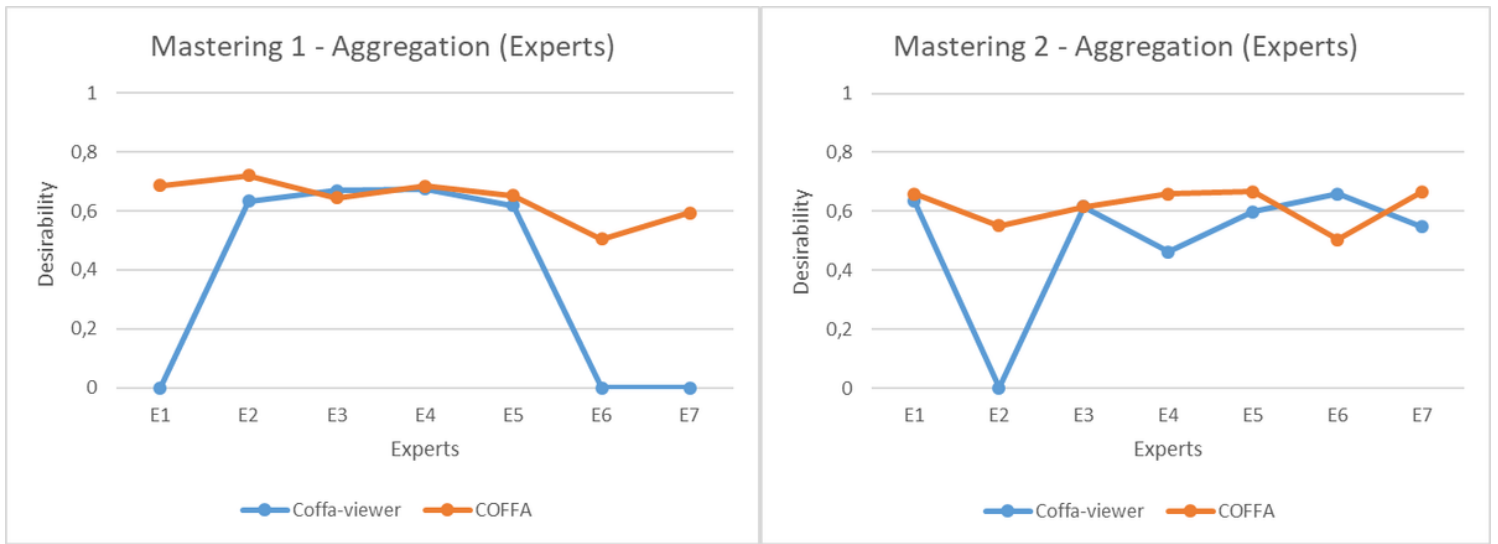

Figure 11

Aggregation of desirabilities of complex parts

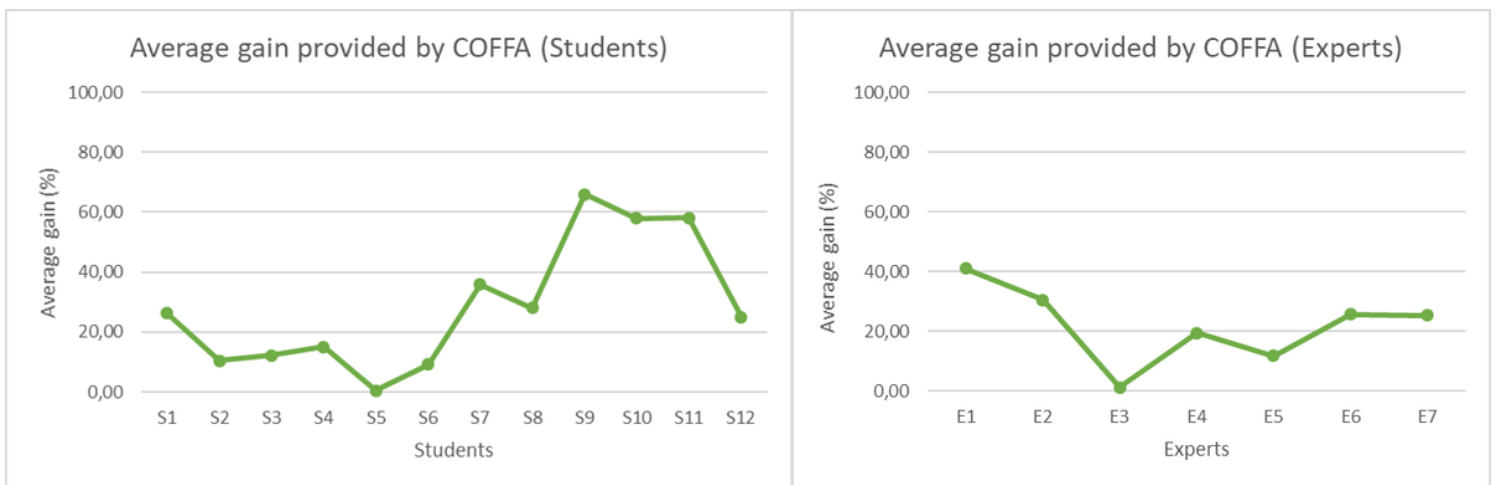

Figure 12

Average gain provided by COFFA for students and experts

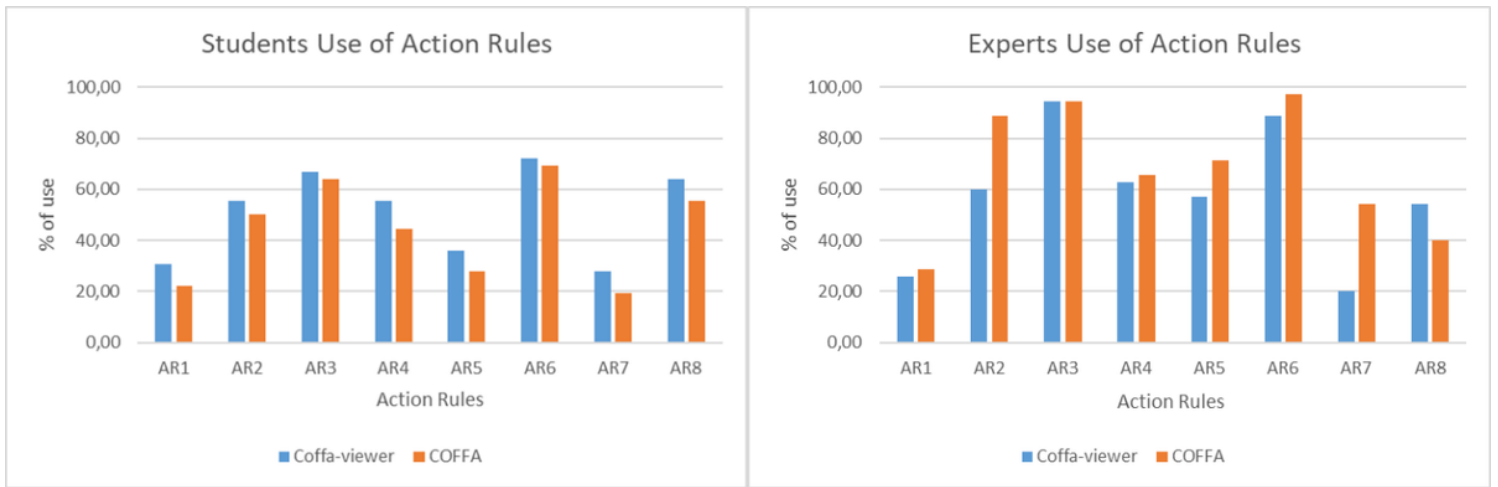
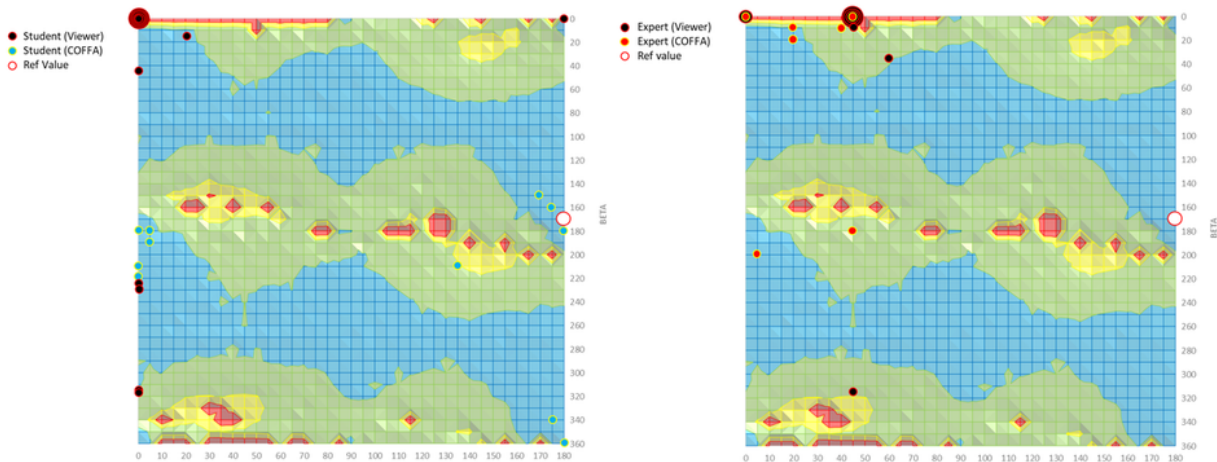

Figure 13

Use of action rules during experiment

Discovering – Case 1



Discovering – Case 2

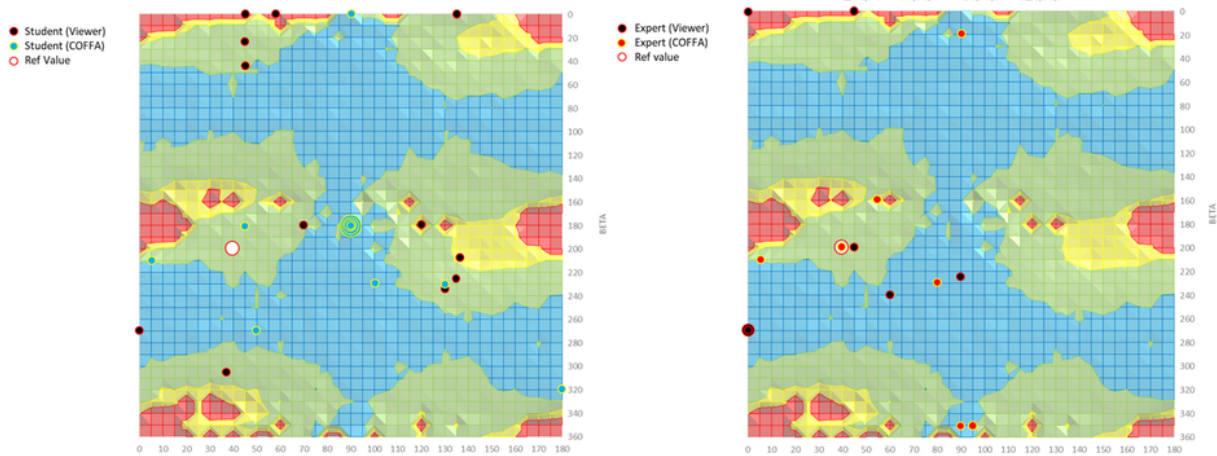

Evaluating

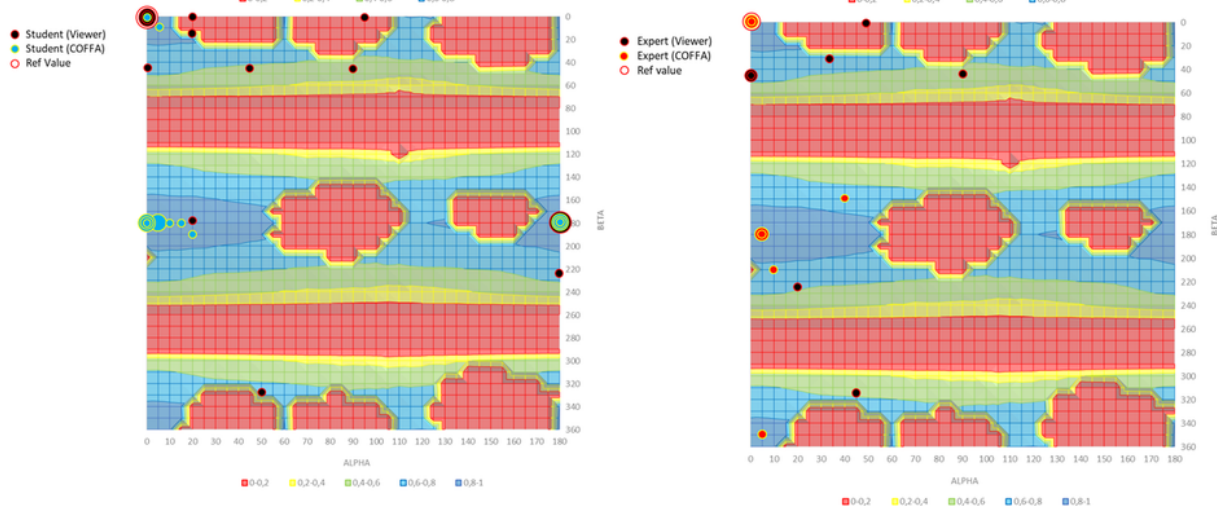

Figure 14

Choice of orientations according to the aggregation of desirabilities of common parts (students & experts)

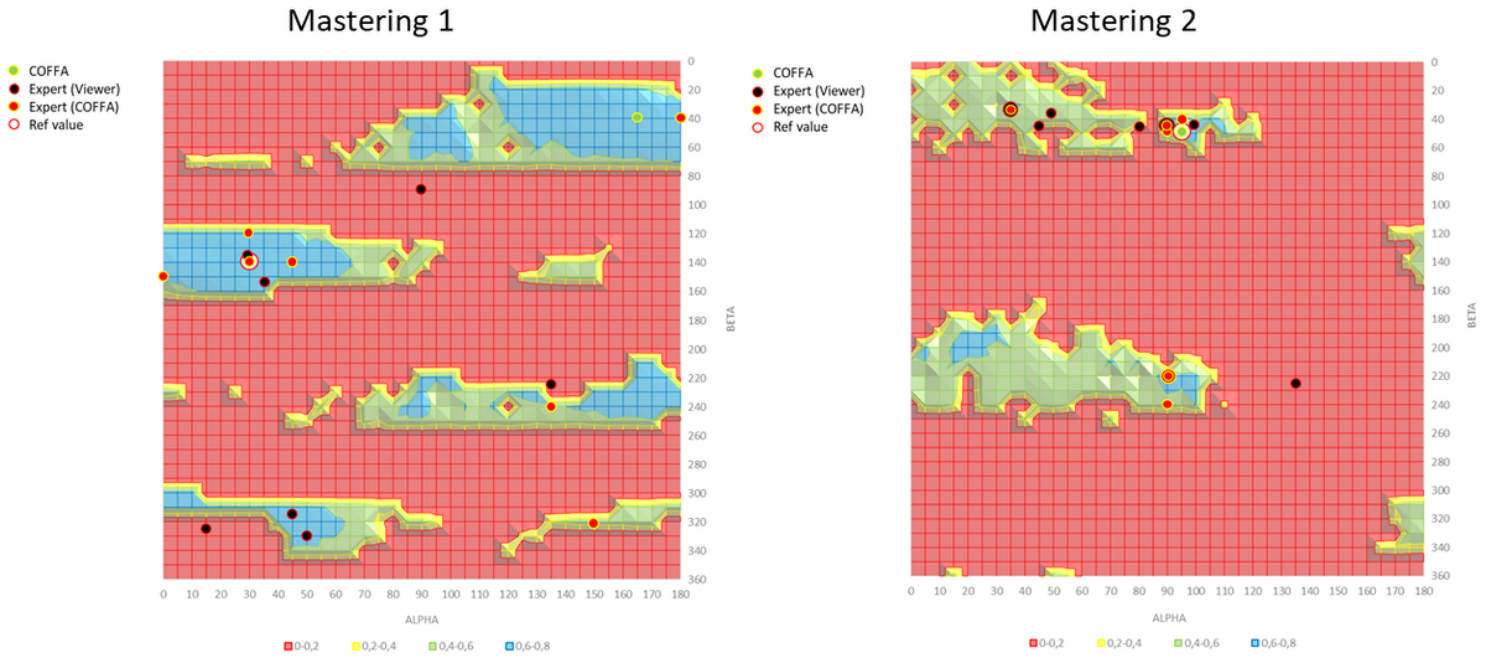

Figure 15

Choice of orientations according to the aggregation of desirabilities of mastering parts

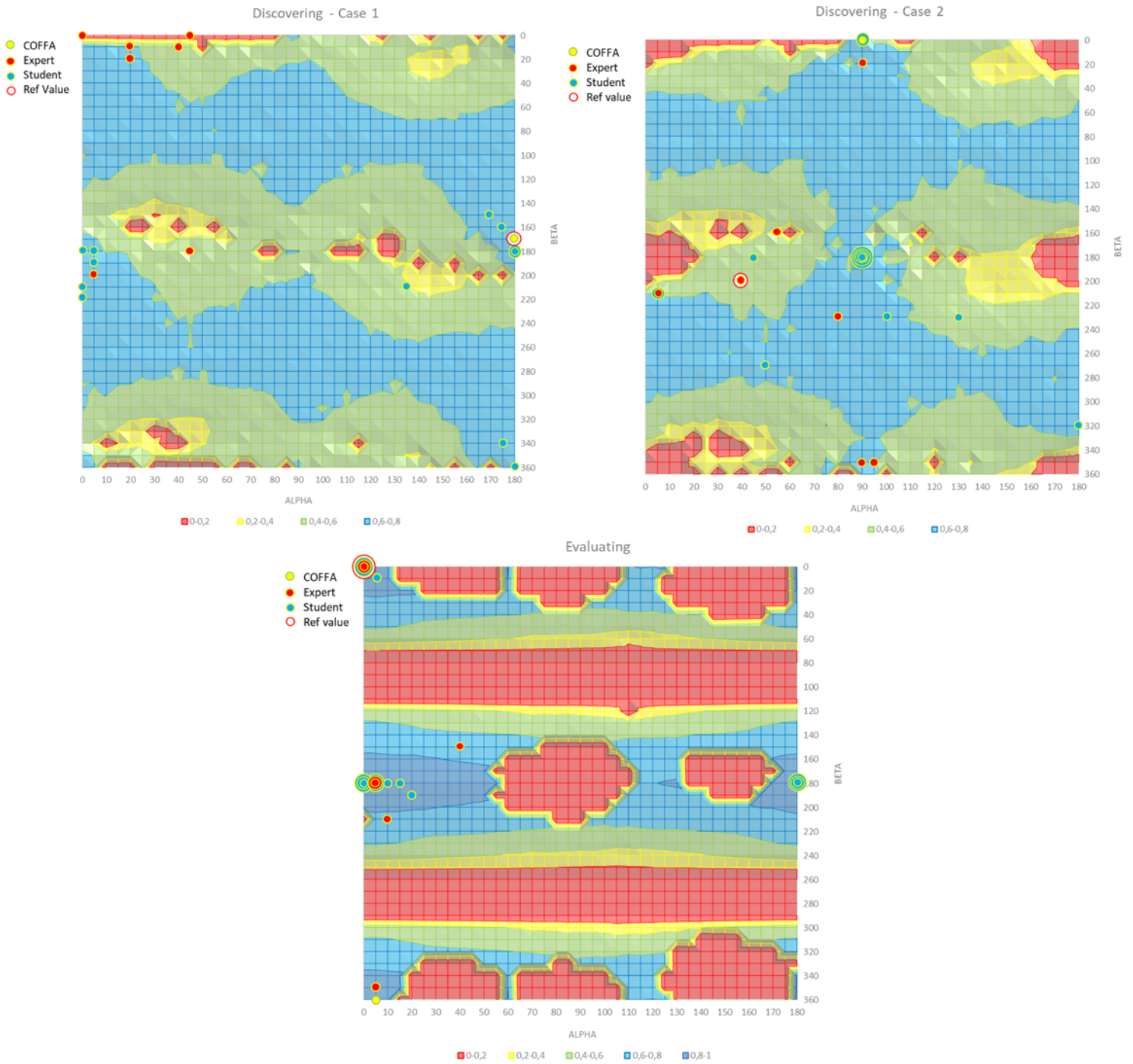

Figure 16

Choice of orientations according to the aggregation of desirabilities (students vs experts)