



**HAL**  
open science

## Thermomechanical Characterizations of Copper at Nanoscale by Laue Microdiffraction

Bassel Ayoub, Sandrine Lhostis, Stephane Moreau, Faycal Houssaini, Helene Fremont, Thomas W. Cornelius, Olivier Thomas

► **To cite this version:**

Bassel Ayoub, Sandrine Lhostis, Stephane Moreau, Faycal Houssaini, Helene Fremont, et al.. Thermomechanical Characterizations of Copper at Nanoscale by Laue Microdiffraction. Satellite European School for Young Scientists Microscopy and Materials Characterization, Oct 2022, Dresde, Germany. 2022. hal-03962892

**HAL Id: hal-03962892**

**<https://hal.science/hal-03962892v1>**

Submitted on 30 Jan 2023

**HAL** is a multi-disciplinary open access archive for the deposit and dissemination of scientific research documents, whether they are published or not. The documents may come from teaching and research institutions in France or abroad, or from public or private research centers.

L'archive ouverte pluridisciplinaire **HAL**, est destinée au dépôt et à la diffusion de documents scientifiques de niveau recherche, publiés ou non, émanant des établissements d'enseignement et de recherche français ou étrangers, des laboratoires publics ou privés.

# Thermomechanical Behaviour of Copper at Nanoscale by Laue Microdiffraction

By Bassel Ayoub<sup>1,2,3</sup>, Sandrine Lhostis<sup>1</sup>, Stéphane Moreau<sup>3</sup>, Fayçal Houssaini<sup>2</sup>, Hélène Frémont<sup>2</sup>, Thomas W. Cornelius<sup>4</sup>, Olivier Thomas<sup>4</sup>

<sup>1</sup>STMicroelectronics, <sup>2</sup>IMS Laboratory, <sup>3</sup>CEA-LETI, <sup>4</sup>IM2NP.

Email: [bassel.ayoub@st.com](mailto:bassel.ayoub@st.com)

The investigation of copper microstructure at nanoscale using synchrotron-based Laue microdiffraction technique is presented. Based on the experimental findings, FEM simulations allow to extract the plastic behaviour dependence on the orientation for the single crystals. The results obtained are used to achieve Cu/SiO<sub>2</sub> hybrid bonding with 300 nm Cu pads.

## INTRODUCTION AND PROBLEMATIC



3D Stacked Image Sensor

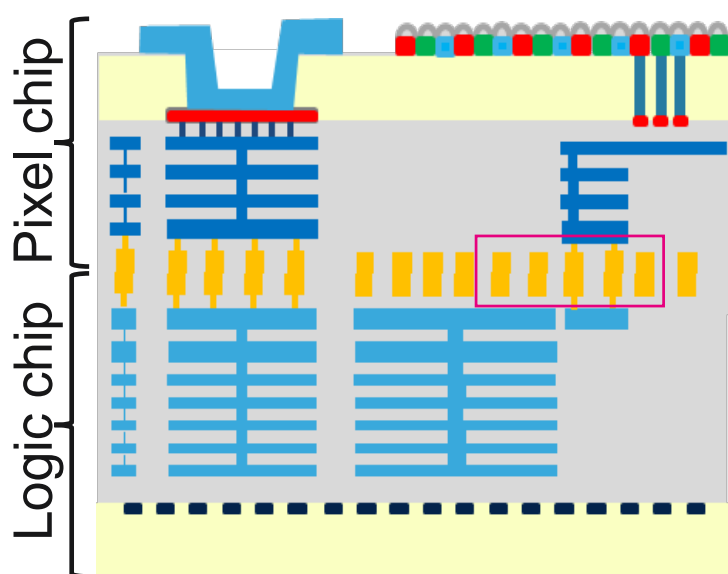
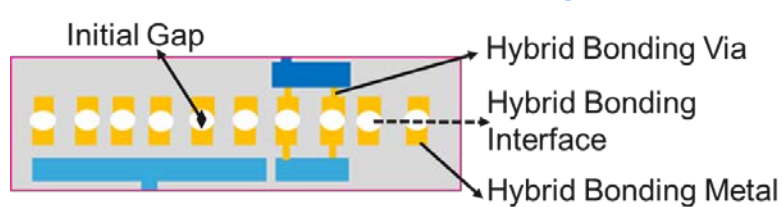
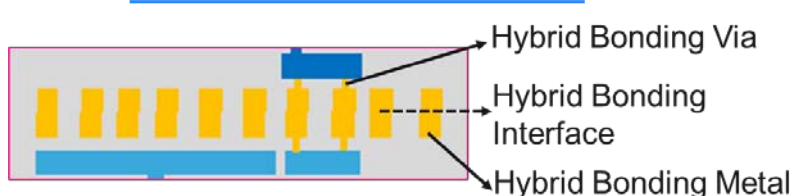

Image sensor could benefit from pad size reduction which bonding is driven by copper thermomechanical behaviour.

Post bonding: gap separating Cu-Cu due to initial Cu dishing



Post anneal at 400°C – 2h: Cu-Cu connections established



## EXPERIMENTAL SET UP

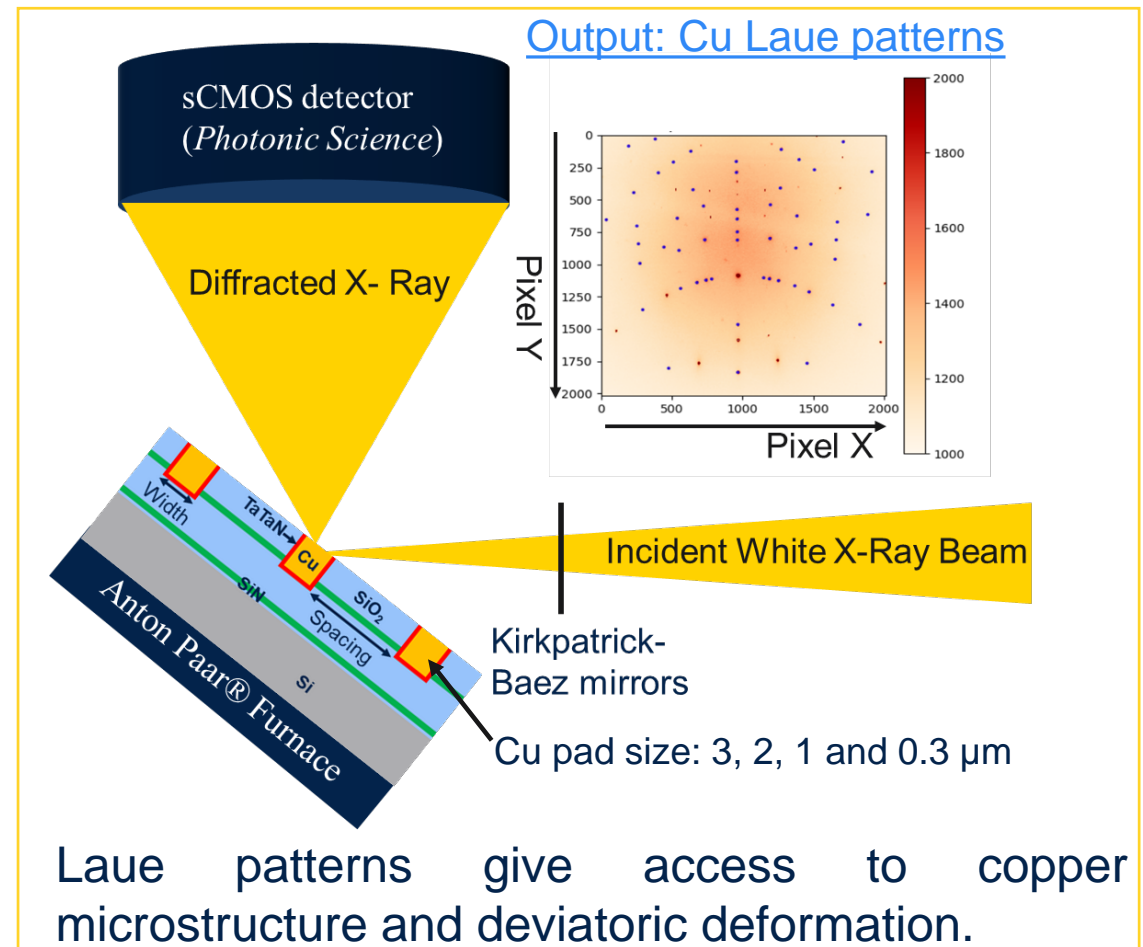

## COPPER MICROSTRUCTURE MAP

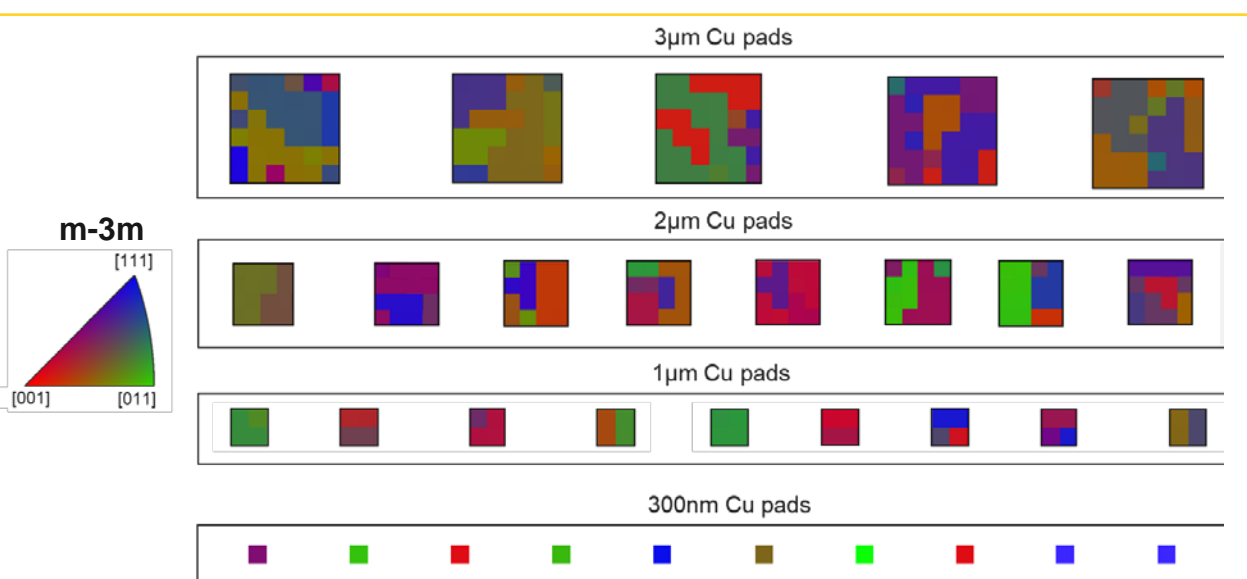

The grain size and number decrease with width reduction down to a single crystal for the 300nm Cu pad. There is no orientation evolution with temperature.

## THERMOMECHANICAL BEHAVIOUR

Grain orientation close to [001]

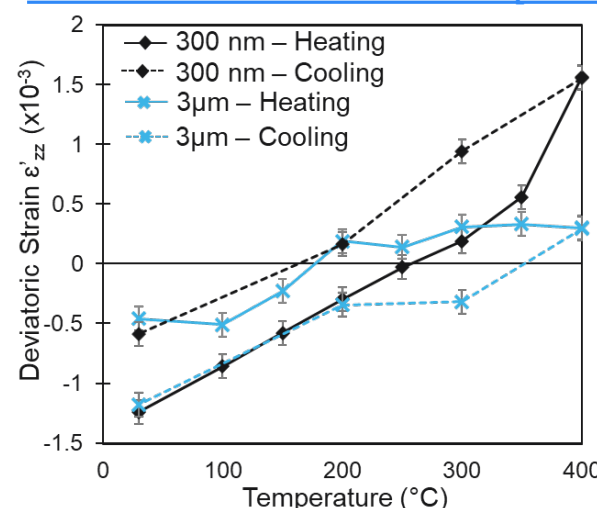

Ludwick parameters for 300nm pads

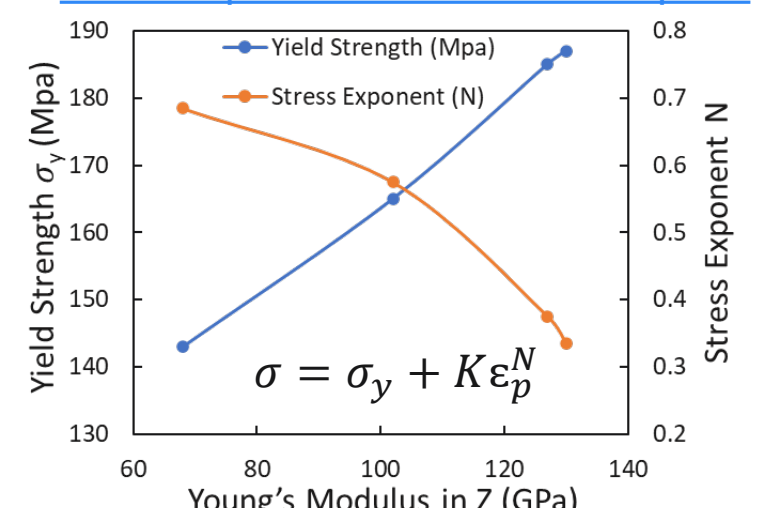

The deviatoric deformation is dependent on grain size with single crystals having higher deformation at T>350°C. By FEM, plastic behaviour of 300nm grains driven by orientation.

## METHODOLOGY VALIDATION

Bonding with 300nm Cu pads

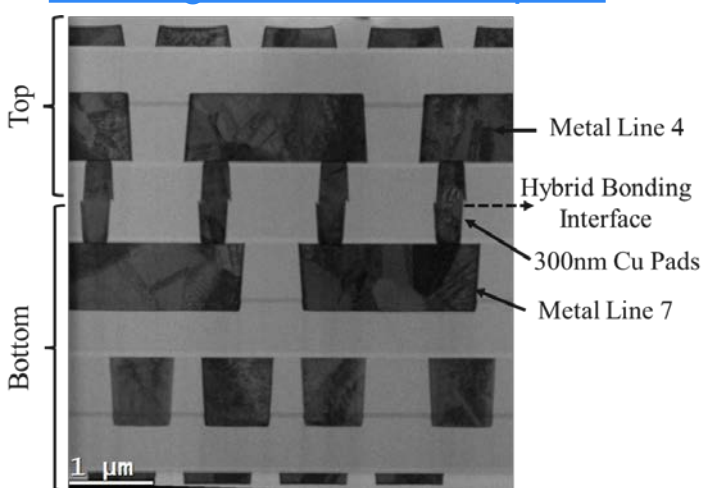

Cu-Cu electrical connections

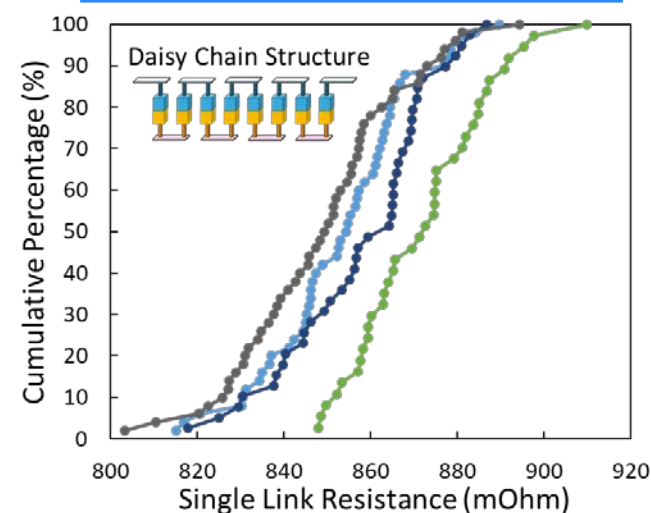

Based on Micro Laue results and FEM, successful bonding of 300nm Cu pad width was achieved by hybrid bonding with 100% yield in electrical connection within a given overlay range.

## CONCLUSION

Thermomechanical behaviour of copper with pad size reduction studied by Laue microdiffraction at ESRF (Grenoble)

- From mono (300nm pads) to polycrystalline microstructure (>1µm pads)
- Orientation is not temperature-dependent

Deviatoric deformation evolution with temperature for the 3µm and 300nm pads

- Distinct behaviour dependency on grain size and orientation
- Monocrystalline grains have higher deformation at T>350°C

Combined FEM simulations and experimental data for 300nm grains

- Total deformation extracted → used to achieve hybrid bonding with 300nm Cu pads

## ACKNOWLEDGMENTS

This work has received funding from the ECSEL Joint Undertaking (JU) under grant agreement No 826600 (project VIZTA). The JU receives support from the European Union's Horizon 2020 research and innovation program of France, Sweden, Greece, Spain, United Kingdom, Germany, Luxembourg, Latvia, Hungary. This work was also supported by the cooperative Research & Development program "IPCEI, Nano 2022 and by the French National Research Agency (ANR) under the "Investissements d'avenir" programs: ANR 10-AIRT-0005 (IRT NANO-ELEC).