



**HAL**  
open science

## Syntheses of N<sub>2</sub>-bridged heterobimetallic complexes, their structural and qualitative bonding analyses

Quentin Le Dé, Fourat Orbay, Laure Vendier, Antoine Simonneau

► **To cite this version:**

Quentin Le Dé, Fourat Orbay, Laure Vendier, Antoine Simonneau. Syntheses of N<sub>2</sub>-bridged heterobimetallic complexes, their structural and qualitative bonding analyses. *Journal of Organometallic Chemistry*, 2023, 986, pp.122604. 10.1016/j.jorganchem.2022.122604 . hal-03955433

**HAL Id: hal-03955433**

**<https://hal.science/hal-03955433v1>**

Submitted on 25 Jan 2023

**HAL** is a multi-disciplinary open access archive for the deposit and dissemination of scientific research documents, whether they are published or not. The documents may come from teaching and research institutions in France or abroad, or from public or private research centers.

L'archive ouverte pluridisciplinaire **HAL**, est destinée au dépôt et à la diffusion de documents scientifiques de niveau recherche, publiés ou non, émanant des établissements d'enseignement et de recherche français ou étrangers, des laboratoires publics ou privés.

# Syntheses of N<sub>2</sub>-bridged heterobimetallic complexes, their structural and qualitative bonding analyses

Quentin Le Dé,<sup>a</sup> Fourat Orbay,<sup>a</sup> Laure Vendier,<sup>a</sup> and Antoine Simonneau<sup>\*a</sup>

<sup>a</sup> LCC-CNRS, Université de Toulouse, CNRS, UPS, 205 route de Narbonne, BP44099, F-31077 Toulouse cedex 4, France.

antoine.simonneau@lcc-toulouse.fr

## Abstract

A series of N<sub>2</sub>-bridged ( $\mu$ - $\eta^1$ : $\eta^1$ -N<sub>2</sub>) heterobimetallic complexes were prepared by the reaction of the dinitrogen complex [Mo(depe)<sub>2</sub>(N<sub>2</sub>)<sub>2</sub>] (depe = 1,2-bis(diethylphosphino)ethane) with the group IV-VI high valent metal halides [Cp<sub>2</sub>ZrCl<sub>2</sub>], NbCl<sub>5</sub>, TaCl<sub>5</sub>, MoCl<sub>5</sub> and WCl<sub>4</sub> via chloride substitution. Compounds [MoCl(depe)<sub>2</sub>( $\mu$ -N<sub>2</sub>)ZrCp<sub>2</sub>Cl] (**1**) and [MoCl(depe)<sub>2</sub>( $\mu$ -N<sub>2</sub>)M'Cl<sub>4</sub>(THF)] (**2–5**, M' = Nb, Ta, Mo or W) were crystallized from the reaction mixtures. In the case of the reaction with WCl<sub>4</sub>, disproportionation of W(IV) was suspected but not evidenced. Single crystal X-ray diffraction analyses on all compounds allowed a systematic structural study, and the sketching of qualitative molecular orbital diagrams helped discussing the bonding situation and bolster the structural data.

**Keywords:** Dinitrogen • Heterobimetallic Complexes • Molecular Orbitals • Molybdenum

## Introduction

Coordination of dinitrogen to a transition metal center is key to render this inert small molecule reactive. This is the way Nature has elected to achieve N<sub>2</sub> reduction into ammonia in microorganisms expressing the nitrogenase enzymes.<sup>1</sup> Since the isolation of the first N<sub>2</sub> complex [Ru(NH<sub>3</sub>)<sub>5</sub>(N<sub>2</sub>)]<sup>2+</sup> by Allen and Senoff in the 1960s,<sup>2</sup> a plethora of coordination and organometallic compounds featuring a N<sub>2</sub> ligand have been described.<sup>3</sup> A wealth of coordination modes and reactivity for the dinitrogen ligand is found in those species, depending on the metal, the ligand sphere and the level of reduction of the small molecule, from dinitrogen to diazenide to hydrazide. Reduced N<sub>2</sub> complexes such as diazenido or hydrazido ones are often generated through homobimetallic activation, affording N<sub>2</sub>-bridged complexes in either end-on ( $\mu$ - $\eta^1$ : $\eta^1$ ) or side-on ( $\mu$ - $\eta^2$ : $\eta^2$ ) coordination mode, and are particularly represented among groups III–VI and the lanthanides.<sup>4</sup> Some of them have allowed the synthesis of hydrazine derivatives by subsequent treatment with electrophiles.<sup>5</sup> Heterobimetallic N<sub>2</sub> complexes remain scarce, and consequently their reactivity has not been explored,<sup>6</sup> even though methods to prepare N<sub>2</sub>-bridged heterobimetallic

complexes have been long known.<sup>7</sup> The group of Hidai has studied the reactivity of group 6 dinitrogen complexes with electrophilic metal halides and have obtained diazenido-bridged heterobimetallic complexes via halide substitution. Depending on the presence of accessible and empty d orbital on the electrophile, bent or linear M-N<sub>2</sub>-M' array were observed (Scheme 1).<sup>7f,g,i,k</sup> Contrastingly, for main-group or late metal Lewis acid adducts of dinitrogen complexes<sup>7c,f,l-q</sup> or those formed from the less electron rich *trans*-[ReCl(L)<sub>4</sub>(N<sub>2</sub>)] complexes (L = phosphine) with high-valent metal halides, as studied by the group of Chatt,<sup>7a,b,d,e</sup> reduction of the N<sub>2</sub> unit is usually not observed. Within a research line aimed at exploring the functionalization of dinitrogen within heterobimetallic complexes, we have looked at the reactivity of [Mo(depe)<sub>2</sub>(N<sub>2</sub>)<sub>2</sub>] (depe = 1,2-bis(diethylphosphino)ethane) with group IV-VI high valent metal halides. The goal was to verify whether similar reactivity to those reported by the group of Hidai could be achieved when the more electron-donating depe ligand supports the zero-valent metal and when oxidizing metal halides are employed. We document herein on the synthesis and structural characterization of a series of [Mo]-( $\mu$ -N<sub>2</sub>)-M'Cl<sub>4</sub>(THF) (M' = Nb, Ta, Mo, W) allowing for the systematic structural comparison of heterobimetallic

complexes having identical ligand spheres, plus the isolation of a group IV-VI [Mo]-( $\mu$ -N<sub>2</sub>)-ZrClCp<sub>2</sub> heterobimetallic compound.

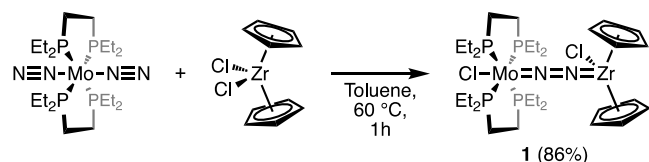

**Scheme 2.** Synthesis of the Mo-Zr heterobimetallic N<sub>2</sub> complex **1**.

When next turned our attention towards group V chloride salts. The group of Hidai also reported chloride substitution at d<sup>0</sup> group V CpMCl<sub>4</sub> (M = Nb, Ta) complexes using [W(PMe<sub>2</sub>Ph)<sub>4</sub>(N<sub>2</sub>)<sub>2</sub>] or [W(dppe)<sub>2</sub>(N<sub>2</sub>)<sub>2</sub>].<sup>7j</sup> Equimolar reactions between [Mo(depe)<sub>2</sub>(N<sub>2</sub>)<sub>2</sub>] and NbCl<sub>5</sub> or TaCl<sub>5</sub> were performed in THF, and were characterized by immediate N<sub>2</sub> evolution upon mixing solutions of the reactants. Clean formation of new species was observed after 5 min according to <sup>31</sup>P NMR monitoring. The product of the reactions of [Mo(depe)<sub>2</sub>(N<sub>2</sub>)<sub>2</sub>] with NbCl<sub>5</sub> and TaCl<sub>5</sub> were characterized by a singlet at 43.8 ppm and 43.6 ppm, respectively. After concentration under vacuum and layering with pentane, orange crystals grew over a night and could be analyzed by sc-XRD. Expectedly, the new complexes [MoCl(depe)<sub>2</sub>( $\mu$ -N<sub>2</sub>)NbCl<sub>4</sub>(THF)] (**2**) and [MoCl(depe)<sub>2</sub>( $\mu$ -N<sub>2</sub>)TaCl<sub>4</sub>(THF)] (**3**, Scheme 3) were the result of chloride substitution on NbCl<sub>5</sub> and TaCl<sub>5</sub>, respectively. Finally, the reactions between [Mo(depe)<sub>2</sub>(N<sub>2</sub>)<sub>2</sub>] and group 6 metal chlorides, MoCl<sub>5</sub> and WCl<sub>4</sub>, were performed in THF at room temperature. As in the preparation of **2** and **3**, N<sub>2</sub> evolution was noticed immediately upon mixing solutions of the reactants and after 5 min, <sup>31</sup>P-NMR analysis of an aliquot no longer showed the resonance associated to [Mo(depe)<sub>2</sub>(N<sub>2</sub>)<sub>2</sub>]. As anticipated due to the paramagnetism of MoCl<sub>5</sub>, no new signal in <sup>31</sup>P NMR could be detected. Intriguingly, the reaction with diamagnetic WCl<sub>4</sub> also led to the disappearance of the NMR signals of [Mo(depe)<sub>2</sub>(N<sub>2</sub>)<sub>2</sub>] without giving new ones. The mixtures were concentrated under vacuum and layered with pentane. Under identical crystallization conditions than for **2** and **3**, crystals suitable for sc-XRD analysis were obtained. Complex [MoCl(depe)<sub>2</sub>( $\mu$ -N<sub>2</sub>)MoCl<sub>4</sub>(THF)] (**4**, Figure 1) crystallized in the space group *P*-1. The sc-XRD analysis of the crystalline material obtained from the reaction with WCl<sub>4</sub> was unexpected, since

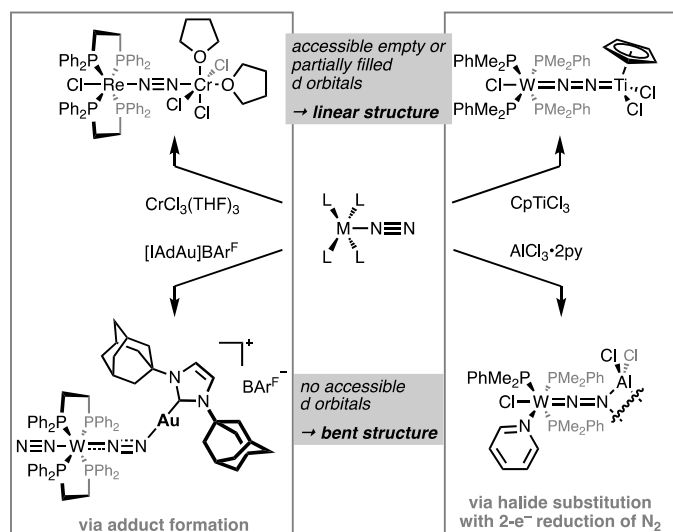

**Scheme 1.** Examples of preparation of heterobimetallic N<sub>2</sub> complexes from terminal dinitrogen complexes.<sup>7b,f,j,q</sup>

## Results

Our study commenced by treating [Mo(depe)<sub>2</sub>(N<sub>2</sub>)<sub>2</sub>] with the group IV metal complex [Cp<sub>2</sub>ZrCl<sub>2</sub>]. It was employed by the group of Hidai for the synthesis of heterobimetallic dinitrogen-bridged complexes by halide substitution with *trans*-[W(PMe<sub>2</sub>Ph)<sub>4</sub>(N<sub>2</sub>)<sub>2</sub>]<sup>7g</sup> or [W(dppe)<sub>2</sub>(NCS)(N<sub>2</sub>)][NBu<sub>4</sub>]<sup>7j</sup> (dppe = 1,2-bis(diphenylphosphino)ethane). A later report from the same research group also documents on similar chemistry employing a series of W(0) dinitrogen complexes and various analogues of [CpTiCl<sub>3</sub>],<sup>7k</sup> but none of these report mentions a productive reaction between [Mo(depe)<sub>2</sub>(N<sub>2</sub>)<sub>2</sub>] and [Cp<sub>2</sub>ZrCl<sub>2</sub>]. At room temperature in toluene, no reaction was observed according to NMR analysis. After 1 h at 60 °C, the color of the solution changed from orange to purple. In the <sup>31</sup>P-NMR spectra recorded on an aliquot, the resonance of the [Mo(depe)<sub>2</sub>(N<sub>2</sub>)<sub>2</sub>] complex (56.0 ppm) had vanished and a new signal appeared at 51.3 ppm. After concentration under vacuum and layering with pentane, purple crystals grew over a night and could be analyzed by single crystal X-Ray diffraction (sc-XRD). Complex [MoCl(depe)<sub>2</sub>( $\mu$ -N<sub>2</sub>)ZrCp<sub>2</sub>Cl] (**1**, Scheme 2), resulting from chloride substitution on [Cp<sub>2</sub>ZrCl<sub>2</sub>] by the N<sub>2</sub> ligand of [Mo(depe)<sub>2</sub>(N<sub>2</sub>)<sub>2</sub>], crystallizes in the space group *P*-1 with two molecules per asymmetric unit (Figure 1).

the analogous complex  $[\text{MoCl}(\text{depe})_2(\mu\text{-N}_2)\text{WCl}_4(\text{THF})]$  (**5**, Figure 1) was obtained.

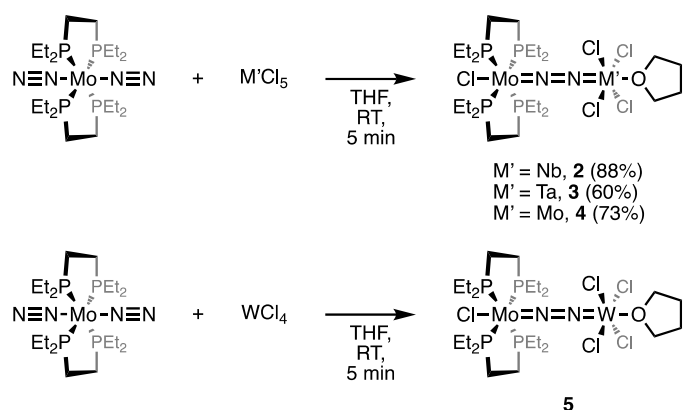

**Scheme 3.** Syntheses of the heterobimetallic complexes  $[\text{MoCl}(\text{depe})_2(\mu\text{-N}_2)\text{M}'\text{Cl}_4(\text{THF})]$  ( $M' = \text{Nb}, \text{Ta}, \text{Mo}, \text{W}$ ) **2–5**.

## Discussion

Compounds **2–5** have all been obtained in similar conditions, reactions between  $[\text{Mo}(\text{depe})_2(\text{N}_2)_2]$  and the metal halide being immediate at room temperature, as witnessed by  $\text{N}_2$  evolution right after mixing solutions of the reactants. The high Lewis acidity and unsaturation of the halide salts is likely to explain the quick reactivity with the rather electron rich  $[\text{Mo}(\text{depe})_2(\text{N}_2)_2]$  complex. The situation was different for the preparation of **1** as thermal activation was needed. This may result from Cp-induced steric hindrance in  $[\text{Cp}_2\text{ZrCl}_2]$  that may lead to a more kinetically demanding ligand interchange. The characterization by sc-XRD of the Mo(II)-W(V) heterobimetallic complex **5** from the reaction with  $\text{WCl}_4$  is somewhat surprising and points to a possible disproportionation of W(IV) to W(III) and W(V). Indeed, Cummins and co-workers have reported intermetal chlorine atom transfer between W(IV) and Ti(III), allowing for the synthesis of  $[\text{WCl}_3(\text{THF})_3]$ .<sup>8</sup> It may be possible that under our reaction conditions chlorine is transferred from  $\text{WCl}_4$  to a transient  $[\text{Mo}(\text{depe})_2(\mu\text{-N}_2)\text{WCl}_4(\text{THF})]$  adduct to afford **5** and  $[\text{WCl}_3(\text{THF})_3]$  or a related species.<sup>9</sup> Unfortunately, we were not able to evidence the presence of a reduced W species by sc-XRD by selecting other crystals of the batch, and NMR analysis on a wide spectral window did not reveal the presence of paramagnetic side-products stabilized with THF. Elemental analyses of the crystalline material were

found close to a  $5 \cdot \text{WCl}_3 \cdot 1.7 \text{ THF}$  formulation. For all complexes, the N-N stretching band of the complexes could not be unambiguously assigned in the IR spectra due to its shifting to the fingerprint region.

Pertinent bond lengths and angles for compounds **1–5** are compiled in Table 1. The five (hetero)bimetallic complexes show a molybdenum atom supported by two depe ligands within a pseudo-octahedral geometry (Figure 1). A chloride and the bridging  $\text{N}_2$  ligand are occupying the apical positions. The structural features of their coordination spheres are almost identical in all complexes. In **1**, the Zr center is found in a distorted tetrahedron. In **2–5**, the high-valent metal lies in a pseudo-octahedral environment with four chlorides in the equatorial plane and one THF molecule facing the bridging  $\text{N}_2$  ligand. The  $\text{ClMoNNM}'(\text{O})$  array slightly distorts from linearity, except in the case of **3**: all 6 atoms were found on a mirror of the  $C2/c$  space group with half occupation in the unit cell and were fixed on that mirror plane for refinement, resulting in perfect linearity. The bridging dinitrogen of the complexes have N–N bond lengths between 1.208(7) and 1.262(4) Å. These numbers are pointing to a bond order of two, although in **1**, the recorded N–N bond length is smaller than those found in representative diazene compounds (1.23–1.25 Å).<sup>10</sup> The  $\text{N}_2$  unit would act as a doubly reduced dinitrogen moiety, or diazene-diide ( $\text{N}_2^{2-}$ ), with each nitrogen acting as an LX-type ligand for each metal.<sup>11</sup> This would result in formal oxidation states of +II for the phosphine-supported molybdenum center and +IV for Zr in **1** and +V for  $M'$  in **2–5**. The  $(\text{depe})_2\text{Mo-N}$  bond lengths all approach 1.80 Å, the shortest being found in **3** (1.778(3) Å) and the longest in **1** (1.820(6) Å). The Zr–N bond in **1** is 2.009(4) Å and is comparable to the one of  $[\text{W}(\text{PMe}_2\text{Ph})_3(\text{py})(\mu\text{-N}_2)\text{ZrCp}_2\text{Cl}]^{7g}$  (1.98(1) Å, py = pyridine). The  $M'-\text{N}$  bonds in **2** and **3** are 1.834(4) and 1.822(3) Å, respectively. For comparison, these bond lengths are longer than what is typically found in group V  $[\text{M}(+\text{V})\text{Cl}_3(\text{ether})_n(\text{NR})]$  imido complexes (average of M–N bond lengths from a 13 hits list is 1.758 Å).<sup>12</sup> The same trend is observed for compounds **4** and **5** that show close  $M'-\text{N}$  distances of 1.786(5) and 1.784(3) Å, respectively. An average M–N distance calculated for a series of 11 group VI *trans*-

[M(+VI)Cl<sub>4</sub>(THF)(NR)] imido complexes is 1.722 Å.<sup>13</sup> These discrepancies may arise from the nature of the N-based ligand (X<sub>2</sub> vs. LX), the not strictly comparable ligand sphere for the group V halides,

and the difference in oxidation states considered for the group VI halides. Overall, the bond lengths of the Mo-N-N-M' array all agree with double bonding between the four atoms.<sup>11</sup>

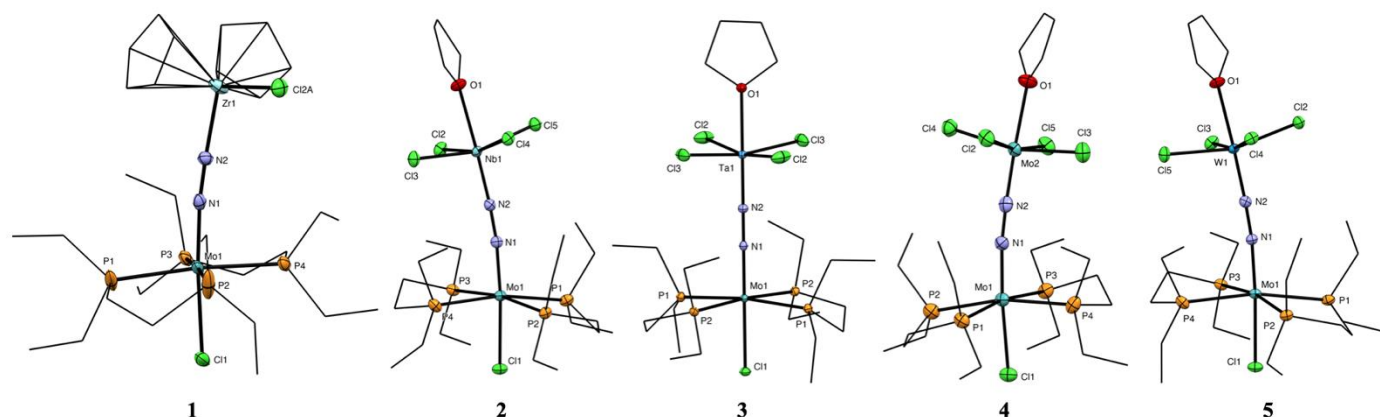

**Figure 1.** Solid-state molecular structure of compounds **1–5** determined by *sc*-XRD with ellipsoids drawn at the 30% probability level. Hydrogen atoms were omitted and hydrocarbon rings and chains are depicted as wireframes for clarity.

**Table 1.** Selected bond lengths and angles for compounds **1–5**. n. a. = not applicable.

Bond (Å) or angle (°)	1	2	3	4	5
Mo–N	1.820(6)	1.803(4)	1.778(3)	1.816(4)	1.801(3)
Mo–Cl	2.550(2)	2.478(1)	2.4779(9)	2.4517(12)	2.4708(8)
N–N	1.208(7)	1.254(5)	1.258(4)	1.257(6)	1.262(4)
M'–N	2.009(4)	1.834(4)	1.822(3)	1.786(5)	1.784(3)
M'–O	n. a.	2.307(3)	2.254(3)	2.230(4)	2.243(2)
Cl–Mo–N	174.7(2)	173.7(1)	180.0	173.77(12)	173.63(8)
Mo–N–N	173.9(5)	172.8(3)	180.0	173.0(3)	172.4(2)
N–N–M'	176.8(4)	176.6(3)	180.0	177.0(4)	177.4(2)
N–M'–O	n. a.	178.0(1)	180.0	177.91(17)	178.1(1)

The difference between complexes **2–5** is the number of d electrons of the metal opposing the Mo(II) center: the group V–group VI bimetallic complexes **2** and **3** incorporate a MCl<sub>4</sub> moiety that carries no d electrons, while in the group VI–group VI ones (**4** and **5**), the MCl<sub>4</sub> center has a d<sup>1</sup> electronic configuration. Since the N–N bond lengths are comparable in these four complexes, the single electron in **4** should be located on a non-bonding orbital centered on the more oxidized metal and not involved in antibonding orbitals of the N<sub>2</sub> unit or of the M–N linkage.

To shed light on the bonding situation, a qualitative Molecular Orbital (MO) diagram focusing on the π system of the MoNNM' core was drawn from the perturbation of a hypothetical, negatively charged C<sub>4v</sub> [MoCl(L)<sub>4</sub>(N<sub>2</sub>)]<sup>−</sup> complex by a [M'Cl<sub>4</sub>(THF)]<sup>+</sup> cation of the same symmetry (Scheme 4, right side).<sup>14</sup> The former carries 8 π electrons stemming from the filled {d<sub>xz</sub>, d<sub>yz</sub>} set and the two π bonds of N<sub>2</sub>, while the latter has either 0 (M' = Nb, Ta) or 1 (M' = Mo, W) d electron in a 1e orbital. In the cationic species, the d<sub>xy</sub>, d<sub>xz</sub> and d<sub>yz</sub> orbital were given high energy levels due to the

destabilizing effects of the chlorides, that are more pronounced for the  $b_2$  ( $d_{xy}$ ) orbital. Interaction of the frontier orbitals of the two fragments gives a new set of MOs within a heterobimetallic complex of  $C_{4v}$  symmetry, in which the single electron of the  $d^1$  cation resides, as suggested by comparison of the crystal structures of **2–5**, in a non-bonding,  $M'$ -centered  $d$  orbital. A set of two degenerate MOs that are antibonding regarding the N–N linkage are further stabilized than in  $[MoCl(L)_4(N_2)]^-$ , giving it more  $N_2$  character. Since they are populated, a high level of activation of  $N_2$  (i. e., N–N bond elongation) results. Based on the metrical data issued from sc-XRD analyses and by comparison with computed covalent radii,<sup>11</sup> an  $Mo=N=N=M'$  depiction for complexes **2–5** makes sense, as mentioned above. However, the drawing of accurate Lewis structures for  $N_2$ -bridged

bimetallic complexes has recently been discussed by Hasanayn, Holland, Goldman and Miller,<sup>15</sup> arguing that comparison of N–N bond lengths with either  $N_2$ , diazene or hydrazine is not always valid. According to their model, compounds **2–5** would better correspond to a  $Mo^+(IV)\equiv N-N\equiv M'^-(V)$  depiction, with a positive charge on Mo and a negative one on  $M'$  and the  $N_2$  unit acting as a two-fold  $LX_2$  ligand. The former would have 18 valence electrons (VE) and the latter, depending whether it is a group V or VI metal, 16 or 17 VE, respectively, to be compared with 18 VE for Mo and 14 or 15 VE for  $M'$  in a  $Mo(II)=N=N=M'(V)$  bonding situation (Chart 1). The former depiction better distributes valence electron to the metals and takes into account the electron-withdrawing nature of the  $M'Cl_4(THF)$  fragment.

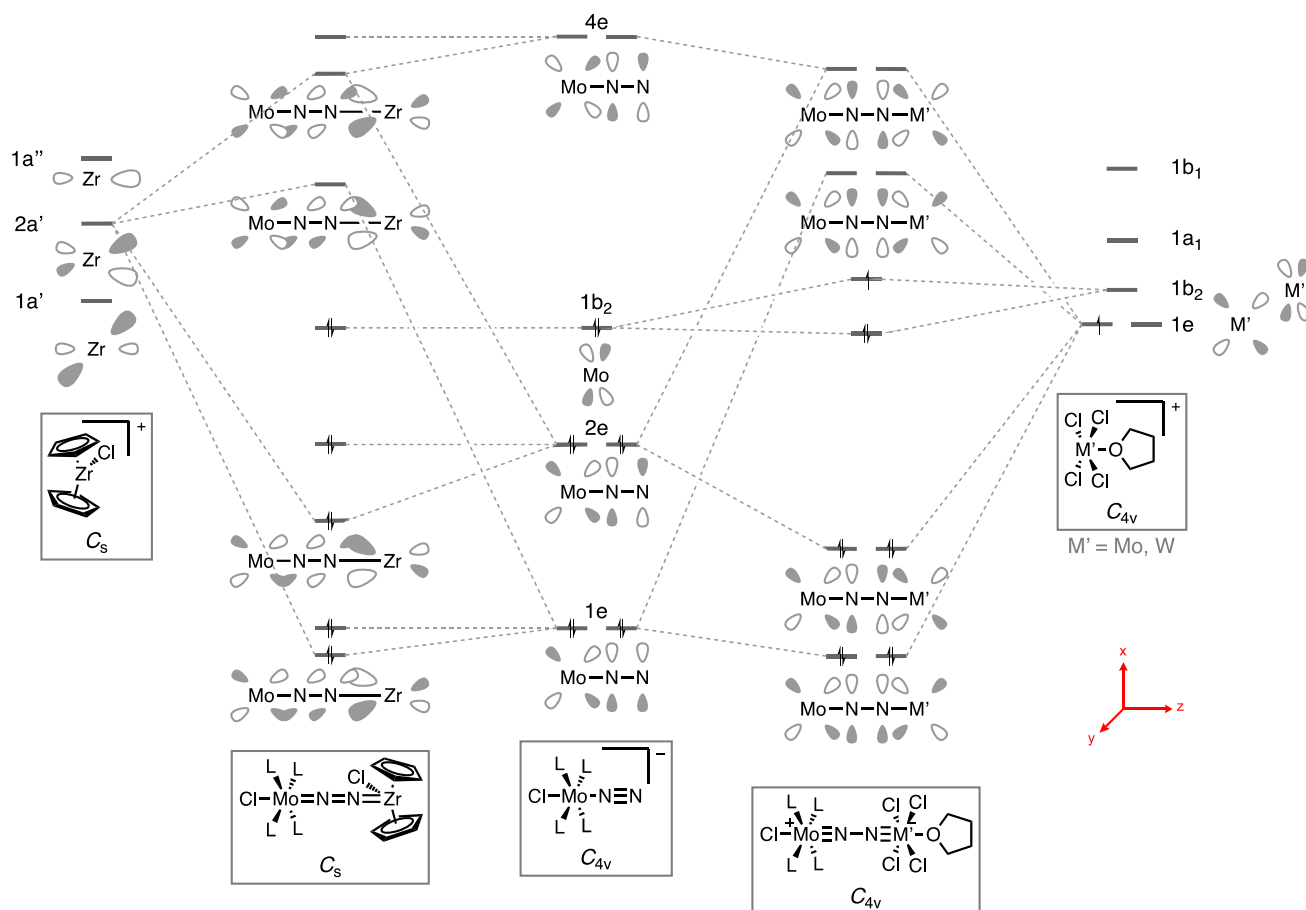

**Scheme 4.** Qualitative MO diagrams for compounds **1**, **4** and **5** obtained by perturbation of  $[MoCl(L)_4(N_2)]^-$  with group IV–VI cations.

Complex **1** has a N–N bond length shorter than the four other complexes (1.207(6) or 1.230(7) Å vs 1.254–1.262 Å). N–N bond lengths are 1.207(6) and 1.230(7) Å, slightly shorter than a N–N double bond (1.25 Å). Zr–N bond lengths are 2.009(4) and

1.991(5) Å long and Mo–N bonds measure 1.821(5) and 1.806(4) Å. Mo–N–N and N–N–Zr angles are 173.96 and 173.35°, respectively. The solid state structure of **1** is very similar to the one of the  $N_2$ -bridged heterobimetallic complex

[WI(PMe<sub>2</sub>Ph)<sub>3</sub>(py)(μ-N<sub>2</sub>)ZrCp<sub>2</sub>Cl], reported by Hidai and co-workers<sup>7g</sup> (N–N and Zr–N bond lengths: 1.24(2) and 1.98(1) Å, respectively). In **1**, the zirconium center has a formal oxidation state of +IV and, like the Ta and Nb ions in complexes **2** and **3**, has a d<sup>0</sup> electronic configuration. We drew the MO diagram of **1** by the perturbation of the d<sup>6</sup> complex [MoCl(L)<sub>4</sub>(N<sub>2</sub>)]<sup>−</sup> with the [Cp<sub>2</sub>ZrCl]<sup>+</sup> cation of C<sub>s</sub> symmetry to see whether it could provide an explanation for a shorter N–N bond (Scheme 4, left side). The frontier MOs of the latter have been calculated by Lauher and Hoffmann, and we considered here, to match with the orientation of [MoCl(L)<sub>4</sub>(N<sub>2</sub>)]<sup>−</sup>, that the Zr–Cl bond is along the y axis.<sup>16</sup> Only the 2a' MO of [Cp<sub>2</sub>ZrCl]<sup>+</sup> can interact with the π system of [MoCl(L)<sub>4</sub>(N<sub>2</sub>)]<sup>−</sup>, resulting in the stabilization of only the half of the MOs that are antibonding with respect to the N–N bond. This may explain why the level of activation in **1** is inferior to those in **2–5**. The MO diagram for **1** would support, according to the model of Miller and colleagues,<sup>15</sup> a Mo(IV)=N=N=Zr(IV) depiction. A Mo<sup>+</sup>(IV)≡N–N≡Zr<sup>−</sup>(IV) bonding situation similar to the one encountered in **2–5**, where the electron-withdrawing nature of the chloride ligands is helping the stabilization of the negative charge on M', would be counter-intuitive in the case of **1**, the valence electron count for Zr being 20 (Chart 1). The fact that the negative charge would be carried by the more electropositive metal, the scarcity of 20-electron zirconocene complexes<sup>17</sup> as well as the relatively short N–N bond are additional arguments that rule out a hydrazine tetraide (N<sub>2</sub><sup>4−</sup>) ligand in **1**.

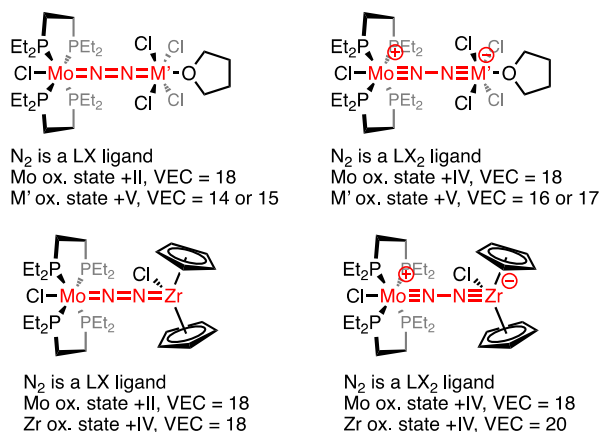

**Chart 1.** Comparison of bonding situations for the Mo–N–M' core of the heterobimetallic complexes in terms of oxidation states and valence electron count (VEC).

## Conclusion

We have prepared new N<sub>2</sub>-bridged heterobimetallic complexes, obtained by the reaction of [Mo(depe)<sub>2</sub>(N<sub>2</sub>)<sub>2</sub>] with various group IV–VI halide complexes. Compound [MoCl(depe)<sub>2</sub>(μ-N<sub>2</sub>)ZrCp<sub>2</sub>Cl] (**1**) and a series of analogous [MoCl(depe)<sub>2</sub>(μ-N<sub>2</sub>)M'Cl<sub>4</sub>(THF)] (**2–5**, M' = Nb, Ta, Mo, W) complexes could be structurally characterized. Sketching of the qualitative molecular orbital diagrams helped understand the bonding situation as well as structural similarities or differences. In light of a recent discussion on qualitative analysis of the bonding in bimetallic N<sub>2</sub> complexes by Miller and colleagues,<sup>15</sup> we have applied their model on the compounds reported herein: if a hydrazine tetraide (N<sub>2</sub><sup>4−</sup>) ligand can be supported for the **2–5** family, a Mo=N=N=Zr depiction (with a diazene-diide ligand) seems more appropriate for **1**.

## Materials and methods

### 1. General information

All reactions were performed in oven-dried glassware with rigorous exclusion of air and moisture, using a nitrogen filled *Jacomex* glove box (O<sub>2</sub> < 2 ppm, H<sub>2</sub>O < 1 ppm) equipped with a vacuum line. Solvent used were pre-dried (toluene, tetrahydrofuran and pentane by passing through a Puresolv MD 7 solvent purification machine) degassed by freeze-pump-thaw cycles, dried over molecular sieves and stored in the glove box. THF-*d*<sub>8</sub> (purchased from *Eurisotop*) was degassed by freeze-pump-thaw cycles, dried over molecular sieves and stored in the glove box. MoCl<sub>5</sub>, NbCl<sub>5</sub>, TaCl<sub>5</sub> and [Cp<sub>2</sub>ZrCl<sub>2</sub>] have been purchased from *Strem*, the latter one was recrystallized from dichloromethane. WCl<sub>4</sub> has been purchased from *Sigma-Aldrich*. *trans*-[Mo(depe)<sub>2</sub>(N<sub>2</sub>)<sub>2</sub>] has been prepared from MoCl<sub>5</sub>.<sup>18</sup> <sup>1</sup>H, <sup>13</sup>C and <sup>31</sup>P NMR spectra were recorded in THF-*d*<sub>8</sub> by using NMR tubes equipped with J. Young valves on a Bruker Avance III 400 spectrometer. Chemical shifts are in parts per million (ppm) downfield from tetramethylsilane and are referenced to the residual solvent resonances as the internal standard (C<sub>4</sub>H<sub>7</sub>D<sub>7</sub>O: δ reported = 3.58 and 1.72 ppm for <sup>1</sup>H NMR). <sup>13</sup>C and <sup>31</sup>P NMR spectra were calibrated according to the IUPAC

recommendation using a unified chemical shift scale based on the proton resonance of tetramethylsilane as primary reference.<sup>19</sup> Data are reported as follows: chemical shift, multiplicity (s = singlet, t = triplet, q = quartet, quint. = quintet, m = multiplet) and integration. Infrared (IR) spectra were recorded in a nitrogen filled Jacomex glove box ( $O_2 < 2$  ppm,  $H_2O < 1$  ppm) on an *Agilent Cary 630 FT-IR* spectrophotometer equipped with ATR and are reported in wavenumbers ( $cm^{-1}$ ). Elemental analyses were performed on samples sealed in tin capsules under  $N_2$  by Analytical Service of the Laboratoire de Chimie de Coordination; results are the average of two independent measurements.

## 2. Characterization

### Synthesis of $[MoCl(depe)_2(\mu-N_2)ZrCp_2Cl]$ (1)

$[Mo(depe)_2(N_2)_2]$  (20.0 mg, 35.4  $\mu$ mol, 1 equiv.) was dissolved in 2 mL of toluene. A toluene solution (2 mL) of  $[Cp_2ZrCl_2]$  (10.2 mg, 35.4  $\mu$ mol, 1 equiv.) was added to the first solution. The mixture was then stirred and warmed to 60 °C during 1 h, time during which the solution became purple. The mixture was concentrated under vacuum to ca. 2 mL and pentane (4 mL) was added. After a night at -40 °C, crystals of (1) were separated from the supernatant and washed with pentane. After drying under vacuum, complex 1 was obtained as purple crystals (25.2 mg, 30.4  $\mu$ mol, 86%).

<sup>1</sup>H-NMR (400 MHz, THF-*d*<sub>8</sub>)  $\delta$  6.01 (s, 10H, Cp), 2.01 (m, 8H), 1.92 (m, 8H), 1.79 (m, 8H), 1.23 (t, 12H), 1.14 (t, 12H). <sup>13</sup>C-NMR (100.6 MHz, THF-*d*<sub>8</sub>)  $\delta$  110.8 (s), 21.7 (quint.), 18.5 (quint.), 17.9 (quint.), 8.1 (s), 7.5 (s). <sup>31</sup>P-NMR (162 MHz, THF-*d*<sub>8</sub>)  $\delta$  51.3 (s).

**Elem. Anal.** Calcd. for  $C_{30}H_{58}Cl_2MoN_2P_4Zr$ : C 43.48; H 7.05; N 3.38. Found: C 42.77; H 6.76; N 2.65.

**IR** (ATR)  $\nu$  = 2931, 2896, 2875, 1543, 1457, 1407, 1305, 1232, 1182, 1118, 981, 863, 786, 730.

### Synthesis of $[MoCl(depe)_2(\mu-N_2)NbCl_4(THF)]$ (2)

$[Mo(depe)_2(N_2)_2]$  (30.0 mg, 53.2  $\mu$ mol, 1 equiv.) was dissolved in 3 mL of THF. A THF solution (3 mL) of  $NbCl_5$  (14.4 mg, 53.2  $\mu$ mol, 1 equiv.) was added to the first solution, and bubbling was immediately

observed. The mixture was stirred for 5 min at room temperature, then concentrated under vacuum to ca. 3 mL. The resulting THF solution was then layered with 4 mL of pentane. After a night at room temperature, crystals of (2) were separated from the supernatant and washed with pentane. After drying under vacuum, complex 2 was obtained as orange crystals (41 mg, 46.7  $\mu$ mol, 88 %).

<sup>1</sup>H-NMR (400 MHz, THF-*d*<sub>8</sub>)  $\delta$  2.20 (m, 8H), 2.01 (m, 16H), 1.31 (t, 12H), 1.22 (t, 12H). <sup>13</sup>C-NMR (100.6 MHz, THF-*d*<sub>8</sub>)  $\delta$  21.7 (quint.), 20.5 (quint.), 18.1 (quint.), 8.5 (s), 7.4 (s). <sup>31</sup>P-NMR (162 MHz, THF-*d*<sub>8</sub>)  $\delta$  43.8 (s).

**Elem. Anal.** Calcd. for  $C_{24}H_{55}Cl_5MoN_2OP_4Nb$ : C 32.80; H 6.42; N 3.19. Found: C 32.52; H 6.56; N 2.43.

**IR** (ATR)  $\nu$  = 2935, 2874, 1456, 1410, 1352, 1243, 1111, 1031, 869, 837, 817, 759, 734, 673.

### Synthesis of $[MoCl(depe)_2(\mu-N_2)TaCl_4(THF)]$ (3)

$[Mo(depe)_2(N_2)_2]$  (30.0 mg, 53.2  $\mu$ mol, 1 equiv.) was dissolved in 3 mL of THF. A THF solution (3 mL) of  $TaCl_5$  (19.1 mg, 53.2  $\mu$ mol, 1 equiv.) was added to the first solution, and bubbling was immediately observed. The mixture was stirred for 5 min at room temperature, then concentrated under vacuum to ca. 3 mL. The resulting THF solution was then layered with 4 mL of pentane. After a night at room temperature, crystals of (3) were separated from the supernatant and washed with pentane. After drying under vacuum, complex 3 was obtained as orange crystals (30.8 mg, 31.9  $\mu$ mol, 60 %).

<sup>1</sup>H-NMR (400 MHz, THF-*d*<sub>8</sub>)  $\delta$  2.16 (q, 8H), 1.94 (m, 16H), 1.29 (t, 12H), 1.21 (t, 12H). <sup>13</sup>C-NMR (100.6 MHz, THF-*d*<sub>8</sub>)  $\delta$  21.1 (quint.), 20.0 (quint.), 17.7 (quint.), 8.1 (s), 7.0 (s). <sup>31</sup>P-NMR (162 MHz, THF-*d*<sub>8</sub>)  $\delta$  43.6 (s).

**Elem. Anal.** Calcd. for  $C_{24}H_{55}Cl_5MoN_2OP_4Ta$ : C 29.85; H 5.74; N 2.90. Found: C 30.07; H 5.66; N 2.40.

**IR** (ATR)  $\nu$  = 2969, 2937, 2907, 1879, 1602, 1577, 1495, 1480, 1454, 1409, 1379, 1252, 1129, 1082, 1029, 1003, 982, 946, 896, 867, 842, 813, 785, 729, 695.

### Synthesis of $[MoCl(depe)_2(\mu-N_2)MoCl_4(THF)]$ (4)



[Mo(depe)<sub>2</sub>(N<sub>2</sub>)<sub>2</sub>] (30.0 mg, 53.2 μmol, 1 equiv.) was dissolved in 3 mL of THF. A THF solution (3 mL) of MoCl<sub>5</sub> (14.5 mg, 53.2 μmol, 1 equiv.) was added to the first solution, and bubbling was immediately observed. The mixture was stirred for 5 min at room temperature, then concentrated under vacuum to ca. 3 mL. The resulting THF solution was then layered with 4 mL of pentane. After a night at room temperature, crystals of (**4**) were separated from the supernatant and washed with pentane. After drying under vacuum, complex **4** was obtained as orange crystals (34.2 mg, 38.8 μmol, 73 %).

**Elem. Anal.** Calcd. for C<sub>24</sub>H<sub>55</sub>Cl<sub>5</sub>Mo<sub>2</sub>N<sub>2</sub>OP<sub>4</sub>: C 32.73; H 6.29; N 3.18. Found C 33.12; H 5.96; N 2.92

**IR** (ATR)  $\nu$  = 2935, 1875, 1456, 1411, 1376, 1306, 1233, 1183, 1119, 1030, 980, 917, 867, 829, 815, 739.

### Synthesis of [MoCl(depe)<sub>2</sub>(μ-N<sub>2</sub>)WCl<sub>4</sub>(THF)] (**5**)

[Mo(depe)<sub>2</sub>(N<sub>2</sub>)<sub>2</sub>] (30.0 mg, 53.2 μmol, 1 equiv.) was dissolved in 3 mL of THF. A THF solution (3 mL) of WCl<sub>4</sub> (17.3 mg, 53.2 μmol, 1 equiv.) was added to the first solution, and bubbling was immediately observed. The mixture was stirred for 5 min at room temperature, then concentrated under vacuum to ca. 3 mL. The resulting THF solution was then layered with 4 mL of pentane. After a night at room temperature, orange crystals were separated from the supernatant and washed with pentane. After drying under vacuum, the crystalline solid weighed 34.2 mg. sc-XRD analysis revealed a W(+V) complex that could not be obtained quantitatively with the applied stoichiometry.

**Elem. Anal.** Calcd. for C<sub>24</sub>H<sub>55</sub>Cl<sub>5</sub>MoN<sub>2</sub>OP<sub>4</sub>W·WCl<sub>3</sub>·1.7(C<sub>4</sub>H<sub>8</sub>O): C 26.76; H 5.03; N 2.03. Found C 26.82; H 4.33; N 1.28.

**IR** (ATR)  $\nu$  = 2960, 2933, 2905, 2876, 1894, 1757, 1649, 1454, 1409, 1378, 1308, 1230, 1182, 1121, 1027, 980, 863, 813, 786, 746, 718.

### Acknowledgements

A.S. and Q. L. D. acknowledges the European Research Council (ERC) for funding (Grant Agreement 757501). All authors are indebted to the French National Center for Scientific Research (CNRS) for financial support.

### Declaration of Interests

The authors declare that they have no known competing financial interests or personal relationships that could have appeared to influence the work reported in this paper.

### References

- (1) a) Hoffman, B. M.; Lukoyanov, D.; Yang, Z.-Y.; Dean, D. R.; Seefeldt, L. C. Mechanism of Nitrogen Fixation by Nitrogenase: The Next Stage. *Chem. Rev.* **2014**, *114*, 4041–4062; b) Seefeldt, L. C.; Yang, Z.-Y.; Lukoyanov, D. A.; Harris, D. F.; Dean, D. R.; Raugei, S.; Hoffman, B. M. Reduction of Substrates by Nitrogenases. *Chem. Rev.* **2020**, *120*, 5082–5106.
- (2) Allen, A. D.; Senoff, C. V. Nitrogenopentammineruthenium(II) Complexes. *Chem. Commun.* **1965**, No. 24, 621–622.
- (3) a) *Transition Metal-Dinitrogen Complexes: Preparation and Reactivity*; Nishibayashi, Y., Ed.; Wiley-VCH Verlag GmbH & Co. KGaA: Weinheim, Germany, 2019; b) Walter, M. D. Recent Advances in Transition Metal-Catalyzed Dinitrogen Activation. In *Advances in Organometallic Chemistry*; Pérez, P. J., Ed.; Academic Press, 2016; Vol. 65, pp 261–377.
- (4) a) Turner, Z. R. Molecular Pnictogen Activation by Rare Earth and Actinide Complexes. *Inorganics* **2015**, *3*, 597–635; b) Gambarotta, S.; Scott, J. Multimetallic Cooperative Activation of N<sub>2</sub>. *Angew. Chem. Int. Ed.* **2004**, *43*, 5298–5308.
- (5) a) Bernskoetter, W. H.; Lohkovsky, E.; Chirik, P. J. Nitrogen-Carbon Bond Formation from N<sub>2</sub> and CO<sub>2</sub> Promoted by a Hafnocene Dinitrogen Complex Yields a Substituted Hydrazine. *Angew. Chem. Int. Ed.* **2007**, *46*, 2858–2861; b) Knobloch, D. J.; Toomey, H. E.; Chirik, P. J. Carboxylation of an Ansa-Zirconocene Dinitrogen Complex: Regiospecific Hydrazine Synthesis from N<sub>2</sub> and CO<sub>2</sub>. *J. Am. Chem. Soc.* **2008**, *130*, 4248–4249; c) Knobloch, D. J.; Benito-Garagorri, D.; Bernskoetter, W. H.; Keresztes, I.; Lobkovsky, E.; Toomey, H.; Chirik, P. J. Addition of Methyl Triflate to a Hafnocene Dinitrogen Complex: Stepwise N<sub>2</sub> Methylation and Conversion to a Hafnocene Hydrazonato Compound. *J. Am. Chem. Soc.* **2009**, *131*, 14903–14912; d) Nakanishi, Y.; Ishida, Y.; Kawaguchi, H. Nitrogen-Carbon Bond Formation by Reactions of a Titanium-Potassium Dinitrogen Complex with Carbon Dioxide, Tert-Butyl Isocyanate, and Phenylallene. *Angew. Chem. Int. Ed.* **2017**, *56*, 9193–9197; e) Lv, Z.-J.; Huang, Z.; Zhang, W.-X.; Xi, Z. Scandium-Promoted Direct Conversion of Dinitrogen into Hydrazine Derivatives via N–C Bond Formation. *J. Am. Chem. Soc.* **2019**, *141*, 8773–8777.
- (6) Some heterobimetallic N<sub>2</sub> complexes have been explored in the dinitrogen splitting context, see: a) Mindiola, D. J.; Meyer, K.; Cherry, J.-P. F.; Baker, T. A.; Cummins, C. C. Dinitrogen Cleavage Stemming from a Heterodinuclear Niobium/Molybdenum N<sub>2</sub> Complex: New Nitridoniobium Systems Including a Niobazene Cyclic Trimer. *Organometallics* **2000**, *19*, 1622–1624; b) Seymore, S. B.; Brown, S. N. Kinetic

- Effects in Heterometallic Dinitrogen Cleavage. *Inorg. Chem.* **2006**, *45*, 9540–9550; c) Xin, X.; Douair, I.; Zhao, Y.; Wang, S.; Maron, L.; Zhu, C. Dinitrogen Cleavage by a Heterometallic Cluster Featuring Multiple Uranium–Rhodium Bonds. *J. Am. Chem. Soc.* **2020**, *142*, 15004–15011.
- (7) a) Chatt, J.; Dilworth, J. R.; Richards, R. L.; Sanders, J. R. Chemical Evidence Concerning the Function of Molybdenum in Nitrogenase. *Nature* **1969**, *224*, 1201–1202; b) Chatt, J.; Fay, R. C.; Richards, R. L. Preparation and Characterisation of the Dinuclear Dinitrogen Complex, Trichloro- $\mu$ -Dinitrogen-Bis(Tetrahydrofuran){chlorotetrakis[Dimethyl-(Phenyl)Phosphine]Rhenium(I)}chromium(III)[(PMe<sub>2</sub>Ph)<sub>4</sub>ClReN<sub>2</sub>CrCl<sub>3</sub>(THF)<sub>2</sub>]. *J. Chem. Soc. Inorg. Phys. Theor.* **1971**, 702–704; c) Chatt, J.; Crabtree, R. H.; Jeffery, E. A.; Richards, R. L. The Basic Strengths of Some Dinitrogen Complexes of Molybdenum(0), Tungsten(0), Rhenium(I), and Osmium(II). *J. Chem. Soc. Dalton Trans.* **1973**, No. 11, 1167–1172; d) Cradwick, P. D.; Chatt, J.; Crabtree, R. H.; Richards, R. L. Preparation and X-Ray Structure of a Trinuclear Dinitrogen-Bridged Complex, *trans*-[MoCl<sub>4</sub>{(N<sub>2</sub>)ReCl(PMe<sub>2</sub>Ph)<sub>4</sub>}<sub>2</sub>]. *J. Chem. Soc. Chem. Commun.* **1975**, No. 9, 351–352; e) Cradwick, P. D. Crystal Structure of a Trinuclear Dinitrogen-Bridged Complex: Di- $\mu$ -Di-Nitrogen-Tetrachlorobis[Chlorotetrakis(Dimethylphenylphosphine)Rhenio]Molybdenum–Dichloromethane (1/1). *J. Chem. Soc. Dalton Trans.* **1976**, No. 19, 1934–1936; f) Takahashi, T.; Kodama, T.; Watakabe, A.; Uchida, Y.; Hidai, M. Preparation and Properties of Molybdenum and Tungsten Dinitrogen Complexes. 18. Preparation and Characterization of Novel  $\mu^3$ -Dinitrogen Mixed Metal Complexes. *J. Am. Chem. Soc.* **1983**, *105*, 1680–1682; g) Mizobe, Y.; Yokobayashi, Y.; Oshita, H.; Takahashi, T.; Hidai, M. Preparation of Heterobimetallic Complexes with a Bridging Dinitrogen Ligand, [WX(PMe<sub>2</sub>Ph)<sub>4</sub>( $\mu$ -N<sub>2</sub>)MCp<sub>2</sub>Cl] (M = Ti, X = Cl; M = Zr, and Hf, X = I), and X-Ray Structure of [WI(PMe<sub>2</sub>Ph)<sub>3</sub>(Py)( $\mu$ -N<sub>2</sub>)ZrCp<sub>2</sub>Cl] (Py = Pyridine). *Organometallics* **1994**, *13*, 3764–3766; h) O’Donoghue, M. B.; Zanetti, N. C.; Davis, W. M.; Schrock, R. R. “Fixation” of Dinitrogen by Molybdenum and the Formation of a Trigonal Planar Iron-Tris[Molybdenum(Dinitrogen)] Complex. *J. Am. Chem. Soc.* **1997**, *119*, 2753–2754; i) O’Donoghue, M. B.; Davis, W. M.; Schrock, R. R.; Reiff, W. M. Heterobimetallic Dinitrogen Complexes That Contain the {[N<sub>3</sub>N]Mo-N:N}-Ligand. *Inorg. Chem.* **1999**, *38*, 243–252; j) Ishino, H.; Nagano, T.; Kuwata, S.; Yokobayashi, Y.; Ishii, Y.; Hidai, M.; Mizobe, Yasushi. Syntheses, Structures, and Reactivities of Heterobimetallic Bridging Dinitrogen Complexes Containing Group 6 and Group 4 or 5 Transition Metals. *Organometallics* **2001**, *20*, 188–198; k) Ishino, H.; Takemoto, S.; Hirata, K.; Kanaizuka, Y.; Hidai, M.; Nabika, M.; Seki, Y.; Miyatake, T.; Suzuki, N. Olefin Polymerization Catalyzed by Titanium–Tungsten Heterobimetallic Dinitrogen Complexes. *Organometallics* **2004**, *23*, 4544–4546; l) Broda, H.; Hinrichsen, S.; Kraemer, J.; Nather, C.; Tucek, F. Molybdenum Dinitrogen Complexes Supported by a Silicon-Centred Tripod Ligand and Dppm or Dmpm: Tuning the Activation of N<sub>2</sub>. *Dalton Trans.* **2014**, *43*, 2007–2012; m) Simonneau, A.; Turrel, R.; Vendier, L.; Etienne, M. Group 6 Transition-Metal/Boron Frustrated Lewis Pair Templates Activate N<sub>2</sub> and Allow Its Facile Borylation and Silylation. *Angew. Chem. Int. Ed.* **2017**, *56*, 12268–12272; n) Geri, J. B.; Shanahan, J. P.; Szymczak, N. K. Testing the Push–Pull Hypothesis: Lewis Acid Augmented N<sub>2</sub> Activation at Iron. *J. Am. Chem. Soc.* **2017**, *139*, 5952–5956; o) Simonneau, A.; Etienne, M. Enhanced Activation of Coordinated Dinitrogen with P-Block Lewis Acids. *Chem. – Eur. J.* **2018**, *24*, 12458–12463; p) Coffinet, A.; Simonneau, A.; Specklin, D. Push–Pull Activation of N<sub>2</sub>: Coordination of Lewis Acids to Dinitrogen Complexes. In *Encyclopedia of Inorganic and Bioinorganic Chemistry*; Scott, R. A., Ed.; Major Reference Works; Wiley-VCH Verlag GmbH & Co. KGaA, 2020; pp 1–25; q) Specklin, D.; Coffinet, A.; Vendier, L.; del Rosal, I.; Dinoi, C.; Simonneau, A. Synthesis, Characterization, and Comparative Theoretical Investigation of Dinitrogen-Bridged Group 6-Gold Heterobimetallic Complexes. *Inorg. Chem.* **2021**, *60*, 5545–5562.
- (8) Kim, E.; Odom, A. L.; Cummins, C. C. Synthesis of Mer-Trichlorotris(Tetrahydrofuran) Tungsten(III) by Intermetal Chlorine Atom Transfer. *Inorganica Chim. Acta* **1998**, *278*, 103–107.
- (9) a) Siepmann, R.; v. Schnering, H.-G.; Schäfer, H. Tungsten Trichloride [W<sub>6</sub>Cl<sub>12</sub>]Cl<sub>6</sub>. *Angew. Chem. Int. Ed. Engl.* **1967**, *6*, 637–637; b) Schrock, R. R.; Sturtevant, L. G.; Sharp, P. R. Preparation of Octachloroditungstate(4-) and Several of Its Derivatives. *Inorg. Chem.* **1983**, *22*, 2801–2806; c) Zheng, Y.-Q.; Jonas, E.; Nuss, J.; Schnering, H. G. von. The DMSO Solvated Octahedro-[W<sub>6</sub>Cl]Cl Cluster Molecule. *Z. Anorg. Allg. Chem.* **1998**, *624*, 1400–1404; d) Thurston, J. H.; Kolesnichenko, V.; Messerle, L.; Lattner, S. E.; Ainsworth, W. Trinuclear Tungsten Halide Clusters. In *Inorganic Syntheses: Volume 36*; John Wiley & Sons, Ltd, 2014; pp 24–30.
- (10) Wells, A. F. *Structural Inorganic Chemistry*; OUP Oxford, 2012, pp 803–805.
- (11) Pyykkö, P.; Atsumi, M. Molecular Double-Bond Covalent Radii for Elements Li–E112. *Chem. - Eur. J.* **2009**, *15*, 12770–12779.
- (12) The CCDC database was interrogated on the fragment MCl<sub>3</sub>(=N)(-O).
- (13) The CCDC database was interrogated on the fragment MCl<sub>4</sub>(=N)(-OC<sub>4</sub>H<sub>8</sub>).
- (14) Qualitative molecular orbital diagram are often used to explain bonding in bimetallic M=N=N=M complexes, understand the electronic spectrum or ways and means of N<sub>2</sub> splitting. See ref. 7d and a) Laplaza, C. E.; Johnson, M. J. A.; Peters, J. C.; Odom, A. L.; Kim, E.; Cummins, C. C.; George, G. N.; Pickering, I. J. Dinitrogen Cleavage by Three-Coordinate Molybdenum(III) Complexes: Mechanistic and Structural Data1. *J. Am. Chem. Soc.* **1996**, *118*, 8623–

- 8638; b) Klopsch, I.; Yuzik-Klimova, E. Y.; Schneider, S. Functionalization of N<sub>2</sub> by Mid to Late Transition Metals via N–N Bond Cleavage. *Top. Organomet. Chem.* **2017**, *60*, 71–112; c) Krewald, V. Dinitrogen Photoactivation: Status Quo and Future Perspectives. *Dalton Trans.* **2018**, *47*, 10320–10329; d) Lindley, B. M.; van Alten, R. S.; Finger, M.; Schendzielorz, F.; Würtele, C.; Miller, A. J. M.; Siewert, I.; Schneider, S. Mechanism of Chemical and Electrochemical N<sub>2</sub> Splitting by a Rhenium Pincer Complex. *J. Am. Chem. Soc.* **2018**, *140*, 7922–7935; e) Schendzielorz, F.; Finger, M.; Abbenseth, J.; Würtele, C.; Krewald, V.; Schneider, S. Metal-Ligand Cooperative Synthesis of Benzonitrile by Electrochemical Reduction and Photolytic Splitting of Dinitrogen. *Angew. Chem. Int. Ed.* **2019**, *58*, 830–834.
- (15) Hasanayn, F.; Holland, P.; Goldman, A.; Miller, A. Lewis Structures and the Bonding Classification of End-on Bridging Dinitrogen Transition Metal Complexes. **2022**. <https://doi.org/10.26434/chemrxiv-2022-p3nrk>.
- (16) Lauher, J. W.; Hoffmann, R. Structure and Chemistry of Bis(Cyclopentadienyl)-ML<sub>n</sub> Complexes. *J. Am. Chem. Soc.* **1976**, *98*, 1729–1742.
- (17) Jaroschik, F.; Penkhues, M.; Bahlmann, B.; Nicolas, E.; Fischer, M.; Massicot, F.; Martinez, A.; Harakat, D.; Schmidtman, M.; Kokkuvayil Vasu, R.; Vasse, J.-L.; Beckhaus, R. Synthesis, Characterization and Reactivity of Formal 20 Electron Zirconocene-Pentafulvene Complexes. *Organometallics* **2017**, *36*, 2004–2013.
- (18) George, T. A.; Noble, M. E. A Direct One-Step Preparation of Bis(Dinitrogen) Complexes of Molybdenum(0) from Molybdenum(V) Chloride. *Inorg. Chem.* **1978**, *17*, 1678–1679.
- (19) a) Harris, R. K.; Becker, E. D.; Cabral de Menezes, S. M.; Granger, P.; Hoffman, R. E.; Zilm, K. W. Further Conventions for NMR Shielding and Chemical Shifts (IUPAC Recommendations 2008). *Pure Appl. Chem.* **2008**, *80*, 59–84; b) Harris, R. K.; Becker, E. D.; Cabral de Menezes, S. M.; Goodfellow, R.; Granger, P. NMR Nomenclature. Nuclear Spin Properties and Conventions for Chemical Shifts. *Pure Appl. Chem.* **2001**, *73*, 1795–1818.

## Graphical Abstract

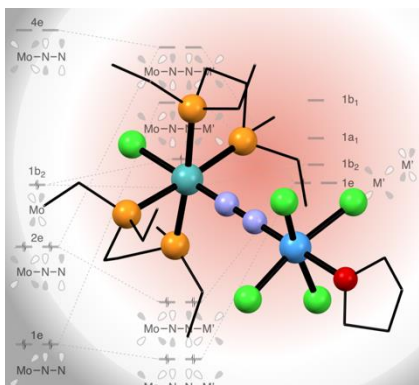

## Synopsis

Syntheses of new N<sub>2</sub>-bridged heterobimetallic complexes are reported, with their systematic structural analysis. Similarities or discrepancies are explained with qualitative molecular orbital diagrams.