



HAL
open science

A comparison of energy allocation rules for a collective self-consumption operation in an industrial multi-energy microgrid

Anthony Roy, Jean-Christophe Olivier, François Auger, Bruno Auvity, Salvy Bourguet, Emmanuel Schaeffer

► To cite this version:

Anthony Roy, Jean-Christophe Olivier, François Auger, Bruno Auvity, Salvy Bourguet, et al.. A comparison of energy allocation rules for a collective self-consumption operation in an industrial multi-energy microgrid. *Journal of Cleaner Production*, 2023, pp.136001. 10.1016/j.jclepro.2023.136001 . hal-03940234

HAL Id: hal-03940234

<https://hal.science/hal-03940234>

Submitted on 19 Jan 2023

HAL is a multi-disciplinary open access archive for the deposit and dissemination of scientific research documents, whether they are published or not. The documents may come from teaching and research institutions in France or abroad, or from public or private research centers.

L'archive ouverte pluridisciplinaire **HAL**, est destinée au dépôt et à la diffusion de documents scientifiques de niveau recherche, publiés ou non, émanant des établissements d'enseignement et de recherche français ou étrangers, des laboratoires publics ou privés.

A comparison of energy allocation rules for a collective self-consumption operation in an industrial multi-energy microgrid

Authors: Anthony Roy ^{a*}, Jean-Christophe Olivier ^a, François Auger ^a, Bruno Auvity ^b, Salvy Bourguet ^a, Emmanuel Schaeffer ^a

***Corresponding author:** Anthony Roy, anthony.roy@univ-nantes.fr

^a Nantes Université, Institut de Recherche en Énergie Électrique de Nantes Atlantique, IREENA, UR 4642, F-44600 Saint-Nazaire, France; {anthony.roy, jean-christophe.olivier, francois.auger, salvy.bourguet, emmanuel.schaeffer}@univ-nantes.fr

^b Nantes Université, CNRS, Laboratoire de thermique et énergie de Nantes, LTeN, UMR 6607, F-44000 Nantes, France; bruno.auvity@univ-nantes.fr

Abstract

With the widespread development of renewable energy sources, collective self-consumption (CSC) has been increasingly considered over recent years to sell the surplus of generated power to nearby consumers. However, appropriate energy allocation rules must be designed to efficiently share the energy among consumers. This paper aims to study two kinds of repartition keys for a CSC operation with multiple producers in the framework of an industrial multi-energy microgrid located in France. The default key considered in French regulations is compared to an optimized key based on the maximization of the income for the producers, in such a way as to maximize profitability by allocating the energy according to the consumers' electricity purchase price. The simulation results show that a CSC with an optimized key decreases the total electricity bill by 11.7%. For some producers, a reduction in the payback period between 6 months and 5 years is observed, compared to the case without CSC. A sensitivity analysis on economic assumptions is also proposed. The results show that the grid use tariff exemption is a key lever and makes it possible to find a more profitable selling price for producers and consumers, and to significantly reduce the payback period for investors.

Keywords

Microgrid, Collective self-consumption, energy sharing, energy communities, governance

1. Introduction

In recent years, renewable energy sources such as solar photovoltaic (PV) panels and wind turbines have been widely integrated into the energy mix. This major evolution implies the need to efficiently manage the excess power generated from these non-dispatchable sources. Most of the time, the power generated by renewable energy sources is in priority self-consumed by the producer (individual self-consumption). However, a surplus may remain if the producer's demand is lower than production. This excess energy can be stored in batteries, but

32 this solution is often too expensive in terms of investment and replacement costs (IRENA, 2020). As an
33 alternative, the surplus can be sold to the main grid or to nearby consumers. The aggregation of geographically
34 close producers and consumers exchanging energy is often referred to as an energy community (Frieden et al.,
35 2019). It can be noted that the participants with a role of both producer and consumer are sometimes referred to
36 in the literature as prosumers (Inês et al., 2020). Participatory, voluntary and open functioning is also put forward
37 as a foundation of the concept of an energy community (Walker and Devine-Wright, 2008). Depending on the
38 country and the regulations in force, an energy community is legally defined according to specific terms such as
39 a “renewable energy community” (REC), “citizen energy community” (CEC) or “collective self-consumption”
40 (CSC) (Frieden et al., 2019). Even if sharing energy between participants is common, some distinctions exist. As
41 described in (Frieden et al., 2019), these concern the organizational and market aspects, the geographical extent,
42 the location on the grid (voltage level), the status of the participants (companies, houses, local authorities, etc.),
43 the governance and activities included in the operation management (generation, distribution, transport, etc.).
44 The regulations in force in some European countries have been reviewed in several recent publications (Alaton
45 et al., 2020; Frieden et al., 2021; Inês et al., 2020; Lormeteau, 2022). Most energy communities developed over
46 the last few years were located in these countries, thanks to regulation recommendations and incentive directives
47 established by the European Union (European Union, 2019, 2018). It should be emphasized that community-
48 based markets differ from peer-to-peer markets, which are more linked to decentralized structures (Sousa et al.,
49 2019, p.). The different kinds of local energy markets have been compared in a recent publication (Capper et al.,
50 2022), including a comparison between energy communities, peer-to-peer and transactive energy markets.

51 One of the key points governing the operation of energy communities is the distribution of the energy
52 generated and sold by the producers to the consumers, which is the responsibility of the legal entity managing
53 the community (the energy community manager) (Frieden et al., 2021). This central entity communicates the
54 allocation of energy to the distribution system operator (DSO) for billing purposes. Most of the time, the energy
55 allocation is carried out in a settlement phase after the physical delivery of the energy. It is thus separated from
56 the real-time control of the system. The financial balance of each participant and of the community depends on
57 the rules taken into account for energy allocation. A literature review concerning energy allocation in energy
58 communities shows that several methods and criteria can be considered (Gjorgievski et al., 2021). Among the
59 possibilities, an energy criterion is often considered in the allotment rules. For example, self-sufficiency is
60 maximized in the study proposed in (Reis et al., 2021), and in (Coignard et al., 2020), in which it is favoured by
61 the integration of a demand-side management program and batteries. The self-consumption rate, which

62 represents the capability to use onsite the energy generated within a community, can also be considered, to use
63 the generated energy as locally as possible (Viti et al., 2020). Energy can be allocated according to prorate rules,
64 thanks to static or dynamic coefficients, as investigated in (Fina et al., 2022) where the authors considered a
65 distribution in proportion to the consumers' demand. Even if an energy community should be driven by
66 environmental values rather than financial profits, the economic balance must be taken into account in the energy
67 allocation rules, to ensure the operation's profitability especially for the participants who invest in the means of
68 production (Frieden et al., 2019). Therefore, the state-of-the-art shows that several studies have focused on the
69 integration of an economic objective in the energy allocation step. Minimization of the electricity bills of
70 participants (de Villena et al., 2022) or the overall cost at the level of the community (Cosic et al., 2021; Reis et
71 al., 2022a) can be considered. In (Contreras-Ocaña et al., 2021), the energy is allocated in a fair way, to ensure
72 that all participants obtained similar savings. The fairness is also considered in (Gjorgievski et al., 2022), with an
73 allocation minimizing inequality between participants. The social welfare is maximized in the optimization
74 proposed in (Perger et al., 2021), including the participants' willingness-to-pay. It should be noted that some
75 concepts can be found in the literature, such as the game theory concept (Abada et al., 2020a, 2020b; Pilz and
76 Al-Fagih, 2019) and the blockchain concept (Menniti et al., 2020; Van Cutsem et al., 2020). Finally, societal
77 aspects are a category of criteria. The users' preferences are considered in (Stephant et al., 2021), with a multi-
78 criteria approach including comfort, origin of electricity and costs. In (Reis et al., 2021), the goals pursued by the
79 members are integrated in a multi-agent framework, considering cost minimization and comfort satisfaction for
80 the consumers participating in a demand-side management program. Whatever the objective, the performances
81 of an energy community depend on the characteristics of the participants, especially of their demand. The
82 heterogeneity between actors has been investigated in (Reis et al., 2022b). Moreover, the study presented in
83 (Fina et al., 2019) shows the influence of the kinds of buildings included in an energy community. It can be
84 noted that an energy community can also concern participants located in the same residential building (Canova et
85 al., 2022). Furthermore, the flexibility of the governance and of the energy allocation rules has to be ensured, in
86 case there is an entry or withdrawal from the CSC operation, as investigated in (Mustika et al., 2022a; Perger and
87 Auer, 2022). Demand-side management can also be found in the literature, allowing flexibility on load demand
88 (Li et al., 2022, 2021).

89 This literature survey shows that most existing publications about energy allocation in the energy communities
90 have considered a minimization of electricity bills and/or a maximization of self-consumption and self-
91 sufficiency. The repartition in a way to foster investment profitability is less considered, which may not

92 encourage the development of such projects as the investment costs of means of production and storage can be
93 high. It seems relevant to take profitability into account in the energy allocation rules in order to obtain a
94 payback period that is acceptable to investors. Moreover, existing studies have focused on residential application
95 frameworks. The literature lacks studies dealing with industrial application frameworks and multi-energy
96 microgrids that could be beneficial for companies, whose load demand often occurs during the day, i.e. when PV
97 panels produce energy. The growth of hydrogen needs for transport also implies that hydrogen must be produced
98 every day, if possible from low-carbon sources. Thus, it could be beneficial to integrate a hydrogen producer into
99 an energy community, to maximize the use of locally generated electricity. From these observations, this paper
100 proposes an adapted energy allocation scheme for an energy community composed of industries and a hydrogen
101 producer. The case study examined is a French seaport area, studied in a national French project called
102 ESTUAIRE (Pole Mer Bretagne Atlantique, 2021). The development of a seaport microgrid is investigated.
103 Thus, the regulations currently in force in France are considered. The regulatory framework suited to the case
104 study presented corresponds to a so-called collective self-consumption operation set out under French
105 regulations (French Government, 2017), in which the energy allocation rules are defined by a repartition key. It
106 should be noted that several recent publications have studied the French context, especially the design of
107 repartition keys (Mustika et al., 2022b), for example in proportion to consumption and according to a
108 competitive exchange policy (Albouys-Perrois et al., 2022). In this paper, we propose to compare the default
109 allocation rules considered in the regulation in force with an optimized allocation scheme favouring the income
110 for the producers. Even if the case study is located in a specific country, the developments can be adapted to
111 other countries with similar regulations (Frieden et al., 2021). It can be noted that the method is applicable for
112 grid-connected microgrids and that the case of isolated microgrids refers to another regulatory framework
113 (energy community with only local producers, without any external supplier). The main contributions of this
114 paper are the following:

- 115 • The design of an optimized repartition key for a CSC operation, based on an income maximization for
116 producers, thus a maximization of profitability and a minimization of the payback period;
- 117 • The study of the benefits brought by a CSC operation in an industrial multi-energies microgrid, with
118 consumption occurring mainly when production exists (unlike CSC operations with residential
119 buildings);

- 120 • A sensitivity analysis of the economic assumptions, to show how the results are influenced by the
121 choice of the local energy price and by the network use tariff, considering a total or partial exemption of
122 the latter.

123 This paper is organized as follows. Section 2 presents the studied fictitious CSC operation. In Section 3, the
124 repartition keys defining the energy allocation rules are explained, as well as the calculations related to the
125 financial assessment. Section 4 aims to compare the results obtained for several scenarios, and then a sensitivity
126 analysis is carried out on economic assumptions. Finally, a conclusion and perspectives for future work are given
127 in Section 5.

128 **2. Description of the studied CSC operation**

129 The fictitious CSC operation considered in this paper is an industrial multi-energy microgrid, the power flow
130 scheme of which is presented in Fig. 1. This microgrid involves $N_p = 12$ participants, assuming that a participant
131 corresponds to a building connected to the distribution network, which has its own electricity bill with a tariff
132 contracted with an electricity supplier. The set of participants is denoted as $\mathcal{J} = \{1, \dots, N_p\}$. Six of these
133 participants are energy producers as they own PV panels. All the participants have electrical loads and thus
134 behave like a consumer. The participant 12 produces hydrogen to supply hydrogen loads (for mobility use), for
135 which more details were given in a previous study (Roy et al., 2021). The integration of a hydrogen producer in a
136 CSC operation allows the production of low-carbon hydrogen because it could benefit from the surplus of energy
137 generated by the producers. This microgrid is connected to the main grid, which ensures that the load demand
138 can be met whatever the local production level. Moreover, the main grid can absorb the surplus of generated
139 power not consumed within the microgrid.

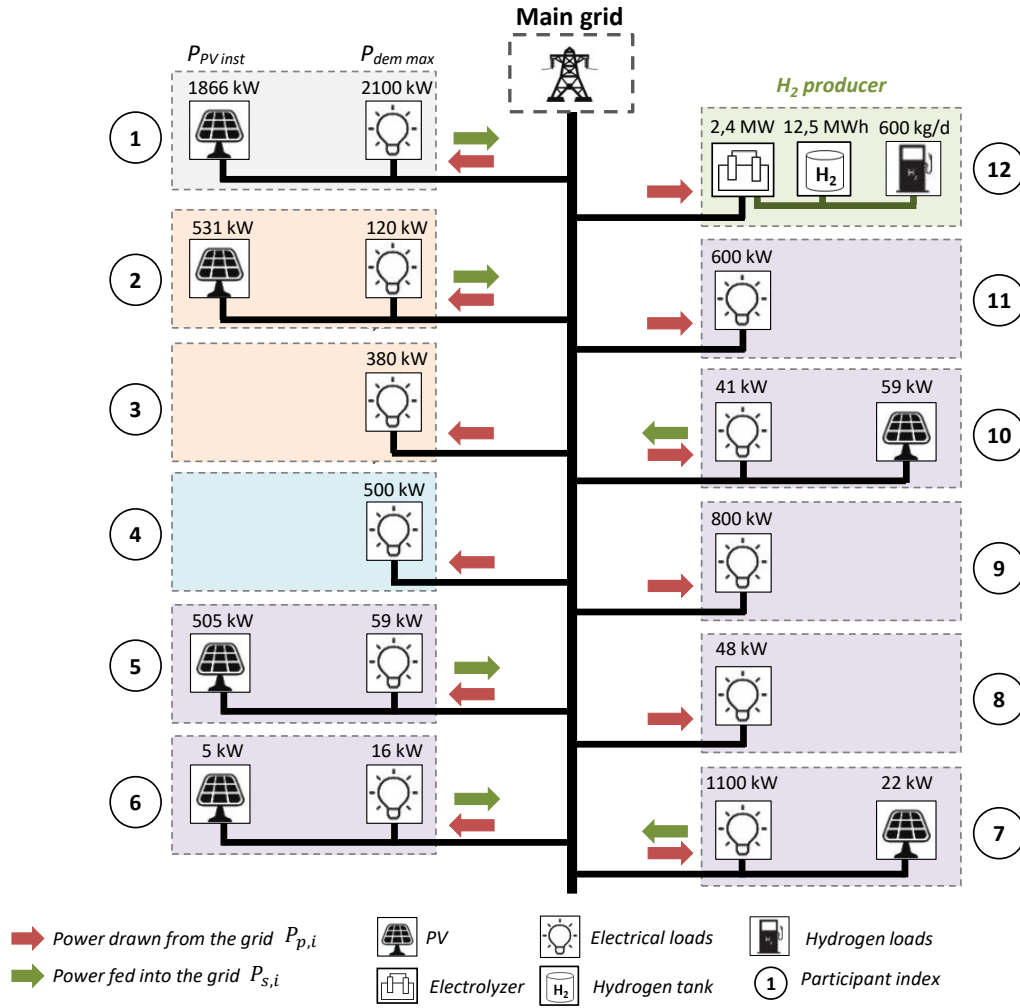

Fig. 1. Layout of the industrial microgrid of the considered CSC operation

140

141

142

143

144

145

146

147

148

149

150

151

152

In this study, it was assumed that the individual self-consumption of the power generated by PV is prioritized as much as possible, as that is the most profitable solution of energy valorisation. Indeed, according to the electricity tariffs of the case study, it is more beneficial for producers to use their generated power to supply their own demand, as the electricity purchase price (i.e. the price defining the electricity bill savings) is higher than the price of a sale to the grid, regardless of the buyer (the main grid or other participants). To simplify the study and the analysis of the results, the storage of energy in batteries is not considered (the installation of batteries can lead to an increase of the producers' payback period due to expensive investment costs). For each participant i , the power denoted as $P_{p,i}$ [kW] corresponds to the power purchased or drawn from the electrical grid, thus for a producer the lack of power after having considered the individual use of the power generated behind-the-meter. This power can also be called net consumption (de Villena et al., 2022). The power $P_{s,i}$ is that sold or fed into the electrical grid by the participant i , i.e. the surplus of generated power remaining after individual self-consumption (also called net production). These powers are considered as positive. They correspond to the

153 power measured by metering devices installed on the buildings of the community members, considering a time
154 step of 30 min, as stated by the French regulation (ENEDIS, 2019). From the meaning of these powers, it must
155 be noted that at any time a participant i is either a producer or a consumer, resulting in $P_{p,i} \times P_{s,i} = 0$. These
156 powers will be used in Section 3 as input data of the CSC management algorithm, so as to share the power
157 generated by the producers that is not used by individual self-consumption.

158 **3. Design of energy allocation rules for the collective self-consumption operation**

159 A CSC operation implies the establishment of energy allocation rules to define how the power surplus
160 generated will be shared between consumers. This step consists of an *a posteriori* allotment of the energy in a
161 settlement phase at the end of each month. It does not necessarily represent the physical exchanges occurring in
162 the system and it is not dedicated to be assessed in real-time. It corresponds to a financial assessment step,
163 performed after the delivery of electricity and is managed by a moral organizer (i.e. a legal entity or a legal
164 person), for example the “*personne morale organisatrice*” (PMO) in France (French Government, 2017).

165 A scheme of the CSC operation structure considered is shown in Fig. 2, representing the data exchanged
166 between entities about power allocation and billing. The power supplier represents the entity from which the
167 participant purchases energy in the case of lack of power in the community (i.e. power drawn from main grid in
168 Fig. 1). The power supplier may be different depending on the participant. The purchaser of surplus represents
169 the entity which purchases the surplus of energy not consumed by the CSC consumers (i.e. power fed into the
170 main grid). Before the start of the CSC operation, the moral organizer has to transmit to the DSO the energy
171 sharing rules contracted between the participants gathered under the term of repartition key. As stated by the
172 regulations (French Government, 2017), this repartition key can be based on default rules which consist of a
173 power allocation proportional to the consumption of the participants. Alternatively, it can follow personalized
174 rules. In the following part, a methodology is proposed for both kinds of repartition key, considering an
175 optimized allocation allowing the producers income to be maximized for the second one.

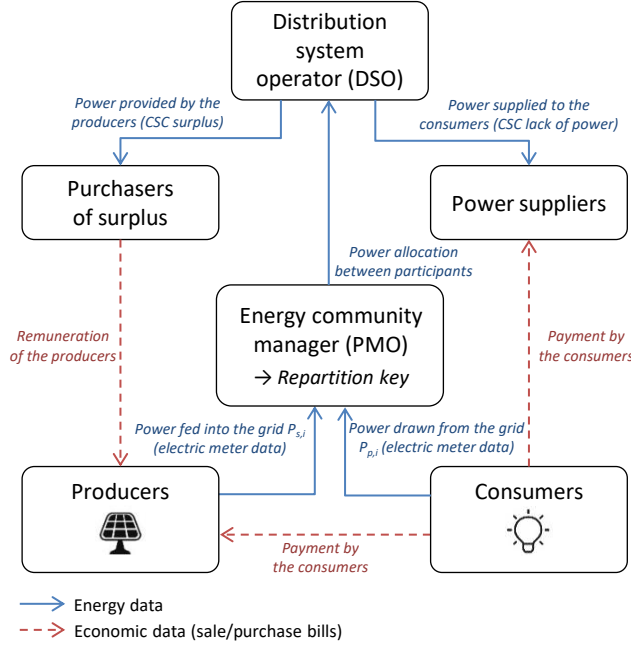

Fig. 2. Scheme of energy and economic data flows between the entities of the CSC operation considered, according to French regulations

176

177 3.1. Proposed energy allocation rules

178 To calculate the share of energy exchanged in the community, the powers $P_{p,i}$ and $P_{s,i}$ of participants
 179 introduced in Section 2 are split into two terms. One is related to the flow with the other participants (denoted as
 180 “local” by an index l) and the other corresponds to the flow with the main grid (denoted as “main” by an index
 181 m), such that for a participant i .

$$P_{p,i} = P_{p,l,i} + P_{p,m,i} \quad (1)$$

$$P_{s,i} = P_{s,l,i} + P_{s,m,i} \quad (2)$$

182 where $P_{p,l,i}$ [kW] is the power requested by participant i from the other CSC members, $P_{p,m,i}$ [kW] the power
 183 requested by participant i from the main grid (i.e. the supplier of electricity not provided by local sources), $P_{s,l,i}$
 184 [kW] the power guaranteed by participant i to the other CSC members and $P_{s,m,i}$ [kW] the power guaranteed by
 185 participant i to the main grid (i.e. to the purchaser of surplus). These four powers are considered to be positive.
 186 Also, these powers are virtual and do not correspond to physical flows. They correspond to an *a posteriori*
 187 energy allocation for billing purposes only. An example of this power distribution is proposed in Fig. 3 for a
 188 small CSC operation, with the allocation of the power fed into and drawn from the grid by participant 1. For the
 189 power allocated within the CSC operation, an individual-to-individual allocation is considered, with $P_{p,l,i,j}$

190 representing the power requested by participant i from participant j , which is equal to $P_{s,l,j,i}$ representing the
 191 power guaranteed by participant j to participant i . This individual allocation must ensure that the following
 192 equations are met:

$$P_{p,l,i} = \sum_{j=1, j \neq i}^{N_p} P_{p,l,i,j} = \sum_{k=1, k \neq i}^{N_p} P_{s,l,k,i} \quad (3)$$

$$P_{s,l,i} = \sum_{j=1, j \neq i}^{N_p} P_{s,l,i,j} = \sum_{k=1, k \neq i}^{N_p} P_{p,l,k,i} \quad (4)$$

193

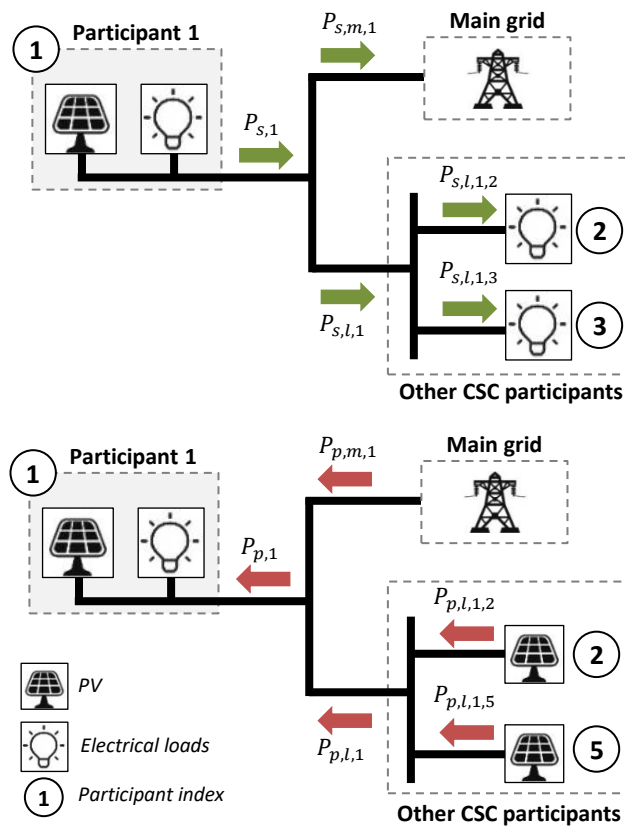

Fig. 3. Distribution of the power flows related to participant 1 for a case in which participant 1 sells energy (top scheme) and a case in which participant 1 purchases energy (bottom scheme)

194 The following sections present the calculation of these four virtual powers, according to the flowchart
 195 presented in Fig. 4. Firstly, the power fed into the main grid and into the CSC operation is calculated to evaluate
 196 the amount of power that can be exchanged within the community. Then, the generated power guaranteed to the
 197 CSC is allocated between consumers thanks to a repartition key, to determine the purchase from the CSC by
 198 each consumer. Finally, the individual-to-individual allocation is calculated, before deducing the remaining
 199 power requested from the main grid.

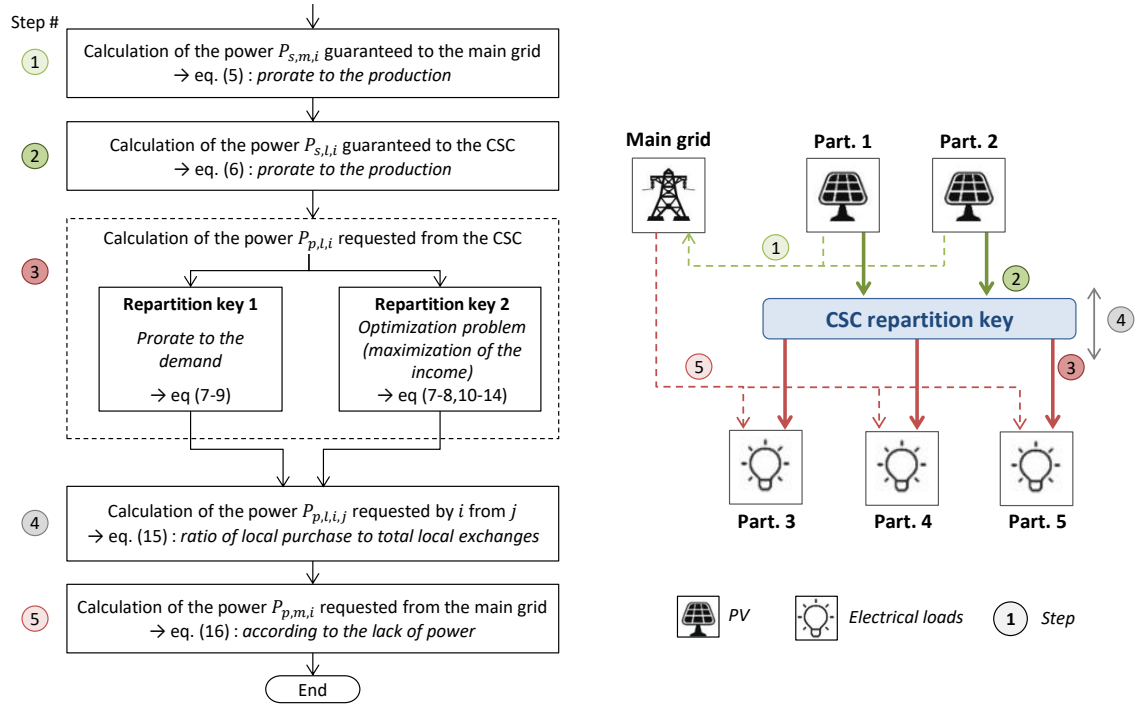

Fig. 4. Calculation steps of the energy allocation algorithm

200

201 **Step 1:** The first step consists of the calculation of the power $P_{s,m,i}$ fed into the main grid, i.e. the part of the
 202 generated power which is not used by CSC consumers due to the total power generated ($\sum_{j=1}^{N_p} P_{s,j}$) being larger
 203 than the total power needed ($\sum_{j=1}^{N_p} P_{p,j}$). It has been assumed that this excess is shared between producers in
 204 proportion to their production $P_{s,i}$ compared to the total production of all the participants, as considered in the
 205 regulations in force (ENEDIS, 2019). Each producer sells part of his production to the main grid, which
 206 represents the least profitable result for a producer, because the purchase price is low. Thus, the power $P_{s,m,i}$ sold
 207 to the main grid by a participant i is defined by:

$$P_{s,m,i} = \max\left(0, \left(\sum_{j=1}^{N_p} P_{s,j} - \sum_{j=1}^{N_p} P_{p,j}\right) \frac{P_{s,i}}{\sum_{j=1}^{N_p} P_{s,j}}\right) = \max\left(0, P_{s,i} \left(1 - \frac{\sum_{j=1}^{N_p} P_{p,j}}{\sum_{j=1}^{N_p} P_{s,j}}\right)\right) \quad (5)$$

208 It should be noted that if the total power generated $\sum_{j=1}^{N_p} P_{s,j}$ is lower than the total power demanded $\sum_{j=1}^{N_p} P_{p,j}$,
 209 the power $P_{s,m,i}$ is zero for all participants.

210 **Step 2:** The power $P_{s,l,i}$ guaranteed to the CSC by the producer i is deduced from the previous result according
 211 to:

$$P_{s,l,i} = P_{s,i} - P_{s,m,i} \quad (6)$$

212 From these results, it can be noted that the total power guaranteed by the producers to the community is at
 213 most equal to the total power requested by the consumers ($\sum_{j=1}^{N_p} P_{s,l,j} \leq \sum_{j=1}^{N_p} P_{p,j}$). Moreover, the part of the
 214 energy generated by each producer that is used in the CSC operation is proportional to their part in production,
 215 i.e. to their investments (the producers who have invested the most, therefore those who have produced the most,
 216 have the most energy allocated to the community). The power $P_{s,l,i}$ will be allocated between purchasers (i.e. the
 217 calculation of the power $P_{s,l,i,j}$ guaranteed by producer i to each consumer j) after the computation of the
 218 repartition key presented in the next paragraph.

219 **Step 3:** The total power $\sum_{j=1}^{N_p} P_{s,l,j}$ guaranteed to the CSC operation by producers has to be allocated between
 220 consumers thanks to a repartition key, so as to determine the power $P_{p,l,i}$ that each consumer i requests from the
 221 CSC operation. This result will be used to calculate the individual-to-individual power exchanged
 222 ($P_{p,l,i,j} = P_{s,l,j,i}$). Regardless of the repartition key applied, the allocated power $P_{p,l,i}$ cannot exceed the
 223 participant' consumption $P_{p,i}$:

$$0 \leq P_{p,l,i} \leq P_{p,i} \quad (7)$$

224 Moreover, the total power requested by the CSC operation from the producers must be equal to the total power
 225 guaranteed by the producers to the CSC operation:

$$\sum_{i=1}^{N_p} P_{p,l,i} = \sum_{j=1}^{N_p} P_{s,l,j} \quad (8)$$

226 **Repartition key 1 (K1):** The first key considered is the default key for French regulations (French
 227 Government, 2017), which consists of allocating the total power $\sum_{j=1}^{N_p} P_{s,l,j}$ guaranteed to the CSC among the
 228 consumers in proportion to their consumption compared to the total consumption of all the participants. This key
 229 is based on a pro rata calculation according to the demanded power, with the power $P_{p,l,i}$ defined as:

$$P_{p,l,i} = \frac{P_{p,i}}{\sum_{k=1}^{N_p} P_{p,k}} \times \sum_{j=1}^{N_p} P_{s,l,j} \quad (9)$$

230 **Repartition key 2 (K2):** the second repartition key investigated in this article is based on an optimization
 231 problem. Current regulations allow a custom key, as long as the rules are established before the start of the CSC
 232 operation (French Government, 2017). The purpose of this key is to obtain a distribution that maximizes the
 233 income of producers and improves the profitability of the investments, by selling as much energy as possible to

234 the consumers who have the highest purchase price. Indeed, the first repartition key does not always lead to
 235 suitable profit, as in priority the energy is allocated to the participants with the highest consumption, regardless
 236 of their purchase price. It should be emphasized that the purchase prices considered in this second repartition key
 237 are defined before the start of the CSC operation, according to the contract established between the consumer
 238 and the supplier. Thus, the consumer cannot decide to change its value at will during the CSC operation, unlike
 239 the situation in a dynamic energy market in which auctions are allowed (Capper et al., 2022; Javadi et al., 2022).
 240 This second repartition key is formulated according to the following equations:

$$P_{p,l} = \arg \max(c_{p,l,sp}^t \bar{P}_{p,l} \Delta t) \quad (10)$$

$$P_{p,l} = [P_{p,l,1} \quad \dots \quad P_{p,l,i} \quad \dots \quad P_{p,l,N_p}] \quad (11)$$

$$c_{p,l,sp} = [c_{p,l,sp,1} \quad \dots \quad c_{p,l,sp,i} \quad \dots \quad c_{p,l,sp,N_p}]^t \quad (12)$$

$$\bar{P}_{p,l} = [\bar{P}_{p,l,1} \quad \dots \quad \bar{P}_{p,l,i} \quad \dots \quad \bar{P}_{p,l,N_p}]^t \quad (13)$$

241 where $P_{p,l}$ is the vector containing the optimal solution of allocated power $P_{p,l,i}$ for each participant, $\bar{P}_{p,l}$ the
 242 vector of decision variables of the optimization problem (i.e. the allocated powers), $c_{p,l,sp}$ the vector containing
 243 the component of the electricity purchase cost that is related to the supply cost (this cost determines the
 244 remuneration of the producer, as described in Section 3.2) [€/kWh] and Δt the time step [h]. To be feasible, the
 245 solution must satisfy certain constraints. The allocated power $\bar{P}_{p,l,i}$ cannot exceed the power $P_{p,i}$ demanded by
 246 the consumer:

$$0 \leq \bar{P}_{p,l,i} \leq P_{p,i} \quad (14)$$

247 Moreover, the total allocated power $\sum_{i=1}^{N_p} \bar{P}_{p,l,i}$ must be equal to the total power guaranteed by the producers
 248 $\sum_{i=1}^{N_p} P_{s,l,i}$ as stated in eq. (8). This optimization problem is a linear programming problem which can be easily
 249 solved. In this work, we used the *linprog* function available in the MATLAB scientific environment. This problem
 250 could also be solved with a rule-based algorithm, consisting of ordering the values of purchase prices and
 251 allocating energy according to this order.

252 **Step 4:** Once the powers $P_{p,l,i}$ are calculated by one of the repartition keys, an individual-to-individual allocation
 253 is needed for individual billing purposes, by defining the amount of energy that each consumer purchases from
 254 each producer. As several producers participate in the operation and as their benefits are related to the
 255 consumers' purchase price, the individual allocation has to distribute between the producers the benefits brought

256 by a sale to the consumers having the highest purchase price. Thus, it is considered in this study that the
 257 individual allocation is carried out in proportion to the local purchase of the consumer compared to the sum of all
 258 local exchanges. Thus, the exchange between a consumer i and a producer j is computed as:

$$P_{p,l,i,j} = P_{s,l,j,i} = \frac{P_{p,l,i} P_{s,l,j}}{\sum_{k=1}^{N_p} P_{s,l,k}} \quad (15)$$

259 where $P_{p,l,i,j}$ is the power requested by i from j and $P_{s,l,j,i}$ the power guaranteed by j to i . In other words, for
 260 example, if the power $P_{p,l,i}$ requested from the CSC operation by a consumer i represents 25% of the total of
 261 local exchanges, this consumer purchases from each producer 25% of its local sale. From the opposite point of
 262 view (i.e. the individual allocation of the sale), if the power $P_{s,l,j}$ guaranteed by a producer j to the CSC
 263 represents 50% of local exchanges, this producer sells to each consumer 50% of its local purchase.

264 **Step 5:** Finally, the power drawn from the main grid by the consumer i is deduced from $P_{p,i}$ and $P_{p,l,i}$:

$$P_{p,m,i} = P_{p,i} - P_{p,l,i} \quad (16)$$

265

266 To illustrate the methodology and the effect of the two repartition keys, an example of power allocation results
 267 on a small number of participants (two producers and two consumers) and for one time sample ($\Delta t = 30$ min) is
 268 given in Table 1, for the case with $\sum_{j=1}^{N_p} P_{s,j} < \sum_{j=1}^{N_p} P_{p,j}$.

269 Table 1: Example of power allocation (the case when total power generated is lower than total power needed)

Participant index i	$P_{s,i}$ [kW]	$P_{p,i}$ [kW]	$c_{p,l,sp,i}$ [€/kWh]	$P_{s,m,i}$ [kW]	$P_{s,l,i}$ [kW]	$P_{p,l,i}$ [kW]	$P_{p,m,i}$ [kW]	$P_{p,l,i}$ [kW]	$P_{p,m,i}$ [kW]
						K1	K1	K2	K2
1	400	0	-	0	400	0	0	0	0
2	100	0	-	0	100	0	0	0	0
3	0	200	0.0905	0	0	166.7	33.3	200	0
4	0	400	0.0880	0	0	333.3	66.7	300	100
Total	500	600	-	0	500	500	100	500	100

270

271 The individual allotment described in Eq. (15) leads to the following results for the first repartition key (K1):
 272 participant 3 purchases $P_{p,l,3,1} = 133.4$ kW from producer 1 and $P_{p,l,3,2} = 33.3$ kW from producer 2. Participant 4
 273 purchases $P_{p,l,4,1} = 266.6$ kW from producer 1 and $P_{p,l,4,2} = 66.7$ kW from producer 2. For the second repartition
 274 key (K2), the individual-to-individual allocation leads to: $P_{p,l,3,1} = 160$ kW, $P_{p,l,3,2} = 40$ kW, $P_{p,l,4,1} = 240$ kW
 275 and $P_{p,l,4,2} = 60$ kW. With the second repartition key, participant 3 obtains more energy from the producers than
 276 participant 4 does, as its purchase price is higher. The income of producer 1 is 17.76 € for K1 and 17.8 € for K2.

277 For producer 2, the income is 4.43 € for K1 and 4.45 € for K2. Thus, with the repartition key K2, the producers'
 278 income is increased.

279 Another example of power allocation results is given in Table 2 in the case where $\sum_{j=1}^{N_p} P_{s,j} > \sum_{j=1}^{N_p} P_{p,j}$. For
 280 this second example, the two repartition keys lead to the same results since the generated power is sufficient to
 281 supply all the demand. Thus, consumers purchase all the electricity that they need from the CSC producers,
 282 regardless of the repartition key. The individual allotment described in Eq. (15) results in the following
 283 distribution: $P_{p,l,3,1} = 142.9$ kW, $P_{p,l,3,2} = 57.1$ kW, $P_{p,l,4,1} = 285.7$ kW and $P_{p,l,4,2} = 114.3$ kW. The income is
 284 19.04 € for producer 1 and 7.61 € for producer 2.

285 Table 2: Example of power allocation (the case when total power generated is greater than total power needed)

Participant index i	$P_{s,i}$ [kW]	$P_{p,i}$ [kW]	$c_{p,l,sp,i}$ [€/kWh]	$P_{s,m,i}$ [kW]	$P_{s,l,i}$ [kW]	$P_{p,l,i}$ [kW]	$P_{p,m,i}$ [kW]	$P_{p,l,i}$ [kW]	$P_{p,m,i}$ [kW]
						K1	K1	K2	K2
1	1000	0	-	571.4	428.6	0	0	0	0
2	400	0	-	228.6	171.4	0	0	0	0
3	0	200	0.0905	0	0	200	0	200	0
4	0	400	0.0880	0	0	400	0	400	0
Total	1400	600	-	800	600	600	0	600	0

286

287 3.2. Economic assessment

288 The rules presented in the previous section concerning energy allocation allows energy exchanges between
 289 producers, consumers and the main grid to be individually quantified. Once this step has been completed, the
 290 billing of the energy purchases and sales can be assessed following the methodology described below.

291 Regardless of the consumer and the producer from whom the energy is purchased, an electricity purchase tariff
 292 is made up of three costs, a distribution common to many European countries (European Council, 2014). The
 293 first component is related to the energy supply cost, which includes the generation cost of electricity, along with
 294 that of trading and selling. This cost, denoted by the index sp in the following equations, represents the
 295 remuneration of the producer. The second component, denoted by the index gr , is the cost dedicated to the use
 296 of the public electric grid for the transport and distribution of electricity. The third corresponds to taxes and is
 297 denoted hereafter by the index tax . The value of these three components depends on the energy source (either
 298 the main grid or a CSC operation producer). However, it is assumed that the total purchase price is the same for
 299 all CSC producers (i.e. there is no concurrence between the CSC operation producers in terms of selling price)
 300 and that the cost components do not differ according to the producer. Thus, for a consumer i , the tariff $c_{p,m,i}$ of

301 the electricity purchased from the main grid and the tariff $c_{p,l,i}$ of the electricity purchased from a CSC operation
 302 producer (in €/kWh) are defined by:

$$c_{p,m,i} = c_{p,m,sp,i} + c_{p,m,gr,i} + c_{p,m,tax,i} \quad (17)$$

$$c_{p,l,i} = c_{p,l,sp,i} + \beta_{gr} c_{p,l,gr,i} + c_{p,l,tax,i} \quad (18)$$

303 where β_{gr} is a coefficient allowing an exemption from the network usage tariff $c_{p,l,gr,i}$ (with $0 \leq \beta_{gr} \leq 1$, 0
 304 meaning total exemption and 1 no exemption). This is considered in the sensitivity analysis section of this paper
 305 (4.3), showing the benefits brought by a partial or total exemption of this cost for the electricity purchased from
 306 the CSC. While the values of the taxes and the grid use cost are set by regulations and can differ between the
 307 main grid and the CSC (Carenco et al., 2020), the supply cost of electricity purchased from a CSC producer
 308 ($c_{p,l,sp,i}$) can be set as desired. A trade-off has to be found between a low price which will be attractive to the
 309 consumer (it will improve savings on the invoice) and a high price which will be interesting for the producer,
 310 since this cost will determine producer' remuneration. To study the impact of this trade-off, a coefficient α_p is
 311 introduced to quantify the ratio between the main grid electricity cost $c_{p,m,i}$ and the local cost of electricity $c_{p,l,i}$,
 312 such as:

$$c_{p,l,i} = \alpha_p c_{p,m,i} \quad (19)$$

313 The electricity purchase costs are time-dependent, as there are low and high price periods during a day, as well
 314 as seasonal periods. Thus, within the CSC operation, the purchase price differs according to the consumer and
 315 the price period. For a period of K time samples and a participant i , the total bill $C_{p,m,i}$ [€] for the electricity
 316 purchased from the main grid and the total bill $C_{p,l,i}$ [€] for the electricity purchased from the CSC producers are
 317 defined by:

$$C_{p,m,i} = \sum_{k=1}^K P_{p,m,i}(t_k) c_{p,m,i}(t_k) \Delta t \quad (20)$$

$$C_{p,l,i} = \sum_{k=1}^K \sum_{j=1}^{N_p} P_{p,l,i,j}(t_k) c_{p,l,i}(t_k) \Delta t \quad (21)$$

318 For producers, remuneration is defined by the supply cost of the purchaser bill. For a producer i and a period
 319 of K time samples, the total remuneration $C_{s,m,i}$ [€] brought by the sale of electricity to the main grid and the
 320 total remuneration $C_{s,l,i}$ [€] brought by the sale to the CSC operation consumers are defined by:

$$C_{s,m,i} = \sum_{k=1}^K P_{s,m,i}(t_k) c_{s,m}(t_k) \Delta t \quad (22)$$

$$C_{s,l,i} = \sum_{k=1}^K \sum_{j=1}^{N_p} P_{s,l,i,j}(t_k) c_{p,l,sp,j}(t_k) \Delta t \quad (23)$$

321 where $c_{s,m}$ is the price of the electricity sold to the main grid [€/kWh], which is the same for all producers.

322 4. Results

323 The methodology described in the previous section is validated by a simulation of an industrial case study. The
 324 aim of this section is to show the benefits for the participants of integrating a CSC operation and to assess the
 325 effectiveness of the proposed repartition keys. Moreover, a sensitivity analysis can reveal the impact of
 326 economic parameters related to the choice of the CSC electricity price and the exemption of grid use tariff.

327 4.1. Case study description

328 The case study considered in this paper deals with an industrial framework involving several companies in a
 329 seaport area in the city of Saint-Nazaire, France. The theoretical CSC operation includes twelve buildings, for
 330 which the consumption characteristics are given in Table 3. The power $P_{dem\ max}$ is the maximum load power of
 331 each participant and the energy E_{dem} corresponds to the energy consumed annually by the loads. The data
 332 related to the load demand of participants is taken from real measurements over a one-year period (2019).
 333 Among these participants, it is presumed that six buildings have PV panels (Table 3), with an installed power
 334 $P_{pv\ inst}$ sized to maximize their individual self-consumption while taking the area available in the roofs into
 335 account. The total installed power reaches 3 MW, corresponding to the maximum installed power allowed by
 336 current regulations for a CSC operation in France (French Government, 2017). The energy E_{gen} corresponds to
 337 the annual energy generated by PV panels.

338

Table 3: Data of participants of the CSC operation

Participant index	$P_{dem\ max}$ [kW]	E_{dem} [MWh/y]	$P_{pv\ inst}$ [kW]	E_{gen} [MWh/y]
1	2147	5047	1865	2227
2	126	264	531	634
3	378	284	0	0
4	563	1166	0	0
5	59	74	505	603
6	16	71	5	5
7	1134	615	22	25
8	48	119	0	0
9	767	371	0	0
10	41	139	59	70
11	600	787	0	0
12	2400	10800	0	0
Total	8279	19737	3000	3564

339 For each participant, the profiles of the purchase price $c_{p,m,i}$ of the electricity drawn from the main grid for a
 340 winter and a summer day are given in Fig. 5 and Fig. 6, respectively. For most participants (except 3, 6 and 12),
 341 a peak price period exists in the morning (between 8 a.m. and 10 a.m.) and in the afternoon (between 6 p.m. and
 342 8 p.m.). It should be highlighted that participant 12, corresponding to the hydrogen producer, has the lowest
 343 purchase price due to its high consumption level and a subsidized tariff due to hydrogen production.

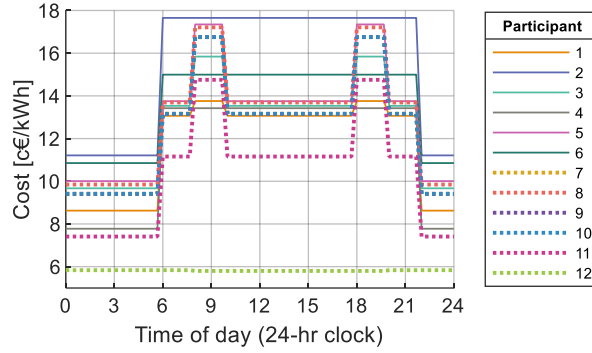

344 Fig. 5. CSC participants electricity purchase prices $c_{p,m,i}$ for a winter day

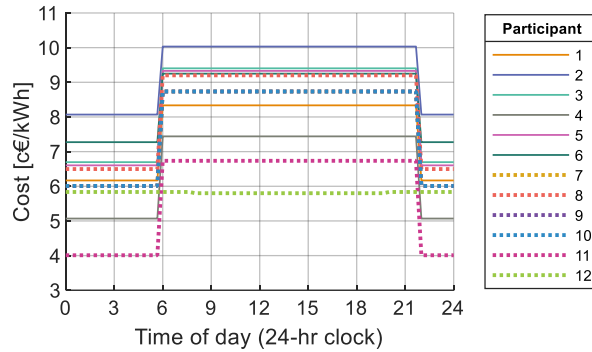

345 Fig. 6. CSC participants electricity purchase prices $c_{p,m,i}$ for a summer day

346 As a baseline scenario, it has been assumed in this article that electricity purchased from any CSC producer
 347 would be 5% cheaper than electricity purchased from the main grid ($\alpha_p = 0.95$), irrespective of the time of day
 348 and of the season. Moreover, no exemption of grid use tariff has been considered ($\beta_{gr} = 1$) in the baseline
 349 scenario. Thus, considering these assumptions and equations (17)-(19), the profiles of the supply cost $c_{p,l,sp,i}$ of
 350 electricity purchased from CSC producers are given in Fig. 7 (winter day) and Fig. 8 (summer day). These prices
 351 correspond to the remuneration of producers who will sell energy to these participants (see Eq. (18) and (23)).

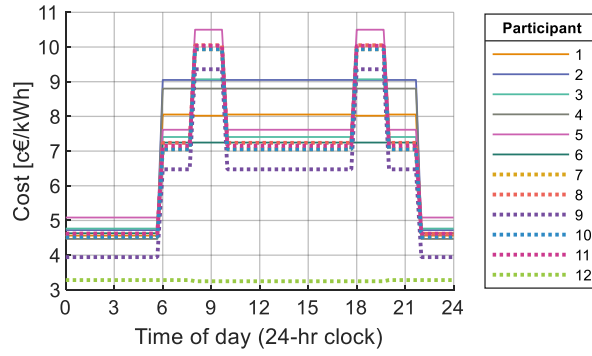

Fig. 7. Supply cost $c_{p,l,sp,i}$ of the local electricity purchase price for a winter day

352

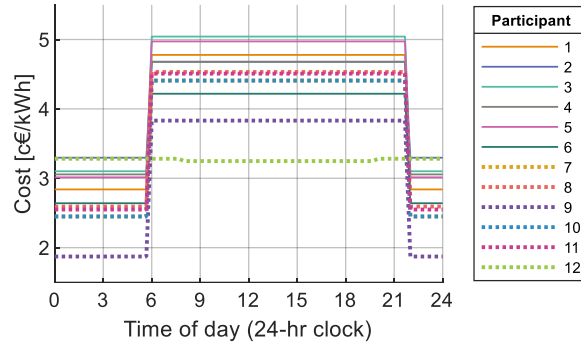

Fig. 8. Supply cost $c_{p,l,sp,i}$ of the local electricity purchase price for a summer day

353

354 For the electricity sold to the main grid by producers, the selling price is set to $c_{s,m} = 4$ c€/kWh regardless of
 355 the producer.

356 4.2. Comparisons of CSC scheme results

357 This section aims to study the benefits of setting up a CSC operation, as well as to show the consequences of
 358 the choice of a repartition key. Three scenarios are compared according to the CSC scheme:

- 359 • Scenario A: no CSC, only individual self-consumption;
- 360 • Scenario B: CSC with the default repartition key based on consumption prorata (K1);
- 361 • Scenario C: CSC with the optimized repartition key based on the maximization of producer income (K2);

362 The PV sizing is the same in all three scenarios. It should be noted that this CSC operation is not yet
 363 operational and the PV panels are not yet installed. Thus, the economic results are presented in such a way as to
 364 identify for the producers whether or not it is interesting to integrate a CSC operation, and if so, with which
 365 repartition key. The calculation of the payback period will be considered, to evaluate the profitability of
 366 investments made by the participants with a producer role. This corresponds to the ratio between investments
 367 and the annual net benefits as explained in (Roy et al., 2021). The annual net benefit is the difference between
 368 income (bill savings and sale of electricity to CSC participants and the main grid) and expenses (PV operational

369 costs). For all participants, the electricity purchase bill savings for each scenario will be calculated by comparing
 370 the fictitious purchase bill (thus, with PV production) with the current electricity purchase bill for which all the
 371 electricity is purchased from the main grid (thus, no PV production).

372 The results related to the energy allocation obtained for each scenario are given in Figs. 9 and 10. Fig. 9 shows
 373 the origin of the energy purchased by each of the twelve consumers. The distributions obtained show that
 374 individual self-consumption can represent a significant proportion of the energy supply, especially for
 375 participants 1, 2, 5 and 10. The integration into a CSC operation is beneficial for all participants as it allows them
 376 to decrease the rate of energy drawn from the main grid (scenarios B and C). When the optimized repartition key
 377 is applied (scenario C), the share of energy purchased from the CSC is significantly increased for some
 378 consumers (participants 3, 4, 6, 7, 8, 9 and 11). Indeed, these participants have the highest supply costs, thus they
 379 are the most interesting purchasers for producers. For participant 12, the optimized key does not bring a positive
 380 effect. Indeed, it decreases the amount of local energy allocated, because of the low supply cost of this
 381 participant, which gives it the lowest priority for the allocation of energy.

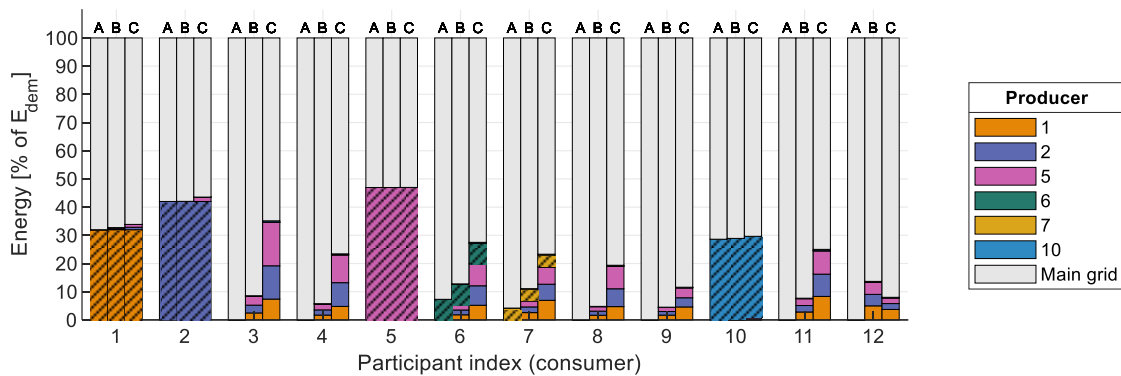

Fig. 9. Source of the electricity purchased by each consumer for scenarios A (without CSC), B (CSC with K1) and C (CSC with K2), expressed as a percentage of the total energy requested by the consumer (the hatched areas represent individual self-production and the top light grey bars purchase from the main grid)

382 In Fig. 10, the energy allocation is plotted from the opposite point of view. For each producer, the bar graph
 383 indicates the purchasers of generated energy. For several producers (1, 6, 7 and 10), individual self-consumption
 384 represents the main use of generated energy. It appears that participants 6 and 7 use almost all the energy they
 385 generate. Thus, their production is not useful for the CSC operation. The results presented on this graph also
 386 show that purchase from the hydrogen producer (participant 12) represents a significant part of the energy sold to
 387 the CSC operation by the producers when the default repartition key is applied (scenario B), since this
 388 participant has the highest energy demand. This rate is reduced when the optimized key is applied (scenario C).
 389 Finally, it can be seen that for producers 2 and 5, the integration into a CSC operation has a positive effect in
 390 terms of energy use because most of the power they generate is allocated to CSC participants. Regardless of the

391 repartition key, the integration into a CSC operation allows all producers to avoid sale to the main grid, thereby
 392 avoiding sale at a low price.

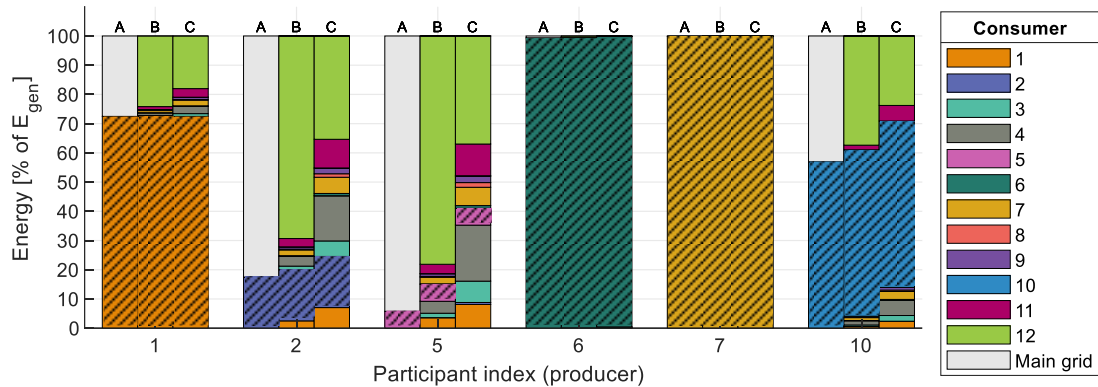

Fig. 10. Use of the energy sold by each producer for each scenarios A (without CSC), B (CSC with K1) and C (CSC with K2), expressed as percentage of the total energy generated by a producer (the hatched areas represent individual self-consumption and the top light grey bars sale to the main grid)

393 The energy allotments shown in the graphs previously discussed have consequences on economic results.
 394 Savings on the electricity purchase bill for each participant and each scenario are shown in Fig. 11. For several
 395 participants with a producer role (1, 2, 5 and 10), the savings are high, between 25% and 40%, mainly due to the
 396 large amount of individually self-consumed energy (Fig. 9). These results show that for most of the participants,
 397 the optimized repartition key (scenario C) allows purchase bill savings to be increased compared to the case
 398 without CSC (scenario A) or with CSC governed by the default key (scenario B), as some consumers receive
 399 more energy from the CSC operation. As can be seen in Fig. 9, the optimized key leads to lower savings for
 400 participant 12 as less local energy is allocated to this consumer (scenario C).

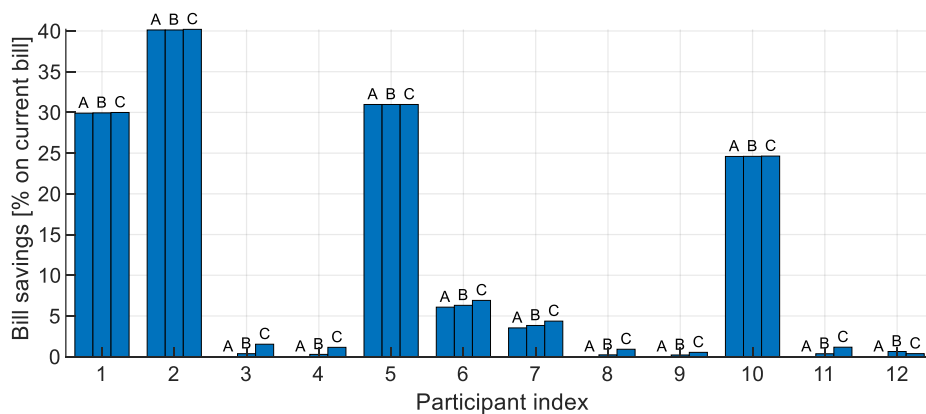

Fig. 11. Electricity purchase bill savings for each participant and each scenario, compared to a case without PV production

401 The payback period expected for participants who play a producer role is given in Fig. 12 for each scenario.
 402 The values obtained show that integration into a CSC operation is only interesting for the producers if an
 403 optimized repartition key is applied (scenario C). Indeed, if the default key is considered (scenario B), producers

404 will potentially have to sell energy to low purchase-price consumers, sometimes ones on a lower tariff than the
 405 main grid (for example to the participant 12). This lengthens the payback period, mainly for participants 2 and 5.
 406 The proposed repartition key based on maximization of producer income allows profitability for the producers to
 407 be improved. Thus, the payback periods obtained for scenario C are shorter than those obtained only with
 408 individual self-consumption (scenario A), which could foster the integration into such a CSC operation of
 409 participants who have PV panels.

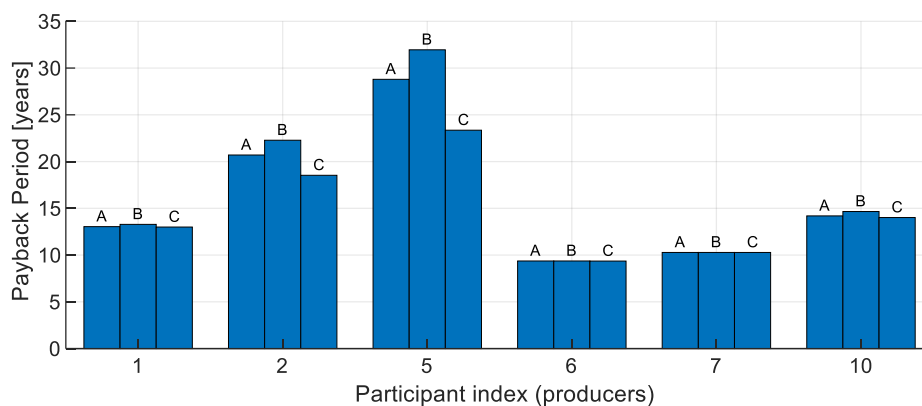

Fig. 12. Payback period for the participants with a producer role, for each scenario

410 Finally, in Table 4 the performances of the three scenarios are compared from the point of view of the whole
 411 CSC operation. The results for the considered case study show that a CSC operation allows the generated energy
 412 to be fully used in the industrial area, as no surplus is sold to the main grid, mainly due to the presence of a
 413 hydrogen producer which represents a high load demand. Moreover, the self-sufficiency rate of the community is
 414 doubled with a CSC operation. From the economic point of view, it can be seen that purchase bill savings are
 415 improved with a CSC operation. However, an optimized repartition key is needed and preferable for the
 416 profitability of producers (scenario C), since with the non-optimized key, energy is allocated regardless of the
 417 purchase cost, resulting in a decrease of income, thus a worse payback period (scenario B).

418

Table 4: Results at the scale of the CSC operation

Criterion	Scenario A	Scenario B	Scenario C
Self-consumption [% of generated energy used by CSC consumers]	51.35	100	100
Self-sufficiency [% of energy needed supplied by CSC producers]	9.27	18.06	18.06
Purchase bill savings [% of current bill]	-11.3	-11.64	-11.72
Payback period [years]	19.94	20.33	19.49

419

420 The results obtained in this study confirm the trends observed in several publications (Albouys-Perrois et al.,
421 2022; de Villena et al., 2022; Mustika et al., 2022b), namely an improvement of the self-consumption and the
422 self-sufficiency rates and an increase of the bill savings by joining a CSC operation, considering a repartition key
423 based on energy criteria (scenario B). However, the optimized repartition key proposed in this paper allows these
424 results to be improved by allocating the energy in a way that maximizes the income (scenario C). Also, this study
425 considers the profitability as an evaluation criterion, unlike past studies. The optimized repartition key proposed
426 here makes it possible to reduce the payback period, therefore the profitability is improved for the producers,
427 unlike scenario B (energy prorata rules) in which the profitability is not an objective.

428

429 *4.3. Sensitivity analysis concerning economic assumptions*

430 The results analysed in the previous section were based on economic assumptions, considering the most likely
431 case according to current regulations, i.e. with a local price just below the current purchase price ($\alpha_p = 0.95$) and
432 no exemption of the grid use tariff ($\beta_{gr} = 1$). However, these parameters could have a significant influence on
433 benefits for participants and the profitability of investments made by the producers. It has to be noted that the
434 current regulations are under discussion to state whether the grid use tariff could be decreased in the case of a
435 CSC operation, as this does not use the same portion of the grid as a situation without CSC. To quantify this
436 influence, a sensitivity analysis performed on these parameters is described in this section, assuming that the K2
437 optimized repartition key is applied.

438 The purchase bill savings the participants obtain by integrating into the CSC operation depends on the price
439 reduction coefficient α_p described in (19). Thus, the sensitivity of the electricity bill savings of each participant
440 to the local tariff coefficient α_p is proposed in Fig. 13, considering a CSC purchase price from -25% to +25%
441 compared to the current purchase price ($0.75 \leq \alpha_p \leq 1.25$). It should be noted that $\alpha_p > 1$ means that the
442 electricity purchased from CSC operation producers is more expensive than that purchased from the main grid,
443 which is favourable for the producers to improve profitability. The curves obtained show that a variation from
444 $\alpha_p = 0.95$ to $\alpha_p = 0.75$ helps purchase bill savings to be increased, but the gain is low. However, the impact is
445 more pronounced and disadvantageous when energy price is increased ($\alpha_p > 1$), meaning that it is less
446 interesting for the participants to integrate into a CSC operation, especially those who are only consumers.
447 Indeed, the bill of such participants is increased (negative savings values). From the global point of view (i.e. the

448 whole CSC operation), the bill savings are between 13.3% (for $\alpha_p = 0.75$) and 9.2% (for $\alpha_p = 1.25$), thus the
 449 CSC operation remains beneficial even if the savings decrease when the price coefficient is increased.

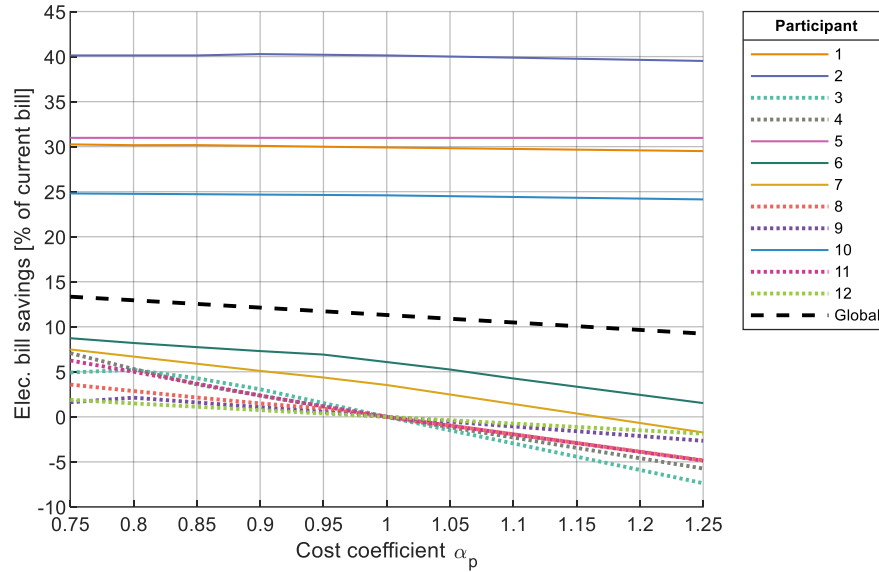

Fig. 13. Sensitivity of the electricity purchase bill savings to the parameter α_p related to the CSC electricity purchase price (dotted lines represents the participants with a consumer role, continuous lines the participants with a dual producer and consumer role, dashed line the saving for the whole CSC operation)

450

451 The profitability of the investments made by the producers depends on both economic parameters α_p and β_{gr} .
 452 Indeed, in the case of a grid tariff exemption ($\beta_{gr} < 1$), the supply cost $c_{p,l,sp,i}$ of the electricity purchased by a
 453 consumer i from a CSC operation producer can be increased to reach the total price set according to the
 454 coefficient α_p . Thus, the sensitivity to the economic parameters α_p and β_{gr} of the payback period expected for
 455 each producer is presented in Fig. 14. Three cases are considered for the grid use tariff: no exemption ($\beta_{gr} = 1$,
 456 as in the baseline scenario), half-exemption ($\beta_{gr} = 0.5$) and full exemption ($\beta_{gr} = 0$). The results obtained show
 457 that the choice of economic parameter values mainly impacts four participants (1, 2, 5 and 10). An exemption of
 458 the grid use tariff could help decrease the payback period by several years, while maintaining an interesting tariff
 459 for the consumers ($\alpha_p < 1$). Otherwise, without exemption, the only solution for an improvement of the
 460 profitability of producers' investments is an increase of the purchase price for the consumers, to a value higher
 461 than the price set for purchase from the main grid ($\alpha_p > 1$). However, this solution is not advisable for the
 462 consumers. Thus, the results presented in Fig. 13 and Fig. 14 show that a trade-off must be found between the
 463 savings of the participants and the payback period of the producers, depending on the choice of the price
 464 coefficient α_p and considering a possible exemption of the grid use tariff β_{gr} .

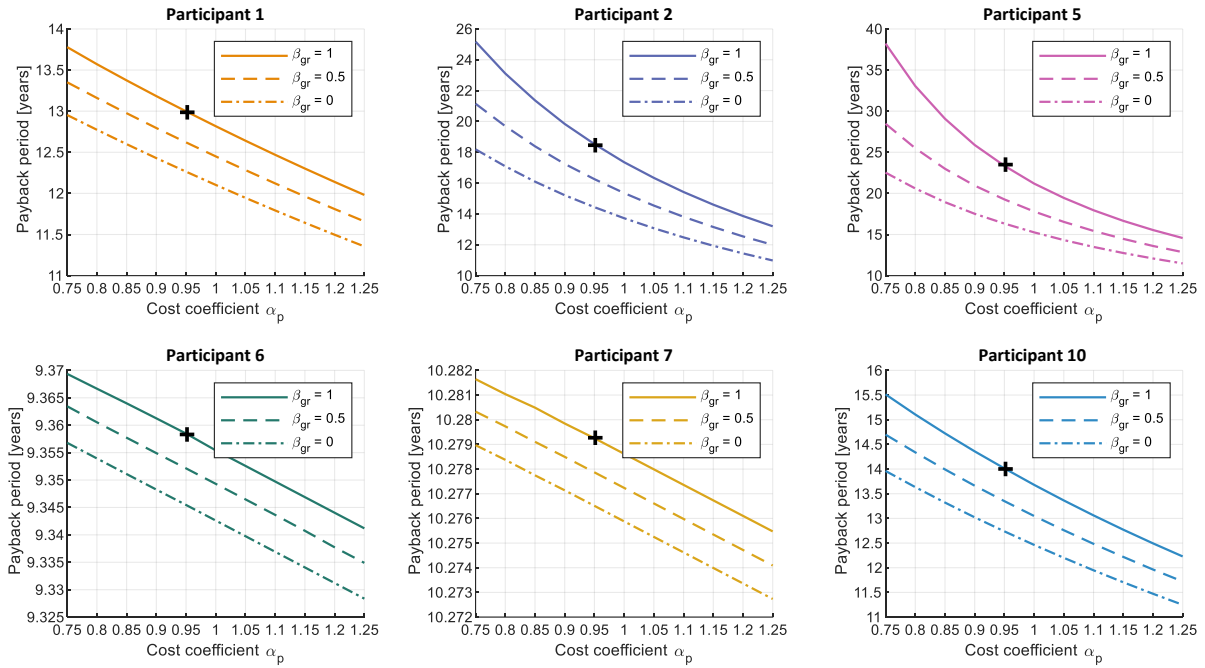

Fig. 14. Sensitivity of the payback period to economic parameters α_p and β_{gr} for the participants with a producer role (marker indicates the results of the baseline scenario discussed in section 4.2)

465

466 5. Conclusion

467 In this paper, a comparison of possible schemes for a CSC operation in a multi-energy microgrid has been
 468 presented. An optimized repartition key has been designed to maximize the income for producers, while the
 469 default repartition key proposed by current regulations in force in France is based on an allocation prorate to the
 470 demand of the consumers. The analysis of the results obtained upon simulation shows that the energy allotment
 471 of the energy generated in the CSC operation is more favourable for more participants when the optimized key is
 472 computed, in terms of profitability for producers and purchase bill savings for consumers. Indeed, the default key
 473 can lead to less profitable results for producers as main consumers do not always show the highest purchase
 474 prices. Moreover, the participation of producers in a CSC operation is favourable in terms of energy use and sale,
 475 as the surplus of generated energy not consumed individually can be shared with neighbours instead of being
 476 sold to the main grid at a low price. The results show that the reduction in the payback period provided by the
 477 optimized repartition key is between several months and 5 years, compared to a case without CSC. Also, the
 478 community bill savings reach 11.7% when CSC with optimized key is considered. In a context of a multi-energy
 479 microgrid with needs of hydrogen production, a CSC operation seems to be an interesting marketing policy, as
 480 energy needs can be high, especially during the day, i.e. when an excess of generated power exists. The energy
 481 indicators of the community show that the self-sufficiency rate reaches 18.06% with CSC (compared to 9.27%

482 without CSC) and the self-consumption rate reaches 100% (compared to 51.35% without CSC). The sensitivity
483 analysis performed in this paper has shown that an exemption of the public grid use tariff (which is related to the
484 national distribution grid) could be beneficial for producers and could allow the purchase price of the consumers
485 to be decreased.

486 The study carried out in this work dealt with a French case study with the regulation in force in this country,
487 but the methodology proposed for the post allotment of excess energy generated could be applied to other case
488 studies in other countries, taking the local regulations into account. The methodology is also scalable since other
489 repartition keys can be proposed. Moreover, the positive trends observed concerning the optimized repartition
490 key and results related to the industrial and multi-energy context seem to be significant for similar trends in other
491 case studies. More profitable results can be expected given the upward trend in energy prices, as the CSC
492 operation allows consumers to avoid purchasing part of their energy needs from the main grid at a high price. It
493 can be noted that the PV sizing considered in this paper, therefore the PV penetration level, depends on the
494 characteristics of the participants and is constrained by the maximum total power set by the regulation (3 MW).
495 Several limitations can be identified for the implementation of the proposed approach in practical applications.
496 The establishment of a contract including all possible issues can be difficult. For example, the unavailability of
497 the measurements due to a dysfunction of the meters must be considered in the contract. Moreover, the
498 governance of a CSC operation requires a moral organizer to manage the community, which can be difficult to
499 find, as the companies and industries have sometimes no experience for such an energy community manager
500 role. Also, the participants must agree on the repartition key, but each of them may have different expectations.

501 Several perspectives of the work presented in this paper can be proposed. Firstly, it could be interesting to
502 study whether a better solution could exist considering the repartition of producers and consumers among several
503 CSC operations, to gather participants into smaller operations. Also, other repartition keys could be proposed, for
504 example prorate to the investments or by minimizing the gap between participants' bills savings. Moreover, the
505 impact of the repartition key and the economic assumptions, such as the grid use exemption and local electricity
506 purchase price, on the sizing optimization could be studied. The impact of the constraint related to the maximum
507 installed power could also be investigated. Finally, the integration of demand-side management into the energy
508 management strategies of each participant could be studied, to evaluate how the flexibility of consumer demand
509 could influence the results and, if necessary, how the repartition key should be modified.

510

511 **CRedit authorship contribution statement**

512 **Anthony Roy:** Conceptualization, Formal analysis, Investigation, Methodology, Software, Validation,
513 Visualization, Writing - original draft. **Jean-Christophe Olivier, François Auger, Bruno Auvity, Emmanuel**
514 **Schaeffer, Salvy Bourguet:** Conceptualization, Methodology, Supervision, Project administration, Funding
515 acquisition.

516 **Declarations of interest:** The authors declare that they have no known competing financial interests or personal
517 relationships that could have appeared to influence the work reported in this paper.

518 **Funding:** This research was funded by the French “Agence De l’Environnement et de la Maîtrise de l’Energie”
519 (ADEME), Grant n°19PLC0149.

520

521 **References**

- 522 Abada, I., Ehrenmann, A., Lambin, X., 2020a. Unintended consequences: The snowball effect of energy
523 communities. *Energy Policy* 143, 111597. <https://doi.org/10.1016/j.enpol.2020.111597>
- 524 Abada, I., Ehrenmann, A., Lambin, X., 2020b. On the Viability of Energy Communities. *The Energy Journal* 41.
525 <https://doi.org/10.5547/01956574.41.1.iaba>
- 526 Alaton, C., Contreras-Ocaña, J.E., Radiguès, P. de, Döring, T., Tounquet, F., 2020. Energy Communities: From
527 European Law to Numerical Modeling, in: 2020 17th International Conference on the European Energy
528 Market (EEM). <https://doi.org/10.1109/EEM49802.2020.9221869>
- 529 Albouys-Perrois, J., Sabouret, N., Haradji, Y., Schumann, M., Charrier, B., Reynaud, Q., Sempé, F., Inard, C.,
530 2022. Multi-agent simulation of collective self-consumption: Impacts of storage systems and large-scale
531 energy exchanges. *Energy and Buildings* 254, 111543. <https://doi.org/10.1016/j.enbuild.2021.111543>
- 532 Canova, A., Lazzeroni, P., Lorenti, G., Moraglio, F., Porcelli, A., Repetto, M., 2022. Decarbonizing residential
533 energy consumption under the Italian collective self-consumption regulation. *Sustainable Cities and*
534 *Society* 87, 104196. <https://doi.org/10.1016/j.scs.2022.104196>
- 535 Capper, T., Gorbacheva, A., Mustafa, M.A., Bahloul, M., Schwidtal, J.M., Chitchyan, R., Andoni, M., Robu, V.,
536 Montakhabi, M., Scott, I.J., Francis, C., Mbarira, T., Espana, J.M., Kiesling, L., 2022. Peer-to-peer,
537 community self-consumption, and transactive energy: A systematic literature review of local energy
538 market models. *Renewable and Sustainable Energy Reviews* 162, 112403.
539 <https://doi.org/10.1016/j.rser.2022.112403>
- 540 Carenco, J.-F., Chauvet, C., Edwige, C., Faucheux, I., Lastelle, J.-L., 2020. Délibération de la Commission de
541 régulation de l’énergie du 17 décembre 2020 portant projet de décision sur le tarif d’utilisation des
542 réseaux publics de distribution d’électricité (TURPE 6 HTA-BT). France.
- 543 Coignard, J., Debusschere, V., Moreau, G., Chollet, S., Caire, R., 2020. Distributed Resource Coordination in the
544 Context of European Energy Communities, in: 2020 IEEE Power Energy Society General Meeting
545 (PESGM). pp. 1–5. <https://doi.org/10.1109/PESGM41954.2020.9282075>
- 546 Contreras-Ocaña, J.E., Singh, A., Bésanger, Y., Wurtz, F., 2021. Integrated Planning of a Solar/Storage
547 Collective. *IEEE Transactions on Smart Grid* 12, 215–226. <https://doi.org/10.1109/TSG.2020.3020402>
- 548 Cosic, A., Stadler, M., Mansoor, M., Zellinger, M., 2021. Mixed-integer linear programming based optimization
549 strategies for renewable energy communities. *Energy* 237, 121559.
550 <https://doi.org/10.1016/j.energy.2021.121559>
- 551 de Villena, M.M., Aittahar, S., Mathieu, S., Boukas, I., Vermeulen, E., Ernst, D., 2022. Allocation of locally
552 generated electricity in renewable energy communities. arXiv:2009.05411 [cs, eess].
- 553 ENEDIS, 2019. Modalités de mise en oeuvre d’une opération d’autoconsommation collective.
- 554 European Council, 2014. Communication from the commission to the european parliament, the council, the
555 european economic and social committee and the committee of the regions - Energy prices and costs in
556 Europe.

557 European Union, 2019. Directive (EU) 2019/944 of the European Parliament and of the Council of 5 June 2019
558 on common rules for the internal market for electricity and amending Directive 2012/27/EU (Text with
559 EEA relevance.), OJ L.

560 European Union, 2018. Directive (EU) 2018/2001 of the European Parliament and of the Council of 11
561 December 2018 on the promotion of the use of energy from renewable sources (Text with EEA
562 relevance.), OJ L.

563 Fina, B., Auer, H., Friedl, W., 2019. Profitability of PV sharing in energy communities: Use cases for different
564 settlement patterns. *Energy* 189, 116148. <https://doi.org/10.1016/j.energy.2019.116148>

565 Fina, B., Monsberger, C., Auer, H., 2022. Simulation or estimation?—Two approaches to calculate financial
566 benefits of energy communities. *Journal of Cleaner Production* 330, 129733.
567 <https://doi.org/10.1016/j.jclepro.2021.129733>

568 French Government, 2017. Décret n° 2017-676 du 28 avril 2017 relatif à l'autoconsommation d'électricité et
569 modifiant les articles D. 314-15 et D. 314-23 à D. 314-25 du code de l'énergie, 2017-676.

570 Frieden, D., Tuerk, A., Antunes, A.R., Athanasios, V., Chronis, A.-G., d'Herbemont, S., Kirac, M., Marouço, R.,
571 Neumann, C., Pastor Catalayud, E., Primo, N., Gubina, A.F., 2021. Are We on the Right Track?
572 Collective Self-Consumption and Energy Communities in the European Union. *Sustainability* 13,
573 12494. <https://doi.org/10.3390/su132212494>

574 Frieden, D., Tuerk, A., Roberts, J., d'Herbemont, S., Gubina, A., 2019. Collective self-consumption and energy
575 communities: Overview of emerging regulatory approaches in Europe. H2020 funded project Compile.

576 Gjorgievski, V.Z., Cundeva, S., Georghiou, G.E., 2021. Social arrangements, technical designs and impacts of
577 energy communities: A review. *Renewable Energy* 169, 1138–1156.
578 <https://doi.org/10.1016/j.renene.2021.01.078>

579 Gjorgievski, V.Z., Cundeva, S., Markovska, N., Georghiou, G.E., 2022. Virtual net-billing: A fair energy sharing
580 method for collective self-consumption. *Energy* 254, 124246.
581 <https://doi.org/10.1016/j.energy.2022.124246>

582 Inês, C., Guilherme, P.L., Esther, M.-G., Swantje, G., Stephen, H., Lars, H., 2020. Regulatory challenges and
583 opportunities for collective renewable energy prosumers in the EU. *Energy Policy* 138, 111212.
584 <https://doi.org/10.1016/j.enpol.2019.111212>

585 IRENA, 2020. Electricity Storage Valuation Framework. International Renewable Energy Agency.

586 Javadi, M.S., Gough, M., Nezhad, A.E., Santos, S.F., Shafie-khah, M., Catalão, J.P.S., 2022. Pool trading model
587 within a local energy community considering flexible loads, photovoltaic generation and energy storage
588 systems. *Sustainable Cities and Society* 79, 103747. <https://doi.org/10.1016/j.scs.2022.103747>

589 Li, Y., Li, K., Yang, Z., Yu, Y., Xu, R., Yang, M., 2022. Stochastic optimal scheduling of demand response-
590 enabled microgrids with renewable generations: An analytical-heuristic approach. *Journal of Cleaner*
591 *Production* 330, 129840. <https://doi.org/10.1016/j.jclepro.2021.129840>

592 Li, Y., Wang, C., Li, G., Chen, C., 2021. Optimal scheduling of integrated demand response-enabled integrated
593 energy systems with uncertain renewable generations: A Stackelberg game approach. *Energy*
594 *Conversion and Management* 235, 113996. <https://doi.org/10.1016/j.enconman.2021.113996>

595 Lormeteau, B., 2022. Regulatory framework of collective self-consumption operations: Comparative study
596 France, Spain, Germany, in: *Local Energy Communities*. Routledge.

597 Menniti, D., Sorrentino, N., Pinnarelli, A., Mendicino, S., Vizza, P., Polizzi, G., 2020. A blockchain based
598 incentive mechanism for increasing collective self-consumption in a nonsumer community, in: *2020*
599 *17th International Conference on the European Energy Market (EEM)*. pp. 1–6.
600 <https://doi.org/10.1109/EEM49802.2020.9221899>

601 Mustika, A.D., Rigo-Mariani, R., Debusschere, V., Pachurka, A., 2022a. New Members Selection for the
602 Expansion of Energy Communities. *Sustainability* 14, 11257. <https://doi.org/10.3390/su141811257>

603 Mustika, A.D., Rigo-Mariani, R., Debusschere, V., Pachurka, A., 2022b. A two-stage management strategy for
604 the optimal operation and billing in an energy community with collective self-consumption. *Applied*
605 *Energy* 310, 118484. <https://doi.org/10.1016/j.apenergy.2021.118484>

606 Perger, T., Auer, H., 2022. Dynamic participation in local energy communities with peer-to-peer trading.
607 <https://doi.org/10.12688/openreseurope.14332.1>

608 Perger, T., Wachter, L., Fleischhacker, A., Auer, H., 2021. PV sharing in local communities: Peer-to-peer
609 trading under consideration of the prosumers' willingness-to-pay. *Sustainable Cities and Society* 66,
610 102634. <https://doi.org/10.1016/j.scs.2020.102634>

611 Pilz, M., Al-Fagih, L., 2019. Recent Advances in Local Energy Trading in the Smart Grid Based on Game-
612 Theoretic Approaches. *IEEE Transactions on Smart Grid* 10, 1363–1371.
613 <https://doi.org/10.1109/TSG.2017.2764275>

614 Pole Mer Bretagne Atlantique, 2021. Maritime ports, infrastructure and transport - ESTUAIRE : Researching a
615 multi-energy, multi-use smart grid for a port district [WWW Document]. URL <https://www.pole-mer->

616 bretagne-atlantique.com/en/maritime-ports-infrastructure-and-transport/project/2577 (accessed
617 3.15.21).

618 Reis, I., Gonçalves, I., Lopes, M., Antunes, C., 2022a. Collective self-consumption in multi-tenancy buildings—
619 To what extent do consumers’ goals influence the energy system’s performance? *Sustainable Cities and*
620 *Society* 80, 103688. <https://doi.org/10.1016/j.scs.2022.103688>

621 Reis, I., Gonçalves, I., Lopes, M., Antunes, C., 2022b. Towards inclusive community-based energy markets: A
622 multiagent framework. *Applied Energy* 307, 118115. <https://doi.org/10.1016/j.apenergy.2021.118115>

623 Reis, I., Gonçalves, I., Lopes, M., Antunes, C., 2021. Assessing the Influence of Different Goals in Energy
624 Communities’ Self-Sufficiency—An Optimized Multiagent Approach. *Energies* 14, 989.
625 <https://doi.org/10.3390/en14040989>

626 Roy, A., Olivier, J.-C., Auger, F., Auvity, B., Schaeffer, E., Bourguet, S., Schiebel, J., Perret, J., 2021. A
627 combined optimization of the sizing and the energy management of an industrial multi-energy
628 microgrid: Application to a harbour area. *Energy Conversion and Management: X* 100107.
629 <https://doi.org/10.1016/j.ecmx.2021.100107>

630 Sousa, T., Soares, T., Pinson, P., Moret, F., Baroche, T., Sorin, E., 2019. Peer-to-peer and community-based
631 markets: A comprehensive review. *Renewable and Sustainable Energy Reviews* 104, 367–378.
632 <https://doi.org/10.1016/j.rser.2019.01.036>

633 Stephant, M., Abbes, D., Hassam-Ouari, K., Labrunie, A., Robyns, B., 2021. Distributed optimization of energy
634 profiles to improve photovoltaic self-consumption on a local energy community. *Simulation Modelling*
635 *Practice and Theory* 108, 102242. <https://doi.org/10.1016/j.simpat.2020.102242>

636 Van Cutsem, O., Ho Dac, D., Boudou, P., Kayal, M., 2020. Cooperative energy management of a community of
637 smart-buildings: A Blockchain approach. *International Journal of Electrical Power & Energy Systems*
638 117, 105643. <https://doi.org/10.1016/j.ijepes.2019.105643>

639 Viti, S., Lanzini, A., Minuto, F.D., Caldera, M., Borchiellini, R., 2020. Techno-economic comparison of
640 buildings acting as Single-Self Consumers or as energy community through multiple economic
641 scenarios. *Sustainable Cities and Society* 61, 102342. <https://doi.org/10.1016/j.scs.2020.102342>

642 Walker, G., Devine-Wright, P., 2008. Community renewable energy: What should it mean? *Energy Policy* 36,
643 497–500. <https://doi.org/10.1016/j.enpol.2007.10.019>

644

Variable	Definition	Unit
i	Participant index	-
k	Time index	-
J	Set of participants of the CSC operation	-
$c_{p,l,i}$	Cost of the electricity purchased from a producer of the CSC operation by a participant i	€/kWh
$c_{p,l,sp,i}$	Supply cost of the electricity purchased from a producer of the CSC operation by a participant i	€/kWh
$c_{p,l,gr,i}$	Grid use cost of the electricity purchased from a producer of the CSC operation by a participant i	€/kWh
$c_{p,l,tax,i}$	Taxes cost of the electricity purchased from a producer of the CSC operation by a participant i	€/kWh
$c_{p,m,i}$	Cost of the electricity purchased from the main grid by a participant i	€/kWh
$c_{p,m,sp,i}$	Supply cost of the electricity purchased from the main grid by a participant i	€/kWh
$c_{p,m,gr,i}$	Grid use cost of the electricity purchased from the main grid by a participant i	€/kWh
$c_{p,m,tax,i}$	Taxes cost of the electricity purchased from the main grid by a participant i	€/kWh
$C_{p,l,i}$	Expenses related to the purchase of electricity from the producers of the CSC operation over a given period	€
$C_{p,m,i}$	Expenses related to the purchase of electricity from the main grid over a given period	€
$C_{s,l,i}$	Income related to the sale of electricity to the consumers of the CSC operation over a given period	€
$C_{s,m,i}$	Income related to the sale of electricity to the main grid over a given period	€
K	Number of time samples of the simulated period	-
N_p	Number of participants	-
$P_{p,i}$	Total power requested (i.e. purchased) by a participant i	kW
$P_{p,l,i}$	Power requested from the CSC operation by a participant i	kW
$P_{p,m,i}$	Power requested from the main grid by a participant i	kW
$P_{s,i}$	Total power fed into (i.e. sold to) the grid by a participant i	kW
$P_{s,l,i}$	Power guaranteed to the CSC operation by a participant i	kW
$P_{s,m,i}$	Power guaranteed to the main grid by a participant i	kW
$\bar{P}_{p,t}$	Vector of decision variables of the energy sharing optimization problem	-
β_{gr}	Exemption rate of grid use cost for electricity purchased from a producer of the CSC operation	-
α_p	Ratio between the cost of electricity purchased from a producer of the CSC operation and the cost of electricity purchased from the main grid	-
Δt	Time step	h

Figure/Table	Caption	Size	Color
Fig. 1	Layout of the industrial microgrid of the considered CSC operation	Double column	Yes
Fig. 2	Scheme of energy and economic data flows between the entities of the CSC operation considered, according to French regulations	Single column	Yes
Fig. 3	Distribution of the power flows related to participant 1 for a case in which participant 1 sells energy (top scheme) and a case in which participant 1 purchases energy (bottom scheme)	Single column	Yes
Fig. 4	Calculation steps of the energy allocation algorithm	Double column	Yes
Fig. 5	CSC participants electricity purchase prices $c_{p,m,i}$ for a winter day	Single column	Yes
Fig. 6	CSC participants electricity purchase prices $c_{p,m,i}$ for a summer day	Single column	Yes
Fig. 7	Supply cost $c_{p,l,sp,i}$ of the local electricity purchase price for a winter day	Single column	Yes
Fig. 8	Supply cost $c_{p,l,sp,i}$ of the local electricity purchase price for a summer day	Single column	Yes
Fig. 9	Source of the electricity purchased by each consumer for scenarios A, B and C, expressed as a percentage of the total energy requested by the consumer	Double column	Yes
Fig. 10	Use of the energy sold by each producer for each scenarios A, B and C, expressed as percentage of the total energy generated by a producer	Double column	Yes
Fig. 11	Electricity purchase bill savings for each participant and each scenario, compared to a case without PV production	Double column	Yes
Fig. 12	Payback period for the participants with a producer role, for each scenario	Double column	Yes
Fig. 13	Sensitivity of the electricity purchase bill savings to the parameter α_p related to the CSC electricity purchase price	1.5 column	Yes
Fig. 14	Sensitivity of the payback period to economic parameters α_p and β_{gr} for the participants with a producer role	Single column	Yes
Table 1	Example of power allocation (the case when total power generated is lower than total power needed)	Double column	No
Table 2	Example of power allocation (the case when total power generated is greater than total power needed)	Double column	No
Table 3	Data of participants of the CSC operation	Single column	No
Table 4	Results at the scale of the CSC operation	Single column	No