



**HAL**  
open science

## **XRR-GIXRF combined characterization of Mg/Sc multilayer**

Hina Verma, Karine Le Guen, Yves Ménesguen, Renaud Delaunay,  
Marie-Christine Lépy, Philippe Jonnard

► **To cite this version:**

Hina Verma, Karine Le Guen, Yves Ménesguen, Renaud Delaunay, Marie-Christine Lépy, et al.. XRR-GIXRF combined characterization of Mg/Sc multilayer. EXRS 2022, European Conference on X-ray Spectrometry, Jun 2022, Bruges, Belgium. , 2022. hal-03936384

**HAL Id: hal-03936384**

**<https://hal.science/hal-03936384>**

Submitted on 24 Feb 2023

**HAL** is a multi-disciplinary open access archive for the deposit and dissemination of scientific research documents, whether they are published or not. The documents may come from teaching and research institutions in France or abroad, or from public or private research centers.

L'archive ouverte pluridisciplinaire **HAL**, est destinée au dépôt et à la diffusion de documents scientifiques de niveau recherche, publiés ou non, émanant des établissements d'enseignement et de recherche français ou étrangers, des laboratoires publics ou privés.



Distributed under a Creative Commons Attribution 4.0 International License

# XRR-GIXRF combined characterization of Mg/Sc multilayer

Hina Verma<sup>1</sup>, Karine Le Guen<sup>1</sup>, Yves Ménesguen<sup>2</sup>, Renaud Delaunay<sup>1</sup>, Marie-Christine Lépy<sup>2</sup>, Philippe Jonnard<sup>1</sup>

1. Sorbonne Université, Faculté des sciences et Ingénierie, UMR CNRS, Laboratoire de Chimie Physique – Matière et Rayonnement, 4 Place Jussieu, F-75252 Paris Cedex 05, France

2. CEA, LIST, Laboratoire National Henri Becquerel (LNE-LNHB), 91191 Gif-sur-Yvette cedex, France

## Motivation

Design of multilayer mirror as optical components for X-ray spectroscopy in the water window range

Water Window Range : C(285 eV) - O (530eV)

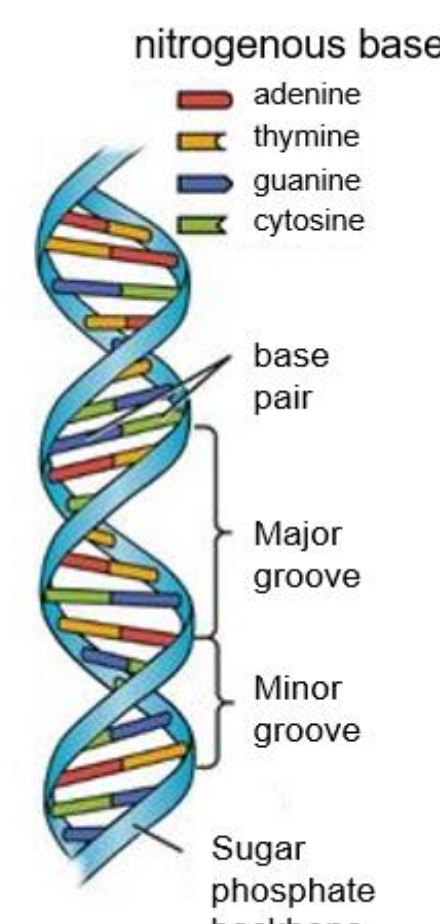
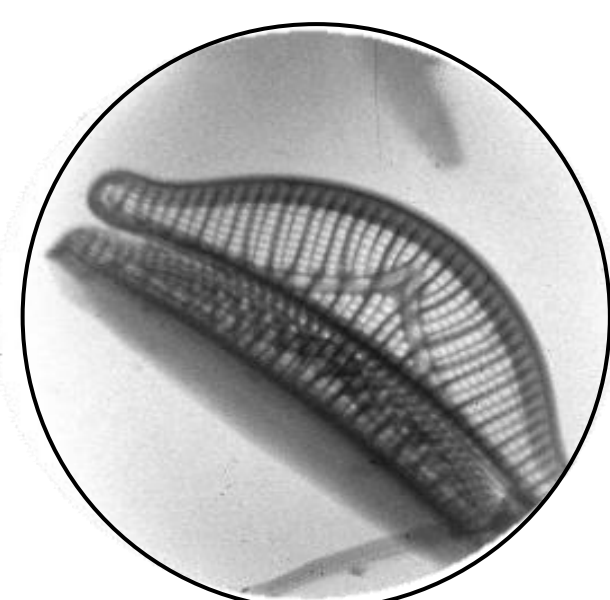
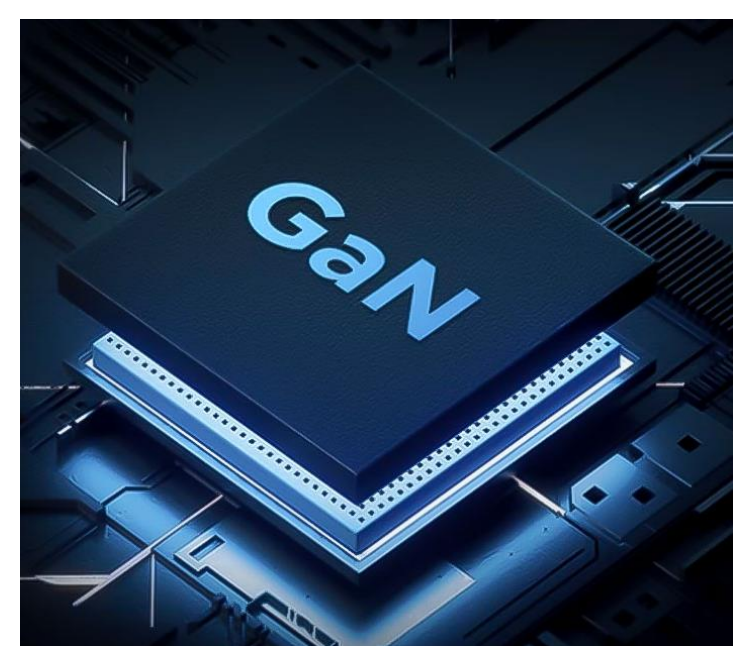
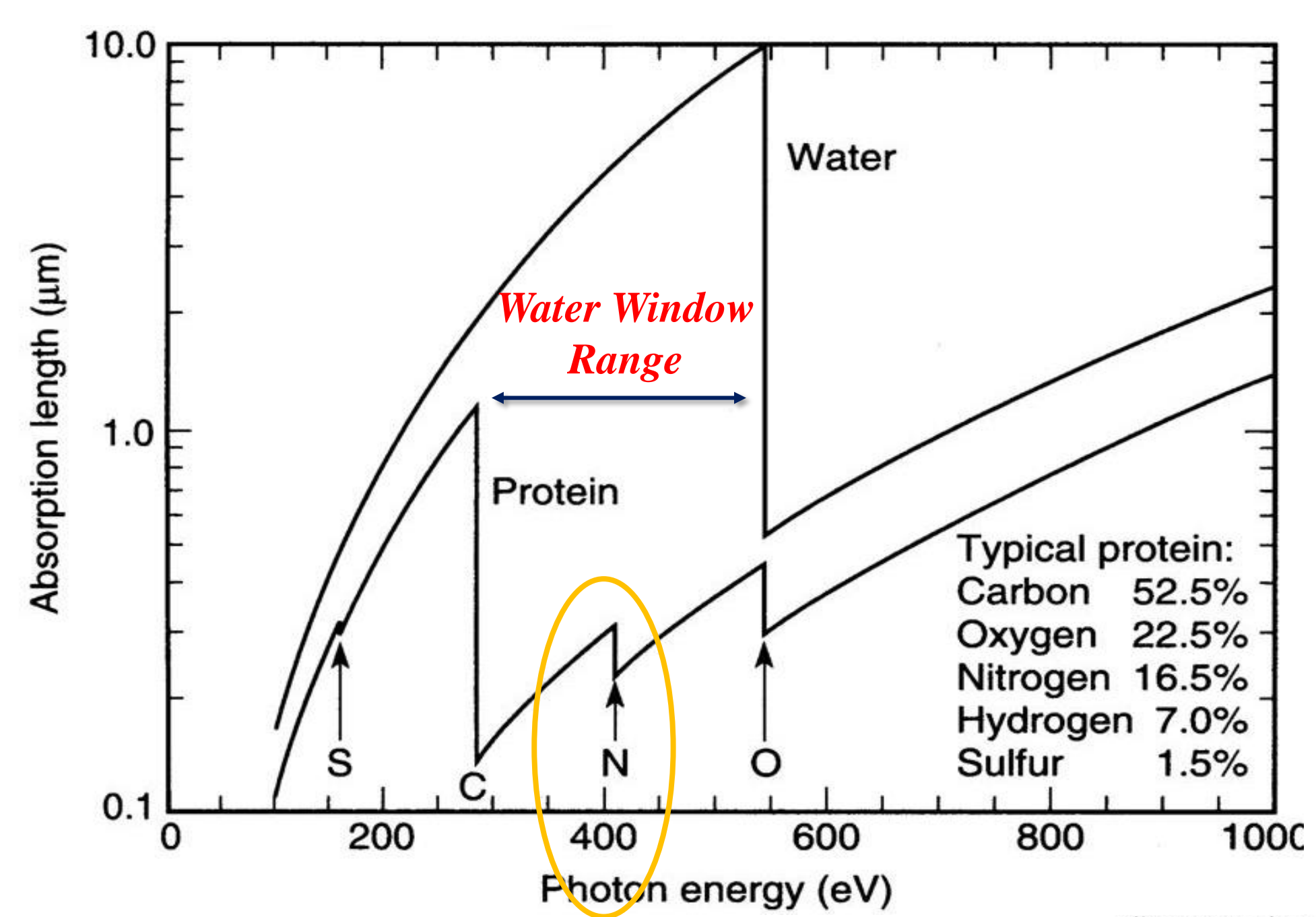

## Method of Analysis

CASTOR: Chambre d'Analyse spectrométrique en Transmission ou en Réflexion Metrologie Beamline, SOLEIL

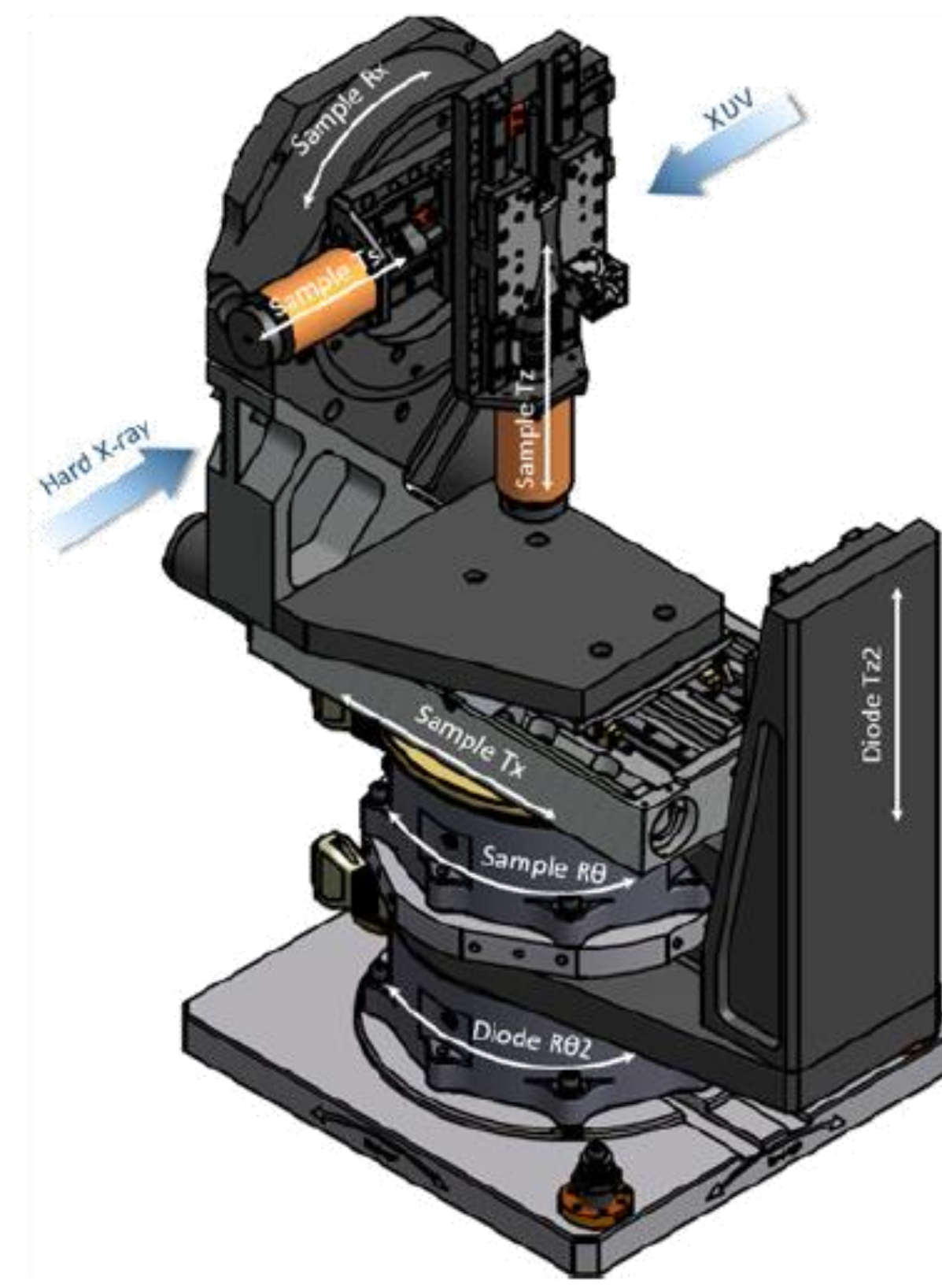

Seven-axis Goniometer

- ❖ Photodiode to record the XRR signal in a  $\theta$ - $2\theta$  configuration.
- ❖ Silicon drift detector (SDD), placed at  $90^\circ$  with respect to the incoming beam, to acquire the fluorescence one

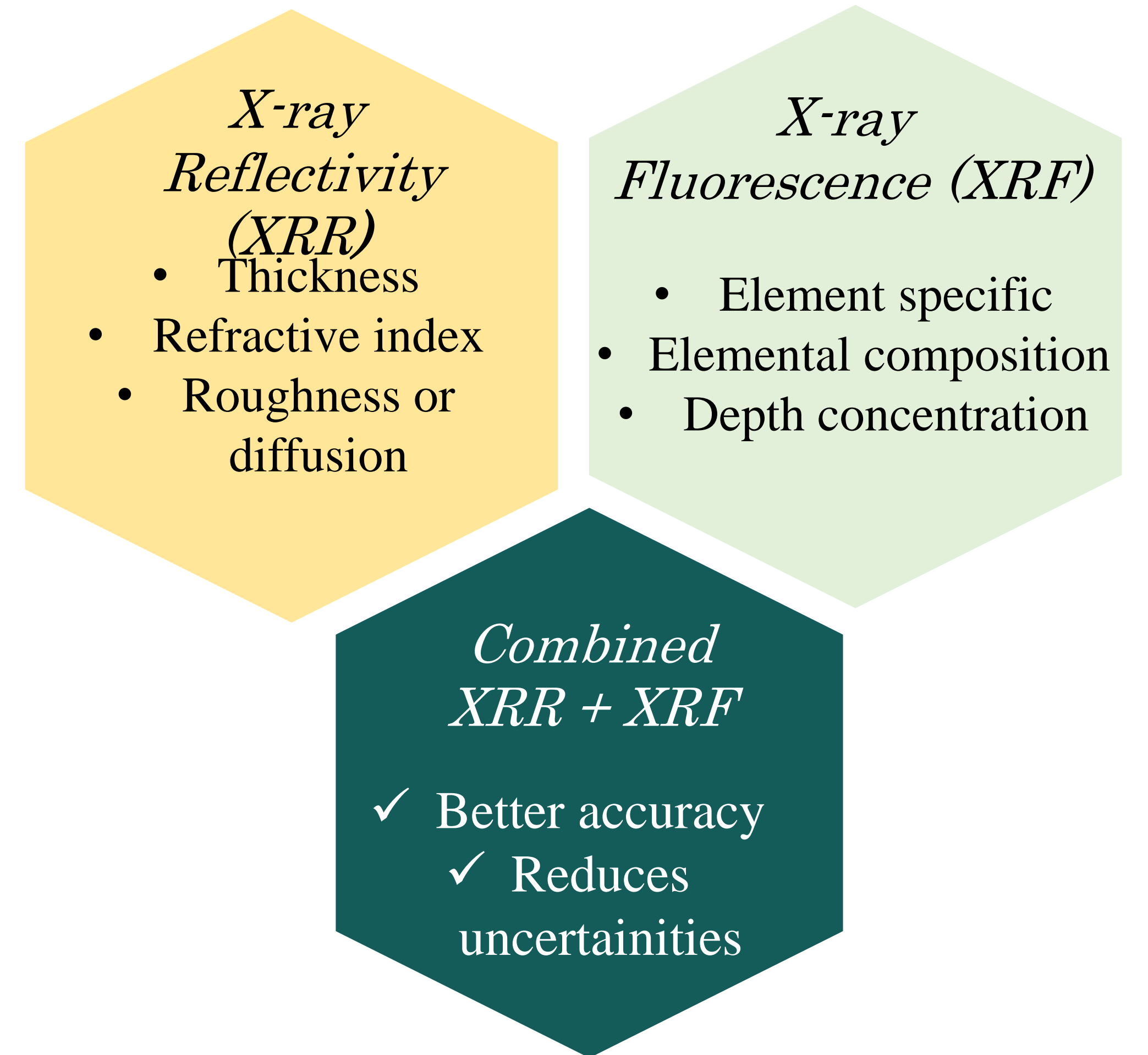

## Problem of Interfaces

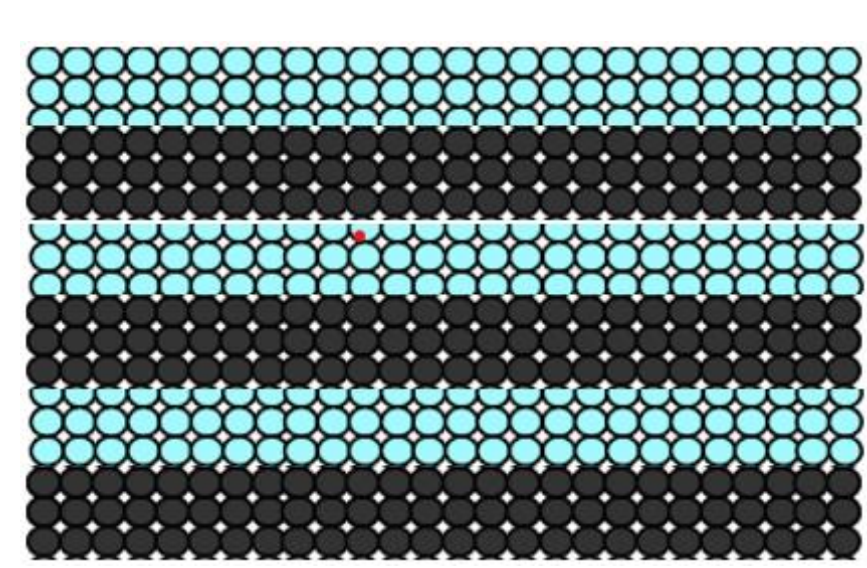

Perfect Interface

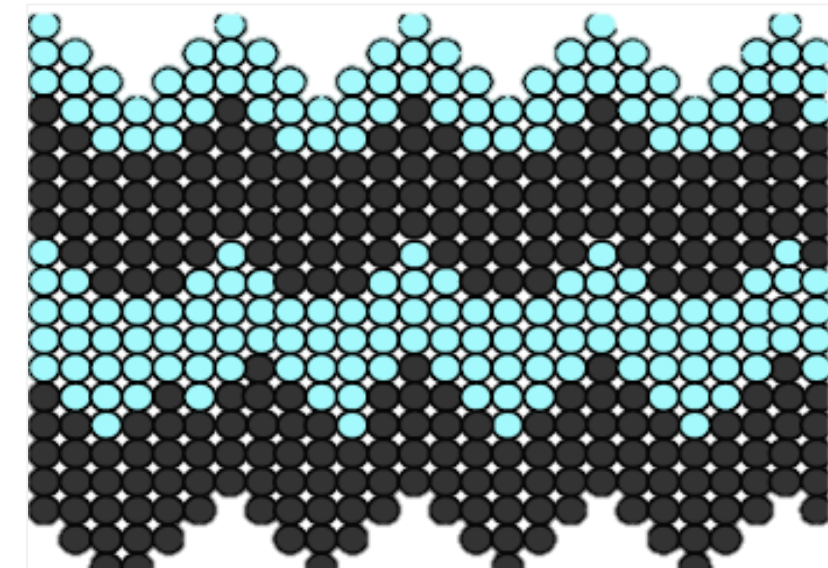

Rough Interface

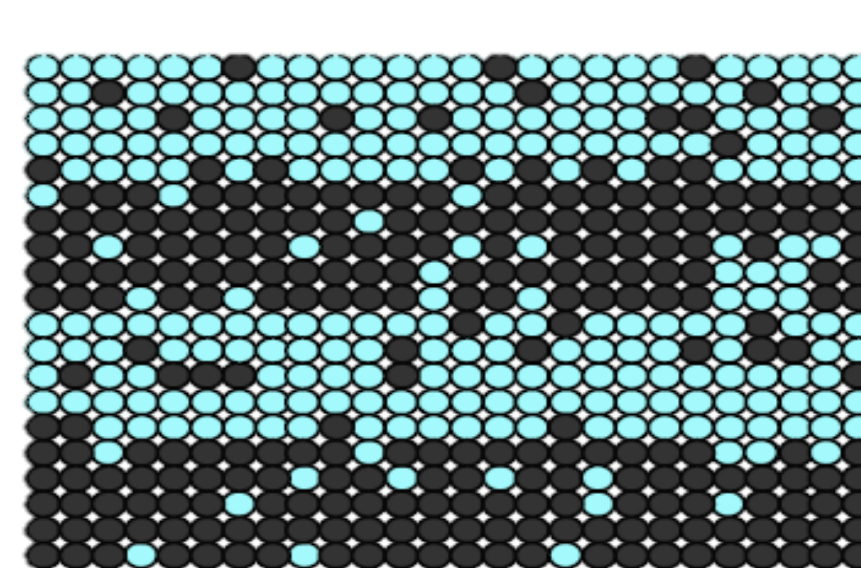

Diffused Interface

- *Mixing Enthalpy*
- *Method of Fabrication*
- *Stability of interfaces over time*
- *Free surface energy*

## Results

Fitted Structure:  $\text{CrO}_3/\text{Cr}_2\text{O}_3/\text{Mg}/\text{MgO}/\text{Si}$  substrate

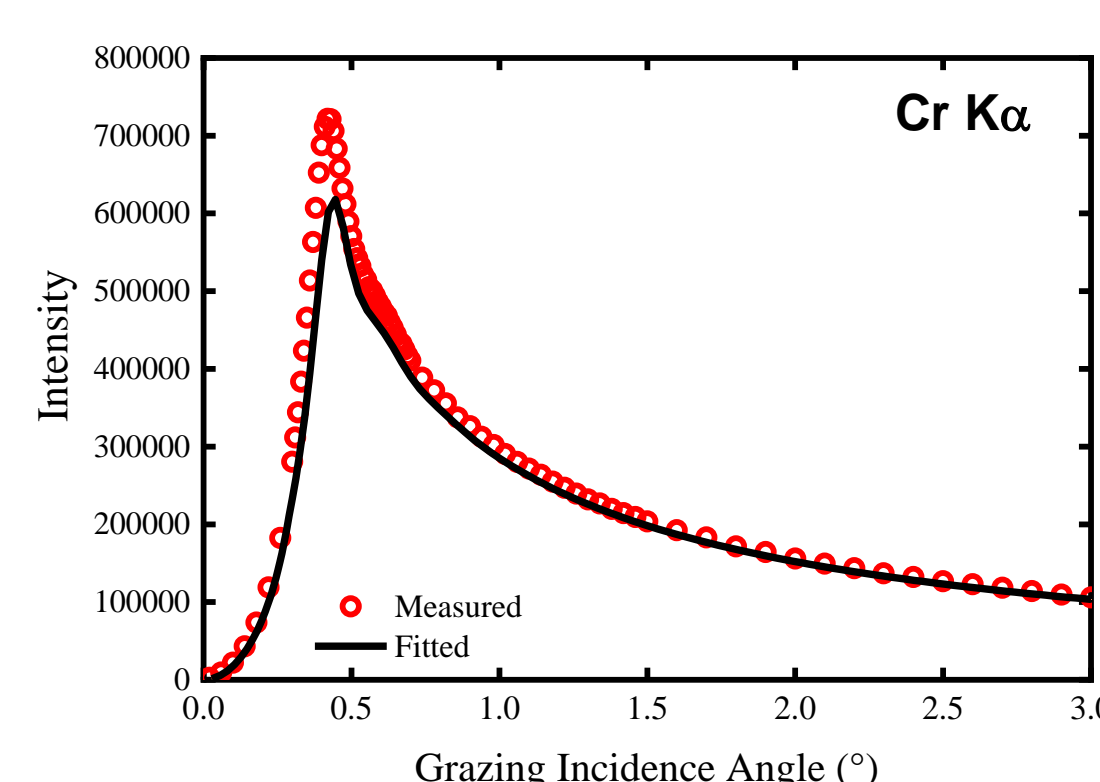
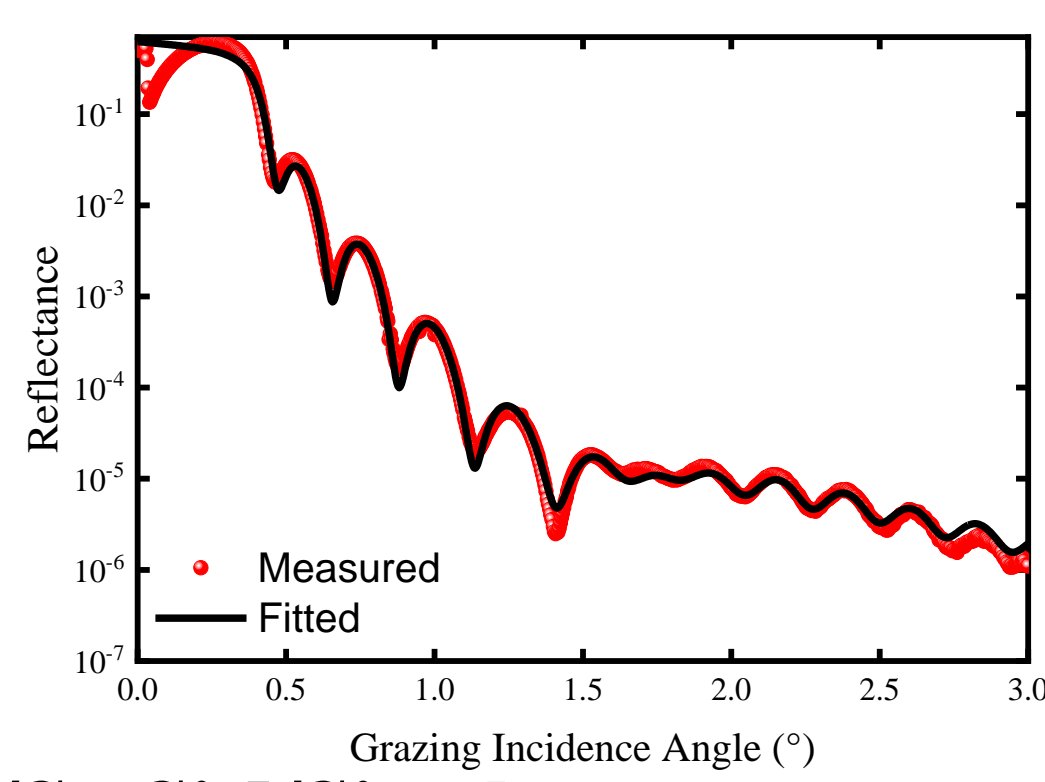

Fitted Structure:  $\text{CrO}_3/\text{Cr}_2\text{O}_3/\text{Sc}/\text{Sc}_x\text{Si}_y/\text{Si}$  substrate

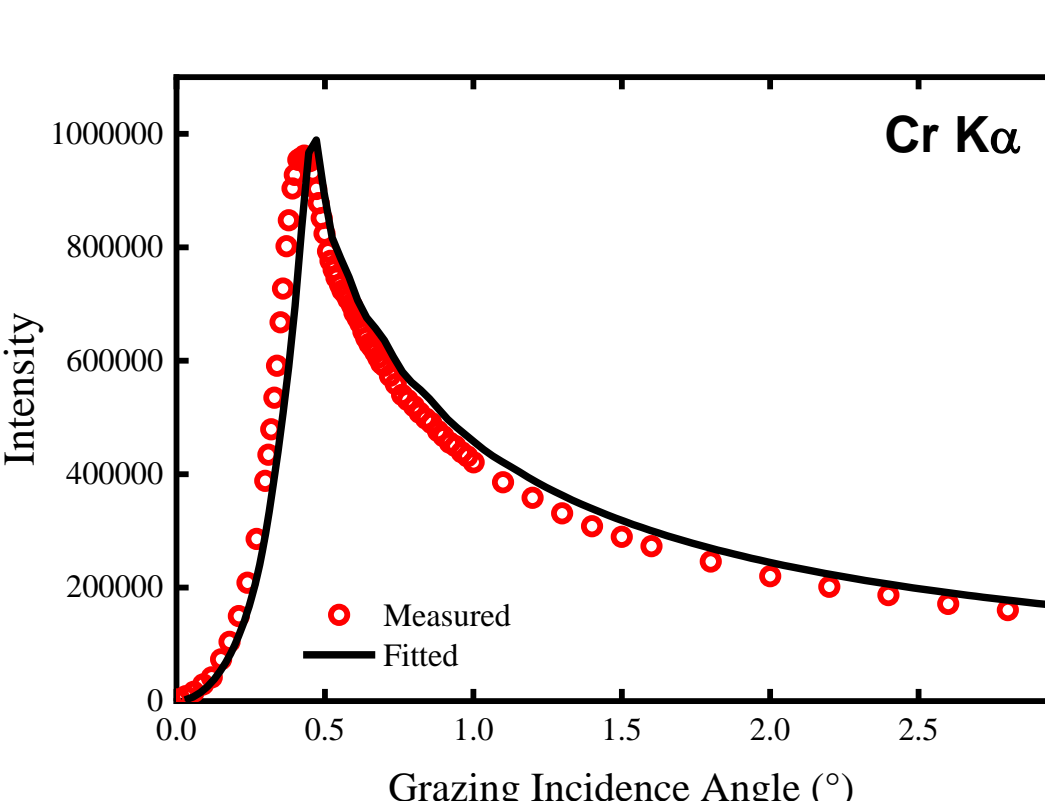
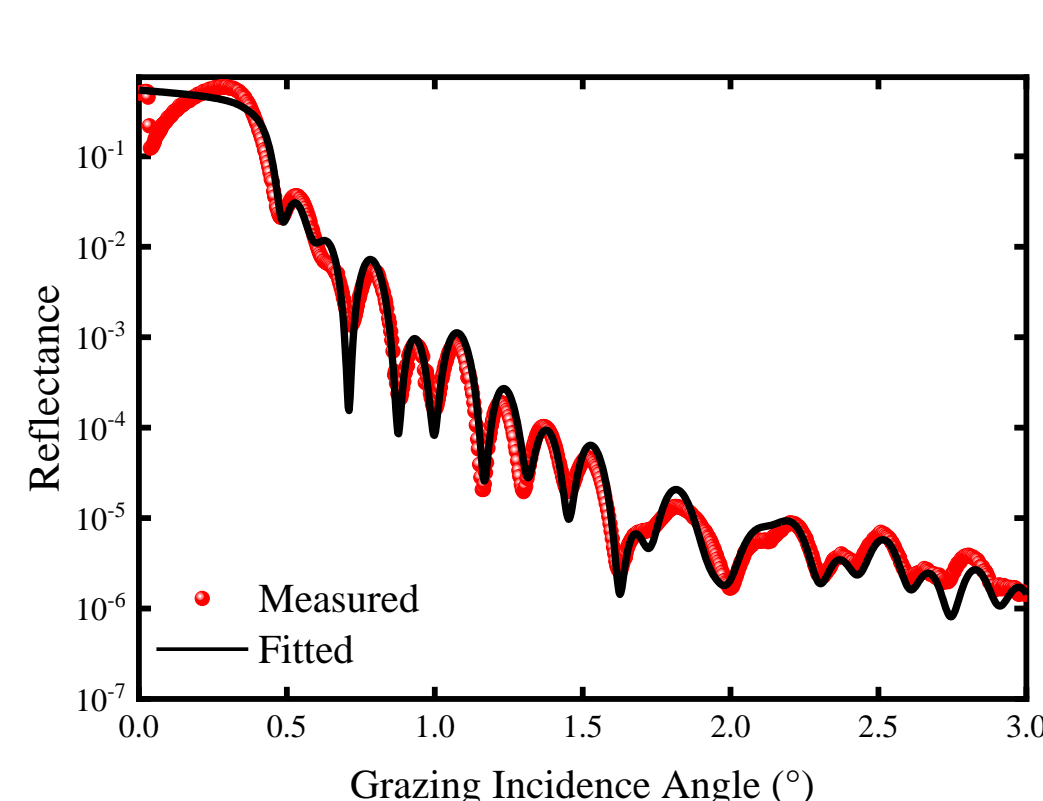

Fitted Structure:  $\text{CrO}_3/\text{Cr}_2\text{O}_3/\text{MgO}/\text{MgSc}/\text{Sc}/\text{Sc}_x\text{Si}_y/\text{Si}$  substrate

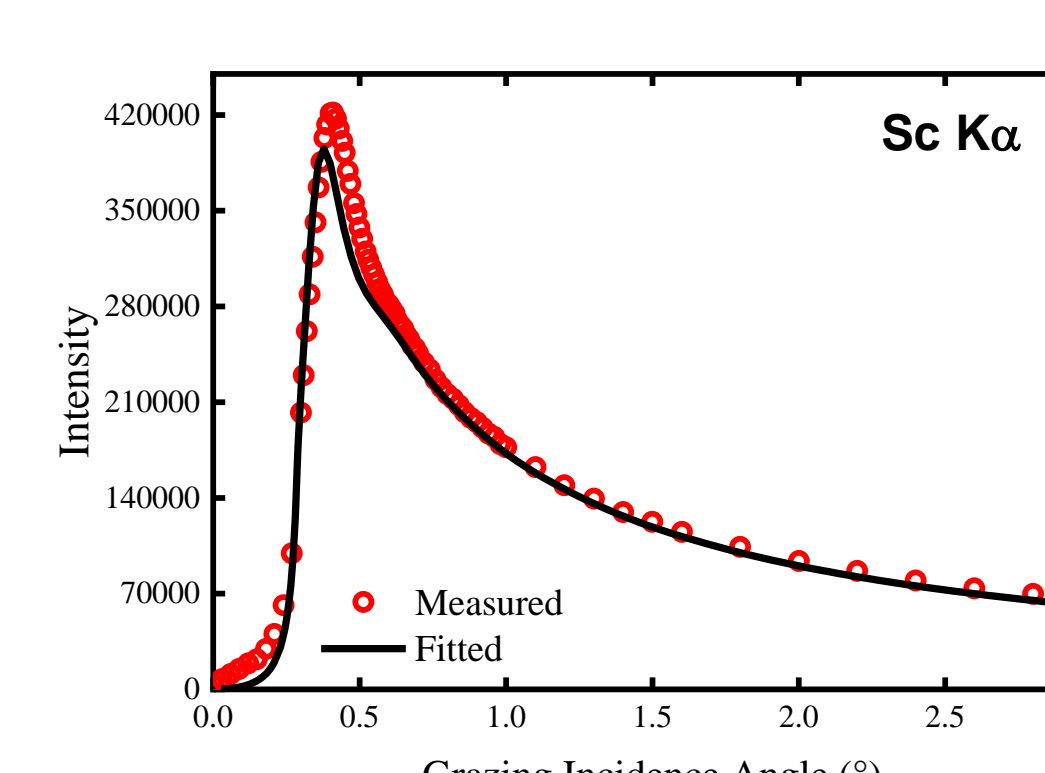
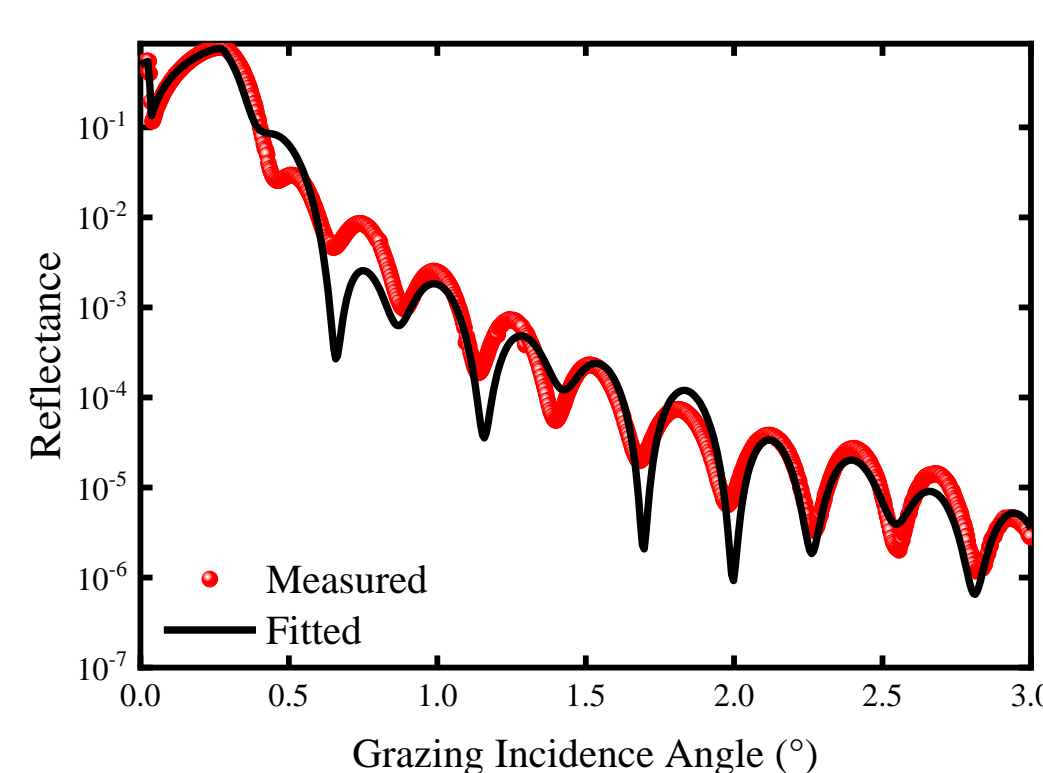

## Conclusion

