



HAL
open science

Curvature in tensegrity platforms for sea accessibility

I Hrazmi, Julien Averseng, Jérôme Quirant

► **To cite this version:**

I Hrazmi, Julien Averseng, Jérôme Quirant. Curvature in tensegrity platforms for sea accessibility. IASS/APCS 2022 - Innovation Sustainability and Legacy, International Association for Shell and Spatial Structures; Asian-Pacific Conference on Shell and Spatial Structures, Sep 2022, Beijing, China. hal-03936150

HAL Id: hal-03936150

<https://hal.science/hal-03936150>

Submitted on 12 Jan 2023

HAL is a multi-disciplinary open access archive for the deposit and dissemination of scientific research documents, whether they are published or not. The documents may come from teaching and research institutions in France or abroad, or from public or private research centers.

L'archive ouverte pluridisciplinaire **HAL**, est destinée au dépôt et à la diffusion de documents scientifiques de niveau recherche, publiés ou non, émanant des établissements d'enseignement et de recherche français ou étrangers, des laboratoires publics ou privés.

Curvature in tensegrity platforms for sea accessibility

I. HRAZMI^{*a}, J. AVERSENG^a, J. QUIRANT^a

^aLMGC, Univ. Montpellier, CNRS, Montpellier, France
issam.hrazmi@umontpellier.fr^{*a}

Abstract

Tensegrity structures are a class of space structures composed of compressed bars in equilibrium in a network of tensioned cables. Independently of the boundary conditions, their stability and stiffness depend both on the mechanical and geometrical properties of the elements as well as the pre-stress introduced during assembly, which is called self-stress state that can be determined using form finding methods. This study is a continuation of an ongoing project “Sea for All” aiming to investigate, develop and design sea accessibility platform solutions based on tensegrity structure which has led to a solution inspired by the “Tensarch” concept. Besides, another platform solution is being developed inspired by “Quadruplex” units with a modified geometry to form a rigid and stable upper layer either for straight or curved configurations all while ensuring lightweightness, esthetics, modularity and foldability. Each module is an assembly of two symmetrical and modified “Quadruplex” units with interlayer cables necessary to introduce selfstress state in the module for an optimal deployment for any modular configuration. Also, we will focus on curvature effect, selfstress state and support conditions of a platform on its stiffness through a parametric analysis.

Keywords: tensegrity, self-stress, accessibility platforms, curvature, folding/unfolding, supports, deck

1. Introduction

In this paper, we present a complimentary study to an ongoing project named “Sea for All” aiming to offer an innovative, lightweight, modular, foldable and environmentally friendly offshore platform solutions for sea accessibility for people of reduced mobility [1]. They are based on tensegrity systems that can be defined as selfstress spatial structures characterized by an equilibrium of tensile and compression [2,3]. In the absence of selfstress, some geometries can be foldable using their intrinsic mechanisms [4,5]. Such systems are subject to many developments applicable in the civil engineering field [6, 7].

Previous in-depth studies on “Tensarch” concept have led us to building and carrying experiments on a prototype in real conditions that proves the feasibility of such technology (Fig. 1) [8,9,10].

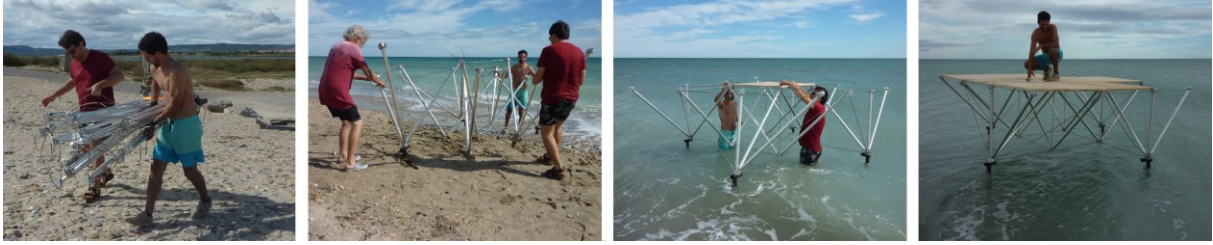

Figure 1: Deployment of a 9 m² “Tensarch” platform *in-situ*.

Considering the rectangular geometry of “Tensarch” topology that only offers to build modular platforms based on rectangular shapes, we aim in this paper to enrich this solution by exploring further topologies with the potential of curvature.

2. Elementary modules

Among tensegrity systems, modules with a polygonal base of n sides, with n bars and $3n$ cables have been the most studied (Fig. 1). They are formed by two layers of n cables each connected by n bars. Motro R. [4] has shown that these modules admit a self-stress state when the polygon of the upper layer forms an angle θ with the lower layer one, and which is solution of equation (1).

$$\theta = \pm \frac{\pi(n-2)}{2n} \quad (1)$$

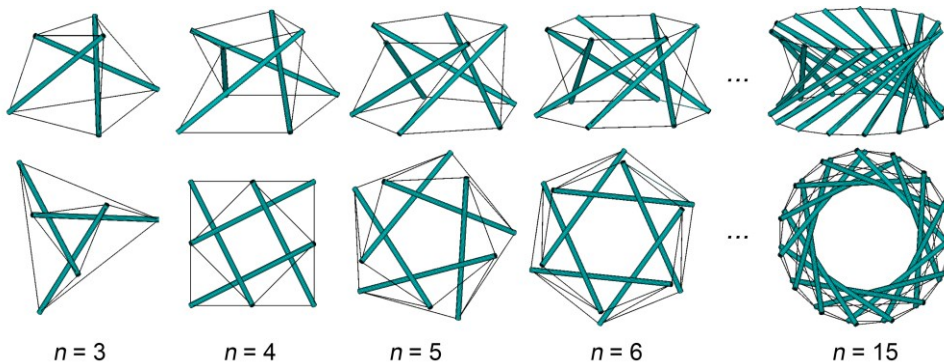

Figure 2: Different tensegrity modules with polygonal base.

3. Adapted topology

In order to create an elementary module capable of generating any curvature, we first assembled two symmetrical 4-bar modules, known as “Quadruplex” modules, whose geometry was adapted to increase the useful surface of the structure.

The transformation consists in widening in one direction the top layer by lengthening 2 bars of each module. Consequently, cables connected to the upper ends of the 2 bars are also lengthened (Fig. 3). This new topology is named “Biquadruplex”.

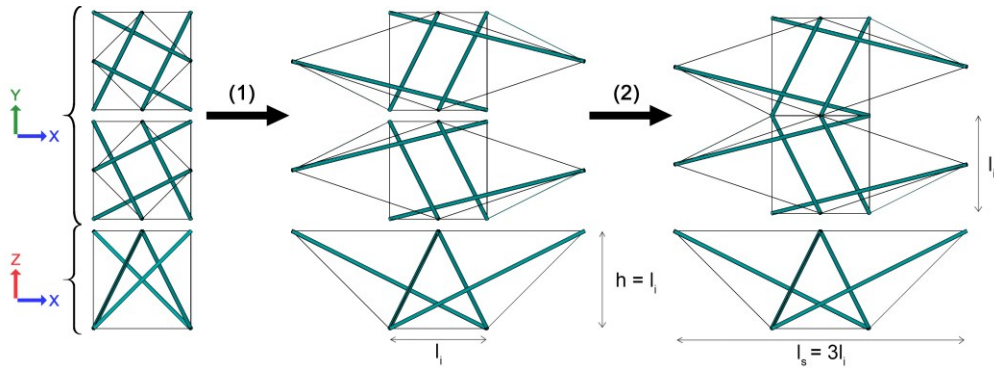

Figure 3: Assembly of “Biquadruplex” module from two symmetrical elementary modules:
 (1) Widening of the upper layer - (2) Fusion of the two modules.

Thus, “Biquadruplex” modules can be decomposed into 4 families of elements as shown in Fig. 4.

In order to build a “Biquadruplex” platform, modules are assembled together with a pair of brace system at both ends to complete the 4 corners of upper layer of supporting structure (Fig. 4).

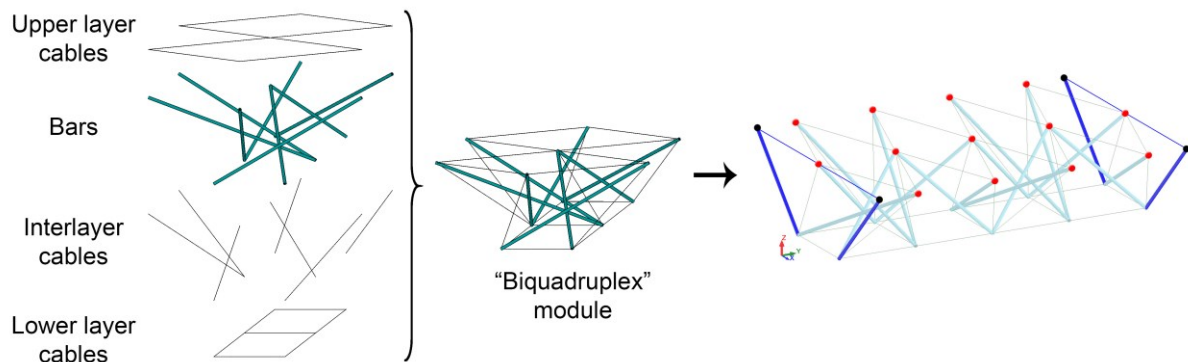

Figure 4: Decomposition of “Biquadruplex” module.

Deck elements are then fixed to upper layer nodes completing the platform useful surface, either straight or curved geometry (Fig. 5).

Given the arrangement of the upper layer nodes, we chose triangular mesh for deck elements everywhere except at the ends where extra nodes in the corners generate a quadrilateral geometry.

In the case of straight platforms, 3 deck geometries are possible (1 triangular + 2 quadrilateral) whereas curved platforms require 5 deck geometries (3 triangular + 2 quadrilateral) which all depend on the platform’s curvature (Fig. 5).

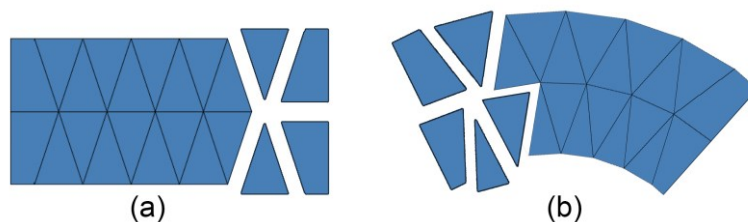

Figure 5: Different deck plates geometry for “Biquadruplex” platforms: (a) straight - (b) curved.

3.1. Folding kinematics

In absence of internal stress, especially when interlayer cables are inactivated, folding of the “Biquadruplex” structure becomes possible thanks to its V-shaped sets of bars. Fig. 6 shows 3 perpendicular projections of a potential trajectory of bars of “Biquadruplex” topology.

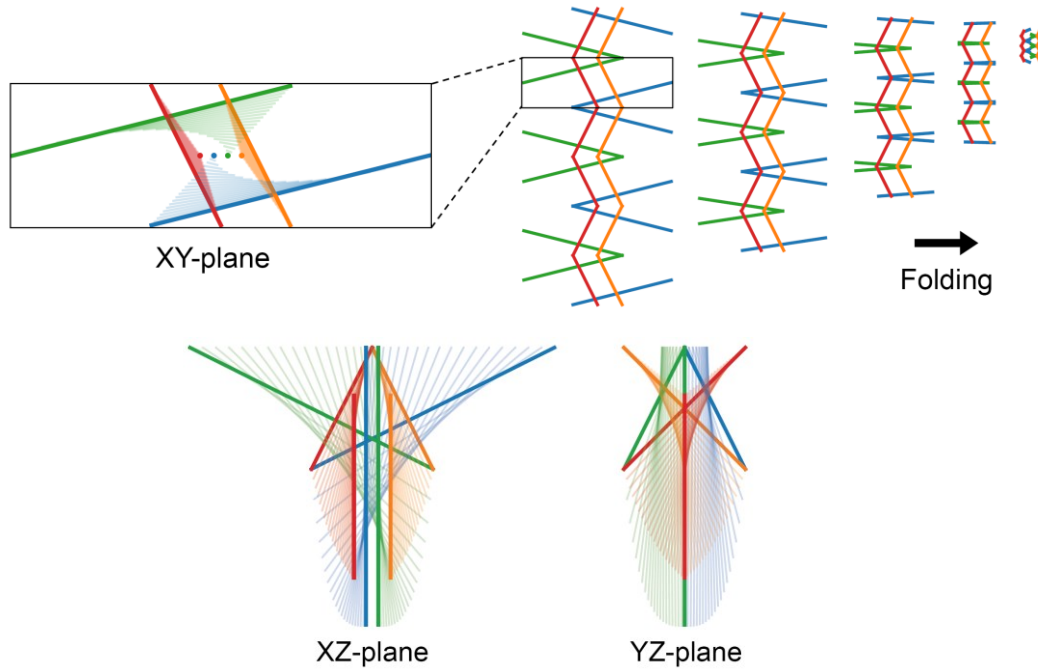

Figure 6: Folding kinematics of “Biquadruplex” topology.

3.2. Curvature

Thanks to the unidirectional topology of “Biquadruplex” concept, it’s also possible to introduce curvature in XY-plane by changing the length of different elements. Besides, for aesthetic reasons, we chose to maintain a proportional shape between curved and straight geometries, the angle θ between two lateral lower layer cables ($l_0 = 1$ m) is taken equal to l_0/R (Fig. 7).

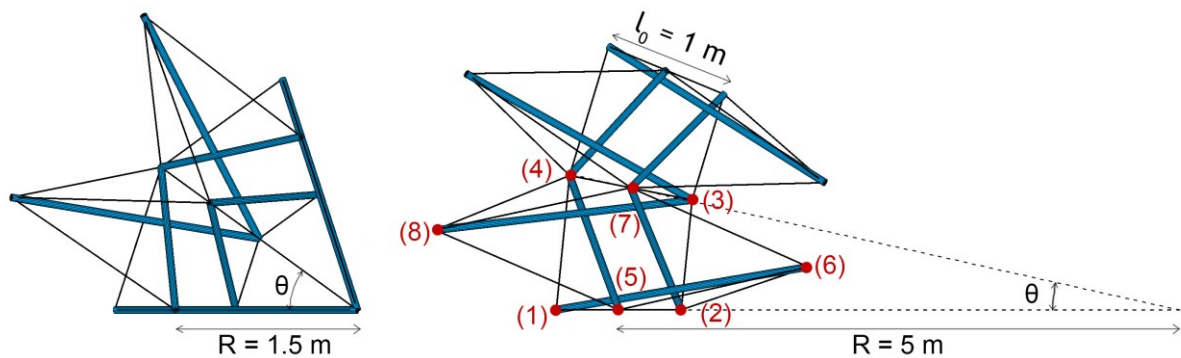

Figure 7: Curvature in “Biquadruplex” topology.

Compared to straight geometry, the variation of length ratio of different elements in function of the radius of curvature is given in the graphics below, where B_{ij} and C_{pq} are respectively the bar between nodes i and j and the cable between nodes p and q (Fig. 8).

Given small extension ratios that can be obtained for high radius of curvature, it shall be conceivable to technologically adjust elements length to achieve a certain curvature by equipping accordingly bars and cables respectively with shoring and turnbuckle systems.

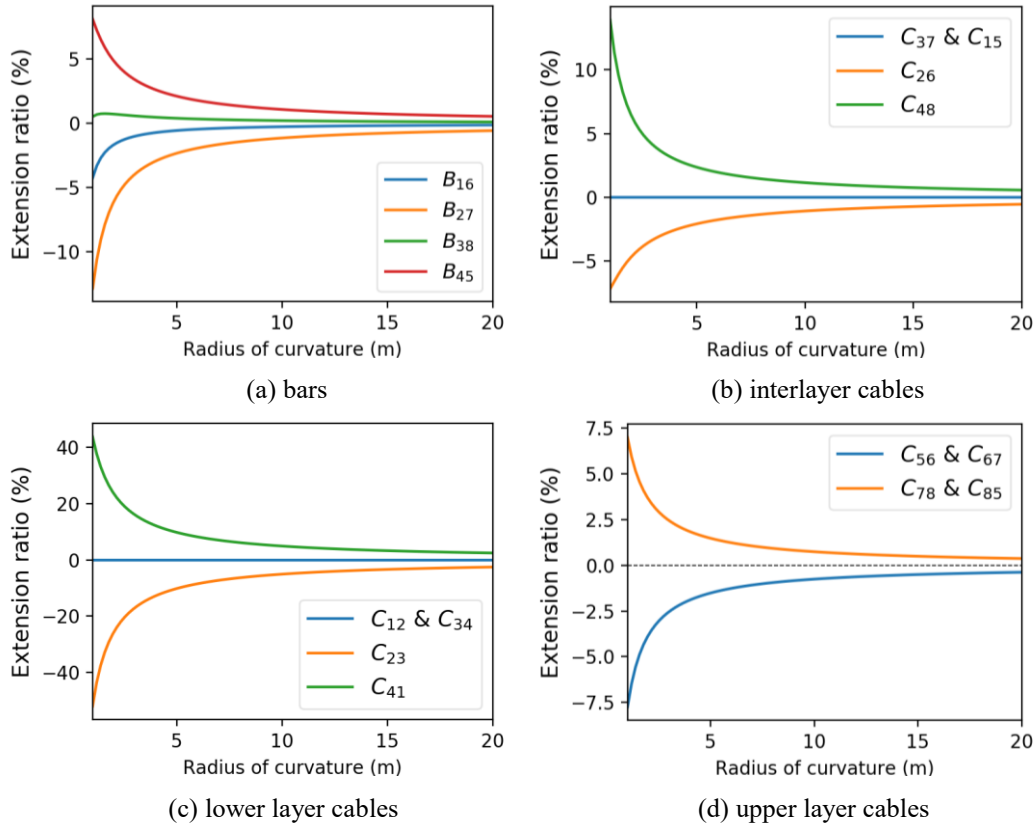

Figure 8: Extension ratio of elements as a function of radius of curvature.

4. Structural behavior

For mechanical qualification of “Biquadruplex” platforms under operating loads, a finite element analysis using Ansys software is conducted on platforms with different spans, support conditions and curvature. However, for further experimental developments, we decided to opt for mechanical and geometrical properties of materials existing on the market (Tab. 1).

Table 1: Mechanical and geometrical characteristics of the numerical model.

Elements	Materials	Young's Modulus (GPa)	Elastic limit (MPa)	Poisson's ratio	Density (kg/m ³)	Geometry (mm)
Bar	Aluminum	71	240	0.3	2700	$\begin{cases} D_{ext} = 40 \\ t = 2 \end{cases}$
Cable	Stainless steel	169	450	0.3	8000	$D = 10$

Plate	Wood	10	20	0.25	600	$t = 22$
-------	------	----	----	------	-----	----------

For mechanical and geometrical reasons, some elements might reach the limit states, buckling limit for bars and elastic limit for cables [11]. For sake of brevity, we aimed to only show the structural behavior of “Biquadruplex” topology dependently of different parameters regardless of limit states.

As in “Tensarch” topology, introduction of selfstress in the case “Biquadruplex” topology is carried out by shortening interlayer cables which diffuses internal stress proportionally through elements as shown in Fig. 9, where ϵ (%) represents the shortening ratio. Nevertheless, internal forces in upper layer cables go down due to the presence of deck plates.

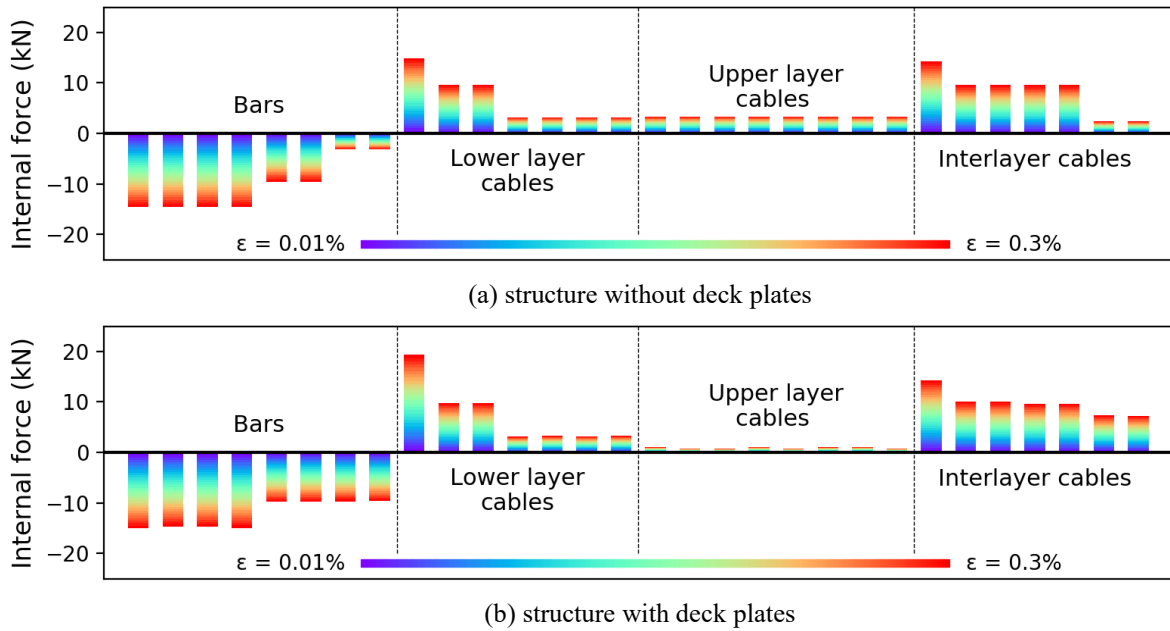

Figure 9: Spectrum of selfstress diffusion in the elements of a “Biquadruplex” module.

4.1. Support conditions

The lower layer of a single “Biquadruplex” module has 6 nodes that can possibly support platform’s structure. In order to qualify the rigidity of this solution in relation to support conditions, we analyzed the mechanical response of a single “Biquadruplex” platform under a uniform loading of 2 kN/m² with ϵ taken equal to 0.2% in the case of 4 different support schemes (Fig. 10).

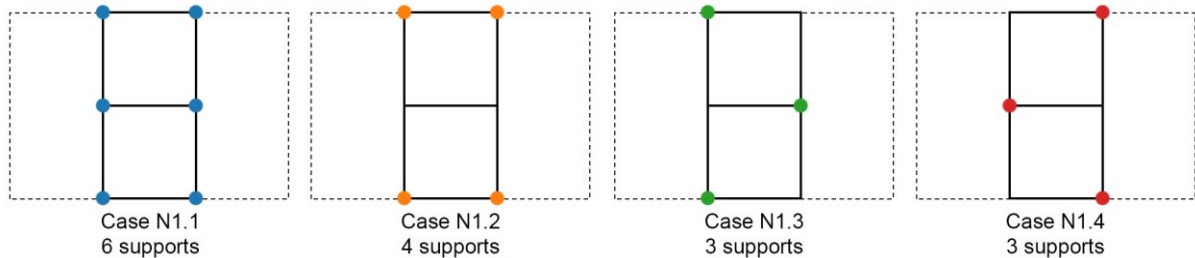

Figure 10: 4 support conditions for a “Biquadruplex” module

By comparing internal forces developed in elements (Fig. 11), the configuration *N1.4* with 3 supports has practically a similar response as the configuration *N1.1* with 6 supports where all lower layer nodes are supported. It's also the case in a matter of vertical displacements (Fig. 12). On the other hand, the configuration *N1.3* is not a relevant choice since it induces large values of displacement in the upper layer. Thus, the optimal supports scheme appears to be *N1.4* with only 3 supports.

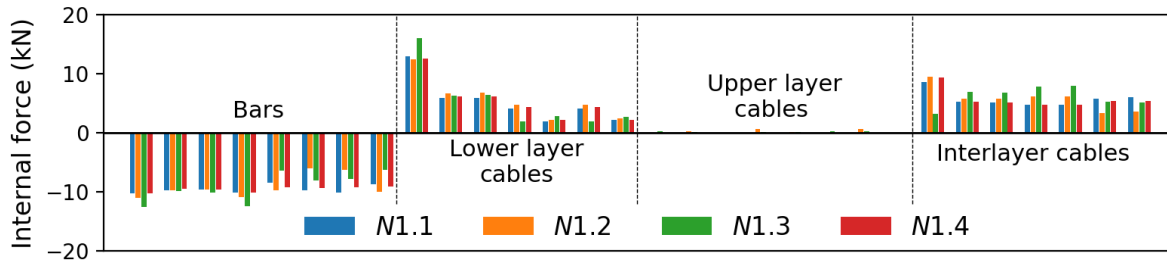

Figure 11: Internal forces developed in the elements under a uniform loading of 2 kN/m².

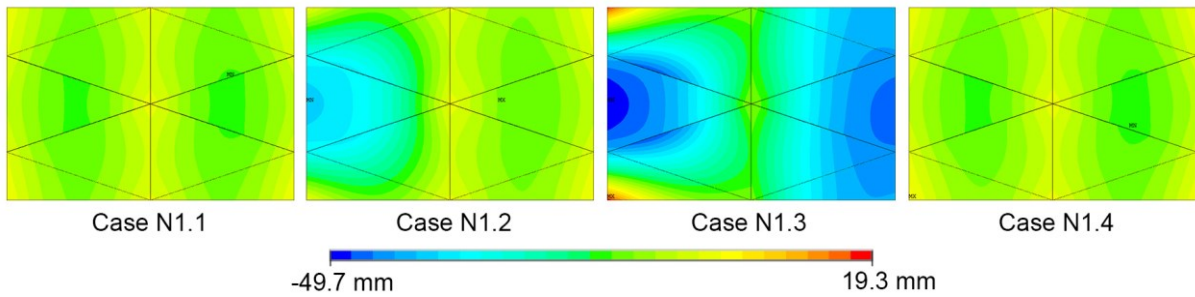

Figure 12: Cartography of vertical displacements of the deck plates under a uniform loading of 2 kN/m².

Moreover, to check if this supports configuration can be generalized to platforms made of several “Biquadruplex” modules, we carried a similar analysis on a double “Biquadruplex” platform where we compared 3 potential supports schemes under a uniform loading of 2 kN/m² (Fig. 13).

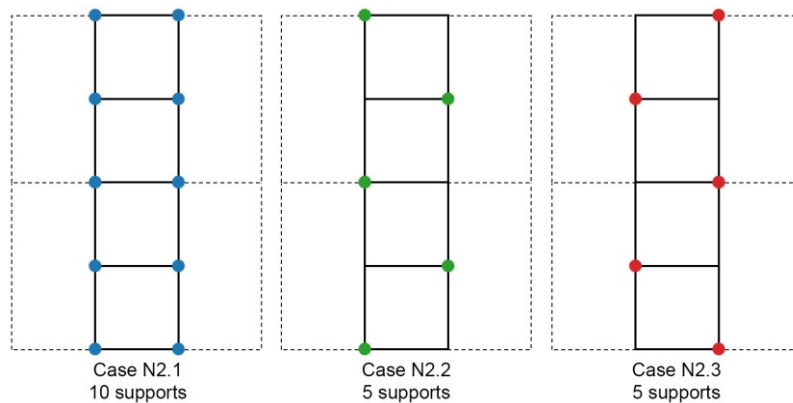

Figure 13: 4 support conditions for a “Biquadruplex” module

Similarly, internal forces developed in the case of configurations *N2.1* (10 supports) and *N2.3* (5 supports) seems to be practically equivalent (Fig. 14). Same is true when it comes to vertical displacements (Fig. 15).

We note that, symmetry in supports distribution doesn't offer the same mechanical behavior, particularly in case *N2.2*.

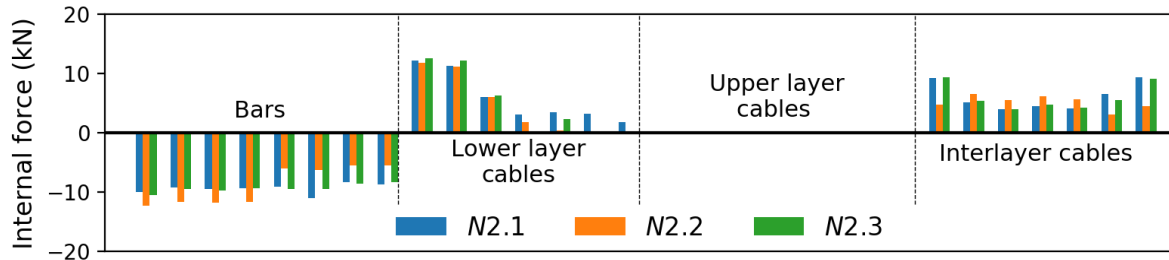

Figure 14: Internal forces developed in the elements under a uniform loading of 2 kN/m².

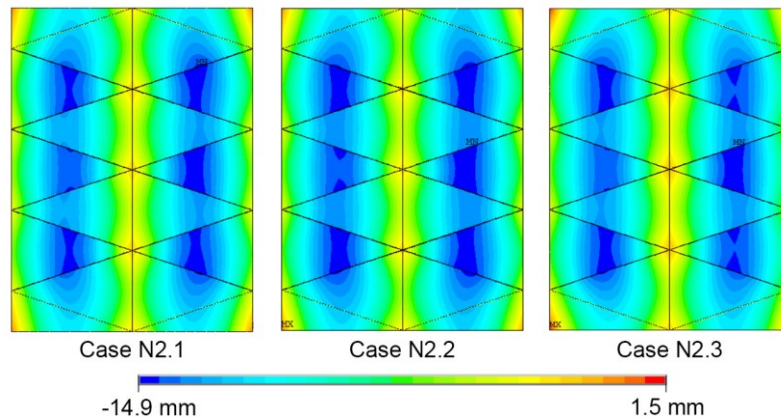

Figure 15: Cartography of vertical displacements of the deck plates under a uniform loading of 2 kN/m².

Thus, alternative support conditions as in the case *N1.4* and *N2.3* seems to be the optimal scheme of "Biquadruplex" platforms under uniform loads.

4.2. Curvature effect

In order to evaluate the effect of curvature on the rigidity of a "Biquadruplex" platform with alternative support conditions as defined previously, similar analysis is carried out on "Biquadruplex" platforms of 4 modules with 4 radii of curvature (5, 10, 20 and 100 m).

Under a uniform loading of 2 kN/m², we note that internal forces slightly increase with radius of curvature (Fig. 16), whereas in terms of displacements, curvature induces asymmetry all while remaining in same range of extremum values (Fig. 17).

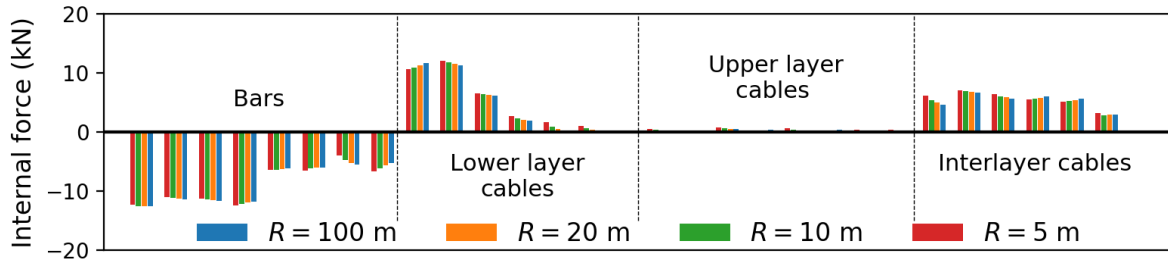

Figure 16: Internal forces developed in the elements under a uniform loading of 2 kN/m^2 .

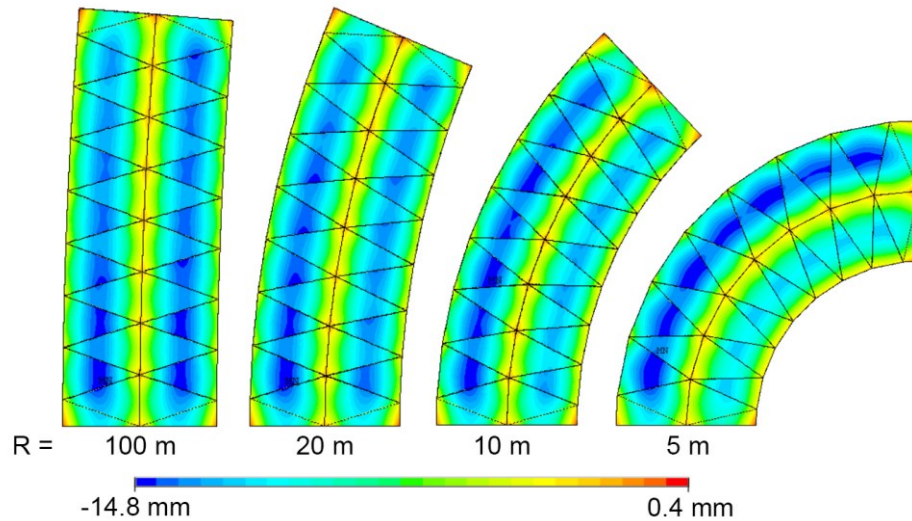

Figure 17: Cartography of vertical displacements of the deck plates under a uniform loading of 2 kN/m^2 .

The simulations presented so far show a satisfying structural performance of the “Biquadruplex” topology as a platform structure under uniform loads, for both straight and curved shapes. Furthermore, a platform of m modules can be supported by only $3m - 1$ lower layer nodes, which amounts to saying that every node can support around 2 m^2 of the useful platform surface.

For proof of concept, the following chapter aims to briefly illustrates the mechanical design of nodes that leads us to build 3D printed prototype of straight “Biquadruplex” topology.

5. Mechanical design

The key components ensuring the different functions are the nodes. To build a physical model, their design should take into consideration different constraints, especially allowing folding mechanisms, ensuring convergence of internal forces and their transmission through the structure at the deployed state, avoiding congestion between elements as well as providing a practical assembly process.

Among the 13 nodes a “Biquadruplex” module has, it’s possible to reduce their number into 4 different family nodes A, B, D and D (Fig. 18).

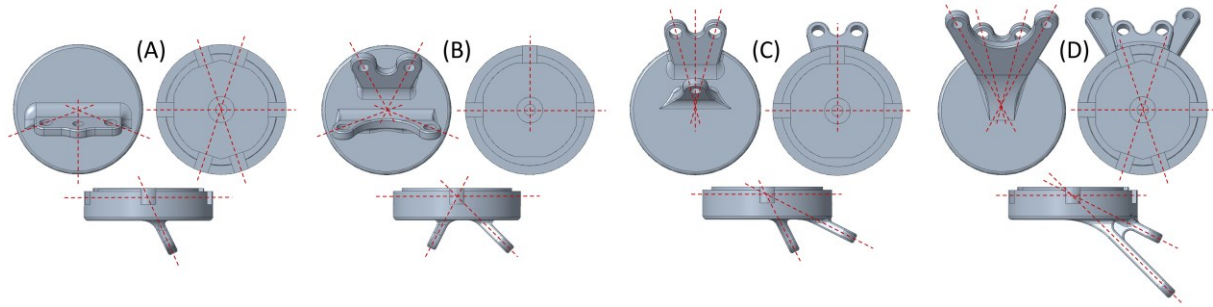

Figure 18: Mechanical design of the 4 family nodes of “Biquadruplex” module.

At this stage of the experimental developments, we built a 3D printed model of a single “Biquadruplex” module, where nodes are designed using a CAD software and printed using Ultimaker 2+ with PLA material. For other elements, we used aluminum alloy for bars and stainless steel for cables. All elements are connected to nodes thanks a clevis system, which allows the rotation mechanism necessary to the folding/deployment process as well as ensuring incidence angles at the deployed state. Besides, interlayer cables are equipped with a turnbuckle system for length adjustments (Fig. 19).

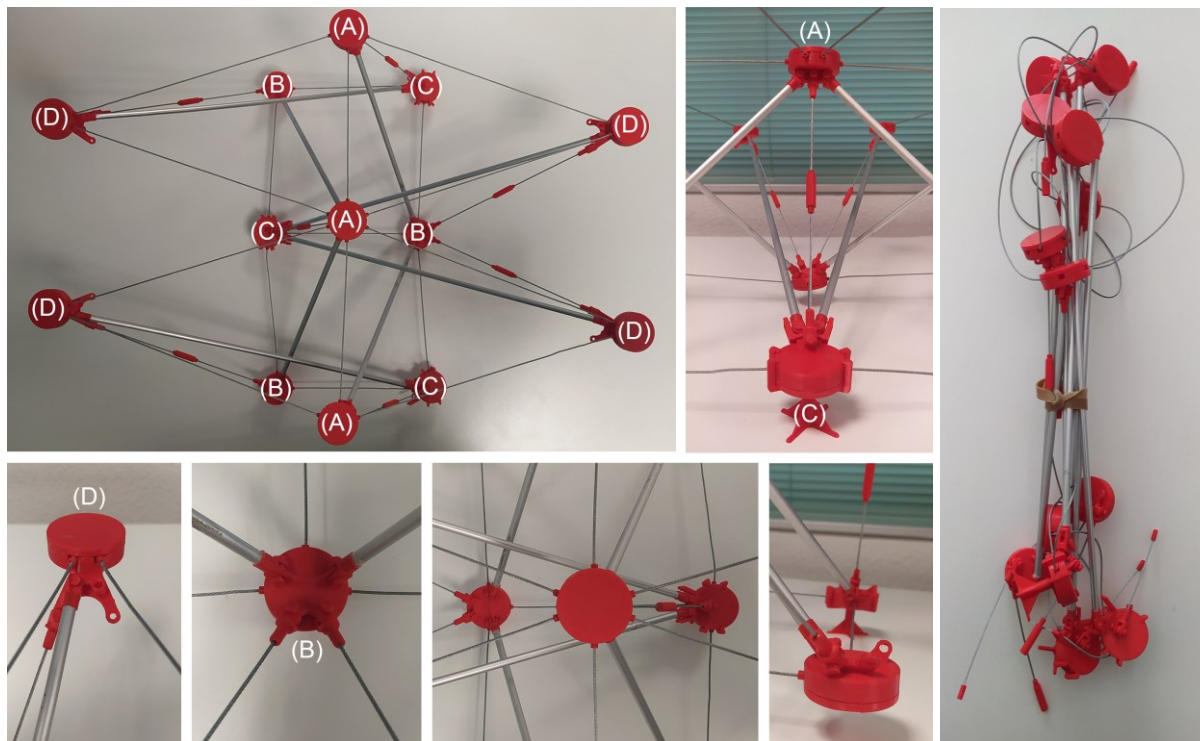

Figure 19: 3D printed physical model of a “Biquadruplex” module.

6. Conclusion and perspectives

The mechanical properties that “Biquadruplex” topology offers, in addition lightweighthness, foldability that led to building a physical model as a proof of concept.

Yet, nodes design turns out to be more complex than in the “Tensarch” concept where the folding takes place in 2 perpendicular planes.

Moreover, disparate elements length in curved topologies can be a hurdle that we need to overcome in order to offer a simple assembly solution all while offering geometrically complex platforms (Fig. 20).

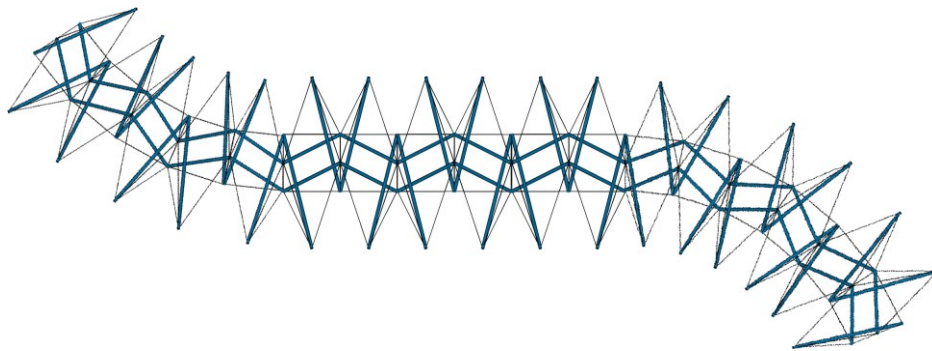

Figure 20: Illustration of a multi-modular “Biquadruplex” platform.

References

- [1] POZEĀA, “Dans l’eau comme tout le monde, 2014.
- [2] F. R. Buckminster. “Tensile-integrity structures”, 1962, US3063521A.
- [3] R. Motro. Tensegrity: “*Structural Systems for the Future*”, Elsevier Science, 2003.
- [4] S. Pellegrino, “*Deployable Structures*”, Springer, 2001.
- [5] A. Smailia and R. Motro, “Foldable/unfoldable curved tensegrity systems by finite mechanism activation”, *Journal of the IASS*, 2007.
- [6] L. Rhode-Barbarigos, N. B. Hadj Ali, R. Motro, I. F. Smith, “Designing tensegrity modules for pedestrian bridges”, *Engineering Structures*, 32 (4) (2010) 1158 – 1167.
- [7] V. Gomez-Jauregui. “*Tensegrity Structures and their Application to Architecture*” 06 2010.
- [8] S. Amouri, J. Averseng, J. Quirant and J.F. Dubé, “Structural design and control of modular tensegrity structures”, *European Journal of Environmental and Civil Engineering*, pp. 687-702, 2014.
- [9] I. Hrazmi, J. Averseng, J. Quirant, and F. Jamin. “Deployable double layer tensegrity grid platforms for sea accessibility”, *Engineering Structures*, 231:111706, 2021.
- [10] I. Hrazmi, “Solutions structurelles d’accès facilité à la mer”, *PhD thesis*, Université de Montpellier, 2021.
- [11] Eurocode 3: “*Design of steel structures*”, EN1993-1-1, 2005.