



# Flat dielectric barrier discharge lamp in interaction with a resonant power supply

B. Caillier<sup>1</sup>, D. Florez<sup>3</sup>, H. Piquet<sup>2</sup>

<sup>1</sup> Laboratoire Diagnostics des Plasmas Hors Equilibre (DPHE), Université de Toulouse, INU Champollion, Albi, France

<sup>2</sup> LAPLACE, Université de Toulouse, CNRS, INPT, UPS - Toulouse (France),

<sup>3</sup> Universidad Sergio Arboleda, Escuela de Ciencias Exactas e Ingeniería - Bogota (Colombia)

# Introduction

Dielectric Barrier Discharge (DBD) lamps have a lot of applications in industry and research (lighting, surface treatment, etc.), so the knowledge of their behavior and their parameters are essential.

The purpose of this study is to analyze the interaction between a pulsed **current** power supply [2] and a flat DBD lamp [1].

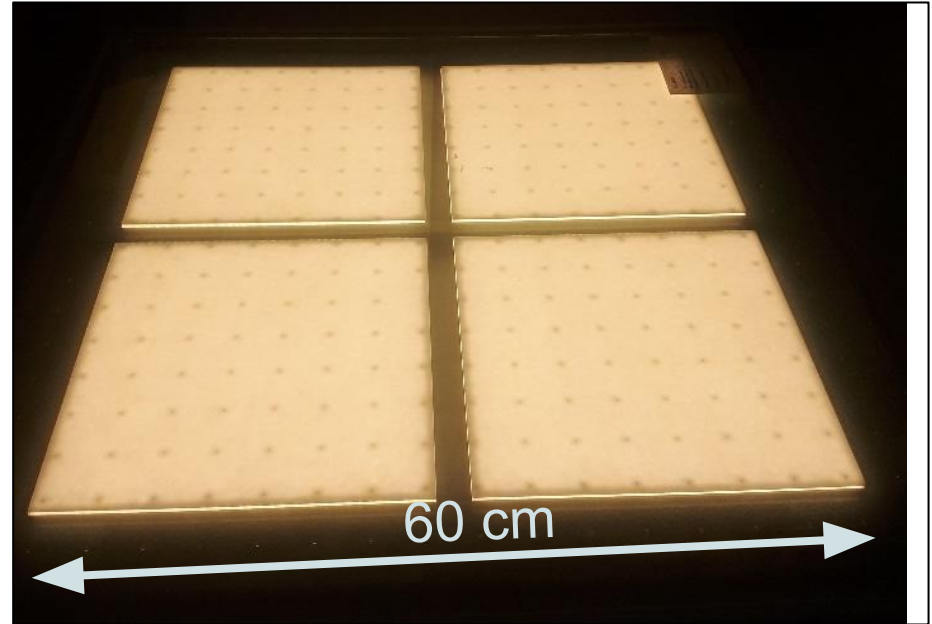

1. B. Caillier, T. Beaudette, L. Therese, P. Belenguer and P. Guillot. (2013), Études et optimisations de lampes planes sans mercure, European Journal of Electrical Engineering 16 565-582.; DOI:10.3166/ejee.16.565-582.

2. David Magin Florez Rubio "Sources d'Alimentation Électrique pour l'Étude et l'Utilisation Efficace des Lampes Excimères DBD", Institut National Polytechnique de Toulouse - INPT, 2014. English. HAL-ID: (tel-00939234)

# Materials and methods

The DBD lamp is composed of 2 dielectric layers, separated by a gas mixture [1].

Dielectric thickness : 3.15mm

GAP : 2 mm

Gas : Ne-Xe 50% 400 mBar

Area : 60x60 cm

Plasma will appear in the gap when the  $v_{Gas}$  voltage reaches the  $V_{th}$  threshold.

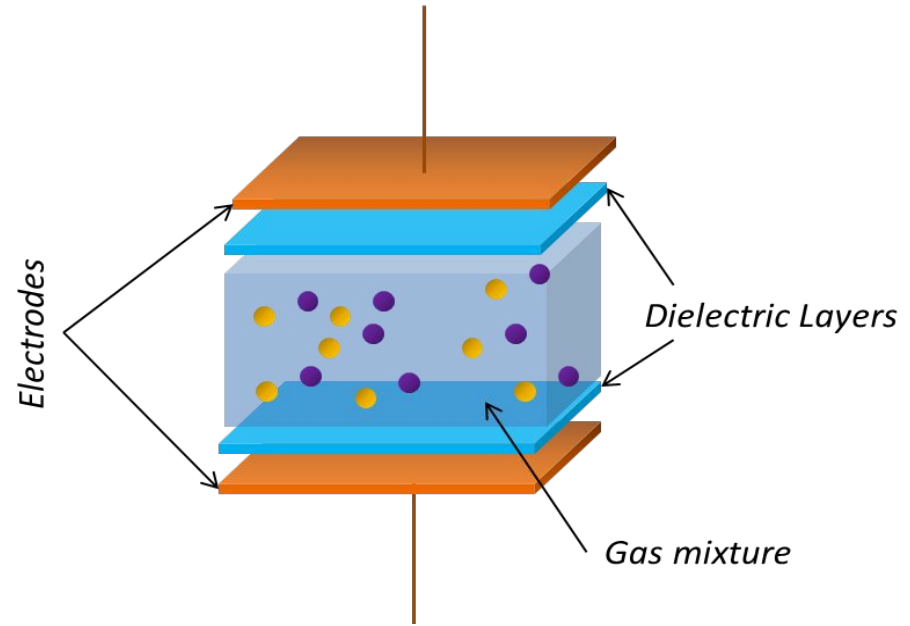

# Circuit

The Power Supply operates on a resonance principle

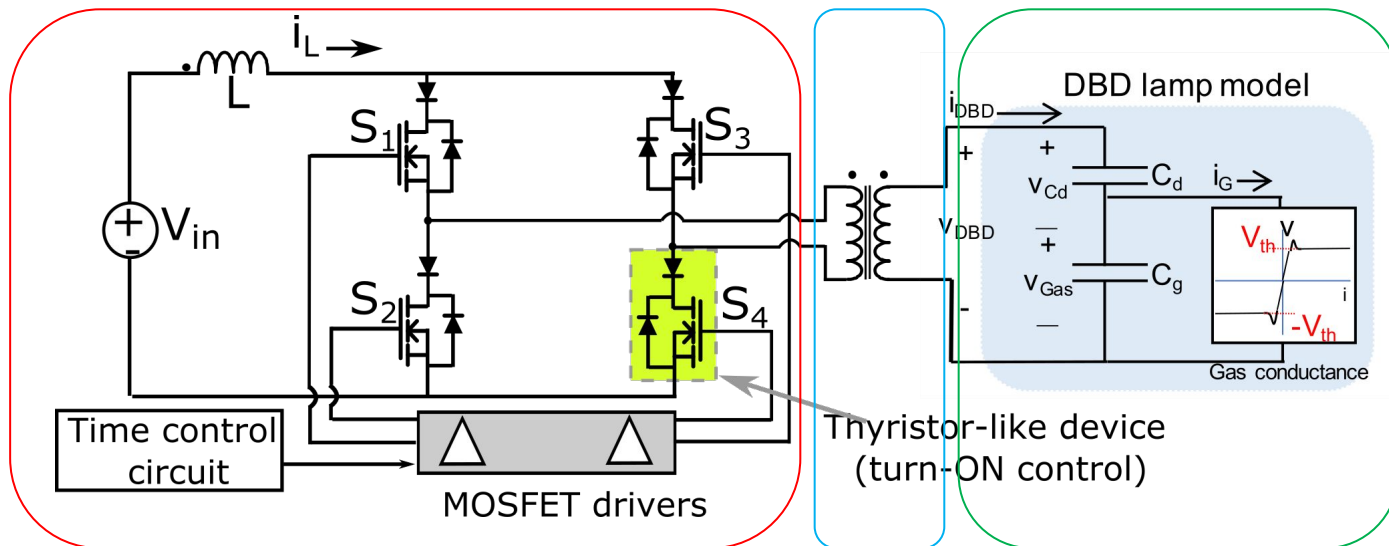

power source = fixed part of the power supply + coil to be adapted

Electrical transformer = part to be adapted

Dielectric barrier discharge part = Characteristics to be determined

# Manley Diagram

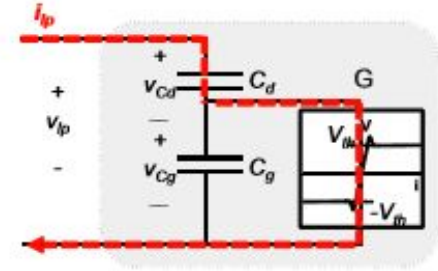
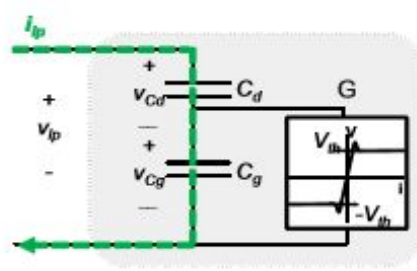
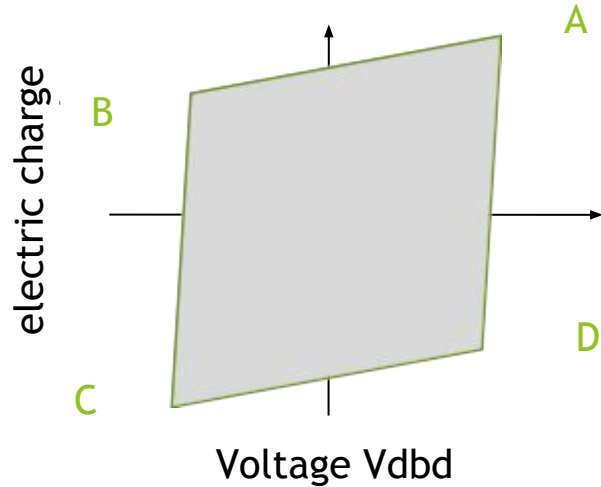

AB and CD: capacitive phases **plasma off**.  
The slope of AB indicates the capacity value  $C_{eq}$ .

$$C = C_{eq} = \frac{C_{diel} * C_{gaz}}{C_{diel} + C_{gaz}}$$

BC and DA: discharge phases **plasma on**.

The slope of BC indicates the capacity value  $C_d$ .

$$C = C_d$$

# From Measurements

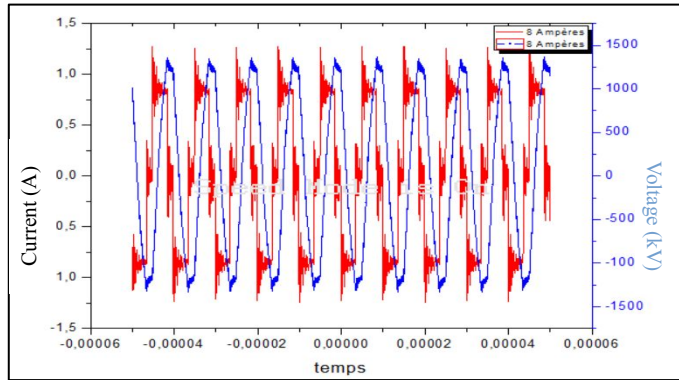

Time (s)

Matlab

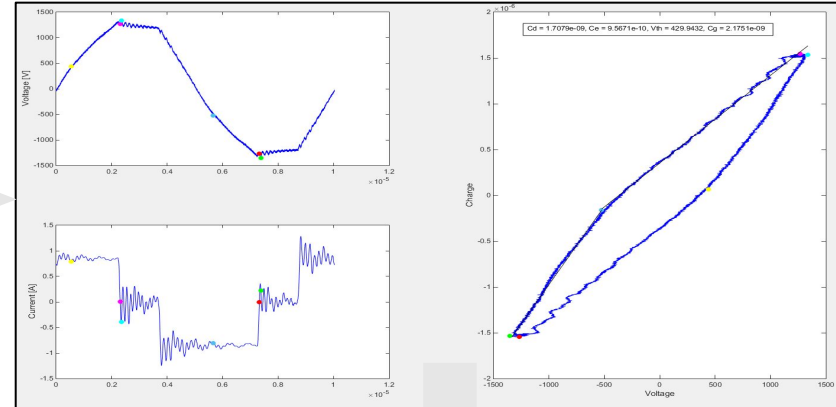

From electric measurements and a Matlab program, capacity  $C_d$ ,  $C_g$  and  $V_{th}$  could be deduced

$C_d=1.70E-9$  F  
 $C_g=2.17E-9$  F  
 $V_{th}=430$  V

# Pspice's simulations

$C_d = 1.70E-9$  F  
 $C_g = 2.17E-9$  F

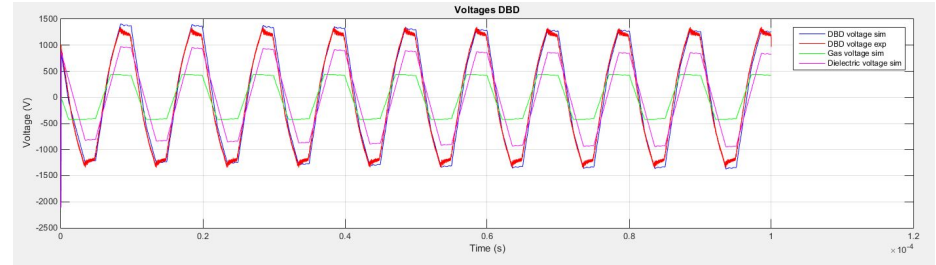
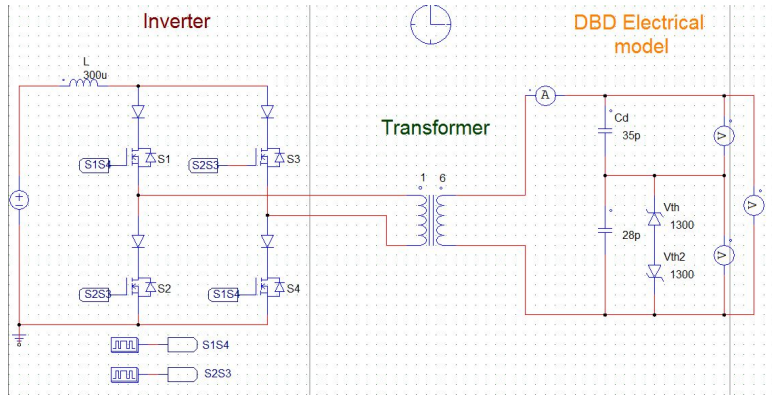

With Pspice, the previous calculated capacities ( $C_d$  and  $C_g$ ) and the experimental current, the voltage could be simulated and compared to the experimental one.

Experimental Current

# Results : Frequencies

## 20kHz to 80kHz

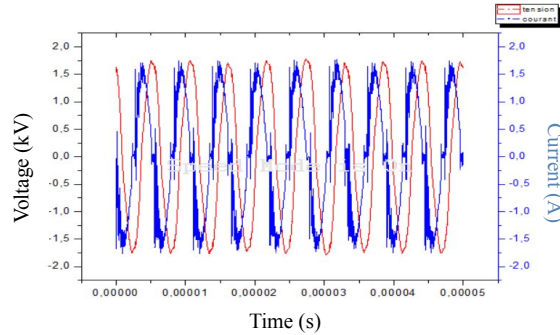
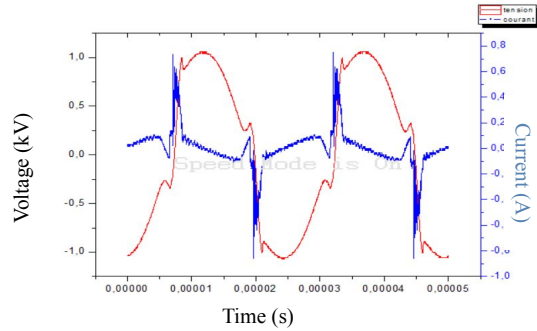

Series of measurements by setting the input voltage amplitude to 150V and varying the frequency from 20kHz to 80kHz

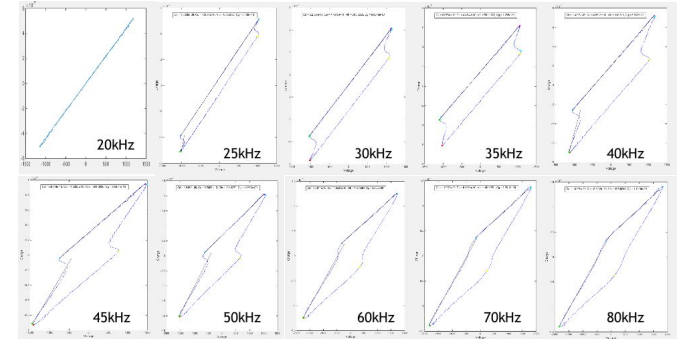
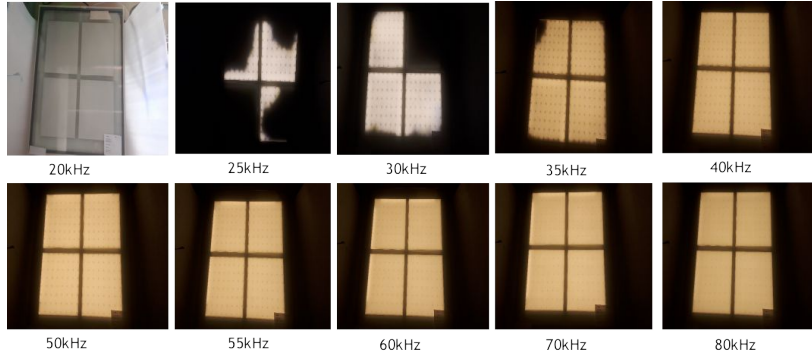



# Obtained from DBD model

## Capacitance

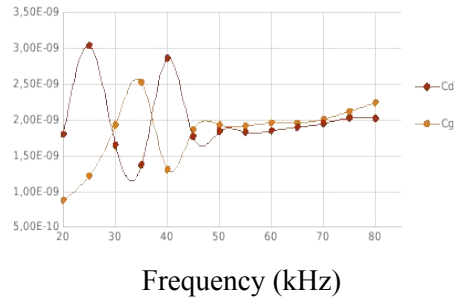

## Vth

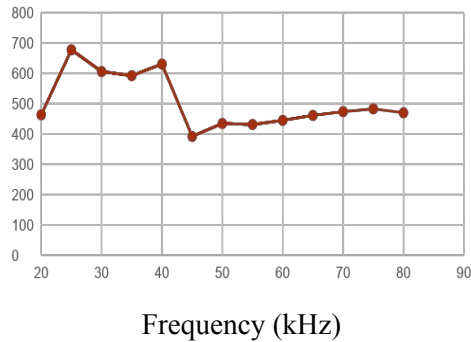

## PManley et Pmoy (40kHz)

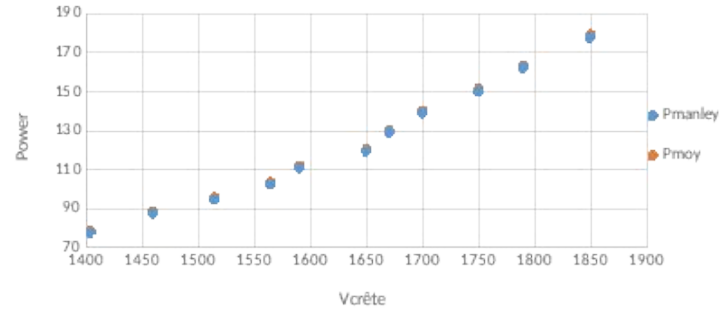

## PManley et Pmoy (50kHz)

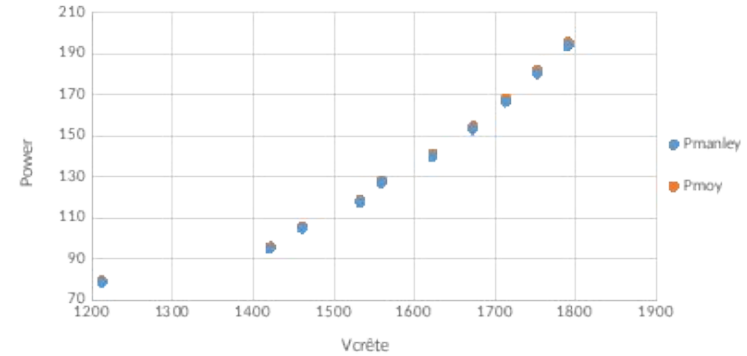

# Power + Luminance measurements = Efficiency

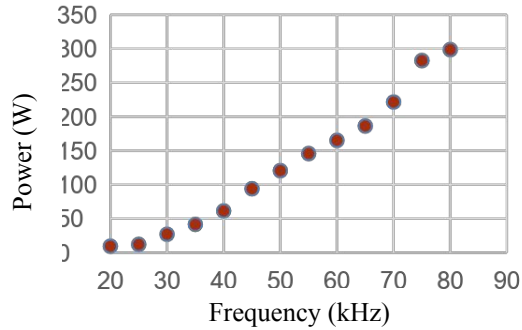

Luminance (cd/m<sup>2</sup>) at 40 kHz

puissance transmise (40kHz)

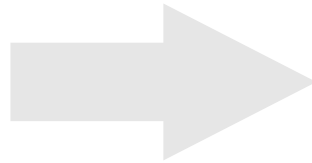
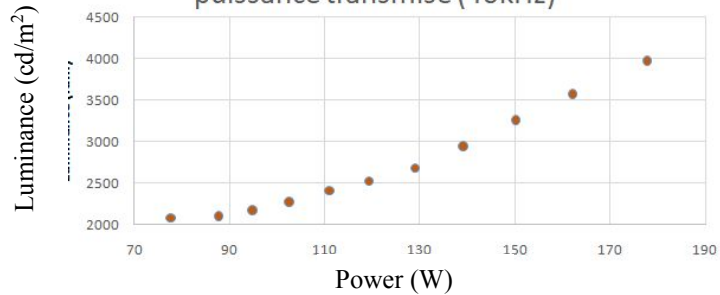

40kHz

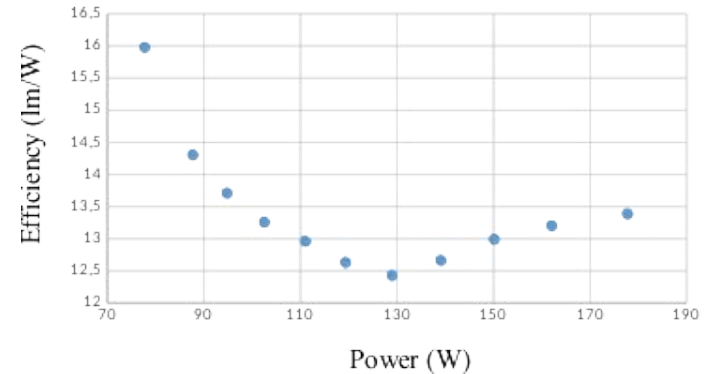

# Frequency impact

45kHz

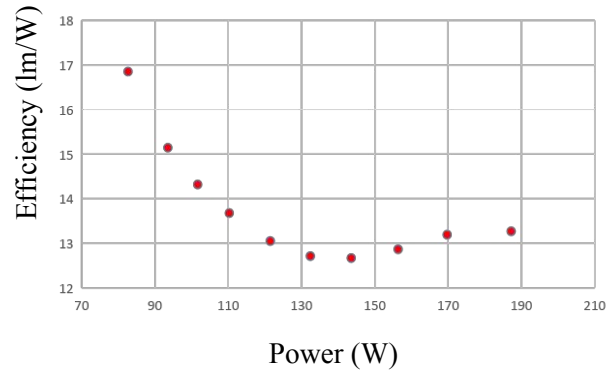

50kHz

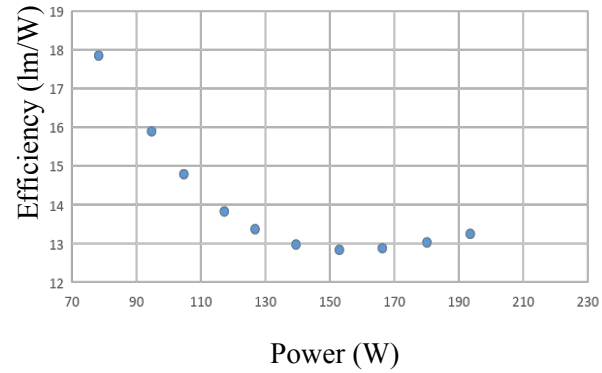

55kHz

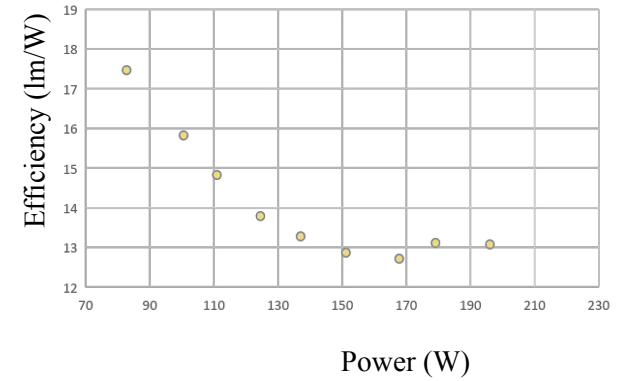

# Conclusion

- Theoretical formulas make it possible to determine in advance the voltage, current and power amplitudes.
- Maximum efficiency of 18 lum/Watts achieved.
- An additional optical study will have to be carried out by modifying the inductance value

# Conclusion

- Theoretical formulas make it possible to determine in advance the voltage, current and power amplitudes.
- Maximum efficiency of 18 lum/Watts achieved.
- An additional optical study will have to be carried out by modifying the inductance value