



HAL
open science

Rotor / Rotor aerodynamic interactions -A Garteur Action Group

Ronan Boisard, Lauriane Lefevre, T. Zhang, G. Barakos, A. Visingardi, F. Lößle, A. Kostek, T. Andronikos, M. Keßler, R. Wickersheim, et al.

► To cite this version:

Ronan Boisard, Lauriane Lefevre, T. Zhang, G. Barakos, A. Visingardi, et al.. Rotor / Rotor aerodynamic interactions -A Garteur Action Group. ICAS 2022, Sep 2022, Stockholm, Sweden. <hal-03935298>

HAL Id: hal-03935298

<https://hal.science/hal-03935298v1>

Submitted on 11 Jan 2023

HAL is a multi-disciplinary open access archive for the deposit and dissemination of scientific research documents, whether they are published or not. The documents may come from teaching and research institutions in France or abroad, or from public or private research centers.

L'archive ouverte pluridisciplinaire **HAL**, est destinée au dépôt et à la diffusion de documents scientifiques de niveau recherche, publiés ou non, émanant des établissements d'enseignement et de recherche français ou étrangers, des laboratoires publics ou privés.



HAL Authorization

Rotor / Rotor aerodynamic interactions – A Garteur Action Group

R. Boisard¹, L. Lefevre¹, T. Zhang², G. Barakos², A. Visingardi³, F. Lößle⁴, A. Kostek⁴, T. Andronikos⁵, M. Keßler⁶, R. Wickersheim⁶, A. Colli⁷, G. Gibertini⁷, A. Zanotti⁷

¹ ONERA, the French Aerospace Lab, France

² University of Glasgow, United Kingdom

³ CIRA, Italy

⁴ DLR, Germany

⁵ National Technical University of Athens, Greece

⁶ University of Stuttgart, Germany

⁷ Politecnico di Milano, Italy

Abstract

The paper presents the objectives, the activities and the results obtained in a self-funded research project carried out by the AG-25 “Rotor-rotor wakes Interactions” consortium of the Rotorcraft Group of Responsables in the GARTEUR framework. The formation of this Action Group was motivated by the observation that new high-speed compound and multi-rotor rotorcraft concepts are spreading out and aerodynamic interactions between rotating parts is important for vehicle performance and stability, especially at low speed. However, there are very few experiments available to improve the understanding and consequences of such interactions and to validate and improve numerical methods. Three research centers: ONERA (France), CIRA (Italy), DLR (Germany), and four universities: Politecnico di Milano (PoliMi) (Italy), University of Glasgow (UoG) (United Kingdom), National Technical University of Athens (NTUA) (Greece) and University of Stuttgart (IAG) (Germany), joined their efforts to fill this gap through common research activities. In particular, three experimental investigations were conducted to study different kinds of rotor / rotor interactions. Two are representative of a fast rotorcraft similar to the Airbus Helicopter RACER, and one of a multicopter vehicle. The measurements include loads on the rotating parts, PIV in the flowfield, as well as noise radiation. The numerical activities aimed at reproducing most of the experimental matrices and comparing different levels of fidelity (ranging from BEM tools up to unsteady RANS CFD). The outcomes of this study are the acquisition of experimental databases and a better understanding of the physics of rotor / rotor interactional aerodynamics. Furthermore, there is a significant validation and improvement of the current numerical tools, and extraction of best practices for the prediction of future high speed and multicopter rotorcraft performance, noise and stability.

Keywords: GARTEUR AG25, High speed Helicopter, Multicopter, Experiment, Computations

1. Introduction

Most conventional helicopters use several rotors, e.g., the classical helicopter with a main rotor and a tail-rotor, the tandem configuration with two side-by-side rotors, and helicopters with co-axial rotors, or tilt-rotors. In the context of the development of high speed compound helicopters, the main rotor cannot be used as an efficient propulsive device at high speed, and most of the time a propeller has to be added to reach high advancing velocities. This multiplicity of rotors is also common in the field of UAVs, where the lifting function is more and more distributed on several rotors (sometimes more than 4). The simultaneous use of rotating blades distributed around the airframe on potentially different planes of rotation (Figure 1 and Figure 2) adds significant aeromechanical complexity and may lead to complex unsteady interactions between the wakes of

the rotors and propellers. It is reasonable to assume that such interactions, of aerodynamic nature, can have a significant impact on vibrations, on radiated noise and on aerodynamic performance, especially but probably not exclusively, at low speed conditions.

Aerodynamic interactions between rotors and fixed surfaces have already been studied over several years. Main rotor – fuselage interactions are now well known, thanks to validated numerical tools and experimental results [1], [2]. Also, the aerodynamic interactions between the helicopter and the ground have been extensively studied (ground effect [3], [4], brown-out, etc). More recently, an Action Group (AG22) focused on the forces generated by helicopter wakes on surrounding obstacles in the context of flight in confined areas [5], [6].

Main rotor – tail rotor interactions are also well documented. For example, they were part of the European project GoAHEAD and the associated numerical studies by several European organizations [7].



Figure 1 : Sikorsky S-97 Raider



Figure 2 : Airbus Helicopter RACER

Rotor–rotor interactions are less documented but some literature on the subject provides interesting inputs about wake interaction phenomena. For example, an experimental study carried out by US Army, simulated co-axial and tandem configurations [8], [1] but it was unfortunately limited to hover cases.

It seems that very little attention has been paid to rotor-propeller aerodynamic interactions. The most exhaustive study of compound helicopter with side propellers was performed back in the sixties [9]. The study was limited to relatively high advance ratio for which wakes interactions are minimal and only a full aircraft was used (main rotor, fuselage, wing and propeller) introducing lots of interactions and making it difficult to understand the consequence of each component wake. More recently, small scale experiments were conducted by Sikorsky and UTRC on a configuration similar to the X2 and the Raider [10]. But experiment is not widely available and only speeds above 105 kts were investigated.

Even if rotor-rotor or rotor-propeller interactions can nowadays be numerically addressed by high order aerodynamic tools (CFD), such approaches are expensive in terms of CPU time due to the differences in rotating speed between the main rotor and the propeller. Also, the rotor and propeller wakes have to be propagated with high accuracy over long distances, further increasing the CPU cost. Moreover, at low speed, flow phenomena tend to be highly unsteady and results must be averaged over a long period of time. Therefore, there is a need for low order models to be used in pre-design phases of advanced rotorcraft vehicles in combination with comprehensive and CFD codes. Developing such low-order models requires adequate experimental databases to validate CFD or free-wake models. However, a survey of the available literature highlights the lack of such experimental databases at least in the open domain.

An exploratory group (EG-36) was created with the aim to promote activities which could contribute to fill these gaps. EG36 proposed the creation of an action group (AG25) gathering a team of researchers willing to investigate, both numerically and experimentally rotor / propeller wake

interactions on high speed rotorcraft operating at low speed conditions.

The time scale for the AG25 is three years, starting in November 2019 during which the following activities were planned:

- Application and possible improvement of computational tools for the study of rotor / propeller wakes interactions
- Setting up some cost effective wind tunnel test campaigns aiming at producing experimental database for the validation of numerical methodologies
- Final validation and assessment of the numerical methodologies

2. Experimental Activities

The experimental investigations were performed during several wind tunnel campaigns, complementary to each other, in order to analyze different aspects of the flow physics of the aforementioned aerodynamic interactions. PoliMi and ONERA worked on configurations similar to the X3 or RACER high speed helicopters with one main rotor and one or two side propellers. The PoliMi experiment is Mach-scaled while this is not the case for the ONERA configuration. The DLR experiment is representative of a multicopter similar to a large UAV. The following section describes the different experiments.

2.1 Rotor/propeller interactions test rig (ONERA)

The ONERA experiment is focused on aerodynamic interactions that occur on fast rotorcraft configurations similar to the X3 or RACER of Airbus Helicopters. The experimental setup is based on a helicopter model and a small scale four bladed propeller. The helicopter model is a DAUPHIN 365 N of 1/77 scale, equipped with a fully articulated four bladed rotor with collective and cyclic pitch controls. The rotor radius is 0.75m and the nominal rpm is 1270 (rotor tip speed~100m/s). The propeller is manufactured by the APC company (APC11x9-4), and is a four bladed propeller with a diameter of approximately 28cm (11 inches). Experiments are carried out in the ONERA L2 large-size low-speed wind tunnel (Figure 3), which is an open-circuit wind tunnel with a closed test section of 6m width, 2.4m height and 13m long. During the experiment, the wind speed varied between 0 m.s⁻¹ to 19 m.s⁻¹. Measurements were performed using two six axis balances (one for the main rotor and one for the propeller), accelerometers and rotor blades pitch, yaw and lag angle sensors. Thermometers and topers were also implemented to monitor the behavior of the rotors. PIV measurements were also done in planes perpendicular to the propeller disc directly upstream and downstream of its position for different wind speeds (Figure 4).

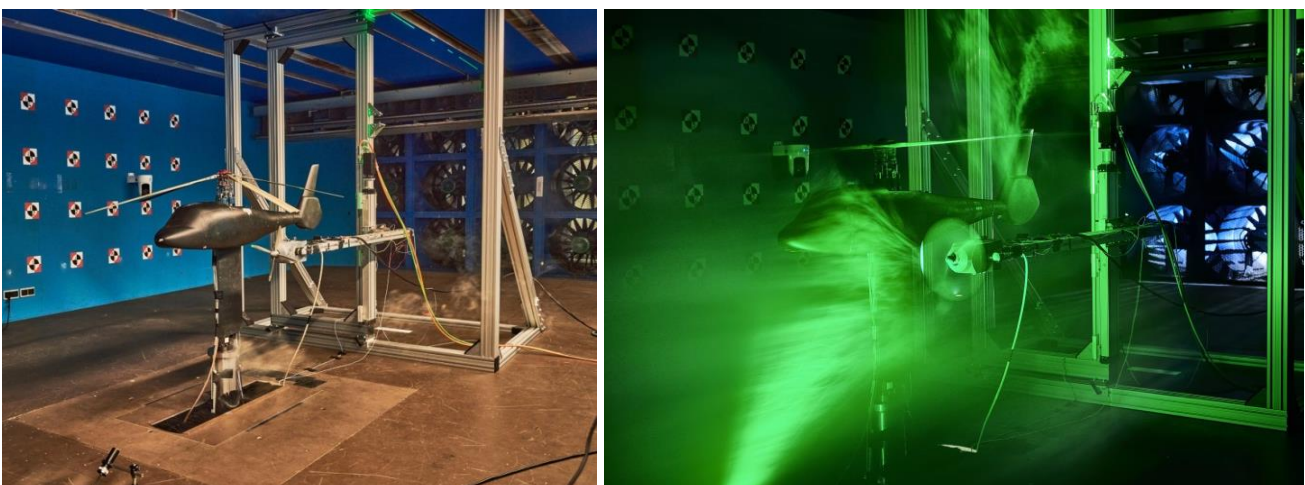

Figure 3: ONERA test rig mounted in the L2 Wind-Tunnel (ONERA-Lille)

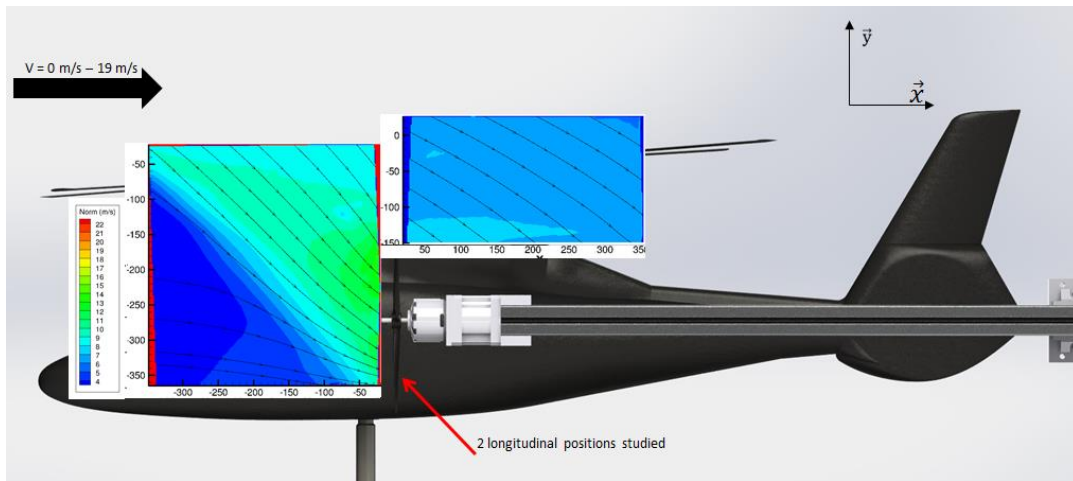

Figure 4 : ONERA PIV planes scheme (ONERA - Lille)

2.2 Mach scaled rotor/propeller interactions test rig (PoliMi)

The PoliMi wind-tunnel test rig (Figure 5) is composed of a five-bladed, fully-articulated main rotor, mounted on a whirl tower and equipped with rectangular, untwisted NACA 0012 blades; and two five-bladed side propellers, with blades from manufacturer varioPROP, both right- and left-handed. The whirl tower and rotor assembly is made available courtesy of Leonardo Helicopters. The main rotor, with a radius of 0.855 m, is equipped with sensors for the measure of the blades' pitch, flap and lag angles, and with a load cell for the measure of the loads on the rotor. Each propeller has a radius of 0.15 m and is powered by a Skorpion electrical motor and is connected to a Futek load cell for thrust and torque measurement. The propellers are set in a pusher configuration, similar to the one found in recent high-speed rotorcraft design, such as the RACER. The propellers were preliminary tested in the "S. de Ponte", closed-circuit wind tunnel at PoliMi with a test section 1 m wide and 1.5 m high. Thrust and torque were measured to assess the adequacy of the setup (Figure 6) The results of the preliminary performance measurements on the isolated PoliMi propeller are shown in Figure 7, indicating the adequacy of the system for the rotor/propellers interaction study.

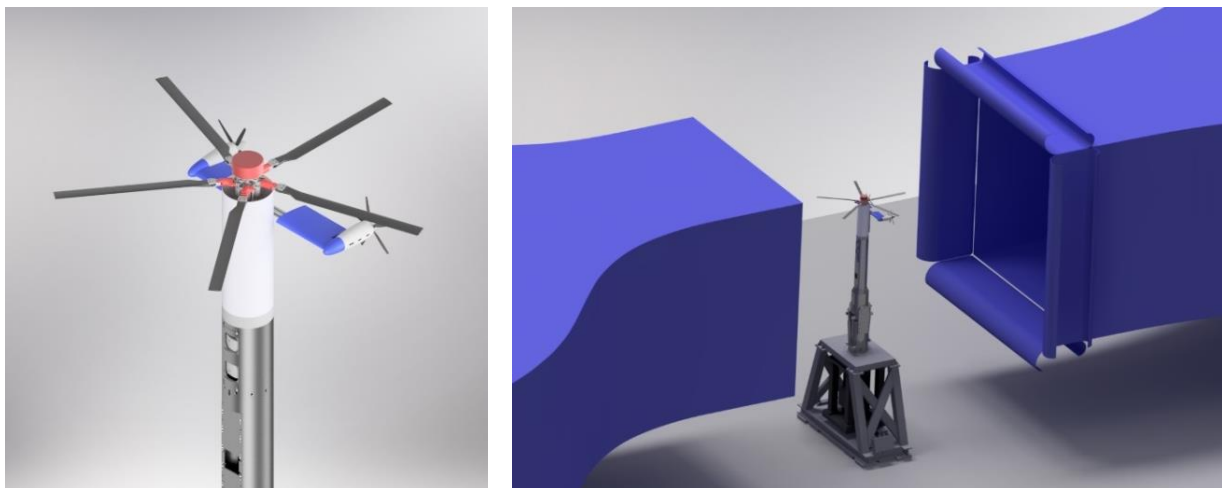

Figure 5 : Schematics of the PoliMi full rig, detail of the rotor-propellers assembly (left) and wind tunnel configuration for testing (right).



Figure 6 : PoliMi propellers, assembly detail (left) and wind tunnel testing (right).

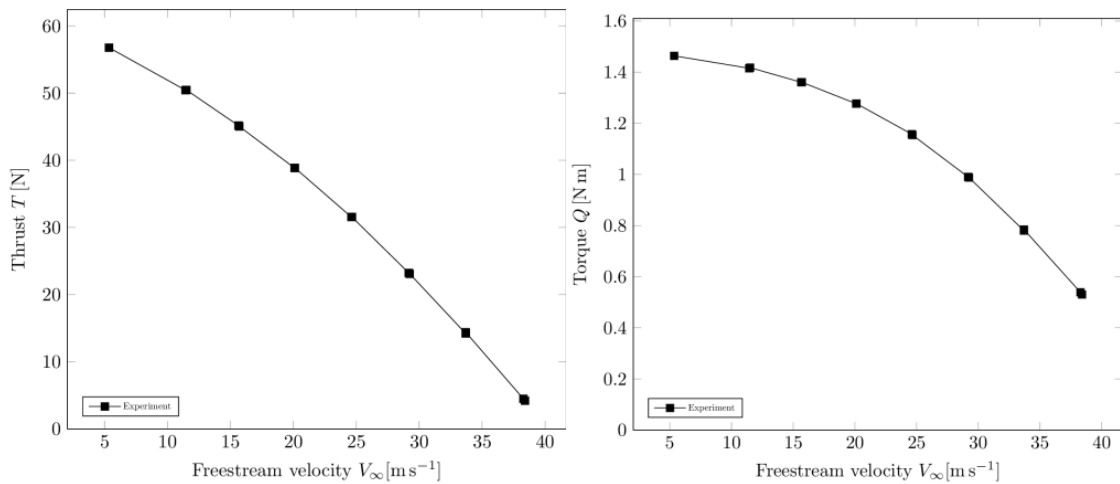

Figure 7 : Experimental data of thrust (left) and torque (right) for the isolated PoliMi propeller.

Experimental tests of the full compound configuration will be performed in the Large Wind Tunnel at PoliMi (GVPM). A “T-shape” test rig configuration is used (Figure 5) in order to open the possibility to add wings to improve similarities with actual rotorcraft and future investigation of interactions between rotor / propeller and wings. The GVPM is a closed-circuit wind tunnel with test section 4 m wide, 3.84 m high and 5 m long, and open test section configuration for rotorcraft testing. The test campaign will include low to moderate advance ratio conditions, with free-stream velocity from different azimuthal directions, with a particular focus on side wind. The experiment will be Mach scaled (contrary to the ONERA experiment), with the main rotor nominal RPM of 2245, for a tip speed of 201 m/s, while the propellers nominal RPM are 12800. Measurement will be performed of all the rotor’s blades angles, of the loads on the main rotor and on each of the propellers. Particle Image Velocimetry (PIV) will also be employed for the measurement of the flowfield.

The main outcomes expected from the full rotor/propellers experiment include the measurements of the effects of the rotor wake interaction on the performance of the propellers and of the dependence of these effects on the direction of the incoming wind; moreover, the flowfield PIV measurement will allow to study the mechanisms of the interaction.

2.3 Multirotor interactions test rig (DLR)

In recent years the use of multicopters in urban areas has rapidly gained in importance because of their broad field of application. Due to the new nature of this subject, the use of several small rotors in multicopters raises new questions about aerodynamics and aeroacoustics of small rotor blades

and rotor-rotor-interaction. The intent of DLR experiment is to improve the understanding of such interactions. In a first step single rotor aerodynamics was studied in a wind tunnel experiment. The measured data served as validation for computational results. The experiment was conducted at DLR's rotor test stand Göttingen (RTG), which is an Eiffel-type wind tunnel with open test section. For the measurements, a nozzle outlet of 1.6m x 0.8m was chosen in order to reach flow velocities up to 23m/s. Different two- and three-bladed rotors with diameters between 30.5cm and 62.2cm were installed vertically in the test section on a rotatable support system allowing variations of rotor tilt angle between -30° and 30° . The rotor was driven by a 180W brushless DC motor. An overview of the configuration is given in Figure 8. For thrust and torque measurements the drive unit was equipped with load sensors. Additionally, a background oriented Schlieren (BOS) setup was applied in order to visualize tip vortices in the rotor wake. The rotors' noise emissions were measured with an innovative microphone array consisting of 512 micro-electro-mechanical systems (MEMS) microphones. Beamforming algorithms can be applied to the acoustic data in order to localize noise sources (results from the acoustic measurements will not be shown in this paper). Further experiments with configurations consisting of up to four rotors which can be controlled in phase are planned. In a second step, experiments with multicopter configurations with up to four rotors that can be controlled in phase are conducted in the RTG. The investigation includes the variation in relative distances between the rotors for the plus and cross configuration. The experimental setup of a plus positioning can be seen in Figure 9.

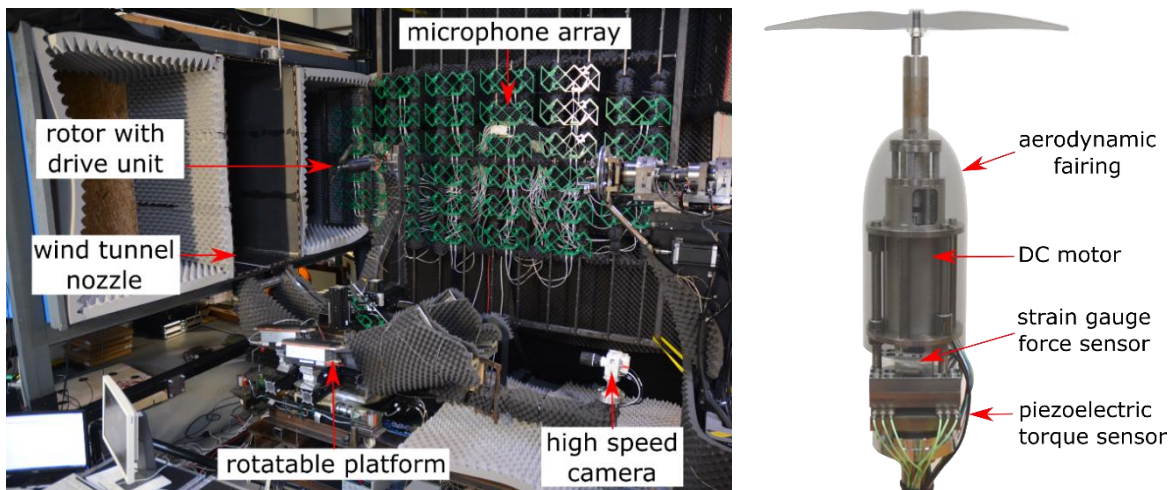

Figure 8: Experimental setup in RTG

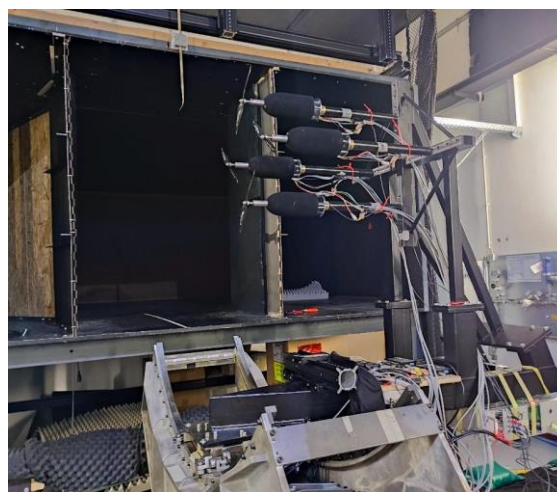

Figure 9: Experimental multicopter setup

3. Numerical methods

The numerical investigations of the “Rotor – Propeller wakes Interactions” are performed by each partner applying in-house-developed or commercial computational tools. The kind of modelling used is ranging from simple Blade Element Momentum theory based tools up to full unsteady Reynolds average Navier Stokes computations. A brief overview of each partner’s tools capabilities is given in the following sections.

3.1 ONERA numerical methods

ONERA computational results shown in this work were obtained with two different tools. The first one is the PUMA code developed at ONERA. It is based on a coupling between aerodynamic module (lifting line, free wake) and a kinematic module (multi-body). It is a well-suited tool to predict wake – obstacle interactions [11] and wake – wake interactions [12]. The airfoil data needed for the lifting line computations were computed using elsA CFD solver [13] for a constant Reynolds number over Mach number corresponding to the rotor scale. Concerning the numerical parameters used for the computations, they are based on ONERA previous experience on the use of PUMA for helicopter rotors and propellers and parametric study. PUMA was used to compute both ONERA and DLR experiments. In all the computations only the blades were taken into account without any fuselage or test rig model. Depending on the test advance ratio, between 5 to 15 wake revolutions were kept in order to compute the induced velocities and between 15 to 40 rotor revolutions were computed to ensure acceptable convergence, with an averaging of the final loads over several revolutions.

The second tool is the elsA CFD solver. It is an unsteady Navier-Stokes code [13] able to simulate any kind of helicopter configuration and perfectly accounting for wake interactions. Computations can be either fully unsteady with all the bodies meshed, or using some approximations (actuator disc, unsteady volume source terms, ...). In the current work, the ONERA experiment was simulated using elsA and fully unsteady computations were performed. Propeller and main rotor blade were meshed using a body fitted approach and immersed in a Cartesian background grid automatically generated using octree technique. The background grid extended up to roughly 10 rotor diameters in the farfield. The mesh was refined in the vicinity of the blades up to a level of approximately 9% of the blade chord. Depending on the test cases (advance ratio and isolated or installed configuration), the final meshes count from 300 million points to 440 million points. For the time marching a 2nd order implicit backward finite differences scheme was used, solved by a Newton algorithm. To ensure good accuracy the number of Newton sub-iterations was set to 25 and a physical time step corresponding to an azimuthal angle of 0.1° on the main rotor was used throughout the whole computations. Due to the low velocities involved in these computations, a version of the 2nd order AUSM+P scheme adapted to low Mach number flow was used. K- ω Kok model was used for the turbulence with Zheng limiter and SST correction. Computations were performed in the absolute velocity formulation using an absolute reference frame.

3.2 University of Glasgow numerical methods

The University of Glasgow adopted high-fidelity CFD and hybrid methods for the accurate prediction of the complex interactional aerodynamics of the ONERA configuration. The in-house Helicopter Multi-Block (HMB3) [14], [15] CFD code was used. The code has been widely used in previous simulations of rotorcraft and rotary-wing flows [16], [17], [18]. HMB3 solves the Unsteady Reynolds Averaged Navier-Stokes (URANS) equations in integral form using the Arbitrary Lagrangian Eulerian (ALE) formulation for time-dependent domains. The governing equations are discretized using a cell-centered finite volume approach on a multi-block, structured grid. The convective fluxes are evaluated using Osher’s approximate Riemann solver, while the viscous terms are discretized using a second-order central difference scheme. The 3rd order MUSCL (Monotone Upstream-

centered Schemes for Conservation Laws) approach was used to provide high-order accuracy in space. For unsteady calculations, the implicit dual-time stepping approach was adopted, and the chimera/overset grid method [19], [20] was extensively used in this work. For turbulence modelling, most simulations in the current work were performed with the k- ω SST [21] model.

Since initial numerical and experimental results of the ONERA configuration suggested that the main rotor sees negligible effects from the interaction, the current study evaluated the actuator disk (AD) representation of the main rotor for the modelling of complex interactional aerodynamics. In this hybrid approach, the actuator disk model resulted in a much-reduced computational cost. It has been widely used as alternative modelling option for edge-wise rotors [22], [23] and propellers [24]. In the present work, the actuator disk model was implemented as equivalent momentum and energy sources injected into the flow-field. In unsteady simulations, a time-dependent Gaussian function redistributed the initial pressure jump to conform with the time-resolved blade location [25]. This approximated the time-resolved blade motions, thereby allowing for better resolution of tip/root vortices and of the induced aerodynamics. Since the momentum sources are now on the discrete rotor blades, this model is often referred to as the actuator line (AL) approach. A convergence study [26] was performed using different grid sizes and time step sizes, and most simulations were then carried out using the medium grid of 18.9 million cells at a step size of 1 degree per step for the propeller.

3.3 CIRA numerical methods

CIRA aerodynamic simulations were carried out by using the medium-fidelity code RAMSYS [27], which is an unsteady, inviscid and incompressible free-wake vortex lattice boundary element methodology solver for multi-rotor, multi-body configurations developed at CIRA. It is based on Morino's boundary integral formulation [28] for the solution of Laplace's equation for the velocity potential ϕ . The surface pressure distributions are evaluated by applying the unsteady version of Bernoulli equation, which is then integrated to provide the forces and moments on the configuration and the surrounding obstacles. A computational acceleration is obtained by applying the module for symmetrical flows and geometries implemented in the solver and the parallel execution via the OpenMP API.

3.4 DLR numerical methods

DLR numerical simulations of chosen cases from the experimental investigation were performed using panel code UPM (Unsteady Panel Method) utilizing free-wake approach ([29], [30]). UPM offers solutions of potential flow problems and includes additional corrections for viscosity effects. The code is capable of calculating aerodynamics characteristics of rotors with arbitrary geometry and motion. The obtained pressure distribution can be easily applied as an input for noise prediction code APSIM (Aeroacoustic Prediction System based on Integral Methods). Geometrical properties of the different propellers were identified from spanwise cuts of 3D-scanned propellers and then used to prepare a paneled surface with PANGEN software. These geometric properties were also shared with all the partners in order for them to base their computation on the exact same geometry. A post-processing correction of torque values helped to account for profile drag contribution, neglected in potential flow.

3.5 NTUA numerical methods

NTUA employed the CORAL code (Comprehensive Rotorcraft Analyses Lab) [31], which is a joint effort of Roma Tre – RM3 University, National Technical University of Athens-NTUA, Carleton University's Rotorcraft Research Group – CU under the coordination of Kopter Germany, a member of Leonardo group. CORAL includes tools for the combined aeroelastic and aero-acoustic analyses of helicopter configurations. The aerodynamic part of the code consists of models of varying fidelity

including free wake vortex particle modules and a URANS hybrid CFD module. Application of each of the modules depends on the scope of the analyses, in terms of time efficiency and/or accuracy. The free vortex wake models solve the inviscid-incompressible-unsteady flow equations around lifting/or non-lifting bodies which can be treated either as lifting Lines, lifting Surfaces or thick panel bodies (lifting and non-lifting). The CFD module is a hybrid one based on the strong coupling of an Eulerian and a Lagrangian [32] model. The Eulerian part solves the compressible flow equations on meshes (structured and/or unstructured) confined in a limited space around the solid bodies. Both fully resolved [33] and actuator line representations [33] of lifting bodies can be considered in the analyses. The Lagrangian part is based on particle representations (particles carrying mass, vorticity, dilatation etc.) and solves the flow equations in material formulation in the far field. In the context of this study, simulations were conducted only on the rotor / propeller interaction configuration (ONERA). For the isolated propeller, computations have been performed using both the free wake module, considering the blades either as lifting Lines, lifting Surfaces and thick panel Bodies and the hybrid CFD module, considering the blades as Actuator Lines. The main rotor and the main rotor-propeller interaction simulations are performed using the free wake module, considering the blades as lifting surfaces.

3.6 IAG numerical methods

IAG applied its proven high-fidelity CFD simulation framework, primarily consisting of the flow solver FLOWer [34], originally developed by DLR and significantly extended by IAG over the last two decades [35]. The URANS framework allows high order WENO discretization in space, arbitrary relative motions of individual component grids by the Chimera method, fluid-structure coupling at the blades as well as the airframe [36] including appropriate mesh deformation [37], flight mechanical trim of control degrees of freedom for free flight or wind tunnel conditions to achieve a specified flight state, adaptive mesh refinement [38] and acoustic evaluation by means of Ffowcs Williams-Hawkings integration as a post processing step. Many more tools for pre-processing the geometry and grids, and for automatically evaluating the obtained data for meaningful quantities afterwards complement the highly parallelized flow solver to form a strong and productive ecosystem.

The first-principles approach with fully resolved blade geometry at the rotor and propeller alike allows for reliable and accurate results for novel configurations like the compound helicopter RACER [39] or the generic one considered here without any need for specific tuning of empirical corrections. In the current investigation, no structure data is available, and consequently no fluid-structure coupling applied. Control angles are prescribed at the experimental values, so no trim process is executed.

4. Overview of the GARTEUR AG25 outcomes

At the time of writing, PoliMi experiments were not yet available due to some issues with the setting up of the test rig. However, ONERA and DLR experiments are well advanced. In this section a comparison of the ONERA and DLR experiment with various numerical tools, along with some analysis of the physics of the flowfield is performed. The main objective of this paper is to give an overview of the GARTEUR AG25, therefore only some key outputs are shown. If the reader is interested, deeper analysis about each configuration, both on the experimental and numerical point of view, can be found in the literature (see Dissemination section).

4.1 Rotor/propeller interactions (ONERA experiment)

The propeller and main rotor geometries from ONERA configuration were available early in the AG25 project; therefore it is the experiment that was the most studied through numerical activities.

In Figure 10, a comparison between the different partner's computations of the isolated propeller from ONERA experiment is shown. An overall good agreement on the trends of the thrust with

respect to the freestream velocity can be seen between all numerical tools and experiments. However, some scattering of the results can also be observed. It should be pointed out that the propeller is operating in a condition which leads to some detached flow and recirculation bubble on a large part of the suction part of the blade. This makes the prediction of the loads more difficult and largely dependent on the choice made for the numerical parameters of the solver. The CFD solvers (ElsA, Flower, HMB3) and the solvers which rely on 2D airfoil data's computed using CFD (PUMA, MapFlow, CORAL) are performing very well compared to experiment. Panel methods (UPM, RAMSYS) feature the largest discrepancies.

To limit the effect of such scattering between the different tools, all the analysis of the rotor / propeller interactions will be performed in terms of installation effects, which can be defined as:

$$\frac{(InstalledValue - IsolatedValue)}{IsolatedValue} \times 100.$$

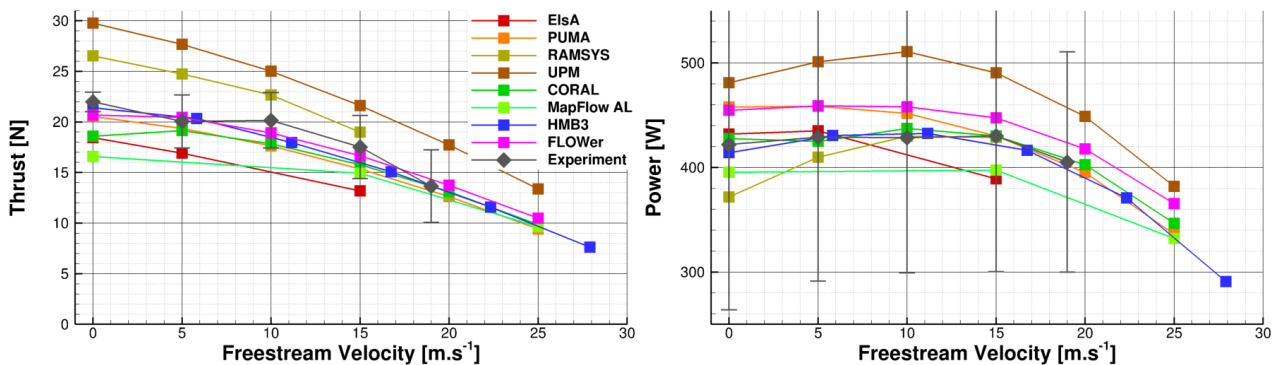

Figure 10: Comparison between computations and experiment of the isolated propeller thrust and power from ONERA experiment

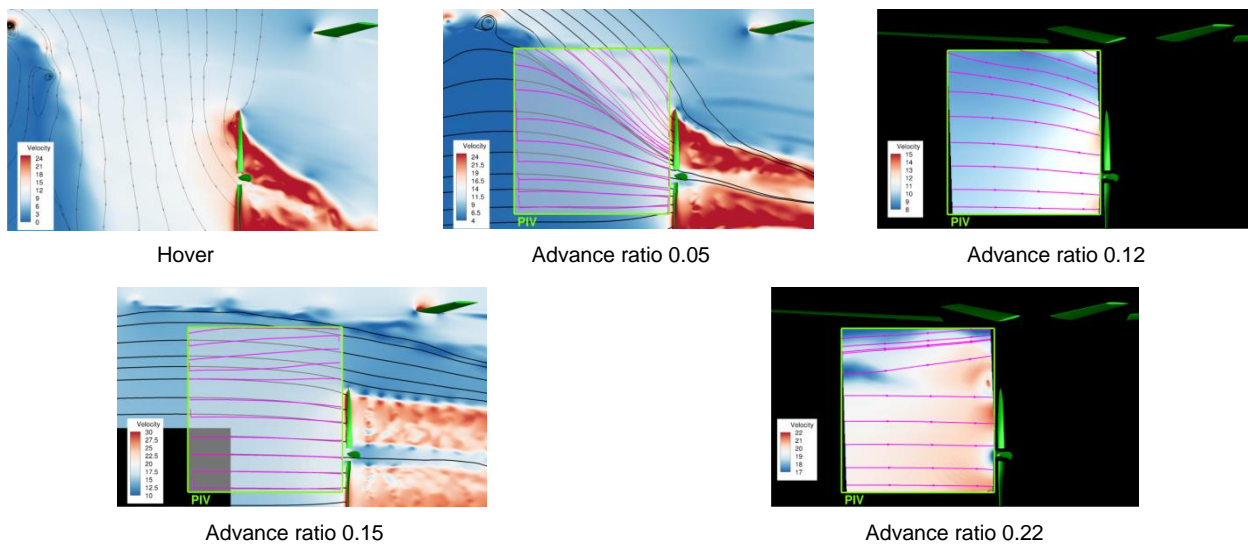

Figure 11: Flow streamline comparison between elsA CFD solver and PIV measurement at different advance ratio

Experiment and numerical activities focus on the effect of the freestream velocities, with a range of advance ratio from hover to 0.19. As observed in Figure 11, increasing the advance ratio reduces the interactions between the main rotor wake and the propeller. For advance ratio above 0.10 the rotor wake does not directly interact with the propeller and only minor wake interactions are observed. At advance ratio 0.05 the propeller is only partially immersed in the rotor wake. In hover the propeller is fully immersed in the rotor wake and important interactions and loads fluctuations are expected on the propeller. For all these freestream conditions it can be observed that the rotor /

propeller wake interactions occur in a very similar manner between the CFD computation and the experiment. At advance ratio 0.05, there is a very good agreement in terms of the portion of the propeller disc that is impinged by the rotor wake.

In order to get an estimation of the effect of the propeller on the main rotor loads, in the computations the same rotor trim was applied in both isolated and installed computations which was not the case in experiment. Figure 12 is showing this effect on the main rotor thrust as a function of the advance ratio estimated by the different numerical tools. All tools agree on the fact that there is almost no effect of the propeller on the main rotor thrust. The change is below 1% over the freestream velocity, except at 5m.s^{-1} . At 5m.s^{-1} there is more effect (up to 4%) but also more discrepancies between the different solvers, and does not seem to be an effect of the level of modelling since the free wake code PUMA is performing similarly to the unsteady CFD solver FLOWer, and another freewake code, RAMSYS, performs closely to ElsA which is an unsteady CFD solver.

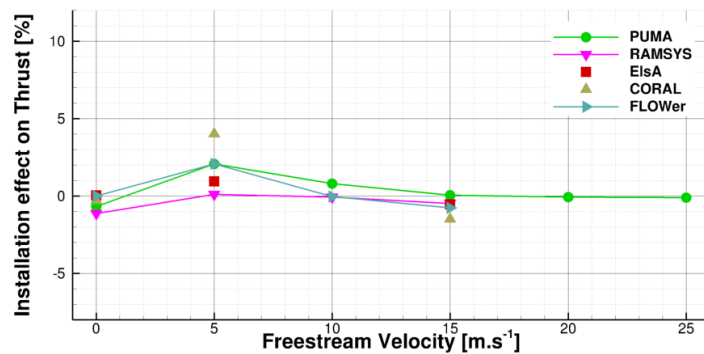

Figure 12: Comparison of the installation effect on the main rotor thrust

Figure 13 shows a comparison of the installation effect on the propeller thrust. When the propeller is outside the main rotor wake, all tools agree reasonably well. For freestream velocities of 10m.s^{-1} and above an increase of the propeller thrust of 3 to 5% is expected. More discrepancies are observed at lower velocities. But overall the trends are similar with a constant gain in thrust above 10m.s^{-1} , a decrease of this gain at 5m.s^{-1} and a re-increase at hover.

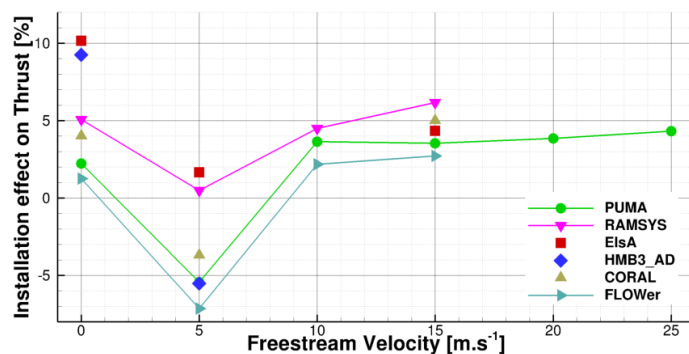

Figure 13: Comparison of the installation effect on the main rotor (left) and propeller (right) thrust (Numerical results)

4.2 Multirotor interactions (DLR experiment)

The KDE rotor series served as an interesting subject of presented study, for which propellers in three different sizes were chosen ($12.5 \times 4.3''$, $18.8 \times 6.3''$ and $24.5 \times 8.1''$), each type both 2 and 3 bladed. The investigation included the effects of wind tunnel velocity and RPM variation, as well as the influence of changing tilt angle of the rotors. While the multicopter experiment is currently running, experimental and numerical investigation of the isolated configuration was already

performed.

Figure 14 is illustrating the comparison of the performances between experiment and different numerical tools from DLR, ONERA, CIRA and IAG for isolated KDE12 propeller at 12.9 m.s^{-1} and 5400 RPM as a function of the tilt angle. An overall very good agreement between all numerical tools and experiment can be observed on the thrust. At high positive tilt angle, interaction of the propeller blades with their own wake is increasing, leading to more discrepancies between the different levels of numerical modelling. Concerning the power, more discrepancies can be observed, but the overall experimental trends are still captured by all the tools. UPM and RAMSYS are panel methods, therefore they can not natively include the viscous effects on the power explaining the larger discrepancies observed. In UPM a postprocessing correction is applied which, as seen on the figure, largely improves the results. At high tilt angle, when blade – wake interaction is important, PUMA (free wake) computation behaves similarly to FLOWer (unsteady CFD) but does not follow exactly the experiment trends.

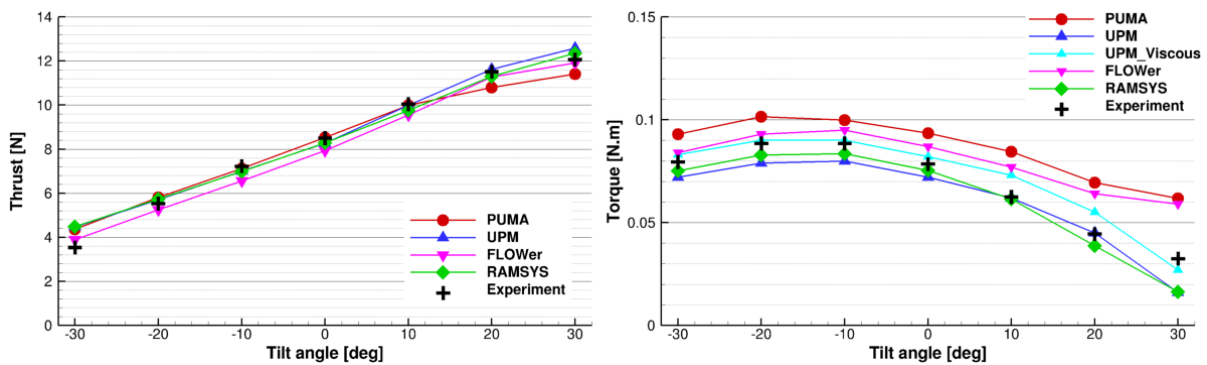

Figure 14: Comparison between experiment and numerical simulations of the KDE12 2 bladed isolated propeller at RPM 5400 and 12.9 m.s^{-1}

Figure 15 is illustrating the comparison of the performances between experiment and the different numerical tools for isolated KDE12 propeller at 12.9 m.s^{-1} and -10° tilt angle as a function of the RPM. A very good agreement is observed in terms of thrust, with only a small underestimation for the unsteady CFD solver FLOWer. More scattering is observed on the torque evaluation but the trend with respect to RPM is still correctly captured. PUMA and FLOWer feature some overestimation of the torque while the panel methods (UPM and RAMSYS) show an underestimation. Including the viscous effect in UPM gives very good agreement with respect to experiment.

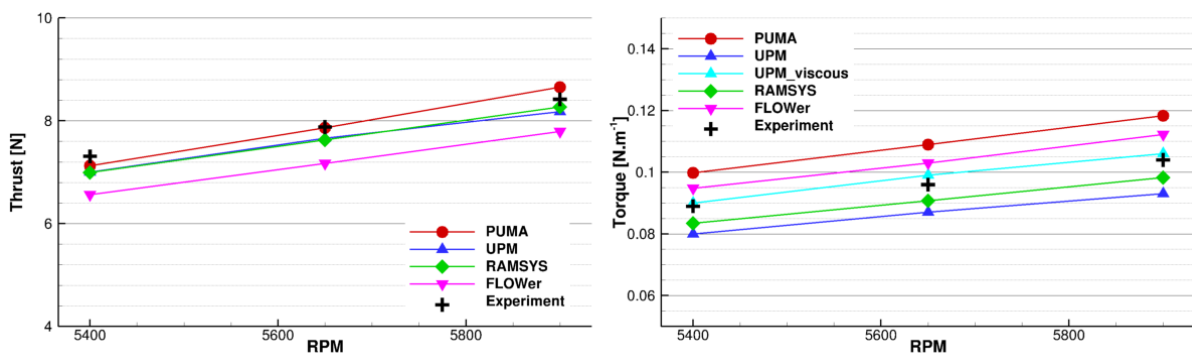

Figure 15: Comparison between experiment and numerical simulations of the KDE12 2 bladed isolated propeller at -10° tilt angle and 12.9 m.s^{-1}

Figure 16 is illustrating the comparison of the performances between experiment and different numerical tools for isolated KDE12 propeller in its 3 blade version at 12.9 m.s^{-1} and 5650 RPM as a

function of the tilt angle. Concerning the thrust, accuracy is similar to the one observed on the two bladed rotor. All numerical tools provide a very good agreement with respect to experimental trends, even at high tilt angle where the blade / wake interaction is increased due to the larger number of blades. Concerning the power, more discrepancies are observed. The overall experimental trends are correctly captured, but at high tilt angle most of the numerical tools are predicting an important loss of power. PUMA is the only tool that approximately follows the experimental behavior.

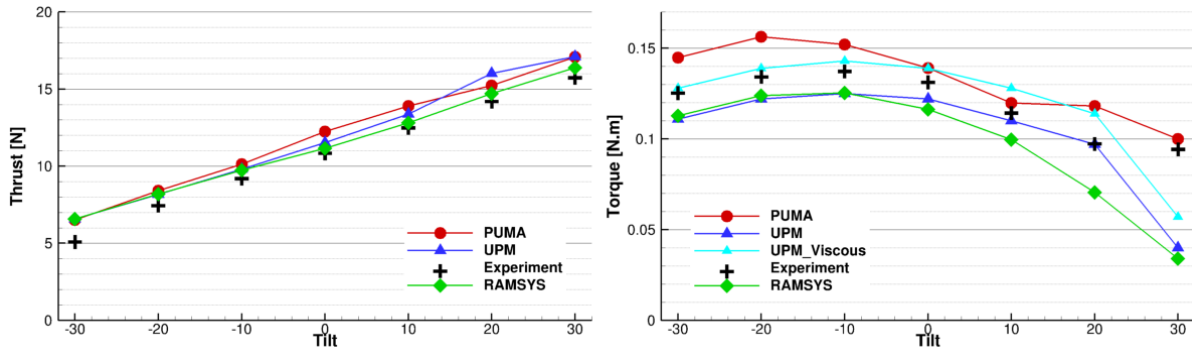

Figure 16: Comparison between experiment and numerical simulations of the KDE12 3 bladed isolated propeller at RPM 5650 and 12.9 m.s^{-1}

5. Dissemination

This paper aims to be an overview of the GARTEUR AG25 activities; therefore it focuses mainly on the objective of the group and the major outcomes that could be expected. More discussions about the results and the physical phenomena involved in rotor / rotor wake interactions can be found in more technical papers that were already released by the different partners of the group.

The Onera experimental setup was the first one to be available; therefore a lot of information is already available in the literature. Details about the experimental setup can be found in [46], [47], [48]. An analysis of the pre-test computations of the installed configuration is available in [12],[26],[43],[42]. Following the analysis of the rotor / propeller interaction, this setup was also used as a starting point for optimization of high speed rotorcraft configurations in [40], [41].

While the DLR experiment on multicopter configuration is still running, details on experiments with an isolated rotor are available in [44]. Furthermore, two papers about experiments and simulations of small rotors are currently under review [45], [49].

6. Conclusions

The present paper described the objectives and major outcomes at the date of writing of the GARTEUR Action Group AG25 research project dealing with rotor / rotor wake interactions. The project started in November 2019 and has a duration of three years with the conclusion planned for the end of 2022.

The experimental activities consist of wind tunnel test campaigns conducted in the ONERA, DLR and PoliMi test facilities. The main objective was to produce some experimental databases for different kind of rotor / rotor interactions to validate numerical tools and improve the understanding of such phenomena. All these experiments are still running and more results will be issued in the coming months.

Most of the partners were also involved in numerical investigations during which in-house or commercial computational tools were applied. This investigation compares codes with each other and with experiment, to improve them if needed and to outline the limitations of the different levels of modelling used. The computations also give access to details that may not be easy to observe in experiment, improving the understanding of the interactions. The computational activities are still

ongoing for most partners.

Finally, a consistent dissemination activity is promoted by the project with different papers presented at conferences or published in relevant scientific journals. Several works are already published, or are currently under preparation and are about to appear in the coming months.

7. Contact Author Email Address

mailto:ronan.boisard@onera.fr

8. Copyright Statement

The authors confirm that they, and/or their company or organization, hold copyright on all of the original material included in this paper. The authors also confirm that they have obtained permission, from the copyright holder of any third party material included in this paper, to publish it as part of their paper. The authors confirm that they give permission, or have obtained permission from the copyright holder of this paper, for the publication and distribution of this paper as part of the ICAS proceedings or as individual off-prints from the proceedings.

9. References

- [1] A. Le Pape, J. Gatard, J-C. Monnier: “Experimental Investigations of Rotor-Fuselage Aerodynamic Interactions Using a Helicopter Powered Model”, 30th European Rotorcraft Forum, Marseille, France, 14-16 September, 2004.
- [2] B.G. van der Wall, A. Bauknecht, S.N. Jung, Y.H. You: “Semi-Empirical Physics-Based Modeling of Fuselage-Rotor and Fuselage-Wake Interferences for Comprehensive Codes”, 70th Annual Forum of the American Helicopter Society, Montreal, Canada, May 20-22, 2014.
- [3] A. Filippone, R. Bakker, P.M. Basset, B. Rodriguez, R. Green, B. Kutz, F. Bensing, A. Visingardi: “Helicopter Wakes in Confined Spaces, including Ground Effect”, 37th European Rotorcraft Forum, Vergiate and Gallarate, Italy, 13-15 September, 2011.
- [4] M. Ramasamy, M. Potsdam, G. K. Yamauchi: “Measurements to Understand the Flow Mechanisms Contributing to Tandem-Rotor Outwash”, 71th Annual Forum of the American Helicopter Society, Virginia Beach, USA, May 21-23, 2015.
- [5] Visingardi, A., Gallas, Q., Gibertini, G., Zagaglia, D., Green, R.B., Giuni, M., “Wind tunnel test campaigns Report,” Deliverable GARTEUR_HC-AG22_WP2.D1, December 2017.
- [6] Visingardi, A., Schwarz, T., Schmid, M., Bakker, R., Voutsinas, S., Andronikos, T., Riziotis V., Boisard, R., Gibertini, G., Barakos, G., Chirico, G., Tan, J., “Final Validation of Codes Report,” Doc. GARTEUR_HC-AG22-WP3.D1, January 2018.
- [7] G.N. Barakos, R. Steijl, M. Woodgate, “CFD for Rotorcraft Recent Progress and new Challenges with the GoAhead case”, 29th Congress of the International Council of the Aeronautical Sciences, St Petersburg, Russia, 8-11 September, 2014.
- [8] M. Ramasamy: “Measurements Comparing Hover Performance of Single, Coaxial, Tandem, and Tilt-Rotor Configurations”, 71th Annual Forum of the American Helicopter Society, Phoenix, USA, May 20-22, 2013.
- [9] Bain, L. J., Landgrebe, A. J., "Investigation of Compound Helicopter Aerodynamic Interference Effects", USAAVLABS Technical Report 67-44, November 1967.
- [10] P. Bowles et al. "A Model-Scale Wind-Tunnel Study of Main Rotor/Propeller Interference", 72nd AHS annual forum, West Palm Beach, Florida, May 17-19, 2016.
- [11] R. Boisard, "Aerodynamic Investigation of a Helicopter rotor Hovering in the Vicinity of a Building", 74th AHS annual forum, Phoenix, Arizona, USA, May 14-17, 2018.
- [12] R. Boisard, "Aerodynamic Investigation of Rotor – Propeller Interactions on a Fast Rotorcraft", 44th European Rotorcraft Forum, Delft, The Netherland, September, 18-20, 2018.
- [13] L. Cambier, S. Heib, S. Plot, “The ONERA elsA CFD software: input from research and feedback from industry,” *Mechanics & Industry*, 14, pp 159-174, 2013.
- [14] R. Steijl, G. N. Barakos and K. Badcock, “A framework for CFD analysis of helicopter rotors in hover and forward flight,” *International Journal for Numerical Methods in Fluids*, vol. 51, pp. 819-847, 2006.

- [15] M. Biava, M. Woodgate and G. N. Barakos, “Fully implicit discrete-adjoint methods for rotorcraft applications,” *AIAA Journal*, vol. 54, p. 735–749, 2015.
- [16] A. F. Antoniadis, D. Drikakis, B. Zhong, G. Barakos, R. Steijl, M. Biava, L. Vigevano, A. Brocklehurst, O. Boelens, M. Dietz and others, “Assessment of CFD methods against experimental flow measurements for helicopter flows,” *Aerospace Science and Technology*, vol. 19, p. 86–100, 2012.
- [17] R. Steijl and G. N. Barakos, “CFD analysis of complete helicopter configurations—lessons learnt from the GOAHEAD project,” *Aerospace Science and Technology*, vol. 19, p. 58–71, 2012.
- [18] A. J. Garcia and G. N. Barakos, “Numerical simulations on the ERICA tiltrotor,” *Aerospace Science and Technology*, vol. 64, p. 171–191, 2017.
- [19] M. Jarkowski, M. A. Woodgate, G. N. Barakos and J. Rokicki, “Towards consistent hybrid overset mesh methods for rotorcraft CFD,” *International Journal for Numerical Methods in Fluids*, vol. 74, p. 543–576, 2014.
- [20] T. Zhang and G. Barakos, “High-fidelity Numerical Investigation of Ducted Propeller Aero-dynamics/Acoustics and Adjoint-based Design Optimisation,” in *77th Annual Forum of the Vertical Flight Society*, 2021.
- [21] F. R. Menter, “Two-Equation Eddy-Viscosity Turbulence Models for Engineering Applications,” *AIAA Journal*, vol. 32, pp. 1598-1605, 1993.
- [22] D. M. O'Brien Jr, “Analysis of computational modeling techniques for complete rotorcraft configurations,” 2006.
- [23] G. N. Barakos, T. Fitzgibbon, A. N. Kusyumov, S. A. Kusyumov and S. A. Mikhailov, “CFD simulation of helicopter rotor flow based on unsteady actuator disk model,” *Chinese Journal of Aeronautics*, vol. 33, pp. 2313-2328, 2020.
- [24] T. Stokkermans, N. van Arnhem, T. Sinnige and L. Veldhuis, “Validation and Comparison of RANS Propeller Modeling Methods for Tip-Mounted Applications,” *AIAA Journal*, vol. 57, pp. 1-15, December 2018.
- [25] T. Zhang and G. N. Barakos, “Toward Vehicle-Level Optimization of Compound Rotorcraft Aerodynamics,” *AIAA Journal*, 60(3), pp. 1937-1957. (doi: 10.2514/1.J061032).
- [26] R. Boisard and J. W. Lim, “Aerodynamic Analysis of Rotor/Propeller Wakes Interactions on High Speed Compound Helicopter,” in *47th European Rotorcraft Forum (virtual)*, 2021.
- [27] A. Visingardi, A. D’Alascio, A. Pagano, P. Renzoni, “Validation of CIRA’s rotorcraft aerodynamic modelling system with DNW experimental data,” in: *22nd European Rotorcraft Forum*, Brighton, UK, 1996, <http://hdl.handle.net/20.500.11881/3171>.
- [28] L. Morino, “A general theory of unsteady compressible potential aerodynamics,” *NASA Technical Reports NASA-CR-2464*, 1974, <https://ntrs.nasa.gov/citations/19750004821>.
- [29] S.R. Ahmed and V.T. Vidjaja. “Unsteady Panel Method Calculation of Pressure Distribution on BO105 Model Rotor Blades”. In: *Journal of the American Helicopter Society* 43.1 (Jan.1998), pp. 47-56.
- [30] J. Yin. “Prediction - and its Validation - of the Acoustics of Multiblade Rotors in Forward Flight Utilising Pressure Data from a 3-D Free Wake Unsteady Panel Method”. In: *20th European Rotorcraft Forum*. Amsterdam, Netherlands, Oct. 1994.
- [31] F. Nitzsche, C. Spieß, R. Leibbrandt, M. Gennaretti, G. Bernardini, J. Serafini, F. Porcacchia, V. Riziotis, G. Papadakis, N. Spyropoulos, A. Siami, D. Hilewit, M. Rafiee, ”A new comprehensive analysis tool for the preliminary design and design evakuation of helicopters – The CORAL”, *47th European Rotorcraft Forum (virtual)*, 2021.
- [32] G. Papadakis and S. G. Voutsinas, “In view of accelerating CFD simulations through coupling with vortex particle approximations,” *Journal of Physics: Conference Series*, vol. 524, no. 1, 2014.
- [33] N. Spyropoulos, G. Papadakis, J. M. Prospathopoulos, and V. A. Riziotis, “Investigating the level of fidelity of an actuator line model in predicting loads and deflections of rotating blades under uniform free-stream flow,” *Applied Sciences*, vol. 11, p. 12097, Dec 2021.
- [34] Kroll, N. and Eisfeld, B. and Bleeke, H.M., The “Navier-Stokes code FLOWer”, in A. Schüller (ed.), “Portable Parallelization of Industrial Aerodynamic Applications (POPINDA)”, *Notes on Numerical Fluid Mechanics*, vol. 71, 1999.
- [35] Kowarsch, U. and Öhrle, C. and Hollands, M. and Keßler, M. and Krämer, E.,”Computation of Helicopter Phenomena Using a Higher Order Method”, in: Wolfgang E. Nagel and Dietmar H. Kröner and Michael M. Resch (eds.), “High Performance Computing in Science and Engineering '13”, 2013.
- [36] U. Schäferlein (né Kowarsch) and M. Keßler and E. Krämer, “Aeroelastic Simulation of the Tail Shake

Phenomenon”, *Journal of the American Helicopter Society*, vol. 63(3), 2018.

- [37] P. Kranzinger and M. Keßler and Ewald Krämer}, ”Advanced CFD-CSD coupling – Generalized, high performant, radial basis function based volume mesh deformation algorithm for structured, unstructured and overlapping meshes”, in: 40th European Rotorcraft Forum, Southampton, UK, 2014.
- [38] C. Öhrle and U. Schäferlein and M. Keßler and E. Krämer, “Higher-order Simulations of a Compound Helicopter using Adaptive Mesh Refinement”, in: 74th Annual Forum of the Vertical Flight Society, Phoenix, Arizona, 2018.
- [39] J. Thiemeier and C. Öhrle and F. Frey and M. Keßler and E. Krämer, “Aerodynamics and flight mechanics analysis of Airbus Helicopters' compound helicopter RACER in hover under crosswind conditions”, *CEAS Aeronautical Journal*, vol. 11(1), 2020.
- [40] T. Zhang, G. N. Barakos, "Aerodynamic Simulation and Adjoint-based Optimisation of Rotorcraft Configurations" 47th European Rotorcraft Forum, UK (Virtual), 2021
- [41] T. Zhang, G. N. Barakos, " Towards Vehicle-level Optimisation of Compound Rotorcraft Aerodynamics", . *AIAA Journal*, 60(3), pp. 1937-1957. (doi: 10.2514/1.J061032)
- [42] T. Zhang, G. N. Barakos, " High-fidelity Numerical Investigations of Rotor-Propeller Aerodynamic Interactions", *Aerospace Science and Technology*, 124, 107517. (doi: 10.1016/j.ast.2022.107517)
- [43] Boisard R., “Numerical Analysis of Rotor / Propeller aerodynamic interactions on a high speed compound helicopter”, *Journal of the American Helicopter Society*, Volume 67, Number 1, January 2022, pp. 1-15, DOI: 10.4050/JAHS.67.012005
- [44] Lößle F., Kostek A., Schmid R.: Experimental measurement of a UAV rotor’s acoustic emission. *Notes on Numerical Fluid Mechanics and Multidisciplinary Design*, Vol. (2020)
- [45] A. A. Kostek, F. Lößle, R. Wickersheim, M. Keßler, R. Boisard, G. Reboul, A. D. Gardner: Experimental investigation of UAV rotor aeroacoustics and aerodynamics with computational cross-validation. 48th European Rotorcraft Forum (2022)
- [46] L. Lefevre, J. Delva, V. Nowinski, “Experimental evaluation of the aerodynamic rotor/propeller interactions in hybrid compound helicopters” 47th European Rotorcraft Forum, Sep 2021, Virtuel, France. (hal-03386087)
- [47] L. Lefevre, V. Nowinski, “Characterization of the propeller for the experimental evaluation of the aerodynamic rotor/propeller interactions in hybrid compound helicopters”, ODAS Onera-DLR Aerospace Symposium ODAS, Nov 2020, Braunschweig, Germany. (hal-03104009)
- [48] L. Lefevre, J. Delva, V. Nowinski, A. Dazin, “Experimental Evaluation of the Aerodynamic Rotor/Propeller Interactions on High Speed Helicopters, Efforts and Velocity Fields Measurements”, 78th VFS Annual Forum, Fort Worth, Tx, USA, May 10-12, 2022.
- [49] F. Lößle, A. A. Kostek, C. Schwarz, R. Schmid, A. D. Gardner, M. Raffel: Aerodynamics of Small Rotors in Hover and Forward Flight. 48th European Rotorcraft Forum (2022)