



HAL
open science

Measuring accurate Angle of Arrival of weak LoRa signals for Indoor Positioning

Hussein Zeaiter, François Spies, Oumaya Baala, Thierry Val

► **To cite this version:**

Hussein Zeaiter, François Spies, Oumaya Baala, Thierry Val. Measuring accurate Angle of Arrival of weak LoRa signals for Indoor Positioning. 12th International Conference on Indoor Positioning and Indoor Navigation (IPIN 2022), Sep 2022, Beijing, China. 10.1109/IPIN54987.2022.9918114 . hal-03932846

HAL Id: hal-03932846

<https://hal.science/hal-03932846v1>

Submitted on 10 Jan 2023

HAL is a multi-disciplinary open access archive for the deposit and dissemination of scientific research documents, whether they are published or not. The documents may come from teaching and research institutions in France or abroad, or from public or private research centers.

L'archive ouverte pluridisciplinaire **HAL**, est destinée au dépôt et à la diffusion de documents scientifiques de niveau recherche, publiés ou non, émanant des établissements d'enseignement et de recherche français ou étrangers, des laboratoires publics ou privés.

Measuring accurate Angle of Arrival of weak LoRa signals for Indoor Positioning

ZEAITER Hussein

FEMTO-ST Institute, Univ. Bourgogne Franche-Comté, CNRS FEMTO-ST Institute, Univ. Bourgogne Franche-Comté, CNRS
UFC, Montbéliard France
hussein.zeaiter@femto-st.fr

SPIES Francois

FEMTO-ST Institute, Univ. Bourgogne Franche-Comté, CNRS
UFC, Montbéliard France
francois.spies@femto-st.fr

BAALA Oumaya

FEMTO-ST Institute, Univ. Bourgogne Franche-Comté, CNRS
UTBM, Belfort, France
oumaya.baala@femto-st.fr

VAL Thierry

IRIT-RMESS Institute, Univ. Toulouse, CNRS
IUT, UT2J Blagnac, France
thierry.val@univ-tlse2.fr

Abstract—In this paper, we propose an Autocorrelation method for measuring the angle of arrival (AoA) of a weak LoRa signal. A weak LoRa signal has a negative SNR down to -20 dB. The objective is to detect a LoRa signal that operates at low transmission power (TX). Operating at low transmission power (TX) reduces power consumption and extends the battery life of LoRa devices. Besides, the transmission of weak signals strengthens the radio communication protocol, preventing an enemy device from accessing the location coordinates. The detecting algorithm consists of finding Autocorrelation peaks of the LoRa signal. We show that Autocorrelation peaks decrease when the signal is buried in the noise. However, using a large number of Fast Fourier Transform (FFT) will increase the Autocorrelation peaks and the signal-to-noise ratio (SNR). Once the peak of the LoRa signal is detected under the noise, the algorithm will calculate the AoA. All of the proposed algorithms are implemented using a Universal Software Radio Peripheral (USRP), Software Defined Radio (SDR) receiver with the help of GNU Radio software. We, therefore, believe that our Autocorrelation method can detect the LoRa signal accurately and measure the AoA at very low SNR in real-time, being usable for indoor positioning.

Index Terms—Autocorrelation function (ACF), peak detection, Fast Fourier Transform (FFT), Software Defined Radio (SDR), Angle of Arrival (AoA), Long-Range (LoRa), Negative SNR.

I. INTRODUCTION

Nowadays, The Internet of Things (IoT) is experiencing rapid growth. The IoT is a network of connected devices that enables connectivity and data exchange for a wide range of applications, including smart cities, healthcare, industrial and infrastructural applications, transportation, and navigation [1]. IoT applications face many challenges, including security, low-cost devices, long-range communication, low data rate,

This work is supported by the Femto-st institute in collaboration with Jolliet-Innovation and SECA companies in the framework of the SYLOIN FEDER BPI Project.

and low power consumption. Today, we can address these challenges with the new low power wide area network (LPWAN) paradigm. LPWAN standards enable wide communication coverage, low data rates, and long battery life. These advantages led the researchers to investigate the performance of the LPWAN technology both outdoors and indoors [2, 3]. Many LPWAN technologies have been studied recently, such as LoRaWAN, Sigfox, and NB-IoT. LoRaWAN is one of the latest LPWAN technologies that has attracted many researchers interest in outdoor and indoor navigation [4, 5, 6].

LoRaWAN is a communication protocol and network architecture built on top of the LoRa physical layer. LoRa [7] is a radio technology based on Chirp Spread Spectrum modulation (CSS) operating at industrial, scientific, and medical (ISM) bands (169 MHz, 433 MHz, 868 MHz, 915 MHz, and 2.4 GHz). The most important benefit of the LoRa technology is the CSS modulation which enables a receiver device to demodulate a transmission up to -20 dB below the noise level. Demodulating a LoRa signal below the noise level reduces the battery lifetime of the LoRa device, makes the transmission distance longer, and secures our LoRa communication. All these benefits make LoRa an ideal candidate for indoor tracking. However, detecting a low signal transmission and maintaining a good location accuracy is always a challenge for most indoor tracking applications.

Software Defined Radio (SDR) is a well-known concept in radio tracking, bringing new possibilities, and allowing us to study existing technologies and detect a weak signal transmission and track it. First, a weak signal can be detected by several methods. Detection can be done using some mathematical tools such as Autocorrelation. Autocorrelation [8] consists of determining the degree of similarity of the same variables between two successive time intervals. Second, tracking the signal can be done using the Angle of Arrival

(AoA) positioning and tracking approach. AoA approach has been used in numerous fields, including tracking people and objects.

In this paper, we present an Autocorrelation approach for detecting and measuring the AoA of a weak LoRa signal using an SDR. The main idea consists of detecting the LoRa frequency peaks. The Autocorrelation technique offers an effective way to improve the SNR by reducing the unwanted noise components by a factor of n . Once the signal is detected, The AoA can be calculated using the method described in our previous work [9]. To the best of our knowledge, no such system can measure the AoA of a LoRa signal up to -20 dB below the noise level.

The rest of the paper is organized as follows. Section II describes the existing LoRa AoA estimation solutions. Section III explains the Autocorrelation method. Section IV presents the implementation and setup of the Fast Autocorrelation method for tracking a LoRa signal using SDR. In section V, we evaluate the effectiveness of the system based on real experiments. In section VI, we conclude the paper and outline future research.

II. RELATED WORKS

The problem of detecting and measuring the AoA of radio signals in localization and tracking services is a rapidly developing area of science and technology. Developing new AoA methods is always a challenge for the research community. LPWAN technologies such as the Long-Range (LoRa) can provide a localization solution based on the time difference of arrival (TDoA) and the received signal strength (RSS) [10, 11, 12, 13]. Recently, some research works are trying to mix the RSS, and TDoA techniques with the angle of arrival (AoA) estimation method using the LoRa technology to provide a good localization solution [14, 15]. LPWAN technologies, including LoRa, utilize a minimum amount of power and a narrow bandwidth to transmit a signal. An RSS-based LoRa localization solution can't offer a good localization accuracy since lowering the power consumption of the LoRa device might result in a lower quality of the RSS and more multipath effect and channel fading. Time-based LoRa localization solutions such as ToA and TDoA also suffer from poor localization accuracy because they require a larger bandwidth or a high timestamp precision of the received signal at the gateway receiver. Addressing these limitations can be done using the AoA estimation technique [16]. Using an AoA-based localization solution has several advantages. First, unlike the TDoA technique, the AoA technique does not require a large signal bandwidth and a high timestamp precision at the receiver. Secondly, the AoA-based localization solutions measure the angle between the transmitter and the receiver by measuring the phase of the received signal at the receiver gateway. Consequently, the narrow bandwidth of the LoRa signal will not affect the phase of the signal and, therefore, the accuracy of the AoA of the received signal. Third, the AoA technique does not depend on the received signal strength and, therefore, the phase and the angle of the received signal will

not be affected by the multipath and channel fading. These benefits make the AoA a promising localization solution for the indoor environment.

Recently, AoA-based LoRa localization solutions have been introduced in the literature. In [17], an AoA localization technique of LoRa signals based on an SDR receiver has been proposed. The proposed method found an estimation error of 2° in LOS (Line-of-Sight), and 10° in NLOS. However, this method consists of 8-element uniform linear array (ULA). The 8 ULA consists of 8 independent SDR receivers for which a hand-crafted crystal oscillator is needed to achieve synchronization between the channels. Another AoA-based LoRa localization approach based on phase detectors has been presented in [18]. The phase detectors make a cost-effective solution to measure the AoA with median and maximum estimation errors of 4° and 14° , respectively.

Recently, we introduced the SDR-based localization system that can estimate the AoA of a LoRa signal by measuring the phase difference of the received signal at two antennas [9]. We built our system based on an individual universal software radio peripheral (USRP) B210 SDR receiver. The choice of this front-end receiver was motivated by its two coherent RX channels. The prototype has been tested in an indoor laboratory office environment with a lot of furniture. The experimental results show that the AoA of the LoRa signal can be measured accurately with a maximum estimation error of 5° in the range of $[0^\circ, 180^\circ]$. However, our system can only achieve an accurate AoA measurement with high signal-to-noise ratio (SNR) communication. In this paper, we aim to validate our AoA-localization system with a very low SNR up to -20 dB. A new approach is proposed to detect and measure the AoA of a very weak LoRa transmission signal. The presented approach is based on two-antenna reception to exploit the Fast autocorrelation signal detection and the phase difference AoA measurement. We, therefore, believe that an accurate AoA of a weak LoRa signal reduces the battery lifetime, extends the communication lifetime, and secures the communication of the LoRa devices. To the best of our knowledge, we are the first to implement a real AoA for a very weak LoRa signal.

In the following section, we will provide an overview of the two-antenna autocorrelation technique for weak signal detection.

III. DUAL-ANTENNA FAST-AUTOCORRELATION

A. Autocorrelation Function

An Autocorrelation is a signal processing tool used to separate useful signal from noise. The Autocorrelation analysis consists of finding the presence of useful segments in a signal. The autocorrelation of a signal is just the correlation coefficient. However, instead of applying the correlation between two different signals, the correlation is between the two segments of the same signal at times T_i and T_{i+k} .

Suppose we have two continuous signals $x(n)$, $y(n)$, $n = 1, 2, 3, \dots, N$, where N is the number of samples. The discrete

correlation function of the two signals can be calculated by the following equation:

$$Corr(x, y)_k = \frac{1}{N} \sum_{n=0}^{N-1} x_{k+n} y_n \quad (1)$$

Equation (1) measures the correlation function of the two signals. When the two signals are similar, then their correlation coefficient will be 1. However, if the two signals are different, then their correlation coefficient will be 0. If we suppose that $y(n) = x(n)$, then Equation (1) will be:

$$Corr(x, x)_k = \frac{1}{N} \sum_{n=0}^{N-1} x_{k+n} x_n \quad (2)$$

Equation (2) measures the correlation function between two same signals $x(n)$ and $x(n+k)$ separated by a time lag k , which is the autocorrelation function of the signal $x(n)$. The autocorrelation function presented by (2) reaches its maximum value at the lag=0, and is always symmetric around zero, which means that the autocorrelation values are equals at lags $+k$ and $-k$. Using these properties, it is possible to detect weak signals. Using the FFT with the autocorrelation function is described in the following section.

B. Fast Fourier Transform Autocorrelation

An FFT is an important signal processing tool used in most digital signal processing (DSP) applications. As the name implies, the FFT is a fast version of the Discrete Fourier Transform (DFT). FFT is an algorithm used to perform a series of computations that computes DFT much more rapidly than the other available algorithms. Therefore, using FFT will reduce the number of calculations necessary. Let $x(n)$ be a discrete signal, the Discrete Fourier Transform of $x(n)$ is given by:

$$X_k = \sum_{n=0}^{N-1} x_n e^{-i2\pi kn/N} \quad k = 0, 1, 2, \dots, N-1 \quad (3)$$

Equation (3) represents the DFT computation of N -point data sequence with $O(N^2)$ multiplies and adds. Thus, when using FFT, the computation would take $O(N \log N)$ multiplies and adds.

Signal detection is a key function of the FFT. Using FFT and the autocorrelation function can accelerate the autocorrelation computation. The Wiener-Khinchin theorem [18] states that the autocorrelation function and the Power Spectral Density (PSD) of the signal are Fourier pairs. The autocorrelation function is the Fourier transform of the PSD.

Let $x(n)$, $y(n)$ be two discrete signals, the correlation function is defined by:

$$Corr(x, y)_k \Leftrightarrow X(f)Y^*(f) \quad (4)$$

From Equation (4), the correlation function of the two signals can be obtained by multiplying the FFT of one signal by the complex conjugate of the FFT of the other signal. As

the autocorrelation function of $x(n)$ is the correlation with its delay copy, the autocorrelation will therefore be as follows:

$$Corr(x, x)_k \Leftrightarrow X(f)X^*(f) \equiv |X(f)|^2 \quad (5)$$

Where $|X(f)|^2$ is the Power Spectral Density of the signal. Using these properties of autocorrelation function and FFT, it is possible to detect weak signal buried in noise.

The next section describes how to detect weak signals using Autocorrelation, FFT, and Dual-Antenna detection.

C. Dual-Antenna weak signal detection

This section discusses the Dual-Antenna Autocorrelation detection. The proposed detection method measures the Autocorrelation function between outputs of two sensors of the receiving antenna array.

The dual-Antenna approach is a very promising topic in radio communication systems. For the receiver side, Dual-Antenna offers a high potential solution to receive two replicas of the primary signal. The Correlation method can be used to determine whether the primary signal exists or not.

Figure 1 shows two signals $XI(t)$ and $X2(t)$ received by the antennas A1 and A2 respectively. When the transmitter and the receiver are in Line-Of-Sight (LOS) conditions, there will be a time delay $\Delta(t)$ between the two signals received at the two antennas. Since the two signals $XI(t)$ and $X2(t)$ are the same time series data received at a different time by the two antennas, $XI(t) = X2(t + \Delta(t))$.

Using the properties of the correlation function between two same signals separated by a time lag t given by the Equation (2), and the Fast Autocorrelation function using FFT given by Equation (5), the detection of the signal using a Dual-Antenna receiver is possible.

By collecting enough samples of the received signals, the Fast Autocorrelation, of the signals received from the two Antennas can be built. Based on the Autocorrelation peaks finding and the threshold value, signal detection can be carried out.

In the next section, we present our solution of detecting a LoRa signal using a Dual-Antenna USRP B210 SDR Receiver with the help of GNU Radio.

IV. PROPOSED METHOD

The following method consists of detecting weak LoRa signals on a Dual-Antenna Receiver by measuring the Fast Autocorrelation function. We first determine whether the LoRa signal exists by using the Fast Autocorrelation signal detection. Then, we measure the AoA of the detected signal based on our published work [9]. Finally, we compare the two methods in terms of accuracy level. The USRP B210 SDR receiver and the GNU Radio development environment form the basis for this research work.

A. USRP-Based SDR Receiver

Most Traditional radios use integrated circuits and specialized equipment for transmission and reception. Traditional

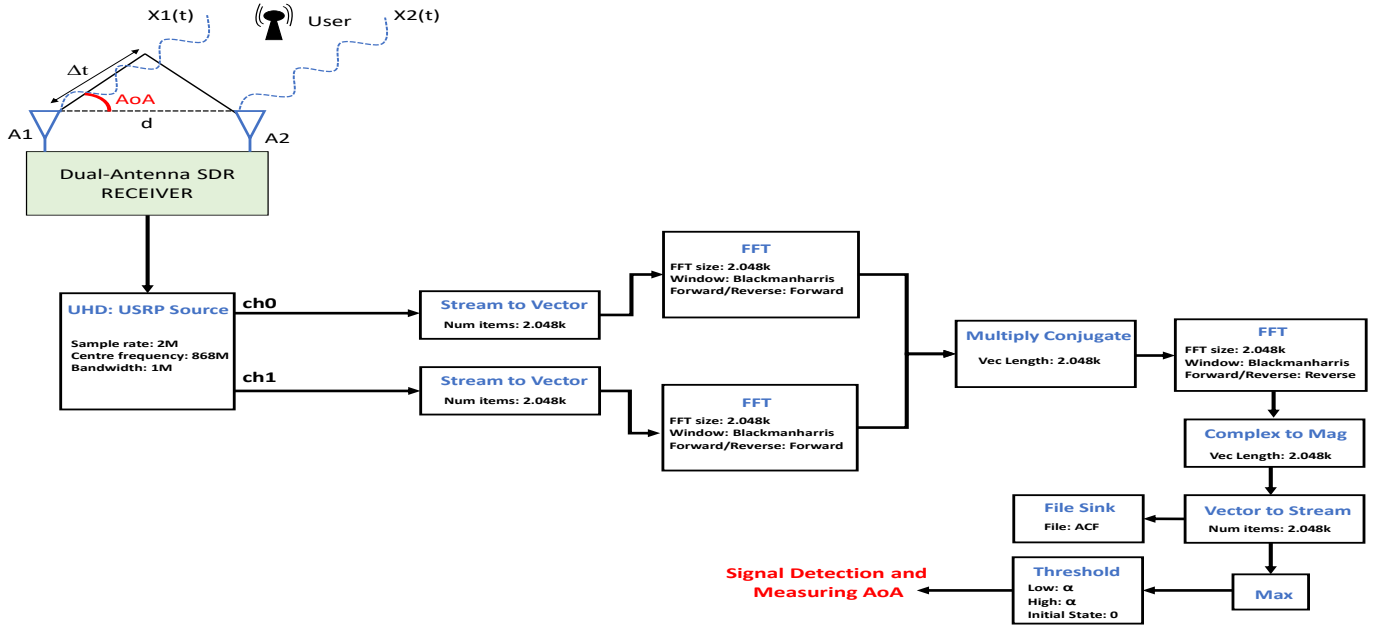

Fig. 1. A GNU Radio flow graph of the proposed system

radios are made up of mixers, amplifiers, analog/digital converters, modulators, and demodulators. An innovative concept named software defined radio (SDR) replaced the analogical traditional radios. In an SDR, signal processing functions are performed by a single device, which performs the functions of multiple hardware radios. Most of the functionality of the SDR are implemented in software rather than in hardware. GNU Radio founder Eric Blossom cites that the SDR is the technique of getting code as close as possible to the antenna. It turns radio hardware problems into software problems [19].

Ettus Research is one of the companies that have developed an open source hardware platform dedicated to the SDR. The development was focused on the Universal Software Radio Peripheral (USRP). The USRP is characterized by its accuracy, large bandwidth and low price compared to other hardware systems. This open source device defines the interface between the RF analog domain and the General Purpose Processor (GPP) and can generate and receive any kind of signals. The USRP can receive radio waves captured by the antenna and convert these waves into a digital signal that can be processed by the computer using an analog to digital converter (ADC). On the other hand, to generate a radio wave, the USRP converts a digital wave processed by the computer into a RF signal using a digital to analog converter (DAC).

The model of USRP used in this research was the USRP B210. The USRP B210 is a Dual channel SDR receiver which contains 2TX and 2RX ports with fully coherent 2×2 MIMO (Multiple Input Multiple Output) capabilities. The coherency between the 2RX ports is an important feature for computing the phase difference and the AoA between the received signals [9]. The B210 covers frequencies from 70 MHz to 6 GHz with a maximum bandwidth of 56 MHz in real-time. Moreover, this

SDR board combines the Spartan6 FPGA, and the AD9361 transceiver that performs the conversion of ADC and DSP. The B210 can be connected directly to a computer via a high-speed Ethernet local area network cable or a USB 2.0/3.0 cable and is compatible with the software development platform GNU Radio.

B. GNU Radio

GNU Radio is one of the most popular software platforms used to interface with a USRP SDR. The USRP implements the hardware part of the system, whereas GNU Radio handles the software part.

GNU Radio provides signal processing blocks for the development of SDR applications. The blocks are written using the C++ programming language, and the connection between them is provided by the Python programming language. GNU Radio is widely used by academic research as well as in the industrial and commercial domain.

In the rest of this paper, the USRP B210 is used combined with GNU Radio development software platform.

C. USRP B210 Fast Autocorrelation signal detection

The block diagram in Figure 1 shows the basic principle of our proposed solution. The process starts by extracting the two signals received at the two channels using a *UHD: USRP Source* block which receives the data from the B210 receiver through the USB3.0 cable. Thereafter, the two signals diverge into two paths. For each path, the output of the *UHD: USRP Source* block is passed through a *Stream to Vector* block. The *Stream to Vector* block transforms the data in I and Q format. Now that the data are in I and Q format, the *FFT* block computes the FFT to transform the data from time domain to frequency domain. Up until this point the data are in the

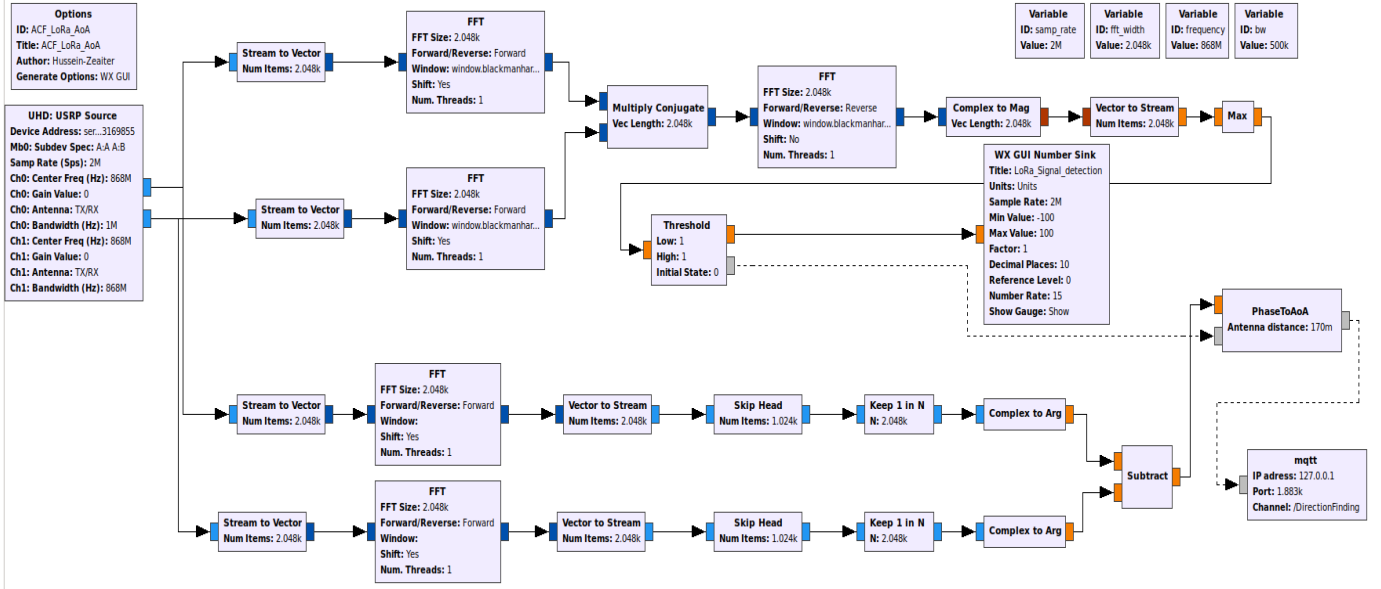

Fig. 2. A GRC flow graph for the USRP B210 to compute the FFT Autocorrelation and AoA Measurements

frequency domain for each path, the *Multiply Conjugate* block performs the multiplication of the output of the first path by the conjugate of the output of the second path. To get back the data in the time domain, the result of the *Multiply Conjugate* block is passed through the *FFT* block which performs a reverse FFT to convert the data from the frequency domain to the time domain. Until now, the data are in complex vector format. The *Complex to Mag* block provides the magnitude in a float format. The *Vector to Stream* block performs the opposite function of the conversion done by the *Stream to Vector* block. It transforms the data back to the stream format and sends it to the *Max* block. Up to this point, the data are in stream float format in the time domain. Since the Autocorrelation function has a maximum peak at lag=0, the algorithm should find this peak. This is done by the *Max* block which takes a stream of data as its input and gives their maximum value as its output.

Once the maximum of the peak value is found, the output of the *Max* block is passed to the *Threshold* block. The *Threshold* block is used to compare the output of the Fast Autocorrelation detection algorithm with a predefined threshold. This block has two parameters: *High* value and *Low* value. If the output of the *Max* block is higher than the value set for the *High* parameter, the output of the *Threshold* block is 1. On the other hand, if the output of the *Max* block goes below the value set for the *Low* parameter, the output of the *Threshold* block is 0. The decision output of the Fast Autocorrelation detection algorithm is given by the following equation:

$$Decision = \begin{cases} 1 & \text{if } Max > \alpha \\ 0 & \text{if } Max \leq \alpha \end{cases} \quad (6)$$

where *Max* is the peak of the Fast Autocorrelation detection and α is the predefined threshold. The predefined threshold α is determined using a post processing analysis. The *FileSink*

block is used to write the data in an empty file. The written data are processed in Matlab to determine the optimum predefined threshold value.

The case when the value of the *Decision* is equal to 1 meaning that the signal is detected, and the case when the value of the *Decision* is equal to 0 meaning that there is no signal. Once the signal is detected, the algorithm computes the AoA using the phase difference method implemented in [9]. The implementation of each block shown in Figure 1 is shown in Figure 2. A full description of the phase difference and AoA measurement blocks can be found in [9].

V. EXPERIMENTATION AND RESULTS

The proposed method was evaluated by performing an experimental measurement in our indoor research laboratory. The equipment setup and experimental measurement results will be discussed in detail in the following sections.

A. Equipment Setup

The FFT Autocorrelation signal detection and AoA measurement is implemented with GNU Radio and USRP B210 SDR receiver for capturing a LoRa signal.

The real time LoRa signal captured by the USRP B210 is transmitted by the Adafruit Feather M0 transceiver containing a RFM95 LoRa module. The Adafruit Feather M0 combines an Arduino-based microcontroller with a LoRa radio module. The radio transceiver can transmit or receive radio signals at both frequencies 868 MHz and 915 MHz, which can be programmed in software. The Feather M0 transceiver was programmed using the Arduino IDE development toolkit via a USB-to-Serial program. The transmitted signal was configured with the frequency 868 MHz.

In the receiving end, the signal was received using the USRP B210 SDR which was connected using USB3.0 high

speed connectivity to a PC running Linux. The SDR card was configured with the GNU Radio Companion (GRC) 3.7 and the USRP hardware Driver (UHD) 3.14.0. The GNU Radio Companion (GRC) is a graphical user interface used to compile GNU Radio flow graphs. The B210 was configured with the following parameters: center frequency: 868 MHz, sampling rate = 2 MHz, and the bandwidth is 1 MHz.

The Feather M0 LoRa transceiver and the USRP B210 are both equipped with a quarter-wavelength commercial off-the-shelf omnidirectional antenna. Both transmitter and receiver were fixed on a tripod with a Line-Of-Sight (LOS) condition. The complete equipment setup is shown in Figure 3.



Fig. 3. The complete installation setup. Both Feather M0 and USRP B210 are fixed on the tripod.

B. Measurement data

For the measurement data, a LoRa signal was transmitted using a Feather M0 with the following parameters: frequency = 868 MHz, bandwidth = 125 kHz, spreading factor = 7, and coding rate = 4/5. On the USRP B210 side, we assume that the sampling frequency is equal to 2 MHz, and the number of sampled points (FFT length) is equal to 1024 by default.

The experiments were divided into two parts: the first was to identify the suitable FFT length in order to improve the detection accuracy at very low power transmission (TX) or signal to noise ratio (SNR). The second was to measure the AoA of the LoRa signal at each SNR level.

In experiment 1, the transmitter is programmed to transmit a signal with a transmission power going from +20 dBm to -1 dBm. The detection accuracy of the proposed method is measured for different FFT length. The performance of the algorithm is shown in Figure 4. When the FFT length is equal to 1024, the LoRa signal can be detected effectively when

the SNR is greater than -12 dB. When the FFT length is equal to 65536, the detection of the LoRa signal increases to -20 dB. The detection performance of the LoRa signal can be improved effectively when increasing the FFT length because the autocorrelation of noise become smaller when increasing the FFT length. Figure 5 and 6 show respectively the values of the autocorrelation peaks for the LoRa signal with two different FFT length. It clearly appears that when using an FFT length equal to 65536 (sample size 30 Hz), the autocorrelation peaks are easier to detect than using an FFT length equal to 1024 (sample size 2 kHz). Therefore, the detection performance of the algorithm is better at high FFT length. In our next experiment, the FFT length is chosen to be equal to 65536.

In experiment 2, we measured the AoA of the LoRa signal at three different SNR levels: 20 dB, 0 dB, and -20 dB. For each SNR level, the AoA was measured in the range of [0, 180] degrees with 15 degrees increments. The results of this measurement is illustrated in Figure 7. We can clearly notice that for an SNR equal to 20dB, the measured AoA are very close to the real AoA values. The angular deviation increases significantly when the measurements were taken with SNR equal to 0dB. For an SNR equal to -20dB, the algorithm still gives a good measurements accuracy for AoA between 45 degrees and 135 degrees. The angular deviation increases exponentially for AoA less than 45 degrees and greater than 135 degrees. Therefore, the AoA accuracy is better for large angles when the SNR is equal to -20 dB. The AoA deviation error of this experiment is shown in Figure 8. When the SNR is equal to 20 dB, the algorithm can successfully measure the AoA with a deviation error less than 4 degrees in the range of [45, 135] degrees, and less than 6 degrees for small angles. Otherwise, when the SNR decreases to 0 dB and -20 dB, the deviation error increases to 9 and 12 degrees respectively for small angles.

According to these experimental results, we can indicate an efficient method to deploy an indoor location infrastructure exploiting low AoA. Indeed, the alignment of the dual antennas of a LoRa gateway must favor the angles located between 45 and 135 degrees in the building so that the other angle values are as much as possible outside the building as can be seen on the Figure 9. Thus, the accuracy of the AoA will be in the range 7 to 8 degrees. With this topology, the best accuracy will be obtained at the center of the building where the AoA are in the green area, while the worst accuracy will be obtained at the building edges where the AoA are in the red area. For an angle with 8 degrees of accuracy, the accuracy will be about 1 meter at a distance of 8 meters. To maintain an accuracy of less than one meter, the distance between two LoRa gateways in the building will be approximately 16 meters. During a critic situation, it will be possible for a gateway to send a specific message to an object in order to ask for a full transmit power reply to improve the accuracy with a factor of nearly 4.

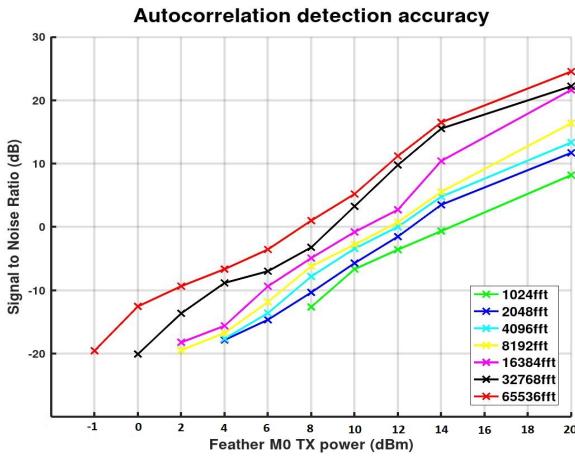

Fig. 4. Autocorrelation detection accuracy for different FFT length

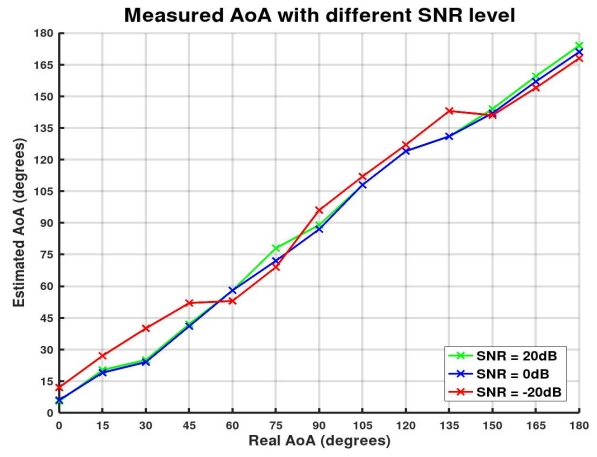

Fig. 7. AoA measurements with different SNR level

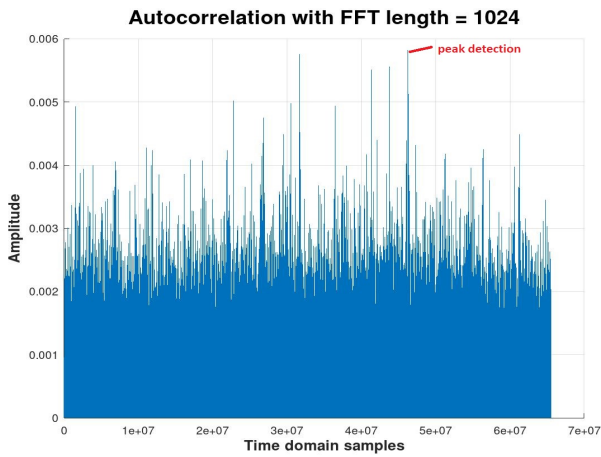

Fig. 5. Autocorrelation peaks detection with FFT equal to 1024

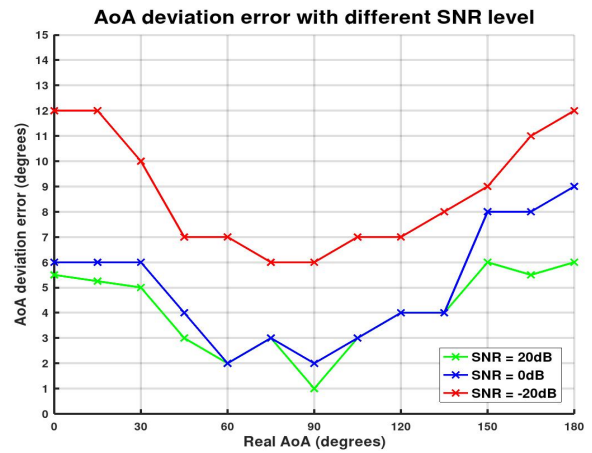

Fig. 8. AoA deviation error with different SNR level

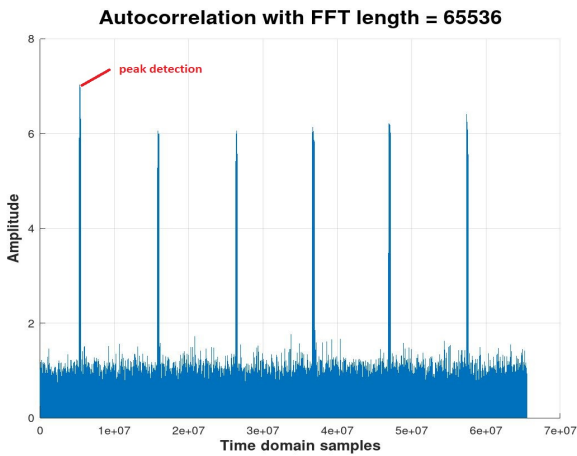

Fig. 6. Autocorrelation peaks detection with FFT equal to 65536

CONCLUSION

In this paper, we described the advantage of Autocorrelation function in detecting weak signals under the noise up to -20 dB

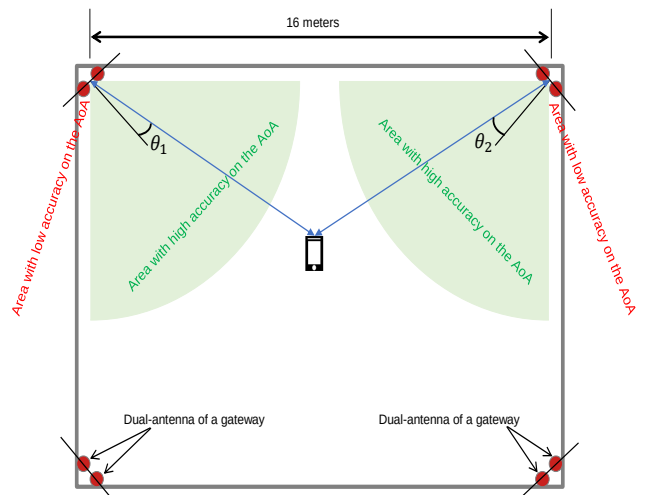

Fig. 9. Indoor location infrastructure exploiting AoA

threshold. Beyond this improvement, the Autocorrelation of a received signal captured on 2 antennas makes it possible to maintain a very good accuracy of the Angle of Arrival (AoA). An accurate AoA on weak signals allow us to strengthen our existing localization algorithms which will merge signal attenuation, time of flight and AoA to make our coordinate calculations more robust. Moreover, our location functions are able to work in a larger space. Additionally, the asymmetry of the transmission power between the gateway and the object makes it possible to extend the communication lifetime of the objects both by reducing the transmission power and by facilitating the reception of strong signals coming from the gateway. Allowing objects to transmit weakly improves the stealth and the confidentiality of exchanges and makes it more difficult for an enemy device to receive and locate our broadcasting. Using low power transmissions allow us a significant budget link inside a building because the reception threshold is very low, between -125 and -140 dBm, conducting to a communication distance longer than Wi-Fi with a power transmission at 100 mW. Finally, we believe that it will be possible to decode the simultaneous transmission of 2 or 3 objects to avoid collisions and limit re-transmissions which would become unnecessary.

ACKNOWLEDGMENT

This work is a partnership with Jolliet and SECA companies and is funded by the Franche-Comté region, the European FEDER fund and the French Public Investment Bank (Banque Publique d'Investissement). Authors want to warmly thank Stephane Givron for his highly valuable contribution.

REFERENCES

- [1] Rosilah Hassan et al. "Internet of Things and Its Applications: A Comprehensive Survey". In: *Symmetry* 12.10 (2020). ISSN: 2073-8994. DOI: 10.3390/sym12101674. URL: <https://www.mdpi.com/2073-8994/12/10/1674>.
- [2] Ahmad Muzaffar Baharudin and Wanglin Yan. "Long-range wireless sensor networks for geo-location tracking: Design and evaluation". In: *2016 International Electronics Symposium (IES)*. 2016, pp. 76–80. DOI: 10.1109/ELECSYM.2016.7860979.
- [3] Faheem Zafari, Athanasios Gkelias, and Kin K Leung. "A survey of indoor localization systems and technologies". In: *IEEE Communications Surveys & Tutorials* 21.3 (2019), pp. 2568–2599.
- [4] Wongeun Choi et al. "Low-Power LoRa signal-based outdoor positioning using fingerprint Algorithm". In: *ISPRS International Journal of Geo-Information* 7.11 (2018), p. 440.
- [5] Carvalho D. Fernandes et al. "Hybrid indoor and outdoor localization for elderly care applications with LoRaWAN". In: *2020 IEEE International Symposium on Medical Measurements and Applications (MeMeA)*. 2020, pp. 1–6. DOI: 10.1109/MeMeA49120.2020.9137286.
- [6] Kyungki Kim et al. "Feasibility of LoRa for smart home indoor localization". In: *Applied Sciences* 11.1 (2021), p. 415.
- [7] Lorenzo Vangelista. "Frequency shift chirp modulation: The LoRa modulation". In: *IEEE Signal Processing Letters* 24.12 (2017), pp. 1818–1821.
- [8] sciencedirect. *Autocorrelation*. URL: <https://www.sciencedirect.com/topics/mathematics/autocorrelation>.
- [9] Zeaiter Hussein et al. "SYLOIN: Measuring Angle of Arrival of LoRa signals using Software Defined Radio". In: *2021 International Conference on Indoor Positioning and Indoor Navigation (IPIN)*. 2021, pp. 1–8. DOI: 10.1109/IPIN51156.2021.9662518.
- [10] Mahnoor Anjum et al. "RSSI Fingerprinting-Based Localization Using Machine Learning in LoRa Networks". In: *IEEE Internet of Things Magazine* 3.4 (2020), pp. 53–59. DOI: 10.1109/IOTM.0001.2000019.
- [11] Ka-Ho Lam, Chi-Chung Cheung, and Wah-Ching Lee. "RSSI-Based LoRa Localization Systems for Large-Scale Indoor and Outdoor Environments". In: *IEEE Transactions on Vehicular Technology* 68.12 (2019), pp. 11778–11791. DOI: 10.1109/TVT.2019.2940272.
- [12] Ioannis Daramouskas et al. "Localization in LoRa Networks Based on Time Difference of Arrival". In: *International Conference on Computer and Information Science*. Springer. 2021, pp. 130–143.
- [13] Nico Podevijn et al. "TDoA-based outdoor positioning in a public LoRa network". In: *12th European Conference on Antennas and Propagation (EuCAP 2018)*. IET. 2018, pp. 1–4.
- [14] Kyung-Jin Baik, Sangjoon Lee, and Byung-Jun Jang. "Hybrid RSSI-AoA Positioning System with Single Time-Modulated Array Receiver for LoRa IoT". In: *2018 48th European Microwave Conference (EuMC)*. 2018, pp. 1133–1136. DOI: 10.23919/EuMC.2018.8541736.
- [15] Michiel Aernouts et al. "Combining TDoA and AoA with a particle filter in an outdoor LoRaWAN network". In: *2020 IEEE/ION Position, Location and Navigation Symposium (PLANS)*. 2020, pp. 1060–1069.
- [16] Noori BniLam et al. "Adaptive probabilistic model using angle of arrival estimation for IoT indoor localization". In: *2017 International Conference on Indoor Positioning and Indoor Navigation (IPIN)*. 2017, pp. 1–7. DOI: 10.1109/IPIN.2017.8115864.
- [17] Noori BniLam et al. "LoRay: AoA estimation system for long range communication networks". In: *IEEE Transactions on Wireless Communications* 20.3 (2020), pp. 2005–2018.
- [18] Noori BniLam, Samer Nasser, and Maarten Weyn. "Angle of Arrival Estimation System for LoRa Technology based on Phase Detectors". In: Apr. 2022.
- [19] Blossom Eric. *Exploring Gnu Radio*. URL: <http://www.gnu.org/software/gnuradio/doc/exploring-gnuradio.html>.