



HAL
open science

Optimization of the Synthetic Jet to improve aerodynamic efficiency of the Next Generation Civil Tilt Rotor Aircraft

Dinh Hung Truong, Abderahmane Marouf, Yannick Hoarau, Alain Gehri, Jan B. Vos

► **To cite this version:**

Dinh Hung Truong, Abderahmane Marouf, Yannick Hoarau, Alain Gehri, Jan B. Vos. Optimization of the Synthetic Jet to improve aerodynamic efficiency of the Next Generation Civil Tilt Rotor Aircraft. TSAS2022 Towards Sustainable Aviation Summit, Toulouse, France 2022, Oct 2022, Toulouse,, France. hal-03931905

HAL Id: hal-03931905

<https://hal.science/hal-03931905v1>

Submitted on 9 Jan 2023

HAL is a multi-disciplinary open access archive for the deposit and dissemination of scientific research documents, whether they are published or not. The documents may come from teaching and research institutions in France or abroad, or from public or private research centers.

L'archive ouverte pluridisciplinaire **HAL**, est destinée au dépôt et à la diffusion de documents scientifiques de niveau recherche, publiés ou non, émanant des établissements d'enseignement et de recherche français ou étrangers, des laboratoires publics ou privés.



Optimization of the Synthetic Jet to improve aerodynamic efficiency of the Next Generation Civil Tilt Rotor Aircraft

Hung TRUONG, A. Marouf, J.B. Vos, A. Gehri, and Y. Hoarau

ICUBE laboratory, University of Strasbourg, France

CFS Engineering, EPFL Innovation Park, Lausanne, Switzerland

Optimization of the ZNMF to improve performance of the NGCTR

- Introduction
- Numerical methods
 - *NSMB solver and Meshing*
 - *Modeling of ZNMF devices*
- Results
 - *Critical Flow Conditions*
 - *Configuration 1 with horizontal nacelle*
 - *Configuration 2 with tilted nacelle*
 - *Configuration 3 with deflected aileron*
- Conclusions and Perspectives

Optimization of the ZNMF to improve performance of the NGCTR

- Introduction
- Numerical methods
 - *NSMB solver and Meshing*
 - *Modeling of ZNMF devices*
- Results
 - *Critical Flow Conditions*
 - *Configuration 1 with horizontal nacelle*
 - *Configuration 2 with tilted nacelle*
 - *Configuration 3 with deflected aileron*
- Conclusions and Perspectives

Introduction

The overall objective of the AFC4TR project is to investigate the use of Active Flow Control using so called pulsed air blowing devices with Zero Net Mass Flux (ZNMF) to control the vortical flow for the Next Generation Civil Tilt Rotor (NGCTR) aircraft configuration.

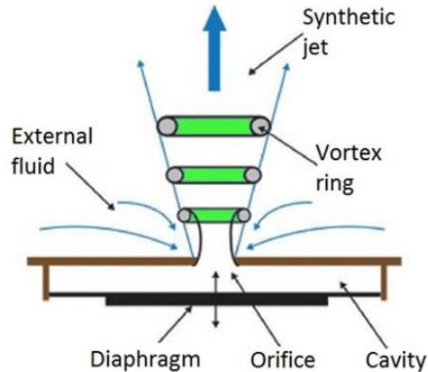

Active Flow Control 4 Tilt Rotor aircraft



CFS Engineering

Computational Fluids & Structures Engineering



Leonardo Helicopters

Optimization of the ZNMF to improve performance of the NGCTR

- Introduction
- Numerical methods
 - *NSMB solver and Meshing*
 - *Modeling of ZNMF devices*
- Results
 - *Critical Flow Conditions*
 - *Configuration 1 with horizontal nacelle*
 - *Configuration 2 with tilted nacelle*
 - *Configuration 3 with deflected aileron*
- Conclusions and Perspectives

Numerical methods

- NSMB solver: Navier Stokes Multi-Block code (compressible NS equations using Finite Volume method) [Hoarau et al. 2016]
- Structured grids are designed following the gridding guidelines of AIAA CFD HighLift/Drag Prediction Workshops
- Farfield boundary $> 100 \times C_{ref}$
- Turbulence model $k - \omega - SST$
- Patched grid and chimera grid techniques are used

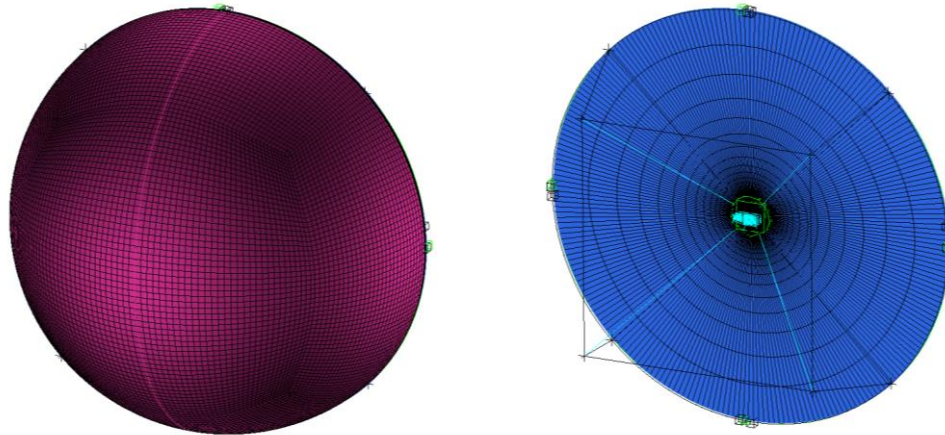

Numerical methods

7 grid components that are merged together (within ICEMCFD or externally with Python scripts)

- Base (fuselage, wing, nacelle) - 10'200'000 cells
- Aileron - 620'000 cells
- Engine cover - 370'000 cells
- Engine - 450'000 cells
- Hub - 340'000 cells
- Blades - 770'000 cells/blade

The engine can be deflected from 0° to 90°

Total mesh 25 millions cells

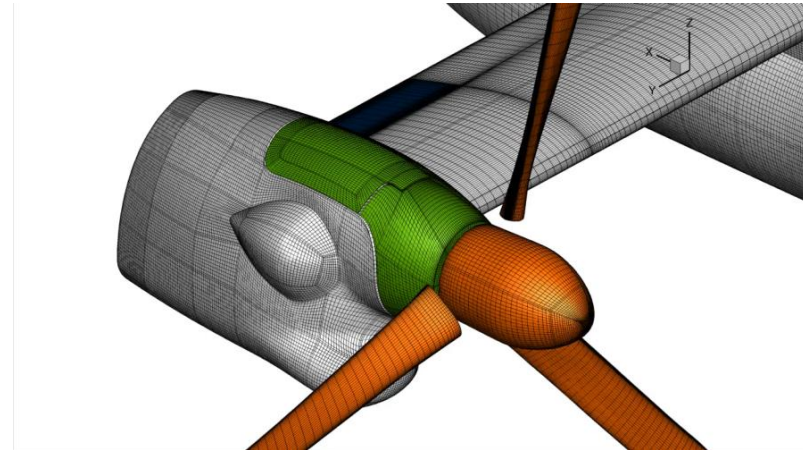
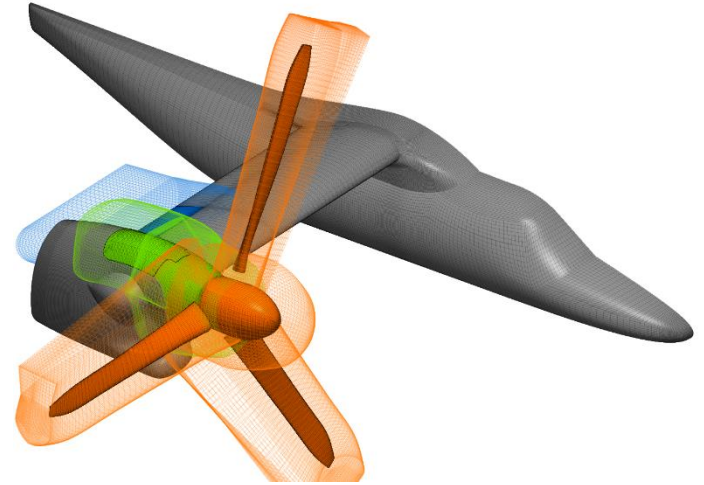

Numerical methods

Modelling of Zero-Net-Mass-Flux (ZNMF) devices

ASPIC synthetic jet actuator

ONERA

THE FRENCH AEROSPACE LAB

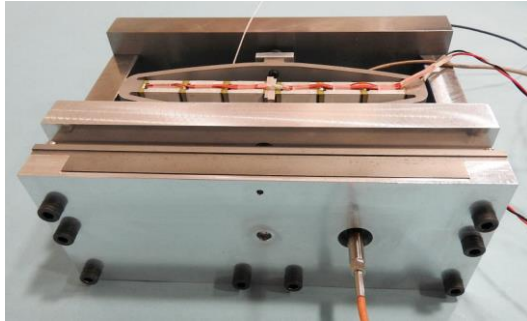

Slot dimensions: $1 \times 150 \text{ mm}^2$
Actuator volume: $164 \times 94 \times 57 \text{ mm}^3$

modelling
→

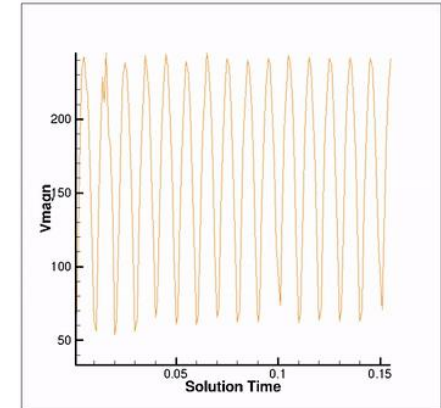
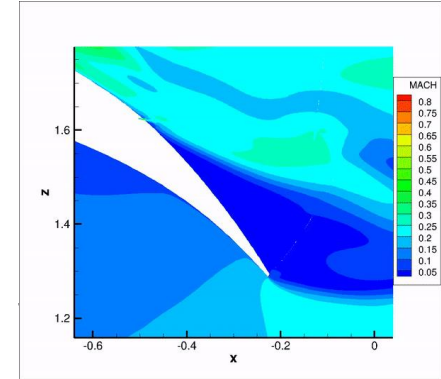
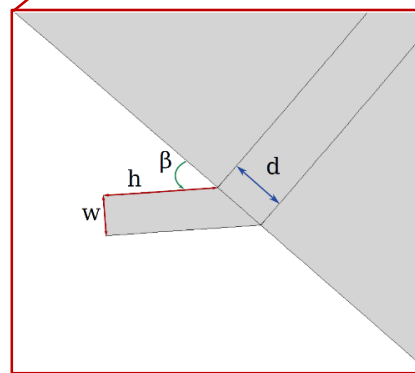
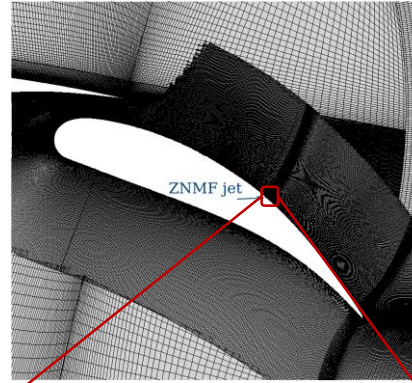

Numerical methods

Modelling of ZNMF devices

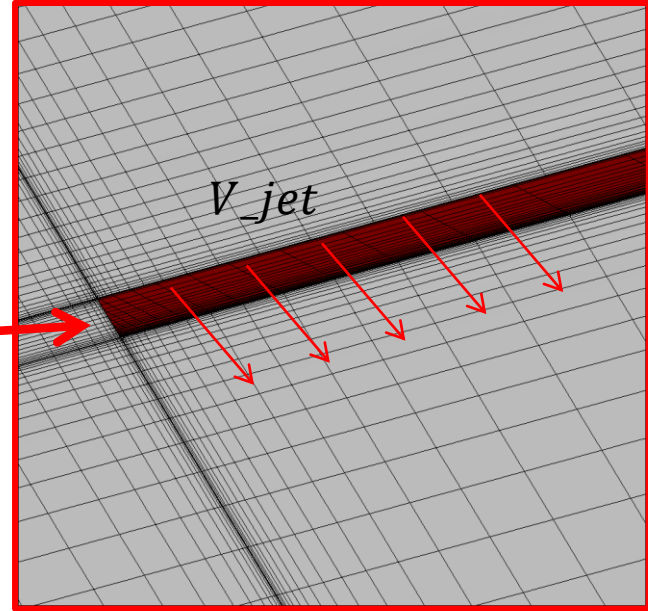
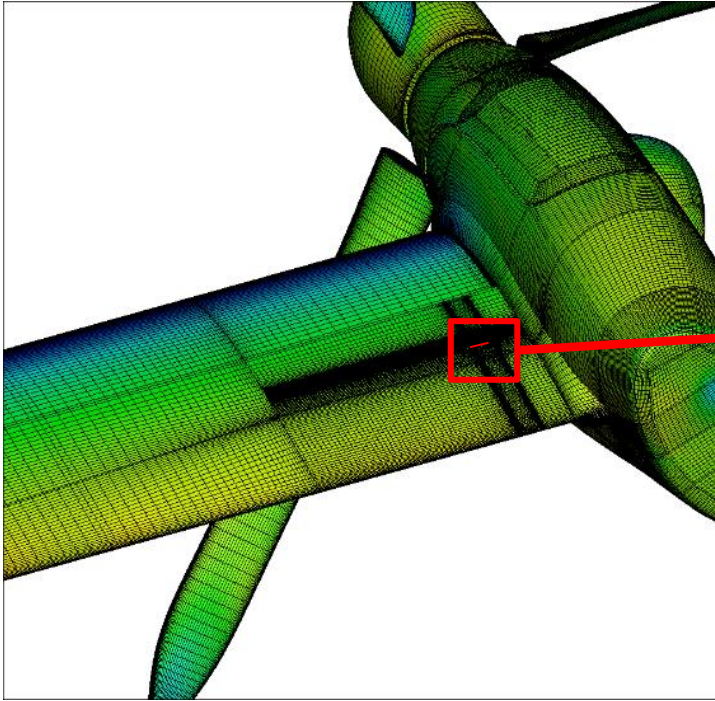

Optimization of the ZNMF to improve performance of the NGCTR

- Introduction
- Numerical methods
 - *NSMB solver and Meshing*
 - *Modeling of ZNMF devices*
- **Results**
 - *Critical Flow Conditions*
 - *Configuration 1 with horizontal nacelle*
 - *Configuration 2 with tilted nacelle*
 - *Configuration 3 with deflected aileron*
- Conclusion and Perspectives

Critical Flow Conditions

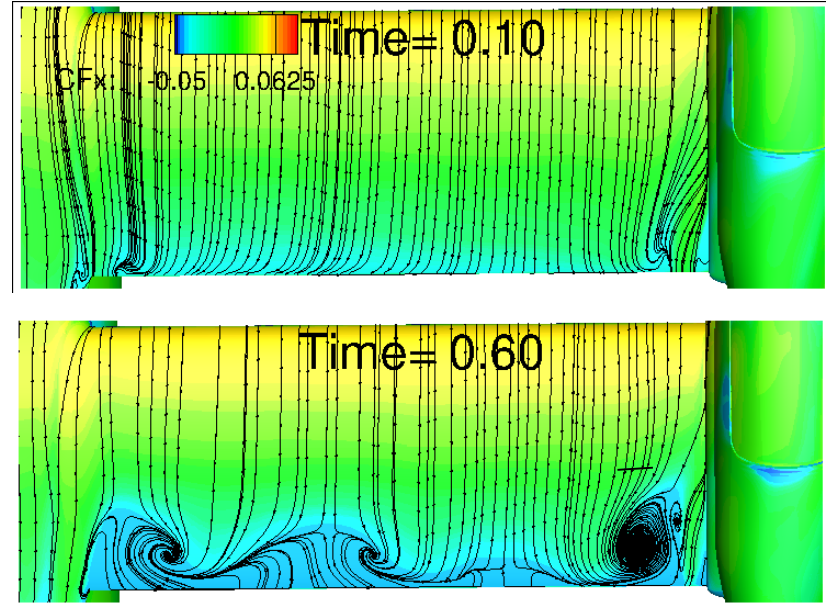
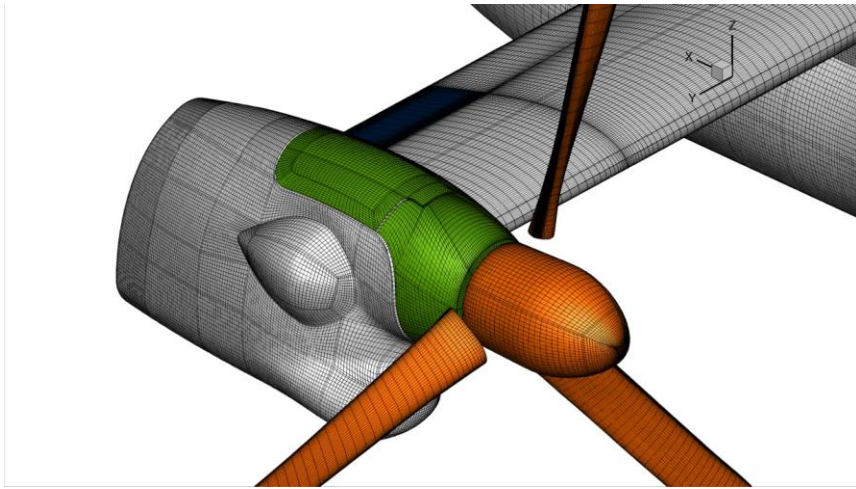

*Skin friction CF_x component contours with streamlines of CF (CF_x , CF_y , CF_z) with **horizontal nacelle***

Critical Flow Conditions

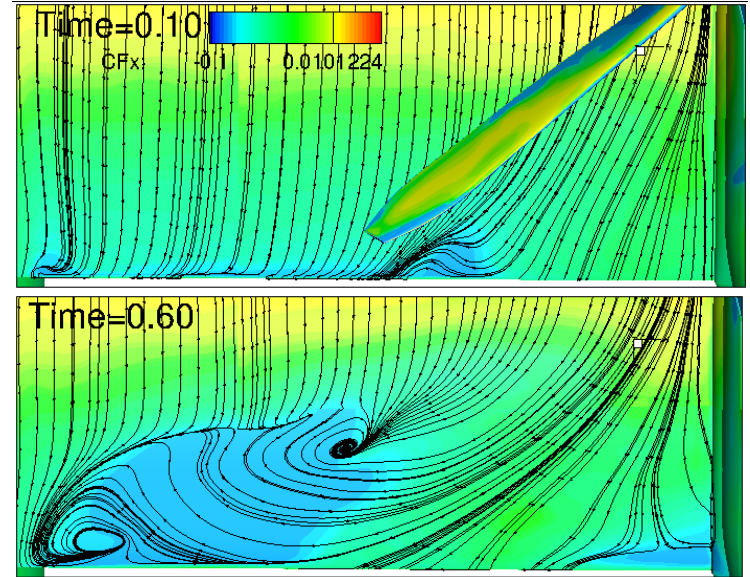
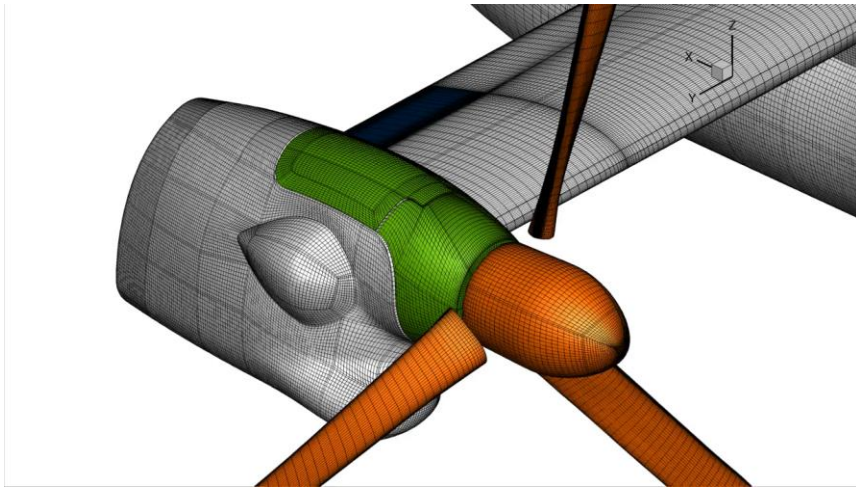

*Skin friction CF_x component contours with streamlines of CF (CF_x , CF_y , CF_z) with **tilted nacelle***

Critical Flow Conditions

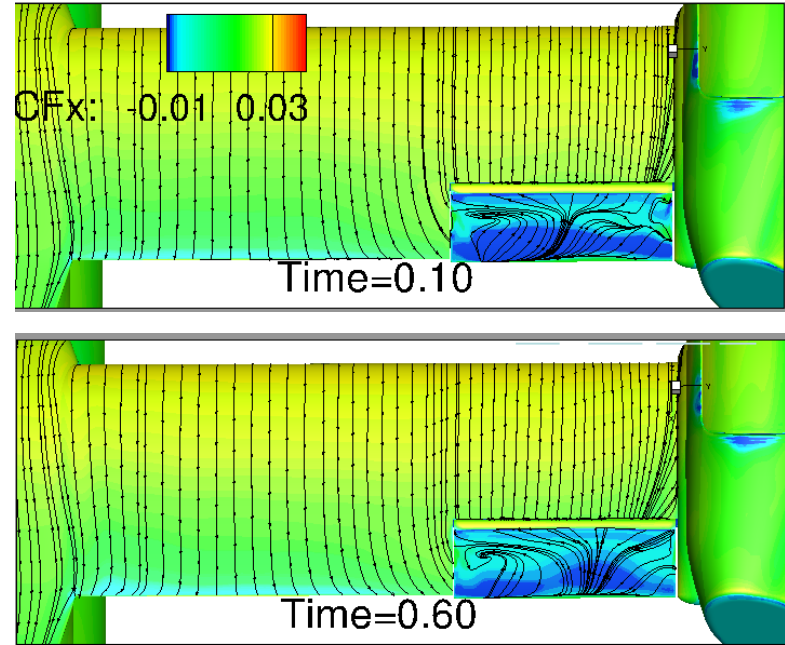
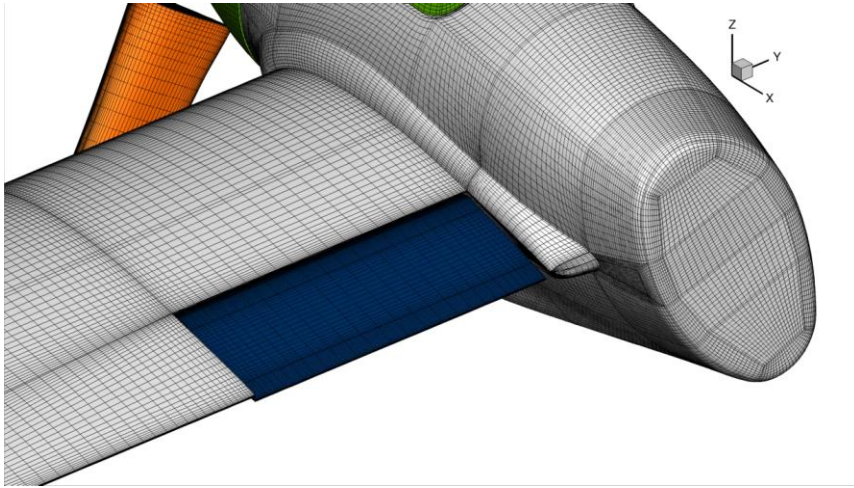

*Skin friction CF_x component contours with streamlines of CF (CF_x , CF_y , CF_z) with **deflected aileron***

Configuration 1 with horizontal nacelle

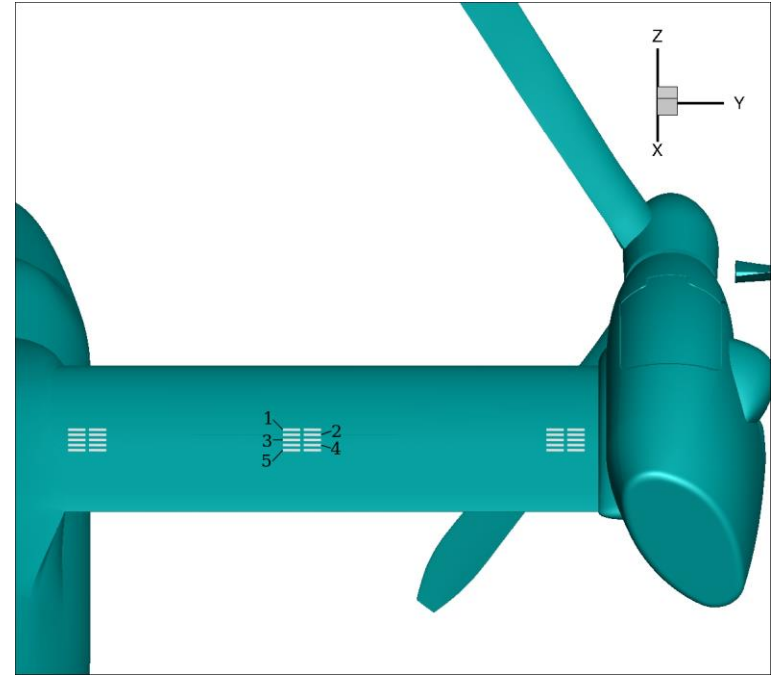
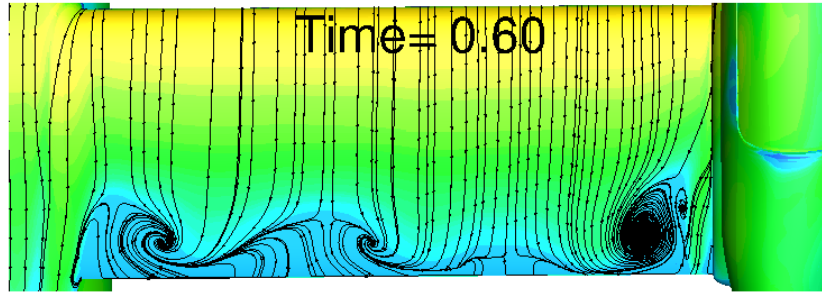

6 ZNMFs are placed upstream of three zones of separation

Configuration 1 with horizontal nacelle

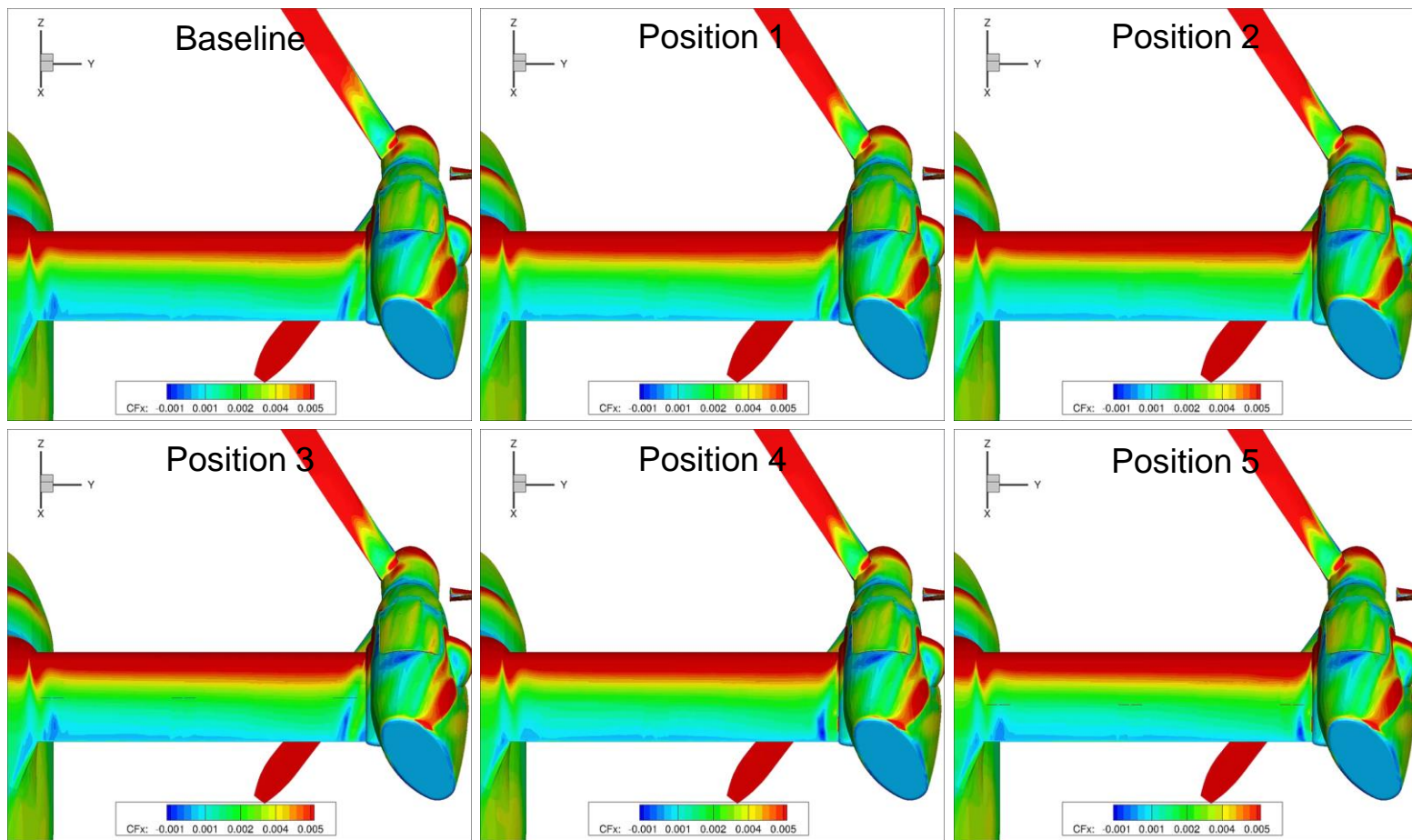

Simulations show skin friction CF_x

*ZNMF parameters
 $v = 300 \text{ m/s}$
 $f = 65 \text{ Hz}$*

Configuration 1 with horizontal nacelle

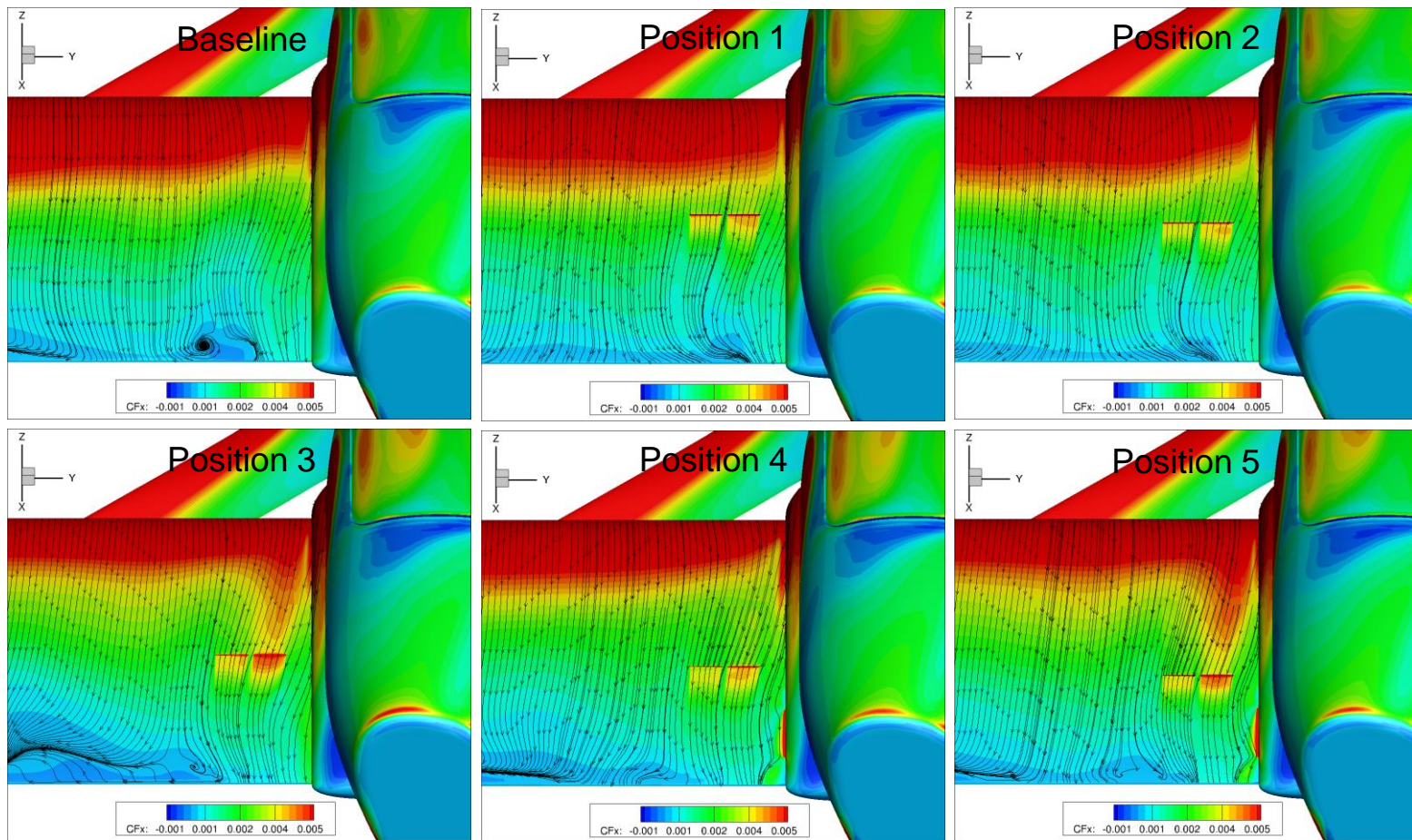

Simulations show skin friction CF_x

ZNMF parameters
 $v = 300 \text{ m/s}$
 $f = 65 \text{ Hz}$

Configuration 1 with horizontal nacelle

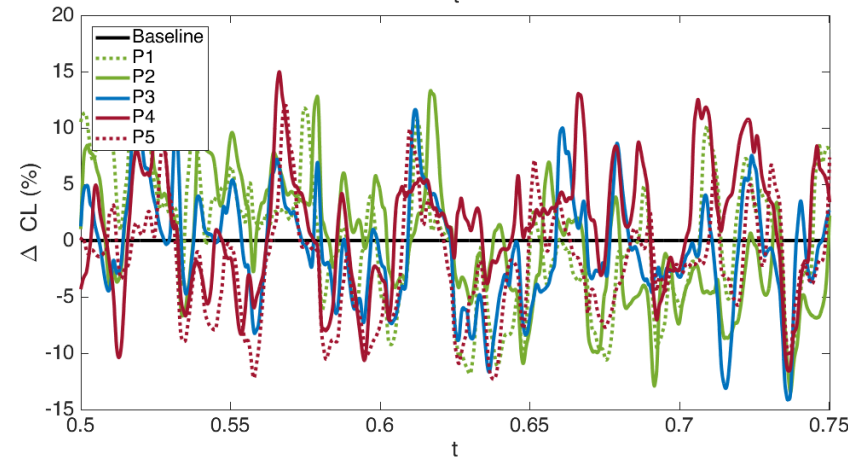
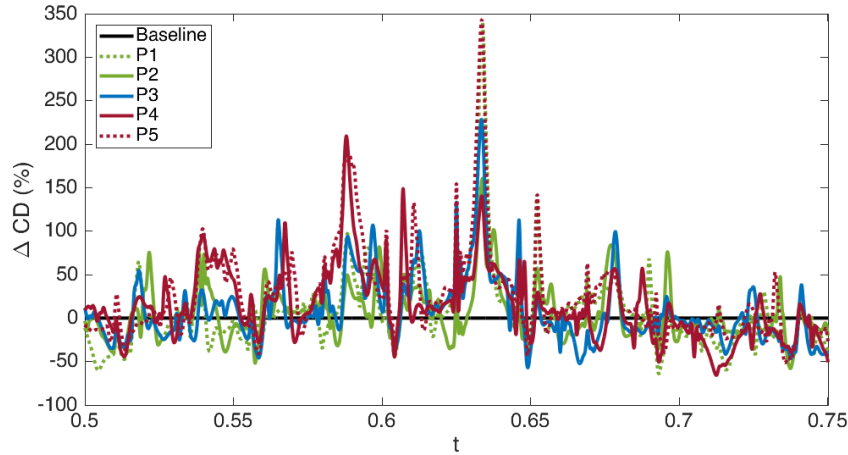

Forces integrated on the wing
for the 5th and 6th rotations of the propeller

$$\bar{C}_L, \bar{C}_D = \frac{1}{t_2 - t_1} \int_{t_1}^{t_2} \bar{C}(t) dt$$

| ZNMF position | ΔCD | ΔCL | $\Delta CL/CD$ |
|---------------|-------------|-------------|----------------|
| 1 | -1.11% | 0.05% | 1.18% |
| 2 | -1.15% | -0.23% | 0.93% |
| 3 | 0.18% | -0.86% | -1.03% |
| 4 | 5.90% | 1.24% | -4.40% |
| 5 | 14.66% | -2.24% | -14.74% |

Insignificant gain since the flow detachment is not as strong as expected

=> the ZNMF position remains to be optimized

Configuration 1 with horizontal nacelle

Simulations show skin friction CF_x

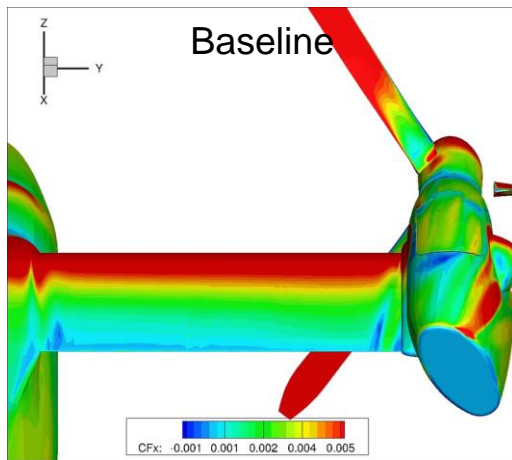

ZNMF parameters
 $v = 300 \text{ m/s}$
 $f = 65 \text{ Hz}$

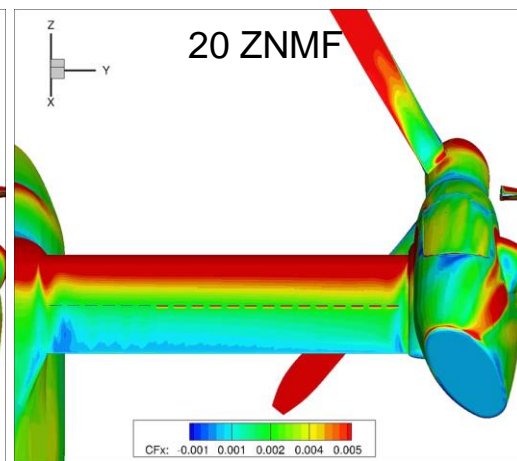
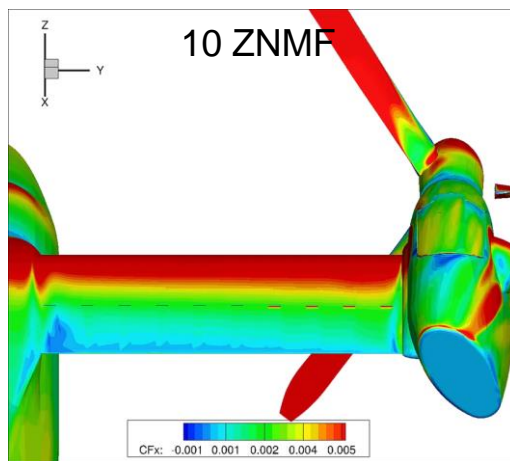
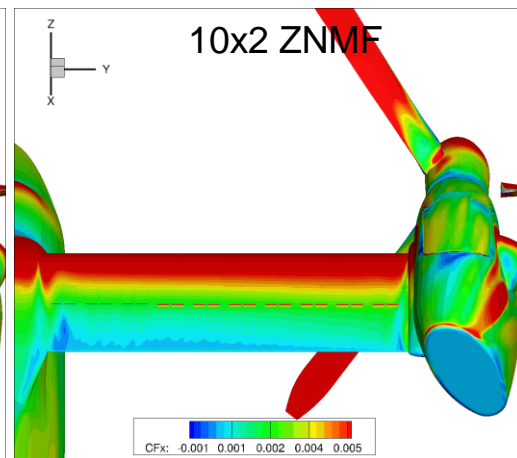
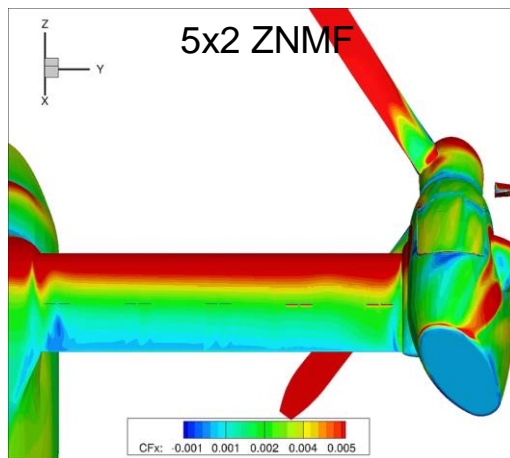

Configuration 1 with horizontal nacelle

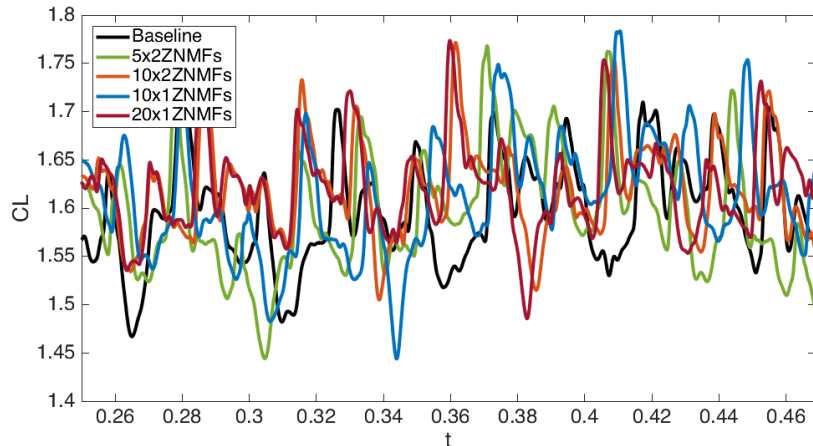
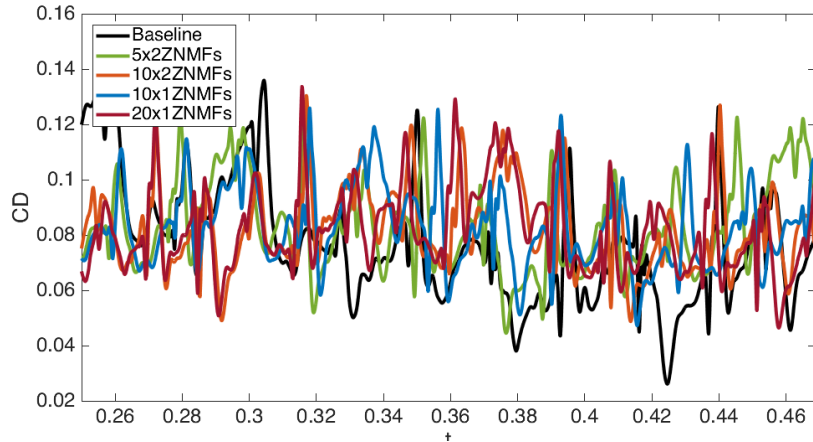

Forces integrated on the wing
for the 4th and 5th rotations of the propeller

$$\bar{C}_L, \bar{C}_D = \frac{1}{t_2 - t_1} \int_{t_1}^{t_2} \bar{C}(t) dt$$

| ZNMF position | ΔCD | ΔCL | $\Delta CL/CD$ |
|---------------|-------------|--------------------|--------------------|
| Baseline | 0.078401 | 1.5899 | 20.27916 |
| 5x2 | 0.081561 | 1.601834 +0.75% | 19.63971 -3.15% |
| 10x2 | 0.0824 | 1.620681 +1.94% | 19.66842 -3.01% |
| 10x1 | 0.083497 | 1.603649 +0.86% | 19.20601 -5.29% |
| 20x1 | 0.082924 | 1.621328 +1.98% | 19.55205 -3.59% |

Lift enhancement accompanied with drag increase
=> lift-to-drag ratio decreases

Configuration 2 with tilted nacelle

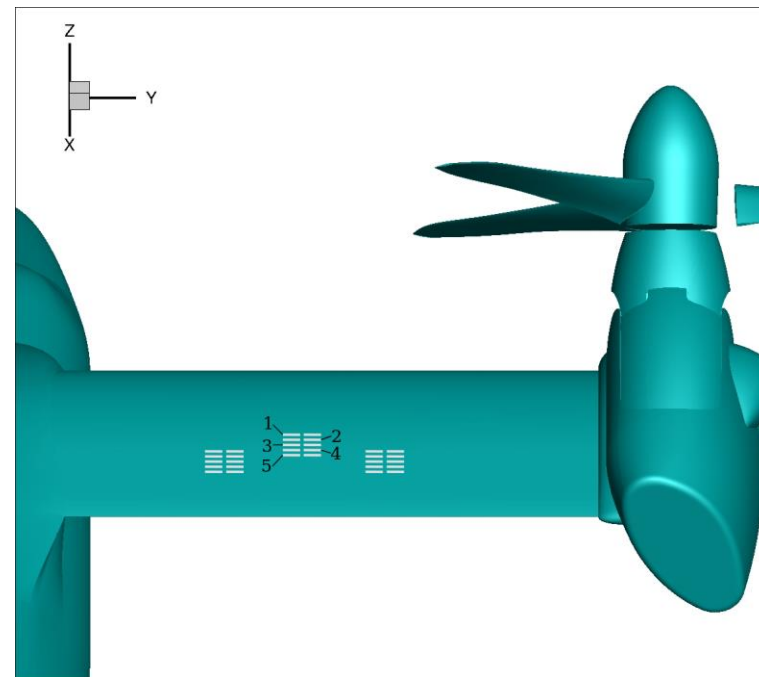
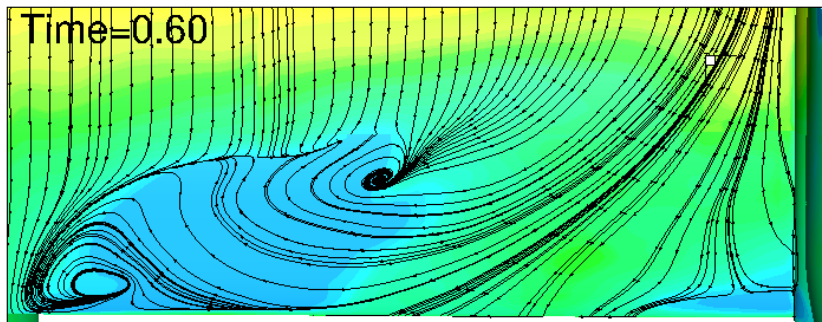

6 ZNMFs are placed upstream of the separation zones in the middle of the wing

Configuration 2 with tilted nacelle

*Simulations show
skin friction CF_x*

*ZNMF parameters
 $v = 300 \text{ m/s}$
 $f = 65 \text{ Hz}$*

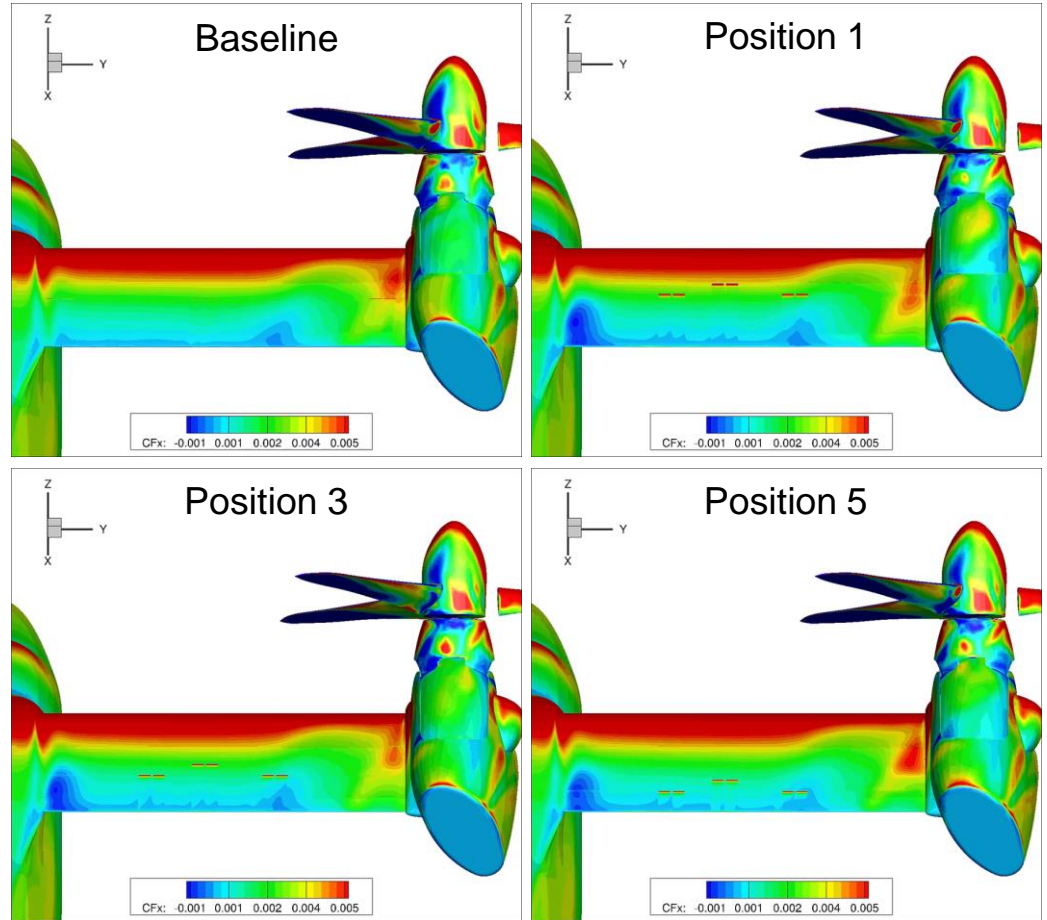

Configuration 2 with tilted nacelle

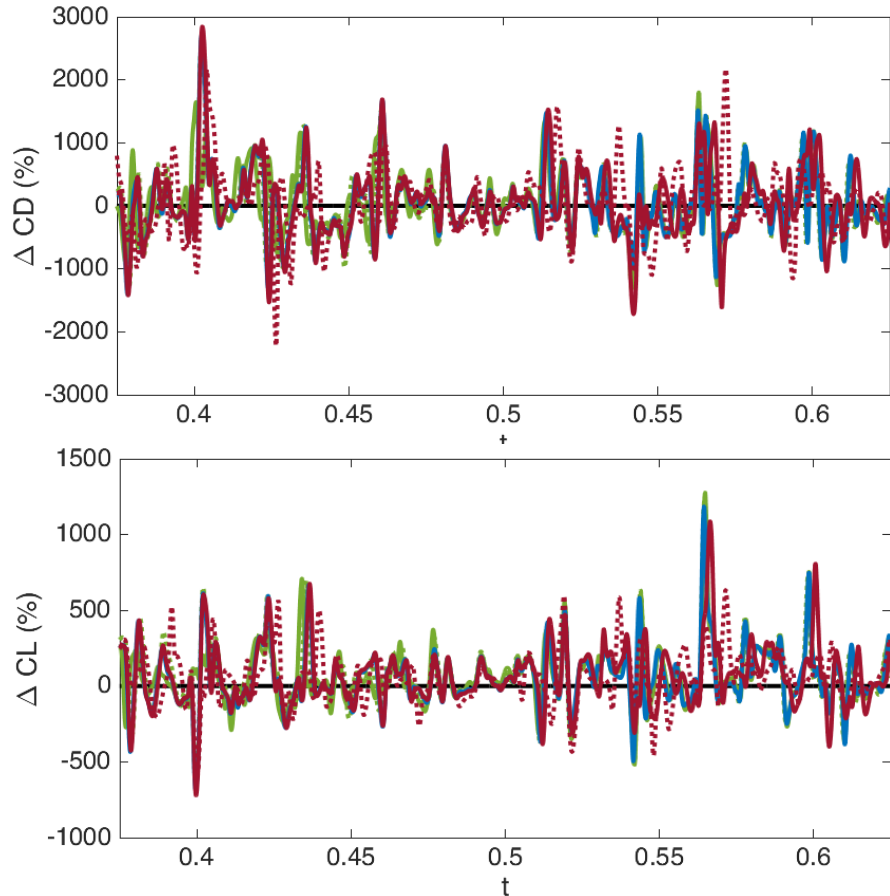

Forces integrated on the wing
for the 4th and 5th rotations of the propeller

$$\bar{C}_L, \bar{C}_D = \frac{1}{t_2 - t_1} \int_{t_1}^{t_2} \bar{C}(t) dt$$

| ZNMF position | ΔCD | ΔCL | $\Delta CL/CD$ |
|---------------|-------------|-------------|----------------|
| 1 | 12.29% | 14.32% | 1.82% |
| 2 | 22.14% | 12.86% | -7.59% |
| 3 | 16.75% | 12.34% | -3.78% |
| 4 | 21.80% | 12.66% | -7.51% |
| 5 | 23.19% | 11.87% | -9.19% |

Lift enhancement accompanied with drag increase
=> lift-to-drag ratio decreases

Configuration 2 with tilted nacelle

Simulations show skin friction CF_x

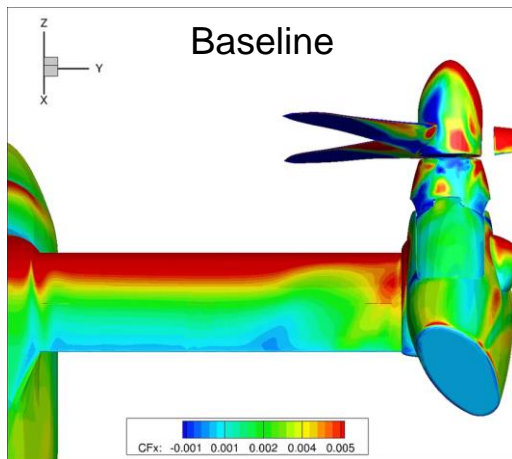

ZNMF parameters
 $v = 300 \text{ m/s}$
 $f = 65 \text{ Hz}$

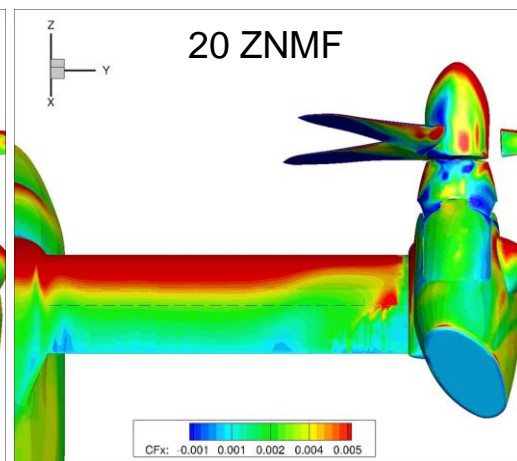
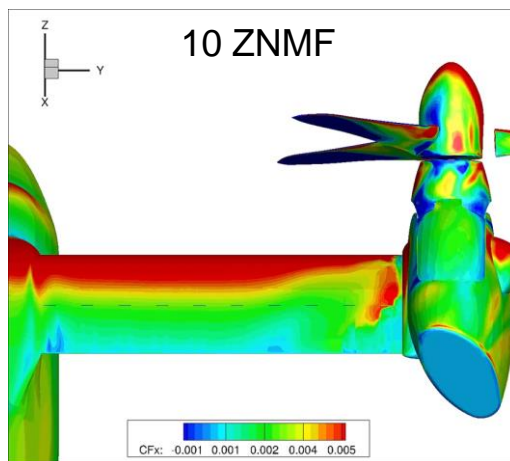
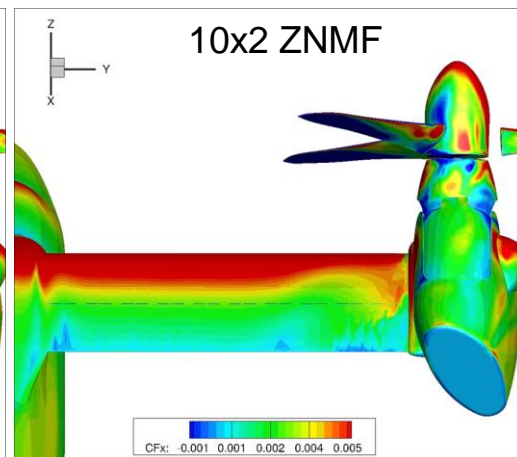
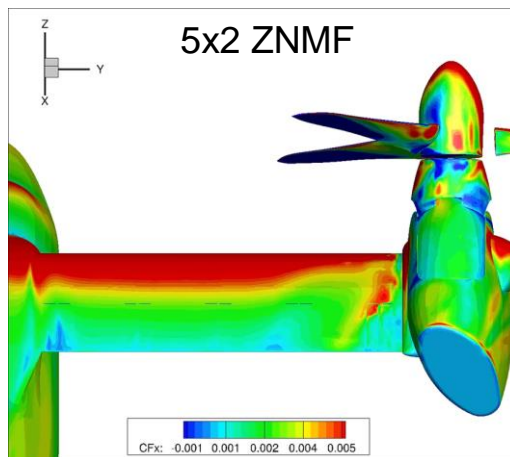

Configuration 2 with tilted nacelle

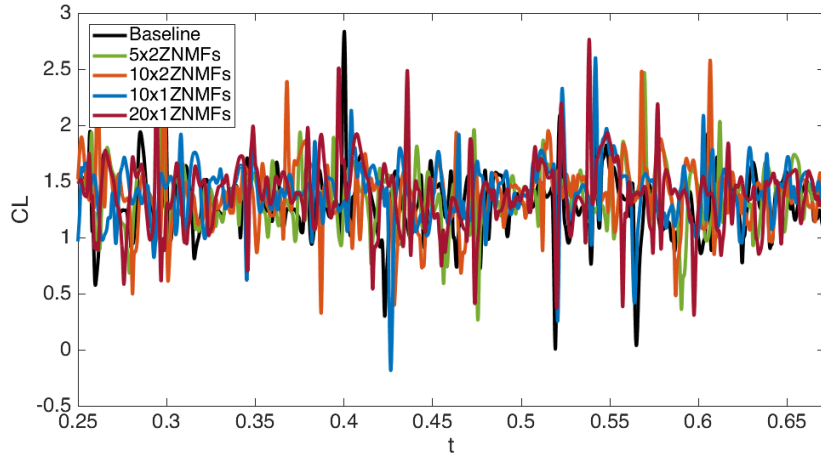
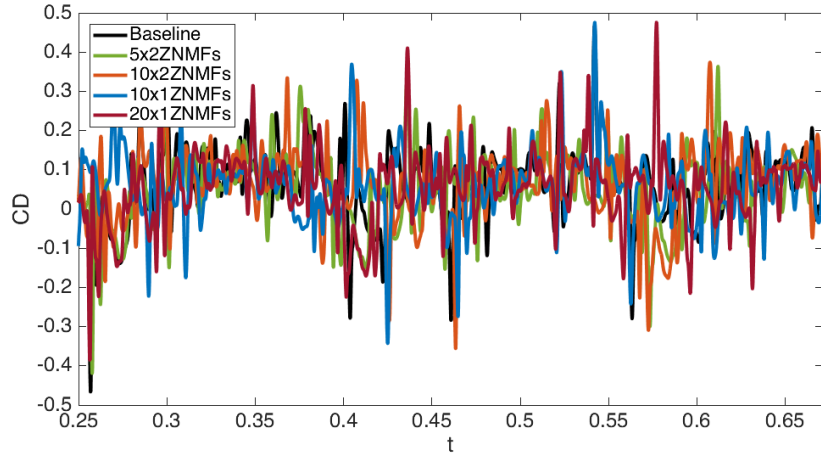

Forces integrated on the wing
for the 4th and 5th rotations of the propeller

$$\bar{C}_L, \bar{C}_D = \frac{1}{t_2 - t_1} \int_{t_1}^{t_2} \bar{C}(t) dt$$

| ZNMF position | ΔCD | ΔCL | $\Delta CL/CD$ |
|---------------|---------------------|--------------------|---------------------|
| Baseline | 0.062931 | 1.318551 | 20.95223 |
| 5x2 | 0.051597 -18.01% | 1.360576 +3.19% | 26.36939 +25.85% |
| 10x2 | 0.060883 -3.26% | 1.38261 +4.86% | 22.70945 +8.39% |
| 10x1 | 0.058348 -7.28% | 1.401107 +6.26% | 24.01302 +14.61% |
| 20x1 | 0.053571 -14.87% | 1.387395 +5.22% | 25.89821 +23.61% |

Lift enhancement accompanied with drag decrease
=> lift-to-drag ratio increases

Configuration 3 with deflected aileron

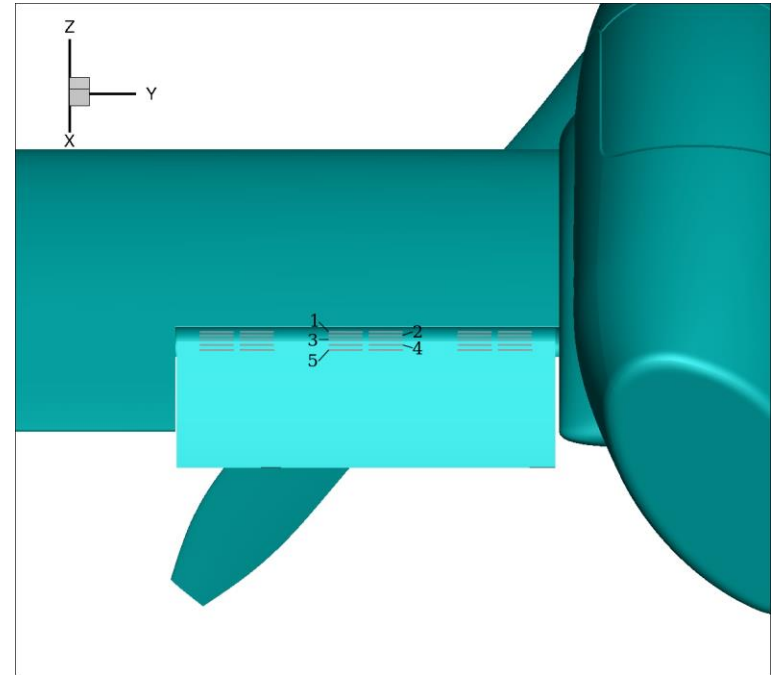
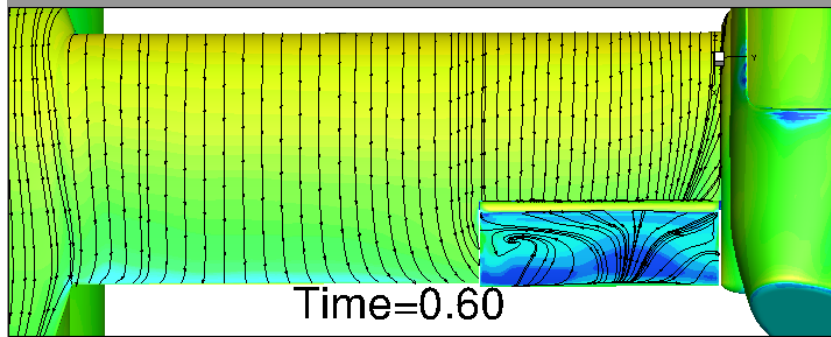

6 ZNMFs are placed near the leading edge of the aileron

Configuration 3 with deflected aileron

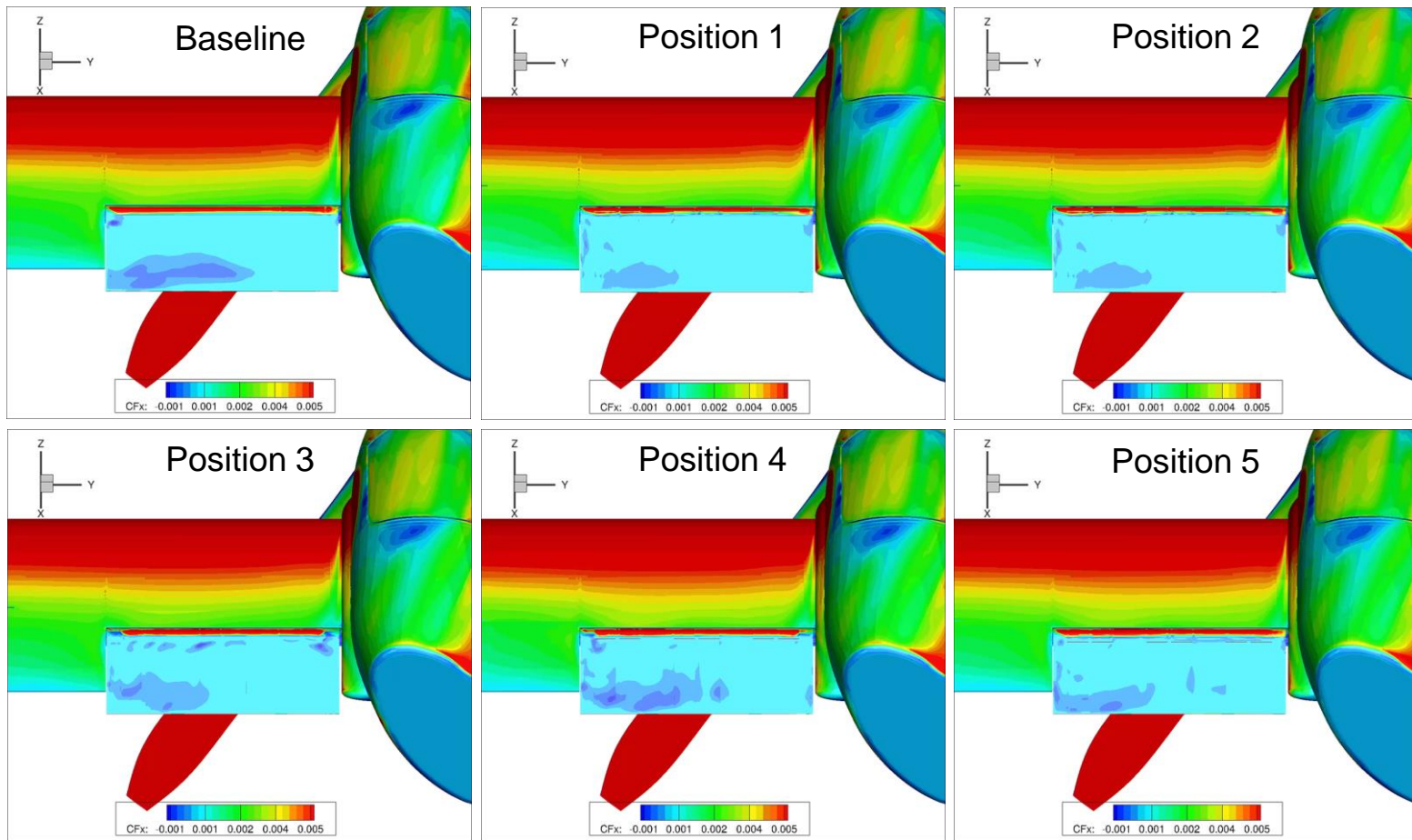

Simulations show skin friction CF_x

*ZNMF parameters
 $v = 300 \text{ m/s}$
 $f = 65 \text{ Hz}$*

Configuration 3 with deflected aileron

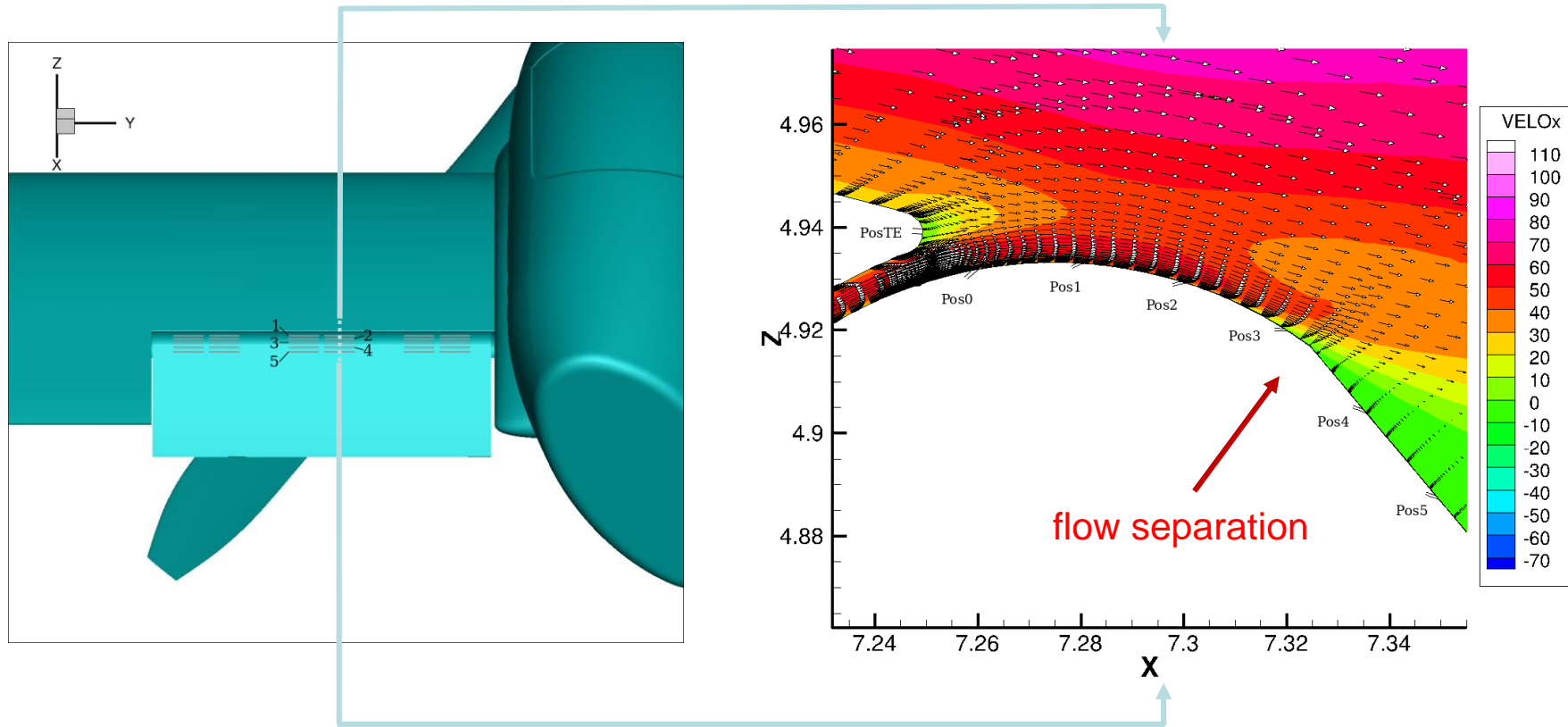

ZNMF positions on deflected aileron

Configuration 3 with deflected aileron

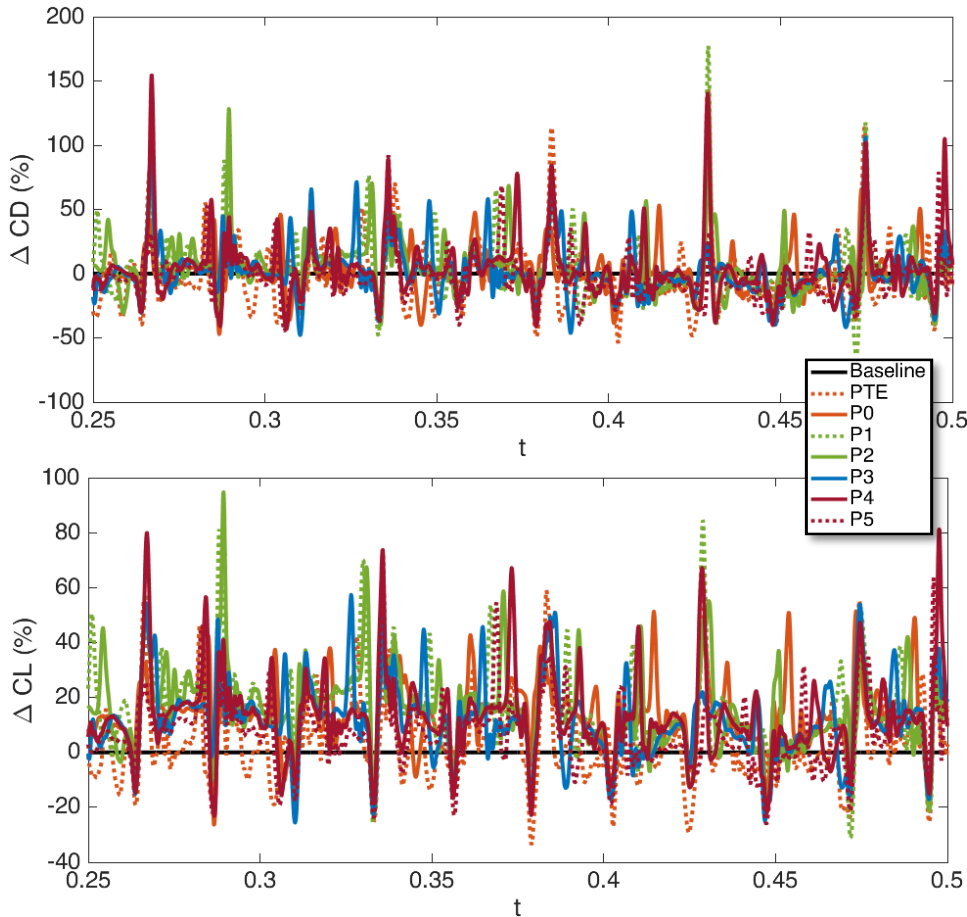

Forces integrated on the aileron
for the 3rd and 4th rotations of the propeller

| ZNMF position | ΔCD | ΔCL | $\Delta CL/CD$ |
|---------------|-------------|-------------|----------------|
| TE | -4.27% | 2.10% | 6.65% |
| 0 | 0.04% | 13.10% | 13.06% |
| 1 | 1.33% | 14.10% | 12.60% |
| 2 | 2.23% | 14.52% | 12.03% |
| 3 | -0.14% | 10.64% | 10.80% |
| 4 | 1.77% | 11.81% | 9.86% |
| 5 | -3.36% | 5.79% | 9.47% |

Lift enhancement while drag remaining unchanged
=> lift-to-drag ratio is improved effectively

Optimization of the ZNMF to improve performance of the NGCTR

- Introduction
- Numerical methods
 - *NSMB solver and Meshing*
 - *Modeling of ZNMF devices*
- Results
 - *Critical Flow Conditions*
 - *Configuration 1 with horizontal nacelle*
 - *Configuration 2 with tilted nacelle*
 - *Configuration 3 with deflected aileron*
- **Conclusions and Perspectives**

Conclusions

- CFD simulations to optimise location of ZNMF for flow control of NCGTR (reference parameters of the ZNMF $v = 300m/s$, $f = 65Hz$, $D/H = 1mm$, $Angle = 45^\circ$)
- ZNMF devices are able to reduce flow separations in critical flow regions, but their location needs to be selected with care
- Optimization of ZNMF position
 - Configuration 1: Insignificant gain since the flow detachment is not as strong as expected
 - Configuration 2: Improvement of lift (+14.32%) and increase of drag (12.3%) => higher lift-to-drag ratio (1.8%)
 - Configuration 3: Lift enhancement while drag remaining unchanged => L/D ratio of the aileron is improved effectively (12%)



<https://cleansky.virtualfair.be/>

Acknowledgement

This project has received funding from the European Union's H2020 - CleanSky2 research and innovation framework programme under grant agreement No 886718

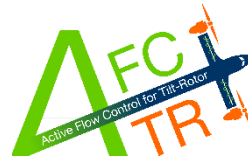



Thank You !

