



HAL
open science

**MEDA3 Mathematics Education in Digital Age 3.
Proceedings of the 13th ERME Topic Conference
(ETC13) held on 7 – 9 September 2022 in Nitra,
Slovakia**

Hans-Georg Weigand, Ana Donevska-Todorova, Eleonora Faggiano, Paola Iannone, Janka Medová, Michal Tabach, Melih Turgut

► **To cite this version:**

Hans-Georg Weigand, Ana Donevska-Todorova, Eleonora Faggiano, Paola Iannone, Janka Medová, et al.. MEDA3 Mathematics Education in Digital Age 3. Proceedings of the 13th ERME Topic Conference (ETC13) held on 7 – 9 September 2022 in Nitra, Slovakia. 2022. hal-03925304

HAL Id: hal-03925304

<https://hal.science/hal-03925304v1>

Submitted on 13 Feb 2023

HAL is a multi-disciplinary open access archive for the deposit and dissemination of scientific research documents, whether they are published or not. The documents may come from teaching and research institutions in France or abroad, or from public or private research centers.

L'archive ouverte pluridisciplinaire **HAL**, est destinée au dépôt et à la diffusion de documents scientifiques de niveau recherche, publiés ou non, émanant des établissements d'enseignement et de recherche français ou étrangers, des laboratoires publics ou privés.



CONSTANTINE
THE PHILOSOPHER
UNIVERSITY
IN NITRA



ERME Topic Conference
Mathematics Education in the Digital Age

MEDA3

Mathematics Education in Digital Age 3

Proceedings of the **13th ERME Topic Conference (ETC13)**
held on 7 – 9 September 2022 in Nitra, Slovakia



Edited by:

Hans-Georg Weigand

Ana Donevska-Todorova; Eleonora Faggiano; Paola Iannone

Janka Medová; Michal Tabach; Melih Turgut

Nitra 2022

e r m e

europaan society for research in mathematics education

International Programme Committee

Chair

Hans-Georg Weigand, Germany

Co-chairs

Ana Donevska-Todorova, Germany/Macedonia

Eleonora Faggiano, Italy

Paola Iannone, UK

Michal Tabach, Israel

Melih Turgut, Norway/Turkey

Members

Andreas Eichler, Germany

Ghislaine Gueudet, France

Gülay Bozkurt (YR), Turkey

Alison Clark-Wilson, UK

Janka Medová, Slovakia

Morten Misfeldt, Denmark

Jana Trgalová, France

Local Organizing Committee

Chair

Janka Medová, Slovakia

Members

Gabriela Pavlovičová, Slovakia

Kitti Páleniková, Slovakia

Lubomíra Valovičová, Slovakia

Veronika Bočková (YR), Slovakia

Silvia Haringová (YR), Slovakia

Conference webpage: <https://www.meda.fpvai.ukf.sk>

Mathematics Education in Digital Age 3 (MEDA3)

Proceedings of the 13th ERME Topic Conference (ETC13)

held on 7 – 9 September 2022 in Nitra, Slovakia

Editors: Hans-Georg Weigand, Ana Donevska-Todorova, Eleonora Faggiano,
Paola Iannone, Janka Medová, Michal Tabach, Melih Turgut

Publisher: Constantine the Philosopher University in Nitra

Place: Nitra, Slovakia

Year: 2022

Edition: Prírodovedec, no 783

ISBN: 978-80-558-1912-9

The contributions were not subjected to language check.
All contributions were peer-reviewed.

© Copyright left to authors.



Faculty of Natural Sciences and Informatics
Constantine the Philosopher University in Nitra

MEDA3

Mathematics Education in Digital Age 3

Proceedings of the 13th ERME Topic Conference (ETC13)
held on 7 – 9 September 2022 in Nitra, Slovakia

Editors: Hans-Georg Weigand, Ana Donevska-Todorova, Eleonora Faggiano,
Paola Iannone, Janka Medová, Michal Tabach, Melih Turgut

Nitra, 2022

Table of Contents

Ana Donevska-Todorova, Eleonora Faggiano, Paola Iannone, Janka Medová,
Melih Turgut, Michal Tabach, and Hans-Georg Weigand
Mathematics Education in Times of Exponential Change: New trends and new debates.....v

Plenary Lectures

Annalisa Cusi
Formative assessment in Mathematics in the digital age: teachers' practices and roles2

Jana Trgalová
Design of digital resources by and for mathematics teachers..... 12

Ivan Kalaš, Iveta Kohanová, Piers Saunders, Alison Clark-Wilson, and Eirini Geraniou
Computational thinking and mathematics education: Debating synergies and tensions21

Full Papers

Ismael Almahdi and Osama Swidan
Mathematics teachers as designers e-textbook: resources and professional
development.....46

Sara Bagossi, Nadia Shifrin, Otman Jaber and Osama Swidan
Interactions and meaning-making in an AR learning environment51

Marita Barabash and Elena Naftaliev
Technology-based mathematics teaching environment as a factor affecting mathematical
definitions: a challenge for teachers56

Daniela Bímová, Petra Pirklová, Jiří Břehovský, Klaus-Peter Eichler and Asif Mushtaq
Developing visuospatial ability by creating the virtual models of cubic solids
for 3D printing64

Maxim Brnic and Gilbert Greefrath
Teacher's recommendations for distance learning compared to student's actual use of digital
textbooks and other (digital) resources72

Roberto Capone and Eleonora Faggiano
Using and designing digital mathematical resources: teachers' beliefs on their professional
needs76

Roberto Capone, Mario Lepore and Federica Mennuni
Characterising paraboloids using Augmented Reality.....80

Cecilie Carlsen Bach, Ewa Bergqvist and Uffe Thomas Jankvist
Mathematical communication when using DGE: Balancing between object
and representations.....88

Scott Courtney, Mary Miller and Michael Gisondo Exploring mathematics teachers' utilization of digital resources throughout, and after, the Covid pandemic	96
Marcantonio de Candia, Giulia Marchese, Federica Mennuni and Eleonora Faggiano Experiencing collaborative task design and video analysis to develop digital teaching practices.....	103
Frederik Dilling and Rebecca Schneider CSC Model – Learning mathematics on the basis of (digital) empirical settings	111
Frederik Dilling, Rebecca Schneider and Kevin Hörnberger Subject-related implementation of (digital) media by mathematics teachers: A theoretical framework.....	116
Ana Donevska-Todorova Digital quiz activities for personalization of learning paths in mathematics education	121
Raimundo Elicer and Andreas Lindenskov Tamborg Networking the theoretical constructs of computational thinking and techno-mathematical fluency through a geometrical task	125
Houssam Elkasti and Zsolt Lavicza Developing an innovation pyramid framework to reflect on the digitalization of mathematics education	133
Maria Fahlgren and Mats Brunström Example-generating tasks in a computer-aided assessment system: Redesign based on student responses	141
Julie Færch, Linda Marie Ahl and Uffe Thomas Jankvist Utilizing the notion of scheme in task design for an online assignment portal	145
Eirini Geraniou and Jeremy Hodgen A case study of an expert in computational thinking in the context of mathematics education research	153
Eirini Geraniou, Uffe Thomas Jankvist, Raimundo Elicer, Andreas Lindenskov Tamborg and Morten Misfeldt On mathematical digital competency for teaching: The case of an expert teacher	161
Silvia Haringová and Janka Medová Identification of domains of mathematics teachers' knowledge addressed in reflection on technology-supported math trails.....	169
Ingi Heinesen Højsted, Erla Olsen, Páll Isholm and Laufey Blaasvær Computers for all – what happens? The case of Tórshavn	177

Otman Jaber, Sara Bagossi and Osama Swidan Augmented reality for conceptualizing covariation through connecting virtual and real worlds	182
Stine Gerster Johansen and Uffe Thomas Jankvist The potential role of digital tools in students' development of Bildung: An illustrative case of statistical distributions	188
Antoine Julien, Elisabeth Romijn and Alexander Schmeding Peer and self-assessment to improve mathematics competence in pre-service middle-school teachers	196
Odd Tore Kaufmann, Marianne Maugesten and Tamsin Meaney Views of pre-service teachers in Norway on the value of programming in teaching mathematical and pedagogical topics	200
Katrin Klingbeil, Fabian Rösken, Bärbel Barzel and Florian Schacht Potential and challenges of SMART as an online diagnostic tool in comparison to diagnostic interviews using the example of understanding variables	208
Manolis Mavrikis, Stefanie Vanbecelaere, Fien Depaepe and Eirini Geraniou Primary school teachers meet learning analytics dashboards: from dispositions to situation- specific digital competence in practice	216
Filip Moons, Alexander Holvoet and Ellen Vandervieren Comparing atomic feedback with classic feedback on a linear equations task using text mining techniques	224
Elena Naftaliev and Marita Barabash Teachers' engagement with experimental mathematics and interactive resources	232
Norbert Noster, Arnon Hershkovitz, Hans-Stefan Siller and Michal Tabach Students' strategies for identifying reflective symmetry of extra-mathematical shapes in a digital environment	240
Julia Pirklbauer and Robert Weinhandl Experiences of mathematics teachers with the use of GeoGebra Classroom in remote teaching during the COVID-19 pandemic in Austria	248
Ana Isabel Sacristán, Marisol Santacruz-Rodríguez, Chantal Buteau, Joyce Mgombelo and Eric Muller Future teachers' appropriation of computer programming as a mathematical instrument and a resource for teaching	256
Ulises Salinas-Hernández, Birgit Pepin, Ayse Kiliç and Zeger-Jan Kock Towards a new understanding of 'agency' in innovative learning environments	264

Michal Tabach and Jana Trgalova What does virtual learning environments afford to mathematics teachers?	268
Mathias Tejera, Shereen El Bedewy, Gonzalo Galván and Zsolt Lavicza 3D Printing and GeoGebra as artefacts in the process of studying mathematics through architectural modelling	276
Athina Thoma, Paola Iannone and Gihan Marasingha Engaging with lean Interactive Theorem Prover: Solving a logic task	284
Eva Ulbrich, Shereen El Bedewy, Martin Ertl, Ingrid Graz and Zsolt Lavicza Connecting hybrid teaching to hybrid manipulatives by 3D modelling	288
Laura Wirth and Gilbert Greefrath Working with a heuristic worked example video – upper secondary students' perceived advantages and challenges	296

Poster Annotations

Brigitta Bekesi, Tony Houghton and Zsolt Lavicza Digitalisation through the students' eyes: collaborative creative tasks with iPads	305
Klaus-Peter Eichler, Jiří Břehovský, Daniela Bímová, Moritz Seibold and Asif Mushtaq Software-supported development of visuospatial abilities	307
Yanjun Hong The application of micro-video clips in mathematical teaching in primary school.....	309
Péter Körtesi and Zsuzsanna Katalin Szabó Inverse of a function - mathematical and GeoGebra approach.....	311
Katarína Laššová and Veronika Bočková Support the development of spatial ability of future teachers for primary education through GeoGebra.....	313
Asif Mushtaq, Klaus-Peter Eichler, Daniela Bímová, Petra Pirklová and Jiří Břehovský Educating pre-service teachers in programming for schools: Block-based programming initiative in the teacher education program.....	315
Hoang Nguyen The influence of dynamic visualizations on learning derivatives.....	317
Siri Krogh Nordby, George Gadanidis and Immaculate Namukasa Resources to teach Computational Thinking in primary mathematics education.....	319

Mathematics Education in Times of Exponential Change: New trends and new debates

Ana Donevska-Todorova¹, Eleonora Faggiano², Paola Iannone³, Janka Medová⁴,
Michal Tabach⁵, Melih Turgut⁶, and Hans-Georg Weigand⁷

¹University of Applied Sciences HTW Berlin, Germany; ana.donevska-todorova@htw-berlin.de

²University of Bari Aldo Moro, Department of Mathematics, Italy; eleonora.faggiano@uniba.it

³Loughborough University, Loughborough, UK; p.iannone@lboro.ac.uk

⁴Constantine the Philosopher University in Nitra, Slovakia; jmedova@ukf.sk

⁵Tel-Aviv University, School of Education, Tel-Aviv, Israel; tabachm@tauex.tau.ac.il

⁶Norwegian University of Science and Technology, Trondheim, Norway; melih.turgut@ntnu.no

⁷Würzburg University, Würzburg, Germany; weigand@mathematik.uni-wuerzburg.de

Introduction

At the time of writing this introduction, the world is dealing with the aftermath of a terrifying pandemic crisis. This crisis has affected teaching and learning practices and scientific activities in all fields, including in mathematics education. CERME12, in 2022, took place a year later than scheduled as a virtual conference and in difficult conditions, and it was made possible only by the dedicated engagement of the International Programme Committee, the Local Organising Committee and the Thematic Working Groups' leaders. In the plenary session of the congress, Jeppe Skott emphasised that the mathematics education community should remain modest in what could be expected from the scientific reports at the conference due the extreme conditions in which teaching and learning had happened in the previous two years. In the same plenary Susanne Prediger added that our community should nevertheless be very ambitious and strive to progress in the advancement of mathematics education. For the new generation of researchers in mathematics education, these encouraging words coming from experienced colleagues meant searching for a balance between maintaining reasonable expectations of the work that could be done in such circumstances and dealing with the challenges of the present. But what does this mean for research about digital technologies in mathematics education? Not only this issue is so complex, but the pandemic forced a shift to modes of teaching and learning that involved much reliance on digital technologies, therefore making research in this area very topical. If the last decade of research was labelled by our community as "Mathematics Education in the Digital Age" (e.g., Clark-Wilson et al., 2021) how could the current times be described? Some authors criticise the speed of the change in the use of digital technologies and describe our era as "Education in the Automated Age" (Andrejevic, 2019) to emphasise the automated generation of large datasets coming from data science and machine learning, without really focusing on what the implications could be on teaching and learning. Could the next decade be described as "Mathematics Education in Times of Exponential Change"? Taking a humorous view of this 'brand name', it contains the word "exponential", which is related to a sophisticated mathematical concept of exponential functions. One outcome of the pandemic crisis was to make clear that the development of pandemics cannot be understood without mathematics. In this sense, the inclusion of a mathematical word such as 'exponential' in the label is well deserved. The unexpected and necessary developments of the use of technologies for teaching and learning mathematics are the topic of the ERME Topic Conference MEDA3 in Nitra, Slovakia, which was held in September 2022.

Thematic and organizational aspects of MEDA3

MEDA3 is a natural continuation of the previous two conferences in 2018 (Denmark) and 2020 (remotely, Austria) where the ERME community gathers to discuss applications of digital technology in mathematics education from cross-disciplinary and interdisciplinary perspectives. Of course, this

does not mean that the use of traditional technologies, resources, and artifacts is neglected, those are used alongside new ones. Indeed, the contributions to this conference address the applications of new tools and well-established tools to the learning and teaching of mathematics, offering much richness of educational experiences. In the call for papers to be submitted to the conference we outlined three themes (Table 1) around which we wished to encourage contributions. Of course, we were aware that many other important issues exist for digital technologies, but we envisaged these three themes to be probably the most relevant to the current use of digital technologies.

Table 1: Overview on the number of conference contributions per theme

Theme	Total number of accepted contributions
1. Mathematics teacher' practices, teacher education and professional development in the digital age	18
2. Curriculum innovation, design of digital and hybrid environments and practical implementation of digital resources	33
3. Assessment in mathematics education in the digital age	6

In what follows we outline the three themes and the nature of the contributions received to each one.

Mathematics teacher' practices, teacher education and professional development

Adoption of digital tools into classroom practice takes time and the tools and functions of digital technologies change rapidly. The COVID-19 pandemic affected teachers' practices, experiences, and their processes of adaptation of new tools. To better understand these new processes, new approaches and emerging frameworks are needed to guide teachers to integrate digital tools into mathematics education on the one hand, and to ensure professional development of mathematics teachers on the other. Teachers' expectations regarding perspectives for teaching after the crisis vary, depending on several factors. Contributions to this theme focus on teachers' self-learning in formal and informal settings, use of shared virtual/hybrid spaces and resources for teacher education and professional development, working in clouds and wiki, but they also address other concerns. Specifically, the theme includes several examples of teacher practices with digital tools in the pandemic, an analysis of virtual learning environments to support teacher practices, and practices of (block-based) programming in professional development of pre-service mathematics teachers.

Curriculum innovation, design of digital and hybrid environments and practices with digital resources

Applications of Learning Management Systems (LMS) in the teaching and learning of mathematics, but also uses of Learning Analytics (LA) and Artificial Intelligence (AI) in the research activities about mathematics education, have intensified since the pandemic outbreak. Although their effects are closely connected to the design of digital curriculum resources for mathematics or synchronous and hybrid activities in mathematics education, these scientific disciplines are seldom considered in connection to learning theories and the didactics of mathematics. Exploring these connections allows us to understand the effects of automated and adaptive learning environments to self-regulated learning and individualization of learning trajectories through collaboration (Donevska-Todorova, 2022). Contributions to this theme focus on the design and implementation of resources with novel technologies, such as 3D print technologies or virtual and augmented reality, in addition to the well-established digital geometry systems (DGS) and computer aided systems (CAS). Other papers discuss

issues concerning computational thinking in mathematics education at all educational levels, as well as different modalities of synchronous and asynchronous learning supported with various digital tools.

Assessment with digital technologies in mathematics education

The impact of assessment with digital technologies on teaching and learning mathematics has been wide-reaching and has touched all aspects of assessment practices in the classroom – both for formative and for summative assessment. Yet little is still known about the effects of introducing assessment with digital technologies on students’ learning and on students’ and teachers’ experiences. As an example, for the case of computer aided assessment (CAA) Kinnear et al., (2022) drew a rich research agenda highlighting the areas which are still under-research in this field – of which there are many. Moreover, the pandemic forced teachers to use digital tools also for marking traditional written output, and the impact of this new development on how feedback is written (by the teachers) and received (by the students) has not been well understood yet. We received six papers regarding the use of digital technologies for assessment. Topics within this theme go from the use of CAA for formative assessment and especially on the topic of example generation, to true/false questions design and generally the design of digital tasks, to the impact that the digital medium has on the type of feedback teachers give students.

Conclusions and Prospects

There has been a change in working with and thinking about digital technologies in mathematics education in the last years and decades. Up to the beginning of the millennium the research emphasis was firmly on the use of computer algebra systems, dynamic geometry systems and spreadsheets. Research focused on the affordances of such tools and possibilities for concept formation, on the likely changes of contents of mathematics and on the possible new ways in which mathematics could be taught in mathematics classrooms if these digital technologies were used. Since 2010 the emphasis concerning digital technologies had been more on learning environments, adaptive systems, virtual reality, augmented reality, videos, 3-D-printing, formative and summative assessment systems, and ebooks. The papers presented at MEDA3 are a representation of this development. Of course, key competences like functional thinking, computational thinking, proving, representing, or modelling and their interaction with digital technologies are still important. However, they are now seen in the frame of learning and teaching systems. The pandemic gave an additional push to this development.

The great variety of contributions to the MEDA3 conference, also concerning different school types and pre- and in-service teacher education, show the challenge to bring together the “old” ideas of working with digital tools (like CAS or DGS), the still important key competences and the “new” ways of working with software systems on laptops and smartphones. They also show the necessity to describe these new ways of working with new or newly interpreted concepts like digital competences, digital resources, digital design, diagnostic tools, dynamic communication, or computational thinking. MEDA3 is one step in moving ahead to understand better the interrelationship between mathematics and the new digital technologies.

Discussion about these themes continues in relation to the Call for Papers for a Special Issue in the Springer International Journal for Research in Undergraduate Mathematics (IJRUME), “Digital Experiences in University Mathematics Education. Advances and Expectations”, that will be edited by Ana Donevska-Todorova, Eleonora Faggiano, Janka Medová, and Melih Turgut and a special ZDM-issue “Mathematics Education in the Digital Age”, edited by Hans-Georg Weigand, Michal Tabach and Jana Trgalova.

References

Andrejevic, M. (2019). *Automated media*. New York and Abingdon: Routledge.

Clark-Wilson, A., Donevska-Todorova, A., Faggiano, E., Trgalová, J., & Weigand, H. G. (Eds.). (2021). *Mathematics Education in the Digital Age: Learning, Practice and Theory*. Routledge. <https://doi.org/10.4324/9781003137580>

Donevska-Todorova, A. (2022). Individual, but not alone! Design of individual and collaborative activities for adaptive learning pathways in learning management systems, *INTED2022 Proceedings*, pp. 8890-8897. doi: 10.21125/inted.2022.2319

Kinnear G., Jones I., Sangwin C., Alarfaj M., Davies B., Fearn S., Foster C., Heck A., Henderson K, Hunt T., Iannone P., Kontorovich I., Larson N., Lowe T., Meyer J., O’Shea A., Rowlett, P., Sikurajapathi I and Wong T. (2022) A collaboratively-derived research agenda for e-assessment in university mathematics. *The International Journal of Research in Undergraduate Mathematics Education*. <https://doi.org/10.1007/s40753-022-00189-6>

Plenary Lectures

Formative assessment in Mathematics in the digital age: teacher's practices and roles

Annalisa Cusi

Sapienza University of Rome, Italy; annalisa.cusi@uniroma1.it

My contribution concerns the ways in which teachers' practices in supporting formative assessment (FA) processes through digital technologies (DT) can be interpreted and analysed. After a reflection on the results of research studies on this issue, I present a model recently refined to characterize, at a macro level, the teachers' FA practices through DT and then the analysis of an example, developed at a micro level to highlight the roles that the teacher plays when interacting with students. I conclude with some reflections on the impact that the experience of distance teaching during the Covid-19 emergency could have on the future evolution of teachers' assessment practices through DT.

Keywords: formative assessment, digital technologies, teachers' practices, teachers' roles.

Investigating teachers' formative assessment practices and roles in the digital age

Teaching practices in the digital age have been a fundamental focus of Mathematics Education research for decades, leading to the development of frameworks recently discussed by Haspekian (2020) in her MEDA2 plenary. Some of these frameworks explicitly focus on teachers' practices, characterizing teachers' expertise in supporting a fruitful integration of DT in teaching, such as the *structuring features of classroom practice* framework (Ruthven, 2009), and identifying categories of teachers' *instrumental orchestration* of classroom activities in technology-rich environments (Drijvers et al., 2010). Others explicitly refer to the roles played by teachers in the integration of DT in mathematics classrooms and to the levels at which teachers have to act to effectively integrate DT in their teaching (Trigueros et al., 2014).

The integration of DT in teaching affects also teachers' assessment practices. Focusing on the ways in which digital summative assessment is developed at university level, Iannone (2020) stresses on the need of re-thinking the ways in which assessment in the digital age is designed and implemented, observing that it is "far failing to realise its full potential and that usually it is designed in a conservative way" (p. 15). These reflections could be certainly referred also to the case of FA practices, which, according to Black and Wiliam (2009), could be conceived as practices through which evidence about student achievement is elicited, interpreted, and used by three main agents (teachers, learners and their peers) to make decisions about the next steps in instruction. The question of the integration of DT in Mathematics teaching for assessment purposes has been addressed in many research studies in the last decade (see, for instance, Stacey & Wiliam 2013, Cusi et al. 2017A, Dalby & Swan 2019, Olsher 2019).

In a review chapter aimed at reflecting on the changes in the ways in which mathematics is assessed due to the increasing availability of powerful technology, Stacey and Wiliam (2013) distinguish between *assessment with DT*, where the mathematical capabilities of technology are used by students in the mathematical performance that is being assessed, from *assessment through DT*, where technology is used to deliver and administer the assessment processes. According to them, "the real

power of computerized assessment is likely, in the future, to be in the creation of learning environments in which students use a range of information resources, engage with powerful software for problem solving, and collaborate with other students.” (p. 748). The role played by DT within these kinds of environments have been the object of various research studies in the last years. Jankvist et al. (2021), for example, investigated the ways in which CAS augment and change assessment situations (both summative and formative). They stress that the new kinds of orchestration that the use of CAS introduces change FA “from being an individual dialogue between teacher and student, which due to resources will need to happen relatively seldom, to a collective – although but perhaps anonymous – class discussion of the different problems and understandings present in the class.” (p. 114). The role played by the teacher seems to be crucial to avoid the risk of shifting to this kind of anonymous discussions. These reflections are also shared by Rezat et al. (2021), who, as a result of their investigation on the use of tasks with automated feedback within digital textbooks, stress on the need of a careful teacher’s handling of classroom discussions aimed at questioning and evaluating the arguments that students develop to make sense of the received feedback.

Connected classroom technologies (CCT) certainly represent powerful DT to support FA practices. By providing teachers with more insight into their students’ sense-making processes, they lead to more thoughtful teacher interventions to promote meaningful mathematical classroom discourse, prompted by shared responses and screens (Clark-Wilson, 2010). Clark-Wilson (2010) highlights the complexity of the roles played by the teacher in the context of FA, since managing the use of CCT in the mathematics classroom requires teachers to develop specific competences, such as, for example, being able to quickly make sense to the diversity of students’ screens that are visible. The ways in which these roles are shaped when sophisticated interactive systems are used has been investigated by Dalby and Swan (2019), who observe the emergence of differing views of the role of the teacher when using DT in the classroom, shifting from a central role to a role of “guide on the side”. Similar results stressing on the complexity of teachers’ roles have been highlighted by recent studies that investigated the use of dashboards as digital curricular resources and, in particular, the teachers’ role in planning, implementing, gathering information, and making real-time decisions starting from the “in-the-moment” pedagogical perspective provided by the teacher dashboards (Edson & Difanis Phillips, 2021). Amarasinghe et al. (2021) model teachers’ orchestration actions during their interaction with learning analytics dashboards to deconstruct the notion of orchestration load. Their study enabled them to highlight that the use of guiding tools, which visualize learners’ interactions with the learning systems and guide teachers to take remedial actions to enhance the learning situation, requires teachers to distribute their attention to evaluate both epistemic (the content of students’ responses) and social (the actions to be taken to foster collaboration) aspects, contributing in creating a cognitively demanding situation for them.

The teachers’ expertise in the use of various combinations of DT does not necessarily implies a corresponding expertise in the use of DT to develop FA processes, since making FA through DT an integral part of teachers’ practice requires changes in their beliefs about teaching and learning and in the classroom culture itself (Feldman & Capobianco, 2008). A three-level developmental progression for teachers’ full transition to the highest level of expertise in carrying out FA processes through DT is described by Bellman et al. (2014), who distinguish between: *immediate level*, when teachers

examine students' feedback and take decisions about "what to do next" after class; *expert level*, when teachers are able to use students' data to make "real time" decisions; and *master level*, when teachers are able to command the full range of advanced interactive capabilities that DT offer.

Macro level of analysis: a model to interpret teachers' FA practices through DT

In a recent work developed with Gilles Aldon, Barbel Barzel and Shai Olsher (Aldon et al., submitted for publication), we introduced a model aimed at supporting the interpretation of teachers' FA practices carried out through DT. The model, which was conceived by combining a survey of general literature on the issue of FA with a survey of studies on the use of DT for FA purposes, represents a refinement of the one introduced within the European Project FaSMEd (Aldon et al., 2017). It is constituted by three main elements: (a) the *key areas* in which FA practices can be taken forward; (b) the *moments* in which teachers' FA practices are carried out; (c) the *functionalities* provided by DT to support FA processes.

The *key areas* for FA (first element) have been identified by referring to the studies developed with the aim of investigating what happens inside the "black box" (Black & Wiliam, 1998), where FA theoretical principles become a reference for framing the design and implementation of FA in practice. The survey of these studies (due to space limitation, I just mention Black & Wiliam 1998, Black et al. 2003, Lee 2006, Bartlett 2015) enabled us to identify four main areas in which FA practices can be taken forward: (1) sharing goals and criteria with learners; (2) designing and implementing classroom discussions and other learning activities (which includes three fundamental processes: monitoring students' understanding, scaffolding their learning and fostering their reflections); (3) fostering the quality of feedback; (4) involving students in peer- and self-assessment.

The second element of the model - the *moments* in which teachers' FA practices are carried out - has been identified with the aim of better characterizing the complex work that teachers have to develop, in time, to carry out effective processes within the four areas. This element of the model was inspired by Mason's (2009) characterization of the processes developed by teachers to prepare themselves to teach a topic during four phases: *pre-paration*, *paration*, *meta-paration* and *post-paration*. In our model we combine *paration* and *meta-paration* in a unique moment, due to their strict interconnection, focusing on three moments that constitute a cycle of teacher's FA practices.

The starting point for the identification of the main *functionalities* that constitute the third element of our model is the framework introduced within FaSMEd, in which three functionalities of technology to support FA processes are considered: sending and displaying; processing and analyzing; and providing an interactive environment. The rapid evolution of digital tools, the new available formats of online interaction and the possibilities offered by artificial intelligence suggested as to extend these three functionalities to best capture the current realities. The result of this extension are the following three functionalities: (1) *communicating between the different agents of FA*, which involves all forms of communication with, through and of technology (Ball & Barzel, 2018); (2) *analyzing*, which involves different levels, from providing just an overview of the work progress, to providing information on the learning status, to realizing an advanced analysis which allows first insights in students' thinking; (3) *adapting*, which is related to the support that DT could provide to teachers in making decisions about the next steps in instruction, by simply offering tasks to be chosen by the

teacher, or suggesting the learning paths for students, or providing teachers with learning materials designed on the basis of a comprehensive learner's profile.

Micro level of analysis: the teacher's roles in fostering FA processes through DT

In this section I will focus on an example from a teaching experiment, carried out within the FaSMEd project in Italy (firstly presented in Cusi et al., 2019), to discuss the roles that the teacher could play during the phase of *paration/meta-paration* of a FA lesson developed with the support of DT. During the teaching experiment, activities were carried out through the use of a CCT. The example refers to the ways in which the teacher exploits the *communicating and analyzing* functionalities of this CCT by administering an instant poll to her students and by carrying out a classroom discussion starting from the results of the poll. The use of a CCT to develop FA processes involves the monitoring of students' work by sharing the students' screens with the teacher and the collecting and displaying of students' answers to design and implement fruitful discussions with students (*communicating* functionality). When instant polls are activated, the DT provides teachers with synthetic information on the class-wide distribution of answers to a focused question (*analyzing* functionality). Then, the teacher's task is to use this information to react in a supportive way, e.g. by designing and initiating in-the-moment classroom discussions to make students reflect on the processes developed when they answered to the polls (Cusi et al., 2019). In this example I focus on this last aspect, by sharing some reflections on the teacher's roles that proved to be effective in fostering the realization of a learning dialogue with students aimed at supporting their reflective processes.

The aim of my analysis of the example is to move: (a) from a *macro level of analysis* of a FA assessment practice realized through DT, which locates the teachers' actions within specific FA key areas (*the where of FA*), in a specific moment (*the when of FA*), and characterizes teachers' practices by highlighting the functionalities that are used (*the how of FA*), (b) to a *micro level of analysis*, which deepens the investigation of the *how of FA* by zooming into a scene of classroom interaction focusing on the teacher's interventions and on their effects in terms of the activated FA key-strategies.

To develop this micro analysis, I will interpret and analyze the teacher's interventions by referring to the MAEAB (acronym for "Model of Aware and Effective Attitudes and Behaviours") construct (Cusi & Malara, 2016). The key-roles characterizing the construct are subdivided into two groups. Here I focus on the roles that the teacher plays when she guides students to reflect on the approaches adopted during classroom activities and to become aware of the relationships between the activities in which they are involved and the knowledge they previously developed. The three key-roles belonging to this group are presented in Table 1, together with indicators to support the coding process.

I will highlight the strategies activated through teachers' interventions by referring to Black and Wiliam's (2009) five FA key-strategies: (1) clarifying and sharing learning intentions and criteria for success; (2) engineering effective classroom discussions and other learning tasks that elicit evidence of student understanding; (3) providing feedback that moves learners forward; (4) activating students as instructional resources for one another; (5) activating students as the owners of their own learning.

Roles of a M_{-AE}AB	Characterization of each role	Indicators to code each role
<i>Guide in fostering a harmonized balance between the syntactical and the semantic level</i>	She/he helps her/his students control the meaning and the syntactical correctness of the mathematical expressions they construct and, at the same time, the reasons underlying the correctness of the transformations they perform.	She/he poses questions/ makes interventions aimed at making students reflect on the correctness of specific transformations that are performed and highlight connections between the processes that characterize the resolution of a problem and the corresponding meanings. For example: “Is this transformation correct?”, “Why did you make this transformation?”, “How have we obtained this result?”.
<i>Reflective guide</i>	She/he stimulates reflections on the effective approaches carried out during class activities in order to make students identify effective practical/strategic models from which they can draw their inspiration in facing problems.	She/he poses questions / makes interventions aimed at supporting students in making the meaning of effective strategies/approaches explicit. For example: “Could you explain your reasoning to your classmates?”, “Is there someone that could explain his/her reasoning?”, “She/he reasoned in this way: “since I want to obtain this kind of result, I could...”.
<i>“Activator” of reflective attitudes and metacognitive acts</i>	She/he stimulates and provokes meta-level attitudes, with a focus on the control of the global sense of processes.	She/he poses questions / makes interventions aimed at supporting students in highlighting strengths/weaknesses of specific arguments/strategies and in fostering the sharing and comparison of different arguments/strategies. For example: “Do you agree with what she/he said?”, “Do you think it is an effective choice/strategy? Why?”, “What differences are there between these answers?”.

Table 1: The second group of roles within the M_{-AE}AB construct (Cusi & Malara, 2016)

The analysis of a wide set of data collected during the FaSMEd Project enabled us to classify polls according to their different focus and aims in relation to the aspects to be highlighted during classroom discussions that could be structured starting from polls’ results (Cusi et al., 2019). We identified four categories of polls: (a) polls on specific mathematical content; (b) polls on argumentation; (c) polls on metacognitive aspects; (d) polls on affective aspects. The instant poll discussed within this example belongs to category (c). It was administered to a grade 5 class at the end of a sequence of tasks on time-distance graphs and created on the spot by the teacher (T) and by a researcher (R), who participated to the lesson and guided the discussion with T.

This is the wording of the poll, aimed at boosting a metacognitive reflection on effective ways to tackle graph interpretation tasks: “*When interpreting a graph, what is the first thing you look at? (A)*

If the graph starts from the origin; (B) If the graph goes up or down; (C) If the graph has horizontal traits; (D) How many traits compose the graph; (E) How steep is the graph; (F) What is written on the axes. This poll does not encompass only one correct answer. The subsequent discussion was aimed at making visible students' strategies when approaching a graph and compare the efficiency of such strategies. In Cusi et al. (2019), a long excerpt from this classroom discussion was analysed to highlight the FA strategies activated by T and R during the discussion and the characteristics of the ways in which FA discussions developed thanks to the activation of polls are initiated and evolve.

At the beginning of the classroom discussion, to which the following excerpt refers, R displays on the interactive whiteboard the results of the instant poll: most students (72%) chose option F, 18% chose A and 9% chose C.

1. R: Here we have 72% that answered F. Someone chose A: "If the graph starts from the origin". Someone chose C: "If there are horizontal traits". The other options were not chosen. Some of you said to have changed her mind. Would you like to tell it now? (*speaking to Sabrina, who, before the beginning of the discussion, asked R to change her mind*)
2. Sabrina: We chose A, but later we changed our mind. We want to choose F.
3. R: So, actually for you it is F? We could start from F. Why do you think the first thing to look at is what is written on the axes? (*some students raise their hands. Among them, Elsa and Carlo, who worked in pairs*)
4. Elsa: Because, if you look at what is written on the axes, you can already understand the graph... and you can get some information.
5. R: Let's listen to somebody else. Carlo.
6. Carlo: I wanted to say that on the axes it is written what they are, what you have to measure, look at, observe...
7. R: Ok.
8. Luca: Also on the axes... if, for instance, it had been the contrary, here (*with gestures, he draws a vertical line*) the time and here (*with gestures, he draws a horizontal line*) the distance, the graph would have changed... (*he draws with gestures a possible new graph*).
9. R: Did you listen to what Luca said? (*speaking with the other students*)
10. Voices: Yes!
11. R: I guess that somebody did not listen.
12. T: He said a very interesting thing.
13. R: Would you like to repeat what Luca said? (*to a student who raised her hand*).

This short excerpt shows how the teacher (in this case R) could initiate a classroom discussion aimed at exploiting the results of a poll on metacognitive aspects to activate the *FA strategy 2*. The excerpt starts with R highlighting one typical effect of the displaying of polls' results, that is student's revision of their answer (*FA strategy 5*). R, in fact, poses herself as an *activator of reflective attitudes and metacognitive acts* (line 1), making the class notice that Sabrina and her mate have changed their mind and asking to the two students to share their reflections and to make their thinking explicit.

The role of *activator of reflective attitudes and metacognitive acts* is again played by R in line 3, when she focuses on the most chosen answer (F) and stimulates a discussion on the reasons subtended to the choice of looking at what is written on the axes. This makes Elsa and Carlo intervene (lines 4 and 6) to justify their choice, activating themselves as *resources for their classmates (FA strategy 4)* by explaining that knowing the variables represented on the axes make it easier to interpret the graph and to grasp the information it brings.

When Luca expresses his idea (*FA strategy 5*) proposing an interesting observation about the effects of inverting the two variables represented on the axes of the graph (line 8), R, to highlight Luca's intervention and to turn him into a real *resource for his classmates (FA strategy 4)*, poses herself as a *reflective guide*, relaunching Luca's intervention and asking to other pupils to repeat Luca's idea (lines 9, 11, 13). This strategy makes Luca's thinking visible to his classmates.

The discussion goes on with a collective reflection on the effects, on the graph, of inverting the variables on the two axes. During this phase of reflection (not reported within the excerpt), R poses herself also as a *guide in fostering a harmonized balance between the syntactical and the semantic level*, with the effect of giving feedback that moves students' learning forward (*FA strategy 3*).

The analysis of the whole set of data collected within the FaSMed project enabled us to identify other ways of initiating and developing discussions on metacognitive aspects, such as focusing on the options that were not chosen and asking students the reasons for not having chosen them. The analysis of these data confirmed the results on the interrelation between the key roles played by the teacher and the corresponding FA strategies highlighted in the example reported in this section.

Concluding remarks

In this contribution I shared reflections on the ways in which teachers' practices in developing and supporting FA processes through DT could be interpreted and analysed. In the path toward the development of these reflections, I gradually zoomed into the investigation of teachers' practices by shifting the focus: (1) from the results of research studies that investigated the teachers' practices in exploiting the support provided by DT to develop FA processes; (2) to a model recently refined to characterize the teachers' FA practices with DT at a *macro level* by describing *the where, the when* and *the how* of these practices; (3) to the presentation of an example aimed at deepening the investigation of the *how* of teachers' FA practices through DT by developing an analysis at a *micro level* to highlight the roles that the teacher plays when interacting with his/her students.

The analysis shared in the last section was focused on the teachers' roles associated to specific interventions during episodes of classroom interaction located within the *paration/meta-paration moment* and supported by the *analyzing* and *communicating functionalities* of DT. This analysis highlighted the connection between specific roles that are played and the corresponding FA strategies that could be activated, which locate the example within the *second* and *fourth key areas* of FA. In particular, it showed that a combination of the roles of *activator of reflective attitudes and metacognitive acts* and of *reflective guide* contributes to the implementation of classroom discussions aimed at fostering students' meta-level reflections (*second area*) and at involving them in peer- and self-assessment (*fourth area*).

The micro level analysis of several classroom interactions performed during teaching experiments developed within FaSMed and other projects led us to reflect on other aspects that characterize the teachers' FA practices through DT, such as the typical strategies employed by the teacher to provide feedback (Cusi et al., 2017B) or the roles that teachers can activate to guide classroom discussions aimed at supporting students' argumentative processes and at scaffolding their awareness about the effectiveness of the written productions they share by means of digital environments (Cusi & Olsher, 2021). The crucial role played by the teacher was also highlighted in the context of a digital

environment aimed at supporting students in individually revising mathematical topics through individualized digital paths at university level, since the tutor's interventions proved to be fundamental in supporting students' interpretation of the meta-scaffolding and feedback provided by the digital environment (Cusi & Telloni, 2020).

In this contribution I focused on what the teachers do to develop FA processes through the support of DT. As a contribution to the issue of delineating a model to characterize teachers' FA practices in the digital age, it is important to intertwine the analysis of what teachers do with the analysis of how they interpret what they do, that is how they describe and justify their FA practices through DT. We started this kind of investigation within two studies carried out at the beginning of the Covid-19 emergency and after one year from the first lockdowns (Aldon et al., 2021; Cusi et al., 2022). These studies have shown that the experience of distance teaching triggered teachers' reflections on the future of assessment in Mathematics and enabled them to highlight the value of FA. Moreover, the distance teaching experience enabled some teachers to discover other 'possibilities', that is, other possible ways of developing assessment processes, potentially enlarging their repertoire of assessment techniques by exploiting the potentialities offered by DT. The results of these studies also showed that not all of the new techniques discovered by teachers continued to be part of their praxeologies after the distance teaching experience. This enabled us to develop reflections on the 'stability' of the changes and transformations of assessment practices declared by teachers and on the need of promoting and supporting the stabilization of these changes by focusing on educational programmes aimed at deepening teachers' professional development to foster the teachers' autonomous use of DT to carry out effective FA practices.

References

- Aldon, G., Barzel, B., Cusi, A., & Olsher, S. (submitted for publication). Rethinking teachers' formative assessment practices within technology-enhanced classrooms. In B. Pepin, G. Gueudet & J. Choppin (Eds.), *Handbook of Digital Resources in Mathematics Education*. Springer.
- Aldon, G., Cusi, A., Morselli, F., Panero, M., & Sabena, C. (2017). Formative assessment and technology: reflections developed through the collaboration between teachers and researchers. In G. Aldon, F. Hitt, L. Bazzini & U. Gellert (Eds.), *Mathematics and technology: a CIEAEM source book* (pp. 551–578). Springer.
- Aldon, G., Cusi, A., Schacht, F., & Swidan, O. (2021). Teaching Mathematics in a Context of Lockdown: A Study Focused on Teachers' Praxeologies. *Education Sciences*, 11(2), 38.
- Amarasinghe, I., Hernández-Leo, D., & Ulrich Hoppe, H. (2021). Deconstructing orchestration load: comparing teacher support through mirroring and guiding. *International Journal of computer-supported collaborative learning*, 16, 307–338.
- Ball, L. & Barzel, B. (2018). Communication when learning and teaching mathematics with technology. In L. Ball, P. Drijvers, S. Ladel, H.-S. Siller, M. Tabach & C. Vale (Eds.), *Uses of Technology in Primary and Secondary Mathematics Education: Tools, Topics and Trends* (pp. 227–244). Springer International Publishing.
- Bartlett, J. (2015). *Outstanding assessment for learning in the classroom*. Routledge.

- Bellman, A., Foshay, W. R., & Gremillion, D. (2014). A Developmental Model for Adaptive and Differentiated Instruction Using Classroom Networking Technology. In A. Clark-Wilson, O. Robutti, & N. Sinclair (eds.), *The Mathematics Teacher in the Digital Era, Mathematics Education in the Digital Era 2* (pp. 347–372). Springer.
- Black, P., & Wiliam, D. (1998). Assessment and classroom learning. *Assessment in Education: Principles Policy & Practice*, 5(1), 7–74.
- Black, P., & Wiliam, D. (2009). Developing the theory of formative assessment. *Educational Assessment, Evaluation and Accountability*, 21(1), 5–31.
- Black, P., Harrison, C., Lee, C., Marshall, B., & Wiliam, D. (2003). *Assessment for learning. Putting it into practice*. Open university press.
- Clark-Wilson, A. (2010). Emergent pedagogies and the changing role of the teacher in the TI-Nspire Navigator-networked mathematics classroom. *ZDM Mathematics Education*, 42, 747–761.
- Cusi, A., & Malara, N.A. (2016). The Intertwining of Theory and Practice: Influences on Ways of Teaching and Teachers' Education. In L. English, & D. Kirshner (Eds.), *Handbook of International Research in Mathematics Education 3rd Edition* (pp. 504–522). Taylor & Francis.
- Cusi, A., Morselli, F., & Sabena, C. (2017A). Promoting Formative Assessment in a Connected Classroom Environment: Design and Implementation of Digital Resources. *ZDM: The International Journal on Mathematics Education*, 49(5), 755–767.
- Cusi, A., Morselli, F., & Sabena, C. (2017B). Enhancing formative assessment in mathematical class discussion: a matter of feedback. In T. Dooley & G. Gueudet (Eds.), *Proceedings of Cerme 10* (pp. 3460–3467). DCU Institute of Education and ERME.
- Cusi, A., Morselli, F., & Sabena, C. (2019). The Use of Polls to Enhance Formative Assessment Processes in Mathematics Classroom Discussions. In G. Aldon & J. Trgalova (Eds.), *Technology in Mathematics Teaching*. (pp. 7–30). Springer.
- Cusi, A., & Olsher, S. (2021). Design of Classroom Discussions and the Role of the Expert in Fostering an Effective and Aware Use of Examples as a Means of Argumentation. *International Journal of Science and Mathematics Education*.
- Cusi, A., Schacht, F., Aldon, G., & Swidan, O. (2022). Assessment in mathematics: a study on teachers' practices in times of pandemic. *ZDM Mathematics Education*.
- Cusi, A., & Telloni, A.I. (2020). Re-design of digital tasks: the role of automatic and expert scaffolding at university level. In A. Donevska-Todorova, E. Faggiano, J. Trgalova, Z. Lavicza, R. Weinhandl, A. Clark-Wilson, & H.-G. Weigand (Eds.), *Proceedings of MEDA 2020* (pp. 159–166). Johannes Kepler University.
- Dalby, D., & Swan, M. (2019). Using digital technology to enhance formative assessment in mathematics classroom. *British Journal of Educational Technology*, 50(2), 832–845.

- Drijvers, P., Doorman, M., Boon, P., Reed, H., & Gravemeijer, K. (2010). The teacher and the tool: instrumental orchestrations in the technology-rich mathematics classroom. *Educational Studies in Mathematics*, 75(2), 213–234.
- Edson, A. J., & Difanis Phillips, E. (2021). Connecting a teacher dashboard to a student digital collaborative environment: supporting teacher enactment of problem-based mathematics curriculum. *ZDM – Mathematics Education*, 53, 1285–1298.
- Feldman, A., & Capobianco, B.M. (2008). Teacher Learning of Technology Enhanced Formative Assessment. *Journal of Science Education and Technology*, 17, 82–99.
- Haspekian, M. (2020). Teaching practices in digital era: some theoretical and methodological perspectives. In A. Donevska-Todorova, E. Faggiano, J. Trgalova, Z. Lavicza, R. Weinhandl, A. Clark-Wilson, & H.-G. Weigand (Eds.), *Proceedings of MEDA 2* (pp. 3–10). Johanne Kepler University.
- Jankvist, U.T., Dreyøe, J., Geraniou, E., Weigand, H-G., & Misfeldt, M. (2021). CAS from an assessment point of view. Challenges and potentials. In A. Clark-Wilson, A. Donevska-Todorova, E. Faggiano, J. Trgalova & H.-G. Weigand (Eds.), *Mathematics Education in the Digital Age. Learning, practice and theory* (pp. 99–120). Routledge.
- Iannone, P. (2020). Assessment of mathematics in the digital age: The case of university mathematics. In A. Donevska-Todorova, E. Faggiano, J. Trgalova, Z. Lavicza, R. Weinhandl, A. Clark-Wilson, & H.-G. Weigand (Eds.), *Proceedings of MEDA 2* (pp. 11–18). Johannes Kepler University.
- Lee, C. (2006). *Assessment for learning in practice*. Open university press.
- Mason, J. (2009) Teaching as disciplined enquiry. *Teachers and Teaching*, 15(2), 205–223.
- Olsher, S. (2019). Making good practice common using computer-aided formative assessment. In G. Aldon & J. Trgalova (Eds.), *Technology in Mathematics Teaching* (pp. 31–47). Springer.
- Rezat, S., Schacht, F., & Häsel-Weide, U. (2021). Challenges of making sense of tasks and automated feedback in digital mathematics textbooks. In A. Clark-Wilson, A. Donevska-Todorova, E. Faggiano, J. Trgalova & H.-G. Weigand (Eds.), *Mathematics Education in the Digital Age. Learning, practice and theory* (pp. 168–184). Routledge.
- Ruthven, K. (2009). Towards a naturalistic conceptualisation of technology integration in classroom practice: The example of school mathematics. *Education & Didactique*, 3(1), 131–149.
- Stacey, K., & Wiliam, D. (2013). Technology and Assessment in Mathematics. In M. A. Clements, A. J. Bishop, C. Keitel, J. Kilpatrick, & F. K. S. Leung (Eds.), *Third International Handbook of Mathematics Education* (pp. 721–751). Springer.
- Trigueros, M., Lozano, M.-D., & Sandoval, I. (2014). Integrating Technology in the Primary School Mathematics Classroom: The Role of the Teacher. In A. Clark-Wilson, O. Robutti, & N. Sinclair (Eds.), *The Mathematics Teacher in the Digital Era, Mathematics Education in the Digital Era 2* (pp. 111–138). Springer.

Design of digital resources by and for mathematics teachers

Jana Trgalová

Haute école pédagogique du canton de Vaud, Lausanne, Switzerland; jana.trgalova@hepl.ch

This text is the written version of the plenary talk given at the third conference on Mathematics Education in the Digital Era, held from 7-9th September 2022 in Nitra, Slovakia. Research on the use of digital technology in mathematics teaching and learning shows that key affordances of technology emanate from the tasks that are used with it. Moreover, carefully designed tasks with their appropriate enactment by teachers are necessary for an efficient use of technology fostering students' learning. In this talk, we therefore focus on digital resources offering technology-based mathematical tasks, adopting the perspective of their design. We draw on our experience of a course for pre-service mathematics teachers based on collaborative design of digital resources.

Keywords: digital resources, design, teacher pedagogical design capacity, teacher design team

Introduction

Recent research studies in mathematics education focusing on teachers' professional activity tend to consider teaching as a design activity (Brown, 2009; Brown & Edelson, 2003). Teachers' use of resources has become a research topic assuming that it is an *act of creation* rather than a simple consumption. The interest mathematics education community pays to studying teachers' interactions with resources is witnessed by the development of related theoretical frameworks, such as the *documentational approach to didactics* (Gueudet & Trouche, 2012) that considers teachers' work with resources as being at the heart of their professional activity, or the conceptualization of the *curriculum enactment process* (Remillard & Heck, 2014) that posits a distinction between an official (prescribed) and an operational (intended and enacted) curriculum. This perspective is aligned with the view of *teachers as designers of the curriculum* enacted in their classroom rather than as mere 'implementers' of curricular materials (Jones & Pepin, 2016), or with the view of adaptation of resources that is required for their appropriation (Hoyles et al., 2013; Trgalová & Rousson, 2017).

More specifically regarding mathematics teachers' use of digital technology, research findings show that key affordances of technology emanate from the tasks that are used with it (Thomas & Lin, 2013). Likewise, Jones (2005) claims that carefully designed tasks with their appropriate enactment by teachers are necessary for an efficient use of technology fostering students' learning.

Based on these considerations, it seems important that teacher training course on digital technologies includes the development of teachers' task design and enactment capacities. On this principle, a pre-service teacher's course was developed at the Claude Bernard University in Lyon, France. The course was attended by student-teachers who were enrolled for a half-time in their teacher education program and taught mathematics in a secondary school for their second half-time. In this talk, we share the experience of the implementation of this course for several years, discuss the design choices and investigate the extent to which the participating

student-teachers developed the above-mentioned capacities. We start by presenting the theoretical framework that we subsequently use to highlight the design choices.

Theoretical framework

The theoretical framework we use for the analysis of the pre-service teacher training course is constituted of the concepts of teacher *pedagogical design capacity*, *teacher design teams* and *facilitator*. We elaborate on these concepts in the following sub-sections.

Pedagogical design capacity

Brown (2009) considers that teachers select, interpret, and adjust curriculum material they use in their teaching. From this point of view, teaching is viewed as a form of design, which leads the author to investigating the dynamics between teachers and their materials. The author introduces the term *pedagogical design capacity* (PDC) to designate teacher's

skill in perceiving the affordances of the materials and making decisions about how to use them to craft instructional episodes that achieve her goals (p. 29).

Pepin et al. (2017) draw on the concept of PDC to further conceptualize what they call *teacher design capacity* (TDC). According to the authors, TDC consists of the following three main components:

- orientation, goal, points of reference for the design, which include knowledge of the classroom context (in particular what do students know and their misconceptions), knowledge of the curriculum guidelines and the learning trajectory related to a specific topic, and knowledge of the position of the design in the short and the long terms;
- set of design principles, which are both robust – evidence informed and supported by justification of their choices, and flexible – possible to adapt to new challenges and contexts;
- reflection-in-action that is an ability to adapt actions in the course of the instruction.

Huizinga et al. (2015) suggest the following activities that favor TDC development: using exemplary materials, evaluating designed material, and sharing experiences of the conducted design process.

Teacher design teams and the facilitator

In recent years, teacher professional development tends to shift from a couple of days events to other models based on long term collaboration within communities of practice (Wenger, 1998). Drawing on other research studies, Becuwe et al. (2016) claim that “the involvement of teachers in collaborative design constitutes an effective strategy for professional development” (p. 2). Handelzalts (2009) introduced the concept of a teacher design team (TDT) defined as

a group of at least two teachers, from the same or related subjects, working together on a regular basis, with the goal to (re)design and enact (a part of) their common curriculum (p. 7).

The fact that TDTs develop curricular material for their own use distinguishes them from other teachers' teams who design materials for others, for example in collaboration with publishers.

According to the author, this distinctive feature is of the foremost importance with respect to the appropriation of the designed material:

Collaboration in design of materials that the teachers themselves will use, and will therefore affect their practice directly, raises their stakes in the process and the ownership of the product (ibid., p. 8).

According to Becuwe et al. (2016), TDTs are often supported by a *facilitator*. The authors highlight three main roles of a facilitator:

- *providing logistic support*, e.g., taking notes, sending emails, coordinating and organizing a TDT;
- *scaffolding the design process* by providing the right tools at a right moment (e.g., design models, theoretical considerations);
- *monitoring the design* by providing pro-active support helping outline the design process and re-active support for ensuring readjustment of the design when necessary.

Pre-service teacher training course on digital technology

This section is devoted to the description and analysis of the pre-service teacher education module focused on digital technology for mathematics teaching and learning. This course is offered in the Master of the teaching of mathematics, which is a two-year program of pre-service teacher education. Two courses focusing on digital technology are offered to future teachers: a course offered in year 1 is centered on mathematics specific digital technology and their affordances for mathematics teaching and learning; digital technology is the object of the study. The course in year 2 proposes to question how digital technology can enhance teaching and learning specific mathematical topics; technology is thus studied as a teaching tool. In this text, we only present the year 2 course, which lasts for 15 hours organized in seven 2 or 3hour sessions.

Sessions 1-3: choice of the appropriate technology to solve given tasks. The first three sessions of the module are devoted to exploring mathematics topics – arithmetic, algebra, functions; geometry; statistics, probability, series – with digital technology – dynamic geometry, spreadsheet, Scratch and Python (these digital tools are recommended by the French secondary school mathematics curricula). The instructors prepare two kinds of tasks: series of tasks to be solved with two different digital tools the student-teachers choose from a proposed list, and another series of tasks that the student-teachers solve with a tool they choose on their own. The student-teachers are invited to first solve the tasks, then compare and contrast solutions with different technologies, and finally discuss the contributions of the digital tools to teaching and learning mathematics at stake in the tasks.

Referring to Huizinga et al.'s (2015) activities favoring TDC development, these tasks can be considered as exemplary that student-teachers are encouraged to analyze and evaluate. From the instructors' point of view, the aim of these tasks is to support student-teachers' thought process towards deciding when and which technology to use to achieve a given educational goal.

Sessions 4-5: resource design by the student-teacher design teams. During the next two sessions, student-teachers are split up into teams of 2-4 and are involved in the design of a digital resource consisting of a task mobilizing a digital tool that at least some of the team members would enact in their classrooms, the rationale explaining the design choices and arguing the contribution of the digital tool to the achievement of their learning goal, and the classroom enactment planification. The design of the resource is monitored by the instructors-facilitators who support the design process by various actions. First, they provide a *pro-active support* to the STDTs in the form of a *resource template* (Figure 1) that aims at structuring the resource design and a priori analysis. The resource template provides the STDTs with guidance towards defining mathematical topic, learning goal and school level that the resource would address, towards choosing a digital tool, designing the technology-enriched task, performing its a priori analysis, and suggesting a planned classroom enactment.

[Title of the technology-supported activity]

1. Identity card

Professional question	
Mathematical topic	
School level	
Teaching goal	
Technology	
Author(s)	

2. Text of the activity (as it will be proposed to students)

3. A priori analysis of the activity

- What is the student's task (what should they do)?
- What do students need to know (in mathematics and with respect to the use of technology) in order to be able to engage in the activity?
- What strategies the students can use? What is the expected strategy, if there is one?
- What difficulties the students can encounter while solving the activity? What hints and feedback can be foreseen to face them?
- What is the role of the technology in the activity? What is its contribution?
- What can be put forward during the synthesis (institutionalization), in terms of mathematical and instrumental knowledge?

Figure 1. Excerpt of the resource template

To facilitate the resource design, the instructors introduce theoretical considerations when appropriate, in particular:

- *Old/new dialectics* (Assude & Gélis, 2002) according to which, when integrating a digital tool, teachers need to pay attention to students' mathematical or instrumental prerequisites so that no new mathematical knowledge is introduced with a new tool. In other words, a new tool should be introduced by revisiting a known mathematical knowledge that would help control the tool use, and a new mathematical knowledge should be introduced with a tool the students master well enough.
- *SAMR framework* (substitution-augmentation-modification-redefinition) (Puentedura, 2006), offering a conceptual tool to reflect on the added-value of the digital tool.

- *Instrumental orchestration* (Trouche, 2004) to think about the ways of accompanying students' exploitation of the digital tool (Figure 2).

4. Implementation of the activity (pedagogical scenario)
 In the table below, describe the main phases of the planned enactment of the activity during a mathematics session. Please feel free to modify the table if you wish.

Phase / duration	Goal	Modality/instrumental orchestration	Role of the student(s)	Role of the teacher	Material support
Phase 1 5 min	Presentation of the activity	Whole class	Listen	Explain the tasks, asks students' reformulation	Projection on a whiteboard

Figure 2. Excerpt of the resource template asking for the description of the classroom enactment of the resource mobilizing the concept of instrumental orchestration

Finally, the instructors provide the STDTs with feedback on their resource design (*re-active support*, Figure 3).

Le problème de la maison couchée

1. Carte d'identité

Problématique professionnelle

Thème mathématique	Géométrie
Niveau scolaire	7 ^{ème}
Objectif d'apprentissage	Tracer une figure robuste
Outil numérique	Geogebra
Auteur(s)	Alice CANTIANI Louis MARTELET Yann SARTOR

2. Énoncé de l'activité

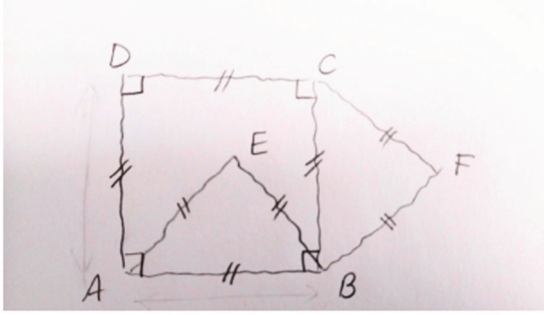

Le polygone ABCD est un carré. Les triangles AEB et BFC sont deux triangles équilatéraux. Donc, dans cette figure.

1. Construire, partie exercice, la figure en choisissant une mesure pour la longueur AB.
2. Que pouvez-vous dire des points D,E,F ?

Figure 3. Instructors' feedback on the resource design of one STDT asking for refining the learning goal (top) and for justifying the design choices (bottom)

Session 6: peer evaluation and redesign. During this session, the STDTs offer critical feedback to their peers and redesign their resource taking into account peers' critics and suggestions. Referring to Huizinga et al.'s (2015) activities to favor the PDC development, the STDTs are engaged in evaluating designed materials. The evaluation is organized in two phases: first each STDT evaluates the resource of another STDT, and second, the pairs of STDTs exchange about their mutual evaluations, explain their appreciations and offer suggestions for the resource improvement. This phase is followed by a redesign of the resources by the STDTs (Figure 4).

The instructors-facilitators support the evaluation of the resources by providing the STDTs with an *evaluation grid (pro-active support)* comprising:

- four evaluation criteria: description of the instrumented task, relevance of the digital tool mobilized in the task, students' activity, and teacher's role,
- overall appreciation of the resource,
- suggested improvements.

The instructors also facilitate the STDTs exchanges and discussions (*inter-active support*).

Le problème de la maison couchée

1. Carte d'identité

Les modifications faisant suite à l'évaluation du projet entre groupe sont notés en vert.

Thème mathématique	Géométrie
Niveau scolaire	6e
Objectif d'apprentissage	Faire émerger la notion de robustesse d'une figure dynamique
Objectif indirect	Découvrir la notion de conjecture, de démonstration qui n'est pas au programme de sixième
Outil numérique	Geogebra
Auteur(s)	Alice CANTIANI Louis MARTELET Yann SARTOR
Problématique professionnelle :	L'activité permet de tester la gestion de classe en situation de travail instrumentée (géogebra). Réfléchir à la polyvalence d'un énoncé mathématique (l'activité relève de plusieurs concept : notion de robustesse, de conjecture/démonstration...) Vérifier expérimentalement les conjectures des élèves. Enfin, la construction papier diffère de géogebra, ce qui amène à réfléchir aux propriétés des figures et à leur utilisation dans le cadre de la construction.

Justification de l'utilisation de géogebra

- Le logiciel permet seulement de conforter l'intuition des élèves, voir simplement d'obtenir un tracé précis (attention lors de l'institutionnalisation insister sur le fait que geogebra permet seulement de conjecturer, pas de prouver)

En sixième, la précision en géométrie leur fait souvent défaut sur papier :

- mesurer une longueur
- tracer un segment de manière précise
- équerre mal placée pour tracer un angle droit
- reporter longueur au compas

- Voir si l'alignement est vrai pour n'importe quelle longueur du côté du carré : robustesse d'une figure

Phase 6 : Mise en commun et correction des étapes à suivre pour construire la figure

Le prof interroge les élèves sur les étapes à suivre pour tracer la figure, reprendre les élèves si le vocabulaire n'est pas adéquat, car il faut utiliser un vocabulaire précis. Le professeur construit étape par étape la figure sur géogebra, son écran est projeté au tableau. Les élèves doivent construire en même temps avec le prof si cela n'a pas été réussi

Phase 7 : Réponse à la question et observation de la robustesse de la figure

Le professeur demande la réponse à la question, "comment semblent les points D,E,F ?" Ensuite le professeur montre la robustesse de la figure en agrandissant les côtés ou en tournant la figure.

Phase 8 : Institutionnalisation

Le professeur explique à l'oral :

- ce qu'est une figure robuste

et introduit :

- ce qu'est une conjecture
- le rôle qu'à jouer Géogebra dans la résolution de l'exercice, pour appuyer une idée, une hypothèse. Ce logiciel permet de supprimer les erreurs liées aux imprécisions lors des tracés et de voir que les points restent alignés, quelque soit la longueur prise au départ.
- ce qu'est une démonstration et que plus tard dans l'année , on saura prouver à l'aide des angles que ces points sont bien alignés, mais tout ceci sous forme d'exercice

Suite envisagée, ouverture, prolongement:

Deux prolongements possibles : une autre activité géogebra mettant également en oeuvre la robustesse d'une figure. De plus, la prémisses conjecture/ démonstration est un élément incontournable des mathématiques du collège : la démonstration du problème d'alignement sera vue lors du chapitre sur les angles au cours de l'année.

Figure 4. Excerpts from a resource designed by a STDT in which text in green highlights modifications made based on the peers' feedback

Session 7: resource presentations and reports from classroom enactment. The last session of the module is devoted to resource presentations and the report from the experiences of their classroom enactment by members of the STDTs. The STDTs are asked to highlight strengths and weaknesses of their designs, to account for the classroom enactment by emphasizing the students' learning and the role of the digital tool and to suggest improvements of their resource. The STDTs are thus engaged in sharing experiences from the design and classroom enactment (Huizinga et al., 2015).

The instructors facilitate the report by providing the STDTs with three kinds of support:

- *Pro-active support* by suggesting a presentation template. The template invites the STDTs to synthesize their presentation by focusing on the strongest aspect of their resource, on one aspect deserving improvement and on reflecting about the impact of the digital tool on students' mathematical activity and learning.
- *Inter-active support* to facilitate whole class discussions.
- *Re-active support* by attempting to connect the STDTs reports with the theoretical considerations introduced during the module and by highlighting issues that emerge from the reports.

Concluding remarks

In this paper, we described a module on digital technology that has been offered for several years in the framework of the mathematics teacher education within a Master for the teaching of mathematics at the university in Lyon. The module aimed at the development of the teachers' design capacity. Drawing on the concept of teacher design teams, reported as an efficient modality of teacher professional development (Handelzalts, 2009; Becuwe et al., 2016), a part of the module was organized around the design of digital resources by groups of students-teachers, called *student-teachers design teams* (STDTs). Our analysis highlights the role of the instructors who acted as *facilitators*

- before the resource design, by selecting exemplary technology-based tasks creating the opportunity for the student-teachers to reflect on when and which digital technology seems appropriate with respect to the given learning goal;
- during the resource design by introducing theoretical considerations facilitating the design process and providing formative feedback;
- after the resource design by facilitating reporting from the classroom enactment of the resources and highlighting lessons learnt.

From the instructors' point of view, the module presented an opportunity for many student-teachers to gain their first experience with the students' use of digital technology. Indeed, they confessed that without having been encouraged to design and enact their resource in their classroom, they would not have dared doing it, not being confident enough in their digital competencies. The module also presented an opportunity for the student-teachers to learn from and with their peers through collaborative resource design.

However, student-teachers faced several challenges. The first challenge is to consider using technology to enhance students' mathematical activity. Indeed, quite often, the goal of the designed tasks is to introduce the students to a new digital tool. The instructors' re-active support turns to be critical attempting to reorient the STDTs' educational goals. Another challenge many student-teachers faced was classroom management of the technology-based tasks. Often, they underestimated students' technical difficulties, and more generally, the students' heterogeneity with respect to the digital tool mastery. Integrating the old/new dialectics in the resource design is far from being obvious for many STDTs. Finally, perceiving the digital tool contribution appeared also challenging. During the report from the enactment,

the STDTs often reported only a positive impact on students' motivation and failed in analyzing its contribution to students' mathematical activity and learning.

From the research point of view, we feel that the analysis of the choices of the module design enabled us to highlight critical components of the teacher design capacity (TDC). First, *knowing when the use of digital technology is appropriate* seems an important component of the TDC leading to a *well-reasoned use of technology*. Second, *knowing how to articulate mathematical and technical knowledge*, drawing on the old/new dialectics (Assude & Gélis, 2002) is another important component required for an *integration of digital technology*, beyond its isolated, occasional use. Finally, *being able to set up appropriate instrumental orchestrations fostering students' instrumental geneses* (Trouche, 2004) is yet another important TDC component leading to digital technology enhanced learning of mathematics. These components are specific to the design of digital resources, unlike those reported in previous research studies (e.g., Brown, 2009; Pepin et al., 2017) that can apply to non-digital resources as well. We therefore feel that our study represents a contribution towards the conceptualization of mathematics teachers digital resource design capacity (DRDC).

References

- Assude, T., & Gélis, J.-M. (2002). La dialectique ancien-nouveau dans l'intégration de Cabri-géomètre à l'école primaire. *Educational studies in mathematics*, 50, 259-287.
- Becuwe, H., Tondeur, J., Pareja Roblin, N., Thys, J., & Castelein, E. (2016). Teacher design teams as a strategy for professional development: the role of the facilitator. *Educational Research and Evaluation*, 3(4), 141-154.
- Brown, M. W. (2009). The teacher-tool relationship: Theorizing the design and use of curriculum materials. In J. T. Remillard et al. (Eds.), *Mathematics teachers at work: Connecting curriculum materials and classroom instruction* (pp. 17-36). New York: Routledge.
- Brown, M., & Edelson, D. C. (2003). *Teaching as design: Can we better understand the ways in which teachers use materials so we can better design materials to support their changes in practice?* LeTUS Report Series.
- Gueudet, G., & Trouche, L. (2012). Teachers' work with resources: documentation geneses and professional geneses. In G. Gueudet et al. (Eds.), *From Text to 'Lived' Resources: Mathematics Curriculum Materials and Teacher Development* (pp. 23-41). New York: Springer.
- Handelzalts, A. (2009). *Collaborative curriculum development in teacher design teams*. Doctoral dissertation, University of Twente, The Netherlands. http://doc.utwente.nl/67385/1/thesis_A_Handelzalts.pdf
- Hoyles, C., Noss, R., Vahey, P., & Roschelle, J. (2013). Cornerstone Mathematics: designing digital technology for teacher adaptation and scaling. *ZDM Mathematics Education*, 45, 1057-1070.

- Huizinga, T., Handelzalts, A., Nieveen, N., & Voogt, J. (2015). Fostering teachers' design expertise in teacher design teams: Conductive design and supportive activities. *The Curriculum Journal*, 26(1), 137–163.
- Jones, K. (2005). Research on the use of dynamic geometry software: implications for the classroom. In J. Edwards & D. Wright (Eds.), *Integrating ICT into the Mathematics Classroom* (pp. 27-29). Derby: Association of Teachers of Mathematics.
- Jones, K., & Pepin, B. (2016). Research on mathematics teachers as partners in task design. *Journal of Mathematics Teacher Education*, 19(2/3), 105–121.
- Pepin, B., Gueudet, G., & Trouche, L. (2017). Refining teacher design capacity: Mathematics teachers' interactions-sourcing teacher work and interactions with digital curriculum resources. *ZDM Mathematics Education*, 49, 999–812.
- Puentedura, R. R. (2006). *Transformation, Technology, and Education*. Screencast of the presentation delivered August 18, 2006. <http://hippasus.com/resources/tte/>
- Remillard, J. T., & Heck, D. (2014). Conceptualizing the curriculum enactment process in mathematics education. *ZDM Mathematics Education*, 46(5), 705–718.
- Thomas, M. O. J., & Lin, C. (2013). Designing tasks for use with digital technology. In C. Margolinas (Ed.), *Task design in mathematics education. Proceedings of ICMI Study 22* (Vol. 1, pp. 111-119). Oxford.
- Trgalová, J., & Rousson, L. (2017). Model of Appropriation of a Curricular Resource: A Case of a Digital Game for the Teaching of Enumeration Skills in Kindergarten. *ZDM – Mathematics Education*, 49(5), 769-784.
- Trouche, L. (2004). Managing the complexity of human/machine interactions in computerized learning environments: Guiding students' command process through instrumental orchestrations. *International Journal of Computers for Mathematics Learning*, 9, 281–307.
- Wenger, E. (1998). *Communities of practice: learning, meaning and identity*. Cambridge University Press.

Computational thinking and mathematics education: Debating synergies and tensions

Ivan Kalaš¹, Iveta Kohanová²,
Piers Saunders³, Alison Clark-Wilson³, and Eirini Geraniou³

¹Comenius University in Bratislava, Slovakia

²Norwegian University of Science and Technology, Trondheim, Norway

³University College London, UK

This paper records the Plenary Panel discussion held at the third conference on Mathematics Education in the Digital Era, which was held from 7-9th September 2022 in Nitra, Slovakia. The panel discussion, which was chaired by Eirini Geraniou, invited the three panelists (Ivan Kalaš, Iveta Kohanová and Piers Saunders) to give perspectives on Computational Thinking (CT) in relation to mathematics education from three different country perspectives (Slovakia, Norway and England). The discussion addresses important differences between computational thinking and mathematical thinking, the challenges associated with the design and assessment of curricular, and the implications for teachers and their ongoing professional learning. It concludes with a reaction by Alison Clark-Wilson, who highlights the importance of epistemologically grounded design principles for new curricular, the related technologies, tasks and assessments.

Keywords: Computational thinking, computer science, computing education, algorithmics, informatics.

Introduction

Over the last 10 years or so, Computational Thinking (CT) has become increasingly evident in both mathematics education research and mathematics teaching practice. This is due to new curricula that emphasise CT as an important 21st century skill for learners. Also, the literature is characterising CT as an essential competency for a digital society (Inprasitha, 2021) or the “new digital age competency” (e.g., Grover & Pea, 2013). However, education in relation to CT is implemented differently across Europe. In some countries, it is a compulsory subject, for example, informatics, computing, or computer science. In other countries it has become part of the mathematics curriculum, or integrated within a combined set of curriculum subjects within a broader STEM or STEAM curriculum. However, although there is growing literature on CT in mathematics education or other disciplines, there exist many different perceptions and expectations of the potential of CT for mathematics education, within and beyond mathematics education researchers, teacher educators and teachers.

This paper reports the panel discussion in which Ivan (Slovakia), Iveta (Norway) and Piers (UK) offer their views on CT within the context of mathematics education. They draw on examples from their respective countries. The panel, which was chaired by Eirini, was framed by three questions, each of which was directed to one panelist first, followed by a short response from the remaining two panelists. This was then followed by Alison’s reaction.

Panel Question 1: Without attempting to define either computational thinking (CT) and/or mathematical thinking (MT), what differences, if any, do you see between them? If yes, can you characterise one such difference?

Response 1 by Ivan

Let me start by pointing out that mathematics education has always been, and continues to be a great inspiration for me in my work to develop educational content for informatics. This is not only through its long tradition of looking for appropriate content and pedagogy, but also by its complexity and sophisticated progression, from year to year, and from school phase to school phase. The field of Informatics education has a lot to learn from mathematics education. In informatics education, we are still busy clarifying content and only just beginning to explore the cognitive demands and appropriateness of particular concepts; learn to distinguish digital literacy from computer literacy; and so on. What has become established, is an understanding of the relationships between computational thinking and programming.

If we carefully consider mathematical thinking, computational thinking and programming, we very soon find a common concept in the background, namely the algorithm. This is present in informatics itself, and equally when we examine the role that CT plays in the development of MT. Nevertheless, I believe that there are significant differences in the two educational perspectives on both algorithms and when solving problems.

As I do not dare, nor attempt, to define either CT or MT, I will try to present my perceptions of the big goals for informatics and programming as we design and implement educational content in the school context. I do this through an example from the lower primary curriculum for pupils in Years 3 and 4 (8-10 years old).

In Slovakia, informatics has been a separate compulsory subject for lower secondary students since 2004, and for primary age students since 2012, which is 10 years now. The curriculum begins in Year 3 and continues in every subsequent year (with one exception) until the end of K12 education. However, although the formal curriculum begins in Year 3, many schools introduce informatics even earlier. In our design research group, we have developed non-mandatory informatics educational content for kindergarten (5-year-olds). An example of one of our pre-programming environments Emil (named after the featured character that provides the familiar narrative for the children) is shown in Figure 1.



Fig. 1: Introductory activities for kindergarten children, designed for a group of 4 to 6 pupils, to work collaboratively in front of the IWB.

In this example, a group of 4 to 6 children would work collaboratively within this environment in front of the IWB. Presented with a sequence of situations, they work to solve a problem on a map with coloured paths, guiding the character “Emil” in his small truck by entering the colour of the path he should follow. In this example, the children work to instruct the path Emil should take to collect the lost animals (a little goose, puppy and calf) and return them to their families.

At the same time, a symbolic record of the steps is created on the top line of the IWB screen. In our task designs, even at this age, we always follow a gradual cognitive transition from directly controlling an actor and creating a record of our steps, to planning the steps while using the same symbols to express these steps. We call this process step planning, and its representation in a particular language programming. Intentionally and specifically, I emphasise the notions of (1) creating a record of steps, (2) planning steps to solve a problem, and (3) a language in which we represent both the record and the plan (the programme).

Indeed, programming plays a key role in both our educational content development and our related research on programming concepts, which concern the cognitive demands for pupils at different years and stages. We view programming very broadly, by considering it in a sense as the language of informatics, as a means and a tool of computational thinking, in all its components. To be more specific, these components are usually recognised to be abstraction, algorithmic thinking, decomposition, generalisation, and evaluation. Consequently programming is broadly understood not as a goal but as a tool – in this way it has the potential to play an important role in supporting pupils to develop each of these components, whilst providing them with opportunities to explore, model, express, and collaborate etc.

Blackwell says that pupils start programming when they stop directly manipulating observable things but specify behaviour to occur at some future time (Blackwell, 2002). And why is this so challenging?

Because, instead of reaping the benefits of direct manipulation, we introduce notational elements to represent behaviour, abstraction, and change. In doing so, we run into various constraints. These relate to the language used, the representation of the program, and in the behaviour of the character we are controlling, in the context of the actual problem, let me illustrate this with a second example, that introduces Emil and Ema, the virtual and floor programmable robots we use in Slovak and Czech primary schools.



Fig. 2: An example that develops the notion of the programme as a set of instructions to be enacted in the future.

In Figure 2, we see: Emil's scene (or world); a group of commands and tools (right) for controlling his movements and applying his tools to the scene cells; and a blue panel (top) for building the program. When the pupils have finished planning, they wake Emil up to run their program.

As the content is so extensive, I am not able to give a complete picture. Instead, I highlight some of our specific design principles and some important milestones when moving from direct control to programming. First, in our pedagogy, primary pupils never work 'one-to-one' with computers, but always in pairs. When they work with robotics (i.e. with Ema), they are in even larger groups. When working with Emil, two pupils have one shared tablet or laptop and two workbooks in front of them. Together they discuss and solve sequences of problems that are ordered by increasing cognitive demands. Second, what is unique about our approach – at least when compared to many schools in our countries – is that there is no space for any traditional teaching in our classes, by which I mean 'lecturing'. The teacher never reveals a new concept or procedure. The sequence of tasks is designed so that the pupils explore and discover everything for themselves, through collaboration and constant discussions, which are guided by the teacher with proper questions. Pairs of pupils share, explain, compare, and justify their strategies and solutions to each other. In that way they construct deep and durable understanding. Finally, the third design principle I want to mention is the fact that our programming environments of Emil for Years 3 and 4 do not give any feedback. It is the pupils themselves who have to consider and assess their progress – first in their pairs, but also many times a lesson as a whole group.

Concerning the progression in the content, let me jump straight to an activity involving Emil in the middle of the progression for Year 3. By this stage, pupils are already familiar with the fact that when a problem begins with Emil asleep, this signals that they have to program the solution first, and only then wake Emil as they are ready to run (or execute) their program.

In earlier activities, pupils have already encountered a significant restriction in the form of the length of the blue panel, i.e. the number of steps of their solution is restricted by the number of positions on the blue panel. In Figure 3, for example, we see a pupils' solution to one of the problems. It is this restriction that makes some tasks unsolvable (while others have multiple solutions), others are open-ended or even 'unclear' in the sense that pupils are invited to formulate their own additional rules. These constraints are all the subject of extensive whole class discussion.

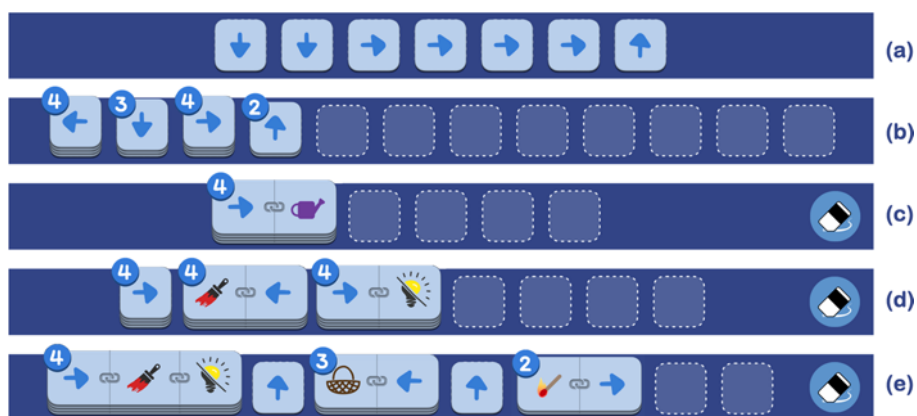

Fig. 3: Different panel designs to show the program provide opportunities to think about its structure and properties.

The blue panel can have a maximum of 12 positions, but for most tasks this number is often lower. For example, in the case of the task relating to Figure 3 (a), up to seven steps can be planned. However, in subsequent problems in the progression, pupils discover new panel behaviour: If they enter the same command multiple times in a row, the icons in the panel automatically stack up, see the solution in panel (b). Even though this program consists of 13 commands, it takes only four positions on the panel. We increasingly transfer pupils' attention to the panel. They consider and discuss various properties of their program, such as its structure. Thus, they discover that two consecutive commands can be connected into a double command. If they create identical double commands in the program in a row, these also automatically stack up, see panels with programs (c) and (d). Three cards can be merged into one as well. So, the fifth program (e) consists of up to 24 commands, but we have created it in panel (e) with only 11 positions, taking just nine of them. Thus, we promote pupils' understanding of the elements of repetition in the program.

In Emil for year 3 we control the character in a so-called absolute frame, that is, with the arrows up, right, down, and left. In Emil for Year 4, we move further in the sense that we control the character in a so-called relative frame, that is, with the commands step forward and turn right 90° or left 90°. Within the activity sequences we gradually add more and more language commands, see Figure 4, so that pupils can always focus on discovering new possibilities and their properties. We start with a simple pair of commands: step forward and stamp the green star (and later add a step forward with

drawing a line). Gradually, pupils will discover how they can choose the colour of the pencil and stamp, and the thickness of the crayon or the size of the stamp. They will also begin filling the enclosed area with a selected colour that they have previously outlined. They will also discover how to use the pin command to draw diagonal lines in a regular square grid, where Emil moves only on horizontal and vertical grid lines.



Fig. 4: In Emil 4, we pupils start with only two simple commands

In addition to a vocabulary of nine basic commands, Emil 4 also provides three compound commands P1, P2 and P3. First, these are defined in the tasks by the authors. Pupils explore them and use them together with other basic commands as shortcuts for groups of commands that logically belong together (in the sense of new blocks in Scratch or user-defined functions in Python). Later on, pupils start to modify and correct provided definitions. Only then do they begin to create and use their own compound commands. We consider this as an important development in the level of pupils' abstraction in their computational thinking.

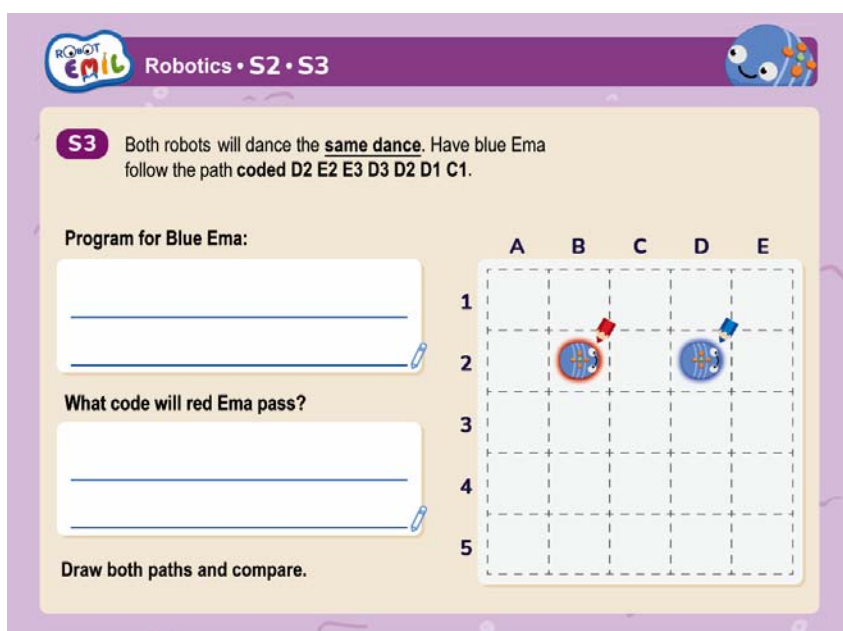

Fig. 5: In Robotics with Ema we focus on multiple representations of different things. In this case we are using a special and yet intuitively simple representation of the path

Before I try to summarise why and how these short vignettes illustrate what I consider to be special about computational thinking when viewed from an informatics perspective, I want to mention another part of our educational content in primary informatics. These activities are implemented by schools within five lessons in each primary year 1 to 4. This is a specific comprehensive progression of activities in which pupils work on the floor in groups of three to four with special mats and Blue-Bots, who we have named as a female robot, Ema. One of the main goals of this progression of activities is to introduce multiple representations. These include how we identify the different squares

on the mat, how we represent Ema's position and direction, how we represent the program; how we control Ema, how we represent the corresponding path on the mat, what shape that path is, etc. In Figure 5, we see an activity from Year 4 where we work with a mat based on a 5 x 5 array. We label its squares in a familiar way, e.g., B2, C2, D4... We name Ema's position and direction, e.g., by saying, Ema is standing on B2 facing away from A2. When Ema executes her program from the start and with the initial direction, she walks a certain path on the table mat: the program corresponds to the path on the mat and the path's shape. And can also be expressed by the sequence of the labels of the squares she walked on. In the activity in Figure 5, we see that blue Ema has to take a path with the 'code' D2 E2 E3... What will be the code of the red Ema's path if both robots execute the same program?

So in conclusion, where do I see differences between MT and CT? This is a hard question, which I have tried to answer in an indirect way by showing what we do within the context of primary school informatics. We solve contextual problems by controlling a character or several characters. We emphasise how they can be controlled and how we can represent that process. We explore how the characters behave, how they react to different events and situations, what their options are and what their constraints are. These interest us not only in the characters' behaviour, but also at the level of data, in several different senses. In accordance with Papert, we try to get pupils to think about the program itself, to consider it as an expression of their idea, to explore different properties of the program, such as its length etc. Pupils compare different representations of a procedure for solving a problem, exploring the language used to represent it. They compare different solutions and explore whether they would be able to express the solution if certain constraints were added, if they had other means and structures to engage etc. We want pupils to encounter different powerful ideas of computing in this way. In computing. And in mathematics as well.

Response 2 by Iveta

I will provide some examples from a survey we conducted in the spring of 2022 of around 350 Norwegian mathematics teachers (Turgut et al., 2022). The survey was framed by the Pedagogical Technology Knowledge framework (Thomas & Palmer, 2014), with a focus on the implementation and use of tools for computational thinking and programming (CTaP tools) in mathematics teaching.

One of the open questions was related to the teachers' perceptions of the effectiveness of these tools for the purpose of supporting their students to have an improved understanding of mathematics. The analysis of the responses revealed teachers' views that imply some differences between computational and mathematical thinking.

- Teacher 1: CTaP tools provide immediate feedback. You get the results quickly, no need to wait for the teacher and you see whether your solution is correct or not correct. So you are naturally motivated to look for an error which is not happening in mathematics. Thus, students learn from their own mistakes.
- Teacher 2: I think the students get a feeling when using these tools that mathematics should be used to arrive at a solution or to create something. Therefore, they must understand that mathematics is a tool to get the desired result. [and] In a traditional problem in mathematics textbook, I don't think they get the same understanding ... that we use mathematics in order to create something.

Teacher 3: It's a borderland between theoretical and practical mathematics because it embraces both worlds in a good way and this can lead to flourishing in other students than those who did well in classical mathematics.

Teacher 1's response indicates that evaluation and debugging are one of the differences between CT and MT. The teacher's example is closely related to programming. Also, the teacher refers to trial and error which is a common heuristic in programming but for many students seen as somewhat invalid in traditional mathematics. In addition, students might be motivated by having less fear of making errors.

The CTaP tools, according to Teacher 2, help students see the usefulness of mathematics. This can be connected to problem solving or entrepreneurial activities. In mathematical thinking it is harder for students to see how their answers and solved problems can be useful for real life purposes.

Teacher 3 sees opportunities for underachieving or underperforming students, as well as for students with a lack of motivation in mathematics. The practical nature of programming found in, for example, debugging and the creation of algorithms, could appeal to many of the students who previously lost interest in mathematics.

In winter 2021, we asked Norwegian in-service mathematics teachers participating in a professional development course, to draw mind maps and compare components of mathematical and computational thinking. The analysis of their mind maps revealed that generalisation, abstraction, analysis and problem solving were the components that were typical for both MT and CT. Components which appeared only in the MT part were reasoning and proof and communication. On the other hand, components present only in the CT part were expressed by verbs related (mainly) to programming, like debug, structure, document, sort, declare, and decompose. But also, to google, to try and to cry. This indicates that Norwegian mathematics teachers perceive/interpret CT as programming and/or coding, which is one of the findings of Nordby and her colleagues (2022) as well. The verbs "trying" and "crying" might express teachers' uncertainty and confusion, which signal a need for professional development courses related to CT. We have noticed a similar issue in the survey answers (Turgut et al., 2022), which resonate with findings from the studies by Kveseth (2022) and Grimsgaard (2022).

Response 3 by Piers

With respect to differences and similarities, my thinking is very much inspired by Cuoco's (1996) "Mathematical habits of mind" which I wrote about and discussed in some depth in my recently completed doctoral thesis (Saunders, 2022). I really feel those habits of mind have strong similarities with how computational thinking has been defined within the literature. For example, if you're not familiar with these, Cuoco describes a series of statements such as "students should be pattern sniffers" or "students should be tinkerers". I think we can see very, very strong links with aspects that Ivan talked about within his presentation for the types of activities that we want students to be doing as they engage with computational thinking, whilst also being the types of activities that we want students to do as they develop mathematical thinking.

Panel Question 2: Do the new curricula look different within the primary, secondary and tertiary school phases? For example, are the digital tools used in each phase the same or different? Are there any particular implications for assessing learners' outcomes?

Response 1 by Iveta

In Norway we have a new national curriculum since August 2020 in which CT and programming are introduced in the following subjects: mathematics, science, arts and crafts, and in music. Computational thinking is in Norwegian translated as “algoritmsk tenkning” (algorithmic thinking) and thus it inevitably leads to misunderstandings and misconceptions, as the term *algorithm* has associations with standard algorithms (Gjøvik & Torkildsen, 2019; Nordby et al., 2022).

CT is mentioned in the mathematics curriculum for Grades 1-13¹ only once, under core element *Exploration and problem solving*.

“CT is important in the process of developing strategies and approaches to solve problems and means breaking a problem down into sub problems that can be solved systematically. This also includes evaluating whether the subproblems can be solved best with or without digital tools.”

(Directorate of Education, 2019a, p.2)

On the other hand, the curriculum uses the term *programming* often. The general idea is that students learn different terms and concepts related to programming in mathematics, which they they apply within mathematics, science, arts and crafts and in music (Sevik & Guttormsgaard, 2019). For example, one of the competency goals in the music curriculum for Grade 10 says: “Create and program musical sequences by experimenting with sounds from different sources” (Directorate of Education, 2019c, p. 8).

Coming back to mathematics, there is one competency goal (of the 10-15) related to programming in the mathematics curriculum for each grade (starting from year 2). Some of them are very general, neither specifying the programming language and (digital) tools to use, nor the mathematical topic. For example, a competency goal within Grade 5 states, “*create and programme algorithms with the use of variables, conditions and loops*” (Directorate of Education, 2019a, p. 9). In Grades 3, 6, 7 and 9 only the mathematical topics are specified:

- create and follow rules and step-by-step instructions in play and games related to the coordinate system
- use variables, loops, conditions and functions in programming to explore geometric figures and patterns,
- use programming to explore data in tables and datasets,

¹ In Norway, children start Grade 1 the year they turn six years old.

- simulate outcomes in random events and calculate the probability that something will occur by using programming.

(Directorate of Education, 2019a)

Similar to the curriculum, some textbooks do not specify the programming language. However, from the text (Figure 6), although not explicitly stated, it can be inferred that the languages used are Scratch or Python. From the aforementioned teachers' survey responses (Turgut et al., 2022) we also know that CTaP tools like MakeCode with the Micro:bit are often used in Norwegian schools, as well as Scratch, Python, GeoGebra or spreadsheets in Grades 6-10. In Grades 2-5 we found that Bee-bot, Scratch, Robot Emil or various online environments are used regularly.

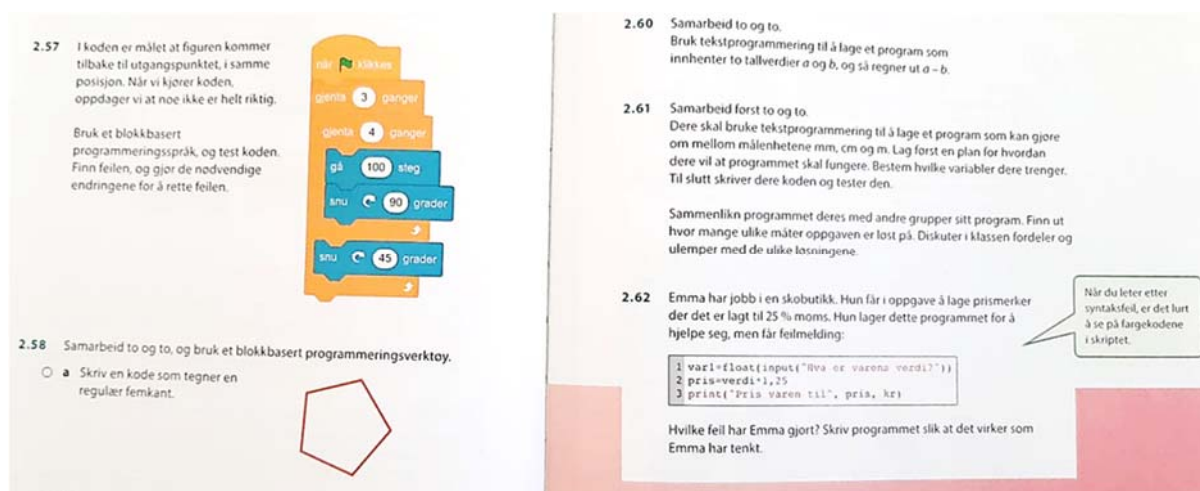

Figure 6. Programming in a year 8 mathematics textbook (Tofteberg et al., 2020, p. 136-137)

In upper secondary school, which in Norway it means Grades 11-13, mathematics is compulsory only in year 11 and students can choose between practical (P) and theoretical (T) mathematics. Only students who choose theoretical mathematics will further develop their competence related to CT and programming, as the curriculum states:

“formulate and solve problems through the use of computational thinking, different problem solving strategies, different digital tools and programming.”

(Directorate of Education, 2019b, p. 5)

Any application related to a mathematical topic is specified only in Grade 13, “*develop algorithms to calculate integrals numerically, and use programming to execute the algorithms*” (Directorate of Education, 2020, p. 6).

As we can see from the above, in mathematics students learn programming as well as the application and use of programming. CT seems to be under-communicated in the curriculum and there is also some confusion regarding what it is, and its place in mathematics.

Moving to the implications for assessing learners' outcomes with respect to CT, it is important to mention that pupils in Norway are not given grades or marks during the first seven school years. Instead, at the end of each term, students are assessed summatively (against competency standards), together with a guidance on how s/he can increase his/her competence. From Grade 8 onwards,

students are given grades and must also have a written half-year assessment with a grade. Assessment practices have traditionally been weak, with teachers focusing on effort rather than the quality of students' competence and curriculum mastery (Hopfenbeck et al., 2012). Since 2007, national mapping tests in reading and numeracy have been implemented to help primary school teachers identify the weakest 20% of students (Nortvedt et al., 2016). In addition, during Grades 5, 8 and 9 the schools are given knowledge about their pupils' basic skills in computing/calculating from national testing. To date, none of the tasks in these national tests relate to CT or programming, which seems fair since these ideas have only been part of the national curriculum since autumn 2020, and teachers need some time to adjust their teaching accordingly. However, there is little recent research on Norwegian primary school mathematics teachers' classroom assessment practices (Nortvedt et al., 2016). I hypothesise the same would be true for secondary school teachers. Again, the new curriculum has only been effective for about two years (at the time of writing) so the research gap becomes even bigger in relation to the assessment practices within CT and/or programming. It will also be interesting to study how mathematics teachers' understanding of CT affects their assessment practices in mathematics.

My final point concerns the national exams (high-stakes tests) in mathematics. In the *example set*² for the Grade 10 exam for 2022, there was one task in which students were asked to explain an algorithm (displayed as a flowchart shown in Figure 7) and give examples for numerical values for which a certain equality holds. The context of the task was mathematical. The purpose of the algorithm was to determine whether the input of a triplet of triangle side lengths (a , b , c) satisfy the Pythagorean theorem (inferring that the sides represent a right-angled triangle).

A second open task was also included in the example set (Figure 8).

² An example set is a complete exam distributed to teachers but only for training and information purposes.

The figure shows an algorithm that can be programmed.

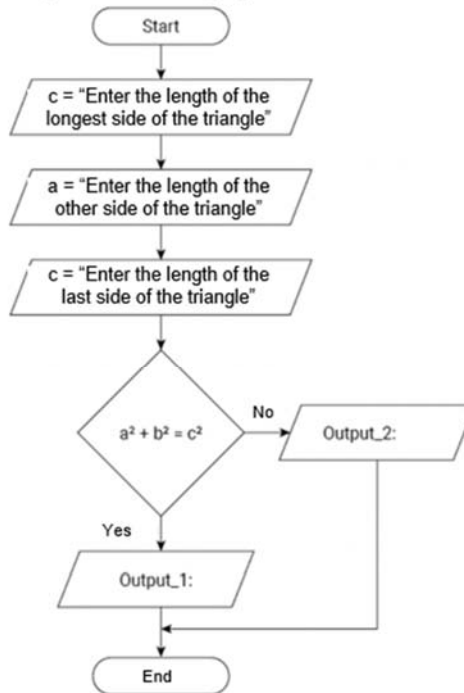

Explain what is the algorithm investigating.
Give examples of numerical values a, b and c that give Output_1.

Figure 7: Flowchart from Grade 10 example set (Directorate of Education, 2022a)

Task 10

Anne is 15 years old and wants to get a driving license for a moped. She will buy a moped when she turns 16. She plans to sell it when she turns 18.

Moped driver's license fee:

Theory test fee	660,-
Driver's license issuance fee	310,-
Invoice fee	65,-

take moped driver's licence:

Basic moped course - 3 hours	1000,-
Step assessment step 2	700,-
Traffic safety course - 4 hours	2040,-
Step assessment step 3	700,-
Road safety course - 4 hours	2040,-

Total price: All compulsory training + 3 hours of driving: kr. 8800,-

Peugeot Speedfight 4 Pure
Price 16 000 kr

Legg til favoritt

One liter of petrol costs ca. 15 kr.

Moped spends ca. 1/3 l of petrol per mile.

Anne lives 2 km from the school and from a football field.

Anne has little experience with mopeds, so she probably needs more driving hours.

The value loss for a new moped is 25-30 % in the first year, 20 % the second year and then 10 % per year.

Insurance for moped costs 125 kr per month.

Use the information above to demonstrate your competency in modeling and application

Figure 8: Open task from Grade 10 example set (Directorate of Education, 2022a)

The accompanying task guidance stated:

In this assignment, you are expected to:

- ask relevant mathematical questions that demonstrate your competence
- show calculations and answer your questions
- make critical assessments based on the questions and your calculations

In the solutions to their own questions, students are expected to demonstrate their competence in *modeling and applications*, another of the core elements of the new curriculum in Norway. In the suggested solution provided by the Norwegian Directorate for Education (2022b), the expected solution is to use a spreadsheet. It can be argued that the creation of such a spreadsheet also can be considered as being within the scope of CT.

The flowchart task was presented without the specification of any programming language. This might happen in later examination designs, but for now it seems that the choice of language, or even whether to choose unplugged, block-based or textual programming, is the responsibility of the teachers and the schools. The flowchart task might seem fairly easy, but this should be seen as a first step into programming in mathematics in Norwegian schools. The open task (Figure 8) demonstrates another new, very open, type of task. This task is representative of some of the new content and new core elements in the curriculum. These new types of tasks will push teachers into making several adjustments to their teaching, and potentially face several challenges. For example, how should they teach the new topics? They also have to consider new types of assessment practices connected to the new task types so that students taking the exams will get fair assessments in these new experiences.

Response 2 by Piers

One key point which continues to perplex me is that when we are thinking about the vehicle of programming for learning mathematics, we also need to address the assessment practices of that learning. For example, Iveta talked about programming through the different curricula without focusing on the specific language such as Scratch or Python itself. She also highlighted in her examples that when we assess programming in the high stakes (end of phase) examinations, the method is through pencil and paper tasks. But surely, the role of programmers is to actually program with a computer! If we consider the role of digital tools in mathematics in the UK, the current assessment structures continue to be pencil and paper based with *some* access to a calculator, although there is a non-calculator examination paper! And so I pose the important question, “How do we bring about system change in the high stakes assessment practices so that digital tools (beyond calculators) are at first recognised and then permitted? ”

Response 3 by Ivan

Again, I will use school mathematics as a parallel. A curriculum for developing computational thinking and programming needs to be complex and comprehensive for the whole of education, across all stages of school, with clear goals, vision and direction. However, it must systematically progress from year to year, respecting developmental appropriateness, interests of the pupils and the level of their abstract thinking. Motivating them

appropriately, building on what we have learned earlier. Otherwise, we would get stuck in a loop, accepting vague learning goals and starting all over again in each stage.

In this process, primary school plays a special role. Primary teachers teach most of the subjects to their pupils, so we must not expect them to be specialists in informatics and programming. But this is not a limitation. On the contrary, it is an amazing advantage! Primary teachers have big experience in how to bridge learning between subjects and various learning areas. We need to build the curriculum in informatics and programming to respect and utilise this primary learning ecology.

Panel Question 3: What are the implications of such curricula developments for teacher preparation and support? Are there any local, regional or national initiatives to address teachers' professional learning needs?

Response 1 by Piers

Both Ivan and I worked on the ScratchMaths project which positioned building mathematical knowledge through learning to computer program. In the UK a new compulsory computing curriculum was introduced in 2014, for all phases of education, from children as young as 5 years old up to 16 years of age. Ivan has stated that we need to respect primary teachers, and so when the computing curriculum was introduced, we were very aware that primary school teachers would not be prepared for teaching such a curriculum. We therefore had an opportunity to design a new curriculum for both the teachers *and* the children, and set an overarching goal to develop problem solving and reasoning in mathematics through programming in Scratch. The success of our project was evidenced by an independent evaluation, which measured the children's mathematics scores on a national test at the end of the primary phase aged 11 years old. The project was a large national project aimed at children who were aged 10 and 11 years old, i.e. the final two years of the primary phase in England. Our design needed to reflect the UK context, in particular the background of children, and the technology that they had available to them at school. Importantly, this was not an initiative for children who had previously experienced programming, and likewise the teachers. The children and the teachers were learning and starting from *Scratch* as they engaged with our carefully sequenced two year ScratchMaths curriculum (Figure 9).

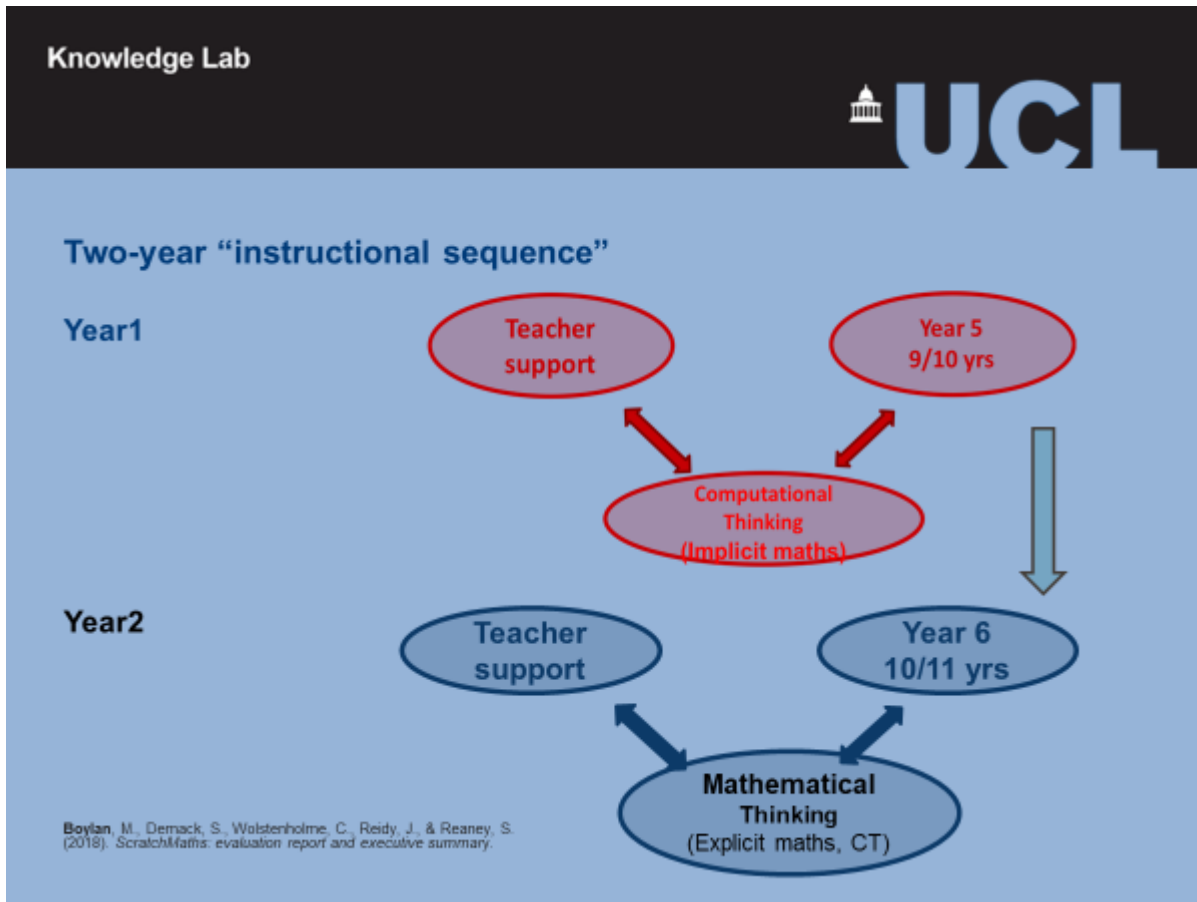

Figure 9: The ScratchMaths instructional sequence across the two years of the curriculum (Boylan et al, 2018).

In year one we provided teacher professional development, through in-person training accompanied by detailed curriculum materials (freely available at <http://www.ucl.ac.uk/scratchmaths>): pupil tasks, teacher guides, posters and Scratch starter projects. The focus of the ScratchMaths curriculum for children aged 9 was on developing computational thinking or aspects of computational thinking where the mathematical concepts were *implicit*. For example, in the first module, ideas of movement, rotation and pattern are explored by controlling the *sprite*³ with programming commands and structures. Students engage with the coordinate system within Scratch as they notice the numbers changing as they move the sprite forwards and backwards. Thus, in the first year of the curriculum the children (and teachers) build a foundation of programming skills. In the second year of the curriculum, we provided additional professional development for the teachers. The children were now a year older, the teachers had experienced teaching Scratch and ScratchMaths for a year and they were now able to develop mathematical thinking and mathematical reasoning where the maths is very, very explicit.

The ScratchMaths final report was published in 2018 by an independent evaluator who found that there was a positive and significant effect on computational thinking skills in Year 5 (Boylan et al,

³ the programmable object in Scratch

2018). For us this was really important since the teachers had received appropriate professional development, taught the curriculum materials as planned, and had the same experiences as the children. However, in the second year of the curriculum when the children were a year older, not all teachers moved forward with the children. Consequently, we were not surprised that the mathematics outcomes at the end of the second year (as measured by the national test) were not significantly affected for those that had studied ScratchMaths. Teachers not following their class as the children progress to the final year in the UK primary system is quite common as schools often timetable mathematics classes with a specialist mathematics teacher to teach and support children towards the national examination. We therefore had a context where the teachers were teaching the second year of a curriculum, having not had any experience of the foundational aspects of the first year. Ivan often uses the analogy of trying to learn (and teach) a foreign language when you have only been given the year 2 textbook. So with respect to implementing a new curriculum successfully, it is essential to understand the teachers' context and how they progress from year to year.

However, during the project we worked directly with teachers in London who acted as design partners. This enabled us to learn that providing only curriculum materials was not enough for a successful implementation. We also needed to support teachers with how to teach programming which needed a different pedagogy. Consequently, we developed a pedagogical framework which you may have heard us talk about before, called the 5E Pedagogical framework (Noss et al, 2020). The framework was embedded throughout the curriculum materials to support the teaching of computational thinking and programming ideas, and to explore teaching mathematics through programming. Explain, Explore, Envisage, and Exchange are fairly well articulated pedagogical approaches, but our final E is the notion of bridgE, ie. bridging from programming in Scratch to mathematics and vice versa. We also recognised the need to support teachers with the pedagogical approach through teacher professional development. We experienced what can happen if the teachers are not supported. Professional development was essential, but we also recognised that addressing a year's curriculum in two days of CPD, whilst also providing opportunities to engage with the second year of the 2 curriculum, was insurmountable.

My doctoral research focused on the teachers within the ScratchMaths project, and their developing mathematical knowledge as they learn to program. The complexity of identifying that knowledge is presented in Figure 10, an adaptation of Thomas and Palmer's (2014) Pedagogical Technological Knowledge for teaching mathematics (PTK).

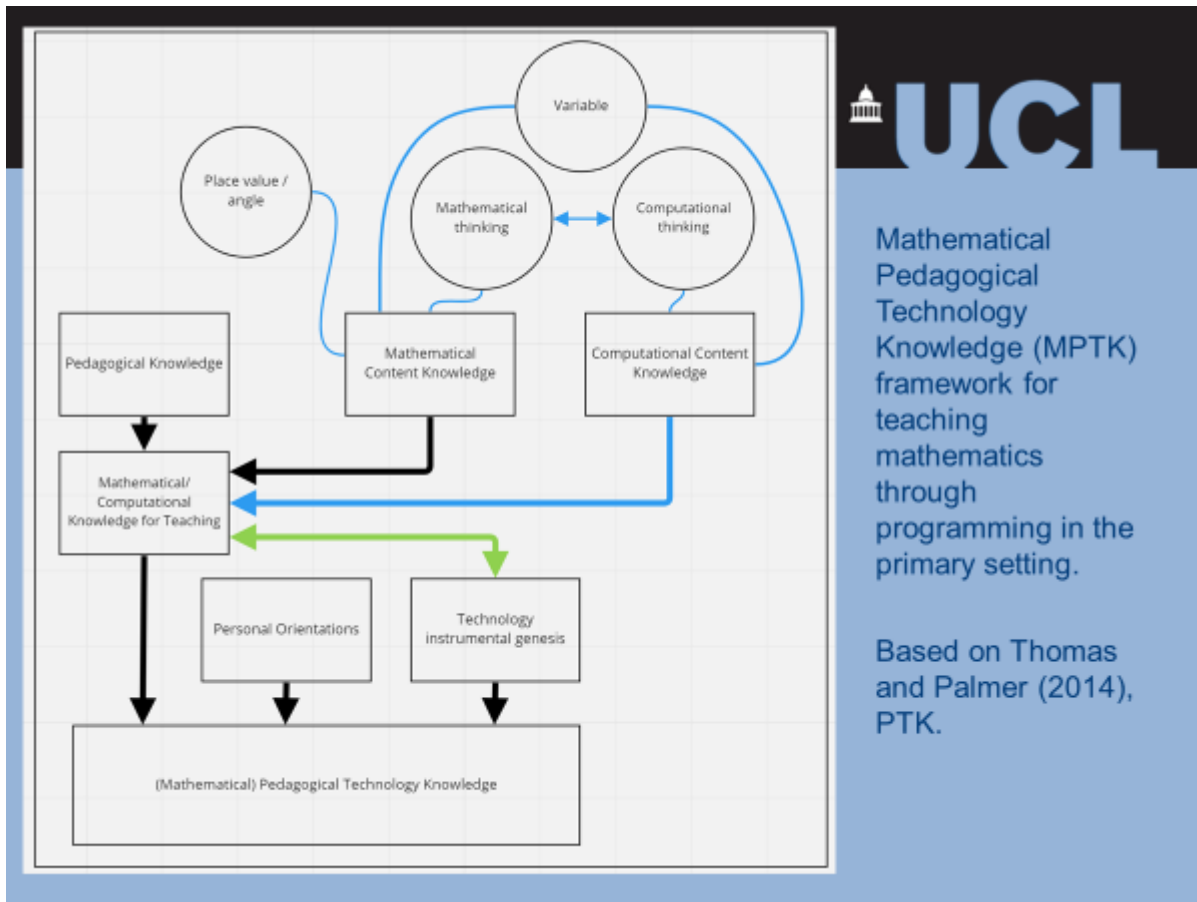

Figure 10: Elaboration of Thomas & Palmer’s MPTK Framework (Saunders, 2021)

I add a box to denote Computational Content Knowledge, which feeds into the mathematical computational knowledge for teaching. I have added the mathematical ideas (in circles) which were the focus of both ScratchMaths and the specific focus of my doctoral research. For example, a variable has a very specific use in mathematics and also a very specific use in computing, but there are also overlaps, which were difficult for the teachers to articulate. This was challenging since the teachers felt they had a good understanding of algebraic thinking and that the concept of variable in computing would be the same. To illustrate this complexity, I use the example in Figure 11.

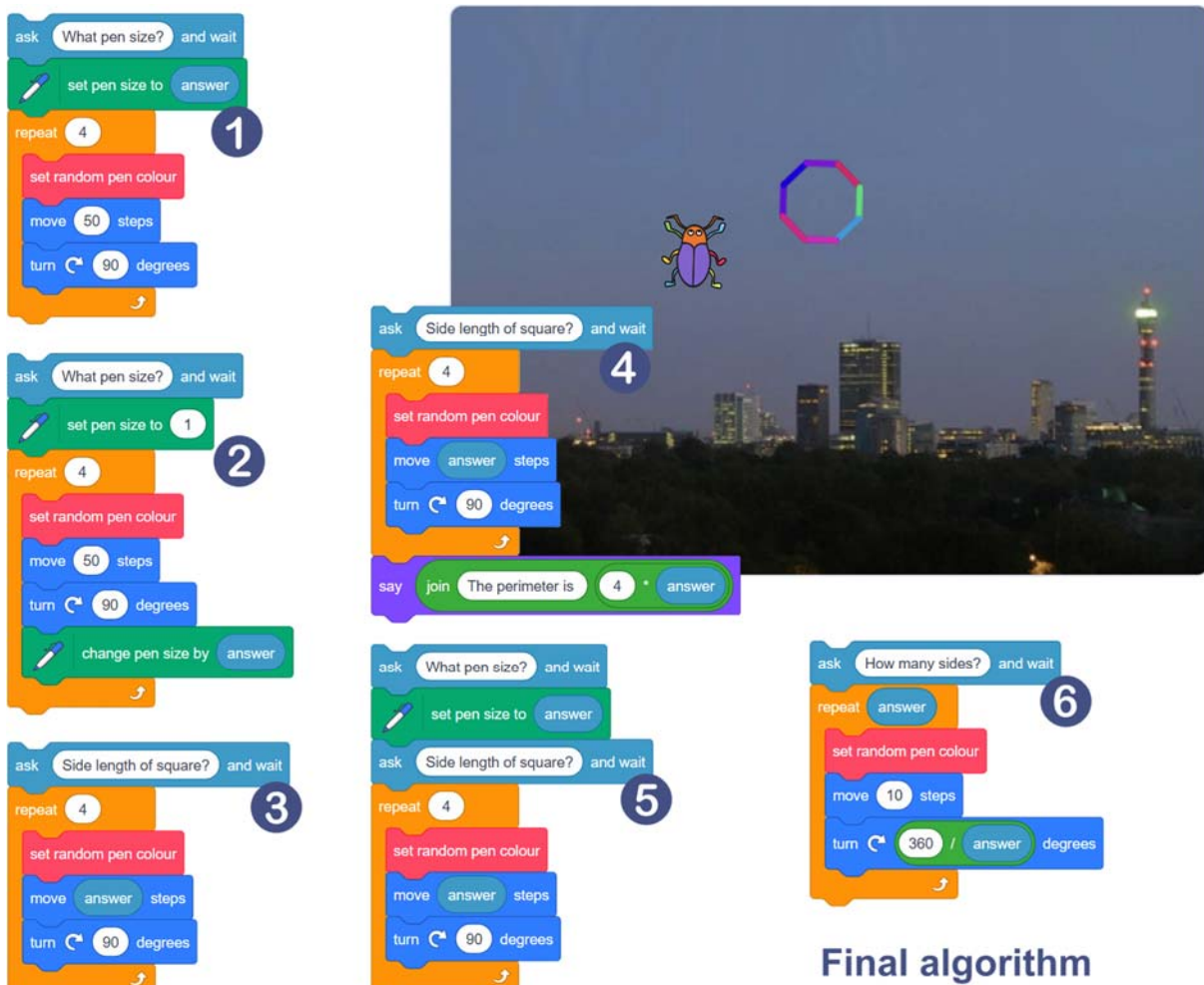

Figure 11: The ScratchMaths Firework task

On the right hand side of Figure 11 is a beautiful Scratch algorithm (Step 6). The algorithm **asks** how many sides, then stores the value in the **answer** block, and a regular Polygon will be drawn. The representation in programming exposes the mathematical structure, for example the relationship between 360 degrees and the number of sides. However, we respected the teachers' starting position so when we designed the guidance for this task, we supported a step by step approach, rather than just providing the final algorithm which brings together computational and mathematical ideas. To illustrate the approach we started with a simple algorithm to draw a square (see step 1 of Figure 11) which uses the **answer** block to store a variable and then use that **variable** to set the **pen size**. Step one therefore presents an **ask** and **answer** block consecutively, a relatively simplistic use of a variable in computing.

We then move to step 2, which uses the same **pen size** again, but now the **pen size** block is moving further from the repeat block. This incremental approach proceeds through Steps 3-5 until we arrive at the final algorithm, which is Step 6 on the right. This approach supported both teachers and their children to develop their programming skills and use those skills to explore mathematical ideas, in this example, the idea of a variable and the concept of external angle.

Moving to consider how local, regional or national initiatives are supporting teachers' professional learning needs in England, the context is set within the new national computing curriculum. It is a separate subject that has to be taught in all state-funded primary school by teachers who have trained as generalists, that is they teach every subject. This provided an opportunity to draw on the experiences of our team, who had worked with Logo and mathematics for nearly 30 years, and reconnect mathematics with computer programming, i.e., to exploit the synergy between the two. We recognised quickly that in order to work at a work at a national level, we needed to have regional support. Hence, we worked with, or created regional hubs where particular local agencies had a good knowledge of the schools, their context, and the types of technical infrastructure in the school.

My final point is perhaps obvious in that continued professional development is essential to sustain any new curricula, but it is so frequently overlooked. As I have discussed this is not just about the curriculum itself, but also about the specific pedagogy that is required to teach such a curriculum. Within our project, we had embedded professional development (PD) opportunities each year, but found very quickly that due to the high turnover of staff in schools, even this PD was not sufficient to support the teachers who had not taught the first year of the curriculum. This particular group of teachers required further support, which we had not envisaged at the start of the project.

Response 2 by Iveta

What we know from our survey responses (Turgut et al., 2022), is that the most common obstacle for Norwegian mathematics teachers to implementing CTaP tools in mathematics teaching is their lack of competency and access to training. This is not surprising since most mathematics teachers were not educated to teach CT and/or programming. As a solution, the municipalities in Norway are offering professional development courses, which in Trondheim, involves a cooperation with NTNU.

Regarding teacher preparation, we find ourselves in an interim period whereby our student teachers have not experienced or learned any programming during their own primary or secondary education, and so are struggling. Thus, we have had to offer an "on the spot" elective course, on programming. In addition, as teacher educators, we also try to implement programming in our regular teaching. So we discuss with the student teachers how this might be accomplished in probability, in statistics, in geometry, etc, following the curriculum competency goals related to programming. I have asked colleagues from other universities about their experiences. In Oslo, for example, the situation is the same. We are all trying to adjust our courses accordingly, and although we may still be a little bewildered, we do our best!

Response 2 by Ivan

In the ScratchMaths project Piers has just presented we worked closely with the in-service teachers. Such efforts are essential for successful transition. Iveta talked about how NTNU is trying to respond to the new situation as they support the preparation of their future teachers. This is also essential and crucial in the efforts of countries and institutions to bring about change, and I want to underline one thing. Unlike with mathematics, I believe, both in-service teachers and our university students, future teachers of informatics or mathematics, have most probably not experienced any programming during their primary and secondary school years at all. Almost certainly not in informatics classes and certainly not in mathematics. So if they come to our PD sessions, or if they are studying teacher

programs, they have to learn both the actual subject content and the skills that a teacher needs for teaching it.

Along the lines of developing their digital literacy, the use of digital technologies is similarly challenging. It is crucial that future teachers experience productive use of digital technologies in all courses – whenever appropriate, during their university studies at the latest. Not just in a special course focused on the use of digital technologies for teaching/learning.

Summary reaction by Alison

Thank you very much to the panel presenters, who have taken us on a complex journey through what is an immensely challenging topic. When we create the curriculum statements in national, regional and school documents, we assemble words on a page. We saw from Iveta's research that a critical starting point is how teachers come to understand the meaning of these words. All teachers arrive with their different backgrounds and experiences. Some may have experience in computational work and programming, others may not. Some may be strong mathematically, others may not. So, building shared understandings of the teacher's perspectives on these words is critical as we plan how we can support teachers to implement the related curricula.

A second important group is the designers of the educational resources being developed to teach computational ideas within/alongside the teaching of mathematics. Both Ivan and Piers spoke very strongly to this. It is critical to understand the epistemological goals for both the mathematical curriculum *and* the computing, programming or algorithmics curriculum, which are influenced by the choice or design of technology.

I was impressed by Ivan's introductory statement, which acknowledges the vast human global history of mathematics as an evolving discipline and a set of practices. It is a subject that is so established in our culture, and although we still struggle to understand many aspects of its teaching and learning, we have many years of human experience in terms of both mathematics and mathematics education.

Put alongside, computer education is relatively new to us. So, we rely on the computing experts to help us through. If we only had the expert mathematicians explaining and telling us how to approach the teaching of mathematics, we know that the mathematics educators would react – we have all heard of the “maths wars” that erupt around the world! Consequently, if the computing experts are working alone, there is the danger that the teaching of computing science in many countries will remain successful only for the minority of students who might elect to take such courses.

When we introduce aspects of computational thinking into a national curriculum, we have to really understand the curriculum goals at the highest level.

- Why do we think it's important that all children have some experience of learning ideas from computing?
- Why is it relevant for this learning to take place within mathematics?

Following on, what explicit design principles flow from these high-level goals? How do the educational content designers understand their design task(s), and its underlying rationale?

We heard from Ivan in this respect. He was very explicit about a design feature of the Emil technology for the kindergarten-aged children. It did not provide any feedback, an interesting point, which he justified in relation to the epistemological foundations of the design in Papert's constructionism. Conversely, within the Norwegian context, the technology was being selected due to its feedback function, interpreted by the notion of a computer programme "working" or not. These are contrasting approaches for the way that feedback is being considered in each context that underpin both the technology and task design decisions.

Piers and Ivan presented conceptions of pedagogical frameworks within the context of CT. This leads us to question, what do we mean by a pedagogical framework? and how might a well-defined pedagogical framework support designers to create resources that are going to be robust enough to keep the epistemic goals that underpin learning and teaching intact across a wide range of classroom contexts. This has a particular importance when the exciting (possibly high stakes) assessment processes may be misaligned with those epistemic goals.

Moving to assessment, which is a globally complex topic that is highly politically charged and, despite international rankings dominating the national and regional approaches, no one country in the world has developed approaches that embed formative, ipsative and summative assessment of CT. A starting point would be to research teachers' *in-the-classroom* strategies that help them to make sense of learners' progressions in their understanding of this new curriculum. Ivan's description of the way that primary teachers support learners in Slovakian classrooms implied a high level of teacher listening and whole class discussion.

In our ScratchMath project experience in England, it was really challenging for teachers who were new to the computing content **and** new to the 5Es pedagogical approach to try to understand how to best support their students. For example managing multiple screens in these environments can be really challenging. What screen is the teacher sharing? How is the teacher interacting with children as they are learning?

We have not had an in depth look at the nature of the assessment tasks that are being designed for CT, but Iveta's second example did imply one that was *product focused*. The students are expected to apply the ideas from computing to solve a problem of their own design. This is quite a different approach to the items posed in most current high stakes assessments around the world.

Finally, reflecting on the teachers' current perspectives, there does not appear to be a wide expertise in our teaching workforce, and even this panel, as the considered experts in the field, are challenged to design the teacher PD approach, the design of the curriculum and the design of the assessment. In England, the response during the ScratchMaths project's design year was to work alongside a smaller group of teachers to codesign the solutions to some of those challenges.

Looking to Norway, which is beginning with the implementation of a new curriculum, whilst the initial work is to co-design curriculum resources, we might also approach the design of assessment tasks in a similar way. By activating teachers in this way, with associated processes of peer-review to iterate and improve both task and associated assessment items, we offer a scalable approach to professional learning at a time when there is limited expertise to offer more traditional cascade PD models.

Overall, what we have heard from Ivan, Iveta and Piers about the development of CT in their respective countries is that, despite the fact that some of these curricula began to be implemented nearly ten years ago, we are still very, very early in the journey to establish computing education as a domain of knowledge and practice. We shouldn't be surprised by that, given that computational ideas are relatively new in the history of humanity. Our call to action is to continue to have dialogues such as this one, and to work together to understand and share different approaches that fit within the institutional and cultural settings of our different countries.

References

- Blackwell, A. (2002). What is Programming? Proc. of *14th Workshop of the Psychology of Programming Interest Group*, pp. 204–218.
- Boylan, M., Demack, S., Wolstenholme, C., Reidy, J., & Reaney-Wood, S. (2018). *ScratchMaths Evaluation report and executive summary*. [https://educationendowmentfoundation.org.uk/public/files/Projects/Evaluation_Reports/Scratch Maths.pdf](https://educationendowmentfoundation.org.uk/public/files/Projects/Evaluation_Reports/Scratch_Maths.pdf)
- Cansu, F. K., Cansu, S. K. (2019). An Overview of Computational Thinking. *International Journal of Computer Science Education in Schools*, 3(1), 17-30.
- Grover, S., & Pea, R. (2013). Computational thinking in K-12: a review of the state of the field. *Educational Researcher*, 42(1), 38–43.
- Directorate of Education (2019a). *Curriculum for Mathematics year 1–10*. <https://data.udir.no/kl06/v201906/laereplaner-1k20/MAT01-05.pdf?lang=eng>
- Directorate of Education (2019b). *Curriculum for Mathematics vgl theoretical. Mathematics T*. <https://data.udir.no/kl06/v201906/laereplaner-1k20/MAT09-01.pdf?lang=eng>
- Directorate of Education (2019c). *Curriculum for Music*. <https://data.udir.no/kl06/v201906/laereplaner-1k20/MUS01-02.pdf?lang=eng>
- Directorate of Education (2020). *Læreplan i matematikk for realfag (matematikk R)*. [Mathematics curriculum for science subjects (mathematics R)] <https://data.udir.no/kl06/v201906/laereplaner-1k20/MAT03-02.pdf?lang=nob>
- Directorate of Education (2022a). *Eksempeloppgave, MAT01-05 Matematikk, Del 2*. [Example set, MAT01-05 Mathematics, Part 2] <https://matematikk.net/matteprat/download/file.php?id=3965>
- Directorate of Education (2022b). *Forslag til vurderingskriterier, MAT01-05 Matematikk*. [Proposal for assessment criteria, MAT01-05 Mathematics] https://www.udir.no/contentassets/a97119d8db0f476eb6f7e9d4adb51e41/losningsforslag_samlet_v2022.pdf
- Gjøvik, Ø., & Torkildsen, H. A. (2019). Algoritmisk tenkning. [Computational thinking] *Tangenten–tidsskrift for matematikkundervisning*, 30(3), 31-37.
- Grimsgaard, H.L. (2022). *Læreres profesjonsfaglige digitale kompetanse i programmering og algoritmisk tenkning*. [Teachers' professional digital competence in programming and

- computational thinking]. [Master's thesis, Western Norway University of Applied Sciences]. HVL Open. <https://hvlopen.brage.unit.no/hvlopen-xmlui/handle/11250/3001030>
- Hopfenbeck, T. H., Throndsen, I. S., Lie, S., & Dale, E. L. (2012). Assessment with distinctly defined criteria: A research study of a national project. *Policy Futures in Education, 10*, 421–433.
- Inprasitha, M. (2021). Preface. In M. Inprasitha, N. Changsri & N. Boonsena. (Eds.) *Proceedings of the 44th Conference of the International Group for the Psychology of Mathematics Education* (Vol.1). Khon Kaen, Thailand: PME.
- Kalas, I., Benton, L. (2017). Defining procedures in early computing education. In: Tatnall, A., Webb, M. (eds.): *Tomorrow's learning: Involving everyone. Learning with and about technologies and computing. WCCE 2017. IFIP Advances in Information and Communication Technology*, Cham, Springer. Vol 515. pp. 567–578.
- Kalas, I., Horvathova, K. (2022). Programming concepts in lower primary years and their cognitive demands. *Digital Transformation of Education and Learning – Past, Present and Future, OCCE 2021*. Cham, Springer Nature, 2022. pp. 28-40.
- Kalas, I., Hrusecka, A. (2023). Levels of Control in Primary Robotics. Accepted for WCCE 2022 post-conference book, Cham, Springer.
- Kveseth, S.S. (2022). *Programmeringsverktøy i matematikkundervisning*. [Programming tools in mathematics education]. [Master's thesis, Norwegian University of Science and Technology]. NTNU Open. <https://ntnuopen.ntnu.no/ntnu-xmlui/handle/11250/3007904>
- Nordby, S.K., Bjerke, A.H., & Mifsud, L. (2022). Primary Mathematics Teachers' Understanding of Computational Thinking. *Künstliche Intelligenz 36*, 35–46. <https://doi.org/10.1007/s13218-021-00750-6>
- Nortvedt, G.A., Santos, L., & Pinto, J. (2016). Assessment for learning in Norway and Portugal: the case of primary school mathematics teaching, *Assessment in Education: Principles, Policy & Practice, 23*:3, 377–395, DOI: 10.1080/0969594X.2015.1108900
- Noss, R., Hoyles, C., Saunders, P., Clark-Wilson, A., Benton, L., Kalas, I. (2020). Constructionism can work: the story of ScratchMaths. In Holbert, N., Berland, M., Kafai, Y. (Eds.), *Designing Constructionist Futures: The Art, Theory, and Practice of Learning Designs*. (pp. 39-52). Cambridge, Massachusetts: MIT Press.
- Papert, S. (1980). *Mindstorms. Children, Computers, and Powerful Ideas*. Basic Books, New York.
- Saunders, Piers; (2022) Tracing the evolution of teachers' mathematical knowledge and pedagogy through programming: Learning from Scratch. Doctoral thesis (Ph.D), UCL (University College London). <https://discovery.ucl.ac.uk/id/eprint/10147323/>
- Sevik, K., & Guttormsgaard, V. (2019, May 8-10). *Algoritmisk tenkning og programmering i fagfornyelsen* [Computational thinking and programming in subject renewal]. [PowerPoint slides]. Nasjonal konferanse om bruk av IKT i utdanning og læring. Trondheim, Norway. <https://www.nkul.no/wp-content/uploads/2019-S1G.pdf>

- Thomas, M. O. J., & Palmer, J. (2014). Teaching with digital technology: Obstacles and opportunities. In A. Clark-Wilson, O. Robutti, & N. Sinclair (Eds.), *The mathematics teacher in the digital era: An international perspective on technology focused professional development* (pp. 71–89). Springer.
- Tofteberg, G. N., Tangen, J., Bråthe, L. T., Stedøy, I. & Alseth, B. (2020). *Maximum 8 Matematikk*. [Maximum 8 Mathematics]. Gyldendal Norsk Forlag.
- Turgut, M., Gjøvik, Ø., & Kohanová, I. (2022). *Surveying Norwegian mathematics teachers' implementation and use of tools for computational thinking and programming*. [Manuscript in preparation]. Department of Teacher Education, NTNU in Trondheim.

Full Papers

Mathematics teachers as designers e-textbook: resources and professional development

Ismael Almahdi and Osama Swidan

The Ben-Gurion University of the Negev, Israel

esmeela@gmail.com; osamas@bgu.ac.il

This paper presents a study that monitored math teachers throughout their experience of designing a chapter in an e-textbook in order to understand how an environment in which the interaction of digital resources, teachers participating in design, and locating resources might contribute to teachers' professional development. The data were collected through a course for math teachers. The theoretical perspectives that guided the study were: the Documentational Approach to Didactics (DAD) and the Interconnected Model of Professional Growth (IMPG). The findings indicate that the teachers gleaned resources from diverse sources with different considerations, and their professional development was demonstrated in the domains of change.

Keywords: *Teacher as designer, e-textbook, resources, professional development.*

Introduction

E-textbooks have become popular among math teachers, increasingly replacing printed textbooks (Usiskin, 2018). The transition from printed textbooks to e-textbooks has gradually become more pronounced following the Covid-19 crisis. This has impacted teaching practices (Kempe et al., 2019). In recent years research on e-textbooks has increased, yet less is known about teachers' involvement in designing them (Pepin, 2021). Until recently, the term "designing textbooks" was reserved for authors and experts in the field. However, the term's boundaries were breached in the era of e-textbooks. Currently, adapting content is increasingly possible, while opinions stressing the advantage of positioning teachers at the center of the design process have gained ground (Trouche et al., 2018). In tune with this background, this study focused on seven math teachers in order to study how to design a chapter in an inquiry-tasks e-textbook. In this paper, we strive to shed light on how teachers choose resources and the effect on their professional development. It was surmised that the process of designing would rely on the teachers' thought processes and principles, potentially leading to their professional development (PD). The teachers' PD in the context of their changes was tracked using the IMPG, which describes the PD of the teachers in four domains (Clarke & Hollingsworth, 2002). The framework of the DAD (Gueudet & Trouche, 2009), a holistic approach to teachers' work, was adopted to identify how the teachers chose and employed resources. The study aims to document the teachers' growth by the IMPG and to determine the resources teachers adopted when designing a chapter in an e-textbook. The questions that the study posed were:

1. What were the major resources used by math teachers for designing inquiry tasks in the e-textbook and what were their considerations?
2. In what domain did the teachers undergo changes following their experience in designing the e-textbook?

Professional development of teachers

Clarke & Hollingsworth (2002) proposed a model that addressed the PD of teachers as active learners who form their PD through reflective participation in PD programs throughout their practice. According to said model, change may occur in four domains that comprise the teacher's world: the personal domain, i.e., the teacher's professional knowledge, perceptions and principles; the domain of practice i.e., the teacher's professional experience; the domain of consequence i.e., the major results from practical experience that the teacher perceives as significant; and the external domain i.e., external sources through which the teacher is exposed to information. The teacher's development process includes sequences of changes comprising at least two processes that mediate enactment or reflective processes. The teacher's change occurs through interactions between different domains. Each action represents the performance of something a teacher knows or has experienced. The IMPG effectively identifies knowledge changes and learning paths that may occur in individual teachers (Huang et al., 2022). We use the four domains to identify the changes that the teachers underwent and the different learning paths that may have appeared. It would be reasonable to assume that choosing resources that are adjusted to the teachers' requirements with an emphasis on innovation impacts the teaching practice.

Documentation Approach to Didactics

This approach considers the work of teachers to be fundamentally composed of designing teaching materials through the use of diverse resources (Gueudet & Trouche, 2009). In this article, the term "resource" denotes a variety of teaching materials teachers use. After monitoring the teachers' work over a period of time, it is possible to gather information on how teachers employ resources, so that teachers will be able to design, choose and manage resources, and possibly also share some with colleagues; this process is known as the documentational genesis (Pepin, 2021). This process is present in many aspects of teachers' work and may lead to professional growth (Trouche et al., 2018). The interaction between the teacher and the resource consists of two processes: the process of instrumentation, the impact of the resources on the teacher's teaching practice; and the process of instrumentalization, the teacher's organization of the resources according to their leanings and knowledge.

Methodology

Seven secondary school math teachers holding at least a bachelor's degree participated in this study. The teachers' use of e-textbooks for teaching was relatively limited compared to the use of printed textbooks. For them, it was the first time they were involved in the process of designing tasks in an e-textbook. The data were collected through observation, gathering documents and tools, and interviews with the seven teachers. The goal was to obtain information on their considerations in selecting resources and the reflective processes resulting from a change in one domain in association with another. The study was conducted as part of a 30-hour PD course, held once a week for two months. The course focused on inquiry-based learning and digital tools (Geogebra and Goformative). After the course, the teachers embarked on their first experience as designers. This was their first opportunity to experience designing inquiry tasks within the framework of an e-textbook. At this point, the researchers observed and examined the process and stages of design undertaken by the

teachers, focusing on the types of integrated resources and monitoring the changes the teachers underwent in the Domain of Change. To observe and analyze the documentation work, we based our methodology on the principles of reflective investigation (Gueudet & Trouche, 2011). The first element was the broad collection of the material resources used and produced in the design process. The second element was a two-month follow-up to collect the resources the teachers used throughout the design process. The last element was to confront the teachers' views on their documentation work (for example, from the collection of material resources and from the teachers practices in their classrooms).'

Findings

We will present selected examples of the resources the teachers used throughout the design process. These examples were mentioned during the seminar, were documented on various occasions in the course of the seminar, and were raised during interviews with the teachers:

- a. The Ministry of Education curriculum - the teachers work on the basis of this curriculum as it is available daily in the course of their teaching. Teachers saw it as an authoritative resource requiring or demanding total commitment.
- b. Textbooks - a source that is available and reliable for them. Teachers rely on textbooks for their teaching, including examples and questions designed for students.
- c. Materials from colleagues - ready-made materials the participants obtained from senior colleagues.
- d. Websites - The seminar provided access to computers and an internet connection. The teachers took advantage of the free access to computers

Findings according to the Interconnected model of professional growth (IMPG)

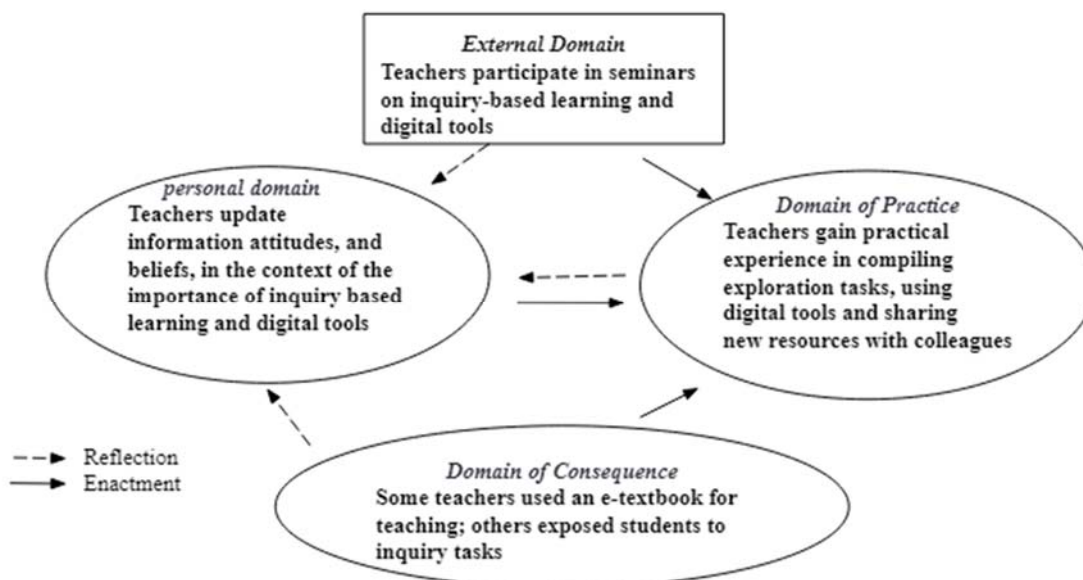

Table A: data on the processes Reflection between the domains according (IMPG)

From Domain	To Domain	Description	Example from data
External	Personal	Teachers consider and reflect on research and technological tools that influence their attitudes and knowledge.	“...Math teachers should know how to use GeoGebra, as I think this is a tool which can help them in their teaching.” (“N”)
Practice	Personal	How teachers reflected the influence of their experience at the seminar on their knowledge, perceptions, and attitudes.	“...After seeing what the other teacher did...I needed to look for another question.” (“M”)

Table B: data on the processes Enactment between the domains according (IMPG)

From Domain	To Domain	Description	Example from data
External	Practice	The effect of the stimuli and support offered to the teachers on their experience	“...In one of my lessons, I presented the students with exploration tasks on the same subject I had to teach to encourage them to think.” (“A”)
Personal	Practice	The influence of knowledge, personal views and perceptions on their methods	“...I chose a question from a test compiled by the mathematics coordinator at the school...The coordinator is more experienced than I am.” (“D”)
Consequence	Practice	The consequences for the teacher when applying the method during their practical work.	“I chose this question based on the level of the class I teach. I have students who have learning difficulties and I think that this fits their learning level.” (“M”)

Final remarks

In this study, we attempted to demonstrate how teachers’ use of resources - emphasizing their use of diverse resources while designing a chapter in an e-textbook - impacted their development and professional growth, as well as identifying the domain of changes that the teachers underwent. We present the initial findings that indicate how the math teachers’ exposure to and experience with diverse resources can support their PD. The results indicate that all seven teachers experienced seeking and choosing different resources based on various considerations. The teachers’ involvement in the design process contributed to enriching their knowledge. For example, they recognized the advantages of the e-textbook for enhancing their teaching. Using adapted and new resources can aid the teachers’ professional growth (Choppin et al., 2018). The teachers used resources from their educational environment. In fact, the resources used by teachers were based on their knowledge and their professional and personal set of beliefs, which are important in their choices (Gueudet &

Trouche, 2009). The process enabled them to choose the resources that supported their day-to-day practice. The course, that was based on exposing the teachers to innovative resources and granting them autonomy in choosing resources and designing inquiry exercises, was groundbreaking. It significantly differed from the PD process they were familiar with from previous years. This may impact their professional growth and increase the teachers' confidence to deviate, if necessary, from the contents of existing textbooks and to create learning texts independently, according to their teaching needs. Thus, we consider it essential to involve teachers in designing, and concur with the researchers who state that teachers should be positioned at the center of the design process (Trouche, Gueudet & Pepin, 2018). We acknowledge that the number of participants was small and that it is necessary to conduct a study with a more significant number of participants and long-term participation to essentially understand the correlation between the use of resources and teachers' development and professional growth.

References

- Choppin, J., McDuffie, A. R., Drake, C., & Davis, J. (2018). Curriculum ergonomics: Conceptualizing the interactions between curriculum design and use. *International Journal of Educational Research*, 92, 75–85. <https://doi.org/10.1016/j.ijer.2018.09.015>
- Clarke, D., & Hollingsworth, H. (2002). Elaborating a model of teacher professional growth. *Teaching and teacher education*, 18(8), 947–967
- Gueudet, G., & Trouche, L. (2009). Towards new documentation systems for mathematics teachers? *Educational Studies in Mathematics*, 71(3), 199–218.
- Gueudet, G., Trouche, L. (2011). Teachers' Work with Resources: Documentational Geneses and Professional Geneses. In: Gueudet, G., Pepin, B., Trouche, L. (eds) From Text to 'Lived' Resources. *Mathematics Teacher Education*, vol 7. Springer, Dordrecht. https://doi.org/10.1007/978-94-007-1966-8_2
- Huang, X., Lai, M.Y., & Huang, R. (2022). Teachers' changes when addressing the challenges in unexpected migration to online mathematics teaching during the COVID-19 pandemic: A case study in Shanghai. *ZDM Mathematics Education*. <https://doi.org/10.1007/s11858-022-01378-y>
- Kempe, A. L., & Gronlund, A. (2019). Collaborative digital textbooks-a comparison of five different designs shaping teaching and learning. *Education and Information Technologies*, 24(5), 2909–2941.
- Pepin, B. (2021). Connectivity in support of student co-design of innovative mathematics curriculum trajectories. *ZDM Mathematics Education*. <https://doi.org/10.1007/s11858-021-01297-4>
- Trouche, L., Gueudet, G., & Pepin, B. (2018). Open Educational Resources: A Chance for Opening Mathematics Teachers' Resource Systems. In *Research on Mathematics Textbooks and Teachers' Resources* (pp. 3-27). Springer, Cham.
- Usiskin, Z. (2018). Electronic vs paper textbook presentations of the various aspects of mathematics. *ZDM—Mathematics Education*, 50(5), 849–861. <https://doi.org/10.1007/s11858-018-0936-2>.

Interactions and meaning-making in an AR learning environment

Sara Bagossi, Nadia Shifrin, Otman Jaber, and Osama Swidan

Ben-Gurion University of the Negev, Israel;

bagossi@post.bgu.ac.il; nadiash@post.bgu.ac.il; jaberot@post.bgu.ac.il; osamas@bgu.ac.il

This study aims to identify the interaction between students as they use augmented reality and understand how the students' interaction may help them disclose mathematical ideas. In this study, we focus on how augmented reality may lead students to disagree and how the disagreement allows them to disclose mathematical objects.

Keywords: Augmented reality, layers of meaning, interactions, disagreement.

Introduction

Augmented reality (AR) is an innovative technology that overlays virtual objects into the real world (Akçayır & Akçayır, 2017). AR allows juxtaposing real-world phenomena and virtual objects and provides real-time data layers that model dynamic situations. In addition, AR promotes interaction among students (Akçayır & Akçayır, 2017; Kamarainen et al., 2013) and facilitates mathematical discussions (Wang et al., 2014). These characteristics create opportunities for exploring and creating meanings for relations between real-world dynamic phenomena and virtual mathematical representations. In this contribution, we shed light on how a specific design of augmented reality technology affects students' interaction and their meaning-making processes.

Theoretical framework

According to the phenomenological perspective (Rota, 1991), mathematical meaning-making happens through a gradual interpretation of the surrounding world and of the various situations in the world in the contexts in which they are exposed. This process resumes the Husserlian concept of disclosure: the same situation may evoke different contexts and produce different sense-making according to the people's background, age, and culture. Such different contexts are not isolated but layered upon each other and generate different layers of disclosure in time flow. Disclosure happens when one can grasp an object's functionality in a given context. The disclosure process is far from natural. Students should be educated to make sense of what they disclose when they meet with mathematical objects.

The relationship between interaction and sense-making of mathematical concepts – as a case of knowledge construction – has been acknowledged among several mathematics educators. For instance, Balacheff (1999) argued that the literature on social constructivism has confirmed the productive and essential character of social interaction and revealed that the social interaction processes are conducive to the construction of mathematical concepts by their very nature. Berland and Reiser (2009) argued that interaction and sense-making are two interlinked, essential scientific practices that schooling should make available to science students. In tune with Berland and Reiser, our basic assumption is that interaction, which includes, among other things, questioning, agreement/disagreement, and the search for explanations and justifications, may foster the students' understanding and prompt their subsequent disclosure of the mathematical relationships depicted in

the digital tool. In particular, disagreements are essential expressions of interactions in a learning process. Such expressions cause participants to raise new and additional ideas, change their minds and perceptions and increase creativity (Van Offenbeek, 2001; Sharma, 2012). Hence, this study's research question is: How does the augmented reality environment promote disagreement between students, and how do these disagreements contribute to disclosing layers of mathematical meanings?

Method

The present study reports on the interaction processes of three 15-year-old students from Israel. The task analyzed in this contribution aimed to disclose the relationship between spring elongation and mass through performing a real experiment and with the support of AR technology. The technological tool we used in this study is an AR headset that collects real-time data of a dynamic phenomenon during a physical experiment about a spring elongation obtained by adding some cube-weights at its free extremity (Figure 1). The data are collected by sensors and analyzed, and the mathematical representations are displayed simultaneously to the students using the designated headset.



Figure 1: Spring elongation phenomenon- students experimenting and observing the graph

In this qualitative study, we adopted as an analytic method a descriptive coding of the emergent forms of interactions (Saldana, 2015). Videos of the learning experiments were watched repeatedly to identify all the relevant interactions. These interactions were classified during the first coding cycle, describing their features. During the second coding cycle, they were grouped into categories and provided with an entitling tag. Eventually, we revised the coding and elaborated on three macro-categories: i) interactions promoting the discussion; ii) interactions based on disagreements; iii) asking questions. Among these categories, in this contribution, we will specifically focus on a selected episode in which interactions based on disagreement emerge.

Results

In the following episode, three students, Sagi, Alex, and Noam, were asked to endow the axes of the Cartesian system in their task with meanings. This episode illustrates the disagreement that emerges because of observing different virtual representations.

- 2 Alex: So, the x-axis... it seems to me...
- 3 Sagi: The y-axis... we saw the length of the ... the height of the spring. It is the... from its initial state plus the elongation.
- 4 Alex Spring length... umm... in cm. The x-axis was the weight of the cubes.

- 5 Sagi: The x-axis was...
- 6 Noam: On the x-axis was only two points. Points between the lengths and points between the parallel lines of the box. It was like this [draws on the right in Figure 2]. There were two boxes between the spring; I had two points along the y-axis that connected the spring. These two points describe the distance between them.
- 7 Alex: It is not; it is given on the graph itself, not on the boxes as you draw in the figure
- 8 Noam: Which graph?
- 9 Sagi: There was a graph when you saw the ... on the spring itself, there was a graph.
- 10 Noam: I only had a table next to it; I only noticed a table next to it.
[...]
- 14 Sagi: Can I check it again for a moment?
- 15 Noam: The table of values had two columns, length, and weight



Figure 2: Noam's drawing-graph points seen as edge points of the reference box

In [2-5], Alex exchanges what they disclosed through the headset. Alex and Sagi conjectured that the x-axis is for the cube's weight and the y-axis is for the spring length. The interaction between Sagi and Alex is characterized as one completing each other's ideas. This harmony is interrupted when Noam says that the x-axis has only two points. Her utterance "On the x-axis was only two points... parallel lines of the box" [6] suggests that Noam focuses on specific virtual objects while she ignores the Cartesian system. It seems that Noam's disclosure led her to disagree with her classmates. In [7], Alex revives the discussion by disagreeing with Noam's argument "[i]t is not" and describes what he has disclosed (the graph). In [9] Sagi confirms Alex's argument and describes what he has disclosed "on the spring itself, there was a graph". In [10], Noam also describes what she has disclosed "I only noticed a table [of value] next to it". Sagi's utterance in [14] suggests that he needs to look again through the headsets to be sure of what he noticed. Noam, in [15], adds that the table of values she has disclosed consists of two columns: length and weight.

Final remarks

This short contribution is part of a large research project aiming at investigating how AR technology shapes students' interactions. In this paper, we present and discuss one case in which the use of AR

leads to disagreement between the students. Of course, this is not the only type of interaction we found. However, we present this type since we found that the features of AR prompt disagreement between the students. The ways used by students to overcome disagreement led them to look for justification and explanations to convince their classmates. In our case, even though the headsets present the same data, different students focused their attention on different aspects of the virtual representations.

Situations in which students disagree may create opportunities for meaning-making. In our case, the disagreement between the students leads each one of them to contribute with the specific aspects (s)he has disclosed. As the discussion progresses, the students pay attention to the aspects that have been disclosed by the others. In this case, the sum is bigger than its parts.

As we showed in the episode above, even though the same information was presented to all students using the headsets, each student paid attention to something different. This issue requested them to reexperience. Hence, the AR not only helps in the creation of the disagreement but also plays a crucial role in solving disputes by examining different opinions and ideas. The students are free to explore and test and thus AR promotes the potential for self-building knowledge (Ibáñez & Delgado-Kloos, 2018). As a future direction of research, we aim at collecting data from other teamwork activities focused on learning other scientific concepts and refining the coding of the interaction categories identified in this preliminary study.

Acknowledgment

This study was supported by the Israeli Science Foundation (Grant No. 1089/18).

References

- Akçayır, M., & Akçayır, G. (2017). Advantages and challenges associated with augmented reality for education: A systematic review of the literature. *Educational Research Review*, 20, 1–11. <https://doi.org/10.1016/j.edurev.2016.11.002>
- Balacheff, N. (1999) 'Is argumentation an obstacle? Invitation to debate', in *International Newsletter on the Teaching and Learning of Mathematical Proof*, Grenoble: IMAG.
- Berland, L. K., & Reiser, B. J. (2009). Making sense of argumentation and explanation. *Science education*, 93(1), 26-55. <https://doi.org/10.1002/sce.20286>
- Ibáñez, M. B., & Delgado-Kloos, C. (2018). Augmented reality for STEM learning: A systematic review. *Computers & Education*, 123, 109-123. <https://doi.org/10.1016/j.compedu.2018.05.002>
- Kamarainen, A. M., Metcalf, S., Grotzer, T., Browne, A., Mazzuca, D., Tutwiler, M. S., & Dede, C. (2013). EcoMOBILE: Integrating augmented reality and probeware with environmental education field trips. *Computers & Education*, 68, 545-556. <https://doi.org/10.1016/j.compedu.2013.02.018>
- Rota, G. C. (1991). *The end of objectivity: a series of lectures delivered at MIT in October, 1973*. Oxford, England: TRUEXpress.
- Saldana, J. M. (2015). *The coding manual for qualitative researchers* (3rd ed.). SAGE Publications.

- Sharma, P. (2012). Advertising effectiveness: " understanding the value of creativity in advertising", a review study in India. *Online Journal of Communication and Media Technologies*, 2(3), 1. <https://doi.org/10.29333/ojcm/2386>
- van Offenbeek, M. (2001). Processes and outcomes of team learning. *European journal of work and organisational psychology*, 10(3), 303-317. <https://doi.org/10.1080/13594320143000690>
- Wang, H. Y., Duh, H. B. L., Li, N., Lin, T. J., & Tsai, C. C. (2014). An investigation of university students' collaborative inquiry learning behaviours in an augmented reality simulation and a traditional simulation. *Journal of Science Education and Technology*, 23, 682–691. <https://doi.org/10.1007/s10956-014-9494-8>

Technology-based mathematics teaching environment as a factor affecting mathematical definitions: a challenge for teachers

Marita Barabash and Elena Naftaliev

Mathematics Teaching Department, Achva Academic College, Israel

maritab@013.net, elenanaftaliev@gmail.com

Using technology to teach mathematics involves conceptual, pedagogical and other transfigurations. In particular, teachers may face mathematical issues different from what they have learned and teach at school. Here, we present our GeoGebra Book based geometry workshop for teachers, in which they faced definitions of polygon and area adjusted for computer platforms. We analyze our observations basing on our three-fold theoretical framework, which includes experimental mathematics (Borwein, 2013) in school, the semiotic framework for pedagogical functionality of interactive materials (Naftaliev (2018) and instrumental orchestration (Trouche et al., 2013).

Keywords: definitions in mathematics; technology-based interactive curriculum resources; experimental mathematics in school; pedagogical functionality; instrumental orchestration.

Introduction

What is presented herein is a small excerpt from our on-going research, in which we study ways of promoting secondary/high-school mathematics teachers' knowledge, skills, and orientations in order to enrich their teaching practices with educated and perceptive use of Technology-Based Interactive Curriculum Resources (TBICRs), in implementing the Experimental-Mathematics (EM) in school alongside with formal, deductive mathematics. Teaching with interactive curriculum resources is more than a technological change; indeed, it is an attempt to create new paths to the construction of mathematical meaning (Naftaliev, 2018), (Barabash, 2019). Groping for the ways to attain this, we opted studying first of all how teachers cope with new mathematical meanings. We present and analyze here the design principles and some outcomes of the workshop organized at the initial stage of the project, with emphasis on teachers' coping with mathematics related to the TBICRs use. In particular, we focus on definitions of mathematical objects familiar to teachers, transformed as a result of their embedding in technologic environment. The design of the project and analysis of the observations are based on our three-fold theoretical framework concisely perused herein, which included experimental mathematics in mathematics teaching and learning, the semiotic framework for pedagogical functionality of interactive materials and instrumental orchestration.

Theoretical frameworks and methodology

Modern experimental approach to mathematics is inseparable from the powerful incentive of modern technology. Borwein (2013, pp. 33-34) has formulated a number of characteristics of what he coined as methodology of this approach, of which we focus on "gaining insight and intuition; discovering new relationships". Recent studies (Arzarello & Manzone, 2017; and others) indicate inevitable and deep transformation in school mathematics related to EM. Interweaving EM at school with formal, deductive mathematics involves conceptual, pedagogical, procedural, didactic, and educational-system transfigurations.

Naftaliev & Yerushalmy, (2017), Naftaliev (2018) introduced a semiotic framework for pedagogical functionality of IDs (Interactive Diagrams) as a pedagogical tool. An ID is a relatively small unit of

interactive text composed of a specific example, its representations (verbal, visual, other) and interactive tools. The semiotic framework is characterized by three types of ID functions that address a variety of pedagogical settings: presentational (refers to type of example in the ID), orientational (refers to mode of representations in the ID), and organizational (refers to the connection between all the components of the ID). The presentational function refers to the three types of examples in IDs: specific, random, and generic. “Sketchiness” vs. “rigorousness” of diagrams is an important factor in user orientation. The organizational function looks at the system of relations defining wholes and parts and specifically at how the elements of text combine together. IDs can be designed to function in three different ways: Illustrating, Elaborating, Guiding. Similar TBIRs designed according to different pedagogical functions should be considered different learning settings (ibid.). The results of the studies find this framework valuable and productive as a tool for teachers’ professional development.

Trouche et al. (2013), Gueudet & Trouche (2012) and others refer to instrumental orchestration as the teacher’s intentional and systematic organization and use of various artefacts available in a learning environment related to a given mathematical task. Teachers’ orchestration includes arrangement of learning environments, or “didactical configurations”, and intentional guidance of their exploitation modes.

In this paper we reveal and analyze our participants’ process of learning mathematics in the environment designed to merge experimental and theoretical mathematics. Their first steps in this process articulate their concepts of mathematical objects, their preparedness to adjust to the GeoGebra environment, and to absorb, amalgamate and apprehend the diverse information each of its “windows” exposes, and the mathematical background behind this information. During the first workshop presented here, we strived to test versatility of their mathematical knowledge needed for this learning process, in particular, in what concerns mathematical definitions and representations of mathematical objects in a dynamic platform. Therefore, our research question is: *To what extent are educated and experienced high-school teachers aware of the need and able to adjust formal definitions and concept images of mathematical objects and the modes of work with these objects to the dynamic computerized environment, and of the mathematical justification of such amendments?* In “modes of work” we include open-minded experimentation with the mathematical objects in the spirit of experimental mathematics.

Methodology

Our research method is qualitative analysis of the documents produced in the course of the project: Zoom recordings and their transcripts, chats and otherwise registered discussions, etc. The categories were based on the three theoretical frameworks above. The participants were 14 high-school teachers. Their academic backgrounds varied from B.Ed. or B.Sc. degrees (9), through MA / M. Sc. degrees (4), to PhD in mathematics education (1). All the participants hold teaching certificate for secondary / high school.

The geometry unit: setting, resources, and observations

The first workshop of the project lasted for three successive sessions, the first one being dedicated to the Geometry Unit (GU). It took place via Zoom platform and lasted for more than 4 hours. We sample here resources from GU and present their analysis within the framework of our study. The

mathematical side of GU referred to definitions. Some key mathematical definitions in computer environment significantly differ from those familiar to the teachers. Mathematics teachers deal with concept definitions and concept images (Vinner & HersHKowich, 1983) previously formed in their students' or in their own minds. One of the expectations in providing a mathematical definition and working with it is the ability to adopt and imply it despite existing images of the concept being defined. Another necessary ability is to refer to different definitions of the same (or seemingly same) object and to assess whether they are equivalent, whether one of them is a generalization of the other, or maybe they contradict each other in some aspect. Definitions in mathematics may be context dependent. Formal mathematical rigor, technological constraints, didactic considerations are examples of decisive factors in the choice of definition of an object. As we observe herein, technology is an active participant and not a passive tool; it actively intervenes in mathematical aspects, such as mathematical definitions and may be not sensitive to pedagogic or curricular needs.

The mathematical perspective: Definitions of polygon and its area

GU presented in GeoGebra book includes dynamic implementations of constructing a quadrangle by its diagonals and involves the participants in guided experimentation in the spirit of EM (<https://www.geogebra.org/m/shsqeeqf>). The presentation of activities in GeoGebra book organizes and structures the workshop, accounting for its hierarchical nature of evolving experiment. The platform suggests rich and possibly unexpected appearances of quadrangle, see e.g., Sinclair et al., 2012; de Villiers, 2015). In addition, in GeoGebra, the quadrangle is denoted by numerical value q (q_1 in most cases in the GU). One of the main foci of the unit is on this value, striving to cause a user – a high school teacher, in our case, to ponder via experimenting on the question: Why and how a geometric object is represented by a single number? An almost immediate and obvious guess for q is that it is area. Nevertheless, for self-intersecting quadrangles, q vanishes for non-void interior. Neither self-intersecting polygons, nor a phenomenon of zero area for non-void interior lay within school curriculum. And yet, the usage of such a platform as GeoGebra is increasingly popular at school. Therefore, a second focus is on the notion of quadrangle (or, more generally, of polygon), leading to various definitions of quadrangles and of area: how are these definitions chosen, and how are they inter-related? Keeping to a definition becomes challenged by the discrepancy between the concept image and the concept definition of quadrangle, in the case of self-intersecting or degenerate one. The teachers' concept image for quadrangle is one related to the definition adopted in school mathematics (Definition 1 herein) which excludes self-intersection. Computer-generated polygon (Definition 2) allows for self-intersection and collinearity of adjacent and non-adjacent vertices, since the algorithms related to polygons creation in computer graphics follow the vertices in order of their appearance, whichever resulting polygon they yield, or whichever polygons result later on from dragging the vertices. The workshop confronted the teachers with the need to elucidate to themselves these appearances of quadrangle and the meaning of q_1 . With this purpose in mind, a guided activity of the workshop was designed. To sum up: The EM core of GU is guided experimenting aimed at the definitions of polygon (applied to quadrangle) and of area of polygon vs. their concept images, in computer-graphic environment.

We counterpose here two definitions of polygon. Definition.1 Polygon is a simple closed line (curve) consisting of straight-line segments. Definition. 2. Polygon is as an ordered sequence of points – vertices, in which the first and the last points coincide. This definition is implicitly in the basis of area

computation in <https://mathworld.wolfram.com/PolygonArea.html>. A school curriculum usually adopts the definition of polygon as a simple closed line (see e.g., https://retro.education.gov.il/tochniyot_limudim/math/metzolaim.htm).

Area of polygon

A definition of polygon has direct implication on the definition of its area. Polygon defined as a simple closed line enables application of the Jordan Curve theorem, stating that a closed simple line divides the plane into two domains, one of which is bounded, and it is the interior of the curve. This theorem is not a part of the school curriculum, but it ensures an unambiguous concept of bounded domain and correspondingly, of its area. In the case of polygon as non-simple closed curve, the notion of area is nebulous and causes ambiguities as to the choice of interior, as in the case of “star-like” polygon (see e.g. <https://mathworld.wolfram.com/Polygon.html>). In the case of ordered sequence of vertices, the area accounts for the ordering, which leads to the concept of signed area: The signed area of a polygon is defined e.g., in (<https://demonstrations.wolfram.com/SignedAreaOfAPolygon/>). In order for the output for area to be non-negative, the final result of signed area computation is presented by its absolute value. If the polygon is simple and its vertices are numbered counterclockwise, Definition 2 turns to be Definition 1. Table 1 presents concisely mathematical contents of GU, necessary for the further analysis of teachers’ coping with definitions of quadrangle and area.

Table 1. Mathematical contents analysis of the unit tasks

Task	Mathematical contents (EM / formal mathematics)
1	In this introductory task the participants get acquainted with the problem and with the task setting, dragging modes and their outcomes.
2	In this task, the participants are to conjecture how various dragging modes might affect the value qI , still not being sure what it is.
3	Participants’ conjectures in this task depend on previous results. The graphs clarify the dependence of qI on each of three independent variables.
4	In this task, the teachers are purposely addressed to various degenerate cases of quadrangles not familiar to them from their previous experience, but unavoidable in computer-based transformations and area calculations. Eventually they are addressed to the concept of signed area indispensable in computer-based geometric calculations of area.

Pedagogical functionality

Table 2 characterizes pedagogic functionality of the tasks:

Table 2. Pedagogical functionality analysis of the unit tasks (Naftaliev, 2018).

Task	Pedagogical functionality
1	The <i>presentational</i> function of this ID is a <i>generic</i> one; its <i>orientational</i> function is <i>schematic and metric</i> : it links the variability of the configuration to the variability of the <i>numeric values</i> of input data. The <i>organizational</i> function is an <i>illustrating diagram</i> .
2	The <i>presentational</i> function of this ID is also <i>generic</i> . The <i>orientational</i> function is purely <i>schematic</i> : the participants are purposely deprived of numerical data. It is an <i>illustrating ID</i> , as in the previous task.
3	The <i>presentational function</i> ID is <i>generic</i> , with emphasis on qI . The <i>orientational</i> function is also <i>schematic</i> . The <i>organizational</i> function is <i>guiding</i> .
4	As in the previous task, the <i>presentational function</i> is <i>generic</i> . The <i>orientational function</i> is both <i>schematic and metric</i> , purposely focusing on the case of zero area for non-void interior as an indication to the need of reconsidering the definition of area in computer-graphic application. The <i>organizational</i> function of this task is also <i>guiding</i> . The diagram has as its ultimate aim the upgrading concepts of the quadrangle and of its area.

Orchestration modes

We discern three principal orchestration modes in GU, each one with its explicit purposes and timing:

- The pre-designed orchestration modes reflected in the setting of the tasks of the unit, aimed at structuring the experiments and at their ultimate purposes, class arrangement for plenary and group work, at various stages of the GU.
- The on-going interference during various stages of GU.
- The post-factum interference following the analysis of unit outcomes, aiming at further clarification of mathematical ideas and pedagogical functions of tasks of the unit (this mode is not referred to in this paper).

Results

Selected observations illustrating the evolving awareness to modified definitions

The following series of short excerpts out of 5th -18th minutes of the GU record followed by excerpts from the final stage (3hrs. 20th -25th min.) present the evolution of the participants' awareness of existence of various definitions of quadrangle and area as a result of their work, organized along the theoretical frameworks of our study. RI is one of the researchers. The participants are encoded by first letters of their names.

(5th Min. -18th Min.).

M: I have reached some conclusions... I understood that when I drag the vertex G, never mind what the resulting figure is – the area does not change.

RI: M., How are you so sure that this is area? I was asking you about q1. ...

M: Ah, OK. I based on the supposition that it is area.

S to RI: Eventually, we will be surprised to discover that q1 is not area...

RI to M: OK, write this down: I know that this is area. And now – how do you propose to make sure that this is area?

YU1: I began not with questions referring to q1; I asked: if I drag the point G – what figures do I obtain? Do they count? How can I consider them? ...

M: I discovered that when I drag the vertex G, so that the diagonals do not intersect, I obtain a non-convex quadrangle, and when I drag F, I obtain two triangles. Why?

Ts: When we are dragging by F, the angle (between the diagonals) changes, and when we are dragging by G, it remains unchanged. How this angle impacts q1? Now, there is a configuration that G and E coincide. I am not sure that q1 is area, but I suppose that it is, and in this configuration the areas become equal...

RI: Equal – whose and whose?

Ts. And M: Of the triangle and of the quadrangle...

RI: Just a moment (configuration 1): do you mean that the sum of areas of these two triangles will become equal to the area of this triangle (dragging G to E) results in one triangle?

As one may observe, during the first minutes of the group activity the interference was aimed at steering the discussion towards the awareness that what is seemingly obvious, is not, that questions should be asked the answers to which are not immediate and lucid, and that there is something that the teachers had not come across previously. Having attained this, the RI more or less withdrew from the discussion. The participants continued working in groups and in plenum (in Zoom) till the following excerpt, documenting their work as previously indicated.

(3hrs. 20th -25th min.) (the discussion refers to the notions of quadrangle and its area after the participants were exposed to self-intersecting and degenerate quadrangles)

M.: ...but if it is not a quadrangle - how did the software compute its area as if it were?

Ts.: It is a quadrangle. We must understand what the definition of quadrangle is...

E. I am not sure that those who wrote the software, referred to these cases

- Ts. I am sure that they did, and that there is a definition that we fail to discern. We are just not familiar with it profoundly enough, with all those extreme cases: what happens if there is a degenerate quadrangle; what happens if the vertices switch their positions...
- M. Just a moment, Ts. just a moment... I mean – the definition we know from geometry – what is a quadrangle, what is area – this sort of things. I just want to sum up what the questions are. So again: based on the definitions we are familiar with – who is right: we or they; the second question: suppose we are right – don't the programmers know geometry? Don't they have counselors in geometry? What are the reasons that, in spite of their knowing the "correct" definition – theirs is "incorrect" compared to the definition accepted by us; and if we are wrong and they are right – what is lacking in our definition so that it is a "complete" definition of quadrangle? That's it. These are the three questions of mine.
- RI: Any more questions? If not – I think this is a good point to stop. You have some instructions and hints in the end of the task. My first point is that you should try and think over the questions that M. posed. There is some guiding in the file, and I will ask you another question, a very wide and somewhat vague about the definition of definition. What do we mean by the word "definition"? what is allowed and what is not? What is accepted and what is not?

The orchestration modes appearing in the excerpts above, evolved as a response to the teachers' deliberations. We characterize the orchestration objectives during the initial phase of the activity as tactical, aimed at steering the discussion into the desired route: to prevent too premature and / or seemingly obvious though unsubstantiated answers; to ensure proper documentation; to ensure proper experiment setting; to focus the participants' attention on the fact that the meaning of q1 has not yet been clarified; to underline the questions posing aspect. Unlike the initial phase, the orchestration objectives of the closing discussion were of more strategic character: to enhance the clarity of participants' suggestions; to underline the need of substantiating one's claims and of providing valid argumentation; to clarify the definitions of polygon and of its area applied in computer graphics (the researcher addressed the teachers to the Wolfram site, as one can see in GU); to enhance the teachers' conception of definition in mathematics, in general.

Analysis and discussion

In order to answer our research question, we analyzed the materials of the geometry unit through the lenses of our theoretical frameworks, with emphasis on EM as the subject matter, on pedagogical functionality as the didactic-organizational rationale of various parts of the unit, and on orchestration modes as mediation between the learners and the unit at various stages of learning. We designed the unit for teachers as learners to enhance their awareness of mathematical definition in general, and of definitions of quadrangle and of its area, and their ability to grasp new or modified definitions and representations in the context of the TBICR-and-EM-based teaching and learning. In particular, we focused on definitions of polygon and of its area in computerized environment that cannot be confined to definitions accepted in school curriculum, even if completely consistent with formal mathematics (see e.g., De Villiers, 2015). This need for amendment of a mathematical definition to a context and the possibility of such a choice is important to emphasize for the teachers as users both in learning and in teaching of mathematics in this new mode. The unit was designed as evolving experiment, aiming at: helping the participants get familiar with the environment; linking the objects familiar from pen-and-pencil experience with the same objects in computerized environment; highlighting the factors that may influence the choice of definition; providing the experience that might model their own future modes of teaching. The pedagogical functionality and the orchestration modes were

superimposed in the unit design, in view of these aims and of our research question. Thus, the first two tasks were illustrating diagrams with generic example, aimed to expose the participants to q1 as a single-valued numerical representation of a set of geometric figures, and to the variety of quadrangle configurations, controlled by the dragging modes. The rest of the tasks were designed as guiding diagrams, enabling open investigation. The numeric and schematic modes of the data presentation in all the tasks focused the users' attention on special cases new to them. The three orchestration modes applied at different stages were attuned to the design of pedagogic functions and to the mathematical contents. The predesigned orchestration included instructions in the written tasks, guiding questions and suggestions to pose questions and look for theorems, and class arrangements. As one may observe from selected excerpts presented above, the mode of orchestration applied in the initial part of the meeting, aimed at keeping the participants up to the spirit of the unit as an evolving experiment, and at responding to their instant, seemingly obvious but irrelevant answers and reactions based on their previous knowledge and experience, whereas at the final stage the discussion focused on new meanings of definitions and eventually the researcher addressed the participants to the new meanings reflected in "upgraded" definitions of polygon and area, in the spirit of EM.

As one may observe from the excerpts presented above, the participants' attitude in the beginning of their learning to the mathematical phenomena they came across, was: "the geometry we know is the correct one; computer programmers can't do with it as they please"; when dragging and "playing around" led to a configuration or a result incompatible with the definitions or concept images they had adopted in the framework of their school teaching, they considered it as redundant or tended to disregard it; they followed the experimentation mode of work suggested in the unit as long as it produced results they could explain and accept. Neither the pedagogical functions of different parts of the unit adjusted to the roles of these parts in the unit, nor the diverse modes of orchestration applied at different stages of design and implementation of the unit did not succeed in overcoming the teachers' "stronghold" attitude to their mathematical knowledge.

To sum up, the answer to our research question on the basis of the analysis of materials produced during the workshop based on the GU is that the educated and experienced teachers' mathematical knowledge, its versatility and adaptability to the interactive dynamic platforms are not necessarily granted and should be the matter of close and systematic learning processes.

In view of the issues that evoke in the challenge of merging the experimental mathematics with the teachers' formal mathematical knowledge stemming out their previous education and experience, we suggest that the flexibility and versatility of the teachers' mathematical knowledge is one of the pivotal factors in implementation of this approach (Naftaliev ,2018). The teachers faced mathematical objects seemingly familiar to them, that at some point or other failed to fit into the familiar definition, as the concept evolved during the activity of a workshop. The unit design based on the three theoretical frameworks presented and analyzed above, was intended to help the teachers to cope with discord between the definition and the concept image of a familiar object. For realization of experimentation in mathematics at the level of high-school curriculum, coping with various embodiments of an object (even a seemingly familiar one) related to its different definitions, becomes a key mathematical and didactical challenge.

Acknowledgments

This research was supported by the Israel Science Foundation (grant No. 780/19).

References

- Arzarello, F., & Manzone D. (2017). The planimeter as a real and virtual instrument that mediates an infinitesimal approach to area. In: Leung, A. & Baccaglini-Frank, A. (Eds.), *Digital technologies in designing mathematics education tasks—Potential and pitfalls. Mathematics education in the digital era*, 121–152. New York: Springer.
- Barabash, M. (2019). Dragging as a geometric construction tool: Continuity considerations inspired by students' attempts. *Digital Experiences in Mathematics Education*, 5(2), 124–144. [10.1007/s40751-019-0050-2](https://doi.org/10.1007/s40751-019-0050-2)
- Borwein, J.M., & Bailey, D. (2004). *Mathematics by experiment*. Natick, MA: A K Peters.
- de Villiers, M. (2015). Crossed quadrilaterals: a missed lakatosian opportunity? *Philosophy of Mathematics Education Journal*, 29. <http://dynamicmathematicslearning.com/dream-crossed-quads.pdf>
- Gueudet, G., & Trouche, L. (2012). Teachers' work with resources: Documentation geneses and professional geneses. In G. Gueudet, B. Pepin, & L. Trouche (Eds.), *From text to "lived" resources: Mathematics curriculum materials and teacher development*, 23–41. Springer, Dordrecht.
- Naftaliev, E., & Yerushalmy, M. (2017). Design digital tasks: Interactive diagrams as resource and constraint. In Leung, A. & Baccaglini-Frank, A. (Eds.), *Digital technologies in designing mathematics education tasks—Potential and pitfalls. Mathematics education in the digital era*, 153–173. Switzerland: Springer.
- Naftaliev, E., (2018). Prospective Teachers' Interactions with Interactive Diagrams: Semiotic Tools, Challenges and Well-Trodden Paths. In Fan, L., Trouche, L., Qi, C., Rezat, S. & Visnovska, J. (Eds), *Research on Mathematics Textbooks and Teachers' Resources: Advances and Issues*, 297–314. Springer.
- Sinclair N., Pimm D., Skelin M. (2012). *Developing essential understandings of geometry for teaching un grades 6-8* (pp. 36–38). Reston VA: The National Council of Teachers of Mathematics.
- Trouche, L., Drijvers, P., Gueudet, G., & Sacristan, A. I. (2013). Technology-driven developments and policy implications for mathematics education. In Clements, M.A., Bishop, A.J., Keitel-Kreidt C., Kilpatrick, J., & Leung, F.K.S. (Eds.), *Third international handbook of mathematics education* (1st ed), 753–789. Springer-Verlag, New York.
- Vinner, S., & Hershkowitz, R. (1983). On concept formation in geometry. *ZDM—The International Journal on Mathematics Education*, 1, 20–25.

Developing visuospatial ability by creating the virtual models of cubic solids for 3D printing

Daniela Bímová¹, Petra Pirklová¹, Jiří Břehovský¹, Klaus-Peter Eichler² and Asif Mushtaq²

¹Technical University of Liberec, Faculty of Science, Humanities and Education, Liberec, Czech Republic; daniela.bimova@tul.cz, petra.pirklova@tul.cz, jiri.brehovsky@tul.cz

²NORD University, Faculty of Education and Arts, Bodø, Norway; klaus-peter.eichler@nord.no, asif.mushtaq@nord.no

Spatial ability is an integral part of everyone's life which is why its practice and deepening are very important. In this article, we reflect on one aspect of 3D printing that contributes to and helps just developing spatial ability. This aspect is the creation of a virtual 3D model of a 3D object in the Rhinoceros software. In this virtual 3D model creation, different visuospatial abilities are involved in other parts of the structure. Our goals are to assign the appropriate visuospatial abilities and categories of identified actions to individual construction steps in the Rhinoceros and PrusaSlicer software for the successful completion of the 3D printing process.

Keywords: Spatial ability, visuospatial abilities, spatial orientation, mental rotation, 3D printing.

Introduction

Visuospatial abilities are one of the crucial abilities of every human being. Without people realizing it, they use visuospatial abilities in their everyday life, e.g. when they need to find their way in the city, in nature, when reading and orienting on maps, parking cars, arranging decorations in rooms, etc. Of course, professionals such as architects, builders, astronomers, doctors, mechanical engineers, and others cannot do their jobs without visuospatial abilities. Samsudin, et al. (2011) mentioned that these abilities were previously regarded as innate, but evidence from experimental studies suggests that significant improvement is possible through proper and specific training. Wang, et al. (2021) stated that in recent years, with the rapid development of 3D printing technology and the popularization of its educational application, researchers began to pay attention to how to use 3D printing technology to improve students' spatial ability. This paper describes the preparatory work for the planned actual case study that will be done by the team members of the project iTEM (project of the EHP Funds between TUL and NORD University with the following main goals: researching spatial ability, Mathematikus, 3D printing, and micro:bits) at chosen schools in the Czech Republic, Norway, and Germany. It is planned to find out if at all and in which way the usage of the spatial ability in modelling virtual 3D models as a basis for 3D printing differs with the age of students, next, which aspects of visuospatial activities students use while creating virtual 3D models, and if students are able to construct 3D virtual models according to 2D drawings of the models (Olkun, 2003). The creation of virtual 3D models of 3D objects is an aspect that leads to the creation of physical educational aids that can help weaker students in their learning process and encourage possibilities of using pupils' manipulative activities.

Spatial abilities

Many works deal with spatial ability, and its essential components are also mentioned in them. For example, Braukmann & Pedras (1993), Gardner (2011), and McGee (1985) point out that the visuoabilities

to mentally manipulate, rotate, bend or flip the depicted object are some of the critical aspects of intelligence. Linn & Petersen (1985) define spatial ability as an ability used for representation, generation, transformation, and evocation of symbolic and pictorial facts. They categorized visuospatial ability using three modules: mental rotation (the ability to quickly and precisely turn 2D or 3D objects, to imagine properties of a rotated object afterward it was revolved around an axis by a specific number of angular degrees), spatial perception (the ability to identify the spatial relationships of an object with regard to the orientation of one's own body), and spatial visualization (the ability to manipulate in one's brain with complex spatial data about the object, including the configuration of its individual components). While Maier (1994) uses the division of spatial ability into five components, see Table 1.

Aspects of spatial ability		Description
A1	<i>spatial perception</i>	solvers are demanded to designate spatial relations with regard to the orientation of their own bodies, in spite of distracting information
A2	<i>spatial visualization</i>	the ability to visualize the object and its parts in the space
A3	<i>mental rotation</i>	the ability to rotate the object in the mind
A4	<i>spatial relation</i>	the ability to imagine spatial objects, their parts and their relationships
A5	<i>spatial orientation</i>	the ability to orient oneself in space

Table 1: Aspects of spatial ability according to Maier (1994)

As can be seen from the above, spatial ability is able to be used as a trigger tool in learning and teaching actions in mathematics and geometry, as described by Cruz, et al. (2000). The usage of visual-spatial representations in solving geometric problems conclusively correlates with problem-solving exercise in general, as described by Battista, et al. (1982), van Garderen & Montague (2011), McGee (1985).

With respect to all these given and many other studies, spatial ability can be interpreted as an ability to perform mental transformations of objects in space, imagine how an object looks like when viewed from different points of view, and understand relations among objects and their components to each other.

Many studies show spatial ability is able to be made better and expanded (e.g. Baenninger & Newcombe, 1989, 1995). Practicing spatial ability is a big topic in the current teaching of geometry. It turns out that in recent years, only a few pupils or students are able to create the correct and corresponding visualization of a 3D object according to a planar drawing in their minds. The development of spatial ability seems to be problematic, especially when using online teaching. In this form of teaching, without the possibility of working with real 3D objects, it is necessary to look for other ways to enable students to imagine 3D objects. Given the importance of visuospatial abilities, it is certainly essential to use all available methods to develop these abilities. Today, we are surrounded by modern technologies more than ever before, and therefore it is certainly desirable to use them properly and meaningfully. For example, 3D printing is becoming increasingly popular and promoted today. In this article, we discuss possibilities to develop spatial ability by creating printable files.

Creating a visual model of a cubic solid in Rhinoceros

Spatial models, created specifically either for some topics of mathematics or geometry, or for some specific groups of students, can be created by teachers themselves and, of course, also by the students in various geometric software mentioned above (GeoGebra, Rhinoceros, Thinkercad,...) and then printed on a 3D printer, which is increasingly available today, as well as some of the mentioned

software. In addition to modelling virtual 3D objects in suitable software and the subsequent 3D printing of the created virtual model on a 3D printer, students' spatial ability can be practiced and developed through manipulative activities.

When designing a virtual model of a 3D object in geometric software, various components of the spatial ability are always involved to construct the required virtual model of a 3D object correctly. To characterize more comprehensively the creation of a virtual model of a 3D object, we supplement the above-mentioned Maier's (1994) categorization of spatial ability into five components with the results of the case study of Dilling & Vogler (2021). We chose both studies because they fit very well for the purposes of our planned case study in comparison with the other studies concerning the same topic. They describe eight identified categories of actions **C1** to **C8** of students (Table 2) when working with CAD software. These are related to aspects of visuospatial ability. It describes the processes that are directly related to the development of various aspects of visuospatial ability:

C1	<i>selecting basic solids</i>	Choosing the right basic solid from a number of predefined solids. To select it, a user has to have a good idea of the composition of the resulting object.
C2	<i>changing parameters of solids</i>	Basic parameters (e.g. length, width, height, etc.) of solids can be changed.
C3	<i>changing position of solids</i>	Repositioning solids. A solid changes its position relative to others, which is related to aspects of spatial perception and spatial visualization.
C4	<i>rotating solids</i>	Rotation of solids around either points or axes into asked positions. Good user's spatial perception and mental rotation are necessary for the correct space rotation of a solid.
C5	<i>duplicating solids</i>	This action is related to an aspect of spatial relations, more exactly of copying solids. A user must imagine he needs some solid more than once to create the correct virtual model of a 3D object.
C6	<i>connecting solids</i>	Joining solids using Boolean operators. It is needed especially when modelling objects for 3D printing.
C7	<i>zooming in and out</i>	It is related to the necessity to shrink or enlarge the resulting solid for a better overview of the spatial situation, and the spatial relations by zooming out and zooming in a whole scene. This is directly related to the spatial orientation aspect. This category is needed when modelling objects for 3D printing.
C8	<i>rotating the total view</i>	This action is related to the ability to rotate either the whole scene or the whole object so that the user more easily creates or verifies his solution. Overall object rotation can also help in solving a given task. It relates to the aspects of spatial orientation and mental rotation.

Table 2: Categories of the identified actions according to Dilling & Vogler (2021)

Further, we use Dilling & Vogler's (2021) categorization mentioned in Table 2 and the aspects of spatial ability according to Maier (1994) (see Table 1) for their assignment to the particular steps of creating virtual models of 3D objects, more precisely of cubic solids. Modelling the particular virtual models of cubic solids, a user had to choose a basic solid for their creation (usage of **C1**). The cube is the basic solid in the case of constructing the cubic solids. The cubes are entered using the coordinates of the vertices lying diagonally on one of six faces of a cube and setting the high of the cube. In doing this, the user

- must determine how the particular cube is oriented with respect to the orientation of his own body. It means he must realize the directions of the axes of the Cartesian coordinate system used in the Rhinoceros with respect to the orientation of his own body and consequently, enter the correct

coordinates of the vertices of the modelled cube as well as the appropriate value of the high of the cube. (usage of **A1**)

- is able to visualize the cube together with its parts following correctly the particular steps of setting by entering the required information (coordinates of vertices and high). (usage of **A2**)
- is able to realize if the virtual model of the cube that appeared in the scene of the software corresponds to the model of the cube. It means if the created model satisfies all the properties of a cube. He verifies if the exact part of a spatial object, e.g. the exact face of the cube is in the required position with respect to the reference plane or coordinate system. (usage of **A4**)
- is able to verify if the virtual model of the cube is located in the Cartesian coordinate system as it was mentioned. (usage of **A5**)

There are two possibilities for further modelling the cubic solid virtual model. Once, the user can create the basic solid (the cube) repeatedly. In this case, the user must consider the coordinates of diagonally opposite vertices for each newly created cube. This way is error-prone. Secondly, **duplicating a solid** (the cube; usage of **C5**) is another opportunity. The process of duplicating is the same as in every application. After duplicating an object, both objects are in the same position in the scene. A user can verify the creation of the duplicated object by marking it. Being two objects in one position, their edges/reference curves are lighted in pink colour instead of in a yellow one. No particular aspect of spatial ability is necessary for this step. The duplicated cube must be relocated in the next step. There is a special command for **relocating objects** (usage of **C3**) in the Rhinoceros software. The user should follow the particular steps that appear step by step in the command line of the software. Being relocating the duplicated cubes (see Figure 1), a user has to find out the coordinates of one of the vertices of the newly placed cubes.

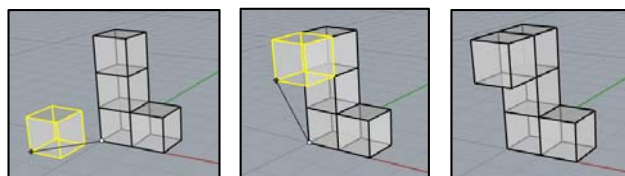

Figure 1: Process of the relocation of the cube in modelling the cubic solid

In relocating a duplicated solid, the user

- realizes the correct relation between the created solids. In the case of the cubic solids, i.e. the placement of the neighbouring cubes. It means, they must touch each other only by their touching faces. It is impossible to one cube is partly situated into a second one. (usage of **A1**)
- is able to visualize the cubic solid together with its unit cubes so that all the unit cubes are situated on their correct positions to create together the required cubic solid. (usage of **A2**)
- is able to imagine the relation of the particular unit cubes in the cubic solid, e.g. to find out parts of their contact (faces, only edges or nothing between the unit cubes of the cubic solid). (usage of **A4**)
- is able to verify how the particular unit cubes of the cubic solid are located in the Cartesian coordinate system. (usage of **A5**)

The Rhinoceros software allows the execution of Boolean operations such as union, intersection, and difference. It means that connecting solids (usage of **C6**) is possible to do in the Rhinoceros. Using the command of Boolean union, the particular unit cubes are united into the compact cubic solid. The user can verify the correctness of the used command by marking the cubic solid. If the edges of only one

cube are in yellow colour (see Figure 2 on the left), the command of the Boolean union didn't work well. All the edges of the compact cubic solid must light in yellow colour. (see Figure 2 on the right)

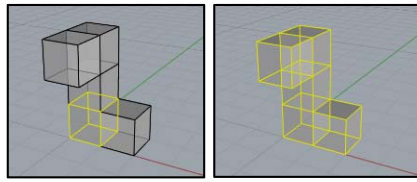

Figure 2: Process of the Boolean union of the unit cubes of the cubic solid

When connecting solids, the user

- realizes and distinguishes if the edges of only some unit cube or of all the unit cubes of the cubic solid are yellow lighted. (usage of **A1**)
- is able to visualize either the particular unit cubes of the cubic solid or the compact cubic solid in the scene of the Rhinoceros software. (usage of **A2**)
- must imagine if the command Boolean union is able to use for uniting the particular unit cubes for formatting the compact cubic solid. E.g. when two unit cubes don't touch themselves anywhere and no other solid is between them, the command Boolean union doesn't work. (usage of **A4**)

When creating the virtual model of the cubic solid, a user can use **zooming in** or **zooming out** (usage of **C7**) or **rotating the whole scene** (usage of **C8**) in the perspective window of the Rhinoceros software. Both mentioned categories are used to overview the parts or the complete constructed virtual model or for taking control of the correctness of the created particular steps of modelling.

Zooming in/out or rotating the total scene, the user

- is able to perceive the constructed virtual model of the cubic solid either in the total overview, in detail, or from various points of view. (usage of **A1**)
- visualizes e.g. a detail of the virtual model for creating small parts belonging to the 3D object, an overview of the virtual model to add some other parts to the scene, or another part of the object that wasn't seen from the starting point of view and is necessary to use it for the further steps of construction. (usage of **A2**)
- can rotate the virtual model of the cubic solid in the perspective scene of the Rhinoceros software and in his mind at the same time. (usage of **A3**)
- can analyze much better the spatial relations of all the parts and the whole created virtual model of the cubic solid with respect to the other created models, to the reference plane, etc. (usage of **A4**)
- is able to orient the virtual model of the cubic solid or its parts in the Cartesian coordinate system set in the Rhinoceros software. (usage of **A5**)

The categories **C2** and **C4** according to Dilling & Vogler (2021) weren't used in the process of creating the virtual model of the cubic solid in the Rhinoceros software. On the contrary, they will be used in setting the virtual model for 3D printing in the PrusaSlicer software.

Setting the visual model for 3D printing in PrusaSlicer

Before inserting the virtual model of the cubic solid onto the virtual printing bed of the PrusaSlicer software, it must be saved in the *.stl file in Rhinoceros. Having inserted the virtual model onto the virtual printing bed, it can be set for 3D printing using various tools of the PrusaSlicer software. The **parameters** of the model can be easily **changed** (usage of **C2**) via setting other percentages of its

original sizes if we realize the printed model will be too small, or vice versa too large (see Figure 3 on the left). Spatial perception (a user perceives the location of the virtual model on the virtual printing bed, the size of the virtual model in comparison to the size of the grid drawn on the virtual printing bed) and spatial visualization (a user visualizes the virtual model on the virtual printing bed; having based on it, he decides if the model is printable without any extra supports) are used in this activity.

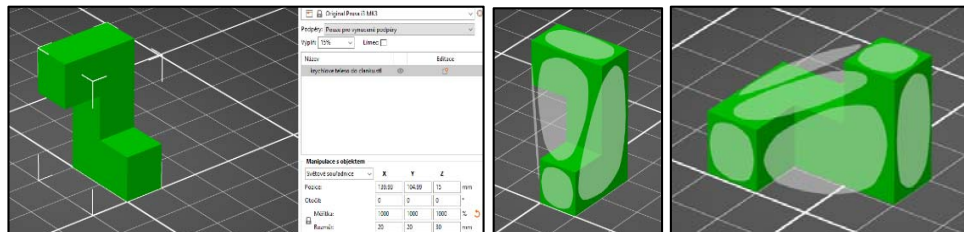

Figure 3: Changing parameters of the model and relocating the model on the virtual printing bed

The suitable location of the virtual model on the virtual printing bed is very important for 3D printing itself. 3D printing of a 3D object takes place in layers when the nozzle of the 3D printer places one layer of molten plastic on the other. Therefore, a user must modify the location of the virtual model on the virtual printing bed especially if the printed 3D object contains "overhangs". Sometimes it is possible to relocate or rotate the virtual model onto the virtual printing bed using the special tool of PrusaSlicer and marking the face of the virtual model onto which the virtual solid should be layn so that "overhangs" disappear in such a position (see Figure 3 in the middle and on the right). Rotation of the cubic solid (usage of **C4**) was done to the model is unproblematically printed on the 3D printer. If we take Maier's (1994) aspects of spatial ability into account, the user is able to

- perceive the inserted virtual model on the virtual printing bed, he realizes its position with the respect to the Cartesian coordinate system and to the grid of the virtual printing bed. (usage of **A1**)
- visualize the inserted virtual model in the position which is the most suitable for the process of 3D printing and set the most appropriate parameters for the virtual model. (usage of **A2**)
- rotate the virtual model of the cubic solid onto the virtual printing bed so that the supports are not necessary to use in 3D printing. (usage of **A3**)
- analyze if the particular cubic solids are located separately without any contact with each other when inserting more than one cubic solid onto the virtual printing bed. (usage of **A4**)
- orient the virtual model on the virtual printing bed in such a way to it is parallel to the 3D printer arm so that 3D printing is of the highest quality. (usage of **A5**)

On the contrary, the rotation of the virtual model is not adequate in some cases. It means there is no chance to rotate the created virtual model of a 3D object into a position in which no overhangs appear. So-called "supports" must be used in such cases. Otherwise, the overhung parts of the 3D object hadn't need to be printed well; a nozzle of a 3D printer could fall in the area of these parts. Consequently, there are two possibilities. A user can let set the supports by PrusaSlicer itself, or he can show the problematic details by drawing where the supports should be added (see Figure 4 on the left). Using the command "Slicing," the software creates the individual layers of a virtual model and adds the supports if they seem to be necessary for safe printing (see Figure 4 in the middle). Having done slicing, a user can take control of the particular layers by using the unique slicer tool of the software (see Figure 4 on the right).

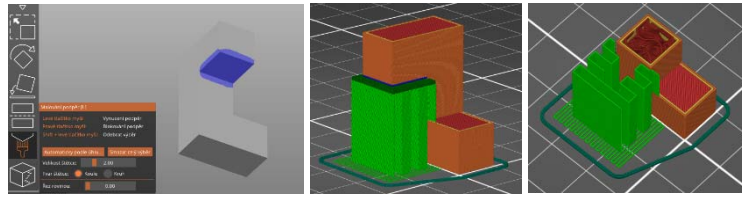

Figure 4: Process of setting supports into overhung parts of the cubic solid

The setting supports is a very responsible activity. If it is poorly done, 3D printing could crash in a better case, or a 3D printer could break down in a worse case. Thanks to that, a user has to use his spatial ability very carefully. Spatial perception and spatial visualization in the meaning of placing a virtual model onto the virtual printing bed in the adequate position are essential for visuospatial abilities as well as spatial relation when realizing whether there will be overhangs and mental rotation due to finding if it is not possible to prevent overhangs by another location of the object. If everything is set well, a user is able to save the created “project” as a so-called *.gcode file by pressing the appeared button. The *.gcode files communicate with 3D printers. So 3D printers reading those files are able to print 3D objects from corresponding virtual models.

Conclusion

Let’s summarize, the attitudes of some researchers toward spatial were briefly described ability. The aspects of spatial ability according to Maier (1994) were mentioned. Categories of the identified actions of students when working with CAD software according to Dilling & Vogler (2021) were clearly written in a table and commented on. We described the creation of the relatively simple virtual 3D model of the cubic solid. By demonstrating its gradual modelling in the software Rhinoceros, we showed that in different steps of modelling, a user must involve various aspects of spatial ability. We have listed these aspects at each step and described them relating to the specific actions taken in each step. At the same time, we took over the relevant actions according to the categorization performed by Dilling & Vogler (2021). We found that in modelling the virtual 3D model of the cubic solid in the software Rhinoceros, six of eight activities mentioned by Dilling & Vogler (2021) were used. The remaining two activities can be used during the virtual setup of the 3D printed model in the PrusaSlicer software. The creation of a virtual 3D model of a 3D object in the software Rhinoceros and the setup of this virtual 3D model for 3D printing in the PrusaSlicer software themselves, e.g. according to a 2D drawing of the 3D model, affords users to develop their spatial ability. Students must transfer the 2D mapping of the 3D objects into the 3D scene of the software which helps to develop their spatial ability. We tested the modelling of cubic solids as parts of the so-called soma cube with students in the third year of the bachelor's cycle of the study program Mathematics for Education within the teaching of the course Geometric Software at TUL. Most of the students did make use of their spatial ability without any significant difficulty, even in the case when each of the students modelled their own cubic solids as part of the soma cube. One of the reasons could be the fact that they created the individual parts of the soma cube and their automatic com- and decomposition into soma cube in a dynamic applet in the freeware GeoGebra some weeks ago. More concrete details on findings of the suggested model in engaging students with spatial ability will be described after finishing the sharp testing of the model.

Our goal for the future is to use a case study to find out whether and how the use of the spatial ability in modelling virtual 3D models as a basis for 3D printing differs with the age of students, next, which

aspects of visuospatial activities students use while creating virtual 3D models, and if students are able to construct 3D virtual models according to 2D drawings of the models.

Acknowledgment

This contribution was created as one of the outcomes of the project iTEM (Improve Teacher Education in Mathematics), EHP-CZ-ICP-2-018.

References

- Baenninger M., & Newcombe N. (1995). *Environmental input to development of sex-related differences in spatial and mathematical ability*. *Learning and Individual Differences*, 363–379.
- Baenninger M., & Newcombe N. (1989). *The role of experience in spatial task performance a meta-analysis*. *Sex roles* 20, 327–343.
- Battista, M. T., Wheatley G. H. & Talsma G. (1982). *The importance of spatial visualization and cognitive development for geometry learning in pre-service elementary teachers*, *Journal for Research in Mathematics Education*, pp. 332–340. ISSN 0021-8251.
- Braukmann, J., & Pedras, M. J. (1993). *Comparison of two methods of teaching visualization skills to college students*, *Journal of Industrial Teacher Education*, pp. 65–80. ISSN 1938-1603.
- Cruz, I., Febles, M. & Díaz, J. (2000). *Kevin: a visualiser pupil*. In *For the Learning of Mathematics*, pp. 30–36.
- Dilling, F., & Vogler, A. (2021). *Fostering Spatial Ability Through Computer-Aided Design: A Case Study*. *Digital Experiences in Mathematics Education* 7, pp 323–336.
- Gardner, H. (2011). *Frames of mind: The theory of multiple intelligences*. New York, Basic books.
- van Garderen, D., & Montague, M. (2003). *Visual-Spatial Representation, Mathematical Problem Solving, and Students of Varying Abilities*. *Learning Disabilities Research & Practice*, 18(4), 246–254. <https://doi.org/10.1111/1540-5826.00079>.
- Linn M. C., & Peterson A. C. (1985). *Emergence and characterization of sex differences in spatial ability: a meta-analysis*. *Child Development*, 56, 1479–1498.
- Maier, P. (1994). *Räumliches Vorstellungsvermögen: Komponenten, geschlechtsspezifische Differenzen, Entwicklung und Realisierung in der Realschule*. Frankfurt am Main, Germany: Peter Lang.
- McGee, M. G. (1985). *Human spatial abilities: Psychometric studies and environmental, genetic, hormonal, and neurological influences*. In *Psychological Bulletin*, pp. 889–918. ISSN 0021-8251.
- Olkun, S. (2003). *Making connections: Improving spatial abilities with engineering drawing activities*. *International Journal of Mathematics Teaching and Learning*, 3(1), pp. 1–10.
- Samsudin, K., Rafi, A., & Hanif, A. S. (2011). *Training in Mental Rotation and Spatial Visualization and Its Impact on Orthographic Drawing Performance*. In *Educational Technology & Society*, 14 (1), pp. 179–186.
- Wang, L., et al. (2021). *Promoting Junior School Students' Spatial Ability through 3D Printing*. In *Tenth International Conference of Educational Innovation through Technology Proceedings, IEEE, China*, pp. 100–105. doi:10.1109/EITT53287.2021.00028

Teacher's recommendations for distance learning compared to student's actual use of digital textbooks and other (digital) resources

Maxim Brnic and Gilbert Greefrath

University of Münster, Germany; m.brnic@uni-muenster.de, greefrath@uni-muenster.de

The Covid-19 pandemic led to school closures and often to asynchronous learning. The study presented here focuses on students in upper secondary school. In particular, it is of interest which analogue and digital curriculum resources the students used to learn mathematics in distance learning and to what extent their resource system differed from the teachers' recommendations. We compare students who had access to a specific digital mathematics textbook to those who did not. Because we consider this digital textbook to be particularly suitable for asynchronous and distance learning and because it addresses challenges faced by teachers, this comparison is of special interest. However, the results of the study show that students are more likely to use printed materials and that learning videos and worksheets also are of crucial relevance.

Keywords: Digital curriculum resources, distance education, digital textbooks.

Introduction

The Covid-19 pandemic caused school closures and thereby distance learning in many countries. Teachers and students had to adjust to such a classroom situation, relying in particular on technology to support learning and teaching. What influence this had on mathematics education is indicated by first studies (e.g., Aldon et al., 2021; Brnic & Greefrath, 2022; Drijvers et al., 2021). Investigating such experiences and practices is relevant not only because of the specifics of mathematics education, for example, the use of specific representations and its focus on interaction and reinvention (Drijvers et al., 2021), but also for future (technology-enhanced) teaching and learning formats. In the previous studies, especially teachers and their actions in distance mathematics education were focused on. In contrast, this study investigates to what extent students implemented the teachers' recommendations for distance learning. Since asynchronous teaching formats were often implemented during distance learning in Germany (Drijvers et al., 2021), it can be assumed that students were often encouraged to work self-directed. Based on a questionnaire, it is explored which analogue and digital curriculum resources the students actually used to learn mathematics. Since we consider a digital textbook with integrated digital tools to be particularly suitable for distance learning (Brnic & Greefrath, 2022), it is of special interest to what extent such a digital resource was integrated into distance learning.

Students' use of (digital) curriculum resources and distance education

Curriculum resources can be defined as "all the material resources that are developed and used by teachers and students in their interaction with mathematics in/for teaching and learning, inside and outside the classroom" (Pepin & Gueudet, 2018, pp. 1–2). These can be digital as well as analogue printed materials that partially or fully represent the content and learning objectives from the curriculum, e.g. (digital) textbooks or worksheets (Pepin & Gueudet, 2018; Rezat et al., 2021). Thus, digital curriculum resources are also distinguishable from digital instructional tools, e.g., dynamic geometry software such as GeoGebra, whereby such digital tools can be part of the digital curriculum

resources (Pepin et al., 2017). Teachers and students do not use just one resource, but a system of analogue and digital resources. When using resources for learning, students are teacher-oriented, but eventually act independently (Rezat et al., 2021) and therefore their use may differ from the teacher's recommendations. The ways of using and interacting with the curriculum resources are influenced, among other factors, by the students' beliefs and prior knowledge (Cai & Howson, 2013; Rezat et al., 2021). In times of school closures during the pandemic and with regard to asynchronous learning formats, which seem to be more common in Germany compared to some other countries (Drijvers et al., 2021), the curriculum resources used at home for self-directed learning of mathematics can be assigned a considerable importance. However, which resources and tools were actually used for mathematics teaching and learning has been investigated mainly from the perspective of teachers in previous studies (e.g., Aldon et al., 2021; Drijvers et al., 2021). For example, in the interaction between teacher, student and resource, the challenges teachers face (Aldon et al., 2021) or the tools teachers used to deliver mathematics lessons before and during the lockdown were investigated (Drijvers et al., 2021). Findings from this research indicate that teachers found it challenging to choose appropriate analogue and digital resources and tools to support students during distance learning, while they were keen to maintain continuity with their previous teaching practices (Aldon et al., 2021). Furthermore, Drijvers et al. (2021) point out that they used fewer mathematics-specific tools, such as mathematics-specific learning environments or exercise platforms, than before. The explicit role of the (digital) textbook, which is the key resource in a set of resources (Pepin & Gueudet, 2018; Rezat et al., 2021), has been neglected in the research on distance education so far. We assume that a digital textbook with interactive features can help while distance learning, as it addresses the challenges of distance education, e.g. communication problems or giving feedback (Aldon et al., 2021), and can contribute to the learning success of the students (Brnic & Greefrath, 2022). Based on the literature review and the challenges of asynchronous and distance learning, the following research question is of particular interest: *Which analogue and digital curriculum resources were recommended to the students by their teachers during distance learning for learning mathematics and which ones did they actually use?* Students who had access to a digital textbook with integrated digital tools and those who did not have access to this resource will be compared.

Method

In the KomNetMath project, the digital mathematics textbook *Net-Mathebuch* (m2.net-schulbuch.de) is made accessible as a digital resource to German upper-level mathematics courses for one school year. This digital textbook contains digital tools, e.g. GeoGebra is integrated, and covers many of the theoretical potentials of a digital mathematics textbook (Brnic & Greefrath, 2022). In addition to this digital textbook, however, teachers and pupils are still allowed to use their previous resources, i.e., their printed textbook. In order to gain an insight into the actual use of the digital textbook and its affective effects, the students participating in the project fill in questionnaires regularly during the school year. The questionnaire for the end of the school year 2019/20 was enriched with items related to school closures and distance learning. The data analysed in this paper is gained from the two (translated) items: "During the school closures due to the COVID-19 pandemic, what media did your teacher *recommend* for you to study for your mathematics lessons?" and „During the school closures caused by the COVID-19 pandemic, what media did you *use* to study for your mathematics lessons?"

The term "media" was used in the questionnaire because we assumed that the students would understand it better than the term "resource". The students could select several answer options in a multiple-response format (see the options in Figure 1). In May/June 2020, 88 (46 female, 40 male, 2 non-binary) students from different schools participating in the project completed the digital questionnaire. The students are in upper secondary school and have an average age of $M = 16.39$ ($SD = .68$). Most of these students use the digital textbook at home on tablets (35 %), followed by notebooks (23 %) or smartphones (23 %). In addition, 44 (31 female, 12 male, 1 non-binary) students with an average age of $M = 16.23$ ($SD = .77$) completed the questionnaire representing a comparison group who did not have access to the digital textbook as a resource.

Results

Figure 1 shows the item results for the group that had access to the digital textbook (DTG) and for the comparison group (CG) that did not have access to the digital textbook Net-Mathebuch during the school year.

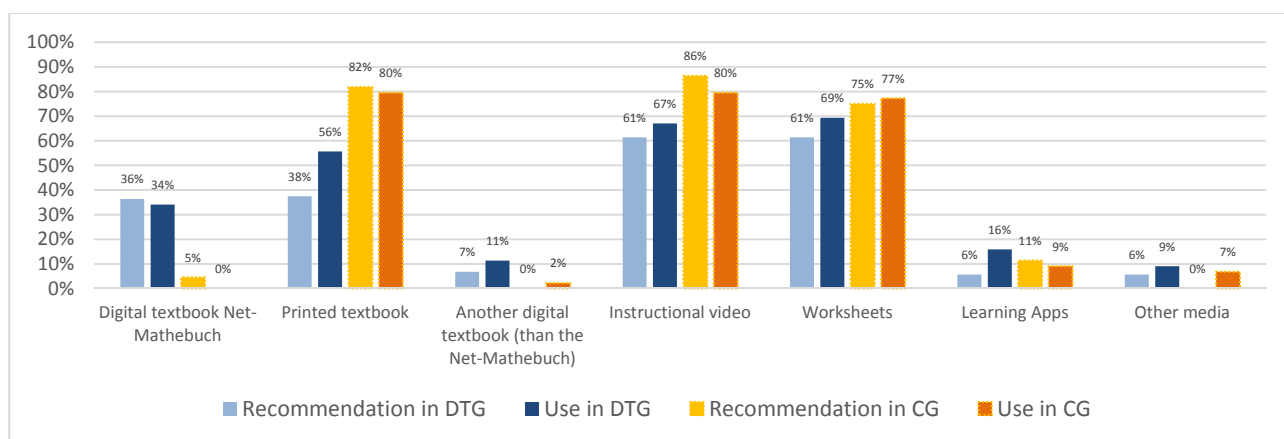

Figure 1: Comparison of actual student use and teacher recommendations in both research groups

The largest difference between the actual use and the recommendation is found in the use of the printed textbook with 18% in the DTG and in the CG with the explanatory videos and other media with 7% each. Further analyses regarding textbook use show that 30% of the students in the DTG and 20% in the CG have not used a textbook at all.

Discussion

The results indicate that students often follow the teachers' recommended resources for learning mathematics. This is particularly evident concerning the results in CG, where there are only small percentage differences between teachers' recommendations and the actual use. In contrast, noticeable differences can be found in the DTG, especially since the printed textbook was used more often than expected based on the recommendations. Reasons could be that similar to teachers (cf. Aldon et al., 2021), students also want to maintain continuity in their learning and thus tend to use the more familiar printed textbooks rather than the digital textbook introduced for these students in that school year. It is also possible that the use of curriculum resources is also influenced by the students' beliefs and prior knowledge (Rezat et al., 2021). However, no statements can be made in this study about the purposes and frequencies of the use of the individual resources. Also, these are only students' self-

reports from a small sample and students may adjust their reported use to conform to the teacher's or researcher's expectations. Although the textbook is considered a key resource of a resource system (Pepin & Gueudet, 2018; Rezat et al., 2021), a considerable part of the students did not use it at all. It is possible, for example, that for learning the required subject matter the teacher's notes are rated more relevant than the textbook. We would also have expected a greater use of the digital textbook with its integrated tools, as we consider it beneficial for distance learning formats (Brnic & Greefrath, 2022). Possibly, however, it was not apparent to the students and teachers at that time to what extent the digital textbook can be supportive in the teaching and learning process. It is also noticeable that in addition to the textbook, instructional videos and worksheets were recommended and relied on to a substantial extent. In summary, the results show that students develop and use a system of digital and printed curriculum resources (Rezat et al., 2021), which can deviate from the recommendations of the teachers. The students must therefore be understood as independent actors with regard to the analogue and digital curriculum resource use. This shows that in studies on distance learning and asynchronous learning formats, students' and teachers' perspectives should be taken into account, as well as that more research is needed in this area.

References

- Aldon, G., Cusi, A., Schacht, F., & Swidan, O. (2021). Teaching Mathematics in a Context of Lockdown: A Study Focused on Teachers' Praxeologies. *Education Sciences*, 11(2), 38. <https://doi.org/10.3390/educsci11020038>
- Brnic, M., & Greefrath, G. (2022). *Distance learning versus face-to-face classroom learning: Student achievement in conditional probability when using a digital textbook with integrated digital tools* [Manuscript submitted for publication]. CERME12, Bozen-Bolzano, Italia.
- Cai, J., & Howson, G. (2013). Toward an International Mathematics Curriculum. In M. A. (Ken) Clements, A. J. Bishop, C. Keitel, J. Kilpatrick, & F. K. S. Leung (Eds.), *Third International Handbook of Mathematics Education* (pp. 949–974). Springer. https://doi.org/10.1007/978-1-4614-4684-2_29
- Drijvers, P., Thurm, D., Vandervieren, E., Klinger, M., Moons, F., van der Ree, H., Mol, A., Barzel, B., & Doorman, M. (2021). Distance mathematics teaching in Flanders, Germany, and the Netherlands during COVID-19 lockdown. *Educational Studies in Mathematics*, 108(1–2), 35–64. <https://doi.org/10.1007/s10649-021-10094-5>
- Pepin, B., Choppin, J., Ruthven, K., & Sinclair, N. (2017). Digital curriculum resources in mathematics education: Foundations for change. *ZDM*, 49(5), 645–661. <https://doi.org/10.1007/s11858-017-0879-z>
- Pepin, B., & Gueudet, G. (2018). Curriculum Resources and Textbooks in Mathematics Education. In S. Lerman (Ed.), *Encyclopedia of Mathematics Education* (pp. 1–5). Springer International Publishing. https://doi.org/10.1007/978-3-319-77487-9_40-7
- Rezat, S., Fan, L., & Pepin, B. (2021). Mathematics textbooks and curriculum resources as instruments for change. *ZDM – Mathematics Education*, 53(6), 1189–1206. <https://doi.org/10.1007/s11858-021-01309-3>

Using and designing digital mathematical resources: teachers' beliefs on their professional needs

Roberto Capone and Eleonora Faggiano

University of Bari Aldo Moro, Department of Mathematics, Italy; roberto.capone@uniba.it,
eleonora.faggiano@uniba.it

This study was developed within an ongoing research project aiming at identifying innovative methodologies and technologies to design and use digital resources supporting mathematics education through the engagement of teachers, researchers and software developers in the collaborative design of a mathematical digital serious game. In this paper, we present and qualitatively discuss, using the Technological Pedagogical Content Knowledge as a theoretical lens, the early results of an initial survey, involving eight teachers. It aims to investigate their beliefs on the use of digital resources in mathematics education and the professional needs for teaching mathematics in the XXI century. With respect to their involvement in the following collaborative design of a mathematical digital serious game, we also investigated their beliefs regarding their potential contribution to such an activity.

Keywords: Collaborative design of digital resources, Technological Pedagogical Content Knowledge, Teachers' beliefs on the use of technology, Mathematical digital serious games

Introduction

The teacher profile required in the Digital Age is an integrated and harmonious combination of several kinds of knowledge and competencies: cultural and disciplinary, psycho-pedagogical, didactic-methodological, and technological. Moreover, one of the key elements of effective teachers' professional development in the XXI century is to bring them out of the isolation they find themselves in by integrating them into a context of continuous training in which they are protagonists (Borko & Potari, 2020). The study that we present in this paper was developed within an international research project MaTIn4MER –Methodological and Technological Innovations For Math Education Resources– based on the collaboration between the scientific world, the productive world, and the school world, to design and experiment with a mathematical digital serious game. We refer to mathematical digital serious games as digital educational games that can foster competition and achievements thanks to the mechanism of games, such as leader boards, point systems, badges, challenges, and up-leveiling. They have been chosen as specific objects of research due to their potential to encourage better emotional dispositions toward mathematics and improve its teaching and learning (Capone & Faggiano, in press). Thanks to the software developers' and teachers' collaboration in the project, researchers aim to elicit guidelines to train teachers in integrating this kind of new technology in the mathematics classroom. The main hypothesis of the project is that to create a framework for developing innovative products and the related guidelines for teachers' training, it is important to directly involve teachers themselves. Moreover, being beliefs contextually significant to the implementation of any innovations, to understand how teachers might deal with digital serious games, it is important to first understand their beliefs. In this study, we refer to teachers' beliefs broadly as those tacit, often unconsciously held assumptions about students, tools

and content to be taught, their professional needs and their potential contribution to designing and experimenting with a mathematical digital serious game. A small group of teachers, called “pilot teachers”, were invited to complete an anonymous online questionnaire with the aim to investigate their beliefs on the use of digital resources in mathematics education, and their professional needs for teaching mathematics using a digital serious game. Through the lens of the Technological Pedagogical Content Knowledge (TPACK), in this paper, we present and qualitatively discuss the early results of this initial survey administered and analyzed with the aim to answer the following questions: a) What are the pilot teachers’ beliefs of their professional needs with respect to the use of digital resources in mathematics education? b) What are the pilot teachers’ beliefs of their potential role in the collaborative design of a digital mathematical serious game to experiment with in their classes?

Theoretical Framework

As far as it concerns the complexity of the integration of technologies into teaching practices, we refer to the framework of the Technological Pedagogical Content Knowledge (Mishra & Koehler, 2006) to build the survey and analyze the resulting data. With his Pedagogical Content Knowledge model, the educational psychologist Lee Shulman (1986) emphasized with his seminal work the need for teachers to combine disciplinary knowledge with appropriate pedagogical strategies to achieve quality teaching. About twenty years later, Mishra and Koehler (2006) proposed integrating a third element: technological competency. The Technological Pedagogical Content Knowledge (TPACK) model suggests that, as with content and pedagogy before, technology should not be introduced into the educational context as a stand-alone element but as a component of a broader scenario: it is the integration of these different domains that supports the teacher in teaching a subject with the support of technology (Niess, 2005). In our case, according to Mishra and Koehler, Pedagogical Content Knowledge (PCK) is concerned with the structure, organization, management, and teaching strategies for how mathematics is taught. Technological Content Knowledge (TCK) is related to how mathematics is represented in technology-rich environments. Teaching with technology requires knowing the mathematics and how mathematics can be changed with the application of technology, and this knowledge is called TCK. Technological Pedagogical Knowledge (TPK) is concerned with how teaching and learning change with the integration of technology and how a teacher should be able to choose a particular tool for a specific task considering its affordances and limitations. This framework helps us to investigate how teachers are faced with the challenge to integrate the three knowledge domains. Looking at the survey results through the lens of the TPACK, hence, can help identify teachers’ beliefs on the use of digital resources in mathematics education and their professional needs for teaching mathematics in the XXI century also using a digital serious game.

Methods

The study uses the survey technique and the questionnaire as an explorative tool, consistent with the aims of the investigation. The questionnaire, anonymous and semi-structured, was composed of three sections: Section A contains questions concerning teachers’ data (to gain characterization of their profiles); Section B contains open questions concerning teachers’ technological, pedagogical and content knowledge; Section C contains open questions concerning teachers’ beliefs about digital

serious games and teachers' potential contribution to the collaborative project involving schools, universities, and companies. A small group of mathematics secondary teachers, with a known bent on didactical innovations and a willingness to experiment with new educational solutions, were invited to join the project. Eight of them, to whom we refer as "pilot teachers", voluntarily decided to answer the questionnaire. The questionnaire was administered in Italian and, together with the answers given by teachers, was translated by the authors. Results analysis is performed based on the teachers' answers to the questionnaire, taking into account the TPACK model. In what follows we will mainly focus on the descriptive analysis of some of the answers given to Sections B and C.

Results

One of the first questions asked to teachers in Section B, was the following: "What difficulties do you think one might encounter when designing and developing a mathematics lesson using ICT somehow?" The answers reveal the need for designing and implementing effective teaching experiences integrating technology and, therefore, the need for pre-service and continuous training. For instance, T2 and T3 respectively answered: "It requires time and attention beyond the classroom. It requires constant training because technologies are always evolving. It is not easy to stay one step ahead of your students who are digital natives"; "it would be necessary to have adequate tools (both theoretical and practical) to use them correctly". Some open questions were more specific about the knowledge required to be a teacher in the XXI century school. Here we focus on the following: 1) "What technological knowledge do you think the teacher should have?"; 2) "What pedagogical knowledge do you think the teacher should have?". Some teachers referred exclusively to technological knowledge without focusing on technologies for teaching mathematics. T6, for example, answered: "They should know how to use the PC, the Interactive Whiteboard (IWB), and the tablet. They should be familiar with teaching and assessment applications in a more evolved way." Others highlighted the relationship between different kinds of knowledge: "I think that technological competencies can act as a framework for other knowledge that the teacher must have, such as knowledge of subject content and the methodologies for teaching this content. Technological competencies alone are of little use". From the questions in Section C, that dealt with digital serious games, emerges the teachers' interest to learn how to integrate them into their teaching. They thought that a serious game can be a supporting tool for more traditional teaching and a stimulus for students and teachers, but it must be instrumental to the teaching goals. To the question "what contribution do you think you can bring to the design of a serious game?" T2, for example, answered: "Teaching experience, knowledge of the discipline for correct implementation of the game". Finally, according to their answers, teachers believed that they could benefit greatly from both the research and the productive world that can help them reflect and rethink how they teach.

Discussion

According to the answers to the questionnaire, all teachers agreed that technologies support the teaching and learning of mathematics, but also that it would be necessary to have adequate knowledge. They referred to the need to have what, in agreement with the TPACK model we have called Technological Pedagogical Knowledge (TPK). Although they did not mention the specific technological and pedagogical knowledge that might be needed to teach mathematics using

technology, they also highlighted the need for more comprehensive knowledge, integrating technological, content, and pedagogical aspects, to improve the effectiveness of mathematics teaching and learning when using digital resources. Moreover, if, on the one hand, teachers felt the need to acquire new technological and pedagogical knowledge, on the other, they thought they can actively contribute to the design of a mathematical digital serious game by bringing their experience in terms of pedagogical content knowledge and assisting the researcher and the software developers in focusing on some unthought scenarios. Finally, teachers' beliefs about their potential role in the collaborative design of a digital mathematical serious game to experiment with in their classes confirm our hypothesis concerning the importance of the direct involvement of teachers in the project.

Conclusions and further developments

This paper describes the preliminary study of a wider international project, that stems from the intersection of expertise from the technological, productive world, the academic world, and the world of education to identify innovative methodologies and technologies to design and use digital resources, such as serious games, supporting mathematics education. The project's initial phase aimed to involve a small group of pilot teachers in sharing a common base to collaboratively design and implement a digital mathematical serious game. This required conducting a survey to investigate teachers' beliefs concerning the use of technological resources in mathematics education, their professional needs with respect to this use, and their awareness of the importance and effectiveness of their contribution in the design and experimentation of a digital mathematical serious game. It emerged that the intersection of technological, methodological, and pedagogical competencies consistently responds to their professional needs with the TPACK theoretical framework. In the next phase of the project, we will further study how the intersection of knowledge and experience derived from multiple actors could give rise to the identification of shared innovative methodologies and technologies to design and use mathematical digital serious games.

References

- Borko, H. & Potari, D (Eds.) (2020). *Proceedings of the 25th ICMI Study Teachers of Mathematics Working and Learning in Collaborative Groups*. National and Kapodistrian University of Athens.
- Capone R. & Faggiano E. (in press) Teachers as key players: from professional development to the design and use of digital resources and backward, In *Proceedings of the Third Workshop on Technology Enhanced Learning Environments for Blended Education*, Foggia, Italy.
- Mishra, P., & Koehler, M. (2006). Technological pedagogical content knowledge: A framework for teacher knowledge. *Teachers College Record*, 108, 1017–1054. doi:10.1111/j.1467-9620.2006.00684.x
- Niess, M. L. (2005). Preparing teachers to teach science and mathematics with technology: Developing a technology pedagogical content knowledge. *Teaching and Teacher Education*, 21(5), 509-523. doi:10.1016/j.tate.2005.03.006
- Shulman, L. S. (1986). Paradigms and research programs in the study of teaching. In M. C. Wittrock (Ed.), *Handbook of Research on Teaching* (pp. 3-36). MacMillan.

Characterising paraboloids using Augmented Reality

Roberto Capone¹, Mario Lepore² and Federica Mennuni¹

¹University of Bari, Department of Mathematics, Italy; roberto.capone@uniba.it,
federica.mennuni@uniba.it

²University of Salerno, Department of Mathematics, Italy; marlepore@unisa.it

In this paper we describe a teaching sequence concerning the characterisation of paraboloids and involving the use of GeoGebra Augmented Reality. The teaching sequence, framed by Marton's Variation Theory and taking into account Duval's theory of semiotic representations, was experimented with involving thirty undergraduate and master's students in mathematics. It was designed with the aim of exploiting Augmented Reality to facilitate the transition between different semiotic representations. The results showed how students characterised paraboloids through treatments and conversions made on the registers of semiotic representations and how they related the observations that emerged during the experimental stages by going through the sequence of patterns of variation following Marton's Variation Theory.

Keywords: Augmented Reality, Paraboloids, Variation Theory, Semiotic representation.

Introduction

One of the difficulties in learning mathematics is the conceptualisation based on meanings referring to a concrete reality (Duval, 1993). The conceptual learning of any object has to go through the learning of one or more semiotic representations (Godino and Batanero, 1994). On the one hand, every mathematical concept uses representations because there are no “objects” to exhibit. Thus, conceptualisation needs to go through representative registers. On the other hand, the management of representations is complex because of the lack of concrete objects to relate the representations in their production and transformations. These difficulties are found not only in primary students, as research in Mathematics Education shows (Duval, 1993), but some of them are also encountered by secondary school students and university students. Many studies show how meaningful use of technologies, including Augmented Reality (AR), can help overcome some of these difficulties (Cahyono et al., 2020; Capone and Lepore, 2020). Since the relationship between experience and conceptualisation is at the basis of learning processes in the educational field, it becomes central to understand how the presence of digital artefacts impacts the process of educational mediation, modifying both the artefacts and the awareness that users have of them. In the area of Mathematics Education, recent studies (Aldon et al., 2019) have highlighted how visual-kinaesthetic activities can help students to experience multiple levels of sophistication and develop the multiple meanings of covariational reasoning (Swidan et al., 2019). In this research, we investigated whether the use of GeoGebra AR (Tomaschko and Hohenwarter, 2019) can facilitate students in conceptualising a mathematical object by easing the transition between different forms of semiotic representations. For this purpose, we carried out a teaching sequence with thirty undergraduate and master's students in mathematics using GeoGebra AR, which was framed by Marton's Variation Theory (Marton et al., 2004). The choice of designing a teaching sequence that exploits the potential of GeoGebra AR comes from considering the fact that this digital tool, also accompanied by the dynamic geometry software GeoGebra 3D,

allows students to visualise 3D graphs and objects in real environments. Moreover, thanks to GeoGebra AR, students can connect the real world with the abstract world of mathematics, making explicit the connections between these two worlds, which with 3D software alone appear to be disconnected. In particular, GeoGebra AR allows students to model 3D objects, manipulating any surface with appropriate tools. Therefore, we focused on the use of GeoGebra AR to help students to conceptualise the idea of paraboloids through the transition between different registers of representation, from the graphical to the analytical and vice versa.

Theoretical Framework

As we are interested in fostering students in conceptualising the mathematical objects involved by exploiting the transition between different semiotic registers, Duval's theoretical framework of semiotic representations in our research leads us in reading and interpreting our findings. The lens offered by Marton's Variation Theory allows us to design a teaching sequence thanks to which students were guided to study paraboloids through appropriate variations of the characteristics of these mathematical objects exploiting the potential offered by the GeoGebra AR environment.

Students' difficulties with mathematics comprehension depend on mathematical processes and cognitive functioning underlying them and from the various registers of semiotic representations (Duval 2006). In his paper, Duval (2006) indeed states that understanding a mathematical concept presupposes the coordination of at least two semiotic representation registers. Therefore, passing from one representation to another is crucial for understanding mathematical concepts. The main activities of semiotic representations are treatments and conversions. According to Duval (2006), treatments are representations transformations within the same register: "the treatments, which can be carried out, depend mainly on the possibilities of semiotic transformation, and the semiotic register of representation used" (p. 111). Moreover, conversions are representation transformations that consist of changing a register without changing the objects denoted: "conversions [...] are more complex than treatment, as any change of register requires the recognition of the object [...]. However, conversion stimulates understanding of mathematical concepts from a cognitive point of view" (p. 112). Thus, the coordination of semiotic registers, the ability to handle multiple representations of the same concept, and the ability to pass from one to the other are necessary for achieving the ability to identify a concept with one of its representations.

The main idea at the basis of Marton's Variation Theory concerns the means by which students can be helped to handle in powerful ways novel situations which emerge during teaching-learning processes in mathematics (Marton and Pang, 2006). Indeed, the Variation Theory describes the dynamic process of student learning as a controlled experiment in science, in which the scientist can vary one variable and observe how another variable changes accordingly (Marton et al., 2004). Thus, the learning process cannot occur until students have experienced variation. Consequently, assuming that teaching with variations in a controlled and systematic way helps students to construct mathematical concepts, the Variation Theory is based on the assumption that in varying teaching situations, students should be stimulated during their learning processes by taking into account the sequence of four patterns of variation (Marton et al., 2004):

to experience something, we must experience something else to compare with it (contrast); to fully understand what "three" is, we must also experience the varying appearance of three (generalization); to experience a certain aspect of something, and to separate this aspect from other aspects, it must vary while other aspects remain invariant (separation); if there are several aspects that the learner has to take into consideration at the same time, they must all be experienced simultaneously (fusion) (p. 16).

Research question

In this paper, we intend to investigate how AR fosters students' transition between the different registers of semiotic representation to conceptualise the mathematical objects involved. Starting from the theoretical background of the chosen frameworks, with our research, we aim at answering the following research question: how can the transition between different semiotic registers of representation through the use of the GeoGebra AR foster students' conceptualisation of paraboloids?

Methods

This research methodology is characterised by direct observation of the participants and a further interpretation of videos, which allowed us to go into detail about verbal (discursive exchanges, oral reflections), non-verbal, proxemic, and interactional codes. Thirty undergraduate and master's students in mathematics were involved in a teaching activity, concerning paraboloids and their characterisation, based on the use of the dynamic geometry software GeoGebra 3D and GeoGebra AR. The combined use of these two software guides students in the transition between different registers of semiotic representation (2D and 3D graphs, algebraic expressions, equations) to conceptualise the mathematical objects at stake by exploring their mathematical characteristics. The teaching activity started with a preliminary task, and then it was developed through a sequence of tasks characterised by cycles of work in small groups and successive collective discussions. The authors have designed and experimented with the preliminary task and the following sequence of tasks. During the group work, students were asked to observe and discover some characteristics of paraboloids through the transition within the same semiotic register or from one semiotic register to another. Their written answers are part of the collected data. All the activities were video-recorded and transcribed. Data were analysed through Duval's Theory of semiotic representations and Marton's Variation Theory to highlight both treatments and conversions performed by the students and the patterns of variation that students create while using GeoGebra AR to conceptualise and characterise paraboloids.

Description of the tasks

In the preliminary task, students were asked to associate a corresponding surface with some level curves and to argue their answers; they were also asked to associate a list of equations with the corresponding surface without using any technological tools and to argue their answers. Three tasks, carried out using GeoGebra 3D and GeoGebra AR, then characterise the teaching sequence:

1. *Moving from the graphical representation of level curves to the graphical representation of the surface (treatment).* Students were asked to move a slider k and observe the shape of the level curves. Furthermore, they were asked to find the connection between the level curves and the surface.

2. *Moving from the different representations of level curves to the analytical representation of the surface (conversion).* Students were asked to move slider k and compare different level curves. Furthermore, they were asked to find the analytical representation of the paraboloid.
3. *Moving from variations on parameters a and b of the surface equation to the characterization of paraboloids.* Students were asked to consider the equation $z = ax^2 + by^2$ and to vary, both on GeoGebra 3D and GeoGebra AR files, the parameter a while leaving b fixed through a slider. They were asked to observe and describe how the characteristics of the surface vary as the parameter changes. Next, the students were asked to use another slider to vary parameter b , leaving a fixed, and observe how the surface's characteristics vary as b varies.

The first task aims to highlight the contrast pattern as a possible variation pattern of Marton's theory. The second task aims to reveal the contrast and a first generalisation patterns. Indeed, in order to find the equation of the surface in 3D, the variable z must be no longer constant. Moreover, since the surface characteristics in 3D (i.e., both its graphical representation and its level curves) change as both a and b vary (changes that are also clearly visible with the graphical representation obtained by GeoGebra AR), with the third task, students can experiment with the pattern of separation by comparing the two different situations. Finally, the fusion pattern can emerge in the last phase of the teaching sequence when students are asked to simultaneously vary parameters a and b and describe what happens concerning these variations.

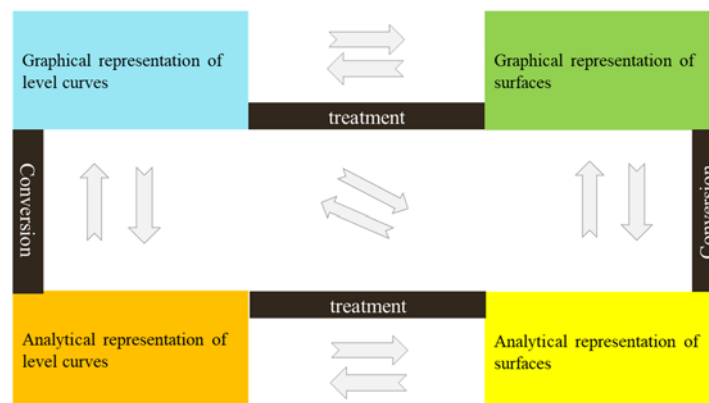

Figure 1: Activities scheme of treatments and conversions

Figure 1 shows the phases of the teaching sequence, highlighting, in tune with Duval's approach on the registers of semiotic representations, the transitions between different representations in terms of treatment and conversion. In particular, the first activity can be regarded as a treatment since, with respect to its description, it allows us to connect the "graphical representation of level curves" to the "graphical representation of surfaces". The second task represents a conversion from the "graphical representation of level curves" to the "analytical representation of surfaces". But, from Figure 1, it is possible to realise that the second task can also be regarded as a treatment from the "analytical representation of level curves" to the "analytical representation of surfaces", passing from the conversion bringing the "graphical representation of level curves" into the "analytical representation of level curves". This is because the second task was designed to foster students to consider different representations of level curves that more easily allowed them to deduce the analytical representation of the surface. Finally, the third task can be described through a "reverse" conversion from the

“analytical representation of surfaces” to the “graphical representation of surfaces”. In fact, through observing the changes in the parameters a and b of the surface equation, it is possible to foster students in characterising the different surfaces that are obtained through observations on the corresponding changes in the different graphical representations that are displayed in 3D space on the GeoGebra AR environment.

Results and Discussion

To answer our research question, we will analyse the video recordings and transcripts obtained from the implementation of the teaching activity with the lens offered by Duval’s Theory of semiotic representations to highlight how the use of GeoGebra AR facilitated students’ transition through the different semiotic representations of paraboloids. Furthermore, analysing our results also with the lens offered by Marton’s Variation Theory, we will briefly show some of the patterns of variations emerging when students conceptualise and characterise paraboloids. Due to the restricted number of pages, in this paper, we present results related to the collective discussions conducted by considering the answers given by the students in the group work.

During the discussion on the preliminary task, students highlighted that, without the use of GeoGebra AR, they could not efficiently accomplish the task, as shown in the following excerpt:

S1: On the graphical representation of the first exercise, we have been very approximate, and even now, we are still not very sure about the answers we gave...

S2: Actually, it was not easy to recognize.

S1: Whereas with GeoGebra, you can rotate the image. And that’s what helps you.

S3: Seen from above, the paraboloid cut from the plane already gives you an idea of the curves that must come in the plane

Thus, students’ comments show that it was easier for them to identify the characteristics of the paraboloid using Augmented Reality. Even during the discussion of the subsequent tasks, students highlighted that, to be able to identify the correspondence between the surface in GeoGebra 3D and that of the level curves in 2D, it was essential to have the possibility to manipulate the surface directly on GeoGebra AR using the available tools (slider, pointer, rotation, intersection):

S4: We manipulated the surface and looked at it like this [paraboloid seen from above] ... then we used the “Intersect two surfaces” tool. We selected the paraboloid in red and the plane in blue and came up with this section, and then we drew the axes and circumference. So, by comparing this section with the given level curve, we saw that it was the same--always varying k . In fact, for example, if we go to change k by putting it on the value three, the two circumferences as we see are the same. [S4 first manipulates the shift of the plane on the surface with the slider, getting in the plane the circumference in blue, and then she manipulates the slider to change the given circumference on all GeoGebra files]. To see that they were just the same, we also took the intersection points and observed that they had the same values for abscissa and ordinate.

After the students observed that varying slider k varied both the level curve and the position of the plane that cut the surface in 3D space, the teacher asked them whether, by comparing two different

level curves corresponding to two different values of slider k , it was possible to deduce the equation of the surface:

S5: We have observed that for $k = 1$, the equation of the circumference, that is obtained by intersecting the red surface with the blue plane $z = 1$, is $x^2 + y^2 = 1$; on the other hand, for $k = 2$, we get $x^2 + y^2 = 2$, and so on... So, we can generalise and say that we get $x^2 + y^2 = k$, depending on the k we chose ... If this is the equation of the intersecting curve, then we can deduce that the surface in red has equation $x^2 + y^2 = z$, which represents an elliptical paraboloid.

It is worth noting that the transition between the same or different registers of semiotic representation depended on whether students had the possibility of exploiting the potential of GeoGebra AR. Students observed changes in level curves and their graphical representation by manipulating the slider k and the graphical representation representing the intersection between the surface and the plane $z = k$. Thus, in this case, the students performed a treatment. From the excerpts above, we can also see how, from this treatment and the observations made, students first performed a conversion between the graphical representation of the level curves and their analytical representation [“for $k = 1$, the equation of the circumference is $x^2 + y^2 = 1$ ” and so on]. Next, the students performed a treatment between the analytical representation of level curves and the analytical representation of the surface. Finally, they generalised the analytical representation of the level curve that depends on the value of the slider k to determine the analytical representation of the paraboloid [“So, we can generalise and say that we get $x^2 + y^2 = k$, depending on the k we chose ... If this is the equation of the intersecting curve, then we can deduce that the surface in red has equation $x^2 + y^2 = z$, and so it represents an elliptical paraboloid”].

Moreover, in S5’s arguments, it was possible to identify some of the patterns of variation in Marton’s theory. Specifically, the contrast pattern emerged by comparing the cases of individual level curves. At the same time, the generalisation pattern emerged when students identified the equation of the level curve as the parameter k varied and the equation of the surface, realising that it was necessary to make the variable z non-constant.

Finally, students also gained experience with the critical and relevant aspects that characterised the paraboloid analytical representation by observing the effect of variations on its characteristics. Subsequently, when we asked them to vary the parameters a and b separately and then simultaneously in the equation of the paraboloid, both the fusion and generalisation patterns emerged from the discussion. In fact, through their observations of what these variations caused, the students made explicit the classification of paraboloids, considering the limit cases, too, as shown in the excerpt below:

S7: In the first case where $a = b = 0$, we have the plane $z = 0$. Instead, we get an elliptic paraboloid if we take a greater than zero and b greater than zero.

T: If a is equal to b instead?

S7: Paraboloid, and that’s it. We get the same thing with a and b , both less than zero and not equal.

S5: But with concavity downward.

S7: Instead, a different case is when we take a and b discordant. We always get a hyperbolic paraboloid; however, if a is greater than 0 and b is less than 0 and vice versa, we get the y -axis or the x -axis.

S5: However, we observed that it is only a 90° rotation of the figure depending on the choice of a and b

Analysing this excerpt, it is worth noting that from the observations made to accomplish the previous tasks, students were facilitated by the transition between the same and different semiotic representation registers to classify the paraboloids. Starting from the variations on coefficients a and b and exploiting the potential of GeoGebra AR, students directly observed what was happening to the different representations for level curves and surfaces by performing the treatments and conversions previously described (Figure 1).

Finally, in the last part of the discussion, students were asked whether they found it easier to transition from the graphical representation of the surface to the analytical representation or vice versa.

T: So, does the transition for level curves make it easier to go from graphical to analytical representation?

S7: Yes, but it depends on the equation. It was easier to work from the level curves and generalise toward everything else. And then, it was helpful to make all the observations when we were asked to vary k and see what happened when we moved the $z = k$ plane. In this case, it was helpful to observe what happened to the radius of the circumferences-otherwise, without that information, it would have been impossible to find the surface equation.

S5: We connected the figures to the equations by observing that the level curves equation was a circumference and then observing the changes...

In the last part of the dialogue, it becomes clear how the transition from level curves' graphical and analytical representations to the surface's graphical and analytical representations was smoother than the direct transition between the surface's graphical and analytical representations. This agrees with what Duval states in his work, in which he accords conversion a central place concerning other functions, especially the treatment function, considered by most to be mathematically decisive. Moreover, "conceptualisation" begins only when the coordination of two distinct registers of representation is set in motion, even if only by sketching it.

Conclusions

In this paper, we wanted to highlight how the use of Augmented Reality can help students conceptualise the concept of paraboloids, facilitating the transition between different semiotic representations. The achievement of the aim of the teaching activity depended on the opportunity to use multiple registers of semiotic representations and to transform them between each other in a way that fostered students' conceptualisation of the mathematical objects involved. Therefore, students characterised paraboloids through treatments and conversions, made on the same and/or different registers of semiotic representations. Indeed, some of the excerpts presented in the results section highlighted how students conceptualised and characterised the paraboloids by taking advantage of

the potential of the available digital tools and the transition between different registers of semiotic representation. In particular, the analysis of the results also showed that, based on the task design of the teaching sequence, students represented level curves and surfaces in a given register, treated them within the same register, and converted them from one given register to another in order to conceptualise the mathematical object at stake. Moreover, the analysis of the last excerpt showed that students not only conceptualised paraboloids but also classified various cases, including borderline cases. Furthermore, they related the observations that emerged during the experimental stages by going through the sequence of patterns of variation following Marton's Variation Theory.

References

- Aldon, G., & Raffin, C. (2019). Mathematics learning and augmented reality in a virtual school. In T. Prodromou (Ed.) *Augmented reality in educational settings*, (pp. 123–146). Brill Sense
- Cahyono, A. N., Sukestiyarno, Y. L., Asikin, M., Ahsan, M. G. K., & Ludwig, M. (2020). Learning Mathematical Modelling with Augmented Reality Mobile Math Trails Program: How Can It Work?. *Journal on Mathematics Education*, *11*(2), 181–192. doi.org/10.22342/jme.11.2.10729.181-192
- Capone, R., & Lepore, M. (2020). Augmented reality to increase interaction and participation: A case study of undergraduate students in mathematics class. In L. T. De Paolis and P. Bourdot (Eds.) *International Conference on Augmented Reality, Virtual Reality and Computer Graphics* (pp. 185-204). Springer, Cham.
- Duval, R. (1993). Registres de Représentations sémiotiques et Fonctionnement cognitif de la Pensée. *Annales de didactique et de sciences cognitives*, *5*, 37–65.
- Duval, R. (2006). A cognitive analysis of problems of comprehension in a learning of mathematics. *Educational studies in mathematics*, *61*(1), 103–131. doi.org/10.1007/s10649-006-0400-z
- Godino, J. D., & Batanero, C. (1994). Significado institucional y personal de los objetos matemáticos. *Recherches en didactique des Mathématiques*, *14*(3), 325–355.
- Marton, F., & Pang, M. F. (2006). On some necessary conditions of learning. *The Journal of the Learning Sciences*, *15*(2), 193–220. doi.org/10.1207/s15327809jls1502_2
- Marton, F., Runesson, U., & Tsui, A. (2004). *The space of learning*. Mahwah, NJ: Lawrence Erlbaum
- Tomaschko, M., & Hohenwarter, M. (2019). Augmented reality in mathematics education: The case of GeoGebra AR. In T. Prodromou (Ed.) *Augmented reality in educational settings*, (pp. 325–346). Brill Sense

Mathematical communication when using DGE: Balancing between object and representations

Cecilie Carlsen Bach¹, Ewa Bergqvist² and Uffe Thomas Jankvist³

¹Danish School of Education, Aarhus University, Denmark; ccb@edu.au.dk

²Umeå University, Sweden; ewa.bergqvist@umu.se

³Danish School of Education, Aarhus University, Denmark; utj@edu.au.dk

When using a dynamic geometry environment, students' mathematical communication may become more dynamic, shown by adverbs and verbs indicating activity or change. In this paper, three examples of students' answers when using a DGE template are analysed through Duval's (2017) semiotic register approach as well as the concept of dynamic mathematical communication. Results exemplify how students' mathematical communication when using DGE may have a dynamic character (using words such as 'drag'). Results also indicate that coordinating representations across four different registers is challenging, and students may focus on only performing treatments in one register. Furthermore, the students' insightful readiness to communicate mathematically may be challenged in DGE settings.

Keywords: Mathematical communication, digital tools, dynamic geometry.

Introduction

Mathematical representations are dynamically linked in digital tools, such as a dynamic geometry environment (DGE). Duval (2017) observes that *non-discursive semiotic representations* [i.e., figures or points and graphs in the cartesian system] become manipulable as real objects. We can move them, make them rotate or extend them from one point. This “dynamic” aspect is just a consequence of the computer capacity of treatment, which is considerable in comparison with the other phenomenological modes of production. *That allows to meet a new epistemological function that the others modes of production cannot do: exploration by simulation.* (p. 100, italics in original)

Duval (2017) also argues that the transformations between different representations are important for learning rather than the individual representations. When using DGE, students may perform transformations between representations by physical actions in such an environment.

Students' mathematical communication reflects the tool in play (Jungwirth, 2006), and when using DGE, they often use verbs and adjectives indicating movement or actions (Ng, 2016, 2019). Such communication may be labelled as ‘dynamic mathematical communication’ (Bach & Bergqvist, in review; Jones, 2000). Conventions for mathematical communication have been established over a long time (Morgan, 1999), but DGE is relatively new, and so is this type of communication. Hence, the DGE seem to change how the students communicate mathematically. Still, how this relates to the students' mathematical communication competency (see Niss & Højgaard, 2019) is not yet examined.

The purpose of the present paper is thus to enhance the understanding of students' dynamic mathematical communication when using DGE. In particular, we want to begin exploring how such

communication relates to transformations of mathematical representations and to mathematical communication competency. We, therefore, present three examples of students' dynamic communication when using DGE. We analyse these examples of students' written answers using Duval's (2017) concepts of transformations of representations, and finally, we discuss the results in relation to the Danish competency framework's (KOM) definition of mathematical communication competency (Niss & Højgaard, 2019).

Dynamic mathematical communication

Previous research has found different characteristics of students' communication when working with mathematics using digital tools. In a literature review, Bach and Bergqvist (in review) found 13 studies describing student communication as being dynamic in different ways when using DGE.

Students' written mathematical communication when using DGE is characterised by temporality and movement (Antonini et al., 2020; Jones, 2000). Students use verbs (Schacht, 2018), such as 'drag' or 'pull' (Jones, 2000; Schacht, 2017). Similar results appear for students' oral mathematical expressions when DGE is involved, also focusing on verbs indicating actions and movement (Hölzl, 1996; Kaur, 2015). Also, "if ... then" sentences may be used to indicate change as students try to capture what happens to the representations when dragging (Kaur, 2015).

The adjective 'dynamic' is defined in the Merriam-Webster dictionary as "marked by usually continuous and productive activity or change" (Merriam-Webster, n.d.). In the present paper, we thus define dynamic mathematical communication as communication of mathematical nature that involves movement, change, action or temporality in verbs and adverbs (we return to 'mathematical nature' in the section on the mathematical communication competency).

Mathematical representations and semiotic registers

Mathematical objects are handled through their representations. According to Duval (2017), individual representations are not important for learning, but rather the transformations between different representations. For example, if drawing a graph based on a function written with mathematical symbols. Hence, the crucial mathematical activity is making and interpreting transformations between representations.

Duval (2017) distinguishes between four kinds of registers that have different rules and characteristics. The four kinds of registers may be arranged in a 2×2 matrix, where the first column includes discursive registers and the second includes non-discursive. The first row comprises multifunctional registers, and the second includes monofunctional registers. 'Discursive registers' involve words or symbols, whereas 'non-discursive registers' do not. 'Monofunctional registers' are registers specifically existing in mathematics. They are governed by specific rules and algorithms, for example, equations. Representations within the 'multifunctional registers' cannot be handled by algorithms. The multifunctional registers are not specific to mathematics, but they are important for communication in the classroom (Duval, 2017).

Each representation belongs to a register and can be placed in one cell in the matrix. For example, the register of ‘natural language’ is discursive and multifunctional. The register of ‘symbolic writings’, such as equations, is discursive and monofunctional as it includes symbols and is controlled by algorithms. The register of ‘images and geometrical figures’ is multifunctional and non-discursive, for example, rectangles and squares. The register of ‘Cartesian graphs and diagrams’ is considered monofunctional and non-discursive (even if single words or phrases are part of a graph). In addition, two different kinds of transformations between representations exist, according to Duval (2017). A transformation between two registers, for instance, a transformation from an equation to a graph, is called a ‘conversion’. A transformation within the same register, for example, when reducing a sentence or an equation, is referred to as a ‘treatment’.

When using a digital tool, a new semiotic register is not added, but the power of the tool makes it possible to perform constant treatments and conversions of representations present in the tool. It is the production of and transformations between representations that are different. Additionally, the register for natural language is often neglected when using a digital tool (Duval, 2017).

Duval’s concepts will be applied in the analysis of examples of dynamic mathematical communication (see the section ‘Method of analysis’ for more details).

Mathematical communication competency

KOM is an abbreviation for ‘Competencies and mathematical learning’ (Niss & Højgaard, 2011). The KOM framework is a competency framework aiming to describe what it means to master mathematics across school levels. KOM consists of eight mathematical competencies, including the mathematical communication competency. A mathematical competency is defined as “someone’s insightful readiness to act appropriately in response to *a specific sort of mathematical challenge* in given situations” (Niss & Højgaard, 2019, p. 14, italics in original). ‘Insightful readiness’ addresses that to exercise a competency, one must have a knowledge base to ‘act’ upon, which is manifested through mathematical activities. Such a knowledge base entails familiarity with the mathematical concepts involved in a given mathematical situation. Niss and Højgaard state that “readiness to act without insight”, although this certainly exists, is not an instance of (exercising a) competency, while (possession of) competency “does not follow alone from being immensely insightful, in case the insights at issue cannot be activated in the broad interpretation of the term ‘action’” (2019, p. 12). In the KOM framework, ‘action’ covers both physical and behavioural actions (including oral communication) as well as mental actions, including decision making.

Mathematical communication competency concerns the ability to communicate mathematically, including expressing oneself mathematically and interpreting others’ mathematical expressions. Mathematical communication may occur using different genres, registers, or styles (Niss & Højgaard, 2019). Students’ dynamic mathematical communication is then a new register (these registers are language registers and different from Duval’s) of mathematical communication, which is different from the conventional way of communicating mathematics.

For mathematical communication competency, communication must be of mathematical nature, including “notions and concepts, terms, results and theories, or other features of mathematics” (Niss & Højgaard, 2019, p. 18). Mathematical representations are necessary when communicating mathematically, which stresses the relationship to Duval’s (2017) perspectives of semiotic registers. We will relate the analysis of the examples to the concept of mathematical communication competency in the concluding discussion.

Methodological aspects

This paper presents three examples of 9th-grade students’ (14-16 years old) written answers to a task involving GeoGebra, which is a DGE according to Sutherland and Rojano (2014). The examples are chosen to show a variation of students’ dynamical communication related to Duval’s semiotic registers as well as cases of dynamic mathematical communication.

The students’ answers are translated from Danish into English, and their forms of writing are kept as far as possible. For instance, if they write a letter for a point using small letters, it is not adjusted when presented in this paper. Students’ spelling mistakes have been corrected.

Task design

A task originally described by Johnson and McClintock (2018) was presented to the three students. The three students, Taylor, Kim, and Nico (fictitious names), were all familiar with GeoGebra. The task focuses on function as covariation, and the students were provided with a template. A snapshot from the template is presented in Figure 1.

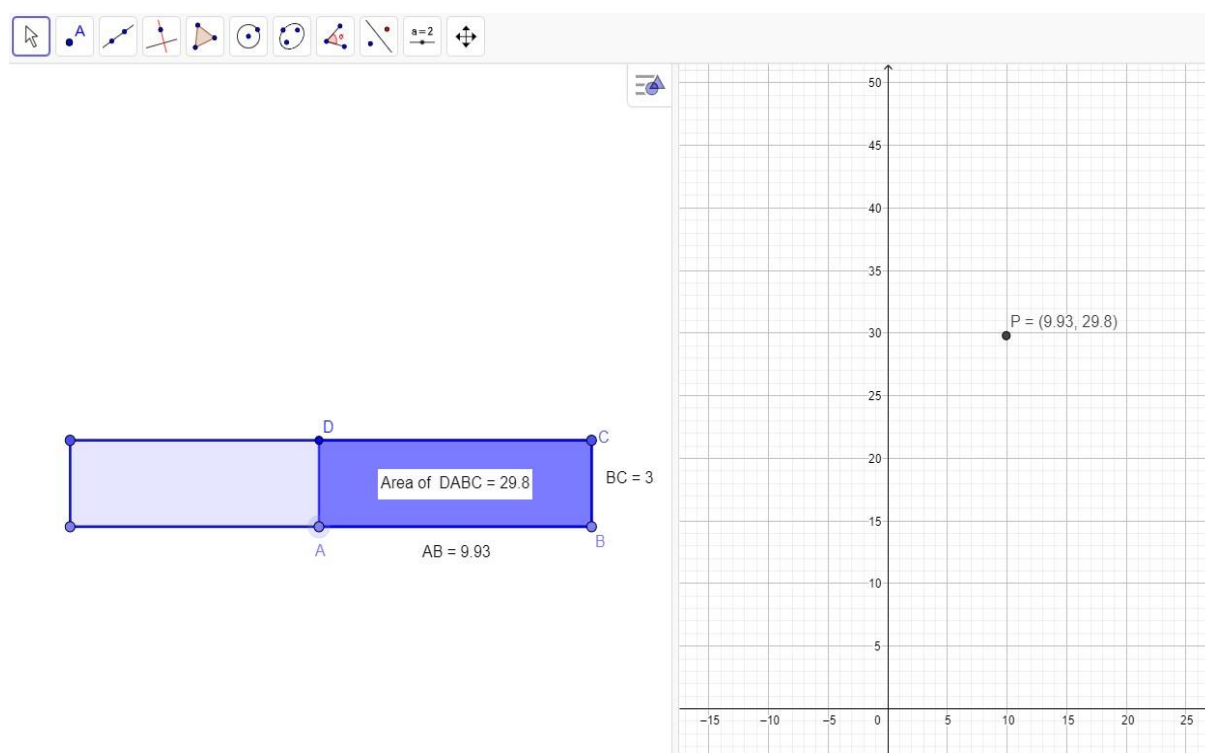

Figure 1: Snapshot of the DGE template with the area of $DABC$, length of AB and BC and coordinates for point P . Inspired by Johnson and McClintock (2018).

The template involves two non-discursive registers: A rectangle, which can be dragged in point A and in a point P , which is linked to the rectangle. The x -coordinate of P is defined as the length of AB , and the y -coordinate of P is the area of $DABC$. The students are asked to investigate the relationship between the rectangle $DABC$ and the point P and to define the equation of the function for the relationship (i.e., $y=3x$). Thereby, the students are asked to make conversions from the non-discursive register into the discursive register. To do so, they need to interpret the constant treatments within the two non-discursive registers when dragging and making conversions between two registers when describing the relationship between the rectangle $DABC$ and point P as a function.

Method of analysis

The three examples of students' written answers all show dynamic mathematical communication. Relying on the definition and characteristics of 'dynamic mathematical communication' in the background section as well as existing literature, we mark the following words: verbs (Schacht, 2018), "is+noun" or "is+adjective" (Ng, 2016) and adverbs, for instance, if writing "then" (Kaur, 2015). Thus, students' verbs indicating movement, temporality, action, or change are written below in italics, while students' adverbs are in bold. Other elements indicating dynamicity are underlined. In this way, dynamic communication is identified and made explicit.

The analysis consists of identifying the students' treatments and conversions between and within the involved representations. For example, transformations from the rectangle to a graph or from a graph to a written expression are identified as conversions. Descriptions of changes only for the rectangle $DABC$ caused when dragging in point A are identified as treatments.

Examples of students' answers and subsequent analyses

In this section, we present the three examples with subsequent analyses.

Taylor **If** you *drag* point A , the rectangle's (the dark blue one) area *gets* bigger.

Taylor's answer in the natural language indicates that he interpreted the constant treatments of the rectangle when dragging point A . The answer does not indicate that he did or interpreted any conversions across the two non-discursive registers (i.e., from the multifunctional to the monofunctional register), since the point P is not mentioned.

Kim **When** you *drag* point A , point P *moves* its coordinates. It *creates* a kind of line the more you *drag* point A . Maybe it is some kind of graph or function, which is *created* **when** P goes **up and down**.

In opposition to Taylor's answer, Kim's answer is more focused on the treatments in the nondiscursive monofunctional register concentrating on point P . The answer is in natural language, concerns "a kind of line". "A kind of line" indicates that Kim activated tracing for point P when dragging. Thus, in this example, the actions of dragging point A are related to the treatments of point P . However, conversions of the properties of rectangle $DABC$ to point P is not part of Kim's description.

Nico **When** you drag point A , p *moves* **up and down**. **If** you *drag* A towards the right, point P *moves* **down**. **If** you *drag* A to the left, P *moves* **up**. $fx=3x$. P relates to the rectangle's area. **If** p stands on 4 on the x -axis, P is at 12 on the y -axis

Nico's answer includes, or at least refer to, representations in all four kinds of registers. Hence, Nico's answer indicates that he made treatments in the Cartesian system focusing on point P , and he coordinated it with the actions of dragging point A . However, Nico also made conversions from the rectangle and its area to point P as well as to the symbolic registers, shown by " $f_x=3x$ ".

The analyses of the students' answers illustrate that coordination of all four kinds of registers at once is a complex endeavour, and students may choose only to focus on treatments within one register and not on conversions between them (i.e., Taylor and Kim). The results also show that the template serves as easy access to the different representations and that all three students manipulate and interpret representations by dragging (see Duval, 2017).

Concluding discussion

The students show dynamic communication, as they use both verbs and adverbs indicating movement, change, action, or temporality. More specifically, verbs such as 'drag', 'create', and 'moves', and adverbs such as 'if' and 'when'. Taylor also utilises the adjective 'bigger' to indicate the change in the size of the rectangle. Duval (2017) argues that the use of digital tools may reduce natural language in mathematics, but these examples do not show a reduced language. Rather, the examples show a language that is dynamic, due to how representations are produced and linked in the DGE, including the representations' dynamic properties.

To exercise *mathematical* communication competency, students' mathematical communication has to be of a *mathematical* nature. Thus, the communication must concern mathematical concepts and notions, including mathematical objects and representations (Niss & Højgaard, 2019). All three students communicate using mathematical representations; they work within a digital geometry environment; solve a mathematical task, and mention concepts and notions, such as "area", and "coordinate". Still, the communication is dynamic, that is, they utilise dynamic mathematical communication.

The epistemological considerations regarding mathematics and the use of computers are described by Duval (2017), who argues that when the students use a computer, the nature of the mathematical representations involved is different than without the computer. Within the DGE, the non-discursive representations (i.e., figures and graphs) become manipulable, as if they were indeed "real objects" (see Duval, 2017). When presented in a textbook or on a blackboard, the representations are not dynamically linked. For example, 'dragging' is not a paper-and-pencil action. Thus, the students describe the representations as dynamic entities with changing characteristics. When this happens, they ascribe dynamic properties to the representations, risking that the distinction between the object and its representations blurs.

The possibility to interact directly with the representations and to use dynamic communication about these might make it more difficult for the students to determine what properties that are inherent to the mathematical objects. Simultaneously, some dynamic properties of mathematical objects may become more accessible in DGE representations and through dynamic communication. For example, the movement of a point along with the graph of a function (e.g., Kim). When this happens, it is possible that the distinction between representation and object blurs.

In summary, DGE offers additional ways of producing and engaging with representations of mathematical concepts, including the representations' properties and the relations between the representations, as the properties of concepts and representations change with the dynamic features in the DGE. In a sense, the use of a DGE makes mathematics and mathematical communication more complex for the students. Of course, the access to new representations might be helpful when communicating mathematically, but it could also be demanding for the students. Regarding the students' mathematical communication competency, this complexity might even reduce their insightful readiness to communicate mathematically. The readiness to act is challenged as students' prerequisites for exercising mathematical communication competency change when the DGE potential brings representations of a new nature.

Dynamic mathematical communication is a new phenomenon stemming from DGE use, but its relation to mathematical communication competency and mathematical nature is still to be further investigated.

Acknowledgement

This study is part of project 8018-00062B under Independent Research Fund Denmark.

References

- Antonini, S., Baccaglini-Frank, A., & Lisarelli, G. (2020). From Experiences in a Dynamic Environment to Written Narratives on Functions. *Digital experiences in Mathematics Education*, 6, 1–29. <https://doi.org/10.1007/s40751-019-00054-3>
- Bach, C. C. & Bergqvist, E. (in review). Mathematical communication when using digital tools.
- Duval, R. (2017). *Understanding the Mathematical Way of Thinking – The Registers of Semiotic Representation*. Springer Nature. <http://doi.org/10.1007/978-3-319-56910-9>
- Hölzl, R. (1996). How does 'dragging' affect the learning of geometry. *International Journal of Computers for Mathematical Learning*, 1, 169–187 <https://doi.org/10.1007/BF00571077>
- Johnson, H. L., & McClintock, E. (2018). A link between students' discernment of variation in unidirectional change and their use of quantitative variational reasoning. *Educational Studies in Mathematics*, 97, 299–316. <https://doi.org/10.1007/s10649-017-9799-7>
- Jones, K. (2000). Providing a foundation for deductive reasoning: students' interpretations when using dynamic geometry software and their evolving mathematical explanations. *Educational Studies in Mathematics*, 44, 55–85. <https://doi.org/10.1023/A:1012789201736>
- Jungwirth, H. (2006). Everyday computer-based maths teaching: The predominance of practical activities. In J. Novotná, H., Moraová, M. Krátká & N. Stehlíková (Eds.), *Proceedings 30th conference of the International Group for the Psychology of Mathematics Education*, Vol. 3, pp. 377–384. PME

- Kaur, H. (2015). Two Aspects of Young Children's Thinking about Different Types of Dynamic Triangles: Prototypicality and Inclusion. *ZDM: The International Journal on Mathematics Education*, 47 (3), 407–420. <https://doi.org/10.1007/s11858-014-0658-z>
- Merriam-Webster (n.d.). *Dynamic*. In Merriam-Webster.com dictionary. Retrieved January 4, 2022, from <https://www.merriam-webster.com/dictionary/dynamic>
- Morgan, C. (1999). Convention or necessity? The impersonal in mathematical writing. In L. Billis (Ed.), *Proceedings of the British Society for Research into Learning Mathematics*, 19 (1), 55–60.
- Ng, O.-L. (2016). Comparing Calculus Communication across Static and Dynamic Environments Using a Multimodal Approach. *Digital Experiences in Mathematics Education*, 2 (2), 115–141. <https://doi.org/10.1007/s40751-016-0014-8>
- Ng, O. L. (2019). Examining Technology-Mediated Communication Using a Commognitive Lens: the Case of Touchscreen-Dragging in Dynamic Geometry Environments. *International Journal of Science and Mathematics Education*, 17 (6), 1173–1193. <https://doi.org/10.1007/s10763-0189910-2>
- Niss, M., & Højgaard, T. (2011). *Competencies and mathematical learning ideas and inspiration for the development of mathematics teaching and learning in Denmark*. IMFUFA, Roskilde University.
- Niss, M., & Højgaard, T. (2019). Mathematical competencies revisited. *Educational Studies in Mathematics*, 102, 9–28. <https://doi.org/10.1007/s10649-019-09903-9>
- Schacht, F. (2017). Nature and characteristics of digital discourse in mathematical construction tasks. In T. Dooley & G. Gueudet (Eds.), *Proceedings of the Tenth Congress of the European Society for Research in Mathematics Education (CERME10)* (pp. 2636–2643). DCU Institute of Education & ERME
- Schacht, F. (2018). Between the Conceptual and the Signified: How Language Changes when Using Dynamic Geometry Software for Construction Tasks. *Digital Experiences in Mathematics Education*, 4, 20–47. <https://doi.org/10.1007/s40751-017-0037-9>
- Sutherland R. & Rojano T. (2014). Technology and Curricula in Mathematics Education. In S. Lerman (Ed.), *Encyclopedia of Mathematics Education*. Springer. https://doi.org/10.1007/978-94007-4978-8_154

Exploring the potential for long-term changes in mathematics teachers' use of digital resources resulting from the covid pandemic

Scott A. Courtney¹, Mary E. S. Miller¹ and Michael J. Gisondo¹

¹Kent State University, USA; scourtn5@kent.edu; mstockd1@kent.edu; mgisondo@kent.edu

Attempts to mitigate Covid-19 through remote instruction provided unique opportunities for researchers to examine the resources teachers utilize to drive their practices. We examine the impact of the pandemic on grades 6-12 mathematics teachers and math interventionists, with particular attention to teachers' integration of digital resources. Using purposive sampling, we surveyed 50 participants throughout the United States. Results indicate that although teachers' utilization of digital resources increased over the course of the pandemic, the significance and potential longevity of such increases were dependent on the participant and the type of teacher practice.

Keywords: Technology integration, digital resources, mathematics teachers' practices.

Introduction

The coronavirus pandemic impacted all aspects of society, causing countries and local communities to close workplaces, move schools to remote instruction, limit in-person contact, cancel public gatherings, and restrict travel. The pandemic forced schools to adapt to fulfill their many functions, challenging teachers to rethink ways to support their teaching and their students' learning. Countries attempted to fill the void left by school closures by offering a variety of distance learning solutions, including "hi-tech alternatives like real-time video classes conducted remotely to lower-tech options such as educational programming on radio and television" (UNESCO, 2020, para. 3). According to the OECD (2020), an almost universal response to the pandemic was the use of digital technologies to support teachers, students, and their families. Digital technology allows for new solutions to "what people learn, how people learn, where people learn and when they learn . . . [and can] enable teachers and students to access specialized materials well beyond textbooks, in multiple formats and in ways that can bridge time and space" (OECD, 2020, para. 2). Unfortunately, not all students have the same access to digital devices and online resources, and access varies greatly across and within countries (OECD, 2020). As a result, the pandemic highlighted and exacerbated existing inequities in education, with the most vulnerable children being the most adversely affected. In the United States, remote learning continued well into (if not all) the 2020-2021 academic year for many students. In this report, we address the following research question: How has the necessity for remote and hybrid teaching and learning environments, due to the ongoing coronavirus pandemic, impacted grades 6-12 mathematics teachers' and interventionists' utilization of digital resources?

Methods

In this report, we use the term digital resource to refer to any digital technology that is 'developed and used by teachers and pupils in their interaction with mathematics in/for teaching and learning, inside and outside the classroom' (Pepin & Gueudet, 2020, pp. 172-173), including electronic tools, systems, devices, apps, software, programs, websites, digital textbooks. The study was conducted using purposive sampling, based on identification of those populations the research team judged

would provide information productive to addressing the study’s research questions. As such, we searched online for the email addresses of grades 6-12 mathematics teachers and math interventionists from across the United States. Potential participants were sent an email inviting them to participate in the survey, followed by a reminder email five days later. Email invites were sent to approximately 200 math teachers and interventionists—across urban, suburban, and rural districts—in each of the 50 U.S. states. The descriptive survey included 13 questions focusing on the six aspects of teachers’ (and their students’) work with/on digital resources. In this report, we focus mainly on one of these aspects: comparisons of the percent of time teachers typically spent prior to covid, and currently spend, using digital resources when engaged in various practices; specifically, preparing lessons, preparing assessments, grading or marking student work (e.g., exam, homework), sharing ideas with colleagues, and engaging in professional development (e.g., workshop, webinar, podcast). Finally, the survey identified “pre-covid” as occurring prior to March 2020—prior to the near-total lockdown of schools in the U.S.—and “post-covid” as occurring at the time the survey was distributed (i.e., March 2022), which was up to a full year after schools in the United States returned fully to in-class instruction.

A total of 50 teachers completed the survey. Forty-six of these participants identified as math content teachers, one participant identified as a math interventionist, and three respondents identified as both a math content teacher and an interventionist. Participants' years of experience ranged from “First Year Teacher” to “More than 25 Years,” with a median of “16-20 Years” of experience. Finally, the grade level(s) of the students taught by participating teachers is provided in Table 1.

Table 1: Grade levels taught by participating teachers

Grade Level	Grade 6	Grade 7	Grade 8	Grade 9	Grade 10	Grade 11	Grade 12
Number of Teachers	11	11	17	18	17	20	17

Data analysis predominantly involved performing a series of chi-square tests to examine relationships between the number of teachers utilized digital resources for various practices (e.g., preparing lessons, grading or marking student work) and the percent of time these digital resources were utilized for these same practices pre- and post-covid; that is, prior to March 2020 and March 2022, respectively.

Results

The findings reported here address whether the need for lockdowns and remote teaching and learning environments during the pandemic impacted teachers’ use of digital resources in the long-term. Therefore, we examined potential differences in teachers’ use of digital resources prior to the pandemic and teachers’ current uses of these same or similar resources now that school districts in the U.S. have returned to face-to-face instruction for at least an entire academic year. Participants were asked to estimate the typical amount of time they spent, pre- and post-covid, using digital resources when engaged in the five practices identified above. Responses, as a broad percentage of time, ranged from “0-10% (Very Infrequently),” “11-20% (Infrequently),” “21-30% (Occasionally),” “31-40% (Fairly Often),” “41-50% (Frequently),” “More than 50% (Very Frequently).”

The distributions of teachers’ use of digital resources to prepare lessons, currently and prior to the pandemic, are illustrated in Figure 1. A chi-square test of independence was performed to determine

the relationship between teachers' use of digital resources to prepare lessons, currently and prior to the covid pandemic. A significant association was found, $\chi^2(5) = 22.73$, $p < 0.05$; that is, teachers were currently more likely to use digital resources to prepare lessons than they were prior to the covid pandemic.

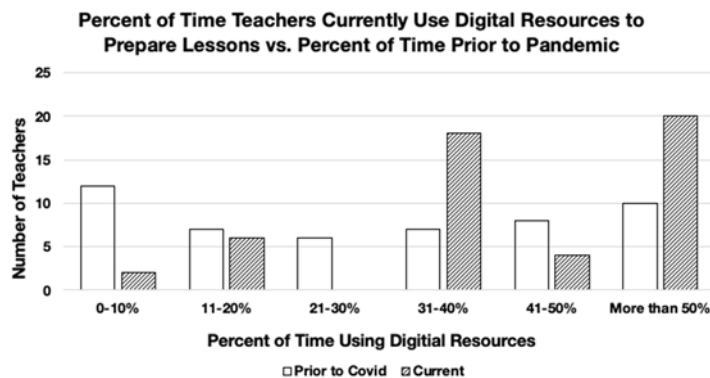

Figure 1. Percentage of time teachers use digital resources to plan lessons

The distributions of teachers' use of digital resources to grade or mark student work, currently and prior to the pandemic, are illustrated in Figure 2. A chi-square test of independence was also performed to determine the relationship between teachers' use of digital resources to grade or mark student work, currently and prior to the covid pandemic. A significant association was found, $\chi^2(5) = 23.84$, $p < 0.05$; that is, teachers were currently more likely to use digital resources to grade or mark student work than they were prior to the covid pandemic.

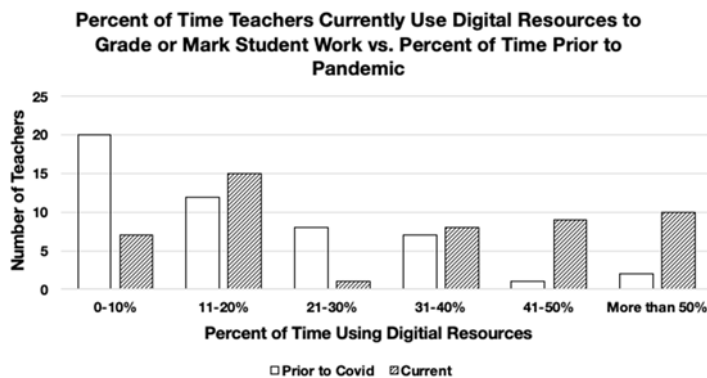

Figure 2. Percentage of time teachers use digital resources to mark or grade student work

Finally, the distributions of teachers' use of digital resources to engage in professional development, currently and prior to the pandemic, are illustrated in Figure 3. A chi-square test of independence was performed to determine the relationship between teachers' use of digital resources to engage in professional development, currently and prior to the covid pandemic. A significant association was found, $\chi^2(5) = 18.63$, $p < 0.05$; that is, teachers were currently more likely to use digital resources to engage in professional development than they were prior to the covid pandemic.

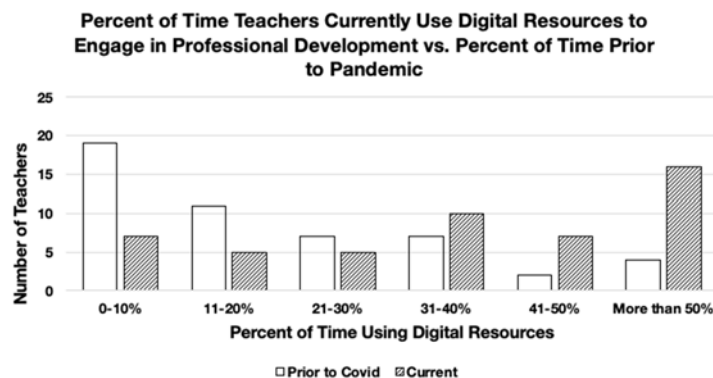

Figure 3. Percentage of time teachers use digital resources to engage in professional development

Although there were differences in the distributions of the percentages of time teachers typically spent, prior to covid (i.e., pre-March 2020) and currently (i.e., March 2022), using digital resources when preparing assessments and sharing ideas with colleagues, there was not a significant relationship between teachers’ current and prior use for either of these practices. Over the five practices addressed here, the practices that increased the most throughout the pandemic were engaging in professional development (e.g., workshop, webinar, podcast), with a mean increase of 1.54 “levels” and grading or marking student work (e.g., exams, homework), with a mean increase of 1.28 “levels.” Here, an increase from “11-20% (Infrequently)” to “21-30% (Occasionally)” or from “41-50% (Frequently)” to “More than 50% (Very Frequently)” are two examples of an increase of one level.

There were no participants that indicated they used digital resources “41-50% (Frequently)” or “More than 50% (Very Frequently)” for all five practices prior to covid. In fact, there were only four participants that indicated they used digital resources “41-50% (Frequently)” or “More than 50% (Very Frequently)” for four practices prior to covid. Conversely, there were 10 participants that indicated they used digital resources “41-50% (Frequently)” or “More than 50% (Very Frequently)” for all five practices post-covid, and an additional three participants indicated such for four practices. Finally, if we examine participants’ changes in their use of digital resources across all five practices, pre- and post-covid, results indicate:

- Eight of 50 participants (16%) indicated a mean decrease in their use of digital resources.
 - Six of these eight participants (75%) indicated an average decrease of less than one level.
- Four of 50 participants (8%) indicated no change in their use of digital resources.
 - Three of these four participants (75%) indicated no change for all five practices.
- Thirty-eight of 50 participants (76%) indicated a mean increase in their use of digital resources.
 - Twenty-two of these 38 participants (57.9%) indicated an average increase of more than one level.
 - Twelve of these 38 participants (31.6%) indicated an average increase of more than two levels.

- Five of these 38 participants (13.2%) indicated an average increase of more than three levels.
- Two of these 38 participants (5.3%) indicated an average increase of more than four levels.

Although participants, in general, indicated an increase in their use of digital resources over the course of the pandemic for each practice, how certain can we be that such changes were a result of the pandemic? Could it be the case that some (or all) participating teachers were already in the process of increasing their use of digital resources prior to covid? Furthermore, although the survey identified “post-covid” as occurring at the time the survey was distributed (i.e., March 2022)—a full year after schools in the U.S. returned fully to in-class instruction—how can we be certain any identified increase will be long-term? To address these questions required examination of participants’ anecdotal responses to the following survey question: Please describe your own and your math students’ growth in the use of digital resources over the course of the covid pandemic.

One of the four participants that indicated they used digital resources “41-50% (Frequently)” or “More than 50% (Very Frequently)” for four practices prior to covid (see above), either continued or increased their pre-covid level of use on all five practices, indicating a stable (i.e., long-term) utilization. According to this teacher (identified as Teacher 2), “Covid opened up so many new resources that I’m able to use . . . I’m still teaching with many of these resources.” Conversely, Teacher 33, another participant that indicated they used digital resources “41-50% (Frequently)” or “More than 50% (Very Frequently)” for four practices prior to covid, decreased their pre-covid level of use on all four practices. Teacher 33 was one of four participants that indicated they had decreased their use of digital resources once classes returned to in-person instruction. Such changes were primarily due to participants’ own and their students’ overexposure to such resources. It is unclear whether such decreases are long-term. The following responses exhibit characteristics of these four participants:

Teacher 13: For a lot of my students and for some [resources] myself, we didn’t get any training on how to use these things . . . so I 100% feel I haven’t used any of my digital resources to their full potential . . . and basically stopped once we came back.

Teacher 47: I did notice that while I used a bunch of [resources] . . . while I was remote, now that I’ve returned to that the classroom, I don’t want to use them anymore.

Five of the 50 participants (10%) indicated they were in the process of increasing their use of digital resources prior to covid, and the pandemic only accelerated this change. For these teachers, such changes have the potential to be long-term. The following responses exhibit characteristics of these five participants:

Teacher 3: Before covid hit my coworker and I were moving more towards a digital technology in our classroom . . . recording ourselves teaching . . . for students that were absent . . . covid really made us move up this transition.

Teacher 8: I always wanted to have a paperless classroom for environmental reasons, and it just . . . never worked out . . . [and] I had been slowly incorporating technology that allows for this, but covid just forced me to go all in.

Twenty-eight of the 50 participants (56%) indicated, to varying degrees, the pandemic was the impetus for the increase in their own and their students use of digital resources. The potential for long-term change in these teachers' practices is participant dependent. The following responses exhibit characteristics of these 28 participants:

Teacher 2: Covid opened up so many new resources that I'm able to use . . . I'm still teaching with many of them.

Teacher 3: I didn't really use to use any digital resources . . . [but] I've definitely become a lot more comfortable with how to use the resources and how the students respond to electronic resources and tools, because I didn't have a choice with covid.

Teacher 10: Personally, I've learned a great deal about Google Classroom and now I am able to turn anything into an online assignment for kids who [are absent].

Teacher 11: I made a bunch of videos for some of my classes . . . and it's nice to have those videos, especially when kids miss for any time . . . so, the flexibility to continue using [those] if we need to is nice.

Teacher 15: I did grow in my use of Google Forms . . . [and] finally settled on using Google Forms to give tests and still do this . . . you can put it into lockdown mode so that students can't look at other sites while they're using their Chromebook.

Finally, 12 of the 50 participants (24%) provided responses that made it unclear as to why they might have changed, or not, their use of digital resources in their practices over the course of the pandemic. Such responses further obscured attempts to determine these teachers' long-term practices. The following responses exhibit characteristics of these 12 participants:

Teacher 4: Now we've gotten the laptops to all the kids and still have situations where, you know, a parent just took the digital device and left the kid without it, because they needed the digital device, and the parent doesn't even live with the kid.

Teacher 22: With respect to the pandemic, my students and I used a lot more Microsoft Teams and programs such as Desmos and IXL . . . specifically . . . having a class meeting . . . and teaching long distance was a huge learning curve for all of us.

As described above, 38 of 50 participants (76%) indicated a mean increase in their use of digital resources pre- and post-covid. Furthermore, 28 of 50 participants (56%) indicated the pandemic was the reason for their increased use. Finally, the potential longevity of changes to teachers' use of digital resources was less clear and dependent on the participant and the type of teacher practice.

Conclusions

Findings reported here indicate that mathematics teachers' and interventionists' use of digital resources changed significantly post- (i.e., March 2022) as compared to pre-pandemic (i.e., pre-

March 2020) with regards to preparing lessons, grading or marking student work (e.g., exam, homework), and engaging in professional development (e.g., workshop, webinar, podcast). Furthermore, the types of digital resources participating teachers used to plan lessons favored technology that utilizes sharing between colleagues and out-of-district teachers. Regarding assessment, the trade-off between features and simplicity did not tilt teachers away from traditional paper and pencil options. Such traditional methods, for now, are seen as more reliable at evaluating mathematics achievement as opposed to measuring technological proficiency. Although it could be argued that asking teachers to report on their pre-covid practices—experiences that occurred more than two years from the time of the survey—allowed for inaccuracies and potential biases in teachers’ memories, we presuppose participants genuinely reflected on their pre-covid practices using whatever information and resources (e.g., old lesson plans, old assignments, old assessments, textbooks) they had available that supported authentic reflection.

Finally, teachers reported that overexposure to technology has created an ongoing challenge. The sheer number of digital options teachers reported they “looked into” or used was characteristic of the overwhelming nature of the switch to digital. There were several limitations to this study, including the small sample size. In addition, the anonymity of the survey did not allow for follow-up questions from respondents. Such follow-up questions would have been helpful to gain more insight into teachers’ integration of digital resources. Lastly, no students were surveyed. Therefore, the opinions and responses provided were solely those of teachers; that is, the facilitators of the learning, not the learners themselves. The results presented here addressed only nine of the survey’s 25 questions. Therefore, future research—utilizing responses to all survey questions—should examine which aspects of teachers’ lesson planning, marking or grading of student work, and professional learning have remained at an increased level long-term (post-covid). Finally, future research should examine how the pandemic impacted more nuanced aspects of teachers’ assessment practices (e.g., feedback, informal assessment) and their interactions with colleagues.

References

- OECD. (2020, April 3). *Learning remotely when schools close: How well are students and schools prepared? Insights from PISA (OECD policy responses to coronavirus, COVID-19)*. OECD. <https://www.oecd.org/coronavirus/policy-responses/learning-remotely-when-schools-close-how-well-are-students-and-schools-prepared-insights-from-pisa-3bfd1f7/>
- Pepin, B., & Gueudet, G. (2020). Curriculum resources and textbooks in mathematics education. In S. Lerman (Ed.), *Encyclopedia of mathematics education* (pp. 172–176). Springer.
- UNESCO. (2020, March 19). *Half of world’s student population not attending school: UNESCO launches global coalition to accelerate deployment of remote learning solutions*. <https://en.unesco.org/news/half-worlds-student-population-not-attending-school-unesco-launches-global-coalition-accelerate>

Pre-service teachers' interpretation of technology-rich teaching and learning episodes

Marcantonio de Candia, Giulia Marchese, Federica Mennuni, Eleonora Faggiano

University of Bari Aldo Moro, Italy: federica.mennuni@uniba.it; eleonora.faggiano@uniba.it

This paper concerns a pre-service teachers' professional development (PD) program focusing on the use of technology in which participants: experienced collaborative task design of a teaching sequence; reflected on the implementation of the designed sequence; and performed detailed video analysis of a lesson in which the sequence they have designed was enacted by an expert teacher. We illustrate the case of a video analysis developed by one of the participants using the Semiotic Bundle lens and the Timeline tool. Results are presented and discussed with the aim of showing how the approach of this PD program can foster pre-service teachers' ability to interpret technology-rich teaching and learning episodes.

Keywords: Collaborative task design, Video analysis, Technology-rich teaching and learning episodes, Semiotic Bundle, Pre-service teachers' professional development.

Introduction

Many research studies are devoted to designing and evaluating teachers' education in mathematics and professional development (PD) programs focusing on the use of digital resources. In particular, teachers' design of teaching activities has been acknowledged to improve teaching practices (i.e. Zaslavsky, 2008). Moreover, videos have been recognised as effective tools for teachers' professional development: Sherin and Han (2004), for instance, underlined that video allows teachers to slow down instructional interactions and closely examine what happened. Gaudin and Chaliès (2015) identified two common objectives for the use of video as a tool for teacher learning: (1) building knowledge of how to interpret and reflect on episodes of teaching and learning; and (2) building knowledge of what to do. However, to the best of our knowledge, the joint experience of task design and video analysis in pre-service teachers' PD programs, particularly those aiming to integrate digital resources in mathematics education, has not yet been investigated enough. With this paper we attempt to contribute to this field. Offering and discussing the results of an ongoing study, we focus on pre-service teachers' interpretation of class activities involving digital resources. In particular, we are interested in how pre-service teachers interpret a teaching and learning episode and how the ability to perform this interpretation is affected by their involvement in task design and video analysis. To do this we illustrate and discuss the case of a pre-service teacher who participated in a PD program based on the joint experience of collaborative task design and individual video analysis. Her video analysis shows the effect of the PD program on her interpretation and reflection on a technology-rich teaching and learning episode.

Theoretical framework

In this section, we briefly present the theoretical point of view which framed this study. According to Clarke and Hollingsworth (2002) we believe that facilitating the professional development of teachers requires the recognition of the complexity of the process. The Clarke and Hollingsworth's

Interconnected Model suggests that teachers' professional learning occurs through the mediating processes of "reflection" and "enactment", in four distinct domains which encompass the teacher's world: the Personal Domain (teacher knowledge, beliefs and attitudes), the Domain of Practice (classroom experimentation), the Domain of Consequence (salient outcomes), and the External Domain (sources of information, stimulus or support). Hence, in accordance with this model, in our PD program we intended to offer pre-service teachers opportunities to facilitate their "reflection" (in Dewey's (1910) sense of "active, persistent and careful consideration") and inform their future professional "enactment" (to be seen as "the translation of a belief or a pedagogical model into action"). The main hypothesis of our work is that the joint experience of collaborative task design and video analysis can contribute to the pre-service teachers' professional growth. More precisely, we assume that the former represents the mean used to foster changes in their knowledge and beliefs informing future enactment. Whereas, the latter –in which they observe and interpret an expert teacher's behaviour while putting into action the outcomes of the former– constitutes the basis for their reflection.

Research questions

Analysing the case presented in this paper, we intend to study how the approach of the PD program –described in detail below– can foster pre-service teachers' ability to interpret technology-rich teaching and learning episodes. With respect to our hypothesis, the interpretation of an episode represents the way the reflection is exhibited. Thus, the research questions we aim to answer are: a) how does the pre-service teacher interpret the technology-rich teaching and learning episode? b) what are the effects of the joint experience of collaborative task design and individual video analysis on her ability to perform this interpretation?

Methods

Twelve pre-service mathematics teachers participated in a PD program articulated in the following phases: a) they were asked to accomplish, in small groups, a sequence of tasks involving the use of digital and non-digital resources and they discussed their experience (Mennuni & Faggiano, 2020); b) they were introduced to the theoretical perspective which framed the sequence that they were exposed to and they were asked to use it to collaboratively task design a similar sequence for middle school students (Mennuni et al., 2021); c) they experimented the designed sequence in an online 7th-grade class and collectively analysed its results using the theoretical framework they have used in the task design; d) they observed an expert teacher conducting the final revised version of the same sequence, in presence, in her 7th-grade class and they performed individual detailed video analysis of some teaching and learning episodes of this class activity.

The teacher who gave her availability to experiment with the sequence of tasks in her class has more than 15 years of teaching experience. She has a master's degree in mathematics and participated in many in-service professional development initiatives. She acted as a mentor teacher to pre-service and in-service teachers and coordinated many projects to foster STEM education in her school. For these reasons, she can be considered an expert teacher (Li & Kaiser, 2011). She was provided with a description of the tasks, as well as their aims, that compose the sequence as it was designed by the pre-service teachers during the collaborative phase of the program.

Each participant was invited to analyse some episodes, chosen according to the important aspects that emerged during the previous phases of the program, and to write a final report presenting and commenting on their video analysis. All the activities of the PD program have been video-recorded and the pre-service teachers' individual written reports have been collected. Due to the limits of space, in this paper, we refer only to the video analysis of one of the pre-service teachers (ST1), presenting the video analysis of the episode she considered most important. The results are discussed with the aim to identify elements revealing her reflections. In particular, we are interested in bringing to the fore how, with her video analysis, ST1 interpreted the teaching and learning episode and how her ability in the interpretation was affected by the previous activities experienced during the PD program.

The example of individual video analysis

In this section, we introduce the example of video analysis performed by ST1. The description of the example, that will be given in the results section, requires two preliminary brief insights. The first one concerns the description of the task at stake in the selected analysed part of the video. The second regards the theoretical point of view which framed the ST1's analysis, namely the Semiotic Bundle lens (Arzarello, 2008), based on the model of the space of Action, Production, and Communication (APC-space).

The description of the analysed task

The sequence of tasks, on which the PD program was focused, concerns the notion of rotation and is based on the synergic use of digital and non-digital resources (Faggiano & Mennuni, 2020). The part of the video that is analysed in the example refers to a collective discussion, orchestrated by the expert teacher, after the task in which students were asked to identify the centre of the rotation between two figures. Students have worked individually interacting with a GeoGebra file that displays two flags, one of which is the rotated version of the other: they were asked to identify the centre of the rotation that allows one flag to be transformed into the other. This is the most significant part of the entire teaching sequence on rotation, as it requires students to use the considerations and properties that have emerged in the previous parts. Indeed, to identify the centre, students need to use the already discovered property of rotated figures: each pair of corresponding points has the same distance from the centre of rotation. This means that the centre belongs to the perpendicular bisector of every segment joining each pair of corresponding points. Thus, to find the centre of the rotation it is necessary (and sufficient) to intersect any two of these perpendicular bisectors. The aim of the final discussion, hence, is to let students explain how they have found the centre, so that the discovered properties can give meaning to the rotation.

The Semiotic Bundle lens

The APC space has been introduced by Arzarello and colleagues (2009) as a model that intends to frame the processes that develop in the classroom among students and the teacher while working together. When students interact with each other and with the teacher during a specific classroom activity, the results are not a linear development, but a complex interplay of interactions composed of multimodal actions, productions, and communications. Consequently, as the variables present within the classroom are multiple and intertwined, teaching-learning processes become a complex

system whose analysis requires a multimodal perspective. However, the main components of the APC space –the body, the physical world, and the cultural environment– need to include students’ perceptual-motor experiences, their languages, the produced signs, and all the resources they use to interact with each other, the tools and the teacher. In these complex processes, the role of the teacher also turns out to be crucial. Her responsibility is to design and implement teaching activities appropriately and to foster the evolution of the students’ personal signs towards shared mathematical signs through her interventions. Arzarello chooses the semiotic lens to investigate the APC space, which he frames in the notion of Semiotic Bundle (SB). The latter is defined as a complex system, evolving over time, of signs that are produced by a student or a group of students to tackle an appropriate teaching sequence, while interacting with each other, with the teacher and with the resources. For a more in-depth analysis of all the interactions, video recordings play a crucial role because they can be examined in detail in order to analyse the observed processes carefully. Based on these videos, a transcript, including information about gestures, is produced and used to build the Timeline (TL). The TL is a table that offers an overview of the a posteriori micro-analysis of the elements that characterise the different registers of the SB: spoken (complete transcripts of the interactions between students and with the teacher); embodied (i.e., the gestures that represent the conversation and that are classified in McNeill’s (1992) four dimensions); written (the representations produced by the teacher and students).

Results







Time	00:08:00	00:08:03	00:08:03	00:08:05	00:08:06	00:08:20	00:08:48	00:09:00	00:09:15	00:12:27	00:12:42	00:12:50
	Teacher	Maria	Ilaria	Teacher	Ilaria	Teacher	Ilaria	Teacher	Ilaria	Teacher	Ilaria	Ilaria
Utterances	Teacher	Ilaria, what did you draw?		Why?		We said that the perpendicular bisector has two properties. What are they?		Each point on this perpendicular bisector has the same distance from the extremities. So, what can you say, Ilaria?		What did you do, Ilaria?		
	Students		The perpendicular bisector of the segment		Because that is the point that joins A with A', being the midpoint, maybe that is where the other midpoints of the other segments will be found		Every point on the perpendicular bisector is equidistant from the segment		So that if we find the other midpoints of BB', CC', DD' on that perpendicular bisector.	I drew the perpendicular bisector of the segment CC' too.		Maybe we can also test with the other segments and see if the midpoint is the one.
Gestures	Students		 iconic		 metaphoric		 metaphoric					
	Teacher							 metaphoric				
Interaction with artefact	Students											
	Teacher											

Figure 1: A part of the ST1’s TL

To analyse the way in which ST1 interprets the episode, we illustrate here, with ST1’s words, a part of the timeline she built (Figure 1) and the related comments that she wrote in her final report. Results refer to the episode in which students realise how to determine the centre of rotation. According to ST1’s added comments, the TL represents “the semiotic analysis of the crucial passage in the video”.

Moreover, to discuss ST1's interpretation it is worth noting that, with respect to the description of this task, in the introduction of her final report ST1 highlights that:

In this activity, the teacher's role is crucial in emphasising that the point is not to be positioned randomly but must be found by exploiting the properties that have emerged so far. If the teacher realises that none of her students can initiate a correct procedure, she could suggest considering the segments connecting the corresponding points and working on them.

The analysed episode lasts about 5 minutes and was described and commented by ST1 using the Timeline, partially shown in Figure 1. Below we present the comments she wrote to describe the TL.

0:08:00 - 0:08:03 - Ilaria had shared her screen with the class, and while looking for the centre of rotation she inserted an element, the perpendicular bisector of the segment, which was immediately observed by the teacher. Knowing that this was the correct procedure, she invited Ilaria to explain what she was doing and asked her what she had drawn. Ilaria soon answered: "the perpendicular bisector of the segment". At the same time, Maria iconically drew in the air, using the pen, first a vertical line from top to bottom and then a second line perpendicular to the first, marking the right angle that was formed. She also identified the perpendicular bisector.

It is worth noting that, although the teacher didn't react to Maria's gesture, ST1 decides to report it in the TL.

0:08:05 - 0:08:06 - The teacher asked Ilaria to clarify why she drew the perpendicular bisector of the segment. And once again she immediately answered: "Because that is the point that joins A with A' [n.a. the corresponding, rotated, point of A], being the midpoint, perhaps the other midpoints of the other segments will be found there". Ilaria realised that the midpoint of segment AA' alone cannot be the centre of rotation, because it is only equidistant from A and A'. Hence, she realised that it is necessary to also consider other segments, whose extremes are corresponding points. In fact, Ilaria's answer is accompanied by a metaphorical gesture, with which, moving her index finger from left to right repeatedly, she pointed to the segments connecting their respective extremes.

In what follows, the video shows Ilaria interacting with GeoGebra but her actions were not considered important by the teacher, and also by ST1. Indeed, ST1's TL and comments continue as follows:

0:08:20 - 0:08:48 - The teacher perceived that Ilaria possesses the notion of the perpendicular bisector. However, she asked Ilaria to remind her classmates what are the properties of this geometric concept. In this way, the teacher involved the entire class in the construction of the centre, making each pupil aware of the intermediate steps they are taking. Ilaria answered: "any point on the perpendicular bisector is equidistant from the segment". She further specified the mentioned property with a metaphorical gesture: Ilaria joined her hands as if they were on a point on the perpendicular bisector, and then moved them contemporaneously from the point of joining, emphasising the equidistance of each point on the perpendicular bisector from the extremes of the segment under consideration.

The TL part concerning the following seconds of the episode shows the teacher's reaction to Ilaria's reasoning. ST1's comments reveal the teacher's choice to let students follow Ilaria's reasoning and develop their own strategies to find the centre.

0:09:00 - 0:09:15 - The teacher obviously approved what Ilaria had said and repeated to the whole class the property interacting with GeoGebra. She initially pointed with the two index fingers to a random point on the perpendicular bisector of segment AA' and then simultaneously moved the index finger to A' and the left index finger to A. At this point, she asked Ilaria to continue with her reasoning. And Ilaria replied: "...if we find the other midpoints of BB', CC', DD' on that perpendicular bisector..." So, she has realised that the midpoint of a single segment is not enough. One more step, one more concept, is needed than that of the perpendicular bisector. Ilaria knows that all points on the perpendicular bisector of the segment have the same distance from the extremes, and she also knows that she is looking for a distance that is also valid for the extremes of the other segments. So, she wants to reproduce the construction of the perpendicular bisector made for segment AA' for the other segments. Ilaria's reasoning found favour with her classmates, who began to reason with her about the construction to be done to find the centre of rotation.

ST1's conclusion of the episode's analysis refers to the moment in which the teacher reacted to Ilaria's action on GeoGebra, displayed on the shared screen.

0:12:27 - 0:12:50 - While many in the class suggest how to proceed, Ilaria continued to work with GeoGebra. The teacher saw, via the shared screen, a new element in the construction and asked Ilaria what she has done. Ilaria replied: "I also put the perpendicular bisector of the CC' segment." The teacher continued: "Maybe we can also try the other segments and see if the midpoint is that one". Being aware of the properties of the perpendicular bisector and having realised that the centre of rotation must keep the distance from all the corresponding points, and not just to a pair of them, Ilaria drew two perpendicular bisectors. She observed that the point of intersection between the two perpendicular bisectors is precisely the sought centre of rotation.

Finally, ST1 highlights that the students' awareness comes through the focused interventions of the expert teacher. Indeed, she argues that "through the awareness of instructional goals, the teacher tries, with each of her interventions, to push students toward the goal, bringing to their attention the properties of the mathematical objects at stake".

Discussion

The episode that ST1 choose to perform her video analysis shows students' interactions with each other, with the teacher, and with the digital resource and highlights students' awareness of the properties of the rotation constructed in the previous phases of the teaching sequence. Moreover, the creation of the Timeline allowed ST1 to observe the importance of the teacher's role in conducting the collective discussion in accordance with the design and the aims of the teaching sequence. In particular, the detailed video analysis also allowed ST1 to realise how the verbal and non-verbal interactions between the teacher and the students resulted fundamental in the development of mathematical concepts. In her choice of the episode and in her TL we can recognise the effects of the collaborative task design. Thanks to the knowledge and the reflections developed during the PD program, indeed, ST1 became aware of the teacher's role that she sees to be "crucial in emphasising

that the point is not to be positioned randomly but must be found by exploiting the properties”. This can also be seen in ST1’s description of the first part (0:08:00 - 0:08:03) of the episode in which she pointed out the teacher’s awareness of the importance of Ilaria’s action with respect to the aim of the task: she highlighted that “knowing that this was the correct procedure, she invited Ilaria to explain what she was doing”. Moreover, ST1’s awareness of the role of the gesture in mathematics reasoning, allowed her to consider important also the iconic answers that Maria gave at the same time and in tune with Ilaria’s words. This choice was a consequence of the pre-service teachers’ discussions and insights developed during their collaborative work, so we can say that ST1’s interpretation of the episode was affected by the collaborative task design activities. The importance given by ST1 to the gestures as expressions of the students’ reasoning is evident also in the next parts of the episode (0:08:05 - 0:08:06) in which she felt the need to report on Ilaria’s metaphorical gestures. ST1’s comments here were still mostly related to the interpretation of what Ilaria was doing. However, they are the basis on which ST1 interpreted the teacher’s behaviour in the following part (0:08:20 - 0:08:48) of the episode. She highlighted, indeed, how the teacher’s behaviour was influenced by her perception of Ilaria’s reasoning on which she counts to make each pupil aware of the importance of the property recovered by Ilaria: “any point on the perpendicular bisector is equidistant from the segment”. ST1 again pointed out the role of Ilaria’s metaphorical gesture in emphasising the property verbally expressed. It is worth noting that the teacher’s approval of Ilaria’s reasoning was considered obvious by ST1 (0:09:00 - 0:09:15). This is because ST1 is aware of the importance of the property with respect to the aim of identifying the centre. At this point ST1 reported how the teacher interacted with GeoGebra, repeating to the whole class the property just recovered, and gave again Ilaria the floor. Here again ST1 interpreted Ilaria’s reasoning underlining that “she has realised that the midpoint of a single segment is not enough”. Her experience of collaborative task design influenced the following comment: “One more step, one more concept, is needed than that of the perpendicular bisector”. Indeed, she highlighted the most important aspects that Ilaria knows and interpreted her thinking: “she wants to reproduce the construction of the perpendicular bisector made for segment AA’ for the other segments”. Then, ST1 interpreted the teacher’s behaviour as driven by the willing to bring the other students “to reason with her about the construction to be done to find the centre of rotation”. The intervention of the teacher –“Maybe we can also try the other segments and see if the midpoint is that one”– finally, is considered to be crucial in order to reach the aim. It was interpreted by ST1 as guided by Ilaria’s awareness of the properties of the perpendicular bisector and of the centre of rotation that “must keep the distance from all the corresponding points”.

Conclusion

In this paper, we presented, briefly analysed and discussed the results of a pre-service teachers’ professional development (PD) program focused on the use of technology. The aim was to show that pre-service teachers experiencing detailed video analysis of a teaching sequence that they have contributed to design, can build knowledge of how to interpret and reflect on teaching and learning episodes. The video analysis of the teaching-learning processes carried out by ST1 allowed her to closely examine what happened. Her interpretation of the episode was affected by the *external stimuli* obtained (e.g. the focus on gestures) and the *personal knowledge* built (e.g. the notion of Semiotic Bundle) during the program, by the *experience* of task design collaboratively conducted with the

other participants and by the *outcomes* that she could observe in the video concerning the evolution of students' thinking and the produced signs. At the same time, the reflection on the episode based on the detailed video analysis acted as a mediator in the four domains described by the Interconnected Model. Hence, it contributed to the professional growth of ST1, building knowledge of how to interpret teaching and learning episodes and creating the basis to learn what to do. Results are intended to be enlarged by considering the cases of other participants and developing a further edition of the PD program in which the final stage would also see pre-service teachers personally put into action a teaching activity.

Acknowledgements

The authors are grateful to the expert teacher, Domenica Mastrandrea, and to her students.

References

- Arzarello, F., Paola, D., Robutti, O., & Sabena, C. (2009). Gestures as semiotic resources in the mathematics classroom. *Educational Studies in Mathematics*, 70(2), 97–109.
- Clarke, D. J., & Hollingsworth, H. (2002) Elaborating a model of teacher professional growth. *Teaching and Teacher Education*, 18(8), 947–967.
- Dewey, J. (1910). *How we think*. Heath & Co.
- Faggiano, E., & Mennuni, F. (2020) Constructing mathematical meanings with digital tools: design, implementation and analysis of a teaching activity in a distance education context, *IxD&A Journal -Interaction Design & Architecture(s)*, 46, 156–174.
- Gaudin, C., & Chaliès, S. (2015). Video viewing in teacher education and professional development: A literature review. *Educational Research Review*, 16, 41–67.
- Li, Y. & Kaiser, G. (Eds.). (2011). *Expertise in mathematics instruction: An international perspective*. Springer.
- McNeill, D. (1992). *Hand and mind: What gestures reveal about thought*. Chicago: Chicago University Press.
- Mennuni, F., Cutrone, F. N., de Candia, M., & Marchese, G. (2021) Costruire il significato di rotazione: dalla formazione alla sperimentazione. In B. D'Amore (Ed) *Atti del Convegno Incontri con la Matematica n.35*, (pp. 215-216) Pitagora Editrice: Bologna.
- Mennuni, F., & Faggiano, E. (2020) Math education master students focusing on teaching mathematics with digital resources. In Donevska-Todorova A., Faggiano E., Trgalova J., Lavicza Z., Weinhandl R., Clark-Wilson A., and Weigand H-G. (Eds.) *Proceedings of the 10th ERME Topic Conference MEDA 2020* (pp. 85–92). Johannes Kepler University of Linz.
- Sherin, M. G., & Han, S. Y. (2004). Teacher learning in the context of a video club. *Teaching and Teacher education*, 20(2), 163–183.
- Zaslavsky, O. (2008). Meeting the challenges of mathematics teacher education through design and use of tasks that facilitate teacher learning. In B. Jaworski & T. Wood (Eds), *The international handbook of mathematics teacher education* (Vol. 4, 93-113). Sense.

CSC Model – Learning mathematics on the basis of (digital) empirical settings

Frederik Dilling and Rebecca Schneider

University of Siegen, Germany;

dilling@matheematik.uni-siegen.de, schneider@mathematik.uni-siegen.de

This paper focuses on knowledge development processes of students with (digital) media in mathematics class. It presents the CSC model, which describes knowledge development based on empirical settings, i.e., learning environments with a focus on empirical objects. In this regard, the CSC model combines insights from scientific structuralism, constructivism, and the idea of situatedness of knowledge.

Keywords: Empirical settings, Empirical theories, Knowledge development processes, Subjective domains of experience.

Motivation

The teaching of mathematics at school is largely characterized by illustration and a reference to reality. Mathematical knowledge is not only used to describe empirical phenomena, but is essentially developed on the basis of these phenomena. For this purpose, learning environments in which empirical objects play a significant role are often used in the classroom – so-called empirical settings. The term empirical setting is very broad and ranges from geometric figures on a drawing sheet to scientific and life-world phenomena. The form of representation is not decisive, but the relation of an empirical setting to empirical objects or entities that can be described as empirical objects. An example of an empirical setting can be seen in figure 1. It is a screenshot of a GeoGebra Applet on teaching the integral in the context of lower, upper and trapezoid sums. By operating a slider, different divisions of the interval for the integral can be performed and the corresponding lower, upper and trapezoid sums are calculated and visualized. The empirical objects in this empirical setting are the function graphs, surfaces, etc., which students can actively operate and experiment with.

The aim of this paper is the presentation of a framework for describing knowledge development processes of students in such contexts – the CSC model (Dilling, 2022). The guiding hypothesis of the approach described in this paper is that students in a classroom with a focus on the visualization and the extra-mathematical application of the mathematical knowledge develop an empirical belief system about mathematics. A person's belief system as a mental structure has a significant influence on the way he or she deals with mathematics and behaves in mathematical situations. For an empirical belief system about mathematics, the mathematical concepts are ontologically bound in a way similar to concepts in the natural sciences.

The mathematical knowledge of students with an empirical belief system can be adequately described by the concept of empirical theories (Burscheid & Struve, 2020). In empirical theories, so called theoretical and non-theoretical terms are distinguished. For non-theoretical terms either empirical objects of reference exist (e.g. a function graph or a geometrical figure) or they have already been defined in a pre-theory. In contrast, theoretical terms acquire their meaning only in the respective

theory and their measurement presupposes the validity of that theory (Sneed, 1971). Examples for potentially theoretical terms are in the field of calculus limit, derivative and integral, in the field of stochastics probability or in the field of geometry the straight line. Whether a term is non-theoretical or theoretical depends on the underlying theory. Thus, in the case of describing student theories, it depends on the individual learner.

A further underlying assumption of this paper is the so-called domain specificity of knowledge, which is to be described with the concept of subjective domains of experience according to Bauersfeld (1983). The basis of this concept is that every human experience is made in a certain context and is bound in this way to the experiential situation. Experiences are stored in separate so-called subjective domains of experience (in short: SDE). Such an SDE includes the cognitive dimension of the experience as well as aspects like motor skills, emotions, valuations or self identity. The mathematical knowledge that learners activate can be understood as the cognitive part of subjective domains of experience and can be reconstructed as empirical theories. The totality of SDEs of an individual forms the so-called "society of mind". In this system, SDEs are non-hierarchically ordered and compete for activation. If a similar situation is repeated several times, this leads to a consolidation of an SDE and thus to a more effective activation in further situations. Frequent activation can change and reshape SDEs. SDEs that are no longer activated increasingly fade, but are not removed.

In knowledge development processes in mathematics education, the application of knowledge acquired in one context to further contexts is of particular importance. According to Bauersfeld (1983), this is done by attempting to link perspectives of different SDEs under the formation of a mediating SDE. This comparison can only occur from the perspective of the new mediating SDE, whose formation requires an active construction of meaning by the learner.

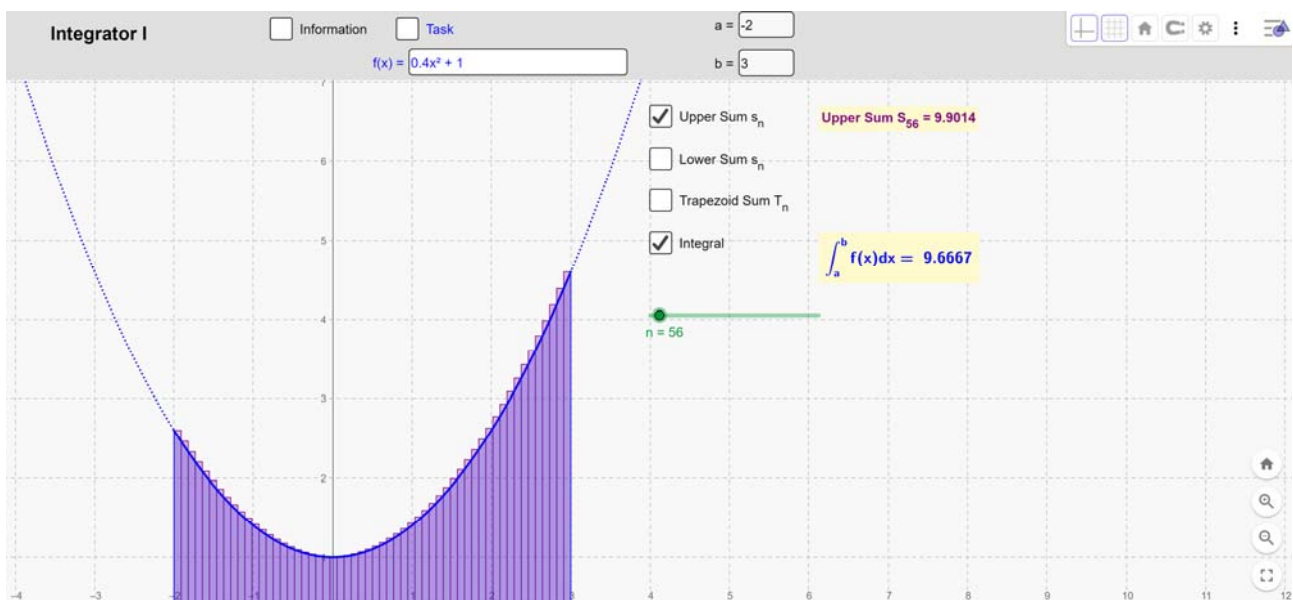

Figure 1: An example for an empirical setting – the applet Integrator by Elschenbroich (2017) in GeoGebra (translated into English by the authors)

Learning based on empirical settings

A basic assumption of the CSC model is, that empirical settings are not self-evident. According to constructivist learning theory, an empirical setting can be interpreted as part of an individual's experiential world in very different ways. There is no mathematical knowledge embodied in an empirical setting that students only have to extract. Instead, learners actively construct meanings of the empirical objects, which in some cases may be quite different from the intended interpretation based on the teacher's theory. The interpretation of an empirical setting in the intended way can be understood as an outcome of classroom negotiation processes which can lead to the development of patterns of interpretation (Voigt, 1994).

The reason for the different attributions of meaning can be seen in the underlying theories of the students and the teacher. To make knowledge development possible with an empirical setting, the person involved needs to integrate it into his or her individual theory. This is done by relating the concepts of one's own theory to the empirical objects. In the sense of the concept of subjective domains of experience, either an already existing SDE is activated or a new SDE is formed in the process of interpreting the empirical setting.

Through the interpretation of an empirical setting by a student, it can be described as an intended application of an empirical mathematical theory. The identification of properties of the empirical setting and their description with the help of a theory is done by the person working with the setting and interpreting it. Which properties are perceived in the setting and with which properties of the theory they are related depends on the individual. Moreover, in the development of theoretical terms, there are certain limits to the knowledge development processes - in this case, an empirical setting can be a heuristic tool in certain contexts and with regard to certain aspects, but a theoretical term cannot be derived from a setting.

A person's belief system about mathematics essentially determines the intentions for which the empirical setting is used. In the sense of a formal belief system about mathematics, empirical settings can be described as visualizations to which certain aspects of mathematical knowledge are applied. The empirical setting is used in particular to illustrate connections, i.e. it has a purely heuristic character. It can be assumed that many mathematics teachers have a formal belief system about mathematics. However, in the case of an empirical belief system about mathematics, the objects of the empirical setting form the reference objects of the empirical theory – accordingly, it can be used for further development and justification. Which properties interpreted in the empirical setting are transferred to one's own mathematical theory and which are not considered is determined by the individual using the setting.

The previous explanations can be summarized in a concept for the description of knowledge development processes with empirical settings in mathematics education. This is named CSC model (Dilling, 2020, 2022; Schneider, submitted) and refers to the terms concept, setting, and conception. According to the CSC model, empirical settings for mathematics education are specifically selected or developed in order to teach a certain mathematical theory. The process of developing or selecting an empirical setting that is considered adequate is carried out at various instances by researchers in mathematics education, textbook authors, and teachers and is based on the mathematical knowledge

results (Dilling, 2020, 2022; Schneider, submitted). The CSC model enables the precise description of interactions between teachers and students in the context of knowledge development processes in mathematics education. For this purpose, first the mathematical knowledge intended by a teacher for the empirical setting under consideration is reconstructed as a formalistic or empirical theory. This is followed by the description of the use of the setting by students and the reconstruction of the knowledge activated or developed in this context as empirical theories. The insights gained in this way provide multiple indications of opportunities and obstacles of empirical learning environments from an epistemological perspective. In the future research of the authors of this paper, the approach should be applied, among other things, to the field of differentiation and heterogeneity in mathematics classes as well as to professional digital competencies of mathematics teachers.

References

- Bauersfeld, H. (1983). Subjektive Erfahrungsbereiche als Grundlage einer Interaktionstheorie des Mathematiklernens und -lehrens. In H. Bauersfeld, H. Bussmann, G. Krummheuer, J. H. Lorenz, & J. Voigt (Eds.), *Lernen und Lehren von Mathematik* (pp. 1-56). Köln: Aulis.
- Burscheid, H. J., & Struve, H. (2020). *Mathematikdidaktik in Rekonstruktionen. Ein Beitrag zu ihrer Grundlegung*. Wiesbaden: Springer Spektrum.
- Dilling, F. (2020, online first). Zur Rolle empirischer Settings in mathematischen Wissensentwicklungsprozessen – eine exemplarische Untersuchung der digitalen Funktionenlupe. *Mathematica Didactica*.
- Dilling, F. (2022). *Begründungsprozesse im Kontext von (digitalen) Medien im Mathematikunterricht. Wissensentwicklung auf der Grundlage empirischer Settings*. Wiesbaden: Springer Spektrum.
- Elschenbroich, H.-J. (2017). Anschauliche Zugänge zur Integralrechnung mit dem Integrator. *MNU-Journal*, 5/2017, 312–317.
- Schneider, R. (submitted). Komparative Fallanalysen zur Spezifität von Wissensentwicklungsprozessen in empirischen Settings im Mathematikunterricht der Grundschule.
- Sneed, J. D. (1971). *The Logical Structure of Mathematical Physics*. Dordrecht: Reidel.
- Voigt, J. (1994). Entwicklung mathematischer Themen und Normen im Unterricht. In H. Maier, & J. Voigt (Eds.), *Verstehen und Verständigung: Arbeiten zur interpretativen Unterrichtsforschung* (pp. 77-111). Köln: Aulis.

Subject-related implementation of (digital) media by mathematics teachers – A theoretical framework

Frederik Dilling, Rebecca Schneider and Kevin Hörnberger

University of Siegen, Germany; dilling@matheamatik.uni-siegen.de , schneider@mathematik.uni-siegen.de , hoernberger@mathematik.uni-siegen.de

The implementation of digital technologies in mathematics classes is gaining an expanding role in the last years. An increasing availability of digital tools and materials in combination with political requirements faces mathematics teachers with new challenges, as the use of digital technologies for initializing mathematical learning processes is now becoming a fundamental part of mathematics teaching. In this article, the MPC model will be presented, which is a framework for describing professional digital competencies of mathematics teachers.

Keywords: Digital competencies, digital transformation, subjective domains of experience, TPACK.

Motivation

The digital transformation in education faces mathematics teachers with great challenges. A variety of new digital technologies and approaches are available, which have to be selected and integrated in a meaningful way for teaching the mathematical content. To accomplish this task, teachers need to develop subject-related professional (digital) media competence (Geraniou & Jankvist, 2020). This paper presents a model for describing the professional media competence of mathematics teachers and its development – the MPC model (media, pedagogy, content).

Professional media competence is understood in this context as the competence that enables a teacher to select and use an appropriate educational medium for teaching a particular mathematical content or activity. As a basis for the MPC model, the well-known TPACK model (Koehler & Mishra, 2009) (technological pedagogical content knowledge) has been used, which distinguishes knowledge dimensions related to digital technologies in subject teaching. However, modifications were made to the model for several reasons, which will be explained below.

MPC Model – Describing professional media competence of mathematics teachers

Digital media in a broader context

While the use of digital media is important for modern mathematics education, it is not a basic requirement for substantial mathematical learning processes. Despite the great new possibilities, mathematics can also be taught without digital media. Alternatively to the TPACK model, we suggest to consider professional digital competencies in a broader context of professional media competencies, which also include knowledge about the appropriate use of analog media.

In the approach described here, digital media are understood as an extension or a further possibility in addition to analog media for teaching mathematical content at school. This further possibility is neither better nor worse per se – it is different. An essential task of teachers is to select suitable media

for certain learning situations. Teaching media in general, in contrast to digital media in particular, represent a precondition for learning at school. A learning environment is always tied to and shaped by a teaching medium. The medium serves the mediation between the development of mathematical competencies and the understanding of mathematical concepts and relationships (Barzel & Greefrath, 2015).

The MPC model is based on the described ideas and considers professional *digital competence* D as a subset of professional *media competence* M :

- D : professional digital competence (referred to digital media)
- M : professional media competence (referred to media in general)
- $D \subset M$

In analogy to the TPACK model (Koehler & Mishra, 2009), the content competence C and the pedagogical competence P represent further considered competence dimensions:

- C : professional content competence (referred to the mathematical content)
- P : professional pedagogical competence (referred to methods and approaches)

These three competence dimensions of professional teacher action build intersections with each other. For example, content competence C also includes knowledge about methodological approaches to certain content. However, at the same time these are also part of the pedagogical competence P . The intersection of both competencies shall be referred to as pedagogical-content competence PC (see figure 1).

Analogously, the professional media competence of teachers includes but is not limited to:

- MC : content-related media competence
- MP : pedagogical media competence
- MPC : content-related pedagogical media competence
- $MC \cup MP \cup MPC \subset M$

The focus of our descriptions is on the content-related knowledge dimensions that are specific to mathematics education.

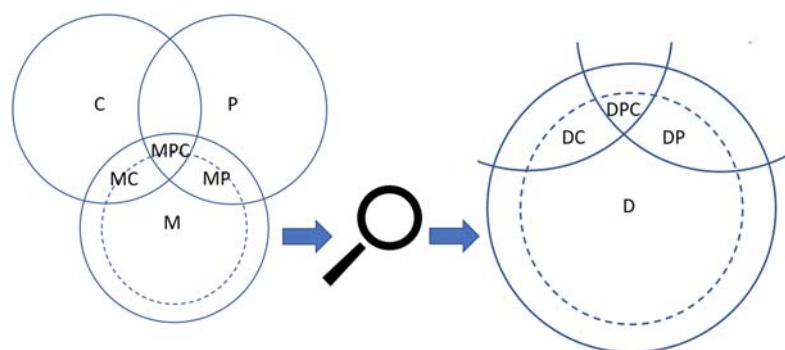

Figure 1: Professional digital competencies as part of professional media competencies

Situatedness as a challenge for media competencies – Focus on a reflective level

The previously presented approach will now be further specified. This is because the general concept of (digital or analog) media cannot address the specifics of the various media under consideration, which are important for teaching and learning. In systematic observations of teachers working with digital media in the mathematics classroom, we found out that the suitable use of one digital medium in a certain context does not indicate the ability of the same mathematics teacher to also reach a subject-specific, suitable selection in another context. Many elements of teachers' competencies relate to specific media and not to media in general. Context also plays a role in the TPACK model as “the impact of teachers and their knowledge on students depend upon how successfully each teacher adapts to the unique context“ (Rosenberg & Koehler, 2015, p. 4).

From an epistemological perspective, this phenomenon can be described with the concept of subjective domains of experience by Bauersfeld (1983). This concept assumes that every human experience is made in a specific context and is attached to the situation in which the experience was made. These experiences are saved in subjective domains of experience (short: SDEs) that are initially isolated from each other. The complete set of experiences stored in this way is called the "society of mind". Within this society of mind, SDEs compete for activation to determine the thoughts and actions of an individual in a specific situation – the individual has no direct influence on the activation of an SDE and it is an unconscious process. An SDE refers either directly to an individual's experiential world (e.g., a specific digital medium), or to other SDEs (a mediating SDE). A mediating SDE enables the individual to select between the perspectives of different SDEs and opens up a level of reflection.

The MPC model describes media competence composed of an individual's SDEs related to media as a subset of the "society of mind". The concept of SDEs can do justice to the breadth of the definition of competencies, which not only relate to knowledge, but also include motivational, volitional, and social components and thus enable the operation in a situation when activated. The (concrete and mediating) SDEs of a person with reference to media shall be denoted by M_1, \dots, M_n . Analogously, the SDEs that (also) refer to digital media shall be named D_1, \dots, D_m . The following applies with respect to these elements:

- S : „society of mind“ (set of all individual's SDEs)
- M : professional media competence (set of all individual's SDEs referred to media)
- $M \subset S$
- $M_{i \in 1, \dots, n}$: SDE referred to media
- $M = \{M_1, \dots, M_n\}$
- D : professional digital competence (set of all individual's SDEs referred to digital media)
- $D_{j \in 1, \dots, m}$: SDE referred to digital media
- $D = \{D_1, \dots, D_m\}$
- $\{D_1, \dots, D_m\} \subset \{M_1, \dots, M_n\}, m < n$

This model of professional media competence and professional digital competence is broad. It is therefore recommended to give special attention to the content-related (digital) media competence.

Furthermore, in the opinion of the authors, the further development of professional media competence should focus on the formation of mediating SDEs, because only those enable a reflective level on which a professional selection of a suitable (digital) medium from a subject-specific and subject-didactic point of view is possible. In this reflection, possibilities and limitations of several (digital) tools and materials can be compared regarding the initiation of mathematical learning processes.

Outlook

The MPC model briefly presented in this paper aims at describing professional media competence of mathematics teachers. The three most important perspectives of the MPC model are the examination of professional digital competence in the larger context of professional media competence, the situatedness of subjective experiences regarding specific media, and the importance of a reflective level for assessing the possibilities and limitations of different media in comparison (see figure 2).

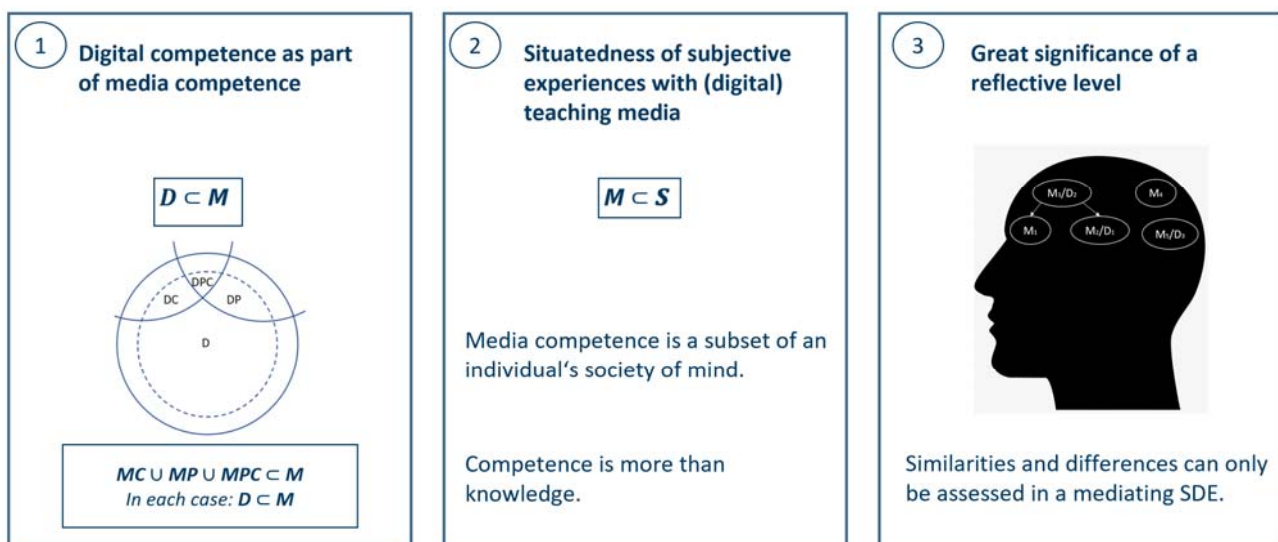

Figure 2: Important perspectives of the MPC model

The approach results from the authors' experience of working intensively with practicing mathematics teachers. It forms the basis for research in the DigiMath4Edu project at the University of Siegen (Dilling et al., 2022). The project investigates how professional digital competence can be (further) developed and what conditions for the success of digital transformation processes in the field of education are important. In this context, the authors are developing questionnaire and interview formats, in order to be able to assess professional media competence on the basis of the MPC model.

In order to clarify the terminology of the MPC model, a short excerpt from an interview with a mathematics teacher from the DigiMath4Edu project will be described here:

Interviewer: Do you somehow see certain contents and methods that are particularly suitable in connection with the different media? Or is it rather the case that many of these media can be used for everything in a meaningful way?

Teacher: Well, the latter definitely applies to GeoGebra. I've really become a fan of it. When you switch from the handheld calculator to GeoGebra, the simple functions, first, seem more complicated. But that passes with the routine and

there is no topic in mathematics from middle school onwards where you can't use GeoGebra in a meaningful way, and there is also no phase of the lesson or the series of lessons where you can't always use it to the full. Um, regarding 3D printing, I'm very enthusiastic about the solids of revolution. I am also looking forward to being convinced of other things.

The teacher reports about his experiences with GeoGebra as well as 3D printing. Based on his reflections, two SDEs can be reconstructed: M1 about the use of GeoGebra and M2 about the use of 3D printing. Both SDEs seem to involve content-related media competence MC. However, this is apparently shaped very differently. In GeoGebra, the teacher perceives many connections to mathematical content. However, he does not make any concrete statements, so it cannot be verified which application areas he actually considers. In the area of 3D printing, the content-related connection is rarely present. He only knows one application from mathematics (solids of revolution). Whether there is a connection between the two SDEs M1 and M2 cannot be seen from this short excerpt.

References

- Dilling, F., Hörnberger, K., Reifenrath, M., Schneider, R., Vogler, A., & Witzke, I. (2022). Das Forschungs- und Entwicklungsprojekt DigiMath4Edu [The research and development project DigiMath4Edu]. In F. Dilling, F. Pielsticker, & I. Witzke (Eds.), *Neue Perspektiven auf mathematische Lehr-Lern-Prozesse mit digitalen Medien* (pp. 73-84). Wiesbaden: Springer Spektrum.
- Barzel, B., & Greefrath, G. (2015). Digitale Mathematikwerkzeuge sinnvoll integrieren [Integrating digital mathematics tools meaningfully]. In W. Blum, S. Vogel, C. Drücke-Noe, & A. Roppelt (Eds.), *Bildungsstandards aktuell: Mathematik in der Sekundarstufe II* (pp. 145–157). Braunschweig: Westermann.
- Bauersfeld, H. (1983). Subjektive Erfahrungsbereiche als Grundlage einer Interaktionstheorie des Mathematiklernens und -lehrens [Subjective domains of experience as a basis of an interaction theory of mathematics learning and teaching]. In H. Bauersfeld, H. Bussmann, G. Krummheuer, J. H. Lorenz, & J. Voigt (Eds.), *Lernen und Lehren von Mathematik* (pp. 1-56). Köln: Aulis.
- Geraniou, E., & Jankvist, U. T. (2020). “Mathematical digital competencies for teaching” from a networking of theories perspective. In B. Barzel, R. Bebernik, L. Göbel, M. Pohl, H. Ruchniewicz, F. Schacht & D. Thurm (Eds.), *Proceedings of the 14th International Conference on Technology in Mathematics Teaching – ICTMT 14* (pp. 368-375). Essen University of Duisburg-Essen.
- Koehler, M. J., & Mishra, P. (2009). What is technological pedagogical content knowledge? *Contemporary Issues in Technology and Teacher Education*, 9(1), 60-70.
- Rosenberg, J., & Koehler, M. J. (2015). Context and Technological Pedagogical Content Knowledge (TPACK): A Systematic Review. *Journal of Research on Technology in Education*, 47(3), 186-210.

Digital quiz activities for personalization of learning paths in mathematics education

Ana Donevska-Todorova

University of Applied Sciences HTW Berlin, Germany; ana.donevska-todorova@htw-berlin.de

While multiple choice and short answer questions are often related to procedural rather than conceptual understanding in mathematics education, innovative hybrid or asynchronous teaching approaches benefit from their didactical potential in supporting differentiation and individualization of learning trajectories. This paper discusses design, usage, and sustainability aspects of individual and collaborative digital quiz activities in learning management systems. In a first design research cycle, results of an empirical pilot trial of generated and implemented automated quiz activities with immediate feedback reveal promising results of university students' performance in financial mathematics.

Keywords: active learning, adaptive learning pathways, personalized learning, learning management systems, mathematics education.

Introduction

Sustainable quality guidance of masses of students with heterogeneous content-related competencies and skills in remote settings evolved since and during the COVID-19 pandemic. Curricular macro digital resources and micro e-content and e-activities that allow learners' individual learning experiences are in high demand in the disciplines related to applied mathematics. The need and search for student-centered individual and collaborative digital activities that can make learning goals more appealing and achievable are growing (Donevska-Todorova, 2022).

Multiple choice questions and closed short answer quiz tasks are usually perceived as having limited potential in promoting conceptual understanding, problem-solving or modeling competencies in mathematics education. Yet, digital quiz tasks can engage learners in meaningful mathematical and self-regulated activities that are of relevance in asynchronous or hybrid teaching settings. Within a long-term project digital quiz queries are generated to be thought-provoking and sufficiently complex, consisting of several sub-tasks that require not only computational skills, but also logical reasoning and algebraic thinking. They should secure achieving standardized learning outcomes, yet through individualized delivery of content and rapid and frequent feedback.

Literature review and theoretical grounding

Research on the use of quizzes in mathematics education shows their potential to boost students' performance (Griffin & Gudlaugsdottir, 2006) or measure mathematics achievement through formative assessment (Blanco & Ginovart, 2012) or both formative and summative assessment. Through measuring the number of attempts, the time of their occurrence and the achieved results quizzes support assessment in distance learning settings (Lowe, 2015). Later studies (e.g., Nguyen-Huy et al., 2022) explore the intensive use of quizzes for predicting students' scores and grades by applying probabilistic models and learning analytics methods. A legitimate question today is how

micro e-activities such as digital quiz tasks can contribute to actively engaging students in meaningful learning processes in which they can perceive themselves as thinkers and doers of mathematics. While some investigations have been focusing on questions about the fairness and effectiveness of online quizzes in mathematics engineering courses (Martins, 2018), this research work is dedicated to exploring the potentials, design, implementation, efficiency, and scale of digital Quiz and StudentQuiz activities for personalizing learning pathways through adaptive strategies as adaptive feedback and task design in mathematics educations. Moreover, I look not only at the likely benefits of this teaching approach for university instructors, but its effects on the formation of unique learning trajectories through engagement in the collaborative activity StudentQuiz consisting of individually produced tasks (Donevska-Todorova, 2022).

Active learning, adaptive learning, and personalized learning

Application of single or disjoint ‘old’ theories for grounding research in mathematics education seems insufficient to explore and thoroughly explain challenges related to the major rise of numerous novel digital technologies and tools and their intensified implementation in the last two years. Therefore, three theoretical concepts: active learning, adaptive learning, and personalized learning serve for grounding this research. *Active learning* is related to student-centered intensive participation and engagement with mathematical activities. Emerging pedagogical approaches are related to adaptive and personalized learning. In comparison to computer and informatics sciences, this research does not attempt to develop new software using neural networks or complex intelligent agents; rather investigates the effects of existing ones on learning. In *personalized learning*, instructional design is customized to individual learning needs and pace. Although there is currently no consensus on a unique definition about *adaptive learning*, it is mainly related to processes that can be shaped, scaled, and monitored by technology with algorithms that provide real-time data.

Research questions and methodology

RQ: How can students' learning pathways be tracked in Moodle online quizzes?

The participants that are enrolled in the module are also participating in the Moodle course about corporate finance. There were 19 participants who voluntary undertook the quiz activity about financial mathematics. The data are collected via the Moodle course considering ethical aspects, anonymised and then further quantitatively and qualitatively analysed. Additional data about the achievements of another group of students on the same quiz activity will be collected in another Moodle course within the design experiments of the first design research cycle. Contextual examples are provided by Donevska-Todorova et al., (2022).

Results and discussion

Self-regulation in learning and academic achievement in quiz activities is related to timely and continuous automated feedback (Donevska-Todorova, Dziergwa, & Simbeck, 2022). This section reports on the practical implementation and the initial empirical results of one segment of an adaptive learning trajectory based on a designed Quiz activity in the first design-research cycle.

The question bank for the quiz activity is structured in four categories: (i) basic rules for exponentiation, (ii) percentage, (iii) operations and relations with fractions, and (iv) financial

mathematics. The tasks in the fourth category refer to applications of basic mathematical operations for calculating rates of interest and their interpretation in realistic scenarios. The generation and the design of the tasks in these categories go beyond simple multiple-choice questions and are of various types such as multiple true/false, numerical, drag-and-drop, and short answer queries. Moreover, the quiz activities include Moodle Cloze tasks combining and integrating several of the above types of tasks into one. Creation of this type of tasks requires more complex syntax than the other previously mentioned. The task generation, regardless of the type of the tasks, involved the application of LaTeX in different parts of their structure: task formulation, automated feedback, hints, and solutions.

The quiz activity is structured analog to the question bank. Two tasks in the quiz activity appear with double randomization within each of the four categories (i) to (iv). That makes 8 tasks in total in the quiz.

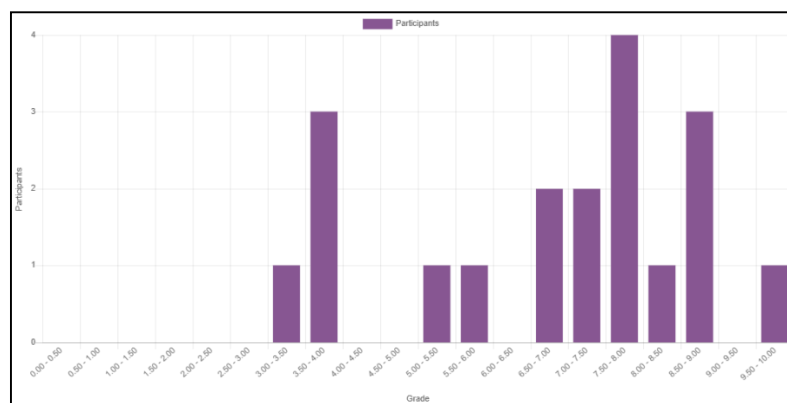

Figure 1: Overall number of students' achieving grade ranges

Figure 1 shows the overall number of students' achieving grade ranges on the first quiz activity. The average grade is 6.69 (19) out of 10. The learning analytics of the Moodle course provide quantitative data for the distribution of the scores average per task and it is shown in Table 1.

Table 1: Overall score average per task

	T1	T2	T3	T4	T5	T6	T7	T8
	1.25	1.25	1.25	1.25	1.25	1.25	1.25	1.25
Overall score average per task	0.92	0.87	0.99	0.92	0.96	0.91	0.53	0.59

Further qualitative analysis of the data points out that the average scores on the tasks in the first three categories are higher than the scores in the category (iv). This confirms the assumption that the applied problems are the most challenging. This information is taken as input for the creation of new tasks for the follow-up Quiz and other activities in the learning management system.

Conclusions

Learning management systems allow the personalization of learning trajectories through adaptive activities and automated feedback. This paper shows students' achievements and frequencies (Figure 1 and Table 1) on created quiz activities tracked in Moodle, which is related to the research question.

Immediate feedback messages of diverse types during the quiz activity aimed at strengthening the personalization of the learning pathways. The heterogeneous students' achievements per task serve as input for the further phases of the design research cycle.

Acknowledgments

This paper is part of the project “Curriculum Innovation Hub” at the University of Applied Sciences HTW Berlin financed by “Stiftung Innovation in der Hochschullehre”. I sincerely thank Prof. Dr. Katrin Dziergwa and Prof. Dr. Katharina Simbeck for their support.

References

- Blanco, M., & Ginovart, M. (2012). On how moodle quizzes can contribute to the formative e-assessment of first-year engineering students in mathematics courses. *RUSC, Universities and Knowledge Society Journal*, 9(1), 354-370.
- Donevska-Todorova, A., Dziergwa, K., Simbeck, K. Individualizing Learning Pathways with Adaptive Learning Strategies: Design, Implementation and Scale. In Proceedings of the 14th International Conference on Computer Supported Education (CSEDU 2022), 2022.
- Donevska-Todorova, A. (2022). Individual, but not alone! Design of individual and collaborative activities for adaptive learning pathways in learning management systems, *inted2022 proceedings*, pp. 8890-8897. doi: [10.21125/inted.2022.2319](https://doi.org/10.21125/inted.2022.2319)
- Griffin, F., & Gudlaugsdottir, S. (2006, July). Using online randomised quizzes to boost student performance in mathematics and operations research. In *2006 7th International Conference on Information Technology Based Higher Education and Training*, pp. 481-489. IEEE. doi: 10.1109/ITHET.2006.339800.
- Jankvist, U. T., Sánchez Aguilar, M., Misfeldt, M., & Koichu, B. (2021). What to Replicate?, Implementation and Replication Studies in Mathematics Education, 1(2), 141-153. <https://doi.org/10.1163/26670127-01010015>
- Leung, A.; Bolite-Frant, J. Designing mathematics tasks: The role of tools. *In Task Design In Mathematics Education: An ICMI Study 22*; Watson, A., Ohtani, M., Eds.; Springer: Cham, Switzerland, 2015; pp. 191–225. [Google Scholar] [CrossRef]
- Niss, M.; Højgaard, T. Mathematical competencies revisited. *Educ. Stud. Math.* 2019, 102, 9–28.
- Lowe, T. W. (2015). Online quizzes for distance learning of mathematics. *Teaching Mathematics and Its Applications: An International Journal of the IMA*, 34(3), 138-148.
- Martins, S. G. (2018). A Study of the Application of Weekly Online Quizzes in Two Courses of Mathematics for Engineering Students—Is it a fair and effective strategy to increase students' learning?. *International Journal of Innovation in Science and Mathematics Education*, 26(1).
- Nguyen-Huy, T., Deo, R. C., Khan, S., Devi, A., Adeyinka, A. A., Apan, A. A., & Yaseen, Z. M. (2022). Student Performance Predictions for Advanced Engineering Mathematics Course with New Multivariate Copula Models. *IEEE Access*.

Networking the theoretical constructs of computational thinking and techno-mathematical fluency through a geometrical task

Raimundo Elicer¹ and Andreas Lindenskov Tamborg²

¹Aarhus University, Denmark; raimundo@edu.au.dk

²University of Copenhagen, Denmark; andreas_tamborg@ind.ku.dk

Frameworks for mathematical learning have been updated to make sense of digital tools, leading to the notion of mathematical digital competencies. In particular and in parallel, the computational thinking (CT) construct has gained relevance, and the mathematics curriculum takes part in this wave of interest. We offer a theoretical discussion on the meanings and implications of enabling techno-mathematical discourse at the intersection of CT and mathematical digital competencies. We do so by networking theories anchored in episodes from an implemented geometry task. A computer-mathematical fluency is not a particular case of techno-mathematical discourse, and it must entail combining and disambiguating computer and mathematical knowledge. It relates to the artefact-instrument duality to communicate through and with the computer environment through instrumented actions to construct computer models in mathematical situations.

Keywords: Computational thinking, digital competence, mathematical competencies, networking theories, programming.

Introduction

Since Wing's (2006) seminal paper, computational thinking (CT) has gained relevance in educational contexts. She portrayed CT as a set of teachable skills for everyone, disjoining its exclusivity to computer scientists. From this point, CT has become part of mainstream curricula in many countries (Bocconi et al., 2022), often connected to school mathematics due to historical, epistemological and pedagogical reasons. Consequently, plenty of research has been dedicated to addressing the potential role of CT in mathematics classrooms. Overall, CT can be a tool for mathematical problem solving through computational ways of thinking (e.g., abstraction and modelling), and building solution strategies that can be transferred to other humans or computers (Kallia et al., 2021).

However, a vast body of knowledge in the relation between mathematics learners and digital technologies has been developed before and in relative isolation from the CT trend. As a way of connecting digital to mathematical competence, Geraniou and Jankvist (2019) networked frameworks to introduce the notion of mathematical digital competencies (MDC). These are summarised into three aspects (p. 43): the ability "to engage in techno-mathematical discourse" (MDC1), an awareness of "which digital tools to apply within different mathematical situations and contexts, and "their "capabilities and limitations" (MDC2), and the ability to "use digital technology reflectively in problem solving" (MDC3). In this paper, we narrow down our discussion to MDC1.

Geraniou and Jankvist (2019) built on Jacinto and Carreira's (2017) concept of techno-mathematical fluency, illustrated by the collective student-with-GeoGebra, and defined as "the ability to combine two types of background knowledge and skills—mathematical and technological—constantly being intertwined to develop techno-mathematical thinking" (p. 1122). These definitions are anchored in

empirical research involving digital artefacts designed for mathematical activity, namely MathCad and GeoGebra. However, as Wing (2006) puts it, computational thinking is “a way that humans, not computers, think” (p. 35). Therefore, CT is a broader construct and performable in many different artefacts and computer environments or none at all.

Therefore, as much as CT is easily associated with computer artefacts, defining a techno-mathematical fluency when the *techno* side is not attributable to a mathematical instrument needs further examination. We thus aim to address the following research question: *What are the meaning and implications of techno-mathematical discourse in the intersection between CT and mathematical digital competencies?*

The research question implies a dialogue between theoretical perspectives. Similar to Geraniou and Jankvist (2019), we engage in a networking of theories strategy (Prediger et al., 2008), with an empirical basis on a geometry classroom intervention that took place as part of the overarching project this paper is embedded in. The paper is structured as follows. We first give a face-value description of selected episodes from this intervention. We then unfold the theoretical constructs and our strategy to network them. Next, we analyse elements of these theories anchored in three illustrative episodes. Finally, we discuss how CT and MDC1 are related but not merely a particular case of one another.

A geometry task on Scratch

The task at hand was designed in close collaboration with a Danish mathematics teacher and implemented with her 6th-grade class. The core idea is that students should draw simultaneously on their mathematical and programming learning to solve the task. See Elicer et al. (2022) for a more elaborate description and discussion of the design process and decisions.

In this paper, we focus on the second of three sessions. Here, students were initially asked to try drawing a polygon of their choice in the Scratch environment. The teacher starts displaying an exemplary code (Figure 1) where a sprite endlessly draws a square and asks them to fix it. A group of students proposes replacing the “forever” loop with a “repeat 10”:

- Teacher: Then there is such a “loop” here, as we call it, which says “repeat 10 times”. And where is there something that is off about it? Who can see it? Danny?
- Danny: Just wait, I just have to...
- Teacher: Nick?
- Nick: That it keeps doing it all the time.
- Teacher: Do you mean it has to repeat 10 times?
- Nick: I mean, 10 times will do.
- Teacher: Ah! There is something here. Danny, have you noticed it?
- Danny: Uh, it does not have to repeat it so many times or it probably does not have to walk 100 steps.
- Teacher: Yes, but it says so there, what is off, then?
- Elvis: It only has to repeat it 4 times.
- Teacher: Why?
- Elvis: Because with that, it gets a whole square.

This group of students did not mind the “forever” loop operator in Scratch. The code programs infinite squares on top of each other, without affecting the solution (Figure 1). The teacher had to prompt Danny to find an error in it to suggest a “repeat” loop instead. Nick says that “10 times will do”, and Elvis finally notices that “it only has to repeat it 4 times”.

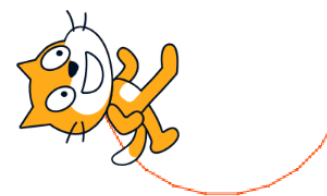
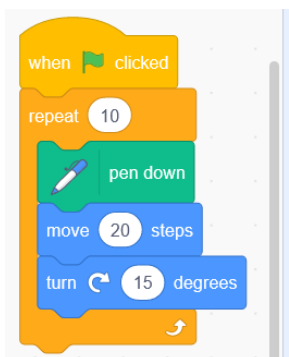
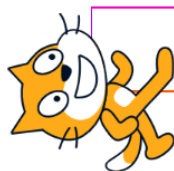
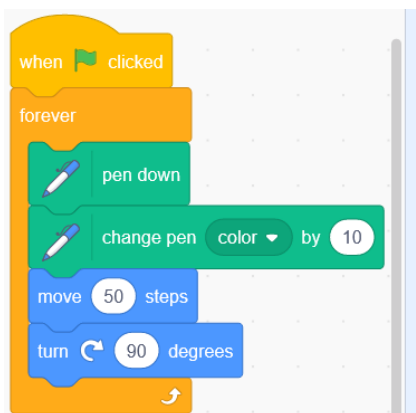

Figure 1: Teacher’s displayed code where sprite does not stop **Figure 2: An approximated circle arc on Scratch**

Afterwards, the teacher encourages them to explore different polygons. Most students kept the number of repetitions and tried with smaller angles. This may be because an excess of repetitions does not appear to hurt the drawn outcome. However, this fails with, for example, 15° (Figure 2):

- Andy: You (Sam) made such an arc-like one.
 Teacher: Yes, a smiling mouth (Figure 2), one could say, right? Then it just turned out to be nothing. If I want to fix it into a finished figure, then I should not just do it 10 times.
 Andy: Then it should have been 20, or what? Or 40?
 Teacher: Could you somehow calculate if it turns 15° ? Could you somehow figure it out?
 Andy: 30 times.
 Teacher: Oops! Someone is starting to think. (...) You are welcome to talk a little with each other about it (student small talk). Now that we have decided that it should go 15° , how many times does it then have to repeat? How can I figure it out?
 Andy: It has to be repeated 25 times.
 Teacher: Why, Sam?
 Sam: If we say 10 once more, then it is almost made, then a small part is missing and then 5 they take those.
 Teacher: You think that smiling mouth could become a circle maybe, or what?
 Sam: Yes.
 Bob: I think so.
 Teacher: Hector, what do you think?
 Hector: Is it 24 times?
 Teacher: Why?
 Hector: Because then it divides up into 360.

This group turned the polygon problem into a circle problem. Andy, Sam and Bob are probing with repetitions. Andy gets close, and Hector figures out that the total number of turning angles should add up to 360° , a full circle. A 15-degrees turn should be repeated 24 times.

Next, the students were to share their experiences in a collective wrap-up session guided by the teacher. She started by asking another student, Izzie, who tried out with a turning angle of 45° to see what happened. As a disclaimer, the teacher refers to the angle “in” the octagon not as an internal angle but in the Scratch code that draws it:

- Teacher: I want to know what kind of polygon it is. Which kind have you made?
 Izzie: Octagon.

Teacher: Octagon, then I go down here to octagon. Octagon. What is the angle in your octagon?
 Izzie: What?
 Teacher: What is the angle in your octagon? What was the angle in the octagon you made? How big was it?
 Izzie: 45.
 Teacher: 45°, then I write 45 here (cell B8, Figure 3). There was one more thing up on the board I was interested in. What was it?
 Izzie: Angle sums...
 Teacher: What was the sum of the angles? How can I find the sum of the angles? ... How can I find the angle sum in that octagon when I know that an angle is 45°? What do you say (Elvis)?
 Elvis: Is it not by multiplying how many sides there are? What is it called—the angle. Or to multiply the angle by the sides (mumbles)?
 Teacher: Yes, and what does it give, then?
 Elvis: 360.

This dialogue leads the teacher to give the general instruction to fill an Excel sheet, particularly columns B and C in Figure 3, to verify Elvis’ conjecture. Figure 3 is one core output from implementing the task. In column B, they registered the angles at which their sprites had to turn to draw each regular polygon on Scratch. In column F, they did so after using GeoGebra’s “Regular Polygon” feature. Respectively, they registered the sums of angles on columns C and G.

	A	B	C	D	E	F	G
1	Kant	Vinkel Scratch	Vinkelsum			Vinkel GeoGebra	Vinkelsum
2							
3	3-kant	120	360			60	180
4	4-kant	90	360			90	360
5	5-kant	72	360			108	540
6	6-kant	60	360			120	720
7	7-kant	51	360			128,57	899
8	8-kant	45	360			135	1080
9	9-kant	40	360			140	1260
10	10-kant	36	360			144	1440

Figure 3: Excel screen capture of students’ collection of angles and sum of angles by means of Scratch and GeoGebra (‘kant’ is ‘side’; ‘vinkel’ is ‘angle’; ‘vinkelsum’ is ‘sum of angles’)

When this latter activity was carried out in the classroom, many students expressed confusion and difficulties related to the angles and sums of angles given by GeoGebra. This problem was only addressed at the beginning of the next session.

The data described above can be analysed from a broad digital technological perspective. However, there are specific aspects of the programming environment that may come into place. Therefore, it functions as an outset to argue for the need for a networking of theories approach.

Analytical strategy: Networking of theories

As a response to the proliferation of theories in mathematics education, Prediger et al. (2008) defined and proposed possibilities for networking theories. They compiled a continuum of strategies that depend on their purpose, ranging from understanding others to synthesising theories. The authors

acknowledge that the term *theory* has several meanings and functions in research. Rather than a problem, this feature gives dynamism to theoretical frameworks but demands transparency when they are networked. For example, MDC results from combining competence frameworks (mathematical and digital) and two greater Theories, namely Instrumental Genesis (TIG) (Trouche, 2005) and Conceptual Fields. The theories give a finer-grained content to MDC1:

In particular, this involves aspects of the artefact-instrument duality in the sense that instrumentation has taken place and thereby initiated the process of becoming techno-mathematically fluent. (Geraniou & Jankvist, 2019, p. 43)

The artefact-instrument duality refers to the basis of TIG, namely that “an instrument is a mixed entity, part artefact, part cognitive schemes that make it an instrument” (Artigue, 2002, p. 250). This process goes both ways. The subject transforms the artefact into an instrument via *instrumentalisation*. In turn, the *instrumentation* of the subject Geraniou and Jankvist (2019) refer to is the process by which the instrument gives opportunities to develop schemes for new instrumented action.

Furthermore, they alleged to have taken the first step toward achieving theoretical synthesis. We aim to build on this by locally integrating techno-mathematical fluency from MDC into CT.

Prediger and colleagues (2008) advised researchers to unfold theories’ core elements in order to make them comparable. As stated above, MDC was discussed as a cross-over between two competence frameworks, and thus not any framework for CT is deemed appropriate. Prominent frameworks put into mathematics education focus, for example, on CT as a set of practices (Weintrop et al., 2016) or, more broadly, as a generic and transferable problem-solving approach (Kallia et al., 2021). Ejsing-Duun et al. (2021) mapped these and more characterisations from the literature into the Danish competence-based curriculum, independent from mathematics. Hereby, we use their competence characterisation of CT as the basis for theoretical integration:

Computational thinking is a problem-solving strategy that implements appropriate modelling using abstraction and algorithmic thinking. A good solution presupposes a good understanding of the problem field, and that the right elements are selected (abstraction) and integrated into rules (algorithmic thinking) so that the model handles the problem without creating new problems (Ejsing-Duun et al., 2021, p. 426).

They provide a simple graphical representation of this characterisation, where problem solving encompasses the other three core competencies: modelling, abstraction and algorithmic thinking.

Aside from dealing with competence descriptions, networking strategies rely on different methods. Prediger et al. (2008) notice that most approaches draw on analysing empirical data from the theories involved. Accordingly, we analyse the selected excerpts using an integration of both perspectives.

Analytical discussion: Computer-mathematical discourse

The task and its outputs can prompt a myriad of reflections regarding MDC. In this paper, we treat only MDC1 in coordination with CT, focusing on three selected episodes.

First, it is unambiguous that *angles and their measures are relevant aspects* in characterising specific and general polygons. What Izzie and other students do as soon as the teacher asks them to create polygons is to change the angle parameter in the “turn” block, realising that, for example, 45° implies an octagon. This episode connects to the abstraction competence of CT since they display an understanding of the domain field (geometry), and they communicate it with the programming environment. A conflict occurs when students measure angles of regular polygons drawn in GeoGebra (Figure 3). From the description of MDC1, computer knowledge and mathematical knowledge are combined—the notion of angle—but not really intertwined. In Scratch, angle refers to the parameter of a turning sprite, whereas in GeoGebra, as on a piece of paper, it is the internal angle of a static shape. Evidently, this ambivalence presents an opportunity to distinguish between external and internal angles, which we did not foresee as a learning outcome.

Second, *a regular polygon can be modelled as an approximate circle or vice versa*. When experimenting with a turning angle of 15° , Sam and Bob found themselves drawing the arc of a circle. This is due to the low resolution on Scratch’s right screen. The dialogue with the teacher leads to the problem of how many times the code should be executed so “that happy mouth could become a circle”. All polygons result in a complete 360-degree turn divided into steps. This approximation became clearer in column C of Figure 1. Instrumentation has taken place here so that students use Scratch—an instrument to draw circles and arcs—to draw lower-resolution versions, i.e., polygons. This episode is particularly relevant considering that, in the original task design offered to the teacher by the researchers, approximating a circle was seen as a future advanced extension. Our original intention was the inverse: instrumentation should have taken place to, eventually, extend the instrumented action of modelling regular polygons into an approximate circle.

Third, the difference in *modelling has implications for describing the problem solution as a set of rules*. On Scratch, a polygon is a described trajectory by a pen that is “down”, as opposed to a static shape produced, for example, with GeoGebra’s feature. Nick’s and Elvis’ suggestions to repeat 10 and 4 times to form a square had to be prompted by the teacher, not by dissatisfaction with the solution. Their algorithmic thinking prompts them to change the rules. They had no problem communicating a square by means of Scratch. After the teacher’s questioning, the problem turned into communicating instructions with Scratch to avoid an “off” behaviour. Scratch is here an artefact to communicate *through* and to communicate *with*.

Discussion: What is there to gain?

We have analysed three selected episodes of a programming and geometry task from two competence-based constructs: techno-mathematical fluency and computational thinking. Competencies associated with CT can highlight the same episodes as aspects of MDC1. Recognising and communicating the relevance of angles in defining polygons illustrates both abstraction and the combination of digital and mathematical knowledge. Modelling regular polygons as approximations of a circle can illustrate a computer model that can be adapted into polygons by students developing new Scratch-instrumented actions. Furthermore, turning a model into a code that draws polygons is both a reflection of students’ algorithmic thinking and the artefact-instrument duality, by which a programming environment turns into an instrument for representing geometrical figures. However,

these matches turned also into sources of ambivalence. Therefore, engaging in computer-mathematical discourse is not a particular case of techno-mathematical discourse.

Mathematical and computing languages overlap, but their combination could be a source of confusion. This issue is even more present in text-based programming languages. Bråting and Kilhamn (2021), for example, delineate three non-injective cases of syntax and semantics between computing and mathematics: symbols that have different meanings (e.g., the equal sign), meanings that use different symbols (e.g., modular arithmetic), and symbols that do not make sense in the other field (e.g., ++). Still, CT environments can bring opportunities to learn about and distinguish between, for example, internal and external angles, operational and relational meanings of the equal sign, and theoretical and statistical (simulated) meanings of probability.

Following the first issue, mathematical and computer models are related but not equal. In the computer model, a circle and a polygon with small enough angles do not differ; in mathematics, they do. However, a computational approach to modelling can be helpful in a mathematical situation. For example, differential equations can be solved by numerical methods, and complex random variable distributions can be obtained by simulations. Moreover, students' instrumented actions lead to lower the resolution of a coded circle and ease the search for a pattern in polygons' angles. That is, CT can have both pragmatic and epistemic values in mathematical situations (Artigue, 2002).

Algorithmic thinking means that the artefact-instrument duality is not only present to communicate by means of the computer but also with it. Papert (1980) had warned that the Logo-based Turtle geometry is a more radical approach than using CT to learn traditional school mathematics. "Euclid's is a logical style. Descartes's is an algebraic style. Turtle geometry is a computational style of geometry" (p. 55). Within this type, Nick and Elvis solved two challenges: one was to express a square through Scratch; the second was refining their communication with Scratch to avoid redundancy. Overall, the coded rules to describe a mathematical notion differ depending on the artefact—digital or otherwise.

In sum, we propose that computer-mathematical fluency must entail combining and **disambiguating** computer and mathematical knowledge. It relates to the artefact-instrument duality to communicate through and **with** the computer environment through instrumented actions to construct **computer models in mathematical situations**.

Acknowledgement

This work was funded by the Novo Nordisk Foundation grant NNF 19OC0058651.

References

- Artigue, M. (2002). Learning mathematics in a CAS environment: The genesis of a reflection about instrumentation and the dialectics between technical and conceptual work. *International Journal of Computers for Mathematical Learning*, 7(3), 245–274. <https://doi.org/10.1023/A:1022103903080>
- Bocconi, S., Chiocciariello, A., Kamylyis, P., Wastiau, P., Engelhardt, K., Earp, J., Horvath, M., Malagoli, C., Cachia, R., Giannoutsou, N., & Punie, Y. (2022). In I. dos Santos, R. Cachia, N.

- Giannoutsou, & Y. Punie (Eds.), *Reviewing computational thinking in compulsory education: State of play and practices from computing education*. Publications Office of the European Union. <https://doi.org/10.2760/126955>
- Bråting, K., & Kilhamn, C. (2021). Exploring the intersection of algebraic and computational thinking. *Mathematical Thinking and Learning*, 23(2), 170–185. <https://doi.org/10.1080/10986065.2020.1779012>
- Ejsing-Duun, S., Misfeldt, M., & Andersen, D. G. (2021). Computational thinking karakteriseret som et sæt af kompetencer [Computational thinking characterised as a set of competencies]. *Learning Tech – Tidsskrift for Læremidler, Didaktik og Teknologi*, 10, 405–429. <https://doi.org/10.7146/lt.v6i10.125258>
- Elicer, R., Tamborg, A. L., & Jankvist, U. T. (2022). *Revising a programming task in geometry through the lens of design-based implementation research* [Paper presentation]. 12th Congress of the European Society for Research in Mathematics Education, 2–5 February 2022, Bozen-Bolzano, Italy.
- Geraniou, E., & Jankvist, U. T. (2019). Towards a definition of “mathematical digital competency.” *Educational Studies in Mathematics*, 102(1), 29–45. <https://doi.org/10.1007/s10649-019-09893-8>
- Jacinto, H., & Carreira, S. (2017). Mathematical problem solving with technology: The techno-mathematical fluency of a student-with-GeoGebra. *International Journal of Science and Mathematics Education*, 15(6), 1115–1136.
- Kallia, M., van Borkulo, S. P., Drijvers, P., Barendsen, E., & Tolboom, J. (2021). Characterising computational thinking in mathematics education: A literature-informed Delphi study. *Research in Mathematics Education*, 23(2), 159–187. <https://doi.org/10.1080/14794802.2020.1852104>
- Papert, S. (1980). *Mindstorms: Children, computers and powerful ideas*. Basic Books.
- Prediger, S., Bikner-Ahsbals, A., & Arzarello, F. (2008). Networking strategies and methods for connecting theoretical approaches: First steps towards a conceptual framework. *ZDM*, 40(2), 165–178. <https://doi.org/10.1007/s11858-008-0086-z>
- Trouche, L. (2005). Instrumental genesis, individual and social aspects. In D. Guin, K. Ruthven, & L. Trouche (Eds.), *The didactical challenge of symbolic calculators: Turning a computational device into a mathematical instrument* (pp. 197–230). Springer. https://doi.org/10.1007/0-387-23435-7_9
- Vergnaud, G. (2009). The theory of conceptual fields. *Human Development*, 52(2), 83–94.
- Weintrop, D., Beheshti, E., Horn, M., Orton, K., Jona, K., Trouille, L., & Wilensky, U. (2016). Defining computational thinking for mathematics and science classrooms. *Journal of Science Education and Technology*, 25(1), 127–147. <https://doi.org/10.1007/s10956-015-9581-5>
- Wing, J. M. (2006). Computational thinking. *Communications of the ACM*, 49(3), 33–35. <https://doi.org/10.1145/1118178.1118215>

Developing an innovation pyramid framework to reflect on the digitalization of mathematics education

Houssam Elkasti¹ and Zsolt Lavicza²

¹Qatar University, Qatar; helkasti@qu.edu.qa

²Johannes Kepler University, Austria; Zsolt.Lavicza@jku.at

This article introduces the Innovation Pyramid Framework (IPF) which is the seed of filling in the theories gap in digitalization of mathematics education. This framework adds innovation to the 2D representation of pedagogical triangle by Jean Houssaye (1984) to make it a 3D representation in an attempt to reflect the complete digitalized learning ecosystem. The current theories and frameworks are not reflective of this ecosystem moreover the emergence of new theories is not as fast as the technologies. Our aim is to provide a framework that is general enough to sustain the flux in technology and innovations but specific enough to reflect on many of the aspects of the digitalized ecosystem. In this article, we explain the initial phases of the IPF and elaborate on some of its facets.

Keywords: Theories, innovation, digitalization, networking theories.

Background and rational

Rational

The idea of the innovation pyramid framework started in an attempt to answer the call for action the mathematics education society and particularly the part interested in technology and digitization requested for theory gap filling. For instance, the Mathematics Education in the Digital Age (MEDA) second conference and the 12th Congress of the European society of Research in Mathematics Education (CERME) both stressed on the need for new theories.

In her plenary talk in MEDA 2 (2020) Mariam Haspekian listed many theories that are used in mathematics education research. As a concluding remark Haspekian (2020) mentioned

Regarding this journey, to advance research on TPDA [Teaching practices in the Digital Age] seems urgent as for the “*constant technological flux [which] makes it difficult to develop proper teacher training programs.*” (Sacristan 2019, p. 173). Gaining robust theoretical frames and tool that resist this flux is needed. Networking may undoubtedly help and the TPDA research field is fairly mature for this! (Ana Donevska-Todorova et.al, 2020, p 10)

Also the thematic working group (TWG) 16 ‘*Learning mathematics with technology and other resources*’ at the last CERME 12 (February 2-5 2022, in print) recommended for the future: “Networking theories/theories on communication; students’ communication while working with digital technologies; developing theories together with developing good practices.”

Therefore, it is clear that there is a need for networking existing theories as well as for developing new theories that capture the technology flux. The questions that follow from this are: for theory (ies) to capture the change in the ecosystem of mathematics education, should we integrate old ones, upgrade old ones, or invent new ones?

In what follows, we explain our ongoing work to fill that theory gap on innovation and we suggest the Innovation Pyramid Framework as a solution. Before explaining the IPF we will define two crucial words for the clarity of this article.

Definition of main words

Innovation. Rogers (1995, p. 11) defined an innovation as “an idea, practice or object that is perceived as new by an individual or other unit of adoption”. Innovation can refer either to something concrete like a piece of technology or to something abstract, like an idea or a concept. Innovation does not necessarily mean better. The idea, practice, or object do not need to be new; rather, it is the perception of novelty in using them is what matters.

Ecosystem. The ecosystem (educational ecosystem) is the community where the biotic and abiotic elements interact with each other. The biotic part includes students, teachers, educators, parents, policy makers, administrators, curriculum developers... and any other living stakeholders. While the abiotic part includes books used, available resources, hardware, software, applications... and any other non-living things. It differs from an environment since the environment refers to the surroundings only, whereas, ecosystem is *the interaction* between the environment and the living organisms. (Vedantu.com, n.d.)

So what have we learned so far? We have learned that the learning and teaching ecosystem is not only some vertices of the pyramid and segments that connect them. The ecosystem is viable system and incorporates a lot of interaction between the stakeholders. Therefore, the need is for a framework that represents that viability and that is the Innovation Pyramid Framework (IPF). In what follows, we explain our thoughts about this new framework.

Introducing the innovation pyramid framework (IPF)

The innovation pyramid framework in mathematics education is an attempt to ameliorate rigid theories and frameworks that cannot encapsulate the viability of the ecosystem around innovation and learning. The current situation resembles a lot if you use a regular camera to catch the trajectory of a speeding bullet. The base of the IPF (Figure 1) is the pedagogical triangle (Friesen & Osguthorpe, 2018) which was extensively used by theorist such as: Theory of Didactic Situations TDS (Brousseau 2006) and Anthropological Theory of Didactics ATD (Artigue, 1994) among others.

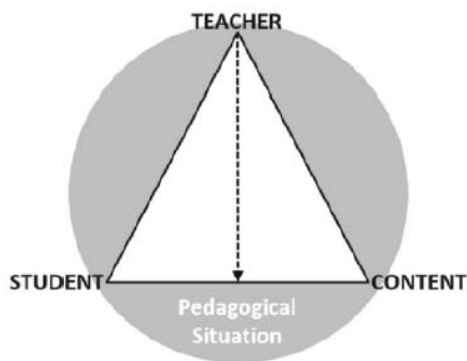

Figure 1: The pedagogical triangle

But since there is a complete ecosystem in the teaching learning and not only pedagogical situations, therefore, what is needed is an upgrade of this triangle that includes innovation that is considered now a substantial part of the pedagogical situation. Moreover, innovation does not belong to this plane and hence the situation extends from a 2D situation into a 3D situation.

The situation becomes three-dimensional (Figure 2) and more dynamic then the two dimensional pedagogical triangle.

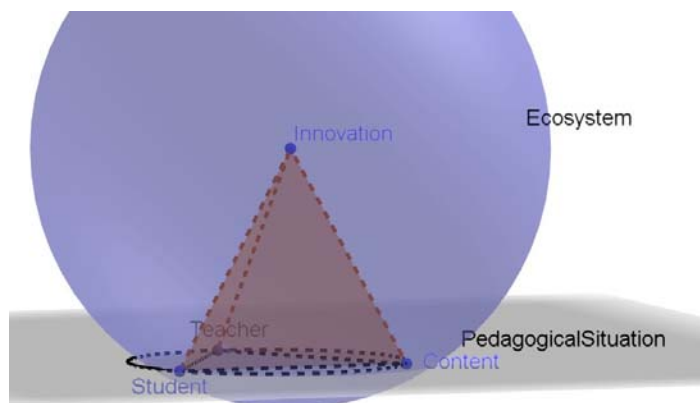

Figure 2: The innovation pyramid framework (IPF)

The theoretical framework is much more complex then it seems and we will try to explain part of it using some examples in the attempt to develop the innovation pyramid framework. The first example is the innovation-teacher-content face.

Innovation-teacher-content pyramid face (ITC)

When innovation is in the pedagogical situation (Figure 3) then teachers face new challenges. There is not one theory that can capture all those challenges. For example, Technological Pedagogical Content Knowledge (TPACK) by Mishra and Koehler (2006) only captures teacher’s knowledge needs to have about the innovation in order to use it in a pedagogically effective way. Nevertheless, is not a sufficient condition for adopting that innovation in his/her practices. For that, there is the Diffusion of Innovation Theory (DIT) by Rogers (1995) that explains the stages a teacher goes through in adopting innovation in the practices.

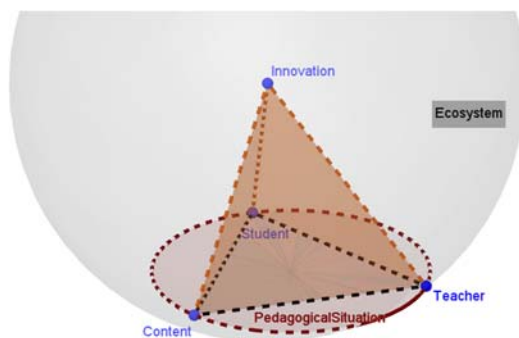

Figure 3: Innovation-Teacher-Content (ITC)

Those two theories do not list nor explain what factors teachers face when adopting that innovation. However, the Zone theory groups and explains those assisting and limiting factors (Goos, 2013). There are more theories that belong to this face of the pyramid such as instrumental genesis (Trouche, 2005); Technology Acceptance Model (TAM); United Theory of Acceptance and Use of Technology (UTAUT); Structuring Features of Classroom Practice framework (Ruthven, 2009) etc...

Therefore, the complexity of adding innovation to the pedagogical triangle cannot be captured by one theory. Maybe the networking of theories or maybe inventing new theory that coordinate and upgrade the existing ones could be the answer. This is the aim of developing the IPF. The second example will be the Innovation Student Content pyramid face.

Innovation-student-content pyramid face (ISC)

Adding innovation to the pedagogical triangle adds complexity of the situation in general. In this section, let us look at how students will interact with the content when innovation is added, keeping teachers away from the perspective (Figure 4).

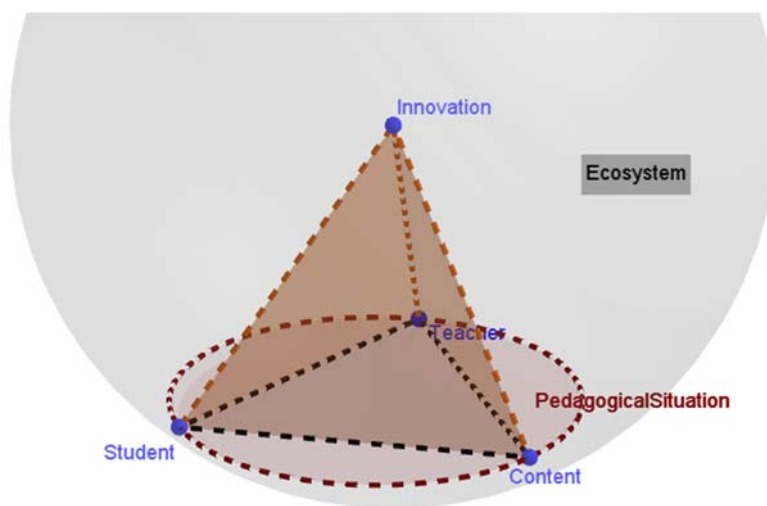

Figure 4: Innovation-Student-Content (ISC)

The known theories that belong to this face are Activity theory (Nardi, 1995), Theory of Semiotic Mediation (TSM) (Bussi & Mariotti, 2008), Communities of Inquiry (Jaworski & Goodchild, 2006), Actions, Processes, Objects, and Schemas (APOS) theory (Dubinsky & McDonald, 2002) etc...

Each of these theories highlights one aspect of the situation; can we integrate them in one general theory? What is the effect of the ecosystem on this triad? For example, what role parents have on the adoption of an innovation by their children on their content knowledge?

Many questions need to be answered and theories should help in answering them. The last example will be the Innovation Teacher Student pyramid face.

Innovation-Student-Teacher Pyramid Face (IST)

There is a big difference between diffusion of innovation by teachers in their classes and the diffusion of innovation by students in their everyday life. The question that poses itself here is, how can we

capture the same innovation adoption by teacher and by the student at the same time? What theory or theories should we use?

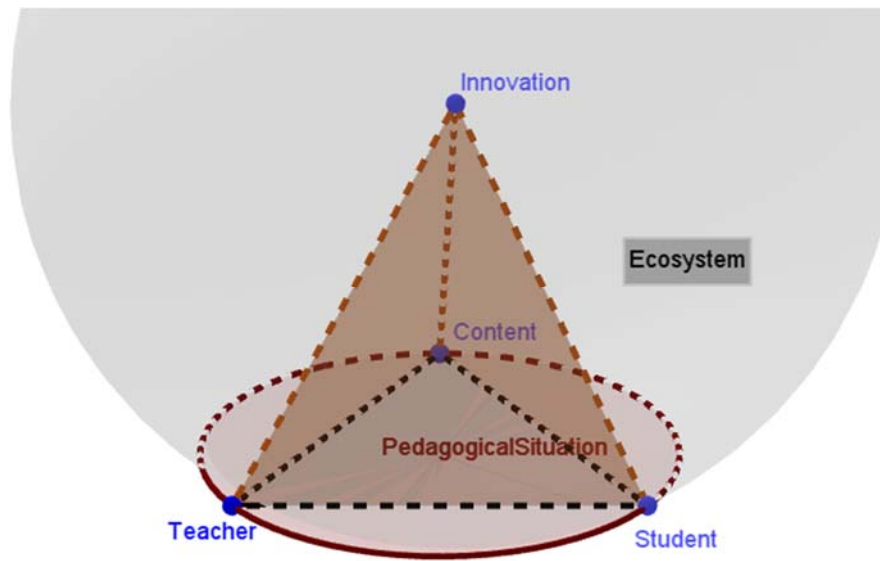
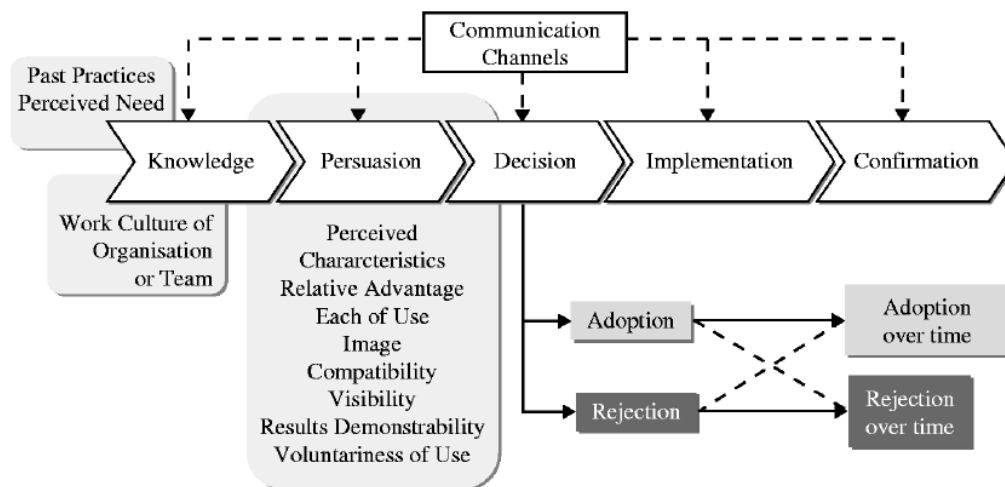

Figure 5: Innovation-Student-Teacher (IST)

Some of the existing theories are: Constructivist, emergent, and sociocultural perspectives (Cobb & Yackel, 1996); the Van Hiele Theory (Pegg, 2014); establishing social and socio-mathematical norms (Dixon et al., 2009); some roles of tools and activities in the construction of socio-mathematical norms (Hershkowitz & Schwarz, 1999); Teaching Practices in Digital Environments (Sinclair & Robutti, 2014); coaching activities (Gibbons & Cobb, 2017).

Similar to ITC and ISC faces, those theories takes part of the story and does not tell us the whole story from the perspective of all the stakeholders. To give an example, let us take the same theory namely the DIT and clarify the difference between teachers and students innovation adoption stages. Teachers go through the following stages in somehow linear manner: knowledge, persuasion, decision, implementation, and then confirmation (Figure 6).



Source: Rogers (2003)

Figure 6: Diffusion of Innovation stages

They know about the innovation (or technology) from any source (peers, social media...) then they are persuaded to use that innovation, they try it, then confirm if it is effective or not, and decide to integrate that innovation in their practices or not.

On the other hand, we see students adopt innovations immediately without going through the stages of persuasion, decision... they simply adopt (Figure 7). The problem is, in most cases, students adopt the innovation but they do not know how it can help them in learning certain content. Teachers, on the other hand, know about the benefit of the innovation in students' learning but they are not at ease in quick adoption.

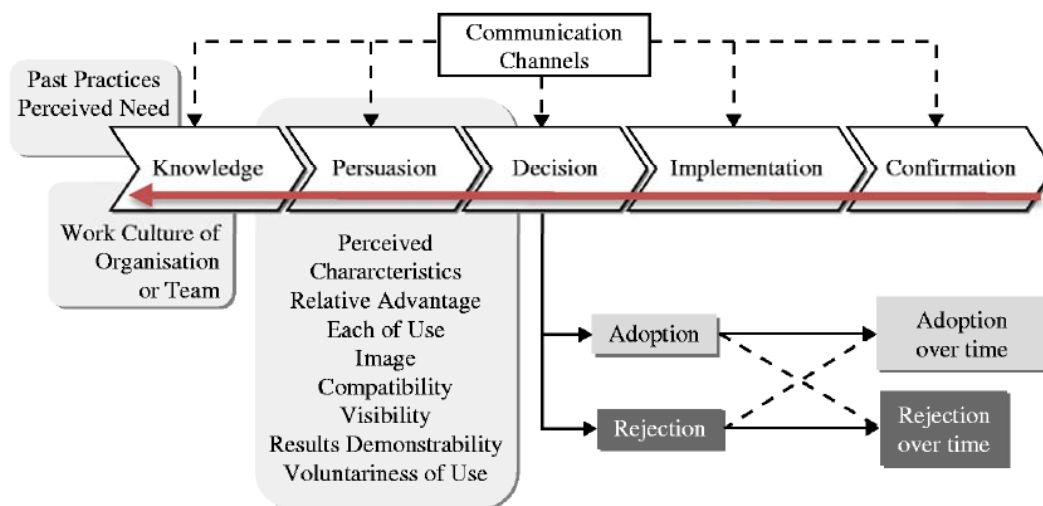

Source: Rogers (2003)

Figure 7: Diffusion of Innovation stages (edited)

How can reconcile between those two directions? What theories we need to use, integrate, or invent?

These are some questions, among others, that need answers. In this article, we tried to highlight the need for a framework that evolve at the same pace of the innovation and more to come...

Discussion

The aim to innovate theories for innovations in mathematics education has been a necessity for many years now and it is still a major one as mentioned by experts in the field. This article is the first stage of a long research towards finding a framework that not only network previous theories on the use of technology in mathematics education but also upgrade them to form new ones that endure the flux of technology and innovations. "Technology Adoption is a complex, inherently social, developmental Process" (Straub, 2009, p 625). Since it is complex process, we need many lenses and different perspectives to understand that complexity. It is inherently social; many biotic factors interact in that process. Developmental process, we need a methodology that captures the development process and not only an immediate laboratory experimental controlled results. What is happening in every face of the pyramid with its ecosystem is worth studying.

In short, in this article we introduced why such a framework is needed and what is the innovation pyramid framework by providing some examples. This is just the beginning of a long journey of studying in that area of research.

References

- Ana Donevska-Todorova, Eleonora Faggiano, Jana Trgalova, Zsolt Lavicza, Robert Weinhandl, et al.. Proceedings of the Tenth ERME Topic Conference (ETC 10) on Mathematics Education in the Digital Age (MEDA), 16-18 September 2020 in Linz, Austria. Sep 2020, Linz, Austria. 2020. hal-02932218
- Artigue, M. (1994). Didactical engineering as a framework for the conception of teaching products. In I. R. Biehler, R. W. Scholtz, R. Sträßer, & B. Winkelmann (Eds.), *Didactics of Mathematics as a Scientific Discipline* (pp. 247–261). Dordrecht: Kluwer.
- Brousseau, G. (2006). *Theory of didactical situations in mathematics: Didactique des mathématiques, 1970–1990* (Vol. 19). Springer Science & Business Media.
- Bussi, M. B., & Mariotti, M. A. (2008). Semiotic mediation in the mathematics classroom: Artifacts and signs after a Vygotskian perspective. *Handbook of international research in mathematics education*, 746.
- Cobb P, Yackel E (1996). Constructivist, emergent, and sociocultural perspectives in the context of developmental research. *Educ Psychol* 31:175–190
- Dixon J, Andreasen J, Stephan M (2009). Establishing social and socio-mathematical norms in an undergraduate mathematics content course for prospective teachers: the role of the instructor. 6th monograph for the association of mathematics teacher educators, scholarly practices and inquiry in the preparation of mathematics teachers, pp 29–44
- Dubinsky E, McDonald M (2002) APOS: a constructivist theory of learning in undergraduate mathematics education research. In: Holton D (ed) *The teaching and learning of mathematics at university level*, vol 7, New ICMI study series. Springer, Berlin, pp 275–282
- Friesen, N., & Osguthorpe, R. (2018). Tact and the pedagogical triangle: The authenticity of teachers in relation. *Teaching and Teacher Education*, 70(255), e264.
- Gibbons, L. K., & Cobb, P. (2017). Focusing on teacher learning opportunities to identify potentially productive coaching activities. *Journal of teacher education*, 68(4), 411-425.
- Goos, M. (2013). Sociocultural perspectives in research on and with mathematics teachers: a zone theory approach. *ZDM*, 45(4), 521-533.
- Hershkowitz R, Schwarz B (1999). The emergent perspective in rich learning environments: some roles of tools and activities in the construction of socio-mathematical norms. *Educ Stud Math* 39:149–166
- Houssaye, J. (1984). *Le triangle pédagogique* (Doctoral dissertation, ANRT).
- Jaworski, B., & Goodchild, S. (2006, July). Inquiry community in an activity theory frame. In *Proceedings of the 30th Conference of the International Group for the Psychology of Mathematics Education* (Vol. 3, pp. 353-360).
- Mishra, P., & Koehler, M. J. (2006). Technological pedagogical content knowledge: A framework for teacher knowledge. *Teachers college record*, 108(6), 1017-1054.

- Pegg J. (2014) The van Hiele Theory. In: Lerman S. (eds) Encyclopedia of Mathematics Education. Springer, Dordrecht. https://doi.org/10.1007/978-94-007-4978-8_183
- Rogers Everett, M. (1995). Diffusion of innovations. *New York*, 12.
- Ruthven, K. (2009). Towards a naturalistic conceptualisation of technology integration in classroom practice: The example of school mathematics. *Éducation et didactique*, (3-1), 131-159.
- Sinclair N., Robutti O. (2014) Teaching Practices in Digital Environments. In: Lerman S. (eds) Encyclopedia of Mathematics Education. Springer, Dordrecht. https://doi.org/10.1007/978-94-007-4978-8_153
- Straub, E. T. (2009). Understanding Technology Adoption: Theory and Future Directions for Informal Learning. *Review of Educational Research*, 79(2), 625–649. <http://www.jstor.org/stable/40469051>
- Trouche, L. (2005). Instrumental genesis, individual and social aspects. In *The didactical challenge of symbolic calculators* (pp. 197-230). Springer, Boston, MA.
- Vedantu.com (n.d.). *The difference between environment and ecosystem*. <https://www.vedantu.com/biology/difference-between-environment-and-ecosystem>

Example-generating tasks in a computer-aided assessment system: Redesign based on student responses

Maria Fahlgren and Mats Brunström

Karlstad University, Department of Mathematics and Computer Science, Sweden

maria.fahlgren@kau.se

Based on the patterns of response to an example-generating task, this paper provides suggestions on how the task could be redesigned to enrich students' example spaces in relation to the key ideas addressed by the task. The participants are 236 first-year engineering students.

Keywords: Mathematics education, example-generating tasks, computer-aided assessment.

The past decades have seen rapid development of technologies for automated assessment of students' work in digital environments. In this paper, we use the notion of computer-aided assessment (CAA) systems for this type of technology. Today, CAA systems are in widespread use, particularly in university mathematics courses (Kinnear et al., 2020). However, researchers point out the importance of designing CAA tasks that address higher-order skills in mathematics to prevent assessment solely focusing on lower-order skills (Rønning, 2017). One way to tackle this is to design tasks using the pedagogical approach of prompting students to generate examples that fulfil certain conditions (Kinnear et al., 2020; Yerushalmy et al., 2017). The idea of asking students to generate their own examples has been suggested as a way to foster students' conceptual understanding (Watson & Mason, 2005). Since the responses generated by a group of students most often provide a rich space of examples, it is time-consuming for the teacher to assess student responses. However, by implementing example-generating tasks into a CAA system this correction work could be outsourced (Sangwin, 2003).

The focus of this paper is on a specific type of example-generating task consisting of a sequence of prompts in which a list of constraints are added successively. The aim of the paper is to examine patterns of student response to this type of example-generating task. The findings will inform the task redesign to strengthen the mathematical key ideas addressed by the task, in this case, the Factor theorem and vertical scaling of function graphs.

Example spaces

Central in the teaching and learning of mathematics are *examples*, most often used to introduce a concept or a method (Bills et al., 2006). Watson and Mason (2005) suggest asking students to construct examples that fulfil certain conditions as a powerful approach in the teaching of mathematics. They use the construct of example spaces when referring to the collection of examples provided by students at a given occasion. According to Watson and Mason, the richness of an example space indicates students' mathematical understanding. They point out the importance of encouraging students to extend their existing and accessible example spaces by asking for another, and then another example (Watson & Mason, 2005). Moreover, by asking for several examples that differ as much as possible, students are prompted to generate examples beyond familiar and prototypical ones (Watson & Mason, 2005).

Another way to encourage students to enrich their example spaces, Watson and Mason (2005) argue, is by adding constraints to the initial conditions. In many cases, this "...opens up new possibilities for the learners and promotes creativity." (p. 11). Sangwin (2003) propose this type of example-generating task as particularly appropriate in creating high-level CAA tasks.

Method

The study took place at a Swedish university in autumn 2021 and it involves 236 first-year engineering students taking a course in Calculus. As part of the course assignment, the students conducted small group activities designed for a combined use of a CAA system (*Möbius*) and a dynamic mathematics software (*GeoGebra*). In this paper, we focus on one of the tasks consisting of a sequence of prompts providing constraints one at a time, adopted from Sangwin (2003).

The task

This example-generating task (see Figure 1) was individualized, i.e. students received different numerical values of the parameters (a and b).

Below are some possible properties (i) - (iv) of a polynomial $p(x)$.

(i) $p(x)$ is a polynomial of degree three, i.e. $p(x)$ is a cubic function.
(ii) $p(a) = 0$ (iii) $p(b) = 0$ (iv) $p(0) = ab$

a) Give an example of a polynomial $p(x)$ satisfying (i).
b) Give an example of a polynomial $p(x)$ satisfying (i) and (ii).
c) Give an example of a polynomial $p(x)$ satisfying (i), (ii) and (iii).
d) Give an example of a polynomial $p(x)$ satisfying all the properties (i) - (iv).
e) Give an example of a polynomial $p(x)$ satisfying (ii), (iii) and (iv), but not (i).

Figure 1. Example-generating task adopted from Sangwin (2003).

The main key idea addressed in this task is the Factor theorem, i.e. understanding the relationship between zeros and factors of polynomials. By adding constraints in terms of specific zeros for a polynomial function (Prompt b and Prompt c), the intention is to encourage students to use the Factor theorem. Some students might generate an example to Prompt b without reconsidering the Factor theorem. The addition of a further zero (Prompt c) might foster them to realize the usefulness of using the Factor theorem. Moreover, the intention is to draw students' attention to the possibility of vertical scaling by adding a further constraint in terms of a given y -intercept (Prompt d).

Data collection and analysis

The data consists of student responses collected through the CAA system. In the first stage of the data analysis process, each student response was coded. This analysis generated several codes for each prompt; from 6 (Prompt a) to 18 (Prompt d) different codes. Next, the initial codes were organized into categories guided by the key ideas addressed by the task.

Results

To the first prompt (Prompt a), 36 % of the students (85 out of 236) responded in the most simple way, i.e. $p(x) = x^3$. Predominantly (141/236), the students provided a polynomial in standard form including more than one term. Only 8 students responded in factored form.

The answer categories to Prompt b and Prompt c are the same, except for one. The categories are:

Factor theorem explicitly (FTE). The responses in this category are written in factored form, e.g. $p(x) = x^2(x - a)$ or $p(x) = (x - a)^3$ to Prompt b, and $p(x) = x(x - a)(x - b)$ to Prompt c.

Factor theorem implicitly (FTI). Although the responses in this category are written in standard form, the strategy to generate the answers most probably begins by using the Factor theorem. For example, several students responded $p(x) = x^3 - ax^2$ to Prompt b, most probably by extending $p(x) = x^2(x - a)$. Analogically, to Prompt c, many students responded $p(x) = x^3 - (a + b)x^2 + abx$, which is an extended form of $p(x) = x(x - a)(x - b)$.

Without using the Factor theorem (WFT). To Prompt b, the most common response was $p(x) = x^3 - a^3$, which is straightforward to find without using the Factor theorem. In this category of responses there were also some students that responded with $p(x) = x^3 + x^2 + x - (a^3 + a^2 + a)$.

Undefined (U). There were several responses, written in standard form, in which we were unable to discern the strategies used by the students, i.e. whether they have used the Factor theorem or not.

Table 1 shows an overview of the responses provided to Prompt b and Prompt c. The result indicates that several students provided an example to Prompt b without using the Factor theorem, i.e. the key idea addressed by the task. In total, 37% of the students (87 out of 236) provided a response (to Prompt b) indicating that the Factor theorem has been used. When a further condition (zero) was added (Prompt c), the corresponding proportion of students increased to 78% (183 out of 236).

Table 1. Student responses to Prompt b and Prompt c (numbers within brackets indicate correct answers)

Prompt	FTE	FTI	WFT	Undefined	No answer	Total
Prompt b	50 (50)	37 (35)	74 (71)	73 (62)	2	236 (218)
Prompt c	78 (76)	105 (100)	-	49 (36)	4	236 (212)

By adding a further constraint in terms of a given y -intercept, another key idea is addressed by Prompt d, i.e. the possibility of vertical scaling of a graph by multiplying with a constant factor. Only 14% of the students (33 out of 236) provided responses indicating that they have used this strategy. Most of the students, 58% (136 out of 236), responded with the polynomial $p(x) = (x + 1)(x - a)(x - b)$, either in factored form or standard form. In this way, they received the correct y -intercept without having to use vertical scaling. Notably, as many as 44 students gave this answer already to Prompt c. In total, 27% (64 students) did not provide a correct answer.

When asked to provide an example of a polynomial function that fulfil all the conditions except for being of degree three (Prompt e), most of the students, 80% (189 out of 236), responded with the (correct) second degree polynomial $p(x) = (x - a)(x - b)$, predominantly written in standard form.

To summarize, the findings indicate that the added zero in Prompt c resulted in a significant increase of students utilizing the Factor theorem, i.e. the main key idea addressed by the task. In this respect, the task worked properly. However, in relation to vertical scaling (the other key idea), the findings indicate a need for a redesign of the task. We will elaborate on this in the next section.

Discussion

One reason why most of the students did not need to use vertical scaling to generate an example to Prompt d, we argue, is the feature of the added constraint in this Prompt ($p(0) = ab$). A straightforward way to tackle this would be to revise the constraint to $p(0) = kab$, for some suitable value of the constant k . In this way, the predominant student response, including the factor $(x + 1)$, will require a multiplication with the constant k , i.e. vertical scaling. Another possibility would be to ask students to provide more than one example. This requirement will prompt students who respond with $p(x) = (x + 1)(x - a)(x - b)$, as most of the students in this study did, to extend their example space.

The latter suggestion of redesign is a more general design principle to extend students' example space (Watson & Mason, 2005), which has been adopted to CAA systems (Sangwin, 2003; Yerushalmy et al., 2017). Reconsidering how this design principle could affect other prompts, we argue that this request might encourage many of the students who did not utilize the Factor theorem when responding to Prompt b to do so. For example, students who provided the simple polynomial $p(x) = x^3 - a^3$ will need to extend their example space by using another strategy, hopefully utilizing the Factor theorem. We strongly suggest that the design principle to ask for more than one example is useful in relation to the last prompt (Prompt e) since it was straightforward for students to provide the second-degree polynomial $p(x) = (x - a)(x - b)$. As there is only one second-degree polynomial that fulfils the given conditions, the request for another example will encourage students to consider polynomials of (at least) degree four.

References

- Bills, L., Dreyfus, T., Mason, J., Tsamir, P., Watson, A., & Zaslavsky, O. (2006). Exemplification in mathematics education. In J. Novotná, H. Moraová, M. Krátká, & N. Stehlíková (Eds.), *Proceedings of the 30th Conference of the International Group for the Psychology of Mathematics Education* (Vol. 1, pp. 126–154). PME.
- Kinnear, G., Jones, I., & Sangwin, C. (2020). Towards a shared research agenda for Computer-Aided Assessment of university mathematics. In A. Donevska, E. Faggiano, J. Trgalová, Z. Lavicza, R. Weinhandl, A. Clark-Wilson, & H. G. Weigand (Eds.), *Proceedings of the Tenth ERME Topic Conference (ETC 10) on Mathematics Education in the Digital Age (MEDA)* (pp. 377–384). Johannes Kepler University.
- Rønning, F. (2017). Influence of computer-aided assessment on ways of working with mathematics. *Teaching Mathematics and its Applications*, 36(2), 94–107. <https://doi.org/10.1093/teamat/hrx001>
- Sangwin, C. (2003). New opportunities for encouraging higher level mathematical learning by creative use of emerging computer aided assessment. *International Journal of Mathematical Education in Science and Technology*, 34(6), 813–829.
- Watson, A., & Mason, J. (2005). *Mathematics as a constructive activity: Learners generating examples*. Routledge.
- Yerushalmy, M., Nagari-Haddif, G., & Olsher, S. (2017). Design of tasks for online assessment that supports understanding of students' conceptions. *ZDM*, 49(5), 701–716. <https://doi.org/https://doi.org/10.1007/s11858-017-0871-7>

Utilizing the notion of scheme in task design for an online assignment portal

Julie Vangsøe Færch¹, Linda Marie Ahl² and Uffe Thomas Jankvist³

¹Danish School of Education, Aarhus University and University College Copenhagen, Denmark,
jvaf@edu.au.dk

²Uppsala University, Sweden, linda.ahl@edu.uu.se

³Danish School of Education, Aarhus University, Denmark, utj@edu.au.dk

The development of middle-grade students' fraction schemes is challenging while also necessary for students in the later development of their ability to reason with reciprocals. In this theoretical paper, we display a method for designing and sequencing tasks in an online assignment portal to develop schemes that provide the necessary prior knowledge for reciprocal reasoning. We place special emphasis on the importance of students' representation competency in the sequencing. Building on Vergnaud's notion of scheme, we analyze possible solutions strategies and anticipate students' actions. The design principles for the sequencing of tasks include assessment of the solution, and how the assessment is used to generate a new task aimed at challenging students to develop new schemes. We exemplify our design principles and discuss the task design principles in relation to task sequencing.

Keywords: Task design, schemes, representations, fraction knowledge, conceptual fields.

Introduction

It is challenging for students to develop the fractional knowledge required to reason with reciprocals, which is essential to relate numbers and measures, reason proportionally, express functional relationships, and solve equations. Not only do students need knowledge of the polysemic nature of fractions, i.e., that the same fraction can have several different meanings;¹ they also need to be able to acquire that meaning from different situations described with different representations. “Although there are different ways to transform one fraction to another multiplicatively, using reciprocals is particularly efficient because it allows a person to scale a fraction to 1 and then scale again” (Hackenberg & Sevinc, 2022, p. 2).

In this paper, we address the development of the conceptual field (see explanation below) of middle school students (age 10–13 years) fraction knowledge. In particular, we focus on the development of students' *partitive*, *unit composition*, and *iterative* fraction schemes (Steffe & Olive, 2010). Students' iterative schemes are precursors for developing multiplicative reciprocal reasoning (Hackenberg & Sevinc, 2022), and the partitive and unit composition schemes are precursors to the iterative scheme. The partitive fraction scheme is defined as the knowledge needed to realize that fractions can be divided into smaller equal parts. For example, realizing that $\frac{8}{10}$ can be divided into eight parts, where each unit is $\frac{1}{10}$, i.e., identifying a unit fraction (Steffe & Olive, 2010). Another possibility is to divide

¹ Parts of whole, measure, quotient, ratio, or operator.

$\frac{8}{10}$ into composed units of equal parts. Instead of identifying $\frac{8}{10}$ as 8 of $\frac{1}{10}$ the student can identify 4 pieces of $\frac{2}{10}$, the unit composition scheme. Once the unit is identified, new fractions can be constructed by iteration, the iterative scheme (for more information, see Steffe & Olive, 2010). Our goal in targeting these schemes is to build a foundation for the adaption of schemes using fractions as multiplicative operators. The adaption of schemes takes place in harmony with the representations signifying the situations used to develop the schemes.

Our aim with this paper is to display a scheme-based task design addressing students' progression in the representation of fractions for an online assignment portal.

We first give the background and setting for the online assignment portal. We then present Vergnaud's notion of scheme. Then follows, a section that exemplifies our task design. We close with a discussion on the task design principles in relation to the task sequencing.

Background and setting

Mathematical competencies (Niss & Højgaard, 2019) have been developed and implemented in the Danish curriculum over the last two decades. The purpose of mathematics in the Danish primary and lower secondary school is that “students must develop mathematical competencies and acquire skills and knowledge so that they can perform appropriately in mathematics-related situations” (EMU, 2021, our translation). Here we focus on the representation competency. “This competency consists of the ability to interpret as well as translate and move between a wide range of representations (e.g., verbal, material, symbolic, tabular, graphic, diagrammatic or visual) of mathematical objects, phenomena, relationships and processes, as well as of the ability to reflectively choose and make use of one or several such representations in dealing with mathematical situations and tasks.” (Niss & Højgaard, 2019, p. 17)

In Denmark, online assignment portals have gained considerable ground in elementary school. Denmark's largest portal alone, *matematikfessor.dk*, has 75% of the Danish primary and lower secondary schools (grades 0 through 10) as regular subscribers, and an average of 1.5 million tasks are answered daily (EduLab, 2021). This means that approximately 500,000 students have access to *matematikfessor.dk* and 45,000–50,000 unique Danish students log on to the portal on a daily basis. Tasks in such portals, however, are mainly used for training students' basic skills (Hawera, Wright & Sharma, 2017).

Theoretical constructs

Schemes

We use Vergnaud's notion of scheme (e.g., Vergnaud, 1997; 1998; 2009) to identify students' fraction schemes. Schemes mediate between empirical objects in the world and cognition. The concept of scheme was first introduced by Kant, and later picked up and elaborated by Piaget. Piaget (1952) described three characteristics of schemes: behavioral, symbolic, and operational schemes. Later, when Vergnaud formulated his notion of scheme, he disposed of the division of schemes into three different kinds of schemes. All actions are governed by schemes, and all actions include both mental and physical operations, which is why Vergnaud saw no point in distinguishing between mental and

physical operations. Vergnaud defined a scheme as *the invariant organization of behavior, or activity, for a certain class of situations*. If we accept that schemes organize action, we can create hypotheses about individuals' existing schemes by analyzing their observable behaviors. A scheme consists of four components:

- goals and expectations;
- rules to generate actions according to the evolution of the different variables of the situation and therefore rules to pick up information and check;
- operational invariants: to grasp and select the relevant information (concepts-in-action) and treat this information (theorems-in-action);
- inference possibilities (there are always *hic et nunc* inferences when the subject is facing a task; a scheme is not a stereotype but a universal organization; it is relevant for a class of situations and not for one situation only). (Vergnaud, 1997, p. 12–13)

Vergnaud defines growth in conceptual knowledge as the adaption of existing schemes to new schemes to handle new situations. Our task design aims at guiding students into cognitive conflicts, where existing schemes require accommodation to solve new situations, and to offer the students opportunities to develop new schemes while increasing their conceptual fields. Vergnaud (2009) developed the theory of conceptual field to describe and analyze students' conceptual development, on a long- and medium-term basis.

Conceptual fields

A conceptual field consists of a set of different concepts tied together and a set of different situations where the concepts apply. Recall that concepts are one of the ingredients in schemes. According to Vergnaud (2009), a variety of situations are necessary to give a concept meaning. Each situation is associated with one or more schemes to handle the situation. Several related concepts are required to understand any situation. Conceptual fields consist of clusters of situations and concepts. Within these conceptual fields, each concept in turn consists of the *situations* that make the concept useful and meaningful; the *operational invariants* that can be used to deal with these situations; the *representations* that can be used to represent invariants, situations, and procedures.

Representations are pictures, words, and mathematical symbols that signify meaning in situations (Vergnaud, 1998). Representations of the same mathematical concept do not necessarily contain the same information about the concept in focus, and a conceptual field holds the whole spectrum of representations and translations between them (see Niss & Højgaard, 2019). *Situations* are an intuitive concept that passes more or less undefined in the research literature, but which in our case refers to the tasks that students are required to solve. *Operational invariants* are the concepts-in-action and theorems-in-action that can be used to deal with the situation (Vergnaud, 2009). The suffix 'in-action' indicates that individuals do not need definitions or terminology for the theorems and concepts they put into action. Due to space limitations, we refer readers to Vergnaud (2009) for further information.

Task design

Design principles

The design of our tasks is operationalized according to the following principles:

1. The task is part of a cluster of tasks that together will give the student opportunities to develop concepts and adapt schemes towards a certain goal.
2. There must be at least two efficient solution strategies, each of which triggers different schemes. The ‘dual scheme idea’ can, according to Elkjær and Hodgen (2022), help task designers focus on the intentions of the task.
3. The choice of representations is conscious and based on the idea that progress in concept knowledge and growth in conceptual fields eventually must involve an epistemological shift, where the meaning of concepts goes from residing in iconic representations to residing in relationships in symbol systems (Ahl & Helenius, 2021).
4. Assessment of the nature of the solution, based on our ideas in the analysis, is done in the online assignment portal. The assessment determines which task is delivered next.

In line with design principle 2, our example tasks can be solved with different strategies (rules-of-action), activating different schemes. Students’ actions reveal which schemes have been activated in the solution process. By changing the situation so that certain schemes lead to a more efficient solution, the student can be guided to adapt their existing schemes to the new situation.

Task analysis and sequencing

Our goal, in our example tasks, is that students should be given opportunities to develop and consolidate fraction schemes within the iconic representation of the number line. The students will be provided with opportunities to develop new schemes, via new situations provided as a result of the online assessment of their solution strategy. The new situation aims to encourage existing schemes to adapt to the situation. Students’ actions may be a result of an existing scheme, but they may also not yet have been consolidated into an invariant organization of behavior, or activity, for a certain class of situations. Longer sequences are necessary to corroborate the existence of a scheme.

Place 1 on the number line

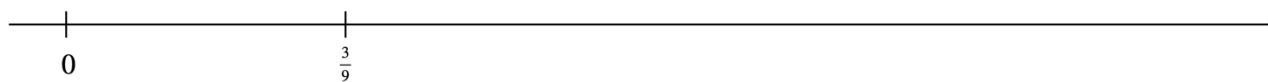

Figure 1: Fraction task. Represented by the number line

Students’ actions show what concepts- and theorems-in-action are activated in their solution process. In our example task, we anticipate two different efficient solution strategies:

Solution A. Students divide the fraction into smaller equal parts and iterate the unit fraction to find the number 1. Based on the markings on the number line (figure 2), both the partition into a unit fraction and the iteration can be recognized in the online assignment portal.

Place 1 on the number line

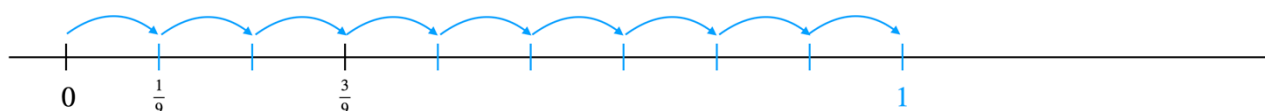

Figure 2: Iterate the unit fraction

Since the student may master both the unit partitive and the iterative fraction scheme, the next task will display a situation, where a composite unit together with iteration will be more efficient for solving the situation. The situation may be: Place 1 on a number line marked with 0 and $\frac{20}{60}$. While iterating the unit fraction $\frac{1}{60}$ 60 times will still solve the situation; a composite unit, where the student iterates $\frac{20}{60}$ three times, first to $\frac{40}{60}$ and then to $\frac{60}{60}$, which equals one, will be more efficient.

Solution 2: Students use a composite unit together with iteration to find the number 1. The individual perceives $\frac{3}{9}$ as the composite unit $\frac{1}{3}$ of 1. They also demonstrate competency to move between the (equal) representations $\frac{3}{9}$ and $\frac{1}{3}$. Based on the markings on the number line (figure 3), both the partition into a composite unit and the iteration can be recognized in the online assignment portal.

Place 1 on the number line

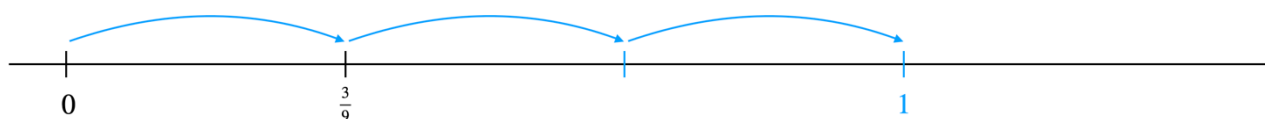

Figure 3: Iterate a unit composite fraction

Because the student may master the unit composite and the iterative fraction scheme, the next task will display a situation, where the unit fraction together with the iteration will be more efficient to solve the situation. The aim is to discover if the iterative fraction scheme is already nested or can be adapted into the student's conceptual field. To be able to conclude that the scheme is accommodated in the student's conceptual field, it needs to be tested on several tasks. The iterative scheme requires students to conceptualize fractions as iterable units:

To judge whether a unit fraction is an iterable unit requires the observation that the child uses it to produce an improper fraction. In the case of the partitive fraction scheme, a unit fraction inherits its iterability from the iterable unit of one. (Steffe & Olive, 2010, p. 180)

By making it rather difficult to use a composite unit, we elicit more information for the assessment of students' schemes. The situation may be: Place 1 on a number line marked with 0 and $\frac{8}{5}$.

Place 1 on the number line

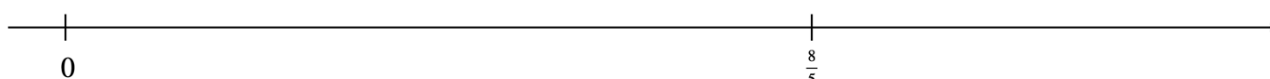

Figure 4: Improper fraction task. Represented by the number line

Because the fraction is improper and the denominator is a prime, it may block the use of iteration of a composite unit. The task aims to encourage a solution where students may use a unit fraction to find $\frac{1}{5}$ by dividing the distance into 8 parts, and then use subtraction (reverse iteration) down to $\frac{5}{5}$.

Place 1 on the number line

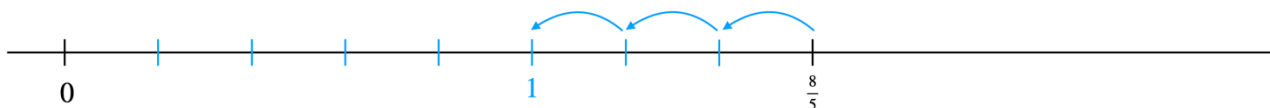

Figure 5: Reverse iteration of a unit fraction

When the partitive, composite and iterative fraction scheme is accommodated in the student's conceptual field, necessary prior knowledge for reciprocal reasoning exists. Yet, while the number line has served us well as representation thus far, the following task design requires a shift in representation to reasoning in mathematical symbol systems. Simply put, the number line has played out its role as an explanatory representation. An example of a task for promoting reciprocal reasoning and reasoning in symbol systems may be:

Object A is 24 cm in height. This is $\frac{2}{7}$ of the height of object B. How high is object B?

A solution in two steps based on students' experiences from the number line representation is efficient. First, since $24 \text{ cm} \sim \frac{2}{7}$, identify that the unit fraction $\frac{1}{7} \sim 12$. Then multiply $12 \cdot 7$ to find the height of object B. The most efficient solution, using reciprocal reasoning, would be $\frac{7}{2} \cdot 24$. However, there may still be some adaption of schemes before the student may combine the two operations into

one operator, and eventually generalize the operations $\frac{a}{b}$ and $\frac{1}{b} \cdot b$ into the theorem $\frac{a}{b} \cdot \frac{b}{a} = 1$. Still, if we do not know where we are heading, we are unlikely to get there, which is why careful task design is worthwhile.

We end our brief presentation of our theoretical ideas about task design with a few words on the importance of the choice of representations. In the examples in Figures 1–3, the number line is a helpful representation, since the individual can switch between iconic and symbolic representations (Ahl & Helenius, 2021). Nevertheless, progress in concept knowledge and growth in conceptual fields must eventually involve an epistemological shift, where the meaning of concepts goes from residing in situations and iconic representations to residing in relationships in symbol systems. When a student has developed competency in reasoning with reciprocals, the iconic number line representation is no longer necessary for meaning-making. While the student's conceptual field develops, the student's degree of coverage of the representation competency is expanded.

Discussion

Above we have displayed a method for designing and sequencing tasks in online assignment portals with emphasis on fractional tasks and the representation competency using Vergnaud's notion of schemes. The intention of the task sequencing is to establish a learning trajectory through the anticipated solution strategies by which the students can develop their fraction schemes. We end the paper by discussing how the principles regarding task design have been implemented throughout the sequencing.

The task is designed to become part of a cluster of tasks that can be delivered to students using dynamic sequencing, to give the students opportunities to adapt fractional schemes on their way to reciprocal reasoning. A preferred sequencing of tasks supports epistemological shifts in dealing with different representations of composite fractions. The two exemplified efficient solution strategies each triggering different fraction schemes. By using the 'dual scheme idea', if an initial solution strategy builds on, for example, iterating a unit fraction, subsequent tasks will encourage a switch in strategies, for example to using a composite unit fraction, by providing a task where the initially chosen strategy becomes increasingly impractical. Similarly, if the initial solution builds on using a composite unit, subsequent tasks may stimulate a switch to iterate a unit fraction.

The described way of using the online portals dynamic sequencing requires knowledge of which rules-of-action the student will make visible in the solution process. To implement this theoretical idea in the online assignment portal, we still need to set up criteria for assessing student responses online. In this theoretical paper, we have assumed that students will either mark a unit fraction or a composite fraction in the online portal. The next step is gathering data to get to know more about what students will do when faced with this type of task in the portal, as similar tasks do not exist at the moment.

Acknowledgments

We thank Morten Elkjær for fruitful discussions during the preparation of this paper.

References

- Ahl, L. M., & Helenius, O. (2021). A framework for analyzing progress in concept knowledge in mathematics textbooks. In G. A. Nortvedt, N. A. Buchholtz, J. Fauskanger, F. Hreinsdóttir, M. Hähkiöniemi, B. E. Jessen, J. Kurvits, Y. Liljekvist, M. Misfeldt, M. Naalsund, H. K. Nilsen, G. Pálsdóttir, P. Portaankorva-Koivisto, J. Radišić, & A. Wernberg (Eds.), *Bringing Nordic mathematics education into the future. Proceedings of Norma 20. The ninth Nordic Conference on Mathematics Education Oslo, 2021* (pp. 1–8). SMDF.
- EduLab (2021). Retrieved March 2021 from <https://edulab.dk/>
- Elkjær, M. & Hodgen, J. (2022). Operationalising Vergnaud’s notion of scheme in task design in online learning environments to support the implementation of formative assessment. *Implementation and Replication Studies in Mathematics Education*, 2(1). <https://doi.org/10.1163/26670127-bja10002>.
- EMU. (2021). Formål. Retrieved May 25, 2021 from <https://emu.dk/grundskole/matematik/formaal>
- Hackenberg, A. J., & Sevinc, S. (2022). Middle school students’ construction of reciprocal reasoning with unknowns. *The Journal of Mathematical Behavior*, 65, 100929. <https://doi.org/10.1016/j.jmathb.2021.100929>.
- Hāwera, N., Wright, N., & Sharma, S. (2017). Mathematics Education ITE Students Examining the Value of Digital Learning Objects. *Teachers and Curriculum*, 17(1), 81-87. <https://doi.org/10.15663/tandc.v17i1.148>
- Niss, M., & Højgaard, T. (2019). Mathematical competencies revisited. *Educational Studies in Mathematics*, 102(1), 9–28. <https://doi.org/10.1007/s10649-019-09903-9>
- Piaget, J. (1952). *The Origin of Intelligence in Children*. (M. Cook, Trans.). New York: International University Press, Inc. (Original work published in 1936)
- Steffe, L. P. (2010). The partitive, the iterative, and the unit composition schemes. In L. P. Steffe, & J. Olive (Eds.), *Children’s fractional knowledge* (pp. 171–223). New York: Springer. https://doi.org/10.1007/978-1-4419-0591-8_7.
- Vergnaud, G. (1997). The nature of mathematical concepts. In P. Bryant & T. Nunes (Eds.), *Learning and teaching mathematics: An international perspective* (pp. 5–28). Psychology Press/Erlbaum (UK) Taylor & Francis.
- Vergnaud, G. (1998). A comprehensive theory of representation for mathematics education. *The Journal of Mathematical Behavior*, 17(2), 167–181. [https://doi.org/10.1016/S0364-0213\(99\)80057-3](https://doi.org/10.1016/S0364-0213(99)80057-3)
- Vergnaud, G. (2009). *The Theory of Conceptual Fields*. *Human Development*, 52(2), 83–94. <https://doi.org/10.1159/000202727>.

A case study of an expert in computational thinking in the context of mathematics education research

Eirini Geraniou¹ and Jeremy Hodgen²

¹UCL Institute of Education, London, UK; e.geraniou@ucl.ac.uk

²UCL Institute of Education, London, UK; jeremy.hodgen@ucl.ac.uk

We conducted semi-structured interviews with three experienced mathematics education researchers with great expertise in the design and use of digital technologies, including programming skills, to investigate their views and perceptions on computation thinking (CT) and its impact on mathematical learning. In this paper we report on our findings from one of them, Mark, and we suggest ways for adapting the very recent Mathematical Digital Competency (MDC) framework to encompass CT practices and dispositions. Our aim is to offer insights into how CT is perceived and understood by him, by prompting him to reflect on his own CT practices and competencies. We offer suggestions for an MDC framework for mathematics teacher educators that encompasses CT.

Keywords: Computational thinking, mathematics education researchers, mathematical digital competency, digital technologies.

Introduction

Computational Thinking (CT) has made its appearance in the mathematics education of the digital era over a decade ago and ever since then, the upsurge of interest in its influence/impact on mathematical teaching and learning is evident. Looking back at PME44, when Inprasitha (2021) announced the theme of the conference being on “Mathematics Education in the 4th Industrial Revolution”, CT was characterised as an essential competency for a digital society. The relationship between CT and mathematics has been of particular interest. Indeed, some see CT as offering the potential to transform school mathematics (e.g., Perez, 2018).

Teacher education will be critical in enabling mathematics teachers to realise the potential of CT to transform mathematics. Yet, to date, educational literature on CT, or computational competency or the “new digital age competency” as sometimes is referred to (e.g., Grover & Pea, 2013), has mainly focused on students’ CT. Undoubtedly, to promote effective CT teaching (Weintrop et al., 2016), one should focus on teacher education and professional development as argued by Lee et al. (2020). To our knowledge, there is not any research that investigates mathematics teacher educators’ (MTEs) expertise in CT.

We address this gap by investigating MTEs’ CT and their computational practices in order to better articulate the knowledge and beliefs required by mathematics teacher educators. To do this, we consider the “telling case” (Mitchell, 1984) of Mark, an experienced ‘mathematics education with technology’ researcher and teacher educator, Mark, who has extensive knowledge of Programming, Artificial Intelligence (AI) and Machine Learning (ML) from an over 15-years active design-based research background on educational technologies in mathematics education. We present initial findings from an exploratory study in order to consider ways for adapting the Mathematical Digital

Competency (MDC) framework (Geraniou & Jankvist, 2019) to encompass mathematics teacher educators' CT practices and dispositions.

Computational thinking and mathematics education

Cuny, Snyder and Wing (2010) defined CT as “*the thought processes involved in formulating problems and their solutions so that the solutions are represented in a form that can be effectively carried out by an information-processing agent*”. The consensus of research (e.g., Shute et al., 2017) is that, whilst there are practices in common, CT is a distinct and separate discipline to mathematics, and that CT is less about the use of technology and computers and more about the concepts, practices and processes involved. However, CT involves practices that are also required in mathematics, such as “decomposition, abstraction, algorithm design, debugging, iteration, and generalization” (Li et al., 2020, p.156). There has been some research regarding the teaching of CT both in general (see Grover & Pea's, 2013) and specifically in mathematics and other STEM subjects (see, e.g., Lee et al., 2020). Our recent work (Geraniou & Hodgen, 2022) indicated that unlike the teachers in Sands et al.'s (2018), neither of the two MTEs we interviewed viewed CT narrowly as synonymous with doing mathematics nor simply using digital tools to do mathematics. However, both appeared to have had limited opportunities to articulate the relationship between CT and mathematics and, as a result, viewed CT as closely tied to computers and other digital tools. This outcome, together with anecdotal data from our own past experiences and work, suggest that there is variation in the way CT is perceived and potentially used by teachers and teacher educators. This argument goes against Perez's (2018) claim that the practices identified in his review represent a consensus in mathematics education. All these findings suggest the need to investigate further mathematics education researchers' (as well as mathematics teachers') perspectives on what CT is and assess their CT practices, offering support towards enriching their mathematics teaching practices.

Teacher knowledge, competencies, and computational thinking

Recent research into teacher knowledge and instructional quality has shown that a key aspect of teacher knowledge is not just the knowledge itself, but also the enaction of this knowledge (Tabach, 2021), or the extent to which pedagogic strategies and tasks are cognitively challenging for students. König et al. (2021) refer to this enaction of knowledge as cognitive activation and conceive of it as a central aspect of teacher competencies (König et al., 2021). Tabach (2021) discusses this shift from knowledge to competencies, as inspired by Niss and Højgaard's (2019) view on what it means to be mathematically competent as articulated in the Danish KOM mathematical competencies framework. “By focusing on mathematical competence rather than on mathematical subject matter as the integrating factor of mathematics across all its manifestations, we have chosen to focus on the exercise of mathematics, i.e., the enactment of mathematical activities and processes” (Niss & Højgaard, 2019, p. 12). Perez's (2018) review of CT in mathematics education indicates a **similar** shift towards competencies by highlighting the practices and dispositions involved in CT. He highlights a range of practices, including elements, such as “developing algorithms and automations” as well as composite practices, such as “efficient and effective combinations of resources, testing and debugging” (p. 428).

The Danish KOM mathematical competencies framework was presented in 2011 by Niss and Højgaard, to represent the mathematical competencies possessed by students, but teachers too. In a more recent publication, Niss and Højgaard (2019) defined mathematical competence as comprising “knowledge of, understanding, doing, using and having an opinion about mathematics and mathematical activity in a variety of contexts where mathematics plays or can play a role” (Niss & Højgaard, 2011, p. 49). Building upon this framework, Geraniou and Jankvist (2019) proposed that students’ having Mathematical Digital Competency (MDC) involves the following three elements:

- “[MDC1]: *Being able to engage in a techno-mathematical discourse.* In particular, this involves aspects of the artefact-instrument duality in the sense that instrumentation has taken place and thereby initiated the process of becoming techno-mathematically fluent.
- [MDC2]: *Being aware of which digital tools to apply within different mathematical situations and context, and being aware of the different tools’ capabilities and limitations.* In particular, this involves aspects of the instrumentation–instrumentalisation duality.
- [MDC3]: *Being able to use digital technology reflectively in problem solving and when learning mathematics.* This involves being aware and taking advantage of digital tools serving both pragmatic and epistemic purposes, and in particular, aspects of the scheme-technique duality, both in relation to one’s predicative and operative form of knowledge” (p. 43).

We also agree with Krumsvik and Jones’s (2013) characterisation regarding teacher’s digital competence that involves two dimensions, that of the competence to use technology for personal use and additionally that of the competence to use technology in pedagogical settings. This idea that has been conceptualised by Chick and Beswick (2018) as *meta pedagogical content knowledge* (meta-PCK) of MTEs. Extending these theoretical ideas, we suggest that mathematics educators’ expertise may involve a further conceptualisation or in other words a meta-MDC, where for example, they engage in a meta-discourse about their own practice and the capabilities and limitations of the particular tools supporting their practice and how these relate to more general aspects of CT.

All the above made us consider that there is a clear link between CT practices and MDC. We should also look into the composite CT practices as it is particularly challenging for educators to become competent at a meta-level in combining these various elements. So, our research question is: *In what ways can mathematics educators conceptualise CT in relation to MDC?*

Design and methods

We carried out an exploratory study with three MTEs, who have extensive experience with research in the use of digital technologies for mathematical teaching and learning. We believed that identifying MTEs’ beliefs would shed light onto what CT is, what CT practices are, what the relationship between CT and mathematical thinking is, how CT practices can be promoted among mathematics teachers, why CT practices are useful (or not) and what they offer to mathematics education. We interviewed those three MTEs independently. Our initial findings based on our discussions with two of the three MTEs, were discussed in a recent publication (Geraniou & Hodgen, 2022). In this paper, we will focus on our discussions with the remaining MTE, Mark.

We carried out a 60-minute interview with Mark and we present a vignette of our discussions. The interview consisted of two parts. In the first part, Mark had to present and reflect on a mathematical activity involving CT, using the Think-Aloud protocol (Güss, 2018). We asked him to reflect on (a) the programming aspects, (b) mathematical definitions, (c) the structure of the mathematical and the tool's language, and (d) the algorithms. Given that CT is a relatively new area of interest, we wanted a task that would enable Mark to articulate various aspects of CT practices. Hence, we asked Mark to bring along a problem he was familiar with. This has an advantage of generating a range of ideas in a relatively short space of time, but has some limitations in terms of comparing the MTEs' beliefs. In the second part, we asked Mark for his own definition of CT using Cuny, Snyder and Wing's (2010) definition and discussed the CT practices presented in Perez's (2018) paper.

Mark's vignette

A mathematical activity

Mark presented an activity that he had recently created at the request of a teacher. The activity was designed to enable students to investigate the modelling of an infectious disease such as COVID. It was designed in Scratch using a simple model of the effect of different factors (movement, handwashing, the transmission rate, and healthcare capacity) on infection and death rates. The environment allowed students to change these factors to explore their effects. The activity, as seen by students, is illustrated in Figure 1. The movement of people, represented as coloured sprites, was modelled as a random process and students could use a slider to alter the level of movement, thus reflecting the effect of social distancing restrictions. When the sprites 'meet', the likelihood of infection was again modelled randomly and students could use a slider to alter the level of handwashing, thus reflecting the effect of hygiene measures. The likelihood of recovery is affected by the healthcare capacity, which can be altered either by students or the teacher. Sprites are in one of four states: susceptible to the disease (yellow), infected (red), recovered and assumed immune (blue) or dead (black). The graph in the bottom left-hand corner shows the level of infection over time against the health care capacity.

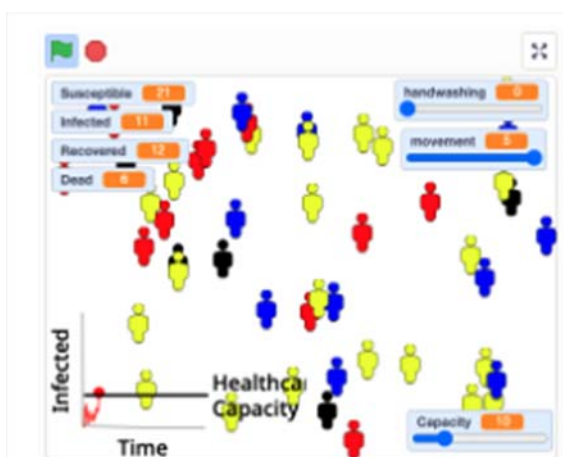

Figure 1: The Scratch activity as explored by students

Mark's definition of computational thinking

Mark saw a strong overlap between mathematics and CT with the notion of variable being key to modelling in both disciplines. Nevertheless, despite this common interest, he considered the two disciplines as distinct. He defined CT as follows:

Mark: [It is] many things ... the simple answer is ... being able to think ... with a specific programming language or specific tools ... in a way that allows you to address a particular problem ... [And] being able to develop something in a way that is... general or abstract, which could be configurable. So going back to the example here, I want to give the people the possibility to ... change the parameters so [they can] understand the model in principle.

So, for Mark, CT involves not only practices, such as understanding coding and algorithms, and dispositions, such as thinking like a programme, but also purposes, such as developing general solutions to problems.

Mark's computational thinking in light of MDC and pedagogy

Unsurprisingly, given his expertise and background, Mark demonstrated considerable facility with CT and we found evidence for many of Perez's (2018) CT practices and dispositions. More significantly in terms of our interest in MTE's knowledge of CT, he also demonstrated a consideration of the cognitive activation directed at teachers and pedagogy that appear to align well with MDC (Geraniou & Jankvist, 2019).

MDC1. Being able to engage in a techno-mathematical discourse: Mark engaged in a techno-mathematical discourse about CT. He reflected not only on the cognitive activation of tasks, but also on *how* and *why* to cognitively activate tasks (König et al., 2021). Mark was careful to distinguish the “*relatively unexplored*” and “*half-baked*” activity microworld environment (using a term from the literature on microworlds - e.g., Kynigos, 2007) from the actual task that a teacher would set students which might be how to reduce the transmission or to “*fix*” some “*broken*” aspect of the activity. This could enable teachers to “*expose students to this idea that there's a variable that is [between] 0 and 1 and it has an impact*”. He noted that he would “*flag the potential ... to ask this kind of 'what if questions'*”. Indeed, for Mark, it is the point at which CT and mathematics “*meet*” where the problem becomes pedagogically productive:

Mark: A lot of the code is just setting up things and ... not so important. ... Where maths meets computation somehow is here, because, this is a code for the person that moves around. So from Scratch, you have these ... sprites ... that move around and [we] define the movement ... [as] random ... The other thing ... [is] when they touch the edge ... [they] bounce back which ... simulates a small school or a city or whatever you want.

Hence, Mark was able to engage in a techno-mathematical and computational discourse *at a meta-pedagogic level*, as indicated by how he distinguishes the key moment in coding with Scratch.

MDC2. Being aware of [...] digital tools [...] and their capabilities and limitations: It was striking that Mark reflected on how his practice was embedded in the programming environment and thus his knowledge was *distributed* across the programming language (Helliwell & Chorney, 2021; Hodgen, 2011):

Mark: Scratch ... is a different way of thinking. ... [The] programming language becomes an object to think with. ... had someone asked me to do this part with the transmission rate, ... I'm not sure I would have done it this way. ... But it's an interesting notion that you pick a number, and then you compare it to the transmission rate.

Here, Mark demonstrates meta-level thinking in his consideration of how Scratch structures one's thinking in particular ways.

He went on to reflect on the constraints of Scratch in terms of “cutting corners” and distinguished this from the simplification involved in constructing models in general:

Mark: I'm using [cutting corners] also in a computational way, ... because of Scratch. ... It's me thinking of the limitations of Scratch. ... Obviously in any modelling you have to simplify ... [I] was being critical of Scratch ... that's why I said I would cut corners.

This demonstrates an awareness not only of the tools of CT but also of how teachers think, and act, pedagogically with these tools and the benefits and limitations of these.

MDC3. Being able to use digital technology reflectively in problem solving and when learning mathematics: He reflected on modelling computationally and mathematically. In particular, he noted that “*the actual models [of transmission] have differential equations in them*” and are hence beyond much of school mathematics. However, he considered that pedagogic models in CT classrooms do not need to be “authentic”, but should rather be “meaningful”:

Mark: Obviously, if you wanted to have a proper model, it would be mathematically very complex and so this [model] is targeted to early secondary. ... So, it's very simple, the code, to be able to achieve this and it doesn't reflect obviously a proper COVID mathematical model. But I think that's actually what makes it kind of useful.

So, in Mark's view, the pedagogic task is to model modelling in order that the CT model is “*close enough*” to key aspects of the “*real, more complex*” model “*because ... it doesn't happen always that when you are close to that person you get the virus, which is close to reality. ... [I]t happens based on a transmission rate.*” This shows not only an awareness of computational modelling as a pedagogical exercise but also at a meta-level what is key in supporting students' interpretation of the mathematical model.

Conclusion

Our study indicated that Mark was very skilled in CT and mathematics and offered insightful comments about CT in relation to mathematical modelling in the Scratch environment, subsequently revealing his own MDC. Reflecting upon our past work (Geraniou & Hodgen, 2022), we remind our readers that we had highlighted the need to articulate the nature of Computational Thinking Pedagogical Content Knowledge (CTPCK). In this paper, however, the data from Mark led us to a different avenue to knowledge, that of competencies. We argue that possessing CT is a competency and in fact a mathematical digital competency, based on the definitions shared by Geraniou and Jankvist (2019). In more detail, we suggested some adaptations to the three elements of MDC regarding students to encompass an MDC framework for mathematics educators that considers CT practices:

- [MDC1:] *Being able to engage in a techno-mathematical and computational discourse at a meta-pedagogic level.*
- [MDC2:] *Being aware of which digital tools to apply within different mathematical situations and context, and being aware of the different tools' capabilities and limitations, so as to think, and act, pedagogically with these tools, while considering the benefits and limitations of these.*
- [MDC3:] *Being able to use digital technology reflectively in problem solving and when learning mathematics, considering and applying computational modelling as a pedagogic enterprise.*

What distinguishes Mark's vignette is his ability to reflect about the nature of CT framed in a pedagogical manner, indicating how he enacted his own mathematical knowledge and computational thinking as several integrated competencies, in our case MDCs.

Our future work entails the wider empirical investigation of this framework for MTEs' competencies with regards to CT practices. We want to identify the CT elements mathematics teacher educators and mathematics teachers possess and those CT elements they should acquire to enrich their mathematics teaching practice. We conclude by posing a challenge to our readers: Is CT better conceived as CTPCK or MDC?

References

- Chick, H., & Beswick, K. (2018). Teaching teachers to teach Boris: A framework for mathematics teacher educator pedagogical content knowledge. *Journal of Mathematics Teacher Education*, 21(5), 475-499.
- Cuny, J., Snyder, L., & Wing, J.M. (2010). *Demystifying Computational Thinking for Non-Computer Scientists* (work in progress). Retrieved from <https://www.cs.cmu.edu/link/research-notebook-computational-thinking-what-and-why> [last accessed 06 September 2021]
- Geraniou, E., & Hodgen, J. (2022, in press). *An exploratory study on mathematics teacher educators' beliefs and understandings about computational thinking*. Paper accepted for the proceedings of the 12th Congress of European Research in Mathematics Education (CERME12), Bolzano, Italy.
- Geraniou, E., & Jankvist, U. T. (2019). Towards a definition of "mathematical digital competency". *Educational Studies in Mathematics*, 102, 29-45.
- Grover, S., & Pea, R. (2013). Computational thinking in K-12: a review of the state of the field. *Educational Researcher*, 42(1), 38-43.
- Güss, C. D. (2018). What is going through your mind? Thinking Aloud as a method in cross-cultural psychology. *Frontiers in Psychology*, 9:1292.
- Helliwell, T., & Chorney, S. (2021). Conceptualizing the expertise of the mathematics teacher educator In M. Inprasitha, N. Changsri, & N. Boonsena (Eds.), *Proceedings of the 44th Conference of the International Group for the Psychology of Mathematics Education* (Vol. 1, pp. 96-98). Khon Kaen, Thailand: PME.
- Hodgen, J. (2011). Knowing and identity: A situated theory of mathematics knowledge in teaching. In T. Rowland & K. Ruthven (Eds.), *Mathematical Knowledge in Teaching* (pp. 27-42). Dordrecht, NL: Springer.

- Inprasitha, M. (2021). Preface. In M. Inprasitha, N. Changsri & N. Boonsena. (Eds.) *Proceedings of the 44th Conference of the International Group for the Psychology of Mathematics Education* (Vol.1). Khon Kaen, Thailand: PME.
- König, J., Blömeke, S., Jentsch, A., Schlesinger, L., née Nehls, C. F., Musekamp, F., & Kaiser, G. (2021). The links between pedagogical competence, instructional quality, and mathematics achievement in the lower secondary classroom. *Educational Studies in Mathematics*.
- Krumsvik, R., & Jones, L. (2013). Teachers' digital competence in upper secondary school: (Work in progress). In L. Morris, & C. Tsolakidis (Eds.), *Proceedings of the International Conference on Information Communication Technologies in Education (ICICTE 2013)* (pp. 171–183). ICICTE.
- Kynigos, C. (2007). Half-baked Logo Microworlds as Boundary Objects in Integrated Design. *Informatics in Education*, 6(2), 335-358.
- Lee, I., Grover, S., Martin, F., Pillai, S., Malyn-Smith, S., (2020). Computational Thinking from a Disciplinary Perspective: Integrating Computational Thinking in K-12 Science, Technology, Engineering, and Mathematics Education. *Journal of Science Education and Technology*, 29,1–8.
- Li, Y., Schoenfeld, A. H., diSessa, A. A., Graesser, A. C., Benson, L. C., English, L. D., & Duschl, R. A. (2020). On Computational Thinking and STEM Education. *Journal for STEM Education Research*, 3(2), 147-166. doi:10.1007/s41979-020-00044-w
- Mitchell, J. C. (1984). Typicality and the Case Study. In R. F. Ellen (Ed.), *Ethnographic Research: A Guide to General Conduct* (pp. 238-241). London: Academic Press.
- Niss, M. & Højgaard, T. (Eds.) (2011). *Competencies and mathematical learning ideas and inspiration for the development of mathematics teaching and learning in Denmark*. IMFUFA tekst no. 485. Roskilde: Roskilde University. (Published in Danish in 2002). Retrieved from: http://milne.ruc.dk/imfufatekster/pdf/485web_b.pdf
- Niss, M. & Højgaard, T. (2019). Mathematical competencies revisited. *Educational Studies in Mathematics*, 102, 9-28.
- Pérez, A. (2018). A framework for Computational Thinking Dispositions in Mathematics Education. *Journal for Research in Mathematics Education*, 49(4), 424-461.
- Sands, P., Yadav, A., & Good, J. (2018). Computational Thinking in K-12: In-service Teacher Perceptions of Computational Thinking. In M. S. Khine's (Ed.) *Computational Thinking in the STEM disciplines*, (pp.151-164). Springer International.
- Shute, V., Chen Sun, & Asbell-Clarke, J. (2017). Demystifying computational thinking. *Educational Research Review*, 22, 142-158.
- Tabach, M. (2021). Competencies for teaching mathematics in the digital era: Are we ready to characterize them? In Inprasitha, M., Changsri, N., & Boonsena, N. (Eds.) *Proceedings of the 44th Conference of the International Group for the Psychology of Mathematics Education* (Vol.1, pp. 32-47). Khon Kaen, Thailand: PME.
- Weintrop, D., Beheshti, E., Horn, M., Orton, K., Jona, K., Trouille, L., & Wilensky, U. (2016). Defining computational thinking for mathematics and science classrooms. *Journal of Science Education and Technology*, 25(1), 127-147.

On mathematical digital competency for teaching: The case of an expert teacher

Eirini Geraniou¹, Uffe Thomas Jankvist², Raimundo Elicer², Andreas Lindenskov Tamborg³ and Morten Misfeldt³

¹UCL Institute of Education, London, UK; e.geraniou@ucl.ac.uk

²Aarhus University, Copenhagen, Denmark; utj@edu.au.dk, raimundo@edu.au.dk

³University of Copenhagen, Denmark; andreas_tamborg@ind.ku.dk, misfeldt@ind.ku.dk

In this paper, we present a mathematics teacher's reflections on the design and experimentation of an activity sequence involving transitions from 'pen-and-paper' mathematical explorations to mathematical explorations within three different digital environments: GeoGebra, the Scratch programming environment and Excel. We look at her arguments for supporting students' development of Mathematical Digital Competency (MDC) and reflect on her instrumental orchestration approaches. We then argue and discuss the idea of MDC for teaching (MDCT) using this expert teacher's case as an exemplar for such practice.

Keywords: Digital competencies, instrumental orchestration, mathematical competencies, mathematical digital competency, mathematics teachers.

Introduction

In a recent paper, Geraniou and Jankvist (2019) argue that for mathematics students of today, their understanding of mathematical concepts involved in several mathematical situations might be “almost inseparable from the digital tools and the students’ instrumented techniques” usually associated with those situations (p. 43). Hence, “for such students, it is no longer only about either mathematical competency or digital competency. It becomes about mathematical digital competency” (p. 43). On this basis, they provide a first attempt at a definition of such MDC (see the following section). Accepting that mathematical digital competency (MDC) thus is an important component for students in 21st-century mathematics education, it is obvious to ask about MDC for teachers. Geraniou and Jankvist (2020) name this mathematical digital competency for teaching (MDCT) and provide a discussion of which potential theoretical frameworks might function—or network—well with the notion of MDC. These include (the theory of) instrumental orchestration (TIO), the Danish KOM framework’s six didactico-pedagogical competencies of mathematics teachers, mathematical knowledge for teaching (MKT), and the associated so-called TPACK (technological pedagogical content knowledge) framework. With reference to Geraniou and Jankvist (2019), Tabach (2021) picked up from a TPACK, and thus MKT, point of view to conclude:

Returning to the issue of teachers’ digital mathematical competencies with which I opened the talk, I believe that the MDC defined by Geraniou and Jankvist (2019) also applies to teachers. Beyond this is a complementary set of competencies, specifically didactical digital mathematical competencies, that are relevant to the work of mathematics teachers. In this talk I hinted at some of these, which I believe constitute a fruitful field for future research (Tabach, 2021, p. 44).

Tabach's "didactical digital mathematical competencies" correspond to our notion of MDCT. In this paper, we address this "complementary set of competencies" by taking a more empirical look at what MDCT might look like when practiced in a classroom by providing an illustrative case of an expert mathematics teacher in programming, Grace. The case stems from a larger project related to students' computational thinking (CT) and MDC and data was collected by the third author. Based on the theoretical basis of MDC and the empirical case, we attempt answers to the following exploratory research question: *Which components should MDCT at least encompass?* Before sharing more information about Grace, and engaging into the empirical case and the educational setting surrounding it, we provide a thorough description of the theoretical constructs on which we will rely: MDC and TIO.

Mathematical Digital Competency and Teacher Competencies

In our past work, we argued that when students interact with a piece of software in their efforts to solve a mathematical task, their digital competencies and their mathematical competencies are enacted and intertwined (Geraniou & Jankvist, 2019). Building upon the Danish mathematics competencies framework, KOM (Niss & Højgaard, 2019), and combining the Theory of Instrumental Genesis (Trouche, 2005) and Vergnaud's (2009) Theory of Conceptual Fields, Geraniou and Jankvist (2019) advanced the theoretical construct of students' MDC, proposing that students possessing such display the following characteristics:

- "[MDC1]: *Being able to engage in a techno-mathematical discourse.* In particular, this involves aspects of the artefact-instrument duality in the sense that instrumentation has taken place and thereby initiated the process of becoming techno-mathematically fluent.
- [MDC2]: *Being aware of which digital tools to apply within different mathematical situations and context, and being aware of the different tools' capabilities and limitations.* In particular, this involves aspects of the instrumentation–instrumentalisation duality.
- [MDC3]: *Being able to use digital technology reflectively in problem solving and when learning mathematics.* This involves being aware and taking advantage of digital tools serving both pragmatic and epistemic purposes, and in particular, aspects of the scheme-technique duality, both in relation to one's predicative and operative form of knowledge" (p. 43).

For teachers to assist students in developing their MDC, besides possessing MDC to some extent themselves, they need MDC for teaching (MDCT). Niss and Højgaard's (2019) definition of mathematical competence as "someone's insightful readiness to act appropriately in response to all kinds of mathematical challenges pertaining to given situations" (p. 12) should be taken into account when considering MDC for teaching. Teacher competencies are not to be mistaken for solely a set of traits or skills; rather, they are defined in the way in which specific actions are implemented and the intentionality and importance that both precede and follow those actions (Winch, 2017). Teacher competencies are defined as the personal qualities—specifically, knowledge, beliefs, and motivation, as distinguished from behaviours and interactions—required for teachers to meet the demands in their profession (Fauth et al., 2019). Krumsvik and Jones's (2013) characterisation of teacher's digital competencies involves two dimensions, that of the competency to use technology for personal use and that of the competency to use technology in pedagogical settings. This has also been

conceptualised as the double instrumental genesis (Haspekian, 2011), a process involving a pedagogical instrumental genesis on top of a teacher's personal instrumental genesis.

Theory of Instrumental Orchestration (TIO)

To analyse how the enactment of the double instrumental genesis takes place, and in fact how a teacher manages and orchestrates the use of digital technology in mathematical learning situations, we use TIO. TIO was derived by Trouche (2004) and later elaborated by Drijvers et al. (2014) as “the teacher's intentional and systematic organisation and use of the various artefacts available in a learning environment—in this case a computerised environment—in a given mathematical task situation, in order to guide students' instrumental genesis” (p. 191). TIO involves the following three elements: (a) a *didactic configuration*, that is the arrangement of artefacts in the teaching environment; (b) an *exploitation mode*, or in other words the approach a teacher chooses to exploit a didactical configuration to assist their didactical intentions; (c) a *didactical performance*, that entails the decisions a teacher needs to make instantly, while teaching to accommodate the chosen didactic configuration and exploitation mode. Seven orchestrations have been identified for whole class teaching in up-to-date research studies and one for students working alone or in pairs with technology (Drijvers et al., 2014): (1) *technical-demo* orchestration concerns demonstration of tool techniques by the teacher; (2) *link-screen-board* orchestration, where the teacher stresses the relationship between what happens in the technological environment, and its representation in the conventional mathematics of paper, book and board; (3) *discuss-the-screen* orchestration concerns a whole-class discussion about what happens on the computer screen; (4) *explain-the-screen* orchestration concerns whole-class explanation by the teacher, guided by what happens on the computer screen; (5) *spot-and-show* orchestration, where students' reasoning is brought to the fore through the identification of their work during the preparation of the lesson and its use in a classroom discussion; (6) *Sherpa-at-work* orchestration, a so-called Sherpa student (Trouche, 2004, 2005) uses the technology to present his or her work, or carry out actions on the teacher's request; and (7) *work-and-walk-by* orchestration, which is where the didactical configuration and the corresponding resources basically consist of the students sitting at their technological devices, and the teacher walking around in the classroom. All these seven orchestrations involve whole-class teaching (Drijvers et al., 2014), and have been derived to describe the teacher's role in supporting and guiding students while they interact with a digital resource, as well as helping them learn the mathematics involved and how to use the resource.

The case of expert teacher Grace

The empirical basis of this paper relies on the collaborative work between the third author and Grace. Grace is a mathematics teacher with 37 years of experience, a mathematics advisor in her municipality, and current member of the mathematics expert group for the Danish Ministry of Education. Moreover, she has a particular expertise and interest in programming, leading a non-profit organisation that involves children into coding for seven years. The collaborative work began by offering Grace a didactical sequence, where students should combine their mathematical and programming learning to solve a task. In particular, the goal of the offered task was to code a program in Scratch that draws a regular polygon of any given number of sides (see Figure 1). The original design is inspired by Papert's (1980) Turtle geometry, and the decisions on the order of coding

different polygons were informed by the *ScratchMaths* project (Benton et al., 2017). Data were collected in one pre- and one post-intervention interviews with Grace, and video and audio recordings from the classroom experience and were transcribed, anonymised and translated. The researchers' reflections presented below are based on all these data. The implemented version of the task consisted of three 90-minute sessions with one of Grace's 6th-grade classes, who were introduced to Scratch in the first session. These sessions are summarised below.

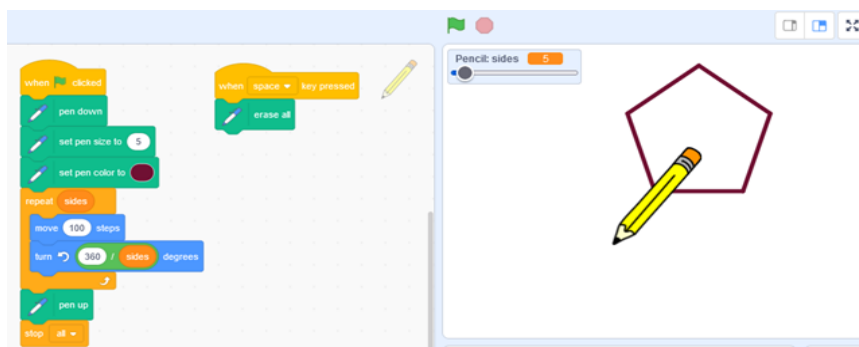

Figure 1: A sample solution of the original proposed task

Session 1: Introduction to Scratch's pen environment. Grace invited students to open Scratch and explore its capabilities. Every so often, students would share with the class what they have found. Grace steered the conversation toward key features: create and remix blocks, the green flag and the pen environment. The session ended with some pre-made code that students should fix.

Researchers' reflections on Session 1. Grace had already reflected on the best tools to use to teach the mathematical topic of 'Angles in a polygon' (MDC2) and aimed for the students to become familiarised with the Scratch environment and its coding language. Grace used a combination of orchestrations, such as: *work-and-walk-by* to support students when and if needed while they interacted with Scratch in their allocated computers; *technical-demo*, *discuss-the-screen* and *explain-the screen* in an effort to draw students' attention to key features mentioned above (e.g., create and remix blocks), and allow students to learn and appreciate what all these key features in Scratch do. Such an approach prepared students to interact with Scratch and initiated students' *engagement in a techno-mathematical discourse* (MDC1), as well as their awareness of Scratch's *capabilities and limitations* (MDC2). At the end of the session, Grace presented students with a pre-made Scratch code and asked students to correct it. In this activity, students began to consider Scratch as an instrument to support them in their mathematical explorations and therefore continued to develop their techno-mathematical discourse. This could not have taken place without Grace's support and guidance. She used several orchestrations and showcased her ability in didactically configuring the activity sequence so that students began to engage with MDC1 and in particular MDC2.

Session 2: Coding polygons. After a briefing on regular polygons, Grace asked the students to code regular polygons in Scratch. The students had the freedom to choose colours, size and order. Upon sharing their findings, Grace displayed an Excel spreadsheet, where the students in collaboration should fill in the turning angle and the sum of exterior angles for each polygon. Grace's past experiences with this class of 6th graders involved training to use Excel to record and discuss tabular data (e.g., daily numbers of Covid-19 infections), which led to the use of Excel as an alternative to

the blackboard. Later, she showed the students how to use another digital resource, GeoGebra, and use the “Regular Polygons” feature and record the interior angles of each polygon (starting from a triangle) and the sum of interior angles in the same Excel spreadsheet (see Figure 2).

	A	B	C	D	E	F	G
1	Kant	Vinkel Scratch	Vinkelsum			Vinkel GeoGebra	Vinkelsum
2							
3	3-kant	120	360			60	180
4	4-kant	90	360			90	360
5	5-kant	72	360			108	540
6	6-kant	60	360			120	720
7	7-kant	51	360			128,57	899
8	8-kant	45	360			135	1080
9	9-kant	40	360			140	1260
10	10-kant	36	360			144	1440

Figure 2: Excel screen capture of students’ collection of angles and sum of angles by means of Scratch and GeoGebra (‘Kant’ is ‘side’; ‘Vinkel’ is ‘angle’; ‘Vinkelsum’ is ‘sum of angles’).

Researchers’ reflections on Session 2. Grace wanted to compare different approaches to creating regular polygons and investigating their interior and exterior angles and the sum of those angles. She demonstrated *awareness of which digital tools to apply within different mathematical situations and context* (in this case the focus being on either exterior angles of polygons, leading to the use of Scratch, or interior angles of polygons, leading to the use of GeoGebra) (MDC2). She drew students’ attention to how the sprite in Scratch ‘forced’ students to visualise the direction the sprite was going to move; hence, recognise that the focus was indeed on identifying how many degrees the sprite had to ‘turn’ to draw the next side of the polygon, and that ‘turn’ was in fact the exterior angle of the polygon. She also drew students’ attention to the angle indicated in their GeoGebra constructed polygons, which indeed was the interior angle of those polygons. She used the *explain-the-screen* orchestration to discuss the two different computations taking place in Scratch and GeoGebra, but also to showcase the data on angles of polygons presented in a different digital resource, Excel. This latter action encouraged students to reflect on and compare exterior and interior angles of polygons of different number of sides, and spot any patterns, e.g., the sum of exterior angles of any polygon always being 360 degrees. We can argue that she took the *link-screen-board* orchestration a step further and instead of using the *physical* board to link what was happening in Scratch and in GeoGebra, she decided to use a third digital resource, Excel, that allowed her instantly to present the sum of angles in a polygon in a tabular representation. In a way, she used a *link-different-digital-resources* orchestration. She also *took advantage* of the three digital resources *erving both epistemic and pragmatic purposes* for her own teaching and her students’ mathematical learning (MDC3). All her decisions reveal her possession of all three elements of MDC and her awareness and application of didactical pedagogical strategies for teaching mathematics with the chosen three digital resources, which can be characterised as MDCT.

Session 3: Drawing skylines. The session began with summarizing findings from the previous session, discussing the patterns between angles and sum of angles in both Scratch and GeoGebra, displayed in the Excel spreadsheet. Students were then encouraged to find skylines of buildings of their interest, draw them on paper, and make notes on how to code them in Scratch. Afterwards, they used Scratch to create their chosen skylines, applying their knowledge of polygons.

Researchers’ reflections on Session 3. This session was dedicated to recapping and reflecting on what took place in the previous two sessions: students’ development of a techno-mathematical discourse regarding the three digital resources used (MDC1); the expected gained mathematical knowledge and knowledge of how to interact with Scratch, GeoGebra and Excel, their capabilities and limitations (MDC2); the use of Scratch, GeoGebra and Excel reflectively to learn about the interior and exterior angles of polygons (MDC3). This was achieved by Grace using orchestrations such as *discuss-the-screen* and *explain-the-screen*, to draw students’ attention to their past work on Scratch, GeoGebra and Excel, as well as the orchestration we proposed earlier on, *link-different-digital-resources*, which allowed Grace to move between the three different digital resources and the three different interfaces showing their mathematical work. The students’ and teachers’ MDC were enacted once again with the last task, which was to model a skyline of a building of their choice using Scratch and thus allowed for consolidating their gained mathematical knowledge on polygons and techno-mathematical discourse (MDC1). This last teaching session actually engaged students the most, as they used a real-life context of their own choice and applied their MDC to produce their own codes in Scratch, leading to the creation of amazing buildings’ skyline models (see Figure 3).



Figure 3: A student’s model of the Brandenburg Gate in Berlin, Germany, as modelled in Scratch

Grace’s reflections. At the end of the activity sequence, Grace was interviewed by the third author and discussed her recollections of her decisions on how best to deliver the suggested activity sequence and accommodate the transitions from pen and paper to the three digital resources used. First, Grace wanted her students to be the ones posing the problem, and exploring their own solution strategies as sub-problems appear. The context of the last task was agreed to be the drawing of skylines of buildings of their choice, by learning first to draw polygons on paper, in Scratch and in GeoGebra. Second, the solution to the problem should involve both computational and mathematical knowledge and skills. This criterion validates the task’s original purpose. Third, Grace suggested involving more digital resources in their work. Based on her own trials with other classrooms, she decided to include Excel to systematize the collection of data and aid pattern recognition. She was aware of the benefits of using Excel, as it allowed seeing what the turning angle needed to create each regular polygon (triangle, square, pentagon...) is in Scratch and the interior angles in GeoGebra, in relation to the sum of angles. During the interview, Grace remembered that during Session 2, students asked “why can we not simply use GeoGebra, which draws regular polygons automatically?”. She argued that she used Excel as an additional tool to support students’ recollection of the different angles in polygons and enable them to compare, reflect and derive mathematical statements regarding interior and exterior angles of polygons. Scratch, GeoGebra and Excel surely played different roles in the activity sequence, and students explored their affordances and limitations, an important mathematical learning process with digital technologies and an important element of acquisition of MDC.

Conclusion

The above discussions of Grace's teaching show that she possessed MDC herself, while making didactical decisions on how the activity sequence should be exploited with students, and in particular which digital resources are the best to achieve the learning goals and why, and which instrumental orchestrations should be implemented in her teaching practice to support these goals. Her pedagogical considerations were evident when: (a) 'making' the technology accessible to students by allowing students to explore Scratch and 'debug' a code, for example, and supporting them in developing a techno-mathematical discourse (MDC1); (b) identifying the best tools to focus on exterior angles (Scratch), on interior angles (GeoGebra) and on deriving mathematical statements about interior and exterior angles as well as the sum of those angles (Excel), based on considerations of those three tools' capabilities and limitations (MDC2); (c) encouraging students to use Scratch to solve the problem of modelling the skylines of their chosen buildings and in the process apply their gained knowledge on interior and exterior angles of polygons (MDC3). Considering our exploratory research question: "Which components should MDCT at least encompass?", we draw on Niss and Højgaard's (2019) definition of mathematical competencies and based on the empirical data from Grace's example, we understand MDCT as the competencies teachers need (or have) to select and implement technology in their practice in pedagogically productive ways. Inspired and informed by the previous literature and research on students' MDC (Geraniou & Jankvist, 2019) and Niss and Højgaard's (2019) description of both students and teachers' competencies, we use the definition for students' MDC to conceptualise teachers' competencies in using technology, re-defined to suit teachers by including pedagogic elements. Therefore, we propose the following MDCT:

- [MDCT1]: Being able to engage in a techno-mathematical discourse **at a meta-pedagogic level**.
- [MDCT2]: Being aware of which digital tools to apply within different mathematical situations and context, and being aware of the different tools' capabilities and limitations, **so as to think, and act, pedagogically with these tools**, while considering the benefits and limitations of these.
- [MDCT3]: Being able to use digital technology reflectively in problem solving and when doing (learning **or teaching**) mathematics.

Our future work entails further research to investigate, validate and refine the above 'tentative' MDCT and show their importance in the effective use of digital resources in mathematics education.

Acknowledgement

This paper was partly written in the frame of project 8018-00062B under *Independent Research Fund Denmark* and project NNF19OC0058651 under *Novo Nordisk Foundation*.

References

- Benton, L., Hoyles, C., Kalas, I., & Noss, R. (2017). Bridging primary programming and mathematics: Some findings of design research in England. *Digital Experiences in Mathematics Education*, 3(2), 115–138. <https://doi.org/10.1007/s40751-017-0028-x>
- Drijvers, P., Tacoma, S., Besamusca, A., van den Heuvel, C., Doorman, M., & Boon, P. (2014). Digital technology and mid-adopting teachers' professional development: A case study. In A.

- Clark-Wilson, O. Robutti, & N. Sinclair (Eds.), *The mathematics teacher in the digital era* (pp. 189–212). Springer. https://doi.org/10.1007/978-94-007-4638-1_9
- Fauth, B., Decristan, J., Decker, A.-T., Büttner, G., Hardy, I., Klieme, E., & Kunter, M. (2019). The effects of teacher competence on student outcomes in elementary science education: The mediating role of teaching quality. *Teaching and Teacher Education*, 86, 102882. <https://doi.org/10.1016/j.tate.2019.102882>
- Geraniou, E., & Jankvist, U. T. (2019). Towards a definition of “mathematical digital competency.” *Educational Studies in Mathematics*, 102(1), 29–45. <https://doi.org/10.1007/s10649-019-09893-8>
- Geraniou, E., & Jankvist, U. T. (2020). “Mathematical digital competencies for teaching” from a networking of theories perspective. In B. Barzel, R. Bebernik, L. Göbel, M. Pohl, H. Ruchniewicz, F. Schacht, & D. Thurm (Eds.), *Proceedings of the 14th International Conference on Technology in Mathematics Teaching – ICTMT 14* (pp. 368–375). DuEPublico. <http://doi.org/10.17185/duepublico/70775>
- Haspekian, M. (2011). The co-construction of a mathematical and a didactical instrument. In M. Pytak, T. Rowland, & E. Swobada (Eds.), *Proceedings of the Seventh Congress of the European Society for Research in Mathematics Education (CERME 7)* (pp. 2298–2307). University of Rzeszów & ERME. <https://hal.archives-ouvertes.fr/hal-01273866>
- Krumsvik, R., & Jones, L. (2013). Teachers’ digital competence in upper secondary school: (Work in progress). In L. Morris & C. Tsolakidis (Eds.), *Proceedings of the International Conference on Information Communication Technologies in Education (ICICTE 2013)* (pp. 171–183). ICICTE.
- Niss, M., & Højgaard, T. (2019). Mathematical competencies revisited. *Educational Studies in Mathematics*, 102(1), 9–28. <https://doi.org/10.1007/s10649-019-09903-9>
- Papert, S. (1980). *Mindstorms: Children, computers and powerful ideas*. Basic Books.
- Tabach, M. (2021). Competencies for teaching mathematics in the digital era: Are we ready to characterize them? In M. Inprasitha, N. Changsri, & N. Boonsena (Eds.), *Proceedings of the 44th Conference of the International Group for the Psychology of Mathematics Education* (Vol. 1, pp. 32–47). PME.
- Trouche, L. (2004). Managing the complexity of human/machine interactions in computerized learning environments: Guiding students’ command process through instrumental orchestrations. *International Journal of Computers for Mathematical Learning*, 9, 281–307. <https://doi.org/10.1007/s10758-004-3468-5>
- Trouche, L. (2005). Instrumental genesis, individual and social aspects. In D. Guin, K. Ruthven, & L. Trouche (Eds.), *The didactical challenge of symbolic calculators: Turning a computational device into a mathematical instrument* (pp. 197–230). https://doi.org/10.1007/0-387-23435-7_9
- Vergnaud, G. (2009). The theory of conceptual fields. *Human Development*, 52(2), 83–94.
- Winch, C. (2017). *Teachers’ know-how: A philosophical investigation*. Wiley.

Identification of domains of mathematics teachers' knowledge addressed in reflection on technology-supported mathematical trails

Silvia Haringová and Janka Medová

Constantine the Philosopher University in Nitra, Faculty of Natural Sciences and Informatics,
Department of Mathematics, Nitra, Slovakia;
silvia.haringova@ukf.sk, jmedova@ukf.sk

This paper focuses on professional development of mathematics teachers in collaborative groups. It is theoretically based on the model of lesson study and the mathematics teachers' specialised knowledge model. Lesson study appears to be a suitable method of professional development stimulated by mathematical trails. A mathematical trail is an activity during which students can discover and solve mathematical problems related to real objects. Mathematics teachers collaborate and design mathematical trails for their students and thus their competencies develop. Our analysis of mathematics teachers' specialised knowledge addressed during reflection on the conducted MathCityMap trail in the form of lesson study points out that all subdomains of pedagogical content knowledge as a part of Mathematics Teachers' Specialised Knowledge (MTSK) have been identified. Identified topics accompanied by examples of teachers' communication acts are presented.

Keywords: mathematical trail; lesson study; professional development; teachers' knowledge.

Professional development in collaborative groups

Nowadays, collaboration among teachers in activities closely linked to their mathematics lessons is considered to be the most appropriate form of professional development of in-service (mathematics) teachers (Prediger, 2020). Current Slovak legislation makes it possible to situate in-service teacher training directly in schools. A well-designed in-service professional development programme influences the knowledge and beliefs of mathematics teachers (Desimone, 2009).

Lesson study, when more- or less-experienced teachers of mathematics and didacticians work together to design an optimal lesson on a pre-agreed topic, seems to be an appropriate method of professional development (Murata, 2011). It has a cyclic nature consisting of four stages: study, plan, teach and reflect (Lewis et al., 2019) intervening changes in teachers' knowledge, beliefs, routines of professional learning and pedagogies which influence the instruction and therefore students' learning (Figure 1). Beliefs play an important role in assessing curricula, teaching, learning and assessing students' knowledge and are grounded in teachers' knowledge and experience (Carrillo-Yañez et al., 2018). Teacher knowledge and beliefs influence various areas of mathematics lesson planning, implementation, and reflection (Ball et al., 2008; Carrillo-Yañez et al., 2018) including the use of students-oriented teaching methods such as a mathematical trail. Implementation of the lesson study varies across the countries and needs to be tailored to the national context.

Mathematics Teachers' Specialised Knowledge (MTSK) model

The growing interest in research concerning the specific knowledge that mathematics teachers have at disposal and use has led to development of analytical models that aim to organize, define, and analyze this knowledge in order to interpret, characterize, and even reproduce it. According to the MTSK model (Carrillo-Yañez et al., 2018) the teachers' knowledge consists of three parts:

Mathematical Knowledge; Pedagogical Content Knowledge and Beliefs. Mathematical Knowledge and Pedagogical Content Knowledge are further divided into three subdomains. Beliefs are placed in the center of the knowledge to emphasize the correlation between beliefs and domains of knowledge.

Mathematical Knowledge

Carrillo-Yañez et al. 'understand mathematics as a network of systemic knowledge structured according to its own rules' (2018, p. 6). A good understanding of this network, the underlying rules and properties related to the process of constructing mathematical knowledge allow teachers to teach mathematical content in a way of connecting and verifying their own and students' conjectures. Teachers' mathematical knowledge is divided into three subdomains: knowledge of the content of mathematics itself (Knowledge of Topic – KoT); interconnected systems that connect the subject (Knowledge of the structure of mathematics – KSM); and the way in which mathematics is progressed (Knowledge of practices in mathematics – KPM).

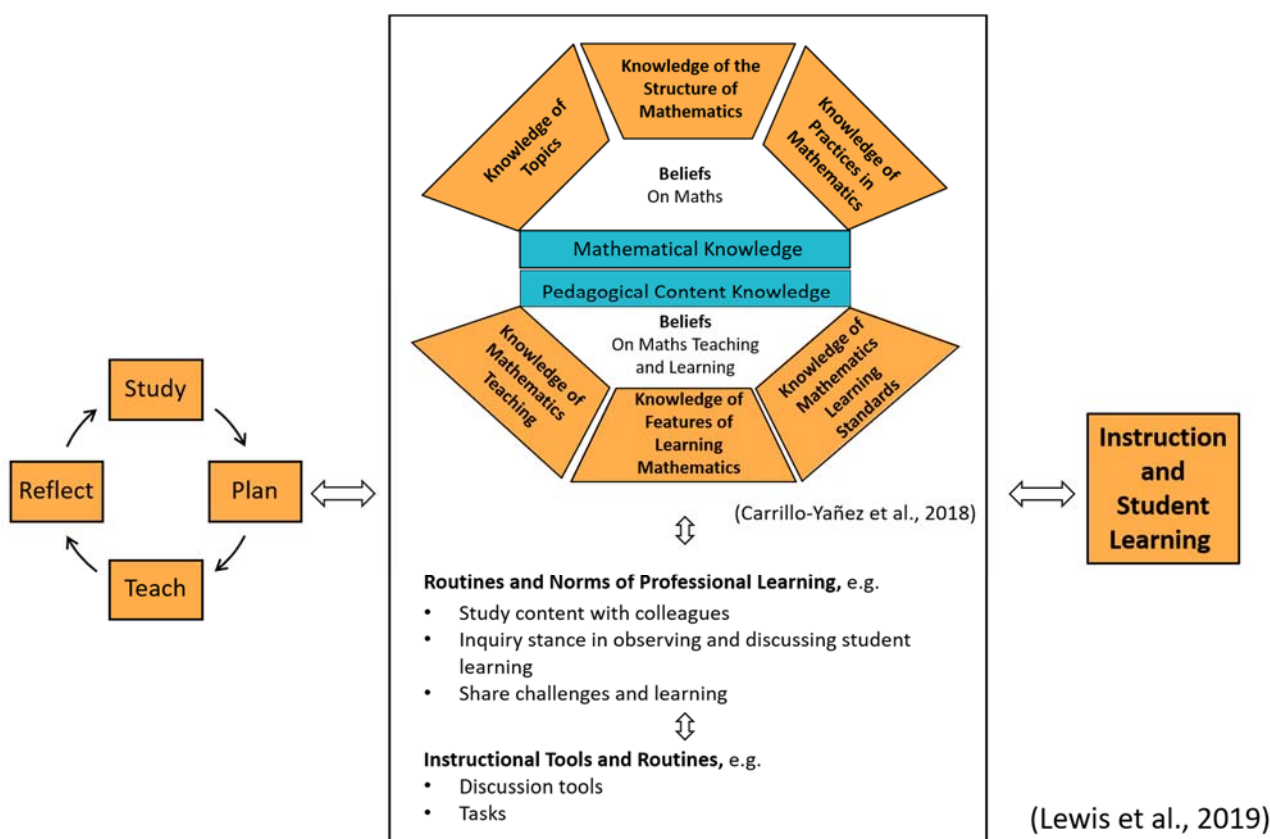

Figure 1: Model of lesson study including the framework for assessing teachers' knowledge

Pedagogical Content Knowledge

Pedagogical Content Knowledge is knowledge of mathematical teaching and learning - the area of teachers' knowledge that may be based on research-based theories in mathematics education or on teachers' personal experiences and reflections from their practice. It comprises three subdomains: awareness of the potential of activities, strategies and techniques for teaching specific mathematical content (Knowledge of Mathematics Teaching – KMT); knowledge about how students think and construct knowledge when solving mathematical activities and problems (Knowledge of Features of Learning Mathematics – KFLM); knowledge of the curriculum (Knowledge of Mathematics Learning Standards – KMLS).

Mathematical trails in teachers' professional development

A mathematical trail is an activity during which participating students look for and then solve a set of mathematical problems on real objects. The tasks are located within walking distance and various measuring devices are often used to obtain data needed to solve the problems. Each trail consists of at least four mathematical problems. Each problem requires GPS location and an image related to the location of the problem (Bočková et al., 2020). MathCityMap trails (MCM trails) are part of outdoor education supported by mobile technologies (Barlovits & Ludwig, 2020). They use 'bring your own device' approach in school as well as out-of-school contexts. In addition to the mathematical version of geocaching, students engaged in MCM trail solve mathematical problems related to real objects (Čeretková & Bulková, 2020), create the original solutions of the problems, communicate their ideas, reasoning and strategies during collaboration in teams what makes mathematical trail suitable tool to develop the competences for 21st century as defined by non-profit organization Partnership for 21st Century Education (Haringová, 2022).

MCM trails are created on the portal <https://mathcitymap.eu/> and implemented through the MathCityMap application. The application is freely available, supported by Android and iOS operating systems. This application on mobile devices displays maps, photos of objects that are related to the tasks, task assignment and hints helping to solve individual tasks. Answers are entered directly into the application, with users receiving immediate feedback on the correctness of their solutions. After registration in the portal, users can design their own MCM trails. The tasks can be used for private purposes or after review by experts, freely accessible to all MCM users. System allows various task formats, multiple choice, short answer, exact value, and number from interval. Each task contains hints that should help the solver while solving the task. A hint can be a formula, sketch, instructional question, or method of solving a problem. The sample solution is expected to be clear and understandable for each solver (Bočková et al., 2020).

Methodology

In this paper we describe the collaboration among mathematics teachers from one grammar school and the didacticians in the school-based professional development activity. The grammar school was given a grant from Ministry of Education, Science, Research and Sport of the Slovak Republic aiming at support the collaboration among mathematics, science and computer science teachers in form of so-called 'pedagogical clubs' where the teachers meet on monthly basis and discuss their needs (Šunderlík, 2021). After two years of regular sessions, the teachers asked the second author to join their sessions and conduct with them several lesson studies on various topics. The teacher responsible for the pedagogical club was interviewed prior to the first meeting, in order to understand the needs of participating teachers. According to him, the students in their school lack the opportunities to develop collaboration and communication skills, especially after the school year 2020/21 when they spent more than three months in on-line education. We considered the MCM trail as a promising tool for development of the mentioned competences (Haringová, 2022), at the same time a promising tool for initiating the collaboration among the teachers and the didacticians and stimulating the reflection on the current practices of participating teachers.

In this paper we will focus on the intellectual component of the teachers' professionalism (Evans, 2014), particularly to the knowledge of mathematics teachers. This study tries to address the

following research question:

What subdomains of mathematics teachers' specialized knowledge are addressed during reflection on enacted MCM trail in form of lesson study?

The MCM trail was designed for the students of Grade 8. Four teachers with varying length of experience and two didacticians (authors of this paper) collaborated in its design. As the first step of the lesson-study cycle the teachers solve the MCM trail prepared by didacticians to allow them to experience the MCM trail from the students' view. In the planning phase each teacher posed two or three problems and the MCM trail independently. Then the MCM trail was constructed collaboratively when teachers and didacticians reflected on the twelve posed problems and chose seven of them for a trail. The trail was implemented in the classroom of Grade 8 with 24 students during three lessons. Two lessons aimed at solving the tasks on site and the third at reflection and whole-class discussion of the students' solution. The group reflection facilitated by the didacticians was held after enacting the MCM trail. All the activities (teachers' solving the MCM trail, collaborative construction of the trail, teachers supervising the students during the enacting of the trail, collective reflection of the enactment) were audio-recorded and partially transcribed to allow the thorough analysis of the data.

For the purpose of this study the collective reflection was transcribed and the turns of the participants were coded according to the subdomains of the mathematics teachers' specialized knowledge (MTSK) model by Carrillo-Yañez (2018). The pseudonyms are used for all the participants. The first author did the coding of the whole session, the second author coded subset of the turns and in the results we list only those examples where both authors used the same codes.

Results

First, we provide information about the MCM trail developed collaboratively with the teachers (Figure 2 and 3). As the grammar school (Gymnasium of Cyril and Methodius, GCM) is situated in the broader center of Nitra, the trail is situated in the pedestrian zone. It can be searched in the MathCityMap under the name "GCM and pedestrian zone" or using the six-digit code that is automatically generated when creating trails on the portal. This MCM trail has the code 196370. The developed MCM trail consists of six tasks, which are represented on the map as specific task positions. It is aimed at practicing the mathematical knowledge of Grade 8 students. Tasks in the participating teachers' trail are focused on working with percentages, decimal numbers, combinatorics, area calculation and application tasks for financial literacy. In the figures 4 and 5 there are shown the two tasks from the MCM trail. Definition and solution of tasks in English are in Table 1.

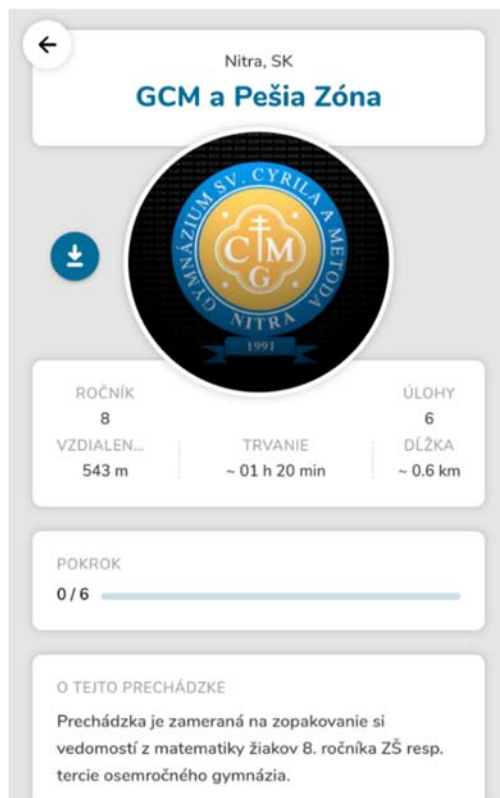

Figure 2 MCM trail created by teachers

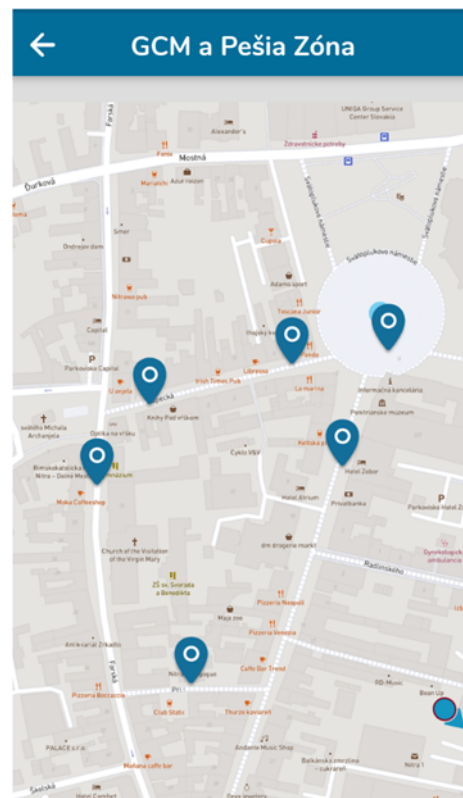

Figure 3 Location of tasks in the map



Figure 4 Small paving tiles

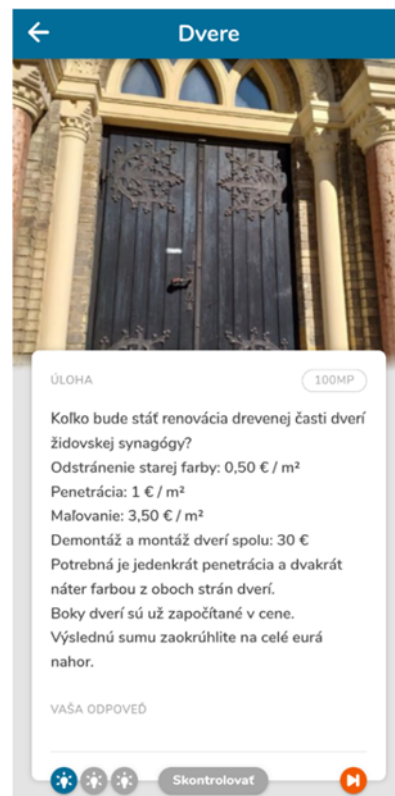

Figure 5 Doors

Table 1: Definition and sample solution of the tasks Paving small cubes and Doors

Definition of task	Sample solution
Small paving tiles	
The area around the hatch is paved with small cubes. Calculate the area of this area. Write the result in square decimeters.	The content of the large square is $9.8 \cdot 9.8 = 96.04 \text{ dm}^2$. The content of the small square is $7 \cdot 7 = 49 \text{ dm}^2$. The surface area is $96.04 - 49 = 47.04 \text{ dm}^2$.
Doors	
How much will it cost to renovate the wooden part of the door of the Jewish synagogue? Old color removal: 0.50 €/m^2 Penetration: 1 €/m^2 Painting: 3.5 €/m^2 Dismantling and assembly of doors together: 30 € It is necessary to penetrate once and paint twice from both sides of the door. The door sides are already included in the price. Round the resulting amount up to whole euros.	Door width - measure: 169 cm Door height - measure or calculate using the number of bricks: Number of bricks: 33 Height of 1 brick with joint: 7.5 cm Door height: $33 \cdot 7.5 = 247.5 \text{ cm}$ Door front surface: $S = a \cdot b = 169 \cdot 247.5 = 41\,827.5 \text{ cm}^2$ $2 \times$ door area: $2 \cdot 41\,827.5 = 83\,655 \text{ cm}^2 = 8.3655 \text{ m}^2$ door Costs per m^2 : $0.50 + 1 + 2 \cdot 3.50 = 8.50 \text{ €}$ Costs of the door: $8.3655 \cdot 8.50 = 71.10675 \text{ €}$ $71.10675 + 30 = 101.1067 \text{ €}$, rounded up to whole euros: 102 €

In order to address the research-question we categorized the participants' turns in the shared reflection based on the mathematics teachers' specialized knowledge model (Carrillo-Yañez et al., 2018). The teachers' dialogues did not include any communication acts in the domain of mathematical knowledge. Among the other acts we identified all the subdomains of pedagogical content knowledge. Further we present identified topics accompanied by examples of teachers' turns in the reflection.

Knowledge of Mathematics Teaching

According to initial interviews with the teachers, only one of them uses group-work on a regular basis. Therefore, it was not surprising that the aspects of group-work and observing of the group-work occurred during several phases of the reflection.

- Martina: They could be so divided into groups that not boys together and girls together, I feel so better when they are mixed.
- Pavol: When I was at the task-site (Small paving tiles), they solved it well. The whole group said out loud "What should we solve? Is it maybe a square? Measure." So, they measured. "And it's a square? Measure the other side, it looks like it's a square and what should we solve?" There were a few wrong ideas. "No, it can't be that way. It must be the big one." So, they figured they had to subtract the bigger one from the smaller one.

Knowledge of Features of Learning

Teachers observing and supervising students' solving of problems in mathematical trail addressed also several emotional aspects, like "the students were engaged" (Tatiana), "some of the students were frustrated by the task with higher difficulty" (Livia) or "the boys liked the practicality of tasks".

Also, the mistakes which occurred during the students' problem-solving were described:

Karol: They had it in meters and another they put it in centimeters, but they did not convert it and then the content writes that the two meters minus 160 and we were in minus.

Knowledge of Mathematics Learning Standards

When teachers were supervising students while solving the tasks they found out that most of them encountered various problems with measuring and using the measurement tools. None of the teachers knew whether measuring is included in mathematics or technology curricula. One of the didacticians had to address their uncertainty.

Daniela: They have a first measurement in mathematics in the third grade: the student knows the means of measurement, the length of their unit and can use them independently in practical measurements.

Another turn identified as belonging to knowledge of mathematical learning standards is related to independent problem-solving, including critical views on their own work. This was formulated by one of the teachers as follows:

Pavol: You could see it spinning in their head. "And what are we supposed to do?" and then what was normal is that you give the task and then you roughly know what to do, but they had to write the data from the task themselves! I liked that they had to take a step more, which they don't normally do.

Concluding remarks

The main aim of this study was to investigate the potential of technology-supported mathematical trail for professional development of mathematics teachers and identify what kind of remarks the mathematics teachers have when planning and enacting the MCM trail. Based on the presented data, we can claim that the various aspects of teachers' knowledge were addressed in the shared reflection on the enactment of the MCM trail. We identified at least two examples of statements related to each subdomain of mathematics teachers' pedagogical content knowledge as defined by Carrillo-Yañez et al. (2018). As seen from provided data, almost all the participating teachers shared their experiences in the subsequent reflection.

It seems that MCM trails are really stimulating activity and therefore a promising approach for professional development of mathematics teachers. The affordances of MCM trails for stimulating collaboration among the teachers and building community of practices should be further investigated.

Acknowledgement

The project is (partially) funded by the Slovak Research and Development Agency under the contract No. APVV-20-0599, by the Ministry of education, science, research and sport of the Slovak Republic under grant no. KEGA 015UKF-4/2021 and by European Commission under grant no. 101052670 — proSTEM — ERASMUS-EDU-2021-PEX-TEACH-ACA.

References

- Ball, D. L., Thames, M. H., & Phelps, G. (2008). Content knowledge for teaching: what makes it special? *Journal of Teacher Education*, 59(5), 389–407. <https://doi.org/10.1177/0022487108324554>
- Barlovits, S., & Ludwig, M. (2020). Mobile-supported outdoor learning in math class: draft of an efficacy study about the MathCityMap app. M. Ludwig et al. (Eds.) *Research on Outdoor STEM*

Education in the digiTal Age, Online Conference. WTM – Verlag für wissenschaftliche Texte und Medien, Münster. (pp. 55-62). <https://www.wtm-verlag.de/DOI-Deposit/978-3-95987-144-0/978-3-95987-144-0-Book.pdf>

- Bočková, V., Pavlovičová, G. & Čeretková, S. (2020). Increasing pupils' interest in geometry through mathematical trails. L.G. Chova, A.L. Martinez & I.C. Torres (Eds). *ICERI Proceedings: 2020: 13th annual International Conference of Education, Research and Innovation, held on 9-10 November 2020, On-line conference* (pp. 2038-2047). IATED Academy. 10.21125/iceri.2020.0499.
- Carrillo-Yañez, J., Climent, N., Montes, M., Contreras, L. C., Flores-Medrano, E., Escudero-Ávila, D., Vasco, D., Rojas, N., Aguilar-Gonzales, A., Ribeiro, M. & Muñoz-Catalán, M. C. (2018). The mathematics teacher's specialised knowledge (MTSK) model. *Research in Mathematics Education*, 20(3), 236-253. 10.1080/14794802.2018.1479981
- Čeretková, S., & Bulková, K. (2020). Mathematics trails in initial teachers' education in Slovakia. *APLIMAT 2020: Proceedings from 19th Conference on Applied Mathematics*. Slovak University of Technology, Bratislava, Slovakia. (pp. 232-236).
- Desimone, L. M. (2009). Improving impact studies of teachers' professional development: toward better conceptualizations and measures. *Educational Researcher*, 38(3), 181-199. 10.3102/0013189X08331140
- Evans, L. (2014). Leadership for professional development and learning: enhancing our understanding of how teachers develop. *Cambridge Journal of Education* 44(2), 179-198. 10.1080/0305764X.2013.860083
- Haringová, S. (2022). *Význam zaradenia matematických prechádzok do vyučovania matematiky [The importance of including math trails in teaching]*. Paper presented at Student scientific conference, held on 6 April 2022 in Nitra, Slovakia.
- Lewis, C., Friedkin, S., Emerson, K., Henn, L., & Goldsmith, L. (2019). How does lesson study work? Toward a theory of lesson study process and impact. In R. Huang, A. Takahashi, & J. P. da Ponte (Eds.), *Theory and Practice of Lesson Study in Mathematics: An International Perspective* (pp. 13–37). Springer International Publishing. (pp. 13-37). https://doi.org/10.1007/978-3-030-04031-4_2
- Murata, A. (2011). Introduction: conceptual overview of lesson study. In L. C. Hart, A. S. Alston, & A. Murata (Eds.), *Lesson Study Research and Practice in Mathematics Education: Learning Together*. (pp. 1-12). Springer Netherlands. 1007/978-90-481-9941-9_1
- Prediger, S. (2020). Content-specific theory elements for explaining and enhancing teachers' professional growth in collaborative groups. H. Borko & D. Potari (Eds.) *Teachers of Mathematics Working and Learning in Collaborative Groups*. (pp. 2-14). Lisbon, Portugal.
- Šunderlík, J. (2021). Pedagogický klub matematickej gramotnosti počas pandémie. [Pedagogical club of mathematical literacy during the pandemics]. *Proceedings of Dva dni s didaktikou matematiky [Two days with didactics of mathematics]*. (pp. 90-94). Bratislava, Slovakia.

Computers for all – what happens? The case of Tórshavn

Ingi Heinesen Højsted¹, Erla Olsen¹, Páll Isholm¹ and Laufey Blaasvær¹

¹University of the Faroe Islands, Faculty of Education, Tórshavn, Faroe Islands; ingih@setur.fo; erlao@setur.fo; palli@setur.fo; laufeyb@setur.fo

The paper presents results from a questionnaire investigating the effects of an impromptu implementation of digital hardware in the municipality of Tórshavn. More specifically, we inquire to what extent GeoGebra is used in the mathematics classroom, as well as other software/webpages. The results indicate that GeoGebra is not used extensively, and that the students do not find it particularly helpful. Our study indicates that the digital tools do not play a major role in the mathematics classroom in the municipality of Tórshavn.

Keywords: Digital tools, GeoGebra, Questionnaire.

Context of the study and theoretical background

In 2015, the city council of Tórshavn, which is the capital of the Faroe Islands¹, decided to provide funds for a single school to test a model where every student and every teacher in that school was provided with digital hardware, mainly iPads (Olsen & Ólavstovu, 2016; Smith, 2017). The students would borrow them from the school, but they could take them home and more or less treat them as if they were their own. The provisional outcome of the test was that the students scarcely used the hardware in school, instead the Ipads were widely used for non-school related purposes, and according to the teachers, digital resources were only sporadically used in the teaching and learning context (Olsen & Ólavstovu, 2016). In the following years, many schools in the municipality of Tórshavn have adopted a digital approach, however, with differences. Mainly, the Ipads have been replaced with PC's, in particular, chrome books. Some schools let the students bring the PC home, while others require that it remains in the classroom. A recurring factor is the lack of teachers' professional development in relation to using the hardware, i.e. the teachers did not get guidance in relation to which types of software or webpages might be useful for different educational purposes (Olsen & Ólavstovu, 2016). The lack of professional development may influence the digital practice in many ways, and we can wonder which software/webpages will be used in the mathematics classrooms when such an approach is applied.

One type of software that has received ample attention in mathematics education research on digital technologies is dynamic geometry environments (DGE) (for an overview, see Højsted, 2021), for example in relation to reasoning and conjecturing (e.g. Sinclair & Robutti, 2013). A specific type of DGE, GeoGebra, is quite popular in Nordic countries, not least in Denmark, where it is commonly

¹ The Faroe Islands, which is situated in the north Atlantic Ocean, is a self-governing country within the Kingdom of Denmark. The archipelago accommodates a population of approximately 54.000. The capital of the Faroe Islands, Tórshavn, has a population of roughly 21.000. Over the last decade, an average of 285 students were enrolled in primary school every year in the municipality of Tórshavn (Hagstovan, 2022).

used in primary and lower secondary school (Højsted, 2020). However, no research has yet investigated to what extent GeoGebra is used in Faroese primary and lower secondary school.

Therefore, in this paper, we ask: *what are the effects of the impromptu implementation of digital hardware in primary and lower secondary school mathematics education in the case of the municipality of Tórshavn. In particular, to what extent is GeoGebra and other types of software/webpages used in the mathematics classroom?*

In the next section, we describe methodological considerations in relation to preparing, distributing and analyzing the results of our questionnaire. We then present our results with ensuing analysis, followed finally by a concluding discussion.

Method

A web-based questionnaire was produced using SurveyXact (www.surveymxact.dk). The questionnaire was developed for students in grade 5 (Age 10-11), grade 7 (Age 12-13), and grade 9 (Age 14-15). While there were many questions in the full survey, we present results from 4 multiple-choice questions, which are most relevant in relation to the aim of this paper. Specifically, we consider questions concerning the software/webpages used in the mathematics classroom and focus on GeoGebra results.

In the preparation of the questionnaire, we developed a list of plausible software/webpages that we suspected, and in some cases knew, were used in primary and lower secondary school mathematics education. In addition, we reached out to the schools and communicated with teachers working with these age groups, to inquire about commonly used software/webpages in the mathematics classroom.

In case the students answered that they used a specific software/webpage, a validation was triggered, and sub questions were posed. We present results from sub questions concerning how often they used the software/webpage, and to what extent it was helpful for them to learn mathematics.

The questionnaire was distributed in five of the major schools in the municipality of Tórshavn (N=640, fully completed), covering 71% of the student population in the municipality. To counter the expected problem of low participation response and completion of web-based questionnaires (Fan & Yan, 2010), a research assistant visited every 5th, 7th, and 9th grade classroom in each of these schools, providing the students with a link and helping them complete questionnaire. This approach ensured a very high participation and completion rate (98%).

In our analysis approach, we present frequency tables that can fuel our discussion of types of software/webpages that are used in primary and lower secondary schools in the municipality of Tórshavn.

Results and ensuing analysis

One of the main questions of interest is presented in table 1 below, in which the students could select from a list with 16 types of software/webpages, those that they used in the mathematics classroom. Several software/webpages received less than 5% and are not shown in the results below.

N=640	Which of these do you use in the mathematics classroom?
Emat.dk	64%
Mathematics eBook	48%
Calculator on the PC	27%
Kahoot	22%
GeoGebra	19%
Wiseflow	18%
Other - explain	18%

Table 1. The commonly used software/webpages according to the students.

Notice that the students could choose several answers and in the final option, “other – explain”, they could also type software/webpages that were not on the list. While there were many who choose other and typed other answers, there was not any particular webpage or software that was mentioned frequently enough to warrant being highlighted.

As we can see in table 1, the webpage emat.dk² is the most commonly used on the list.

N=411	How often do you use Emat.dk in the mathematics classroom?
Every day	3%
Every week	18%
Every month	29%
Fewer	39%
Don't know	13%

Table 2. Frequency of usage of Emat.dk.

While Emat.dk is the most commonly used from the list, we see in table 2 (N=411) that it is not used so frequently, mainly once a month or fewer than that. This may indicate that it serves a role as a supplement to other forms of teaching.

A somewhat surprising result of the study is that GeoGebra is not extensively used, with 19% (table 1) reporting that they use it in their mathematics lessons. In table 3, below, we see the frequency of GeoGebra usage in the mathematics classroom, according to these students (N=118).

N=118	How often do you use GeoGebra in the mathematics classroom?
Every day	1%
Every week	2%
Every month	27%
Fewer	60%
Don't know	10%

Table 3. Frequency of GeoGebra usage, according to the students.

² Emat.dk is a Danish website, on which students can solve tasks that correspond to the mathematics curriculum in grades 1-10. The teacher can choose sets of tasks for the students, and she can maintain an overview of the students' progression. The students gain points from solving tasks, therefore, they can compete against other students, also from other schools.

The results indicate that not only is GeoGebra not used by many students, but of those 118 students that report that they use GeoGebra, 60% use it fewer than every month.

When they are asked if GeoGebra is helpful to understand mathematics (table 4) the students also disagree slightly more than they agree - 25% agree or agree completely, while 30% disagree or disagree completely.

N=118	GeoGebra is helpful for me to understand mathematics
Agree completely	3%
Agree	22%
Neither agree nor disagree	33%
Disagree	18%
Disagree completely	12%
Don't know	12%

Table 4. Students' description of to what extent GeoGebra is helpful for understanding mathematics.

Concluding discussion

Returning to our research question, our study indicates that the impromptu implementation of digital hardware, without accompanying professional development for the teachers, has resulted in a mathematics practice where the digital tools do not play a major role. Mostly, a single webpage, Emat.dk, is used in many classrooms, however, not very frequently, along with the mathematics ebook (digital version of previous paper-based book), and the PC calculator. GeoGebra usage is not very widespread in the municipality of Tórshavn, and in the classrooms where it is used, it is not used frequently, and there are indications that many students do not feel that it supports them in learning mathematics. This result calls for more research on the practice with these digital tools. One issue that seems worth investigating, is whether the teachers possess the necessary professional development to effectively implement such tools.

References

- Fan, W., & Yan, Z. (2010). Factors affecting response rates of the web survey: A systematic review. *Computers in Human Behavior*, 26(2), 132-139.
- Hagstovan (2022). *UV02010 Fólkkáskúlin, næmingatal skift á skúla og flokk (2005/2006-2021/2022)*. Hagtalsgrunnur. Hagstovan. https://statbank.hagstova.fo/pxweb/fo/H2/H2_UV_UV02/fs_ntalsk.px/table/tableViewLayout2/
- Højsted, I. H. (2021) *Toward Marvels in Dynamic Geometry Teaching and Learning: Developing guidelines for the design of didactic sequences that exploit potentials of dynamic geometry to foster students' development of mathematical reasoning competency*. [Doctoral dissertation, Aarhus University] AU Library Scholarly Publishing Services. <https://doi.org/10.7146/aul.413>
- Højsted, I. H. (2020). Teachers Reporting on Dynamic Geometry Utilization Related to Reasoning Competency in Danish Lower Secondary School. *Digital Experiences in Mathematics Education* 6, 91–105. <https://doi.org/10.1007/s40751-020-00059-3>

Olsen, E. & Ólavstovu, V. (2016). *Teldlanýstla í fólkaskúlanum – ein eftirmeting*. Námsvísindadeildin, Fróðskaparsetur Føroya

Sinclair, N. & Robutti, O. (2013). Technology and the role of proof: The case of dynamic geometry. In M. Clements, A. Bishop, C. Keitel-Kreidt, J. Kilpatrick, & F. Leung (Eds.), *Third international handbook of mathematics education* (pp. 571–596). New York: Springer.

Smith, S. (2017, February 16). Teldur og Skúlar. *Skúlablaðið*. <http://www.lararafelag.fo/teldur-og-sk%C3%BAlar>

Augmented reality for conceptualizing covariation through connecting virtual and real worlds

Otman Jaber, Sara Bagossi and Osama Swidan

Ben-Gurion University of the Negev, Israel

jaberot@post.bgu.ac.il; bagossi@post.bgu.ac.il; osamas@bgu.ac.il

The Augmented Reality learning environment connects both real-world and virtual representations simultaneously. This contribution investigates how students coordinate conceptual facets belonging to the two worlds when conceptualizing the time-distance relationship of a cube sliding down along an inclined plane.

Keywords: Augmented reality, covariational reasoning, conceptual facets, conceptual understanding, functional thinking.

Introduction

One of the goals of teaching and learning mathematics is to allow students to quantify, interpret, and understand the world. To achieve this goal, curricula worldwide integrate modeling activities to engage students in mathematizing real-world phenomena. Since the mathematical representation and the real world are not explicitly connected, and due to the lack of tools that juxtapose both worlds, the link between the real phenomenon and the mathematical representations is made when both worlds remain separate. Recently, by using dedicated augmented reality (AR) technology, the juxtaposition of the two worlds has become possible.

So far, the assumption is that juxtaposing the two worlds may help students mathematize the real-world phenomena and endow them with meanings (Swidan et al., 2019). In this contribution, we want to shed light on the specific role of AR in how students interpret a real phenomenon. So, this study aims to understand how students use mathematical representations to analyze a real phenomenon and what mathematical knowledge they use for this purpose. To achieve this goal, we used Prediger and Zindel's (2017) model of conceptual facets to understand the transition between the two worlds and the covariational reasoning framework (Thompson & Carlson, 2017) to understand what knowledge students use. Understanding the ways in which students transit from one world to another carries out theoretical and methodological implementation. Theoretically, this study may shed light on the role of AR technology in mathematizing real-world phenomena. Methodologically, we modified Prediger and Zindel's (2017) model to fit the analysis of modeling activities; this modification may allow the use of the model by other researchers to analyze the learning resulting from the transition between the two worlds.

Theoretical framework

Conceptual understanding can be intended as a dense network of pieces of knowledge called conceptual facets (Hiebert & Carpenter, 1992). This network of facets can be built by compacting facets into denser concepts (Aebli, 1981). Prediger and Zindel (2017) propose a model of conceptual facets of understanding functional relationships (Figure 1) in tune with these theoretical ideas. The model is based on a definition of the conceptual understanding of functional relationships as “the ability to adopt different perspectives in different representations and to coordinate them by

addressing the facets” (Prediger & Zindel, 2017, p. 4166). Upwards and downwards movements in the facet model reveal the processes of compacting and unfolding the conceptual facets. The following example outlines the functioning of the model. Thinking of the law of a certain motion of a car, a student claiming that a certain function tells for which time you have a certain distance traversed by the car is identifying correctly which are the ||dependent|| and ||independent variable|| and is unfolding the ||functional dependency|| on the medium level of the facet model. The words between || || are the corresponding facets that will be marked in the analytical model.

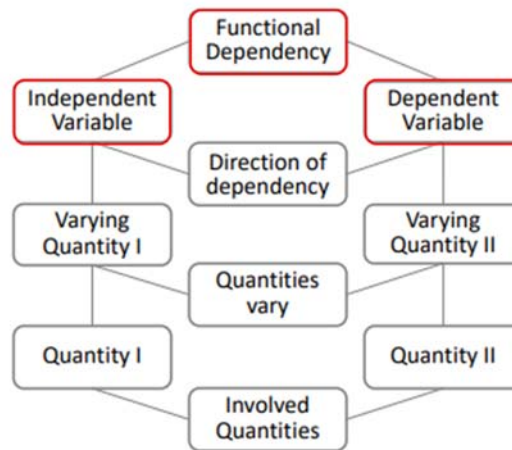

Figure 1: Facet model

Our second theoretical perspective is covariational reasoning, which considers the ability to hold a sustained image, in the mind, of two quantities' values (magnitudes) that change simultaneously (Thompson & Carlson, 2017). The covariation concept is deeply inherent in several dynamic phenomena, such as filling a bottle with water (volume-height) or a rolling ball (time-distance). Arzarello (2019) and Bagossi (2022) further elaborated the idea of covariational reasoning to include what they call “second-order covariation”, which considers covarying between quantities and mathematical objects. For example, considering the changes between a car's velocity (quantity) and the graph of motion (mathematical object) is a form of second-order covariational reasoning.

AR is an innovative technology that combines layers of virtual objects and information about physical objects from the real world, such as texts, images, graphs, etc. This creates an environment in which virtual and real objects coexist (Azuma, 1997). In addition, AR allows uncovering invisible mathematical details embedded in dynamic phenomena and presenting them simultaneously. This suggests opportunities for real-world modeling phenomena, where the covariation concept is inherent and creates meanings through combining both real and virtual worlds.

The research question guiding this study is: How do students coordinate conceptual facets of the real and virtual world representations as they learn covariation in an AR environment?

Method

The learning experiment here analyzed was conducted with a group of three 11th graders, Sagi, Noam, and Alex, from Israel. The experiment explores the time-distance relationship as a cube slides down along an inclined plane, the so-called Galileo experiment. The graph representation, as well as

the table of values with numerical measurements of time and distance (virtual world in the facets model), were layered over the real inclined plane with the sliding cube (real-world in the facets model). The group worked on a corresponding task sheet. Data were collected through video recordings documenting all actions and interactions in the learning environment. Since data provided by AR and observed by the students through their AR headset is not available or seen by the researchers, it was mirrored on a screen to allow us better understand students' observations and explanations (Figure 2).

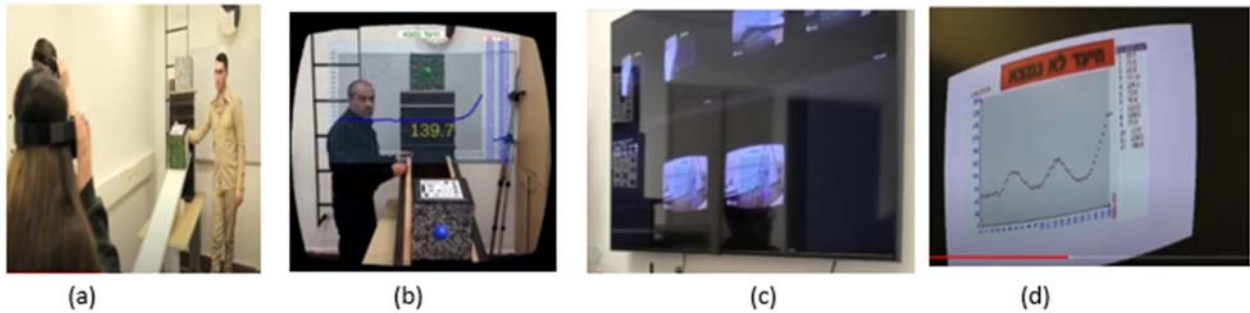

Figure 2: (a) Galileo experiment, (b) Galileo experiment as seen through AR headset, (c) Screen mirroring students' AR headsets, (d) Mirrored data

To analyze the data, we identified episodes revealing forms of covariational reasoning and documenting students while combining both real and virtual worlds. Eventually, we used the Prediger and Zindel (2017) multi-facet model to analyze students' conceptualization of covariational reasoning. The analysis of students' reasoning is visualized by the facet model in Figures 3, 4, and 5. Facets referred to the real-world phenomenon are framed in blue, while the ones referred to the virtual world are framed in red. Connectors denote connections between the two worlds. In the analysis, the addressed facets in the model are remarked by using || ||.

Results

This episode illustrates how Alex connects the real-world phenomenon with the virtual representation.

- 1 Alex: As the height (of the inclined plane) is greater, then the faster the cube speed is, and then it passes the distance in a shorter time than a lower height.
- 2 Sagi: From second to second, the distance simply increases.
- 3 Alex: Yeah, like, it (the cube) takes less time to pass it (distance) because the inclination is... more drastic.
- 4 Sagi: If I'm not wrong, the distance... the difference between the distances from point to point is greater at the top (of the graph), right?
- 5 Alex: Yes, it sounds correct.
- 6 Noam: At a specific time, the cube traveled a certain distance, ... mm... while the plane's inclination... brought to... as if... it (cube) had an acceleration that was growing... dependent on time... which have been created...
- 7 Alex: The acceleration affects the graph that is created...

Alex in [1] shifts from the real world to the virtual one while demonstrating covariational reasoning. His words “as...then...” in [1] suggest that he describes a ||functional dependency|| within the real world. It seems that Alex is aware of the ||independent variable|| (height), and the ||dependent variable|| (speed). He also outlines the ||direction of dependency||: “As the height is greater, then the faster the cube speed is”. After that, Alex focuses on the virtual representations, and similarly, he describes a ||functional dependency|| between time and distance. In the same utterance, he connects them with the height of the inclined plane. This connection suggests that Alex considers the height as a quantity, which varies in the real world: “It (cube) passes the distance in a shorter time compared with a lower height”.

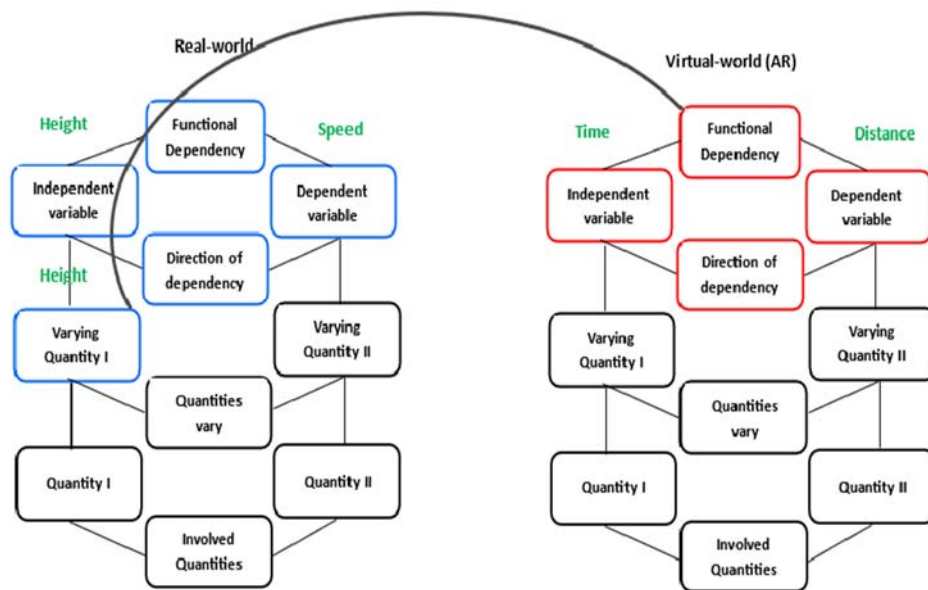

Figure 3: Facet model for utterance [1]

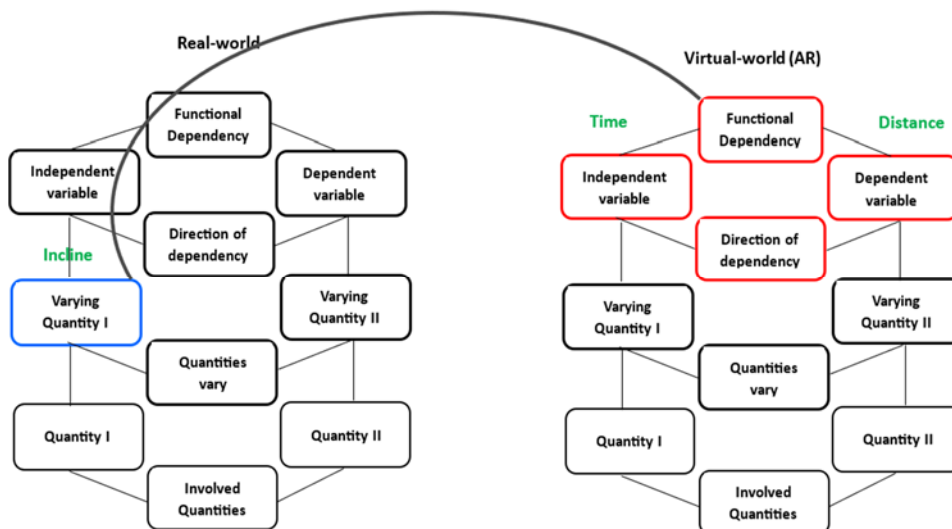

Figure 4: Facet model for utterance [3]

Similarly, in [3], Alex refers to the inclination as a ||varying quantity|| in the real world. Then, he shifts his focus of attention to the virtual world. There he identifies ||independent|| and ||dependent variables||, and describes explicitly the ||functional dependency|| and the ||direction of dependency|| between time (independent variable) and distance (dependent variable) when the cube rolled down “it takes the (cube) less time to pass it (distance) because the inclination is ... more drastic”.

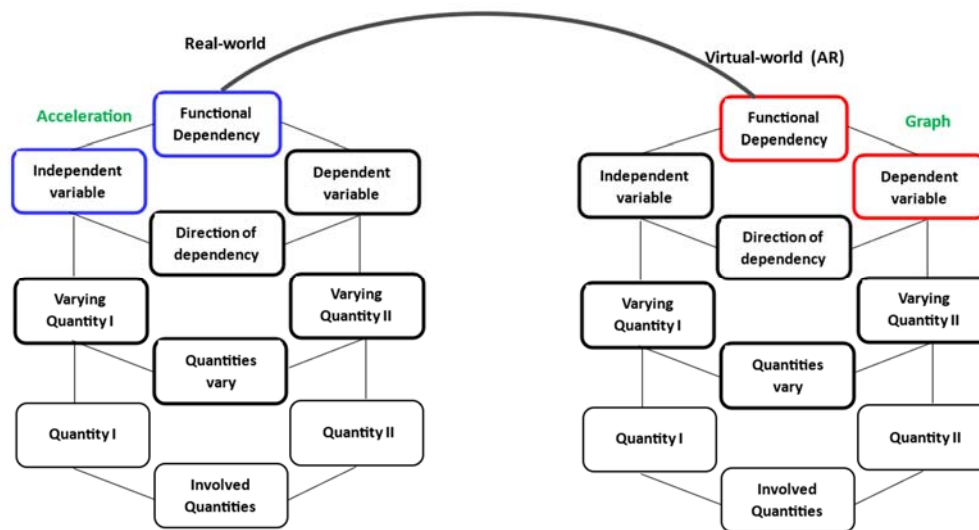

Figure 5: Facet model for utterance [7]

In [7], Alex refers to acceleration as an ||independent variable|| in the real world. Then, he shifts to the virtual world and refers to the graph as a ||dependent variable||: “The acceleration affects the graph that is created”. Alex identifies a ||functional dependency|| between cube acceleration and the graph that represents the real phenomenon. The verb 'affect' used by Alex suggests that he expresses the functional dependency as second-order covariational reasoning between the acceleration and the graph.

Final remarks

As visualized through the facets model, Alex's thinking process indicates the frequent transition between real-world and virtual-world representation facets. He demonstrates the ability to describe functional dependency between dependent and independent variables that he explicitly addresses. In addition, he also refers to the direction of dependency when he describes the relations between the variables. Such description also relates to the changes in the varying quantities of the variables. This path of translations among several conceptual facets and unfolding relationships on lower levels of the facet model are indicators of a developed conceptual understanding. Coordinating conceptual facets of the virtual and real-world representations is attributed to the potential of AR technology which brings both worlds to coexist (Azuma, 1997). Juxtaposing virtual representations with the real-world environment seemingly afford the meanings making of covariation concept in learning processes as conjectured by Swidan et al. (2019). The analysis presented in this contribution aims at being a preliminary attempt to adapt the conceptual facets model to a learning environment offering a coexistence of two worlds, the real and the virtual one. Indeed, instead of addressing the specific

representations involved, we focused on the facets belonging to the two worlds. The use of this model revealed two main issues: first, the difficulty of analyzing rich covariational reasoning involving more than two quantities [1-3]; second, the inadequacy of the model to describe forms of second-order covariational reasoning in which not only quantities are involved but also mathematical objects [7]. Both these issues will be object of our future research.

Acknowledgment

This study was supported by the Israeli Science Foundation (Grant No. 1089/18).

References

- Aebli, H. (1981). *Denken: das Ordnen des Tuns [Thinking: the ordering of doing]*. Band II: Denkprozesse. Stuttgart: Klett.
- Arzarello, F. (2019). La covariación instrumentada: Un fenómeno de mediación semiótica y epistemológica [Instrumented covariation: a phenomenon of semiotic and epistemological mediation]. *Cuadernos de Investigación y Formación en Educación Matemática*. Año 14. Número 18. pp 11–29.
- Azuma, R. T. (1997). A survey of augmented reality. *Presence: Teleoperators and Virtual Environments*, 6(4), 355-385. <https://doi.org/10.1162/pres.1997.6.4.355>
- Bagossi, S. (2022). *Second-order covariation: an analysis of students' reasonings and teacher's interventions when modeling real phenomena*. Ph.D. thesis, University of Modena and Reggio Emilia in agreement with the University of Ferrara and the University of Parma.
- Hiebert, J., & Carpenter, T. P. (1992). *Learning and teaching with understanding*. In D. A. Grouws (Ed.), *Handbook of research on mathematics teaching and learning* (pp. 65–97). New York: Macmillan.
- Prediger, S., & Zindel, C. (2017). School academic language demands for understanding functional relationships: A design research project on the role of language in reading and learning. *Eurasia Journal of Mathematics, Science and Technology Education*, 13(7b), 4157–4188. <https://doi.org/10.12973/eurasia.2017.00804a>
- Swidan, O., Schacht, F., Sabena, C., Fried, M., El-Sana, J., & Arzarello, F. (2019). Engaging Students in Covariational Reasoning within an Augmented Reality Environment. In T. Prodromou (Ed.), *Augmented Reality in Educational Settings* (pp. 147–167). Brill Sense. https://doi.org/10.1163/9789004408845_007
- Thompson, P. W., & Carlson, M. P. (2017). Variation, covariation, and functions: Foundational ways of thinking mathematically. In J. Cai (Ed.), *Compendium for Research in Mathematics Education*, Reston, VA: National Council of Teachers of Mathematics, 421–456.

The potential role of digital tools in students' development of Bildung: An illustrative case of statistical distributions

Stine Gerster Johansen^{1,2} & Uffe Thomas Jankvist²

¹University College Copenhagen, Denmark; stgj@kp.dk

²Danish School of Education, Aarhus University, Copenhagen, Denmark; utj@edu.au.dk

In a context of secondary mathematics teaching, this paper explores the potential role of digital tools, in this case Tinkerplots in the teaching of statistical distributions, in students' development of Allgemeinbildung (Bildung). Relying on the so-called model of 'levels of reflectiveness', adapted to distributions, as an analytical tool, two excerpts of students' work and discussions are analyzed. The analysis shows that the digital tool indeed has a role to play in relation to students' self-reflection (an essential component of the applied model for Bildung). At the same time, the illustrative case, and the analysis of this, also indicates an unfulfilled potential of the 'higher' levels of reflectiveness in the model in relation to an interplay between use of digital tools and development of Bildung, at least in the case of distributions and Tinkerplots.

Keywords: Bildung, statistical reasoning, self-reflection, digital tools, Tinkerplots.

Introduction

Allgemeinbildung, or Bildung, has been an embedded part of the Danish mathematics curriculum for primary, secondary and upper secondary school for several decades. In the Danish context, Bildung addresses the matters of growing up and managing oneself in a society subject to change and varying circumstances. Hence, Bildung in this regard concerns the fact that a democratic society needs enlightened and empowered citizens. The teaching of mathematics, as well as all other school subjects, must thus contribute to students' Bildung (Niss, 2021). During the past two decades, Danish mathematics education in schools has been subject to a heavy introduction of mathematics digital technologies, in curriculum, in textbooks and as part of school examinations (Jankvist et al., 2019). Although the curricula for the different mathematical levels do state that digital tools must be used in support of students' mathematical concept formation, reasoning, etc., research suggests that the digital tools often come to serve pragmatic purposes rather than the intended epistemic ones (Jankvist et al., 2019). As to the potential of having such digital tools support and relate to students' Bildung, it seems fair to say that mathematics teachers are, at best, bewildered.

In this paper, we display an empirical case from a Danish secondary school that nonetheless seem to do exactly this, i.e., illustrate a meaningful interplay between the use of a digital tool, the statistical software Tinkerplots, and students' development of Bildung. We rely on the works of Neubrand (2000) and Prediger (2005), and to some extent also Bauer (1990), in relation to the development of students' Bildung in mathematics education, and in particular Prediger's model of 'levels of reflectiveness' (to be explained in detail later). More precisely, the research question we ask is:

How may the model of 'levels of reflectiveness', adapted to the teaching of statistical distributions, inform the analysis of secondary school students' development of Bildung in a context of working with the digital tool Tinkerplots?

We draw on the available experiences and research results from using statistical digital tools, not least Tinkerplots, in learning and teaching situations related to statistical distributions, which we briefly account for in the following section. Following this comes an introduction to the model of ‘levels of reflectiveness’ and the works from which this originates. In the section of methodology, we provide the model adapted to teaching distributions and briefly account for educational setting and context of the empirical case, which we present next. Finally, we discuss and conclude.

Research on digital tools in students’ work with distribution

The affordances of digital technologies to support students in learning statistics are widely explored. Research shows that it is easier for students to gain access to key statistical concepts, when freed from tedious calculations and drawing of graphs (Ben-Zvi et al., 2018; Biehler et al., 2013). The role of digital technologies in statistics teaching should, according to Chance et al. (2007, pp. 2-3), be “...accessing, analyzing and interpreting large real data sets, automating calculations and processes, generating and modifying appropriate statistical graphics and models, performing simulations to illustrate abstract concepts and exploring ‘what happens if...’ type questions.”

The potentials of digital tools in relation to students’ conceptualization of distribution is explored in relation to Minitool, a set of educational software designed to follow a specific hypothetical learning trajectory (Bakker & Gravemeijer, 2004; Cobb & McClain, 2004). Whereas Minitool is characterized as a route-type, designed to follow a specific learning path, Tinkerplots is characterised as creating a landscape “...in which students and teachers may freely explore data” (Garfield & Ben-Zvi, 2004, p. 402). Ben-Zvi (2004) includes spreadsheets in an empirical study focusing on students’ emergent conception of variability when comparing groups. He identifies a parallel development of a global understanding of distribution. In the *connections project*, Tinkerplots gradually became a thinking tool in the development of students’ statistical reasoning. The tool assisted the students in learning new ways to organize and represent data (Biehler et al., 2013).

The construct of Bildung – when speaking about statistics

The notion Bildung stems from a German tradition. It has some similarities with the one of mathematical literacy, which is well known in the international math education society. For a thorough discussion of the relation between the two notions, see Biehler (2019). As this study is embedded in a Danish educational context where curricular aims build on the German notion and can be connected to the competence orientation in the mathematics curriculum (Niss, 2021), we focus on the term Bildung.

If mathematics teaching should contribute to students’ Bildung, the teaching must provide opportunities for students to reflect on several levels (e.g. Neubrand, 2000; Prediger, 2005). Such reflections can take place in concrete classroom situations as what Neubrand (2000) refers to as “speaking about mathematics” in his exploration of the twofold tension between learning and reflecting. Such opportunities could be established through so-called “didactic construction” in regard to which Neubrand (2000) identified four different levels of “speaking about mathematics”:

1. Level of the mathematician, e.g., mathematical subjects and problems themselves, the correctness of a proof, and logical dependencies.

2. Level of the deliberately working mathematician, e.g., mathematical ways of working with heuristic techniques in problem-solving, mathematical methods such as systematization, classification, abstraction, schemes or techniques of proofs.
3. Level of the philosopher of mathematics, e.g., mathematics as a whole with a critical distance, or the role of its application, proofs as a characteristic issue in mathematics, etc.
4. Level of the epistemologist, e.g., the characteristic distinction between mathematics and other scientific disciplines, including the nature and origin of mathematical knowledge.

Prediger (2005) further developed Neubrand's framework. She formulated "reflectiveness" (both the ability and the disposition) as the core of Bildung. Mathematics teaching must provide access not only to the two first levels, but also to levels three and four (Neubrand, 2000; Prediger, 2005). Prediger combined Neubrand's framework of reflectiveness with Bauer's (1990) four different forms of reflection: comprising content reflection; object reflection; reflection of meaning and sense; and self-reflection, thus obtaining a 4×3 matrix. In her analyses of a teaching unit on exponential growth, she illustrated which kinds of questions might be posed at the different levels. The first two levels (those of the philosophical base and the epistemological level) are rather important in the mathematics classroom in terms of the development of mathematical literacy (Prediger uses this synonym for Bildung). According to Neubrand (2000), teachers should be aware of the reflective potentials of a task and provide both opportunities and stimulation for reflection. And as Prediger (2005) notes, "Once learners start to pose their own questions on the dimensions of self or sense reflection, they can lead to content reflection as well" (p. 254). She explains the lack of self and sense reflection with the image of mathematics as depersonalized.

Methodological aspects of design and setting

In the context of exponential functions, Prediger (2005) exemplifies the cells of her 4×3 matrix of levels of reflectiveness. In table 1, we provide an adaption of her framework to the situation of teaching statistical distributions, which is to serve in our pending analyses of the empirical case.

The case stems from a larger project of the first author related to Bildung and use of digital tools in Danish secondary school mathematics (grade 6, students age 12-13).

Two excerpts from a classroom conversation are displayed and analyzed. Here the students were to investigate differences in the age of their parents (Figure 1), the age of their parents at the time of their first child (Figure 2), and finally compare this to national data of 2020 from Statistics Denmark.

The role of the mathematical software, Tinkerplots, was to assist the students in their exploration of data (Ben-Zvi, 2004), and hopefully also become a "thinking tool" to them (Biehler et al., 2013). More precisely, the hope was that it would support students' concept formation from informal to formal as well as support their statistical reasoning along the way. The students investigated data in pairs with one computer in each group. In the classroom conversations, the students who wanted to share details from their investigations connected their computers to the interactive display beside the blackboard. Other students then compared their own work and commented in a classroom dialogue. At the beginning, the digital tool was unknown to the students. Students' work on the computer as well as classroom conversations were video recorded and analyzed with the seven-step model of Powell et al. (2003) for analyzing students' mathematical ideas and reasoning through video data.

We considered this methodology appropriate for the study, as it comprises an openness to the variety in the articulation of such reflections.

Table 1: Levels of reflectiveness exemplified with distribution

	Object and content reflection	Reflection of sense and meaning	Self-reflection
Level of Mathematical (statistical) content	(1.1) <i>Is the mean the most sensible measure of central tendency for this data, or would the median be better?</i>	(1.2) <i>What are the potentials of viewing data as patterns instead of individual values?</i>	(1.3) <i>Which kind of conclusions can I draw about variation in data? What can distribution tell me about my own experiences of the world around me?</i>
Level of the deliberately working mathematician (statistician)	(2.1) <i>How can distribution be represented (table, histogram, boxplot, etc.) and which terminology is suitable (terms of center, shape and spread)?</i>	(2.2) <i>In which ways can different representations expose different features of the distribution?</i>	(2.3) <i>What is the connection between my conception of distribution and the formal description?</i>
Level of the philosophical base of mathematics (statistics)	(3.1) <i>When and how can I draw conclusions about a larger population with the help from distribution?</i>	(3.2) <i>Which types of questions can be answered by describing data through distribution? And which types cannot?</i>	(3.3) <i>How do I experience the differences between working with statistics and other mathematical subjects in school?</i>
Level of the epistemologist	(4.1) <i>How is statistics connected to mathematics? What are differences and similarities between the two disciplines?</i>	(4.2) <i>What role does statistics play in society? What is the power of statistical arguments?</i>	(4.3) <i>What implications can it have for me, when statisticians (or others) use statistics for societal issues?</i>

An illustrative empirical case

Excerpt 1: Balancing between individual values and shape – the affordances of the tool

The following is an excerpt from the beginning of a lesson. The teacher had initiated a discussion about the work that students had done in the prior lesson. In the lesson, students explored data about their parents' ages using Tinkerplots. The idea was to recapitulate what features the students had found useful as well as any initial conclusions about gender differences in their informal descriptions of the distribution of the data. In the excerpt, Albert had connected his computer to the active board. He was guided by Frida in finding the best way to represent the data. Frida and Emma explained why grouping data as displayed in figure 1 was the best representation.

- Frida: I think we chose ... well, one time sideways
Frida makes a little gesture with her hand from left to right.
 Teacher: One more time? Can you try to do it one more time [addressed to Albert]?
Albert pulls one of the dots one more time to the right.
 Frida: Over, over, over ... there!
 Teacher: That was the one you liked the best?

Frida: Yes.
 Teacher: Do you remember why you thought it was the best one?
 Frida: Well, it was not like too lumpy, so you could not see it properly. But it is not like too spread out, so it is not really... yes.
 Teacher: Because if you chose one of each age, then it would be almost in one line?
Emma raises her hand.
 Teacher: Emma?
 Emma: We thought that one was good as well, because you could sort of ... there in the middle, what is the mean. If you pulled it more out that would not be clear.

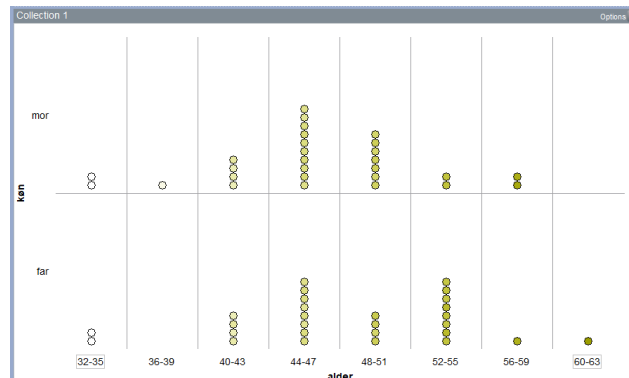

Figure 1: The ages of the parents in our class, Frida and Emma’s favorite representation

The feature of the tool invited the students to test different representations. The teacher asking the students *why* made them reason about what was useful to them in order to view distribution of data as a shape instead of individual values. In addition, Emma’s desire to see the mean in the representation pointed to the usefulness of seeing the variation in data through the lens of distribution.

Excerpt 2: Emma reflects on her own situation compared to the distribution

The next excerpt is from the last part of the session, where the teacher gathered the students to share their experiences and findings in the data. The students expressed considerations about the differences they found in the three data sets, in particular those on their own parents’ ages and their parents’ ages at the birth of their first child. The teacher asked why the two curves were not similar in shape. She was of course referring to only some of the students being firstborn.

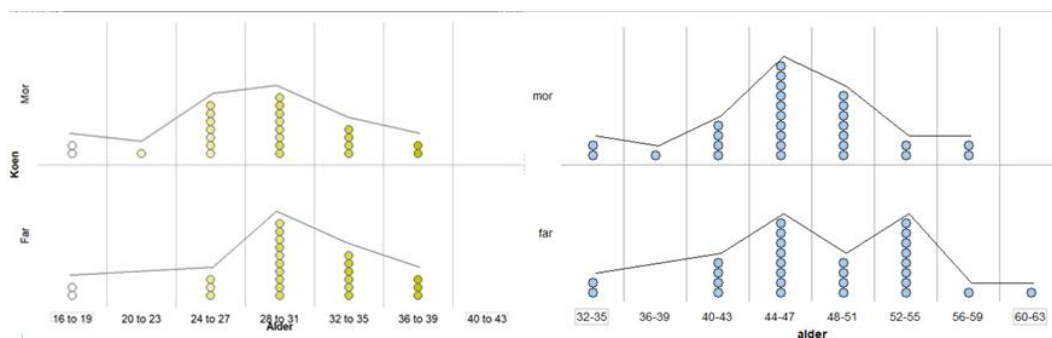

Figure 2: Parents ages at first child (left) and today (right)

Mathew: Well, it might be because one of the parents had an earlier relationship, and then they have a child from before they come into this one.
 Teacher: So it could be, if you are the youngest in the family, then it is clear that your parents would have a different age than at the time of their first child.

Emma raises her hand.

Teacher: Emma?

Emma: That is the case with my dad. He was 26, when he got his first child, but that was with someone called Miranda. That is my two oldest brothers. They are like 36 and 39, so... but when he got me, he was 52.

Teacher: So your dad could be a part of the statistics as young, when he got his first child. But not so young, when he got you?

Emma: Yes.

Here, the two students did not connect to the teacher's idea that the main difference between the two data sets was about the students having different places in the row of siblings. Mathew articulated the idea of some parents having their first child from an earlier relationship as an explanation. Emma was reflecting on her own dad's placement in the two datasets. He represented the 'right-hand tale' in the distribution of their parents' ages (as being old), while he also represented the 'left-hand tale' in the distribution of ages at first child (being young).

Discussion

The first excerpt is an example of students exploiting the affordance of the tool to investigate informal and formal representations. They are reflecting on the content level—cell (1.1) in table 1—e.g., what is a good representation for seeing the central tendency. Yet, they also reflected about distribution as an aggregate, e.g., not too many and not too few details. When the students were asked to give an argument about the “best” representation, it might have invited students to reflect on the level of the deliberately working mathematician (or statistician) as self-reflection (2.3), and potentially also reflection on sense and meaning (2.2). What the students thought was the best representation without any expectation of an exact answer, but instead with an interest in students' reasoning, provided them with an opportunity to reflect upon the question: “*What do I appreciate in order to ‘see’ properly?*” They were impelled to bring themselves in a position where they could see something coherent in their data, hence a deliberately working statistician. The affordance of the tool to let students shift fast and easily between representations invited them to choose the best representation among several. When asked to choose the best representation, this gave rise to reflections on more than one level. The students' personal opinion of the use of the tool also, in this case, gave rise to view distribution as a coherent description of data, hence sense making (2.2).

In the second excerpt, where Emma identified singular data in data set distribution, she was able to connect her own perspective to that gained through investigation of variation of the twofold dataset. This was a way of putting her own situation into the perspective of the lesson learned from looking at the distribution of the data. Surely, this is on the level of self-reflection, as Emma reflected on her own situation in relation to the data distribution. In our interpretation of the excerpt, we lean towards placing this in the level of the deliberately working statistician (2.3). Still, presence of aspects of the level of content (1.3) cannot be ruled out.

The affordance of Tinkerplots is to develop conceptual knowledge of statistical key concepts in parallel with explorations of data. If data is meaningful to students, which is also a principle for good statistical learning environments (Ben-Zvi et al., 2018), then self-reflection becomes an obvious part of the investigation of data. Still, these kinds of reflection must of course happen in an interplay with a development of a more and more sophisticated notions of statistical concepts and processes. In our

illustrative case, the students were novice learners of statistics and they were unfamiliar with the digital tool (Tinkerplots) at the beginning of the teaching unit. Nevertheless, the affordance of the tool gave rise to initial sense making of distribution (content level), and exploited how distribution could be useful (sense and self-reflection) in parallel with the development of more fine-grained ways to describe ‘range’, ‘shape’ and ‘central tendencies’.

Recalling Prediger’s (2005) problematization of the lack of self-reflection in the classroom, it seems safe to say that in our case, where the students investigated data about themselves, the presence of self-reflection was obvious. The affordance of the digital tool invited the students to develop representations, which then could enable them to “see properly”, i.e., a desire to view the distribution of the data as an aggregate. As also pointed out by Prediger (2005), “Once learners start to pose their own questions on the dimensions of self or sense reflection, they can lead to content reflection as well” (p. 245). Even though Prediger’s (2005) own example of self-reflection had a different character and was formulated in a context of exponential functions, the two excerpts above exemplify that conceptual knowledge can indeed take place in an interplay with self-reflection. The reflections on how distribution should be represented in order to make sense to *me*, and how *my own* situation is related to the story that data can tell us by viewing the data through the lens of distribution, are steppingstones to reflections on the content level. This observation is further supported by the ways in which students can investigate data with the tool and make instant shift between representations.

Conclusion

Returning to our research question, it clearly appears that the model for ‘levels of reflectiveness’ is indeed useful when discussing students’ development of Bildung in a context of working with statistical distributions. That digital tools, and not least statistical tools such as Tinkerplots, can aid students in their concept formation and reasoning processes, i.e., in relation to ‘object and content reflection’ and ‘reflection of sense and meaning’ (columns 1 and 2 of table 1) is already well documented in the research literature. A crucial aspect of Bildung, however, is the dimension of ‘self-reflection’ (column 3 in table 1). The analyses of the two excerpts, and in particular the student Emma’s excerpt, suggest that digital tools do have a role to play in this respect too. By means of the visualizations in Tinkerplot (and potentially the shifting between these), Emma was able to interpret some of her own experiences to the world around her through her understanding of distribution, i.e., self-reflection at the level of the deliberately working statistician (2.3). Not only in terms of analysis, but also in terms of design of teaching activities may the model of ‘levels of reflectiveness’ have something to offer to the interplay between use of digital tools and development of Bildung. In particular, we contemplate that also the level of the ‘philosophical base’ and that of the ‘epistemologies’ may benefit from a well thought through use of digital tools such as Tinkerplots, and this not only in relation to self-reflection. This is to say, we see an unfulfilled potential only waiting to be explored.

References

- Bakker, A., & Gravemeijer, K. P. E. (2004). Learning to reason about distribution. In D. Ben-Zvi & J. Garfield (Eds.), *The challenge of developing statistical literacy, reasoning and thinking* (pp. 147-168). Springer. https://doi.org/10.1007/1-4020-2278-6_7
- Bauer, L. (1990). Mathematikunterricht und Reflexion. *Mathematil Lehren*, 38, 6-9.

- Ben-Zvi, D. (2004). Reasoning about variability in comparing distributions. *Statistics Education Research Journal*, 3(2), 42-63.
- Ben-Zvi, D., Gil, E., & Apel, N. (2007). What is hidden beyond the data? Young student reason and argue about some wider universe. In D. Pratt & J. Ainley (Eds.), *Reasoning about informal inferential statistical reasoning: A collection of current research studies. Proceedings of the Fifth International Research Forum on Statistical Reasoning, Thinking, and Literacy (SRTL-5)*. University of Warwick.
- Ben-Zvi, D., Gravemeijer, K., & Ainley, J. (2018). Design of Statistics Learning Environments. In D. Ben-Zvi, K. Makar, & J. Garfield (Eds.), *International Handbook of Research in Statistics Education* (pp. 473-502). Springer International Publishing. <https://doi.org/10.1007/978-3-319-66195-7>
- Biehler, R. (2019). Allgemeinbildung, Mathematical Literacy, and Competence Orientation. In H. N. Jahnke & L. Hefendehl-Hebeker (Eds.), *Traditions in German-Speaking Mathematics Education Research* (pp. 141-170). Springer International Publishing. https://doi.org/10.1007/978-3-030-11069-7_6
- Biehler, R., Ben-Zvi, D., Bakker, A., & Makar, K. (2013). Technology for enhancing statistical reasoning at the school level. In M. A. Clements, A. J. Bishop, C. Keitel, J. Kilpatrick, & F. K. S. Leung (Eds.), *Third International Handbook of Mathematics Education* (pp. 643-689). Springer. https://doi.org/10.1007/978-1-4614-4684-2_21
- Chance, B., Ben-Zvi, D., Garfield, J., & Medina, E. (2007). The Role of Technology in Improving Student Learning of Statistics. *Technology Innovations in Statistics Education*, 1(1), 1-26. <https://doi.org/10.5070/T511000026>
- Cobb, P., & McClain, K. (2004). Principles of Instructional Design for Supporting the Development of Students' Statistical Reasoning. In D. Ben-Zvi & J. Garfield (Eds.), *The Challenge of Developing Statistical Literacy, Reasoning and Thinking* (pp. 375-395). Springer Netherlands. https://doi.org/10.1007/1-4020-2278-6_16
- Garfield, J., & Ben-Zvi, D. (2004). Research on Statistical Literacy, Reasoning, and Thinking: Issues, Challenges, and Implications. In D. Ben-Zvi & J. Garfield (Eds.), *The Challenge of Developing Statistical Literacy, Reasoning and Thinking* (pp. 397-409). Kluwer Academic Publishers.
- Neubrand, M. (2000). Reflecting as a Didactic Construction: Speaking About Mathematics in the Mathematics Classroom. In I. Westbury, S. Hopmann, & K. Riquarts (Eds.), *Teaching as a Reflective Practice* (pp. 251-266). Lawrence Erlbaum Association.
- Niss, M. (2021). Matematisk dannelse i det 21. århundrede. [Mathematical Bildung in the 21st Century] In P. Weng, M. Wahl Andersen, & L. Østerlind (Eds.), *Håndbog om matematik i grundskolen : læring, undervisning og vejledning* (2. ed., pp. 71-85). Dansk Psykologisk Forlag.
- Prediger, S. (2005). Developing reflectiveness in mathematics classroom: An aim to be reached in several ways. *Zentralblatt für Didaktik der Mathematik*, 37(3), 250-257. <https://doi.org/10.1007/s11858-005-0017-1>

Peer and self-assessment to improve mathematics competence in pre-service middle-school teachers

Antoine Julien^{1,†}, Elisabeth Romijn^{1,2,†} and Alexander Schmeding^{1,†}

¹Nord University, Norway; antoine.julien@nord.no, alexander.schmeding@nord.no

²Current address [from Aug. 2022]: NTNU, Norway; elisabeth.romijn@ntnu.no

[†]All authors contributed equally and are listed in alphabetical order

Abstract: We report on an exploratory study in which we used self-assessment and peer assessment in a mathematics class for pre-service middle-school teachers.

Keywords: assessment, mathematics, teacher education, computer aided instruction.

Assessment and feedback are amongst the most effective tools teachers can use to promote students' learning (Hattie, 2008). Assessment, however, can be resource-intensive, especially when it comes to giving written feedback on students' assignments. Hence, peer-assessment can be a tool by which students can achieve better learning without [the university spending] extra resources, as described by Maugesten (2005). Generally, peer assessment and self-assessment can be performed in various manners with different objectives (Topping, 1998). Following Panadero et al. (2016, p. 804), we define self-evaluation as any activity by which students describe or evaluate the qualities of their own learning processes and products. We use Topping's (1998, p. 250) definition of peer assessment as being an arrangement in which students evaluate the work of peers of similar status. Our interest in self- and peer assessment stems from the goal of enhancing both students mathematical and assessment skills without increasing the workload of university staff.

Falchikov and Goldfinch (2000) reviewed peer assessment studies in higher education, though not specifically in mathematics. They highlight the importance of the grading criteria and instructions which are given to the students. See also Li et al. (2019), in which moderate correlation between student-given grades and teacher-given grades is found (in line with our findings); this correlation was however higher when using paper-based rather than computer-assisted assessment. This is interesting as ICT tools are crucial to facilitate and scale our research into teaching practice.

In the present article, we report on an exploratory study in which we used self-assessment and peer assessment in a mathematics class for pre-service middle-school teachers. Although we gathered a variety of data, including self- and peer assessment data on a mathematical task, mathematical confidence score and interviews, only some data is relevant to this paper (see Methodology section). Our study is similar to Zevenbergen (2001) but differs in important details (our students only graded one delivery not several and the scores they awarded were inconsequential for student grades).

Our main goal was to investigate how pre-service teachers assess their own and each other's mathematical work, and how these activities of assessing benefit them. Through collection of assessment data and semi-structured interviews, we aim at answering the following question: How accurately do pre-service teacher's assessment of own and peer's work agree with the educator's assessment?

In planning and executing this peer-assessment experiment, we were crucially assisted by ICT tools: the online learning platform and questionnaires facilitated the distribution of assignments to peers for grading and allowed students to give feedback effectively to each other. This level of automatization enabled peer assessment beyond an experimental setting as a routine teaching practice.

Methodology and research setting

The group from which we collected data consisted of three different classes of pre-service teachers in a Norwegian university. The first two groups were two sections of the same mathematics course, given at two different campuses of the university. These students ($n = 36$) were in their second year of a 5-year integrated master's program of middle-school teacher education. The third group consisted of one class of fourth year students ($n = 11$) participating in the final mathematics course in a five-year integrated high-school teacher education program. All three groups were studying probability and statistics, which allowed for similar assignments.

In each of these classes, the number of participants was rather low (47 student across all three groups), so we cannot, in general, expect our results to be statistically significant. Therefore, all of our findings should be interpreted as a preliminary evaluation. However, see Schönbrodt and Perugini (2013) for an overview of (small) sample size versus stability of correlations.

The aspects of the study's protocol relevant to this paper are described below:

1. Measure students' mathematical confidence through an online questionnaire inspired by Pierce (2007). The score ranges from 1 (low) to 5 (high).
2. Develop a homework assignment with several mathematics exercises. We purposefully included exercises of different nature: from computation-based to very open.
3. Immediately after completing the problems and delivering their work, the students were asked to complete a questionnaire in which they assessed their own performance out of 10 for each task (*self-assessment*).
4. Develop a grading guide. The content of the guide was carefully considered such that it provided a framework without dictating how the grading and feedback should be executed.
5. The participants were randomly assigned a peer's work and asked to give written feedback on each task, as well as give a grade out of 10 for each task using the grading guide (*peer-assessment*).
6. Independently, we graded the students' papers, with the same criteria (*educator evaluation*).
7. We interviewed three students, and transcribed each interview.

The self-assessment in step 3 was performed by the participants without access to the grading guide used in steps 5 and 6. This was done to obtain expectation of performance directly without measuring against an external corrective. Our research design included the following aspects. All scores (self-assessment, peer assessment or educator evaluation) were converted to percentages in the data-analysis. Next, even though we asked the students to give formative assessment to their peers, we will restrict our analysis on the numerical grades. It is also worth noting that in the self-evaluation, students were asked to estimate how well they performed, and not which grade they think they would get, or which grade they would give themselves. How important this request is to the numerical results is unclear and may require further investigation.

Results of empirical research

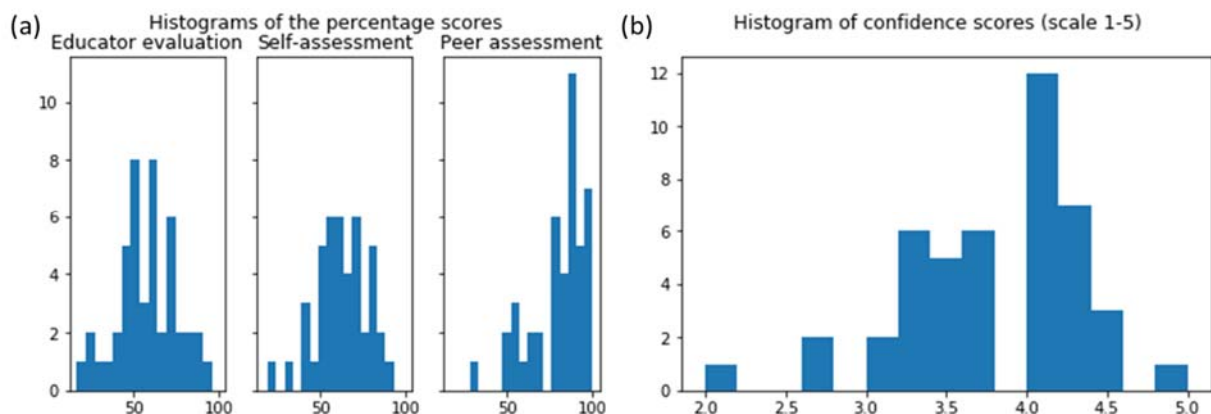

Figure 1: Distribution of students according to assessment scores in percentages (a) and the confidence score calculated based on the self-assessment questionnaire (b).

The full set of participants consisted of 47 students, some of whom did not participate in all activities. Non-answers pertaining to these participants have been removed from the statistics of the items they were not included in. Thus, the data set fluctuates depending on the item, but always contains at least 42 students in every item. The statistical methods used in this section are standard and can be found in introductory statistics texts (e.g., Ross, 2010). Computations were carried out using Python's Pandas and SciPy packages. We evaluated the point scores (in percent) achieved by participants on the assignment in three categories: Educator evaluation (given by the authors), self-assessment (awarded by the students themselves on delivery), peer assessment (awarded by another student). The histogram in Figure 1a shows the percentage scores divided into 7.5% bins each.

The histogram gives a visual indication that the educator evaluation and self-assessment are already (asymptotically) normally distributed. Note that there is a large deviation between the self-assessments and the peer assessment item. On average the students have evaluated each other much more positively (mean = 80.3%) than the educator has evaluated them (mean = 58.8%). This might be a consequence of the process not being anonymized (students knew whom they assessed and by whom they were assessed).

The mean of the self-assessment score of 63.1% is similar to the mean of scores awarded by the educators. Computing the (Pearson) correlation for both items yields a coefficient $r = 0.31$ which is significant on the 5% scale ($p = 0.04$). Interestingly though, the correlation coefficient for educator evaluation vs. peer assessment score (a student received from another) turns out to be $r = 0.34$ with $p = 0.03$. In future work, we will investigate the underlying mechanisms of these findings. Beyond the summative assessment, we collected items tracking the student's confidence in mathematics on a scale from 1 (lowest) to 5 (highest). We called their mean the confidence score (cf. Figure 1b).

In the complete group there is a weak correlation between confidence score and points awarded in self-assessment of the exercise ($r = 0.24$, $p = 0.14$). The result is not significant, which is not surprising considering the size of the group considered (cf. Schönbrodt & Perugini, 2013). However, the confidence score is also weakly correlated to educator evaluation ($r = 0.22$, $p = 0.07$) with a surprisingly low p -value (though it doesn't meet the 0.05 conventional threshold for significance). Therefore, this

lends some credibility to the items evaluated for the confidence score as a useful albeit weak predictor for success in mathematical exercises. We plan to expand the collection of items to make the confidence score more robust and useful as a predictor.

Conclusion and outlook

Preliminary analysis of the interview data suggests that the activity of assessing gave students a deeper understanding of the material, maybe more so than receiving feedback from other students. In future papers, we will explore this point, and investigate the role of the grading aid. We also plan to investigate to which extent the validity of the peer-evaluation can be improved by having the student's grade (and therefore compare) several of their peers' works. Iterating on these findings, we will adapt peer-review practices in future courses via a design-based research process.

References

- Brignell, C., Wicks, T., Tomas, C., & Halls, J. (2019). The impact of peer assessment on mathematics students' understanding of marking criteria and their ability to self-regulate learning. *MSOR Connections*, 18(1). <https://doi.org/10.21100/msor.v18i1.1019>
- Falchikov, N., & Goldfinch, J. (2000). Student Peer Assessment in Higher Education: A Meta-Analysis Comparing Peer and Teacher Marks. *Review of Educational Research*, 70:3,287-322. <https://doi.org/10.3102/00346543070003287>
- Hattie, J. (2008). *Visible learning*. Routledge. <https://doi.org/10.4324/9780203887332>
- Li, H., Xiong, Y., Hunter C.V., Guo, X., & Tywoniw, R. (2019). Does peer assessment promote student learning? A meta-analysis. *Assessment & Evaluation in Higher Education*, 45:2, 193-211. <https://doi.org/10.1080/02602938.2019.1620679>
- Maugesten, M. (2005). Bedre læring av matematikk uten bruk av ekstra ressurser? *Uniped*, 28(2), 28–39.
- Panadero, E., Brown, G. L., & Strijbos, J.-W. (2016). The future of student self-assessment: a review of known unknowns and potential directions. *Educational Psychology Review* 28, 803–830. <https://doi.org/10.1007/s10648-015-9350-2>
- Pierce, R., Stacey, K., & Barkatsas, A. (2007). A scale for monitoring students' attitudes to learning mathematics with technology. *Computers and Education*, 48(2), 285–300. <https://doi.org/10.1016/j.compedu.2005.01.006>
- Ross, S. M. (2010). *Introductory statistics*. (3rd. ed.). Elsevier/Academic Press. <https://doi.org/10.1016/C2009-0-28078-0>
- Schönbrodt, F. D., & Perugini, M. (2013). At what sample size do correlations stabilize? *Journal of Research in Personality*, 47(5), 609–612. <https://doi.org/10.1016/j.jrp.2013.05.009>
- Topping, K. (1998). Peer assessment between students in colleges and universities. *Review of Educational Research*, 68(3), 249–276. <https://doi.org/10.3102/00346543068003249>
- Zevenbergen, R. (2001). Peer assessment of student constructed posters: Assessment alternatives in preservice mathematics education. *Journal of Mathematics Teacher Education*, 4, 95–113. <https://doi.org/10.1023/A:1011401532410>

Views of pre-service teachers in Norway on the value of programming in teaching mathematical and pedagogical topics

Odd Tore Kaufmann¹, Marianne Maugesten¹ and Tamsin Jillian Meaney²

¹ Østfold University College, Faculty of teacher education and language, Norway;

odd.t.kaufmann@hiof.no

¹ Østfold University College, Faculty of teacher education and language, Norway;

marianne.maugesten@hiof.no

² Western Norway University of Applied Sciences, Norway; tamsin.jillian.meaney@hvl.no

The recent addition of programming to mathematics in the Norwegian curriculum indicates that mathematics teachers and future mathematics teachers need ways to teach this new content, based on what they already know. However, research on pre-service teachers experience with programming and their views of integrating programming into mathematics education is scarce. The aim of this research is to address this gap using the responses from a survey of 408 pre-service teachers at three institutions in Norway. The results indicated that students with experience with programming rank the value of problem solving in programming higher than other mathematical and pedagogical topics. At the same time, both experienced and non-experienced students ranked geometry as the least likely to be supported by programming, especially in relation to Scratch.

Keywords: Programming, Pre-service teachers, online survey.

Introduction

The importance of programming as a core competence for the future work force has become increasingly evident, with schools bearing most of the responsibility for helping pupils acquire this competence (Balanskat & Engelhardt, 2015). In recent years Computational Thinking (CT) and its related concepts, such as coding, programming and algorithmic thinking have been promoted as equally fundamental as numeracy and literacy (Bocconi et al., 2016). There is a lack of consensus on the definition of CT, however many researchers (Bocconi et al., 2016) use Wing's (2011) definition, "CT is a thought process and a specific type of problem solving that entails distinct abilities as to design solutions that can be executed by a computer." Given that this definition has influenced the incorporation of CT into the Norwegian curriculum, we use it in our project. As part of CT, programming requires the ability to analyze, understand, and solve problems by verifying algorithmic requirements (Grover & Pea, 2013). Since 2020, programming and CT have been included in the Norwegian mathematics curriculum:

Computational thinking is important in the process of developing strategies and procedures for solving problems. Problem solving in mathematics is about students developing a solution to a problem they do not already know. It is also about analyzing and work with known and unknown problems, solving them and assessing whether the solutions are valid. (Ministry of Education and Research, 2020).

The introduction of CT into school curricula around the world is creating a demand for in-service professional development and redesigned teacher education courses for pre-service teachers (Bocconi

et al., 2016). Yet, implementing effective pedagogical approaches may be challenging when teachers lack knowledge of programming or experience of integrating programming into mathematics education or both (Kaufmann & Stenseth, 2021). The recent addition of programming to curricula indicates that most—if not all—mathematics teachers need to find ways to teach this new content. Furthermore, mathematics teachers and preservice teachers are interested in working with programming but they do not feel prepared for this task (Kaufmann & Maugesten, 2022; Misfeldt et al., 2019) and they do not identify the connection between programming and mathematics (Pörn et al., 2021). Therefore, there is a need to understand how preservice teachers' current views on integrating programming into mathematics education and how they value programming in different mathematical and pedagogical topics. To do this, we wanted to investigate how the pre-service teachers considered the usefulness of programming in different topics, and how they consider the usefulness of a specific programming tool, Scratch. We know, from earlier research, that Scratch is used to some degree in primary school, especially in grades 5-7 (Kaufmann et al., 2018). In this context, the following research question guides this paper: “How do preservice teachers view programming as part of mathematical and pedagogical topics?” We focus on preservice teachers' views about programming generally and Scratch, specifically, their previous experience with programming and the relationship to the teaching of mathematical and pedagogical topics.

Relevant literature

Recently, there has been an increase in research focusing on programming in mathematics education. Studies have found strong connections between teachers' CT in programming and problem-solving processes, through, for example, using debugging and tinkering to explore the structure of an algorithm (Bråting & Kilhamn, 2021; Kaufmann & Stenseth, 2021). There are also a few studies on preservice teachers' views on programming and the teaching of programming within the mathematics curriculum (Pörn et al., 2021).

Although limited research exists examining teachers and programming (Moreno-León et al., 2016), relevant research has been conducted regarding teachers' views on the use of technology that corroborate the following findings: preservice teachers' beliefs play a key role in their pedagogical decisions and affect whether they adopt technology and how technology is integrated into their classroom practices (Tondeur et al., 2016). Pörn et al. (2021) studied Finish primary preservice teachers' views of programming in mathematics and the connections they saw between mathematics and programming. They found that most teachers connected programming in primary school as an activity, which means the explicit activity of writing, giving, or following instructions. Some teachers consider programming as an important subject related to logical thinking and problem solving. Connection to specific mathematical content was scarce, and the examples were only connected to spatial thinking and geometrical shapes. Pörn et al. (2021) concludes that primary school teachers do not fully apprehend the interplay between mathematical and computational content and learning. Similar results were obtained by Misfeldt et al. (2019) who collected data from 133 Swedish teachers, showing that, although teachers were positive toward working with programming in mathematics, everyone could not see the relationship between the two, or the relevance of including it into the subject.

Even though preservice teachers do not identify the connection between programming and mathematics, they might view other potential benefits with programming as pedagogical topics. Kilhamn et al. (2021) interviewed 20 Swedish mathematics teachers who, as early adopters, taught programming in their ordinary mathematics lessons. These teachers were interviewed with the intention of capturing different aspects of their talk about programming in mathematics. The results indicate that the teachers describe programming as useful and engaging on a general level, not necessarily connected to mathematics. Their arguments for using programming in mathematics are that programming increases engagement and it is a powerful tool. Similar results were identified by Kaufmann and Maugesten (2022). In their study, preservice teachers' survey answers were analyzed about programming being placed in the mathematics curriculum and its usefulness for teaching-specific mathematical topics as numbers, algebra and function and geometry, and pedagogical topics as problem solving, multicultural classroom, and differentiated teaching. The results indicated that the respondents held more positive views with regards to using programming in multicultural classrooms and differentiated teaching than mathematical content, such as geometry and numbers as well as algebra and functions. Further, the participants rated the usefulness of programming for geometry significantly lower than other topics. This result was surprisingly as the origins of including programming with mathematics had been related to strengthening students' understanding of geometry (Papert, 1980).

The results presented above indicate that preservice teachers do not identify the connection between programming and mathematics, but view other potential benefits with programming connected to pedagogical topics. They are interested in using programming in mathematics, but do not feel prepared for including programming in mathematics education (Kaufmann & Maugesten, 2022; Misfeldt et al., 2019). The results do not consider if the participants are experienced or non-experienced in programming. There might be that experienced preservice teachers have different views of integrating programming with mathematics because of their experience with programming. Consequently, there is a need to better understand how experienced and non-experienced preservice teachers view and value programming in mathematics education. Therefore, we analyzed the responses to a questionnaire to investigate preservice teachers' experience with programming and how they valued programming and Scratch in relation to their future mathematics teaching.

Methodological approach

The pre-service teachers were enrolled in the following institutions: 408 respondents from the Western Norway University of Applied Science (57% of the respondents), The Arctic University of Norway (16%), and Østfold University College (27%). The three institutions were convenience sampled, with all pre-service students being in their first, second, or third year of teacher education. In terms of gender, 70% of the participants were women, and 30% were men. This gender distribution approximates the study population of pre-service teachers in these three institutions specifically and in Norway generally. Therefore, we consider this sample as representative (a prerequisite for external validity) of the population. The participants in the survey were either enrolled in a master's level program for teachers of Grades 1–7 (208 students) or Grades 5–10 (200 students). There is an overlap between grade 5-7 which was where research suggested that more Norwegian classrooms used

Scratch. Therefore, we believe it is most likely that preservice students would be familiar with Scratch.

Our focus is on four of the questions about programming. Two of these questions are about pre-service teachers' experiences with programming. The first question regarding their experience was, "how often they programmed in their leisure time." The participants had the following alternatives; Never, rarer than once a month, one or twice a month, one or twice a week and more than twice a week. We defined those who answered never and rarer than once a month as non-experienced in programming, while the other preservice teachers (N=12) we defined as experienced. The second question about their experience was the kind of digital tools they had engaged with during their teacher education. The participants could choose between several digital tools, with one category being programming, with examples provided being Scratch, Python and Java. 70 participants answered they had experience with programming during their teacher education. Those two questions were merged into two groups; experienced (N=82; there were no overlapping respondents) and not experienced (N=326) with programming.

The other two questions were about the preservice teachers' views of the usefulness of programming, and the usefulness of Scratch, related to different topics. They were asked to rate the value of programming and Scratch¹ in teaching specific mathematical and pedagogical topics on a five-point scale (1 "completely useless" to 5 "very useful") for five topics: (1) numbers, algebra, and functions; (2) geometry; (3) problem-solving; (4) multicultural classrooms; and (5) differentiated teaching. We consider topic 1 – 3 related to content knowledge, and topic 4 – 5 to pedagogical knowledge in the TPACK model (Mishra & Koehler, 2006).

A nonparametric test of two independent samples, the Mann–Whitney U test, was employed to identify differences between pre-service teachers' experiences with programming and their views on the usefulness of programming and Scratch. We hypothesized that respondents with experience with programming would rank the value of programming and Scratch higher than those who had no experience. We assumed that their experience would contribute to them seeing possible connections between programming/Scratch and mathematics/pedagogy.

Results

In the Mann–Whitney U test, responses were scaled from 1 – 5 (1 "completely useless" to 5 "very useful") that were then used for comparison. Table 1 and 2 present the differences in the mean ranks between the participants categorized as experienced and non-experienced with respect to

¹ When answering the questions about the usefulness Scratch in different topics the respondents could choose the category "I do not know the tool." Of the remaining preservice teachers, 58 with no experience of programming and 45 with experience of programming rated the value of Scratch in different topics. The remaining 305 participants, were excluded from the analysis because they did not know Scratch.

programming. The results indicated no significant difference between the two groups in all the five questions in relation to programming in general and Scratch in particular.

We find the largest difference between the two groups and programming (Table 1) related to the topic problem-solving. In this case those who had experience with programming rated the value of programming in relation to problem-solving higher than those who had no experience. There are also no significant differences in relation to Scratch (Table 2). The largest differences between the experienced and non-experienced was to do with the topics numbers, algebra and functions, multicultural classroom and differentiated teaching. In all these cases those who have experience with programming ranked these topics higher than those who were non-experienced.

Programming: Experience\Mean rank	Numbers, algebra and functions	Geometry	Problem-solving	Multicultural classrooms	Differentiated teaching
Yes (N=82)	96,31	98,28	101,72	97,30	94,86
No (N=326)	97,28	89,37	88,67	89,12	89,40
Asymp. Sig. (2-tailed)	0,911	0,287	0,121	0,328	0,508

Table 1: Mean rank for programming in different topics for experienced versus non-experienced with programming

Scratch: Experience\Mean rank	Numbers, algebra and functions	Geometry	Problem-solving	Multicultural classrooms	Differentiated teaching
Yes (N=45)	56,86	48,09	49,92	51,98	52,19
No (N=58)	48,23	43,34	44,60	43,73	43,55
Asymp. Sig. (2-tailed)	0,132	0,379	0,333	0,127	0,110

Table 2: Mean rank for Scratch in different topics for experienced versus non-experienced with programming

The mean rank helps us to find a statistically difference between the two groups. In the next two tables we report on the mean values which are better for illustrating the mean rank in different topics. In all topics, except numbers, algebra and functions (Table 3), preservice teachers who had experience with programming rated the topics higher than those who had no experience. Both the experienced and non-experienced preservice teachers rated the value of programming in multicultural classroom and differentiated teaching high, much higher than geometry. For experienced pre-service teachers only problem-solving was ranked higher, than multicultural classroom and differentiated teaching. This difference is reinforced in the responses to Scratch (table 4). The results in this table indicate that both experienced and non-experienced preservice teacher students did not rate the value of Scratch much higher for the pedagogical topics, such as multicultural classroom and differentiated teaching, than mathematical topics.

We also conducted a paired sample t-test to find if there were significant differences between how preservice teachers rated the use of Scratch in the different topics. The participants ranked the value

of differentiated teaching (and multicultural classroom) significant higher ($p < .05$) than the other three topics problem solving, geometry and numbers, algebra and functions.

Programming: Experience\Means	Numbers, algebra and functions	Geometry	Problem-solving	Multicultural classrooms	Differentiated teaching
Yes (N=82)	3,25	3,02	3,46	3,26	3,44
No (N=326)	3,28	2,77	3,12	3,05	3,31

Table 3: Mean value for programming in different topics for experienced versus non-experienced with programming

Scratch: Experience\Means	Numbers, algebra and functions	Geometry	Problem-solving	Multicultural classrooms	Differentiated teaching
Yes (N=45)	3,18	3,10	3,21	3,81	4,05
No (N=58)	2,81	2,84	2,92	3,35	3,61

Table 4: Mean value for Scratch in different topics for experienced versus non-experienced with programming

Discussion and conclusion

In Norway, it is expected that everyone who teaches mathematics will also teach programming, since the inclusion of programming in the mathematics subject from 2020. Nevertheless, many teachers and preservice teachers do not have experience with programming or with integrating programming in the mathematics. It is therefore important that teachers have relevant pedagogical, technological and mathematical knowledge (Mishra & Koehler, 2006) to include programming in mathematics. To design appropriate courses to support these preservice teachers, it is important to know about their existing views about programming in different pedagogical and mathematical topics. We expected that preservice teachers would rank problem-solving higher than the other topics because of the strong connection between problem solving and CT in the Norwegian curriculum. Our findings show that this was more likely for those who had experience with programming as they ranked problem solving higher than other topics. This is in alignment with findings from Bråting and Kilhamn (2021). Even though not statistically significant, we found the greatest difference between those who had experience with programming and those who did not in how they rated the value of problem solving, than for the other topics. This indicates that preservice teachers may need experience with programming before they are able to see the connection with problem-solving, even if they are aware that this is explicitly stated in the curriculum.

We also expected that the preservice teachers would rank the pedagogical topics differentiated teaching and multicultural classroom lower than the other mathematical topics because there is no research evidence to suggest that such pedagogical concerns could be supported through the use of programming in mathematics learning. However, our findings show that the preservice teachers ranked the value of the pedagogical topics as the same as (and in some cases a little bit higher) the mathematical topics, regardless of their experience with programming. This is reinforced in relation

to their views on Scratch, which showed a significant higher ranking of the pedagogical topics than the mathematical. This result may be in alignment with other research (Gadanidis et al., 2017; Kaufmann & Maugesten, 2022; Misfeldt et al., 2019), which showed that even though not all preservice teachers understood the relationship between mathematics and programming, or were apprehensive about programming, they were positive about working with programming. We can only speculate on these results, but pre-service teachers may think that students can work at their own pace when they program (differentiated teaching) and that the language (often programming language are in English or you can choose the preferred language) is not a hindrance (multicultural classroom).

As presented in the literature review, the participants emphasize pedagogical domains in describing the advantages of programming in mathematics, but they do not see the connection between programming and mathematical topics (Kilhamn et al., 2021; Misfeldt et al., 2019). In our study the respondents considered the importance of programming in already defined mathematical and pedagogical topics. Despite the Norwegian curriculum emphasize the connection between programming and mathematics (numbers, algebra and functions and geometry), the preservice teachers still rank pedagogical topics higher than the mathematical. Although we assumed preservice teachers with experience of programming would rank mathematical topics higher than pedagogical, this was not the result in our study. These results are in contrast with our beliefs that experience with programming is important (as the teachers in Misfeldt et al.'s (2019) study called for), to identify the connection between programming and mathematics. The reason for this discrepancy could be that in our survey the participant only answered questions about experience with programming at leisure and at school, but we need to know more about what kind of experience the participants have with programming.

Geometry is the topic experienced and non-experienced ranked the lowest, both for programming generally and for Scratch specifically. We find this result rather surprisingly, especial because of the strong link between Scratch and geometry (Gadanidis et al., 2017; Kaufmann et al., 2018). There are many similarities between how to program the avatar in Scratch and Papert's (1980) turtle. We believe one reason could be that those respondents who have experience with Scratch did not necessarily have experience in using Scratch in mathematics. This might also explain the rather high rankings of the pedagogical topics in relation to Scratch. Therefore, further research is, thus, required to explore the connection between mathematics and programming (Kilhamn et al., 2021; Pörn et al., 2021) as teachers need more information on how programming can advance students' understanding of mathematics.

References

- Balanskat, A., & Engelhardt, K. (2015). *Computing Our Future*. Computer Programming and Coding - Priorities, School Curricula and Initiatives across Europe. European Schoolnet.
- Bocconi, S., Chiocciariello, A., Dettori, G., Ferrari, A., & Engelhardt, K. (2016). *Developing computational thinking in compulsory education – Implications for policy and practice*; EUR 28295 EN; doi:10.2791/792158
- Bråting, K., & Kilhamn, C. (2021). Exploring the intersection of algebraic and computational thinking. *Mathematical Thinking and Learning*, 23(2), 170–185.

- Gadanidis, G., Cendros, R., Floyd, L., & Namukasa, I. (2017). Computational thinking in mathematics teacher education. *Contemporary Issues in Technology and Teacher Education*, 17(4), 458-477.
- Grover, S., & Pea, R. (2013). Computational thinking in K-12: a review of the state of the field. *Educational Research*, 42(1), 38–43.
- Kaufmann, O. T., & Stenseth, B. (2021). Programming in mathematics education. *International Journal of Mathematical Education in Science and Technology*, 52(7), 1029–1048.
- Kaufmann, O. T., & Maugesten, M. (2022). In press.
- Kaufmann, O. T., Stenseth, B., & Holone, H. (2018). Programming in mathematics education. In *Norstein, Anne & Haara, Frode Olav (Eds.), Mathematics education in a digital world*. Cappelen Damm Akademisk.
- Kilhamn, C., Bråting, K., & Rolandsson, L. (2021). Teachers' arguments for including programming in mathematics education. In G. A. Nortvedt, N. F. Buchholtz, J. Fauskanger, F. Hreinsdóttir, M. Hähkiöniemi, B. E. Jessen, ..., A. Werneberg (Eds.), *Bringing Nordic Mathematics Education into the Future*. Proceedings of Norma 20 The ninth Nordic Conference on Mathematics Education, 169–176.
- Misfeldt, M., Szabo, A., & Helenius, O. (2019). Surveying teachers' conception of programming as a mathematical topic following the implementation of a new mathematics curriculum. In U. Jankvist, M. Van den Heuvel-Panhuizen, & M. Veldhuis, M. (Eds.). *Proceedings of CERME11* (pp. 2713–2720). Utrecht: Freudenthal Institute, Utrecht University and ERME.
- Ministry of Education and Research (2020). Mathematics subject curriculum. Retrieved from <https://www.udir.no/lk20/mat01-05>
- Mishra, P., & Koehler, M. J. (2006). Technological pedagogical content knowledge: A framework for teacher knowledge. *Teachers College Record*, 108(6), 1017-1054.
- Moreno-León, J., Robles, G., & Román-González, M. (2016). Code to learn: Where does it belong in the K-12 curriculum? *Journal of Information Technology Education: Research*, 15, 283–303
- Papert, S. (1980). *Mindstorms: Children, computers, and powerful ideas*. Badic Books.
- Pörn, R., Hemmi, K., & Kallio-Kujala, P. (2021). Programming is a new way of thinking. Teacher views on programming as a part of the new mathematics curriculum in Finland. I Y. Liljekvist, L. Björklund Boistrup, J. Häggström, L. Mattsson, O. Olande, H. Palmér (Red.), *Sustainable Mathematics Education in a Digitalized World*. Proceedings of MADIF12. SMDF.
- Tondeur, J., Van Braak, J., Ertmer, P. A., & Ottenbreit-Leftwich, A. (2016). Understanding the relationship between teachers' pedagogical beliefs and technology use in education: a systematic review of qualitative evidence. *Educational Technology Research and Development*, 65(3), 555-575.
- Wing, J. (2011). Research notebook: Computational thinking—What and why. *The link magazine*, 6, 20-23.

Potential and challenges of SMART as an online diagnostic tool in comparison to diagnostic interviews using the example of understanding variables

Katrin Klingbeil, Fabian Rösken, Bärbel Barzel and Florian Schacht

University of Duisburg-Essen, Germany; katrin.klingbeil@uni-due.de

The SMART system (“Specific Mathematics Assessments that Reveal Thinking”) is an efficient diagnostic online tool that analyses response patterns to elicit students’ (mis)conceptions. To examine whether its multiple choice and multiple true-false items (translated into German) adequately capture the understanding of algebraic letters of German students, a comparison to open-ended questions and diagnostic interviews was performed. In general, the concordance between SMART test results and students’ explanations was high and only a few deviations were observed.

Keywords: formative assessment, online diagnostic, student thinking, understanding variables.

Introduction

Technology can support teachers in the time-consuming task of conducting formative assessment. But to reliably reveal students’ thinking, instead of only checking the correctness of responses, online tests need to be designed in precise ways. To achieve this, the development of SMART tests is based on research including an analysis of student response patterns. Currently, SMART tests are being adapted and implemented for use in German-speaking countries by the DZLM (German Centre for Mathematics Teacher Education). Our accompanying research project SMART[alpha] examines the effects of using SMART tests on different levels, exemplarily on the topic of understanding variables. We are investigating how and the extent to which teachers’ competencies, as well as students’ understandings, develop through the use of SMART, depending on whether teachers participate in an additional professionalisation programme. Since automatic diagnosis is at the core of the SMART system, the underlying test items and the evaluation logic are examined more closely in advance of the main study. In this paper, we focus on the research question whether the translated multiple-choice and multiple true-false items are able to adequately reveal (mis)conceptions of algebraic letters of German secondary school students.

Theoretical Background

Formative assessment can be described as “all those activities undertaken by teachers, and or by their students, which provide information to be used as feedback to modify the teaching and learning activities in which they are engaged” (Black & Wiliam, 1998, pp. 7–8). Important core elements of formative assessment include gathering evidence of students’ understandings, e.g. through appropriate tasks, and adapting instruction based on the diagnostic information gathered (Black & Wiliam, 1998). In this context, it is important that learners’ diagnoses do not stop at a superficial level such as assessing only the correctness of an answer. Rather, diagnoses should focus on conceptual understanding of the content and possible misconceptions. Such an in-depth diagnosis is the basis for teachers to plan the next learning steps – individually, in groups, or for the whole class. However, without technical support, understanding-based formative assessment is often difficult to realise as individual

diagnosis is time-consuming and identifying patterns in students' responses is often complicated (Stacey et al., 2018).

When devising an online tool for formative assessment, various aspects need to be considered. For this report, we focus on the **item format**, as appropriate tasks are crucial for eliciting students' thinking. When deciding between open-ended (OE) and multiple-choice (MC) formats, different affordances and limitations need to be considered. Since OE tasks do not restrict students' responses, they "have the potential to fully reveal student understandings" (Hubbard et al., 2017, p. 2). However, students may omit areas for which they are not confident. Furthermore, student answers depend on their writing skills and on how they interpret the task, which can lead to unclear or ambiguous responses. Therefore, despite their potential, OE items may provide insufficient information on student thinking (Hubbard et al. 2017). Choosing from given MC options can, on the one hand, support a correct understanding of the task and avoid unclear responses. On the other hand, this can lead to working backwards (which may alter the difficulty or addressed competency of the item) or random guessing (Bridgeman, 1992). Furthermore, selection of one response option does not allow for any inferences about the student's opinion on the other options. Here, multiple true-false (MTF) items can be an expedient alternative as they require an active decision for each response option (Hubbard et al. 2017). Although the reasoning behind the choices made cannot be assessed, items can be designed in a way to reveal students' thinking by analysing response patterns since "in contrast to careless errors, misconceptions [...] lead to predictable errors in student work" (Akhtar & Steinle, 2013, p. 36). However, rationally uninterpretable error types may occur when carefully chosen distractors make the task more difficult (Birenbaum & Tatsuoka, 1987). With regards to digital assessment tools, the possibilities of inputting solutions (e.g. symbols) with a keyboard and of automatically analysing responses also need to be taken into account when choosing item formats (Stacey & Wiliam, 2012).

Algebra is a field in which an online tool for formative assessment of students' understanding might be helpful as there still exists a lack of basic competencies to handle variables, algebraic expressions, and equations in a proper way (Arcavi et al., 2017). In our research, we focus on the understanding of algebraic letters. According to Küchemann (1981), students can hold six different interpretations of algebraic letters: *Letter evaluated*, *Letter not used*, *Letter used as an Object*, *Letter used as a Specific Unknown*, *Letter used as a Generalised Number*, and *Letter used as a Variable*. Steinle et al. (2009) report not only non-numerical thinking (e.g. *Letter as Object (LO)* or *Letter ignored/not used*) but also incorrect numerical ways of thinking. In this case, students replace letters by numbers but have an incorrect idea about what values the letters can take: They think that the value of a letter is in some way related to its position in the alphabet, or they interpret algebraic letters as a mere placeholder for a number in a number sentence, so they allow one letter to have several values in one expression (*Empty box*), or they believe that different letters must stand for different numbers (*Different Letter means Different Number*).

SMART tests

SMART tests have been in development at the University of Melbourne, Australia, since 2008. Most SMART tests focus on the conceptual understanding of key fundamentals from years 5 to 9 and can be completed online within 10–15 minutes (Price et al., 2013). According to the framework suggested

by Fahlgren et al. (2021), SMART can be described as *formative assessment through* technology that is following a rather *migratory* approach. While Fahlgren et al. (2021) distinguish between sending and displaying, processing and analysing, and providing interactive feedback as the functionalities of technology (of which only the first two are addressed by the SMART system), Aldon et al. (in press) propose a modified framework that distinguishes between communicating, analysing and adapting. In terms of communication, SMART enables easy provision and processing of diagnostic tasks. Since students also interact with the SMART system through inputs, according to Aldon et al. (in press), SMART would be categorised as assessment *through* and *with* technology. Much more important, however, is the analysis: SMART offers an *extended analysis* that automatically analyses patterns between individual diagnostic items (Steinle et al., 2009) and thus allows insights into students' understanding by flagging levels of understanding and misconceptions of individual students. In addition, explanations, tasks, and teaching suggestions for the individual misconceptions and levels of understanding are provided to support teachers in planning targeted interventions. Since it is the teacher who makes these decisions, SMART offers a *passive adaptation* according to Aldon et al. (in press). However, Fahlgren et al. (2021) restrict adaptivity to an automatic adaptation by the technology itself and therefore classify SMART as a *non-adaptive* system with feedback provided to *teachers* (*receiver*) on an *intermediate level* between micro and macro as "it is based on a number of items, although in a special (small) domain" (2021, p. 78).

For our research project, we focus on two SMART tests about understanding variables. The first test *Values for Letters* is based on results by Fujii (2003) about students' understanding of the conventions for the values that pronumerals may take, e.g. that in one algebraic expression, a letter must stand for only one number and that different letters can stand for the same number. Steinle et al. (2009) as well as Akhtar and Steinle (2013) modified Fujii's test items and examined the frequency and the underlying misconceptions of students' response patterns. Based on the analysis of the responses to 18 short items, students are classified as showing understanding at one of five stages; in addition, several misconceptions are reported if they occur (see Table 1 for a shortened description).

Table 1: Test *Values for Letters* – Stages of understanding and misconceptions

Stages	Stage 0	GE or A0	Stage 3	<i>Different Letter means Different Number (+R)</i>
	Stage 1	A1 or non-systematic errors	Stage 4	In one algebra question, a letter must stand for only one number and different letters can stand for the same number. (+R)
	Stage 2	<i>Empty box</i>		
Misconceptions	GE	Instead of correctly substituting numerical values into an algebraic equation, students combine the given elements of pronumerals and values in some way		
	A0	Students strongly associate algebraic letters with their position in the alphabet, using letters and their position numbers interchangeably.		
	A1	Some of these students give a letter a value related to its place in the alphabet, such as $b = 2$. Other students believe that the values of consecutive letters must be consecutive numbers, or that if one letter is before another in the alphabet, its value must be smaller.		
	R	When the same letter is used more than once in an equation, these students recognise that it has the same value, but state this value separately for each occurrence.		

The second test *Meaning of Letters* was developed based on Küchemann's work (1981) adapting his "pencil" item (Akhtar & Steinle, 2017). Collaborative discussions between the Australian and our research team have resulted in an extended version of this test, containing three additional items, two

of them being similar to the “Students and Professor” problem (Rosnick, 1981). This test assesses whether students know that letters, when used in algebra, stand for numbers. Many students interpret and use algebraic letters as abbreviations for words or to stand for things and they think that algebra is mainly just mathematical shorthand (*LO*). Three stages and a more sophisticated way in which students can exhibit the *LO* misconception are reported (see Table 2 for a shortened description).

Table 2: Test *Meaning of Letters* – Stages of understanding and misconception

Stages	Stage 0	<i>LO</i> misconception in most items, rarely interpreting algebraic letters as standing for numbers
	Stage 1	Sometimes algebraic letters correctly interpreted as standing for numbers and sometimes <i>LO</i>
	Stage 2	Algebraic letters consistently interpreted correctly as standing for numbers, rather than as objects.
Misconc.	SAC	Solution as coefficient – Because they interpret algebraic letters as standing for objects, these students believe that they need to find a solution to a problem situation <i>before</i> they can describe it with an equation. Instead of writing or choosing an equation that describes the relationship between numbers in a word problem, these students prefer an equation which explicitly shows a solution.

The latest English version of the test items and full descriptions can be retrieved via smartvic.com.

Methods

Our aim was to examine whether the translated SMART test items (MC and MTF) of the two tests *Values for Letters* and *Meaning of Letters* adequately capture the (mis)conceptions of German students. Translating the items into German, we had to adjust a few of the contexts, e.g. doughnuts became “Enten” (ducks) because an object starting with the same letter as our currency (euro instead of dollars) was required for this task. Moreover, we changed some of the completion stems into question stems as the German wording seemed rather complicated and not so familiar to students. This should not have an impact on the diagnosis though, as research shows no difference in discrimination between those two item formats (Haladyna et al., 2002). We then asked a class of 8th-grade students to fill in the two SMART tests online. Based on the automatic diagnosis, we chose individual students for the interviews to cover as wide a range of stages of understanding and misconceptions as possible. However, these choices were limited by the lack of consent forms and absences due to the illness of some of the students on the day of the interviews. Hence, we eventually conducted interviews with six students on the *Values for Letters* test and with five students on the *Meaning of Letters* test. During the semi-structured interviews one week after the online test, students were presented with a pen-and-paper test (PP) of the parallel version of the two SMART tests which had been modified slightly in terms of item format: In order to examine the possible effects of MC/MTF items providing corrective feedback or provoking non-prominent misconceptions, some of the items were changed into OE tasks. To compare these modified PP tests to the online tests, response patterns were analysed following the same decision rules as the automatic online analysis.

Three of the 11 interviews have been analysed in more detail to date, i.e. in addition to the comparison of SMART diagnoses for the online test and the modified PP version, students’ interview responses have been analysed qualitatively with regards to their conceptual understanding and misconceptions as well as to effects of item formats.

First results

For the first test *Values for Letters*, we can report an absolute concordance between the diagnosis of

the online SMART test and of the modified PP version from the interview settings for all six students. Moreover, in the interview of Student 1, the same misconception is evident in his explanations during the interview as diagnosed in the online test (Stage 2). After giving the correct solution 5 as a value for a in the equation $a + a + a = 15$, he finds another possibility:

Student 1: Yes, one possibility would be a is 7 for example. And then a is 5 and a is 3; so each a has different numbers, but that would still give 15.

This reveals that Student 1 interprets an algebraic letter rather as a mere placeholder (*Empty box*). It needs to be mentioned though, that the student only gave this answer after being asked if there was another possible solution. In the following MTF task however, he immediately accepted comparable statements (e.g. $a = 7, a = 7, a = 1$) as correct. Furthermore, he showed the R misconception which is further evidence for Stage 2 understanding. (Note that misconception R is only reported for Stages 3 and 4 by the SMART system since for Stage 2, misconception R is a direct consequence of the placeholder-misinterpretation which needs to be addressed first; that means this is no deviation from the SMART diagnosis.)

In contrast to the SMART diagnosis which revealed no problems with substituting into very easy expressions, Student 1 showed some irritation when answering the second task (MC). For the question “ $a = 1$ and $g = 7$. What is $a + g$?”, he correctly chose 8 as a response, but also $1a + 7g$. It is possible that the task asking to tick *all* possible answers and the presentation of responses in two columns tempted him to choose another, wrong answer from the second column. However, after justifying his choice of the correct response, he instantly corrected himself and explained exactly why this second choice had been wrong. Thus, his explanation confirmed the absence of the GE misconception as diagnosed by the online test.

Overall, for the *Values for Letters* test, it was observed that OE tasks did not always suffice for identifying a certain misconception. For example, it was not possible to rule out misconception $A1$ when only the solution $d = 4$ and $e = 5$ was given to the question of which values d and e could take to make $d + e = 9$ true. Subsequent MTF tasks proved to be more revealing as they ask students to also judge solutions that do not comply with the $A1$ misconception.

For the second test *Meaning of Letters*, concordance between the diagnosis of the online SMART test and of the modified PP version was also high for the five students, but not perfect. In one case, the difference only lies in the frequency of the LO misconception shown in items accounting for the higher stage (Stage 1 online compared to Stage 0 PP). However, this does not change the diagnosis of the misconception being present. In the other case, the modified PP test was not only diagnosed at Stage 1 instead of Stage 0 online, but it also did not reveal any signs of the SAC misconception as opposed to the online test. The corresponding interview with Student 2 provides no clear evidence for SAC either but shows a strong prevalence of an interpretation of letters as objects in her explanations despite giving correct answers. Interestingly, she does not only choose the correct MC response options but is also able to formulate the correct equation for a given context herself. However, her explanations give the strong impression that she simply combines given numbers and letters in the correct way without understanding their meaning:

Student 2: Um, it says that an apple costs 2 euros. And a stands for apple and therefore $2a$, so 2.

Interviewer: Why 2?
Student 2: Because an apple costs 2 euros. And $3k$ because a kiwi costs 3 euros and k stands for kiwi.

In addition to using a as an abbreviation for apple instead of standing for the number of apples (LO), she does not consider the operation linking the number and the letter at all. Moreover, our interpretation that she is combining numbers and letters without complete understanding is affirmed by further explanations in the course of the interview as well as by the first SMART test that diagnosed her at Stage 0 because she was combining given elements instead of substituting correctly (GE).

With regards to the ignored operation, a related observation was made in the explanations of Student 3 who was asked for the meaning of the letter e in a context-related equation (MC task):

Student 3: So, when we write in detail, we write with a multiplication sign. But $5e$? (10 sec)
Interviewer: What are you thinking about?
Student 3: I don't know, because 5 times e ?
Interviewer: What bothers you about it?
Student 3: Somehow, I forgot that you can also add a multiplication sign because somehow that confuses me now. Umm.
Interviewer: Why? Because it's strange with the muffin then? Or what is strange about it?
Student 3: Because of the e . You can also just write 5 equals 10. But then you can only write 5 muffins equal 10 euros.

This shows that an omitted multiplication sign in a given equation might make it easier for students to choose an LO interpretation as “muffins”. However, being reminded of the convention of the omitted multiplication sign, Student 3 is not able to make sense of the equation at all as her interpretation of the letter as an abbreviation for an object is very persistent. Furthermore, her last statement in the transcript excerpt shows that she has no comprehensive understanding of equations, which is an additional hurdle to overcome an LO interpretation.

In general, Student 3 shows a strong urge to find solutions for given equations rather than thinking about the meaning of the algebraic letters used. For example, the OE version of the first item was asking for the meaning of the letter t in a given equation; this prompted her to give a value for t instead of a context-related meaning. Only when provided with the MC options, she chose “tons” as her response. After being asked for an explanation, she quickly changed her mind to “tractors” though. This suggests that here, on the one hand, MC options can be helpful to make the task's aim clearer, on the other hand, they may tempt students to make a quick, unfounded decision.

Student 3's desire to find a solution becomes also visible when finding an equation. She uses the values she has found, presumably by guessing and checking, as coefficients for her equation respectively checks if the coefficients of a given equation are a possible solution for the described situation. This is not only the case in MC items as was expected from the online test, but also in the OE task, she starts figuring out a solution first.

Discussion and Outlook

For the first test *Values for Letters*, we observed a very high concordance between SMART diagnosis and misconceptions visible in the interview. (Of course, the other five interviews still need to be analysed in more detail, but the diagnoses of the modified PP items already indicate no major deviations.) This suggests that the translated SMART items are suitable for assessing the understanding of

German students. The advantages – or even more the necessity – of MTF items in addressing certain misconceptions (e.g. *AI*) became apparent and thus reaffirm the future use of this item format.

The interviews regarding the second test *Meaning of letters* revealed various challenges that need to be considered. First, we saw that it is possible for students to choose and formulate correct equations despite interpreting algebraic letters as abbreviations for objects. As the test also includes two items explicitly asking for the meaning of the letter, chances nevertheless are high that the automatic SMART diagnosis would only deviate by only one stage and would still flag the *LO* misconception. For the use in the classroom, this is not a severe problem since SMART tests are only intended for formative use. They provide a quick ‘snapshot’ of the student’s current understanding to support the planning of the next learning steps. Additional, more time-consuming forms of diagnosis, e.g. diagnostic interviews, are generally recommended and able to provide a more detailed insight. Second, there were indications of guessing in MC items. This is problematic since *LO* errors are easy to make (not only for novices) but can be overcome by checking for them. MC items, however, can tempt students to make a quick decision without further thinking. To prevent this, we are planning to add two OE questions asking for an explanation of why the selected equation was chosen. (For now, these items cannot be automatically analysed by the SMART system, but only be used for research.) We hope that these items will also provide an even more detailed insight into the students’ conception of variables and enable us to check the accuracy of the automatic diagnosis on a large scale during our main study. Third, we are currently discussing if the multiplication sign should be used at least in some of the given equations in order to avoid irritations due to the invisible multiplication sign. On the one hand, this might support students in ruling out *LO* responses, but on the other hand, this could also be even more confusing (as seen in the interview with Student 3). Maybe the analysis of the remaining interviews will provide guidance in this matter.

Overall, the analysis of student interviews has shown that the SMART diagnosis based on MC/MTF items quite reliably reveals German students’ misunderstandings of algebraic letters, and thus, provides teachers with helpful information about individual students without having to invest a vast amount of time for diagnostic interviews with each student.

References

- Akhtar, Z., & Steinle, V. (2013). Probing students’ numerical misconceptions in school algebra. In V. Steinle, L. Ball & C. Bordini (Eds.), *Mathematics education: Yesterday, today and tomorrow – Proceedings of the 36th annual conference of the Mathematics Education Research Group of Australasia* (pp. 36–43). MERGA.
- Akhtar, Z., & Steinle, V. (2017). The prevalence of the ‘letter as object’ misconception in junior secondary students. In A. Downton, S. Livy & J. Hall (Eds.), *40 years on: We are still learning! – Proceedings of the 40th annual conference of the Mathematics Education Research Group of Australasia* (pp. 77–84). MERGA.
- Aldon, G., Barzel, B., Cusi, A., & Olsher, S. (in press). Rethinking teachers’ formative assessment practices within technology-enhanced classrooms. In B. Pepin, G. Gueudet, & J. Choppin (Eds.), *Handbook of digital resources in mathematics education*. Springer.

- Arcavi, A., Drijvers, P., & Stacey, K. (2017). *The learning and teaching of algebra: Ideas, insights, and activities*. Routledge.
- Black, P., & Wiliam, D. (1998). Assessment and classroom learning. *Assessment in Education*, 5(1), 7–74. <https://doi.org/10.1080/0969595980050102>
- Bridgeman, B. (1992). A comparison of quantitative questions in open-ended and multiple-choice formats. *Journal of Educational Measurement*, 29(3), 253–271. <https://doi.org/bqmsvg>
- Fahlgren, M., Brunström, M., Dilling, F., Kristinsdóttir, B., Pinkernell, G., & Weigand, H. G. (2021). Technology-rich assessment in mathematics. In *Mathematics Education in the Digital Age* (pp. 69–83). Routledge.
- Fujii, T. (2003). Probing students understanding of variables through cognitive conflict: Is the concept of a variable so difficult for students to understand? In N. A. Pateman, B. J. Dougherty, & J. T. Zilliox (Eds.), *Proceedings of the 27th PME International Conference, Vol. 1* (pp. 47–66). PME.
- Haladyna, T. M., Downing, S. M., & Rodriguez, M. C. (2002). A review of multiple-choice item-writing guidelines for classroom assessment. *Applied Measurement in Education*, 15(3), 309–333. https://doi.org/10.1207/S15324818AME1503_5
- Hubbard, J. K., Potts, M. A., & Couch, B. A. (2017). How question types reveal student thinking: An experimental comparison of multiple-true-false and free-response formats. *CBE—Life Sciences Education*, 16(2), ar26. <https://doi.org/10.1187/cbe.16-12-0339>
- Küchemann, D. (1981). Algebra. In K. M. Hart, M. L. Brown, D. E. Küchemann, D. Kerslake, G. Ruddock, & M. McCartney (Eds.), *Children's Understanding of Mathematics: 11–16* (pp. 102–119). John Murray.
- Price, B., Stacey, K., Steinle, V., & Gvozdenko, E. (2013). SMART online assessments for teaching mathematics. *Mathematics Teaching*, 235(4), 10–15.
- Rosnick, P. (1981). Some misconceptions concerning the concept of variable. *The Mathematics Teacher*, 74(6), 418–420.
- Stacey, K., Steinle, V., Price, B., & Gvozdenko, E. (2018). Specific mathematics assessments that reveal thinking: An online tool to build teachers' diagnostic competence and support teaching. In T. Leuders, J. Leuders, K. Philipp, & T. Dörfler (Eds.), *Diagnostic competence of mathematics teachers – Unpacking a complex construct in teacher education and teacher practice* (pp. 241–263). Springer. https://doi.org/10.1007/978-3-319-66327-2_13
- Stacey, K., & Wiliam, D. (2012). Technology and assessment in mathematics. In M. Clements, A. Bishop, C. Keitel, J. Kilpatrick, & F. Leung (Eds.), *Third international handbook of mathematics education* (pp. 721–751). Springer. https://doi.org/10.1007/978-1-4614-4684-2_23
- Steinle, V., Gvozdenko, E., Price, B., Stacey, K., & Pierce, R. (2009). Investigating students' numerical misconceptions in algebra. In R. Hunter, B. Bicknell & T. Burgess (Eds.), *Crossing divides – Proceedings of the 32nd annual conference of the Mathematics Education Research Group of Australasia (Vol. 2)* (pp. 491–498). MERGA.

Primary school teachers meet learning analytics dashboards: from dispositions to performance in classroom practice

Manolis Mavrikis¹, Stefanie Vanbecelaere², Fien Depaepe² and Eirini Geraniou¹

¹UCL Institute of Education, University College London, London, UK;
m.mavrikis@ucl.ac.uk and e.geraniou@ucl.ac.uk

²ITEC, an imec research group at KU Leuven, Kortrijk, Belgium;
stefanie.vanbecelaere@kuleuven.be and fien.depaepe@kuleuven.be

Abstract: This paper looks into teachers' use of Learning Analytics Dashboards, visualization tools that present data regarding students' learning progress in and out of lessons. Based on data of two studies conducted in Belgium and England, we discuss primary school teachers' dispositions and performance regarding the use of learning analytics dashboards in the classroom. We argue on the importance of looking into specific elements of teacher competence in using such dashboards in their practice but also understanding the broader educational context and the teachers' goals. We conclude by suggesting further research into the relationship between teachers' dispositions and how they make sense of the information presented on dashboards in practice, to inform future dashboard design and teacher training opportunities.

Keywords: primary teachers, learning analytics dashboards, digital competence

Introduction

There is much hype about the use of learning analytics to inform classroom practice. This can be seen in the proliferation of digital learning environments that provide visualisations and other forms of information to support teachers' awareness and decision making based on summarised data that students leave in the respective digital tool. Commonly referred to as 'learning analytics dashboards' (LAD) these visualizations show aggregated data about learners, learning processes, and/or learning contexts (Schwendimann et al., 2017). LAD are promising because they can inform teachers' instructional behaviour (Connor, 2019), support real-time classroom orchestration (Mavrikis et al., 2019) or promote reflection on behalf of the teacher (Molenaar & Knoop-van Campen, 2016). The use of dashboards has been shown to result in improved knowledge about the learner and adapted lesson plans involving individualised scaffolding (Aslan et al., 2019; Xhakaj et al., 2017). Furthermore, teachers might reflect on the impact of their instructions and implemented learning design. As such dashboards can improve teachers' reflection on their own practice and hence improve teaching quality (Ndukwe et al., 2020). Altogether, the aspiration is that LAD can support individualised learning experiences and improved student learning outcomes.

There has been a lot of research on the design and use of LAD in higher education (Rienties et al., 2018; Wise & Jung, 2019). Also, in primary education teachers increasingly use digital technology, a phenomenon that was accelerated by the distance and online education during the global pandemic (Kovanic et al., 2021). While research shows positive results of using dashboards for teachers (thus indirectly for learners) in primary education, there is a large variation in how teachers use these dashboards in the classroom (Molenaar & Knoop-van Campen, 2016). For example, teachers' interactions with dashboards vary with regards to when they look at the dashboard (during versus

after a lesson), how much they look at the dashboard, and the kind of feedback (personal, meta-cognitive, social, etc.) they give to learners (Van Leeuwen et al., 2021). It is well understood that whether digital technologies, including dashboards, will lead to meaningful student learning is linked with teacher competence (Molenaar & Van Campen, 2016; Ndukwe et al., 2020) and particularly, digital competence including “knowledge, skills, attitudes, abilities, strategies, and awareness that are required when using ICT” (Ferrari, 2012, p. 30). Mathematics teachers’ digital competence in particular has also been explored and presented as the combination of instrumental skills and knowledge (e.g., the ability to use digital tools), advanced skills and knowledge (e.g., the ability to apply digital tools to particular tasks), and attitudes of skills and knowledge application (Jasute & Dagiene, 2012). However, when looking into the research of dashboards in mathematics education, there is little understanding of how specific elements of teacher competence relate to effective dashboard use and how decision-making is influenced by the broader educational context.

Theoretical Background

One model that has been widely used in mathematics education research to investigate teacher competence is the competence model of Blömeke et al. (2015). They conceptualize teacher competence as a multifaceted concept consisting of dispositions, situation-specific skills and performance (Depaepe et al., 2020). First, dispositions refer to teachers’ cognitive and affective-motivational traits. Cognitive traits necessary to interpret LAD incorporate data literacy skills, defined as “the ability to effectively engage with data and analytics to make better pedagogical decisions” (Ndukwe et al., 2020, p. 3). Affective-motivational traits include professional beliefs about data and the use of LAD. In relation to the use of data for instructional purposes in particular, previous studies have revealed the importance of teacher self-efficacy (i.e., teachers’ beliefs in their own abilities to use learner data to enhance learner performance) and perceived usefulness (i.e., teachers’ beliefs about the use of learner data to enhance learner performance) (Dunn et al., 2013; Reeves & Honig, 2015). Previous studies also documented the importance and interrelations of beliefs about teaching mathematics with technology, self-efficacy, and epistemological beliefs (e.g., Thurm et al., 2022). These dispositions are assumed to impact the second facet of professional competence, i.e., situation-specific skills including cognitive processes such as perception, interpretation and decision-making before, during and after actual classroom behaviour (Blömeke et al., 2015). In view of LAD, perception refers to the extent to which teachers get oriented and apply focused attention to what is presented on the dashboard (Van Leeuwen et al., 2021). Interpretation refers to how teachers filter, organize or analyse the perceived data from dashboards and combine this information with prior expertise and experiences with the learners (Van Leeuwen et al., 2021). Decision-making refers to the instructional actions teachers plan to undertake based on the data or the assessment of the effectiveness of these actions (Wise & Jung, 2019). Third, teachers’ situation-specific skills are considered to impact their actual performance in a classroom (Van Leeuwen et al., 2021). Specific teacher actions can include selecting suitable instructional methods, prioritizing which content to teach or emphasize, reteaching and designing support for these learners in most need of them (Aslan et al., 2019).

However, there are some reasons why the implementation of LAD is not self-evident for primary education teachers. First, using LAD teachers often have limited opportunities to learn about analytics

and how they can be useful for teaching. Due to a lack of emphasis on this topic in teacher training programmes, it can be expected that teachers' self-efficacy towards the use of data and the extent to which they perceive using data for instructional purposes valuable for their teaching practice, is rather low (Dunn et al., 2013; Reeves & Honig, 2015; Wise & Jung, 2019). For example, Vanlommel et al. (2020) observed that teachers greatly relied on intuitive processes rather than on data to decide about the transition of pupils during their last year of primary education. Second, primary education teachers are generalists and may lack data literacy skills which are necessary to interpret the many visualisations presented on dashboards (Merk et al., 2020; Van Leeuwen et al., 2021). For example, teachers reported to have difficulties with interpreting dashboards, making meaningful connections between the various data components and making instructional decisions about specific groups or whole classrooms (Molenaar & Knoop-van Campen, 2016). Third, using digital artefacts in real-time classroom practice is complex. Taking the perspective of the 'theory of instrumental orchestration' (Drijvers et al., 2014), a type of orchestration is required so that the use of LAD, an available artefact in the learning environment the teacher uses for a mathematical task, is exploited in ways that improve didactical situations (Drijvers et al., 2014; Trouche, 2004). Fourth, research also pointed at limitations in teachers' ability to make data-driven decisions. Sun et al. (2016) conducted a systematic review on the use of learner assessment data. They found that while teachers use data often to identify learners' weaknesses and gaps, they consider it difficult to adapt instruction accordingly.

Methods and Participants

The overarching question of this paper is what teachers' dispositions are towards the use of LAD and how this relates to their actual performance regarding the use of LAD in their teaching. We report here on two different cases from studies in Belgium and England.

In Belgium, a study was conducted to investigate teachers' dispositions towards LAD, their situation-specific skills and performance to use dashboards. Participants were required to have at least one year teaching experience and were recruited by contacting schools in Flanders. In total, 45 (9 men, 36 woman) in-service primary education teachers of Flanders agreed to participate in the study. Teachers taught in different years of primary education (Year 1: $n=7$, Year 2: $n=9$, Year 3: $n=8$, Year 4: $n=14$, Year 5: $n=9$, Year 6: $n=15$). Their teaching experience varied from less than 5 years ($n=21$), between 5- and 20-years ($n=12$) to more than 20 years ($n=12$). Teachers dispositions and performance were measured through an online questionnaire. At the beginning of the questionnaire, teachers were given an example of a LAD as well as an explanation of what a LAD is. The first part of the questionnaire assessed teachers' dispositions (i.e. their perceived value towards the use of data in the classroom, and self-efficacy towards the use of LAD). For the scale that measured perceived value, we translated the Survey of Educator Data Use according to Wayman et al. (2009) into Dutch and adapted the items to the context of this study, regarding LAD. The items had to be evaluated on a 4-point Likert scale: (1) strongly disagree, (2) disagree, (3) agree and (4) strongly agree. Internal consistency of the scale was good (9 items, Cronbach's $\alpha=.75$) (Field, 2017). Self-efficacy was investigated using the scale of Walker and colleagues (2018). The items were translated to Dutch and were adapted to the context of this study, specifically for LAD. The scale uses a 5-point Likert scale: (1) totally disagree, (2) disagree, (3) neither agree nor disagree, (4) agree and (5) totally agree. The internal consistency was very good (12 items; Cronbach's $\alpha=.83$). A second part of the questionnaire assessed teachers'

performance. As there are no existing scales to measure this, one self-constructed multiple choice item measured how often teachers use LAD, and one self-constructed item assessed for which purposes teachers use LAD (teachers were allowed to indicate one or more than one answer). Interviews were conducted with each teacher to assess their situation-specific skills in particular situations but due to space limitations we do not report on that part in this paper.

In England, at the time of this writing, we are piloting a study with teachers who already use LAD in their teaching practice. Participants are identified from schools with three different LAD: a platform focusing specifically on practice for multiplication tables, an online tutoring service for primary mathematics, and a reading and spelling online resource. We piloted our instruments and interviews with two schools, and we are in the process of recruiting and training participants for the main study. Participants are given a short questionnaire on their profile and experience with educational technology in general, a diary to include their interactions, observed once a month in relevant planning and classroom sessions, and complete a semi-structured interview that focuses on their performance regarding the actual usage of LAD, reflect on their notes and focus on identifying how they relate the data presented in the dashboard with the decisions they are taking. In this paper, we hone in on one of our participants in the multiplication tables practice platform: a Year 4 teacher at a state school with 12 years teaching experience and a year experience with the specific platform.

Teachers' dispositions towards dashboards and actual performance in Belgium

Regarding teachers' dispositions, the mean score for perceived value towards the use of data to inform classroom decisions was 2.86 ($SD = 0.54$) meaning that they rather agree towards the idea that data are useful to make informed classroom decisions. Similar results were found for teachers' self-efficacy towards how confident they are to use a dashboard in the classroom. The teachers' mean score on this scale was 3.76 ($SD = 0.80$) showing that teachers rather feel competent to use dashboards in classroom practice. Regarding teachers' performance, all 45 teachers indicated that they use digital learning tools in their classroom practice to train learning content with pupils. Regarding the availability of dashboards, 39 out of 45 teachers report that the digital learning tools they use contain a dashboard. When asking how familiar teachers are with these LAD, we get mixed responses. Almost half of the teachers (42.3%) report that they have not heard of LAD before they participated to the study, or they knew what LAD were but never have used them before. The other teachers used LAD less than once a month (17.8%), once or twice a month (17.8%), (almost) weekly (13.3%) or (almost) daily (8.9%). The teachers that reported to use a dashboard did this for different purposes. Teachers use the data displayed on dashboards mostly to plan content to focus more on during the following lessons (42.2%). Teachers also use the data on dashboards to tailor instruction to individual students' needs (33.3%) or to form small groups of students for targeted instruction (31.1%). The data on dashboards is used less to ask for additional support in the classroom for certain learners (22.2%) or to discuss the data with the student, colleague or parent (24.4%). Most teachers use dashboards for 0 ($n=12$), 1 ($n=12$) or 2 reasons ($n=12$), far fewer teachers use them for more than two reasons. Pearson's correlation coefficients were calculated between the variables. A significant positive relationship was observed between how much teachers use dashboards and the variety of purposes they use the dashboards for ($r(43)=0.37$, $p = 0.012$). A significant negative correlation between teachers' experience with dashboards and teachers' perceived value ($r(43)=-0.33$, $p = 0.029$) was

found. This implies that teachers who report higher use of dashboards, also tend to perceive them as less valuable compared to teachers who reported less frequent use of dashboards. No significant correlation was observed between teachers' experience with dashboards and their self-efficacy towards the use of dashboards.

The case of Lena in England: actual LAD usage

In this case study, Lena (not the teacher's real name), had no prior training in the dashboard from the multiplication tables platform (which we will call MTP to keep it anonymous) or prior training on possible dashboard purposes. She has been using the MTP in a Year 4 classroom regularly (almost weekly) throughout the term and recommends to parents to access it at home too. Her use of the dashboard is occasional (once every two weeks) and not necessarily systematic. Following a preliminary qualitative data analysis of the interview, a key observation was that Lena approached the dashboard with an explicit objective that varied depending on the specific goals of the class for that week and what she had asked from parents at home. In particular, the MTP contains different game types and teachers encourage students to focus on one game or another depending on their emphasis that week (e.g. learn a specific multiplication table, several together as a practice test, or some whole-classroom competitions). Similar to the purposes reported above for the Belgium teachers, Lena accessed the dashboard to (i) plan which multiplication table she should focus on the following lesson, (ii) allocate specific multiplication tables for certain students, and (iii) identify small groups of students for targeted instruction. Less frequently, the dashboard was used to tailor feedback to specific students and to provide specific recommendation to parents e.g., in parent meetings or with other colleagues. However, Lena reflected on the fact that there is not enough time in her workload to focus on the two last purposes so she mainly used the "average daily minutes over the last 7 days" as a proxy to prioritise which students to 'nudge' to use the platform more. This helped her implement the "little and often" principle that is key to multiplication tables fluency and recall. At this point, it is worth reflecting on the teacher's intentions and the overall context behind the use of the dashboard in this case. During the interview it became clear that two intertwined forces are shaping Lena's actions, revolving around the multiplication tables check (MTC) that is statutory for primary schools in England. According to the UK government, the aim of the MTC is to determine whether pupils can recall their multiplication tables fluently. The test adds significant pressure to some schools and teachers and some parents and students find it particularly stressful. Lena (like other teachers) is concerned that the test is encouraging rote learning and creates unnecessary time pressures, therefore possibly contributing to maths anxiety for some pupils. Driven by both the desire, on one hand, that the school does better on the test and on the other hand that the pupils are supported as much as possible. The first matters as in essence the results will be used to analyse school performance that plays a role in parental decisions for selecting a school. The emphasis on individual pupils, however, was also important for Lena not only to support them to master specific multiplication tables but to use the data from the dashboard to help provide additional support wherever possible as it provided a diagnostic function that the MTC is not intended for. "The dashboard", Lena said, "helps me see exactly which times table they struggle with [...] and if I had more time or a teaching assistant, I could target with precision".

Conclusion

We started this paper referring to the common rhetoric and aspiration in the field of Learning Analytics to design dashboards and other tools that support teachers so as, in turn, they can support students with their learning. Although it is assumed that LAD can lead to better support students and even more individualized learning (Molenaar & Knoop-van Campen, 2016), its effectiveness very much depends on the teacher's competence to use LAD (Blömeke et al., 2015). Therefore, in this study we investigate two elements of teacher competence, namely their dispositions and performance towards the use of LAD in the classroom. Two data collections provide both quantitative (case Belgium) and qualitative (case England) data enabling a more holistic view on teachers' competence to use LAD. Both cases are comparable as both samples involve primary education teachers and using LAD (as part of a digital learning environment) to inform classroom practice is in both countries a relatively new tool that can support teachers.

First, we discuss the data from the Belgian case. The data demonstrated that teachers' perceived value and self-efficacy towards using LAD are moderate. This is also reflected in the reported actual usage of the teachers. Although many teachers report to use digital tools that contain a LAD, they do not report to use LAD regularly. A possible explanation for the limited use of LAD, is that teachers actually do not have time for this or do not believe to have time to use LADs. Another explanation revolves around the perceived value of LAD in that the information that is presented on current dashboards is not valuable enough for teachers to justify their use. This is also reflected in the negative correlation we observed between teachers' experience with using LAD in classroom practice and perceived value. Although there is a growing realization of advanced dashboards that can trigger interventions or even prescribe new pathways or strategies to improve student success (Kovanic et al., 2021), it is possible that the data presented on dashboards that are used at scale are rather limited and only present relatively simple descriptive information (such as accuracy, time).

Second, we discuss the data from England. The case of Lena demonstrated that -although she mentioned to have limited time- LAD can be useful, at least to a certain extent. We saw how the dashboard is beginning to be part of her practice – an instrument that is being exploited in several ways leading to specific actions. We also saw how this is shaped, if not motivated, by the overall schooling context and the national multiplication tables test that creates additional pressure to her. Applying this lens reveals a complex interplay of factors that shape the use of the LAD in this case in practice. From the case of Lena, it becomes clear that a situated account of how and why LAD are used in practice is required, analogous to a situated action perspective (e.g., Suchman, 1987). Similarly, research in mathematics teacher training has demonstrated that a key element of teacher knowledge and instructional quality is the enaction of this knowledge in practice (Tabach, 2021).

These results can inform the development of teacher training. The training may offer an answer to a key challenge in the area of Learning Analytics to facilitate teachers' journey from information to insight to action (Molenaar and vanCampen, 2019). Based on the theoretical framework of Blömeke et al. (2015), it is assumed that teachers' dispositions indirectly (through teachers' situation specific skills) influence teachers' actual performance. Targeted training that focuses on improving teachers' perceived value and self-efficacy may be helpful to support teachers' use of LAD in practice. For

example, it may be useful to present LAD and discuss explicitly which data can be helpful in classroom practice. Furthermore, from the case of Lena, it became clear that the use of LAD is very context dependent. Therefore, preparation for mathematics teachers requires not only acquiring general pedagogical training but bringing “the mathematics competence into play with the issues regarding the teaching and learning of mathematics” (Niss & Hojgaard, 2011, p.83).

References

- Aslan, S., Alyuz, N., Tanriover, C., Mete, S. E., Okur, E., D'Mello, S. K., & Arslan, A. (2019). Investigating the impact of a real-time, multimodal student engagement analytics technology in authentic classrooms. In *Proceedings of the 2019 CHI Conference on Human Factors in Computing Systems* (pp. 1-12).
- Blömeke, S., Gustafsson, J. E., & Shavelson, R. J. (2015). *Beyond dichotomies*. *Zeitschrift für Psychologie*.
- Connor, C. M. (2019). Using technology and assessment to personalize instruction: Preventing reading problems. *Prevention Science*, 20(1), 89-99.
- Depaepe, F., Verschaffel, L., & Star, J. (2020). Expertise in developing students' expertise in mathematics: Bridging teachers' professional knowledge and instructional quality. *ZDM*, 1-14.
- Drijvers, P., Tacoma, S., Besamusca, A., van den Heuvel, C., Doorman, M., & Boon, P. (2014). Digital technology and mid-adopting teachers' professional development: a case study. In A. Clark-Wilson, O. Robutti, & N. Sinclair (Eds.), *The Mathematics Teacher in the Digital Era* (pp.189-212). Springer.
- Dunn, K. E., Airola, D. T., Lo, W. J., & Garrison, M. (2013). Becoming data driven: The influence of teachers' sense of efficacy on concerns related to data-driven decision making. *The Journal of Experimental Education*, 81(2), 222-241.
- Ferrari, A. (2012). *Digital competence in practice: An analysis of frameworks*. Sevilla: JRC IPTS, 10, 82116.
- Jasute, E., & Dagiene, V. (2012). Towards Digital competencies in mathematics education: a model of interactive geometry. *International Journal of Digital Literacy and Digital Competence (IJDLDC)*, 3(2), 1-19.
- Kovanovic, V., Mazziotti, C., & Lodge, J. (2021). Learning analytics for primary and secondary schools. *Journal of Learning Analytics*, 8(2), 1-5.
- Mavrikis, M., Geraniou, E., Gutierrez Santos, S., & Poulouvassilis, A. (2019). Intelligent analysis and data visualisation for teacher assistance tools: The case of exploratory learning. *British Journal of Educational Technology*, 50(6), 2920–2942.
- Merk, S., Poindl, S., Wurster, S., & Bohl, T. (2020). Fostering aspects of pre-service teachers' data literacy: Results of a randomized controlled trial. *Teaching and Teacher Education*, 91, 103043.
- Molenaar, I., & van Campen, C. K. (2016). Learning analytics in practice: the effects of adaptive educational technology Snappet on students' arithmetic skills. In *Proceedings of the Sixth International Conference on Learning Analytics & Knowledge* (pp. 538-539).
- Molenaar, I., & Knoop-van Campen, C. A. N. (2019). How Teachers Make Dashboard Information Actionable. *IEEE Transactions on Learning Technologies*, 12(3), 347–355.

- Ndukwe, I. G., & Daniel, B. K. (2020). Teaching analytics, value and tools for teacher data literacy: a systematic and tripartite approach. *International Journal of Educational Technology in Higher Education*, 17(1), 1-31.
- Niss, M. & Højgaard, T. (Eds.) (2011). Competencies and mathematical learning. *Ideas and inspiration for the development of mathematics teaching and learning in Denmark*. IMFUFA tekst no. 485. Roskilde: Roskilde University. (Published in Danish in 2002).
- Rienties, B., Herodotou, C., Olney, T., Schencks, M., & Boroowa, A. (2018). Making sense of learning analytics dashboards: A technology acceptance perspective of 95 teachers. *International Review of Research in Open and Distributed Learning*, 19(5).
- Reeves, T. D., & Honig, S. L. (2015). A classroom data literacy intervention for pre-service teachers. *Teaching and Teacher Education*, 50, 90-101.
- Schwendimann, B. A., Rodriguez-Triana, M. J., Vozniuk, A., Prieto, L. P., Boroujeni, M. S., Holzer, A., & Dillenbourg, P. (2016). Perceiving learning at a glance: A systematic literature review of learning dashboard research. *IEEE Transactions on Learning Technologies*, 10(1), 30- 41.
- Suchman, L. A. (1987). *Plans and situated actions: The problem of human-machine communication*. Cambridge university press.
- Sun, J., Przybylski, R., & Johnson, B. J. (2016). A review of research on teachers' use of student data: From the perspective of school leadership. *Educational Assessment, Evaluation and Accountability*, 28(1), 5-33.
- Tabach, M. (2021). Competencies for teaching mathematics in the digital era: Are we ready to characterize them? In Inprasitha, M., Changsri, N., & Boonsena, N. (Eds.) *Proceedings of the 44th Conference of the International Group for the Psychology of Mathematics Education* (Vol.1, pp. 32-47). Khon Kaen, Thailand: PME.
- Thurm, D., & Barzel, B. (2022). Teaching mathematics with technology: A multidimensional analysis of teacher beliefs. *Educational Studies in Mathematics*, 109(1), 41–63.
- Trouche, L. (2004). Managing complexity of human/machine interactions in computerized learning environments: Guiding students' command process through instrumental orchestrations. *International Journal of Computers for Mathematical Learning*, 9, 281-307.
- van Leeuwen, A., Knoop-van Campen, C. A., Molenaar, I., & Rummel, N. (2021). How teacher characteristics relate to how teachers use dashboards: Results from two case studies in K-12. *Journal of Learning Analytics*, 8(2), 6-21.
- Vanlommel, K., Van Gasse, R., Vanhoof, J., & Van Petegem, P. (2020). Sorting pupils into their next educational track: How strongly do teachers rely on data-based or intuitive processes when they make the transition decision?. *Studies in Educational Evaluation*, 100865.
- Wise, A. F., & Jung, Y. (2019). Teaching with analytics: Towards a situated model of instructional decision-making. *Journal of Learning Analytics*, 6(2), 53-69.
- Xhakaj, F., Aleven, V., & McLaren, B. M. (2017). Effects of a teacher dashboard for an intelligent tutoring system on teacher knowledge, lesson planning, lessons and student learning. In *European conference on technology enhanced learning* (pp. 315-329). Springer, Cham.

Comparing atomic feedback with classic feedback on a linear equations task using text mining techniques

Filip Moons¹, Alexander Holvoet² and Ellen Vandervieren¹

¹University of Antwerp, Antwerp School of Education, Belgium; filip.moons@uantwerpen.be

²KU Leuven, Leuven, Belgium; alexander.holvoet@kuleuven.be

In a previous study, we did a crossover experiment with 45 math teachers giving feedback to 60 completed linear equation tasks in two conditions: the semi-automated condition in which they could re-use feedback and were encouraged to write atomic feedback; and a condition in which they wrote classic feedback. Atomic feedback consists of a set of formulation requirements that makes feedback significantly more reusable; instead of writing long pieces describing lots of different mistakes at once, they must (1) identify the independent error occurring and (2) write small, independent feedback items for each error. We already know that the semi-automated system led teachers to give significantly more feedback instead of saving time. This paper now explores the differences and similarities of the provided feedback in both conditions using text mining. We found that the word frequencies and sentiments are similar in both feedback types, while atomic feedback contains fewer abbreviations, more section titles, and more concrete instructions.

Keywords: semi-automated assessment, feedback, atomic, reusable feedback, handwritten tasks.

Introduction

In this research project, we investigate how we can give feedback to handwritten math assignments more efficiently. After all, handwritten tasks remain important to train higher-order thinking skills and genuine problem-solving in mathematics education (Bokhove & Drijvers, 2010). Therefore, we propose a semi-automated approach: *teachers write* feedback items, and the *computer saves* these items so they can *easily be re-used* when other students make similar mistakes (Moons & Vandervieren, 2020).

In this section, we first introduce atomic feedback, while the actual results of this project (Moons et al., 2022) are briefly presented in the research context. These are necessary to thoroughly grasp the differences between the two feedback types under investigation in the methods and results-section.

Atomic feedback

How to write feedback that can easily be re-used for other students? Long pieces of classic feedback are often too targeted to a specific student. Hence, we came up with atomic feedback: a collection of form requirements for written feedback from which we could show that it makes feedback significantly more reusable (Moons et al., 2022). To write an atomic feedback item, teachers must:

- (1) identify independent errors,
- (2) write small feedback items for each error separately, and
- (3) if an error reflects a structural mistake/misconception, create two feedback items:
 - a. one item containing feedback on the misconception in general and
 - b. one or more sub-items addressing specific mistakes.

¹ PhD fellowship of Filip Moons funded by FWO, the Research Foundation of Flanders, Belgium (1S95920N).

Atomic items ultimately form a point-by-point list covering only items that are relevant to a student's solution. The list can be hierarchical in order to *cluster* items that belong together. Clustering ensures that feedback can be written as atomically as possible and prevents teachers from writing overly specific items because it provides an orderly way in which to present related feedback to students (e.g., through thematic clustering or a visual presentation of both general and specific feedback on the same error).

A comparison of *classic* and *atomic* feedback is presented in Figure 1. As demonstrated by this comprehensive example, any classic feedback text can be rephrased as an atomic text.

Student's solution

Manipulate the formula:

$$A = 2\pi r h + 2\pi r^2 \quad \text{to } h$$

$$\frac{A}{2 \cdot \pi \cdot r} = h + 2 \pi r^2$$

$$\frac{A - 2 \pi r^2}{2 \cdot \pi \cdot r} = h$$

Classic feedback

Mind the fact that the dominant operation on the right-hand side of the equation is an addition! The division of the left-hand side by $2\pi r$ is, therefore, not helpful. Moreover, $2\pi r$ is a common factor of the right-hand side, but the sum wasn't completely divided by it (second addend not divided). Although your final answer is correct, the way it is written makes it look like a coincidence. Going from the first to the second step, you would normally subtract $2\pi r^2$ from both sides, meaning that it shouldn't be placed directly in the numerator, as you should make the denominators the same.

Atomic feedback

- First step
 - Dominant operation on the right side is an addition!
 - * Division of left-hand side is not helpful
 - * $2\pi r$ is a common factor of the right side, but:
 - sum wasn't completely divided by it
 - the second addend was not divided
- Second step
 - Your final answer is correct, but:
 - * Subtract $2\pi r^2$ from both sides.
 - * Mistake with making the denominators the same!
 - $2\pi r^2$ shouldn't be directly in the numerator.

Figure 1: A comparison between classic and atomic feedback

Research context

In a crossover experiment with 45 Belgian math teachers (Moons et al., 2022), the teachers wrote feedback on all completed linear equations tasks of 60 students in two conditions. All teachers were given a random selection of 30 tasks on which to provide classic feedback, and they assessed the other 30 in the semi-automated condition in which they could re-use feedback and were encouraged to write atomic feedback. Teachers got a small introduction training on writing atomic feedback. Half of the teachers started with writing atomic feedback, the other half with the classic feedback condition. Across all teachers, each task was assessed an equal number of times under both conditions.

For the semi-automated condition, a self-developed plugin in Moodle was used. Teachers always had three options in this condition: formulating atomic feedback, indicating that a solution was perfect, or indicating that a solution was missing (see Figure 2a). When formulating feedback, they could use

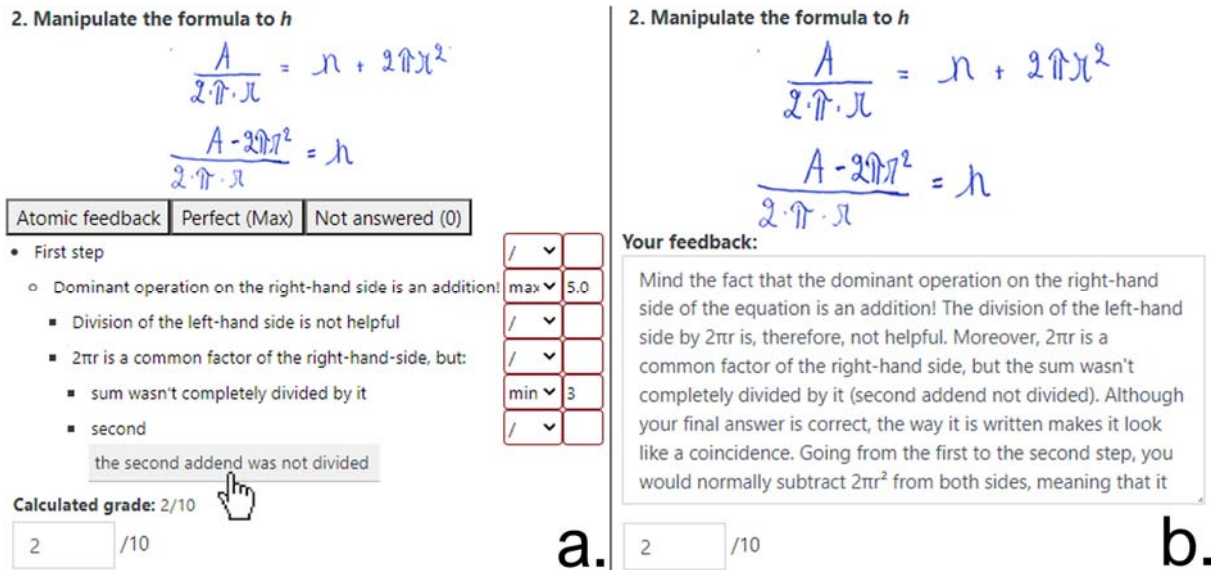

Figure 2: Screens of the semi-automated tool with atomic feedback (a) & classic feedback (b)

keyboard shortcuts to create a hierarchical list of feedback items. When a teacher typed something, the system searched the feedback items that had already been entered to detect possible matches (see Figure 2a). The system searched only within the feedback items that the teacher had already entered for that particular question. In the classic feedback condition, the teachers received only a text box to type feedback (see Figure 2b), with no possibility of re-using feedback and simulating the limited possibilities of writing feedback on a piece of paper. In both conditions, teachers were also asked to give each student's answer a score out of 10.

The 60 completed linear equations tasks on which teachers gave feedback, consisted of three items: (1) solving an equation, (2) manipulating a formula (see Figures 1 and 2), and (3) a word problem.

In Moons et al. (2022), we could already prove that feedback items meeting the atomic feedback requirements were significantly ($p < .001$) more re-used than items classified as non-atomic (odds ratio: 2.6). Furthermore, results showed no significant time differences between paper-based *classic* feedback versus semi-automated *atomic* feedback, but the teachers in our sample wrote significantly ($p = .02$) more feedback characteristics using the semi-automated system with atomic feedback compared to giving classic feedback, with a Cohen's $d = 0.41$, approaching a medium effect.

However, a key research question remained unanswered: we know by now that the semi-automated system with atomic feedback resulted in teachers giving significantly more feedback instead of saving time, compared to the 'paper-based' condition with classic feedback, but how do the two types of feedback compare in practice? A first attempt toward answering this question is made in this paper. As more feedback does not necessarily mean better feedback (Glover & Brown, 2006), this first comparison of both feedback types is of crucial importance.

Methods

To answer this question, we explored the provided feedback for both the atomic as well as the classic feedback type using text mining techniques (Silge & Robinson, 2017; Kwartler, 2017). Text mining is the process of transforming unstructured text into a structured format to identify meaningful

patterns and new insights using computer algorithms. It can be seen as a qualitative research method (Ho Yu et al., 2011) ‘using quantitative techniques’.

In this paper, we compared word frequencies, did a sentiment analysis, and compared the Markov chains of bigrams and the pairwise correlations for both feedback types. All the analyses were done using R (Silge & Robinson, 2017).

Since the teachers participating in the study provided their feedback in Dutch, all analyses were conducted in this language. In the data pre-processing phase, we first removed all Dutch stop words (= words very frequently used like ‘a’, ‘the’, ‘of’,... in English, which are semantically almost meaningless). To make the results interpretable for an English-speaking audience, only in the final data analysis step of reporting/visualising, we automatically translated all content to English using the DeepLr-package. You will notice that in the results section, sometimes two words are shown while we speak about individual words, stemming from the fact this is indeed a single word in Dutch.

Results & Discussion

Comparing word frequencies

A common first step in text mining is to compare word frequencies. The frequency of a word is the proportion of the number of times a word occurs out of the total word count. In Figure 3, a scatter plot of the used words in both feedback types is given. Words close to the identity line have similar relative frequencies in both feedback types. It is apparent from this plot that most words scatter around this line, meaning that the majority of the words appear in both feedback types with a similar relative frequency. For example, ‘off’, and ‘x’ appeared almost equally frequent in both feedback types. The observation that most words appeared in both feedback types with an almost equal relative frequency was confirmed by calculating the Pearson’s correlation coefficient of the word frequencies in both feedback types. It returned a high, positive correlation of $r(928) = 0.89$ with 95% CI [0.87, 0.90].

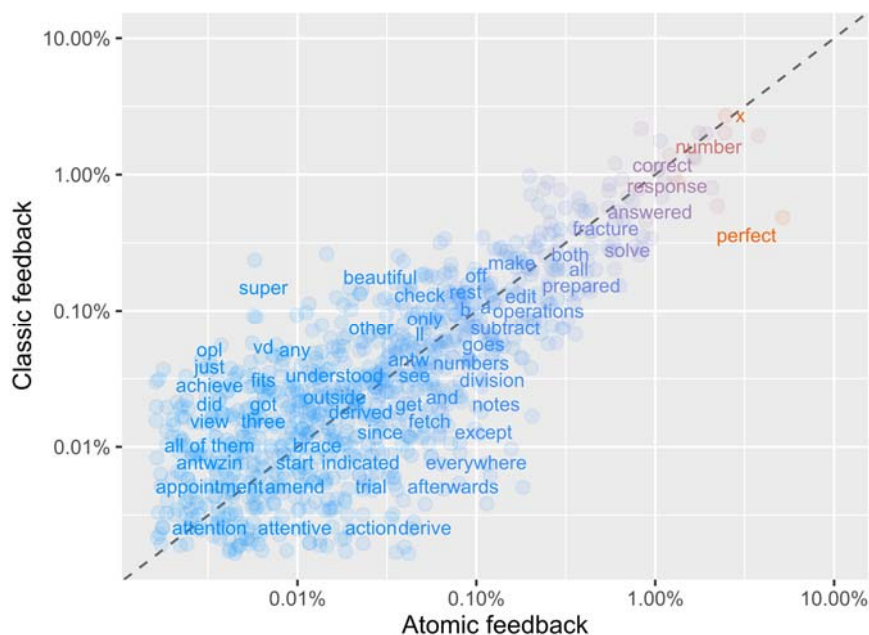

Figure 3: Comparing the word frequencies of atomic and classic feedback

Words that are far from the line are found more in one feedback type than the other. For example, ‘super’ and ‘beautiful’ were found more in classic feedback, while ‘perfect’ was found more in atomic

feedback. This can be explained by the default presence of a button to immediately indicate ‘perfect’ for a good answer in the atomic feedback condition. In the classic feedback condition, teachers always had to write something themselves, and it seems they naturally chose a more diverse range of encouraging words. Also notable is the increased presence of a lot of abbreviations in the classic feedback condition, which DeepL understandably failed to translate, like ‘opl’ (Dutch abbreviation for ‘solution’), ‘vd’ (= ‘of the’) or ‘antw’ (= ‘answer’). This was slightly confirmed by computing a two-proportions z -test of words of 3 characters or less in both conditions; there was a significant difference between atomic and classic feedback, $z = 9.31, p < .001$. Teachers shortening feedback is one of the well-known coping mechanisms described in the literature (Price et al., 2010) to overcome the workload stemming from giving feedback. It seems that our semi-automated system with atomic feedback restrains teachers from using abbreviations all too often, as they can re-use feedback items. This might render feedback more readable for students.

Sentiment analysis based on given scores

Analysing the sentiment of a text is often done by using a pre-existing lexicon that assigns a sentiment to individual words (like ‘beautiful’ = positive, ‘incorrect’ = negative); subsequently, the sentiment of the whole text can be determined (Silge & Robinson, 2017). However, in this crossover experiment, teachers were asked to give a score out of 10 to every question in both feedback types, meaning we could perform a sentiment analysis by using an (arbitrary) division in points. We looked at the words belonging to a score < 5 (sentiment: bad), to a score ≥ 5 and ≤ 7 (sentiment: moderate) and to a score > 7 (sentiment: good). The distribution of all these sentiments for both feedback types can be found in Figure 4.

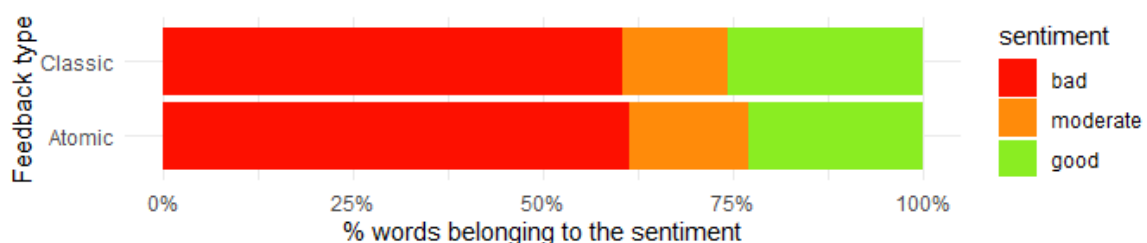

Figure 4: Comparing the sentiments of atomic and classic feedback

The distribution of sentiments of both feedback types looks largely the same: proportionally, an almost equal amount of words is spent on bad answers, and atomic feedback features a bit more feedback on moderate feedback than classic feedback, which has, in turn, proportionally more words coupled to good answers. A Chi-Square Goodness of Fit test indicated that the sentiment distributions differed significantly across atomic and classic feedback, $\chi^2(2, n = 31053) = 166.65, p < .001$; although this result has little practical importance as this test is severely overpowered.

Let’s look at the more characterising words for each sentiment in each feedback type than others, using the $tf-idf$ -measure (term frequency-inverse document frequency). We see that both the bad and moderate sentiments contain abbreviations for classic feedback, meaning they are more characteristic for classic feedback than atomic feedback for these sentiments. For the good sentiment, a variety of appreciation words appear in the classic feedback condition, while ‘perfect’ dominates the atomic feedback for this sentiment. Yet again, the default presence of the ‘Perfect’-button in the atomic feedback condition might have teachers stop bothering to write some more words of appreciation

Table 1: Observed similarities and differences between atomic and classic feedback

	Atomic Feedback	Classic feedback
Similarities	(S1) Similar in both word usage and relative word frequency ($r = 0.89$) (S2) Equal distributions of feedback belonging to bad, moderate, and good answers	
Differences	(D1) More feedback (Moons et al.,2022) (D2) Good answers often labelled 'perfect' without anything more (D3) Limited use of abbreviations (D4) Many structuring elements such as section titles (D5) More concrete instruction on how to improve mistakes	(D1) Fewer feedback (Moons et al.,2022) (D2) Good answers praised with a variety of appreciation words (D3) Abbreviations common (D4) No structuring elements (D5) More limited to short statements on mistakes

References

- Bokhove, C., & Drijvers, P. (2010). Digital tools for algebra education: Criteria and evaluation. *International Journal of Computers for Mathematical Learning*, 15(1), 45–62. <https://doi.org/10.1007/s10758-010-9162-x>
- Glover, C. & Brown, E. (2006). Written feedback for students: Too much, too detailed or too incomprehensible to be effective? *Bioscience Education*, 7(1), 1-16, <https://doi.org/10.3108/beej.2006.07000004>
- Kwartler, T. (2017). *Text Mining in Practice with R*. Wiley.
- Moons, F., Vandervieren. E & Colpaert, J. (2022). Atomic, reusable feedback: a semi-automated solution for assessing handwritten tasks? A crossover experiment with mathematics teachers. *Computers & Education Open*. <https://doi.org/10.1016/j.caeo.2022.100086>
- Moons, F. & Vandervieren. E. (2020). Semi-automated assessment: the way to efficient feedback and reliable math grading on written solutions in the digital age. In A. Donevska-Todorova, E. Faggiano, J. Tralova, Z. Lavicza, R. Weinhandl, A. Clark-Wilson, & H.-G. Weigand, *Proceedings of the tenth ERME topic conference (ETC 10) on mathematics education in the digital age (MEDA)*, 16–18 September 2020 in Linz, Austria (pp. 393–400). HAL. <https://hal.archives-ouvertes.fr/hal-02932218>
- Price, M., Handley, K., Millar, J. & O'Donovan, B. (2010). Feedback : all that effort, but what is the effect? *Assessment & Evaluation in Higher Education*, 35(3), 277–289. <https://doi.org/10.1080/02602930903541007>
- Silge, J. & Robinson, D. (2017). *Text Mining with R: a tidy approach* (1st ed.). O'Reilly Media. <https://www.tidytextmining.com/>
- Yu, C. H., Jannasch-Pennell, A., & DiGangi, S. (2011). Compatibility between Text Mining and Qualitative Research in the Perspectives of Grounded Theory, Content Analysis, and Reliability. *The Qualitative Report*, 16(3), 730-744. <https://doi.org/10.46743/2160-3715/2011.1085>

Teachers' engagement with experimental mathematics and interactive resources

Elena Naftaliev and Marita Barabash

Mathematics Teaching Department, Achva Academic College, Israel;

elenanaftaliev@gmail.com; maritab@013.net

The study focuses on ways of enhancing mathematics teachers educated use of Technology-Based Interactive Resources (TBIRs) in merging the Experimental-Mathematics (EM) with Formal Mathematics (FM). We designed and analysed professional development environments offering the teachers relevant experience in learning, teaching, and designing resources on their own. The paper presents the case study of an experienced leading teacher (Sol) in three time-points during the first year of his professional development. The study implies amalgamation of three aspects of teachers' professional knowledge: mathematical knowledge needed for EM – FM merging; pedagogical functions of TBIRs; instrumentational orchestration.

Keywords: Technology-Based Interactive Resources, Experimental Mathematics, Instrumentational orchestration, Teachers' professional knowledge.

Theoretical background

The information technology has changed the nature of mathematical experience, suggesting that mathematics may become an empirical discipline, a place where things are invented by running experiments and observing what happens (e.g., Borwein, 2016). The process has led to the development of the new mathematics approach called "experimental mathematics". The approach builds on previous approaches to mathematics, yet adds something new - extensive use of computer tools such as algebraic manipulations and calculations, sophisticated visual tools, simulations and data analysis to deal with mathematical problems. To infer from computer-based results, one must be able to distinguish relevant from irrelevant, variant from invariant, obvious from proof-demanding, random from systematic. These types of mathematical activities, invoked in teaching approaches based on educated use of TBIRs, bridge the tension between "traditional rigorous" mathematics and EM enabled by modern technology. There are profound differences between the traditional page in math curriculum materials that appears on paper and the new page that derives its principles of design and organization from the screen and the affordances of technology (e. g., Naftaliev & Yerushalmy, 2017). In traditional curriculum materials, content is displayed in a static mode and students are invited to interpret it with limited possibilities of interaction, e.g., by pointing to a figure or tracing with a pencil. In contrast, recent technological advancements have enabled the production of TBICMs: a new type of materials that enables a broader interaction between the users and content. TBICMs comprise a set of interactive diagrams (IDs), namely, a relatively small unit of an interactive materials that can be used for different purposes: an exposition, a task, an exercise, etc. In such materials, students are invited to interpret the content by interacting with it, e.g., by playing a video clip, interacting with a graph, or changing the given examples (e. g., Naftaliev, 2018).

Considering the relevant school mathematics learning and teaching implications, Arzarello & Manzone (2017, p. 123) remark that teachers can create a classroom climate, according to which students enter into the logic of inquiry: “When such a climate is introduced in the classroom students learn to rely on arguments and reasoning rather than authority, they make use of their factual knowledge, and they come to a deeper understanding of the way mathematical facts are related. Experimental and theoretical features will not be seen any longer as contrasting but as complementing components of processes that coach students to investigate, conjecture, and prove.”

Mathematics teachers find it challenging to integrate technological interactive resources into their lesson plans and revise their practice accordingly (Trouche et al., 2013). Naftaliev (2018) mentions three challenges that prospective teachers face when integrating TBIRs in teaching-learning. The first is a mismatch between TBIR orientations and their own. Although aware of the pedagogical possibilities of TBIRs, they continue to interact with the materials in conventional ways. Second, there is an imbalance between what students learn by engaging in TBIR-facilitated interactions and what they “should” learn according to the teachers’ goals. Third, teachers have difficulties in dealing with knowledge that students develop via TBIRs and in designing teaching-learning processes to help them progress.

Thus, teaching with interactive curriculum resources should be considered more than a technological change; indeed, it is an attempt to create new paths to the construction of mathematical meaning (Naftaliev, 2018). It should be the aim of TBICM-aided mathematics teachers to orchestrate students' learning and manipulation of tools by implementing well designed tasks and lessons (Leung, 2017).

To facilitate students’ engagement with interactive resources, teachers must learn how to promote and guide the exploration while bridging the tensions among the curricular requirements, opportunities for students’ active personal learning, and their own beliefs, values, and preferences (Naftaliev, 2018). They need to examine the interactions among the mathematical content to be taught/learned; interactive curriculum resources that directly affect the way the content is taught; their instructional practices; and students’ working modalities and experiences within the specific educational setting. The mutual influence of teacher and material implies that curricular resources allow but also constrain their use by teachers, as do teachers’ orientations toward curricular resources (Choppin et. al., 2018; Naftaliev, 2018). The emergence of digital curriculum resources has blurred the boundaries between designer and user. Historically, curricular resources were designed by small teams of people who were external to the context in which these resources would be used (Gravemeijer, 2004). With the advent of digital curricular resources, however, teachers can undertake design work at two stages: at inception and in translating resources into teaching tools ((Pepin et al., 2017; Choppin et al., 2018).

Naftaliev & Yerushalmy studied how, as the core of engaging TBIRs, IDs can be designed to form a pedagogical tool for various teaching intentions and students’ needs and developed a semiotic framework for pedagogical functionality of interactive materials (e.g., Naftaliev & Yerushalmy, 2017; Naftaliev, 2018). The framework is characterized by three types of ID functions that address a variety of learning and teaching settings: presentational (refers to type of example in the ID), orientational (refers to mode of representations in the ID), and organizational (refers to the connection

between all the components of the ID). The presentational function refers to the three types of examples in IDs: specific, random, and generic. “Sketchiness” vs. “rigorousness” of diagrams is an important factor in user orientation. The organizational function looks at the system of relations defining wholes and parts and specifically at how the elements of text combine together. IDs can be designed to function in three different ways: Illustrating, Elaborating, Guiding. Similar TBIRs designed according to different pedagogical functions should be considered different learning settings (ibid.). The results of the studies find this framework valuable and productive as a tool for teachers’ professional development (Naftaliev, 2018).

Trouche et al. (2013) and Gueudet & Trouche (2012) refer to instrumental orchestration as the teacher’s intentional and systematic organization and use of the various artefacts available in a learning environment in order to guide students’ learning. Teachers’ orchestration includes arrangement of learning environments, or “didactical configurations”, and intentional guidance of their exploitation modes (ibid.). When teachers interact with TBIRs, they develop particular schemes of using it. The schemes may vary from teacher to teacher even if the same resource is used because they depend on such major factors as the teachers’ orientations and knowledge.

Research design

Table 1: Stages of teacher engagement with TBIRs in the course of the PD

<i>Teachers as learners</i>	In first 2-day workshop the participants experienced learning mathematics based on use of TBIRs in merging the EM with FM.
<i>Teachers as reflective learners</i>	During the second 2-day workshop the participants were exposed to the theoretical frameworks and reflective analysis guided by the researchers, of the materials and of the learning and teaching processes at the first workshop, through the mathematical and pedagogical functionality lenses. In the workshop the teachers were also exposed to possibilities of work in the GeoGebra platform and to the general aspects of the project and its structure and purposes.
<i>Teachers as designers</i>	The workshops were followed by group work coordinated by the leading teachers. Each one of three groups chose a topic and designed a teaching unit. The participants were asked to justify their design from two principal viewpoints: mathematical approaches and pedagogic functionality. The units were tried-out by their peers and discussed in pairs and in full group so that each designer got feedback on his/her group’s work. This was followed by another workshop that included the reflective analysis by the participants of their experiences with the units both as teachers, i.e., in reference to the units they had designed, and as learners, i.e., in reference to their peers’ units.

In our research, we study ways of promoting secondary and high-school mathematics teachers’ knowledge, skills, and orientations in order to enrich their teaching practices with educated and perceptive use of TBIRs, for the implementation of the experimental-mathematics approach in school alongside with formal, deductive mathematics. To attend this objective, we design and analyze five stages in the course of the professional development (PD): teachers as learners; teachers as reflective learners; teachers as teachers; teachers as reflective teachers and teachers as designers. Each stage is designed and re-designed in several cycles to provide teachers with necessary kinds of experiences

with TBIRs. The following questions we find important to answer, on the way of attaining the objective: (1) Are there amendments in teachers' attitudes towards mathematical background of the TBIRs designed by them, and if there are – how they can be characterized? (2) Does the teacher start to differentiate among different pedagogical functions of TBIRs? (3) Are there amendments in teachers' orchestration modes applied at different stages of designing and implementation of the TBIRs designed and/or learned by peers?

During the first six months of PD, we had performed a series of meetings in various formats: six plenary workshops and regular zoom or face-to-face meetings of working groups coordinated by the leading teachers / research assistants. The three stages in the course of the PD described in Table 1. The data for the case study in the paper was picked from the documents obtained during the described above period of the project, reflecting the three different instances of the period. The participant (Sol, pseudonym) is an experienced leading teacher and teachers' educator. We analyse Sol's evolution using the three documents which were obtained at three different timepoints of the first year: (1) The questionnaire answered by the participants prior to the beginning of the project, and the lesson plan submitted at the same time. (2) The first unit based TBIRs designed by the Sol's group after the first two workshops. (3) The questionnaire answered after the unit had been designed. These documents are being analyzed through the lenses of the three theoretical frameworks.

Sol's evolution as teacher at three timepoints

Orchestration modes (Response to Research Question 3)

At the first stage, before the workshops, the usage of interactive tools in Sol's document was only optional as an addition to static materials: printed tasks and exercises using Google forms.

Unlike the first stage, the second one was organized around several interactive tasks with variety of didactic purposes: exploratory tasks, exercising, demonstration. The students were encouraged to engage with the tasks, to work with the peers, to present and discuss their work with whole class, and only in the end the teacher demonstrated the key idea of the unit.

Supposedly the difference between the modes at the first and the second stages was due to the workshops held in between. An important fact is that Sol explicitly listed some challenges he faced related to orchestration of classroom activity based on TBIRs: "waste" of time, documentation of students' work, choice of platforms, design of tasks, etc. Sol didn't mention any challenges either in mathematics or in pedagogical functionality of TBIRs.

Mathematical contents (EM / FM) (Response to Research Question 1)

As it was described by Sol in the questionnaire at the first stage, the main role of technology is in "discovery of new theorems and investigation". Sol did not provide any constructive suggestions regarding the role.

After the first workshop, Sol and his group chose to design a unit with IDs on loci, focusing on the perpendicular bisector and on the locus of vertex of the triangle of given area and with two other vertices fixed. As the group participants emphasized, the task focused on loci which are straight lines.

The GeoGebra applet on which one of the units is based, was downloaded from the Ministry of Education site.

The notion of locus in formal mathematics involves necessary and sufficient conditions on points belonging to it: in order to claim that a set of points is a locus defined by a certain property, one has to ensure that for all the points in it the property holds, whereas for any other point it does not hold. Therefore, developing an adequate intuition involves reference to both these issues. In formal mathematics, any definition is explicitly or implicitly an “if and only if”, that is, two-way, statement. Nevertheless, in formulating formal definitions, the “if and only if” part is frequently omitted, remaining implicitly implied, but not explicitly stated. Unlike a general mathematical definition, a proper formulation of the definition of locus explicitly requires both logical directions.

The locus in the first part of the Sol’s group unit is that of a point equidistant from the endpoints of a given segment. The “candidate” for locus is formed in a dynamic (GeoGebra) applet as a trace of the moving point whose distances from the endpoints are maintained equal; they are presented numerically or graphically, opting for any of the two representations. The activity and instructions given to the students, lead to the understanding that all the points equidistant from the segment endpoints, are on the bisector perpendicular. No instructions or suggestions are aimed at what is didactically coined as “non-examples”; in this case, at points that do not belong to the bisector perpendicular, to make sure that for them the property of being equidistant from the segment endpoints does not hold. Moreover, the interactive diagram design is limited to constructing equidistant points alone, not suggesting to consider an arbitrary point, though the diagram is designed within the open platform.

The locus presented in the second part of the unit, is that of the third vertex of a triangle whose area and side (i.e., two vertices) are given both visually and by their numerical values. Two points on two sides of the given segment are suggested as “candidates”; these points are “draggable” and “traceable”, thus suggesting the locus form. In this case, as well, the implication was one-way, through two lines resulting from the applet.

The diagram design leads to certain intuition on how the locus of triangle vertices is located. Namely, the locations of the vertices suggested in the example lead to understanding that they are located on two separate lines parallel to the given side. If not for the advantages of technology, this conjecture would probably be far from obvious. On the other hand, provision of abundant numerical data in the diagram has two consequences: first, it explicitly links the notion of locus to analytic geometry, both in tools to be used and in the representation of the result; second, it provides redundant information that does not enhance the students’ insight into the geometric configuration. Another limitation refers to the visual effect of the limited-scale field in which the applet is designed, the scale of the applet field being non-variable. The open GeoGebra platform enables “unlimited”, “infinite” dragging, thus providing the image of the object as a line. The finite working space renders the result to look like two parallel segments, and it is far from obvious that they are parts of infinite lines who are the locus sought for in the problem.

The title of the ID given by the site of the Ministry of Education is: “The triangle by two vertices and area”. The title given by the group is “Triangles of constant base and equal areas”. Actually, both

titles do not mention a “locus”; thus, it seems not to be necessarily what is being sought for, though it is implicitly understood and mentioned by the participants. The explicit definition of locus is lacking in the whole unit; an explicit formal proof doesn’t seem to be expected in this specific task, unlike the task with perpendicular bisector where a partial proof was expected, referring to one logical direction of the locus property. To be sure, in intertwining experimental and formal mathematics, the experimentation and the formal proof of the conjecture, ensuring that an object observed with the aid of the tool stands for the formal definition, are two sides of the same coin.

As we have observed in the task designed by his group, the reference to formal or experimental mathematics, as well as to their intertwining, as mentioned e.g., as “discovery of new theorems”, lacked some important features. No clear-cut definition was given either to locus in general, or to perpendicular bisector of segment, so that the starting point of a theorem to be discovered is absent. In addition, the experimentation as planned in the unit referring to both loci, leads only to one direction in the locus properties, with no indication of the “if and only if” part in the definition of the locus concept. Though Sol obviously makes use of visualization features provided by the tools, his readiness to apply them in the teaching unit is limited, subject to his conception of time restrictions and to the matriculation exams expectations.

In the reflective questionnaire, after the group learning and teaching activity, the claims of mathematical discovery remain at the declarative level, no deeper remarks or suggestions provided in either topic. Though one of the peers explicitly asked whether a formal proof was expected, eventually Sol made no amendment in his initial design.

Pedagogical functions of TBIRs (Response to Research Question 2)

As we can conclude from the documents’ analyses, there is no explicit reference to pedagogical functions in Sol’s documents. The analysis of TBIRs’ pedagogical functions in Sol’s documents presented here was performed by the researchers. The materials Sol referred to in the questionnaire at the first stage were static and interactive materials were only optional. Nevertheless, we have discerned several implicit pieces of evidence on variety of pedagogical functions in the unit designed by Sol’s group at the second stage.

Of the four activities involved in the first part of the unit, only one was designed as an interactive diagram based on the open GeoGebra platform. Its organisational function was that of an illustrating diagram. It demonstrated only the points on the perpendicular bisector, and suggested no possibilities for further exploration, though the platform being open, these possibilities are not restricted. From the point of view of presentational function, this is a generic example: it does not depend on specific values of endpoint co-ordinates, enabling “playing-around” with the given segment. Thus, the implication is that whatever the observations are based on this diagram, they do not depend on the chosen segment. From the point of view of orientational function, the diagram is designed in a metric mode, and has no characteristics of a schematic mode: the information the students receive is pre-designed and focuses on purely numeric values, explicitly providing the distances of the point from the segment endpoints.

The second part of the unit focused on locus of the third vertex of triangle whose two vertices and area are given. It is intended to lead to the appreciation that the constraints on the movement of the

third vertex of the triangle of given side and area are such that (the part of) its locus is a straight line parallel to the given side. Moreover, it explicitly suggests trying location of vertices at two sides of the given line, thus leading to both (disjoint) parts of the locus. The diagram is of the guiding type because it provides the following resources: the numerical values of the points coordinates, of the area, and upon the request – the heights of the triangles; the traces of the vertices being dragged allow conjecturing on the locus being asked for. The vertices of two triangles given in the applet explicitly suggest that the locus consists of two separate parts. The diagram is purely metric, presenting the numerical data of all the given objects with no option of disregarding the numerical data and presenting it as a geometric sketch. The example in the diagram is of the generic type, enabling the variation of all the given objects.

To sum, we have discerned variety of pedagogical functions in the interactive unit designed by Sol's group at the second stage, such as illustrating and guiding functions, metric modes of IDs, generic example. As we have observed in the analysis of the questionnaire following the design and implementation of the first unit, he referred to pedagogical functions of units – both his own and of his peers'. Sol chose to characterize his peers' unit as elaborating diagram, referring to its open character, too open to the best of his judgment. To his opinion, there are too many options for a student to choose from, therefore the student will need further instruction and direction; he claims the unit would profit from subdivision into smaller parts. After he was involved in learning and teaching with the units, he could appreciate the importance and the relevance of pedagogical functions due to this experience. It was apparently much less lucid to him at the initial stage.

Conclusions and challenges

To sum up our observations and analysis, we discern the beginning of formation of the new attitude to teaching mathematics interweaving formal and experimental approaches involving TBIRs. As we have observed, the teachers refer to pedagogical functions of their units only after they themselves have been involved in learning and teaching with TBIRs. And yet, the reflective analysis of the units designed by the groups of teachers resulted in both the researchers' and the teachers' conclusion, that the units designed by the teachers at that stage did not reflect at a satisfactory level the expectations of teaching and learning modes. One of our conclusions was that the teachers' initial intention in their design was going along the "well-trodden paths", i.e., translating the paper-and-pencil tasks into interactive tasks without any change in the teaching paradigm.

Thus, we infer that during the first year, the teachers' mode of action with TBIRs was very much influenced by the long experience accumulated in their previous teaching with static materials and based on apposite paradigms. Studies conducted about teachers' selection of resources and classroom practices support our conclusion concerning teachers' choice of design principles being closely linked to their beliefs and teaching practices (e.g., Naftaliev, 2018). We assert that the real challenge is changing the paradigm and not only introducing this or that technological platform. The paradigm comprises the amalgam of the three key aspects: merging EM and formal mathematics based on the TBIR use, including the appropriate deepening and enhanced flexibility of the teachers' mathematics knowledge; classification of pedagogical functions of TBIR; instrumentational orchestration modes.

Acknowledgements

This research was supported by the Israel Science Foundation (grant No. 780/19).

References

- Arzarello, F., & Manzone D. (2017). The planimeter as a real and virtual instrument that mediates an infinitesimal approach to area. In: Leung, A. & Baccaglioni-Frank, A. (Eds.), *Digital technologies in designing mathematics education tasks—Potential and pitfalls. Mathematics education in the digital era*, 121–152. New York: Springer.
- Borwein, J. M. (2016). The life of modern homo habilis mathematicus: Experimental computation and visual theorems. In J. Monaghan, L. Trouche, & J.M. Borwein (Eds.), *Tools and mathematics*, 23–90. Springer International Publishing.
- Choppin, J., McDuffie, A. R., Drake, C., & Davis J. (2018). Curriculum ergonomics: conceptualizing the interactions between curriculum design and use. *International Journal of Educational Research*, <https://doi.org/10.1016/j.ijer.2018.09.015>.
- Gueudet, G., & Trouche, L. (2012). Teachers' work with resources: Documentation geneses and professional geneses. In G. Gueudet, B. Pepin, & L. Trouche (Eds.), *From text to “lived” resources: Mathematics curriculum materials and teacher development*, 23–41. Springer, Dordrecht.
- Gravemeijer, K. (2004). Local instruction theories as means of support for teachers in reform mathematics education. *Mathematical thinking and learning*, 6(2), 105-128.
- Leung, A. (2017). Exploring techno-pedagogic task design in the mathematics classroom. In A. Leung & A. Baccaglioni-Frank (Eds.), *Digital technologies in designing mathematics education tasks: Potential and pitfall*, 3–16. Cham: Springer.
- Naftaliev, E., (2018). Prospective Teachers' Interactions with Interactive Diagrams: Semiotic Tools, Challenges and Well-Trodden Paths. In Fan, L., Trouche, L., Qi, C., Rezat, S. & Visnovska, J. (Eds), *Research on Mathematics Textbooks and Teachers' Resources: Advances and Issues*, 297–314. Springer.
- Naftaliev, E., & Yerushalmy, M. (2017). Design digital tasks: Interactive diagrams as resource and constraint. In Leung, A. & Baccaglioni-Frank, A. (Eds.), *Digital technologies in designing mathematics education tasks—Potential and pitfalls. Mathematics education in the digital era*, 153–173. Switzerland: Springer.
- Pepin, B., Gueudet, G., & Trouche, L. (2017). Refining teacher design capacity: Mathematics teachers' interactions with digital curriculum resources. *ZDM—The International Journal on Mathematics Education*, 49(5), 645–661.
- Trouche, L., Drijvers, P., Gueudet, G., & Sacristan, A. I. (2013). Technology-driven developments and policy implications for mathematics education. In Clements, M.A., Bishop, A.J., Keitel-Kreidt C., Kilpatrick, J., & Leung, F.K.S. (Eds.), *Third international handbook of mathematics education (1st ed)*, 753–789. Springer-Verlag, New York.

Students' strategies for identifying reflective symmetry of extra-mathematical shapes in a digital environment

Norbert Noster¹, Arnon HersHKovitz², Hans-Stefan Siller¹ and Michal Tabach²

¹University of Würzburg, Germany; norbert.noster@mathematik.uni-wuerzburg.de,
hans-stefan.siller@mathematik.uni-wuerzburg.de

²School of Education, Tel Aviv University, Israel; arnonhe@tauex.tau.ac.il,
tabachm@tauex.tau.ac.il

Sorting tasks are commonly used in mathematics education to highlight certain features of a group of objects or a certain concept. Such tasks can also use extra-mathematical objects which, compared with inner-mathematical objects, are not reduced to essential features and often contain additional ones, hence are more complex. This makes the application of mathematical ideas to extra-mathematical objects more demanding and is of special interest because it requires one to transfer and apply mathematical ideas outside the world of mathematics. Our goal was to identify students' classification strategies. In this study, 29 students were presented with ten traffic signs, representing extra-mathematical shapes, and were asked to classify them regarding reflective symmetry. This was done in a digital environment, providing automated real time feedback on the correctness of the classification. Signs clustering analysis highlight complex combinations of strategies.

Keywords: Reflective symmetry, mathematical applets, feedback, open learning environments.

Introduction

As using examples and non-examples has been shown to be beneficial for learning (Tennyson, 1980), we ask students to classify extra-mathematical objects (traffic signs), being examples for reflective symmetry, as having one or multiple lines of symmetry (LoSs). This was realized in a digital environment: It allows students to interact with objects and gain feedback based on the interaction in real time – a feature that may influence the working process. Importantly, feedback may support the learning process (Hattie & Timperley, 2007). Therefore, acknowledging the inherent difficulty of tasks that involve extra-mathematical objects and the interference of feedback in problem-solving, we asked: Which clusters of extra-mathematical shapes emerge based on students' sorting patterns?

Intuitiveness on categorizing traffic signs with respect to reflective symmetry

Categorizations seem to be influenced by intuition, meaning that some examples are intuitively accepted for representing a concept while others are not (Tsamir et al., 2008). That is, intuitive (non-)examples are directly acceptable without further need for justification (Fischbein, 2002). *Secondary Intuitive* describes that a second level of intuition is developed through instruction (Fischbein, 2002).

Such a categorization of (non-)examples being intuitive or non-intuitive was found to be useful for categorizing basic geometric shapes regarding reflective symmetry (Noster et al., 2022). Students face different criteria which may influence their judgement, when asked to classify traffic signs with respect to reflective symmetry. As this represents a multitude of elements, this can be a rather complex task due to the amount of information that needs to be processed (Sweller, 2012), what makes assumptions on (non-)intuitiveness of categorizing objects rather difficult. However, we

present four criteria, which appear to the authors as being the most important ones as they are derived by a careful analysis of the signs and in one case by previous empirical findings, representing possible indicators for intuitiveness of (non-)examples.

Similarity of Inner and Outer Shape of Signs

The overall shape (circle, triangle, square) of the sign is defined by the outer most borders, which we refer to as *outer shape*. Within that, an *inner shape* can be identified, meaning that there is a shape inscribed into the outer shape (e.g., arrow, exclamation mark, circle). The relationship between the inner and outer shapes may impact the classification task, as if they are not similar to each other (e.g., an arrow in a circle), each of them must be examined and compared to the other regarding their LoSs.

Basic Geometric Shapes

Shapes such as circles, triangles or quadrilaterals are in the focus of mathematics instruction and can be assumed to be somewhat familiar to learners. Therefore, they are of relevance for examining extra-mathematical objects, especially when they are dominantly apparent as they are in traffic signs outer shapes and to some extent the inner shapes as well.

Orientation of LoSs

It was shown that students seem to struggle with *inclined LoSs*, meaning that they are oriented neither horizontally nor vertically (Kuchemann, 1980; Hoyles & Healy, 1997). Therefore, the orientation of the LoSs needs to be examined, as there is reason to believe that inclined LoSs are harder to identify.

Number of LoSs Inherent in a Sign

Tsamir et al. (2008) raised the point, that the more critical attributes an object is missing the more likely it is to be accepted intuitively as non-example and therefore, may affect student's ability to categorize geometric shapes. This may also be the case for categorizing traffic signs. It may be more likely to identify multiple LoSs, the more LoSs are inherent of a sign. For example, detecting two out of an infinite amount of LoSs (circle) may be easier than identifying two out of two LoSs.

Methodology

Research Field and Population

By 4th-grade, students from both Germany and Israel are expected to understand reflective symmetry in two-dimensional geometry. They should be familiar with the term "Line of Symmetry", be able to identify LoSs, and to correctly classify shapes based on reflective symmetry-related characteristics.

Data was collected (N=29 – 12 female /17 male, 9-12 years, M=10, SD=0.9) in a pilot project carried out in Israel ($n_1 = 12$) and Germany ($n_2 = 17$) with further results being published separately (Noster et al., 2022). We are aware of a statistically significant difference in age between the two country-based groups (Mann-Whitney's W-value=38, at $p < 0.01$, with Rank-Biserial Correlation of 0.63), however none of the research variables proved a difference between these two groups. Also, there were no gender differences between the country-based groups, with $\chi^2(1)=2.26$, at $p=0.13$. Therefore, we treated the whole population as one group.

Research Tool and Process

Our main research tool was a first version of an applet integrated, designed and developed using GeoGebra. The applet presents users with different shapes that are to be classified as either owning or not owning a certain property. This task design was used in a small series of three applets (see next section). In the task discussed in this study ten traffic signs are presented to the participants, which they are asked to classify by dragging each image into one of two regions (see Fig 1); one region would hold the images with a single LoS, the others – images with multiple LoSs. This builds upon the previous task in which participants were asked to decide whether objects have a line of symmetry or not and aims at a different aspect of reflective symmetry (meaning that objects may own multiple LoS at the same time). After dropping a shape in one of the regions, immediate feedback is available in the form of an updated cumulative count of correct and incorrect classifications. Users can keep dragging shapes from anywhere to anywhere on the screen. This allows for learners to analyze their mistake and revise it, which may have remained unnoticed without the feedback function. The automated feedback therefore serves as a tool to provide learning opportunities, that makes students aware of their mistakes. We ran the applet on either a large-screen tablet or a touch-screen laptop.

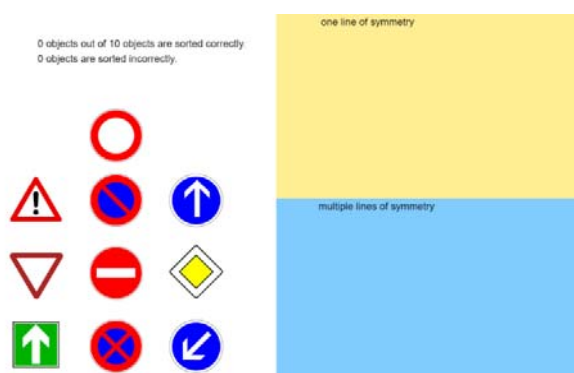

Figure 1: GeoGebra applet used in this study

Data Collection, Preparation

Data collection took place in early March 2022. Members of the research team had met with each of the participants individually. In Israel, these meetings took place in the students' homes, after getting an approval from their parents; in Germany, these meetings took place in school, after getting an approval from their parents, the responsible teachers as well the school management. First, the researcher made sure – by asking them directly about it – that the participant was familiar with the concept of reflective symmetry and was able to classify shapes based on this property. Then, the researcher presented the participant a similar (non-symmetry related) applet, which had the very same graphical interface and made sure that the participant got familiar with the interface and engaging with the applet, as well as the feedback. Next, the researcher presented the participant with a symmetry-related applet where they were asked to classify quadrilaterals based on the existence/non-existence of LoSs (Noster et al., 2022), an applet that is not included in the current analysis. Finally, the researcher presented the participant with the applet studied here and let them use it by themselves until they stated that they were done. Each such meeting was a few minutes long (up to approx. 5). While using the applet, we captured the screen, and used these recordings for our analysis.

The videos were manually coded with the basic unit of analysis being an image-movement, that is, dragging and dropping a traffic sign image from one region on the screen to another region. We had 524 image-movements, with number of image-movement per participant ranging between 10–69 ($M=18.1$, $SD=13.9$). Most common were movements from the “pool” (the area where all the images are initially located) to either the single LoS (157, 30% of all shape-movements) or the multiple LoSs (151, 29%) areas. There were relatively high instances of image-movements between the symmetry classification areas, either from the single LoS to the multiple LoSs (114, 22%) or vice versa (84, 16%), and only 18 image-movements (3%) from either of these to the pool area. We documented the following fields for each movement: action ID (across the whole population, to make each movement distinguishable), user ID (so that movements can be linked to the corresponding student), user-action number (count of actions for each user ID), country, object dragged, area from which the object was dragged [pool, single symmetry, multiple symmetries; see figure 1], area in which the object was dropped [pool, single symmetry, multiple symmetries; see figure 1], correct classification [yes, no, N/A (in case of dropping at the pool)]. These fields were used for calculating the variables.

Research Variables

To explore strategies of sorting traffic signs by their LoSs (single vs. multiple), we measured participants' interactions with these images. The following variables were measured for each traffic sign image separately.

Total Moves. Number of steps in which the traffic sign image was dragged.

Correctness on First Attempt [$0=No$, $1=Yes$]. Whether the first classification attempt of a traffic sign image was correct.

Step of First Attempt to Classify. Serial number of the step in which the traffic sign image was first attempted to be classified, whether this attempt was successful or not.

Data Analysis

For answering the research question, we used hierarchical cluster analysis. Using this method, we partition the objects population into groups (clusters) where items in each group are "similar" to each other more than to items in other groups; similarity is based on the values of the research variables. This is a bottom-up, unsupervised method that makes no prior assumptions on the way the data is organized (cf. Kaufman & Rousseeuw, 2009). In our case, each object (traffic sign image) is to be considered as residing in a 3-dimensional space defined by the three research variables; we used Pearson correlation to measure distance between objects in this space. Variables were standardized using Z-scores before clustering. Analysis was conducted in JASP 0.14.

Findings

Characterizing the Classification Process

Examining our participants' interaction with the applet vis-à-vis the three research variables gives us a rich understanding of their behavior. Analyzing our data at the level of the traffic sign images, we may infer not only how difficult they were to classify (i.e., *Correctness on First Attempt*), but also

the way our participants strategized their classification (*Step of First Attempt*) and to what extent they interacted with them later (*Total Moves*).

On average, it was the Road Closed image that was attempted to be classified the earliest (M=3.8, SD=3.9), and Pass This Side was attempted to be classified the latest (M=9.0, SD=4.1). The three images with the highest rate of correctness were Priority Road, Proceed Straight, and No Entrance—all with M=0.83, SD=0.38—and the image with the lowest success rates on first attempt was Yield (M=0.24, SD=0.44). Regarding total moves throughout the applet use, Yield took the highest average (M=2.21, SD=1.89), and No Stopping took the lowest average (M=1.43, SD=0.84). Note that participants were able to move objects as often as they wished. Findings are summarized in Table 1:

Characterization of the traffic sign images' classification (highest value/lowest value of a column)

Table 1 show that extremal values of the research variables *do not* coincide for specific traffic sign images. That is, our data depicts a complex relationship between the research variables, hence we used cluster analysis, which is multivariate by its very nature.











Image	Traffic Sign	Average (SD)			Image	Traffic Sign	Average (SD)		
		Step of First Attempt	Correctness on First Attempt	Total Moves			Step of First Attempt	Correctness on First Attempt	Total Moves
	Priority Road	6.2 (3.1)	<u>0.83 (0.38)</u>	1.83 (1.93)		No Parking	6.9 (3.9)	0.59 (0.50)	2.10 (1.80)
	Proceed Straight	5.5 (3.7)	<u>0.83 (0.38)</u>	1.69 (1.69)		Follow This Way	8.2 (6.1)	0.76 (0.44)	1.59 (1.12)
	Road Closed	3.8 (3.9)	0.79 (0.42)	1.89 (2.13)		No Entrance	7.1 (4.1)	<u>0.83 (0.38)</u>	1.72 (1.44)
	Warning	6.8 (5.0)	0.72 (0.45)	1.93 (2.19)		No Stopping	7.5 (4.2)	0.79 (0.42)	1.43 (0.84)
	Yield	7.5 (5.1)	0.24 (0.44)	<u>2.21 (1.89)</u>		Pass This Side	<u>9.0 (4.1)</u>	0.72 (0.45)	1.79 (1.50)

Table 1: Characterization of the traffic sign images' classification (highest value/lowest value of a column)

Table 1 show that extremal values of the research variables *do not* coincide for specific traffic sign images. That is, our data depicts a complex relationship between the research variables, hence we used cluster analysis, which is multivariate by its very nature.

Cluster Analysis

To define the optimal number of clusters, we used three metrics: AIC (Akaike Information Criterion), BIC (Bayesian Information Criterion), and Silhouette. Note that these metrics are used for model selection, i.e., each of them is useable when there are multiple models to compare. We compared models of 2-5 clusters. AIC and Silhouette values were optimal for a 3-cluster model, while BIC was optimal for a 2-cluster model. After examining these two models, we chose to continue with a 3-cluster model (AIC=28.5, BIC=31.2, Silhouette=0.68), which helped us interpret the results in a more insightful way. Findings are summarized in Table 2.

Cluster A holds three objects: "Priority Road", "Proceed Straight", and "Road Closed". On average, these objects were the easiest to correctly classify, as evident by the cluster mean value and the very low standard deviation of *Correctness of First Attempt* ($M=0.82$, $SD=0.02$); this variable takes its highest value in this cluster. Also, objects in this cluster were attempted to be classified early in the process of using the applet, as evident by the mean value of *First Attempt* ($M=5.2$, $SD=1.2$), which is the smallest across clusters.

Cluster B holds three objects: "Warning", "Give Way", and "No Parking". Although showing a rather high variance, on average, objects in this cluster were the most difficult to correctly classify, as evident by the cluster mean values of *Correctness of First Attempt* ($M=0.52$, $SD=0.2$)—the lowest across clusters—and *Total Moves* ($M=2.1$, $SD=0.1$)—the highest among clusters. These objects were attempted to be classified relatively late while using the applet, as evident by the mean value of *First Attempt* ($M=7.1$, $SD=0.4$).

Cluster C holds four objects: "Follow This Direction", "No Entry", "No Stopping", and "Pass This Side". On average, these objects were attempted to be classified the latest compared with the other clusters, as evident by the value of *First Attempt* ($M=8.0$, $SD=0.8$), however were mostly correctly classified, as evident by the high value and the low dispersion of *Correctness of First Attempt* dispersion ($M=0.78$, $SD=0.05$), and by the fact that *Total Moves* takes the minimal value in this cluster ($M=1.6$, $SD=0.2$).



Cluster	Traffic Signs	First Attempt	Correctness of First Attempt	Total Moves	Interpretation
A		$M=5.2$ ($SD=1.2$)	$M=0.82$ ($SD=0.02$)	$M=1.8$ ($SD=0.1$)	Early attempts to classify, high correctness rate, some attempts
B		$M=7.1$ ($SD=0.4$)	$M=0.52$ ($SD=0.2$)	$M=2.1$ ($SD=0.1$)	Relatively late attempts to classify, low correctness rate, multiple attempts
C		$M=8.0$ ($SD=0.8$)	$M=0.78$ ($SD=0.05$)	$M=1.6$ ($SD=0.2$)	Late attempts to classify, high correctness rate, some attempts

Table 2: Statistics of the research variables for each cluster

Discussion

The question we asked in this study was: *Which clusters of extra-mathematical shapes emerge based on students' sorting patterns?* Data was collected from 29 upper-elementary students from Germany and Israel. All students worked individually in the same digital environment that provided immediate feedback to their attempts to classify traffic sign images as either having one or multiple LoSs.

Three clusters emerged from cluster analysis, based on students' classification behavior. They seem to be spatially linked to the arrangement they are presented in the applet, indicating that the arrangement may have influenced the order in which students engaged with the objects. Looking at the order in which the clusters were sorted, cluster A clearly stands out with being attempted first. Based on the mean values it seems as if cluster B was approached second and C last. Considering the standard deviations, cluster A still stands out, while cluster B and C do not seem to be distinguishable all that well regarding first attempts. This leads to the conclusion that signs from cluster A have been clearly attempted first, with signs from clusters B and C being to a certain extent both secondly with a tendency of signs from cluster C being classified later in the process than the ones from cluster B.

Cluster B stands out (negatively) regarding correctness compared to the other two clusters, which are hardly distinguishable in other variables than First Attempt. As cluster B was not approached first and a learning effect cannot be ruled out while working the task (especially due to the automated feedback), the difference between cluster A and B regarding correctness is to be stressed even more. Classifications of signs from cluster C may have benefited from being classified later in the process, by having classified signs from (at least) cluster A as references. A discussion of criteria possibly influencing students sorting patterns is helpful for understanding how and why these clusters differ.

None of the criteria seems to be dominant, as they seem to be spread out through the clusters (similar inner and outer shape in A and B; (non-)examples of multiple LoSs, basic geometric shapes, inclined LoS in A, B, C). A deeper analysis of the signs however indicates that it indeed seems to be influential.

All signs owning both a horizontal and a vertical LoS, therefore not requiring identification of an inclined LoS for correctly categorizing as multiple LoSs, were amongst the easiest to classify and belong to either cluster A (Priority Road, Road Closed) or C (No Stopping, No Entry) with at least a moderate amount of correctness. On the contrary, signs that required identification of inclined LoS for correct classification (Yield & No Parking sign) were the most difficult to classify and belong to Cluster B. Amongst the criteria discussed in this paper, the orientation of LoSs seems to be the best descriptor explaining difficulty leading to the assumption that horizontal and vertical LoSs are recognized more easily than inclined LoSs.

Taking students intuition into account, cluster A seems to represent Intuitive (non-)examples of extra mathematical objects, as they are categorized not only first, but also with rather high success rates, leading to the conclusion that they were (correctly) accepted as (non-)examples more directly than the signs from the other clusters. This seems to be due to the vertical and horizontal orientation of LoSs. The other end of the spectrum regarding correctness is represented by cluster B with low correctness rates. It also goes along with later and multiple classification attempts and can be referred to as non-intuitive, as their first (intuitive) classification led to a wrong result, making it necessary to reconsider their choice. This seems to be due to the relevance of inclined LoSs. Cluster C that differs mainly from cluster A in that it was approached last, where several signs were already classified correctly. This could be an indication for the notion of Secondary Intuitiveness as this cluster shows lowest count of Total Moves and a rather high correctness rate, which could be the result of either a learning process throughout working the task or recalling further information about reflective symmetry. As we cannot be certain that either of these two conditions is true and that cluster C is merely a result of the arrangement of signs, they might be attributed to the intuitiveness category.

Although faced with a rather small number of participants, our findings suggest that overall students' strategies seem to be: first start off with the easiest subtasks; second analyze harder subtasks, possibly by using the feedback function; third work the remaining subtasks. The information on strategy used by students is of great importance for development of further classification tasks in digital environments. One for creating an elaborate, digital feedback mechanism that goes beyond stating correctness and respond to students' strategies derived from the sorting patterns. In case of participants struggling solving the task by beginning with other than intuitive objects, they can be asked to start with intuitive ones (in our case e.g. Road Closed or Proceed Straight). When recognized

that students seem to struggle with classifying non-intuitive objects hints about possible reasons for that can be provided (e.g. have you considered that lines of symmetry do not have to be either horizontal or vertical?). Beyond deriving information for a feedback-system it can be used for developing intelligent tutoring systems which assign tasks to learners based on previous tasks. Tasks can be assigned as suggested by the clusters and have learners (correctly) classify intuitive (non-) examples first, before going over to correctly (classify) non-intuitive objects and finally sorting secondary intuitive ones. This classification also leaves room for variation in the order of which objects are presented and may increase performance by not sticking to the order learners chose in this study. These are only a few suggestions on how these findings and especially the categorization of (non-)intuitiveness can be used to innovate future development and research of digital environments.

Acknowledgment

We thank the Bavarian Research Alliance for promoting this cooperation through the Bavarian Funding Programme for the Initiation of International Projects (BayIntAn).

References

- Fischbein, H. (2002). *Intuition in Science and Mathematics: An Educational Approach* (1st ed.). New York, Boston, Dordrecht, London, Moscow: Kluwer.
- Hattie, J., & Timperley, H. (2007). The Power of Feedback. *Review of Educational Research*, 77(1), 81–112. <https://doi.org/10.3102/003465430298487>
- Hoyles, C., & Healy, L. (1997). Unfolding Meanings for Reflective Symmetry. *International Journal of Computers for Mathematical Learning*, 2(1), 27–59. <https://doi.org/10.1023/A:1009721414546>
- Kaufman, L., & Rousseeuw, P. J. (2009). *Finding groups in data: An introduction to cluster analysis*. John Wiley & Sons.
- Kuchemann, D. (1980). Children's Difficulties with Single Reflections and Rotations. *Mathematics in School*, 9(2), 12–13.
- Noster, N., Hershkovitz, A., Tabach, M., & Siller, H.□S. (2022). Learners' Strategies in Interactive Sorting Tasks. In I. Hilliger, P. J. Muñoz-Merino, T. De Laet, A. Ortega-Arranz, & T. Farrell: *Educating for a New Future: Making Sense of Technology-Enhanced Learning Adoption (EC-TEL)*. Springer Nature.
- Sweller, J. (2012). Implications of Cognitive Load Theory for Multimedia Learning. In R. Mayer (Ed.), *The Cambridge Handbook of Multimedia Learning* (pp. 19–30). Cambridge University Press. <https://doi.org/10.1017/CBO9780511816819.003>
- Tennyson, R. D., & Park, O.□C. (1980). The Teaching of Concepts: A Review of Instructional Design Research Literature. *Review of Educational Research*, 50(1), 55–70. <https://doi.org/10.3102/00346543050001055>
- Tsamir, P., Tirosh, D., & Levenson, E. (2008). Intuitive nonexamples: the case of triangles. *Educational Studies in Mathematics*, 69(2), 81–95. <https://doi.org/10.1007/s10649-008-9133-5>

Experiences of Mathematics Teachers with the use of GeoGebra Classroom in Remote Teaching during the COVID-19 Pandemic in Austria

Julia Pirklbauer and Robert Weinhandl

Johannes Kepler Universität Linz, Austria; juliaantonia@gmx.at; robert.weinhandl@jku.at

This study aims to find out which aspects of a virtual learning environment could support mathematics teachers in distance learning during the COVID-19 pandemic. We conducted interviews with secondary school and university teachers who worked with GeoGebra Classroom, a virtual learning environment, during distance learning, used qualitative content analysis to get an insight in their experiences. Through using qualitative content analysis, we found out that teachers used GeoGebra Classroom A) as a working tool during distance learning to monitor the students' work in an organized way, and B) to teach remotely in an efficient way, furthermore C) teachers missed opportunities to provide individual feedback and collaborative learning.

Keywords: Distance learning, virtual learning environments, online learning, mathematics education, GeoGebra classroom.

Introduction

In the 21st century, technologies are becoming more and more important and as it is schools' task to prepare children for current challenges and future developments, technologies should be a vital element of teaching (BMB, 2017). Vital skills to be learned at schools are often described as "21st Century Skills". Prominent examples of these skills are for example creativity, critical thinking, social skills, communication, or media and technology literacy. Acquiring these skills should prepare students for today's and tomorrow's labor world (Larson & Miller, 2011). Due to the COVID-19 pandemic and the associated closure of Austrian schools and universities in 2020/21 teachers and students had to rely on digital technologies to communicate with each other and 21st century skills were suddenly no longer a nice to have but required elements to sustain teaching and learning. The sudden reliance on digital technologies faced teachers with challenges (Schrammel et al., 2020; Weinhandl et al., 2021). In this period, we accompanied teachers and conducted interviews to find out which difficulties they experienced and how a virtual learning environment (VLE), like GeoGebra Classroom, can support teachers during distance learning (DL). Thereby, we pursued the following research question:

Which technological features of GeoGebra Classroom, as an example of a virtual learning environment, facilitated teaching mathematics in secondary schools and at university level during pandemic-related distance learning in Austria?

To answer the research questions, we conducted interviews with secondary school and university teachers and analyzed the data using Mayring's (2015) qualitative content analysis.

Theoretical Background

Teaching Math during COVID-19 crisis

In addition to challenges such as social isolation, a lack of equipment and experience, or poor internet connection, teachers report further difficulties at the beginning of the pandemic (Almarashdi & Jarrah, 2021; Azhari & Fajri 2021). Especially for math teachers, the situation of DL was a challenge, as mathematic is an abstract subject that made it difficult for students to understand though online learning. For teaching math, specific characteristics and specials representations like symbols, formulas and graphs are needed. As teachers cannot just write on blackboard, it is not easy to communicate math during DL (Cassibba et al., 2020; Drijvers et al., 2021; Noviani, 2021; Ní Fhloinn & Fitzmaurice, 2021). Fakhrunisa and Prabawanto (2020) examined challenges and opportunities that math teachers perceived during DL. Teachers struggled with selecting a tool which fits their needs and can be reached easily by students. Teachers were not able to monitor students learning motivation, and it was difficult to make accurate assessments of students learning outcomes (Fakhrunisa & Prabawanto, 2020). In our study we aimed to find out, how a freely available VLE, which is especially made for teaching math (e.g., GeoGebra Classroom) can support teachers with the above-mentioned difficulties.

Teachers reported that they missed the opportunity to observe students' work, as they are used to wandering around the classroom. On the one hand, monitoring students' progress is necessary to notice when students are struggling and to warn them when they are in danger to fall behind. Furthermore, teachers cannot see if they are really participating, especially when the camera is turned off. (Niemi & Kousa, 2020; Ní Fhloinn & Fitzmaurice, 2021). On the other hand, teachers can also discover the potential of students while observing their work (Stillman, 2019). According to Ní Fhloinn and Fitzmaurice (2021) another challenge was to conduct classroom discussions, as teachers found it difficult that students explore resources in more depth and to provide feedback in real-time. Furthermore, teachers mentioned that they missed the possibility of doing group-work during DL and that the absence of group-work increased the workload of the teachers (Ní Fhloinn and Fitzmaurice, 2021). Another barrier explored by Noviani (2021) is the fact that students feel ashamed to ask their teacher while DL. To overcome these barriers, we examined teachers' experiences with a VLE that enabled observation of student work in our study.

GeoGebra Classroom as an example of a virtual math learning environment

To face some of these challenges, especially the difficulty that teachers were not able to monitor students' work in real time and to foster classroom discussions, we examined how a VLE could support teachers during DL. First, we want to clarify what we mean with DL, as Phipps & Merisotis (1999) already mentioned that “the technology is evolving, the definition of what DL is continues to change” (p.11). We assume that DL is a way of studying in which students and teachers do not attend the school or university, but study and teach from where they live and communicate over the internet (Dictionary Cambridge, 2022). By a VLE, we mean a web-based system for delivering educational content and enabling communication (Macmillian Dictionary, 2022).

An example of such a VLE is GeoGebra Classroom¹, which facilitates using all GeoGebra apps and other online tools. We choose GeoGebra Classroom for our study, as on the one hand it is a VLE developed for teaching mathematics and on the other hand it makes it easy to communicate math. GeoGebra Classroom is a virtual platform which enables teachers to assign interactive tasks to their students and view their students' progress on specific tasks in real time. All progress will be sent to teachers immediately, so students do not have to upload or submit their work. Teachers see which tasks students have, or have not, started and if they are struggling. By sharing the teacher's screen, rich and interactive discussions can be held with the whole class (GeoGebra, 2022). To determine which technological features of a VLE could be vital for teaching mathematics, we accompanied teachers using GeoGebra Classroom during pandemic-related DL.

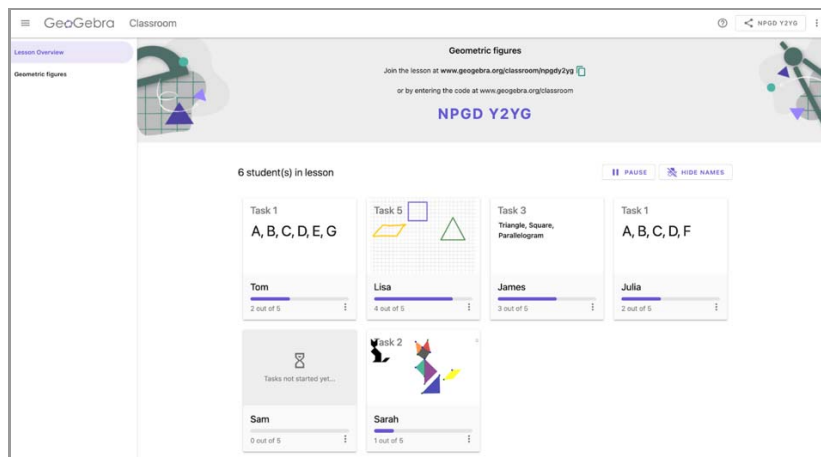

Figure 1: Teacher View in GeoGebra Classroom: Teachers can monitor the students work in real-time
 – Activity: <https://www.geogebra.org/m/uc7gxp8j>

Data Collection and Participants

To obtain data about using GeoGebra Classroom during DL in secondary schools and at university, five interviews were conducted. Due to the COVID-19 situation, we used audio-visual tools for the interviews, which also offered the possibility that interviewees share their screen and show some examples. All interviews were recorded. The interviews were conducted from February 2021 to April 2021. At this time, Austrian schools and universities have been completely closed for two times and were also closed when the interviews were conducted (Weinhandl et al., 2021).

All interviewees had used GeoGebra Classroom in their lessons during DL. Two interviewees are teaching math didactics courses for pre-service teachers at the Johannes Kepler University, and three interviewees are teaching math in secondary schools in urban and rural areas. In terms of professional experience, we selected both teachers who are just beginning their tenure and experienced teachers who are about to retire. So, the interviewees were between the ages of 30 and 60. Of the five teachers in our study, two are women and three are men.

¹ GeoGebra Classroom: <https://www.geogebra.org/classroom>

Particularly, the problem-centered interview was used to collect data. This procedure allows interviewees to speak as freely as possible. Before the interviews were conducted, a guide was created to support the interviewer to monitor that all relevant topics are covered during the interview (Mayring, 2016). The main topics of the interview guide were •) how the VLE was used, •) which features of an VLE could facilitate teaching math and •) which additional features of an VLE are desired by mathematic teachers. The interviews lasted from 14 to 30 minutes (on average 21 minutes).

Data Analysis

As a first step, audio files were transcribed so that the recorded data could be properly processed. During the transcription, the language was smoothed out and transferred to standard German, as interviews were conducted in everyday speech. The qualitative content analysis according to Mayring (2015) was chosen as the evaluation method, as this enables a systematic analysis of the source material. In this way, statements made by interviewed teachers could be structured and summarized. For the interpretation of the data, the summary was chosen as the form of analysis. The aim of this form is to reduce the material and to retain the essential content. A manageable corpus is to be created through abstraction, in which the basic material is nevertheless to be represented (Mayring, 2015).

First the transcripts were openly coded by the authors. In this process, individual coding units which should support answering the research question, were provided with a keyword. A coding unit was any complete statement by a teacher about the experience with the use of GeoGebra Classroom. Thereby a higher level of abstraction and generalizability should be reached. Next, individual coding units from the transcripts were reduced to the essential content for our study by dropping text passages not closely related to our research question. Then, coding units with a higher level of abstraction were combined into categories. Coding units were combined into categories by grouping those units with similar properties regarding our research aim (Mayring, 2015). Up to this point, secondary teacher and university teacher data were treated separately. In the next step, we merged the data, performed further reduction processes as described above, and thereby developed categories with an even higher level of abstraction and generalizability following Mayring's (2015) suggestions for interpreting data.

The goal of qualitative content analysis was achieved after the third reduction process. A large amount of material was reduced to a manageable form, which still ensured the preservation of essential content. Since the categories were derived directly from the source material in a generalization process, this is an inductive category formation (Mayring, 2015).

Results

In the following section, the core categories of our study are outlined in more detail and supported with original quotes from our interviews. The original quotes were translated from German to English. For each quote we provide additional information, whether the interviewee is female (F) or male (M) and whether the teacher is teaching at secondary school (S) or teaching at university (U).

Usage of GeoGebra Classroom as a working tool

GeoGebra Classroom was used by the interviewed teachers in secondary school in mathematics and geometric drawing classes and at the university for mathematics didactic courses for pre-service teachers and teacher training courses for in-service teachers. It was used as a work tool during online

classes and as a homework submission system. *“In the end, I used GeoGebra Classroom in two variants. On the one hand as a homework submission system and on the other hand as a tool during distance learning. From the homework side, I think it was super handy as it just gives me the ability to pause the classroom at a set time, so the students can't continue working.”* (F,U)

Monitor students' work in an organized way

What the teachers liked about GeoGebra Classroom was that they had the opportunity to monitor students' work in real time. Therefore, they were able to give specific feedback and assistance, since even in DL it was immediately apparent where difficulties arose. *“... that I can monitor students, not so much to check them, but rather to help them. Because if I just want to check it, I can simply set a deadline, and then you must hand it in, and theoretically it doesn't matter how you get there. Whereas if I see a student has been struggling for xy minutes now and maybe just going the wrong way or maybe just needs a little nudge to get back in the right direction, I find it very helpful”* (M,S)

The teachers appreciate that they could see the results of all students at a glance. For example, a teacher reported on the use of GeoGebra Classroom when exploring angles: *“I then said, now you all set it to about 30 degrees, and then they had to estimate how big 30 degrees is, and I saw exactly what they do... and that's really something that you can see at a glance, even with 23 children, whether it fits or not. So that was really cool too”* (F,S)

Another secondary school teacher commented positively that this made it easier to understand students' work, for example with homework. The teacher was therefore able to look at students' work afterwards. He also appreciated that GeoGebra Notes², a whiteboard software which can be used in Classroom, allowed students to photograph handwritten notes and submit them in the classroom.

Another advantage mentioned was that students did not have to upload any files, as their work was automatically saved immediately. *“Uploading Excel worksheets to Moodle overwhelms some children in the 5th grade. I don't have the problem in GeoGebra. You have to log in, edit your book and get out afterwards and the book is automatically saved with the latest status, which I consider very positive”* (M,S).

A further benefit is that a sequence could be easily created from several resources: *“On the one hand, you can easily make your own sequence out of several resources. So that I take resources from my colleagues and with just a few clicks I have a sequence on a topic that is now being dealt with”* (M,S)

The pause function was found to be very useful for homework. *“For homework, I think it was super handy as it gives me the ability to pause the classroom at a set time, so the students can't continue working. I can then assess and, after the assessment, activate the course again so that the students can access it again”* (F,U)

Need for opportunities to provide feedback and collaborative learning

Teachers can use GeoGebra Classroom to monitor student work, but they cannot give them individual feedback or intervene in constructions directly in Classroom. For communicating with each other,

² GeoGebra Notes: <https://geogebra.org/notes>

they need to use another platform, like Zoom. It is hard for teachers to only give verbal feedback to their students, therefore teachers miss the possibility to give direct feedback: *“I would like to have the possibility to actively intervene in a construction. So, if a student says: “this doesn't work for me”, I look in and see what's wrong, but I find it very difficult to verbally formulate what the problem is. I would either like to take a red pen and draw on it and say:” look, there's the problem”, or just type it in directly. But then the student would have to see it ... I don't have any possibility to give feedback directly... So, I would like to have some way how I can intervene in the construction, or how I can comment, so that the student can see what I'm talking about right now (F,U).*

Compared to teaching in classroom, teachers also miss the possibility of collaborative learning. Instead of assigning tasks to individual students, they would like to assign them to a group of students, so that they can solve tasks collaborative: *“Group work would be nice at this time. So that children can document solution approaches for tasks together in groups...”(M,S)*

“...that you can do group work assignments, so students get a trickier assignment, or they get the classic type 2 assignments from the last maturity exam, and they solve them together. That I can now say that it is not assigned to one student, but it is assigned to groups, and I can then get in touch with these groups.” (M,S)

In our study, we found further problems, which are briefly described here. The problems that the interviewed teachers had while using GeoGebra Classroom were very technology specific and often not reproducible. In the situation of DL, teachers often did not know if it is a real problem or if the students did something wrong. A secondary school teacher said that he did not let the students create an account at the beginning to avoid an additional registration platform. Once it happened that a student's work progress was not saved. However, it was not clear here either whether the problem was with GeoGebra Classroom or with the student. To be on the safe side, the teacher had the students log in with their Office 365 account the next time they used GeoGebra Classroom. Since then, the teacher has not been able to identify any more issues.

Other issues can be traced back to missing features and bugs. So missed a teacher the possibility of entering Greek letters with the GeoGebra Keyboard in open-ended questions: *“It was all about angles and the students didn't know how to enter alpha, beta, and gamma...” (F,S)*

Discussion

Analyzing our study data indicated that teachers appreciate it that they can monitor students' work in real-time, even when they are physically separated from each other. This is a big advantage of GeoGebra Classroom, because Niemi and Kousa (2020) or Ní Fhloinn and Fitzmaurice (2021) mentioned that not being able to monitor students' work in DL was one of the main difficulties. As Noviani (2021) point out that students feel ashamed to ask their teacher during DL, the real-time synchronization could also avoid this problem. As the teacher can see if a student is struggling, the teacher can get in contact with the student to provide further help, like he would also do in the real classroom. According to Noviani (2021) or Cassibba et al. (2020) communication mathematical language was another challenge for teachers and students during DL. This was mentioned also in our results, as students missed the option to enter Greek letters when answering open questions. The results of our study indicate that teachers wish to be able to do collaborative work with GeoGebra

Classroom and that they miss the possibility to give individual feedback to their students. These findings were supported by the findings of Ní Fhloinn and Fitzmaurice (2021), as they also mentioned that teacher miss these possibilities during DL.

Conclusions and Limitations

The results of our study indicate that GeoGebra Classroom can really help teachers in times of DL, especially for monitoring their students' work in real-time, like they used to do while teaching in the classroom at school. Another benefit was, that all work is saved automatically, so this avoids students having problems with uploading files. In addition to these advantages, our study also produced suggestions for future improvement. We found out, that a VLE should offer the possibility that students can collaborate in groups. Furthermore, there is the need for individual feedback. So, teachers would like to give feedback directly in the VLE without communicating through an additional platform, like it is the case when using GeoGebra Classroom.

The results of our study must always be interpreted restrictively, as the interviewed teachers are experts in using technologies for teaching and learning. Even before the school and university closed and teachers were forced to teach with technologies, the interviewees already used different technologies, and they knew GeoGebra very well. Furthermore, the results of our study should be interpreted having in mind that the results are based on information from five teachers. To sharpen and further elaborate the results of our study, further teachers will be interviewed by us. To be able to generalize the results of our study further, it will also be necessary to conduct interviews with teachers who have less experience in using technologies and GeoGebra. This study had a focus on Austrian teachers, so another possibility for generalization would be an international study, which includes experiences of teachers of other countries as well.

References

- Almarashdi, H. & Jarrah, A. M. (2021). Mathematics Distance Learning amid the COVID-19 Pandemic in the UAE: High School Students' Perspectives. *International Journal of Learning, Teaching and Educational Research*, 20(1), 292–307. <https://doi.org/10.26803/ijlter.20.1.16>
- Azhari, B. & Fajri, I. (2021). Distance learning during the COVID-19 pandemic: School closure in Indonesia. *International Journal of Mathematical Education in Science and Technology*, 1–21. <https://doi.org/10.1080/0020739x.2021.1875072>
- BMB. (2017). *Schule 4.0 – jetzt wird's digital*. Presseunterlage 23.01.2017. <https://docplayer.org/77795654-Schule-4-0-jetzt-wird-s-digital-presseunterlage.html>
- BMBWF. (2020). *8-Punkte-Plan für den digitalen Unterricht*. <https://www.bmbwf.gv.at/Themen/schule/zrp/dibi.html>
- Cassibba, R., Ferrarello, D., Mammana, M. F., Musso, P., Pennisi, M., & Taranto, E. (2020). Teaching mathematics at distance: A challenge for universities. *Education Sciences*, 11(1), 1-20. <http://doi.org/10.3390/educsci11010001>
- Dictionary Cambridge. (2022). *Distance Learning*. <https://dictionary.cambridge.org/dictionary/english/distance-learning>.

- Drijvers, P., Thurm, D., Vandervieren, E., Klinger, M., Moons, F., van der Ree, H., Mol, A., Barzel, B. & Doorman, M. (2021). Distance mathematics teaching in Flanders, Germany, and the Netherlands during COVID-19 lockdown. *Educational Studies in Mathematics*, 108(1–2), 35–64. <https://doi.org/10.1007/s10649-021-10094-5>
- Fakhrunisa, F. & Prabawanto, S. (2020). Online Learning in COVID-19 Pandemic: An Investigation of Mathematics Teachers' Perception. *2020 The 4th International Conference on Education and E-Learning*, 207–213. <https://doi.org/10.1145/3439147.3439179>
- GeoGebra (2022). *Learn GeoGebra Classroom*. <https://www.geogebra.org/m/hncrgruu>
- Larson, L. C. & Miller, T. N. (2011). *21st Century Skills: Prepare Students for the Future*. Kappa Delta Pi Record, 47(3), 121–123. <https://doi.org/10.1080/00228958.2011.10516575>
- Macmillian Dictionary (2022). *Virtual Learning Environment*. <https://www.macmillandictionary.com/dictionary/british/virtual-learning-environment>
- Mayring, P. (2015). *Qualitative Inhaltsanalyse* (12., überarbeitete Auflage). Beltz & Gelberg Verlag.
- Mayring, P. (2016). *Einführung in die qualitative Sozialforschung: Eine Anleitung zu qualitativem Denken* (6. Auflage). Beltz GmbH, Julius.
- Niemi, H. M. & Kousa, P. (2020). A Case Study of Students' and Teachers' Perceptions in a Finnish High School during the COVID Pandemic. *International Journal of Technology in Education and Science*, 4(4), 352–369. <https://doi.org/10.46328/ijtes.v4i4.167>
- Ní Fhloinn, E. & Fitzmaurice, O. (2021). Challenges and Opportunities: Experiences of Mathematics Lecturers Engaged in Emergency Remote Teaching during the COVID-19 Pandemic. *Mathematics*, 9(18). <https://doi.org/10.3390/math9182303>
- Noviani, J. (2021). PERCEPTIONS OF MATHEMATICS EDUCATION STUDENTS TOWARD E-LEARNING DURING THE COVID-19 PANDEMIC. *Kalamatika: Jurnal Pendidikan Matematika*, 6(1), 15–30. <https://doi.org/10.22236/kalamatika.vol6no1.2021pp15-30>
- Phipps, R., & Merisotis, J. (1999). *What's the difference? A review of contemporary research on the effectiveness of distance learning in higher education*. Institute for Higher Education Policy.
- Schrammel, N., Tengler, K., & Brandhofer, G. (2020). *Lernen trotz Corona.Chancen und Herausforderungen des Distance Learnings an österreichischen Schulen*. Open Online Journal for Research and Education, 14, 1–18. <https://journal.ph-noe.ac.at/index.php/resource/article/view/893/907>
- Weinhandl, R., Lavicza, Z., Houghton, T. & Hohenwarter, M. (2021). A look over students' shoulders when learning mathematics in home-schooling. *International Journal of Mathematical Education in Science and Technology*, 1–21. <https://doi.org/10.1080/0020739x.2021.1912423>

Future teachers' appropriation of computer programming as a mathematical instrument and a resource for teaching

Ana Isabel Sacristán¹, Marisol Santacruz-R.², Chantal Buteau³, Joyce Mgombelo³ and Eric Muller³

¹Cinvestav, Mexico; asacrist@cinvestav.mx

²Universidad del Valle, Cali, Colombia; marisol.santacruz@correounivalle.edu.co

³Brock University, Canada; cbuteau@brocku.ca, jmgombelo@brocku.ca, emuller@brocku.ca

The focus of this paper is on how preservice mathematics teachers appropriate computer programming as an instrument for their own mathematical learning and thinking, and for educational resources they create for others. This is part of a 5-year naturalistic on-going research, where we examine how university students use computer programming as a computational thinking instrument for mathematics inquiry, using a mixed methodology and an iterative design approach. We present the phases of instrumental, personal and professional, and documentational geneses that such future teachers go through, and exemplify parts of these through data from the case studies of two students. This work has implications for the design of future professional development programmes for the integration of computer programming in mathematics education.

Keywords: Programming, mathematics, preservice teacher education, instrumental and documentational approaches, naturalistic observation.

Introduction

Computer programming and computational thinking have taken renewed importance in the last decade in education. Many regions, such as some in Canada, now require the teaching of coding or computational thinking in schools, including in mathematics curricula (e.g., Ontario Ministry of Education, 2020). Thus, the importance that future mathematics teachers appropriate programming as an instrument, both for mathematical learning as well as for their teaching practice. However, little research has been done in terms of how to promote such appropriation, particularly in the case of teachers. In this paper we analyse elements of an undergraduate programme where mathematics students, including future mathematics teachers, learn to use computer programming for mathematics inquiry. Our analysis seeks to illustrate the various geneses that future teachers go through in order to appropriate programming and how the design of the university programme promotes those geneses. Such analysis has implications for the design of other professional development programmes.

This analysis is part of a larger five-year, naturalistic (i.e., not design-based), on-going research (see Buteau, Gueudet et al., 2019, Gueudet et al., 2022), which takes place at Brock University (Canada) where students have the option to take a sequence of three one-semester courses called *Mathematics Integrated with Computers and Applications* (MICA) courses. During those courses, mathematics students and future teachers engage in programming and developing interactive microworlds-type objects or environments for investigations of pure and applied mathematical ideas (see Buteau et al., 2016). Our research questions have focused on how students come to appropriate programming as an instrument for mathematical inquiry and on how the MICA learning environment supports the development of students' instrumental geneses.

In our previous research, we have been using the instrumental approach (Rabardel, 2002) to analyse how MICA participants, mainly mathematics majors, appropriate programming as an instrument that they can use for mathematical investigations (Buteau, Gueudet et al., 2019; Gueudet et al., 2022). And in Mgombelo et al. (in press), we presented the case study of a MICA preservice teacher using programming in the design of a learning object to teach a mathematics concept. Here, we build on that work, with the aim of analysing how the MICA program presents opportunities for future teachers to appropriate computer programming both as a personal instrument for their own learning of mathematics as well as a professional resource for mathematics teaching.

Conceptual and theoretical framework

As mentioned, our research uses as framework, the instrumental approach, which has at its core the concept of instrumental genesis: how an artefact becomes an instrument. In instrumental genesis, an instrument is psychologically constructed by attaching to the artefact (mobilized to realize a type of task), schemes that organise the activity of the subject (Trouche, 2004), through the dual processes of instrumentation (how the artefact affects the user) and instrumentalisation (how the user affects the artefact). Students' instrumental geneses can be steered by how a course is orchestrated.

In this paper, the task of analysing the future teachers' knowledge development and work, is more complex, since the instrumental genesis is not just for turning programming into a personal instrument for oneself, but also as an instrument for professional work. Thus, we rely also on two further frameworks that have emerged from the instrumental approach: the double instrumental genesis (Haspekian, 2014); and the documentational approach to didactics (Trouche et al., 2018).

Haspekian (2014) explains that a same artefact –in our case, computer programming– becomes two different instruments for a teacher: a personal instrument for mathematical activity and professional instrument for the teacher's didactical activity. She calls this *double instrumental genesis*, and says:

The *personal instrumental genesis* leads (as for pupils) to the construction and appropriation of a tool into an instrument for mathematical work, and differs from the *professional instrumental genesis*, which leads to the construction and the appropriation of the previous instrument into a didactical instrument for mathematics teaching activity [...] these two geneses are not independent (in some cases [...] this double instrumental genesis may happen simultaneously), neither are they independent of pupils' instrumental geneses. Applying the instrumental approach to the [artefact] seen as a teaching instrument built by the teacher, let's precise the two processes of this professional genesis:

- An instrumentalization process: the tool is instrumentalized by [the] teacher in order to serve her didactic objectives. It is distorted from its initial functions and its didactical potentialities are progressively created (or “discovered” and appropriated in the case of an educational tool).
- An instrumentation process: [the] teacher, as a subject, will have to incorporate in her teaching schemes that were relatively stable some new ones integrating the tool use.

(Haspekian, 2014, p. 98).

Another extension of the instrumental approach, also related to teachers' professional development, is the Documentational Approach to Didactics (Trouche et al., 2018). This approach focuses on how mathematics teachers interact and use resources (including the digital ones), through the design, re-design or 'design-in-use' of resources for their own work and/or the collective work with other

teachers. Resources –which we can think of as “didactic artefacts”–, can be material (e.g., textbooks, digital resources, manipulatives, tasks), social (e.g., forum conversations) and cognitive (e.g., frameworks/theoretical tools used in work with teachers) (Trouche et al., 2018). When teachers interact with resources, they change and develop their professional knowledge; this is called the teacher’s *documentation work*, generated through the dialectic *documentational genesis* process, involving *instrumentalisation* –how resource affordances influence teachers’ practice– and *instrumentation* –the development of schemes of usage of these resources according to the teacher’s instructional needs. Through documentational genesis, a system of resources together with their utilization schemes, becomes a *document*.

Context and methodological aspects

As mentioned above, our research focuses on the teaching and learning that takes place within the MICA programme at Brock University. This programme, launched in 2001, currently consists of three one-semester courses, taken over three years: MICA I, II and III/III* –where III is for mathematics and science majors, and III* is for preservice teachers. During these three courses, students design, program (in VB.Net, Python or, in MICA III*, one in Scratch), implement and test a total of 14 programming-based mathematics investigation projects (4 or 5 in each course) in various topics (e.g., conjectures about primes; stock market analysis; dynamical systems; prey-predator models). Most of these are Exploratory Objects (EOs) –microworld-type interactive and dynamic computer-based models “ developed to explore a mathematical concept or conjecture, or a real-world situation” (Buteau & Muller, 2009, p. 1112). At the end of each term, students, individually or in groups of two or three, develop a final project, for which they select the topic.

In MICA I and II, for their final projects, most students generally have to create an original EO, but, in some cases, they may choose –preservice teachers, in particular– to create, instead of an EO, a Learning Object (LO) to teach a mathematics concept, which may be relevant to their future profession; an LO is defined as “an interactive and dynamic computer-based environment that engages a learner through a game or activity and that guides him/her in a stepwise development towards an understanding of a [school] mathematical concept” (Buteau & Muller, 2009, p. 1112). In MICA III*, the final project consists of developing and, when possible, implementing a teaching resource of programming-based mathematics activities, in accordance with a regional curriculum, for mathematics classrooms, that could be done in collaboration with a teacher and shared in collaborative resource networks (e.g., in <http://mkn-rcm.ca>). □The 2020 MICA III* final project consisted of designing a teaching resource for grade 9 (with each team designing for a different mathematical topic). The design of the teaching resource used as a model the UK’s ScratchMaths (UCL, 2018) curriculum and pedagogy. The aim was for MICA future teachers to develop fluency in Python programming and to put into practice their understandings of learning math through programming. That teaching resource had to include: tasks using Python programming, worksheets in Jupyter Notebook, a short video and follow-up resources for teachers (and optional additional resources, which could be in Scratch), investigate curricular and didactical strategies for their teaching and use their own knowledge about mathematics, programming and teaching to design it.

Although the three-course sequence was initially developed (and implemented) independently from a particular established theoretical framework, as argued in Buteau et al. (2016), it is considered to be framed by a constructionist (Papert, 1991) approach: We consider the EOs created by students to be microworlds and objects-to-think-with (Papert, 1980); furthermore, analyses of the learning environment of the course sequence show an orchestration that promotes students' engagement in constructionist experiences for learning mathematics (Buteau et al., 2016, Sacristán et al., 2020) that may facilitate the appropriation of programming as an instrument for mathematical inquiry.

Our research uses a mixed methodology and an iterative design approach. Over the years, we have collected data from all MICA courses, including course materials (syllabus, assignment guidelines, etc.); students' weekly lab reflections; pre/post-questionnaires; EOs with associated reports; final projects (original EOs or LOs; final MICA III* teaching resource project); and student/instructor semi structured interviews. In addition to that from several MICA I and II courses, we have data from two MICA III* courses (in 2020 and 2022), with detailed data of 7 participants from the first and of 4 from the second (as well as anonymous responses to a questionnaire from larger cohorts). For this paper, we use data from the 2020 MICA III* course; for one MICA III* participant, Kassie (pseudonym), we have analysed also her MICA II data.

Part of our research work has consisted in analysing in detail some students' instrumental geneses, by codifying their responses to the questionnaires and interviews, together with other source material, to analyse in-depth their schemes. We have also analysed the orchestration of the MICA courses (as noted above; e.g., see Sacristán et al., 2020). It is also worth noting that Buteau and Muller (2009) present several development process models (dp-models) of EOs and LOs, which point to some aspects of MICA students' instrumental geneses, as has been discussed in Buteau, Gueudet et al. (2019) and Mgombelo et al. (in press).

Instrumental and documentational geneses in MICA

Whereas some of our previous papers focus on more detailed analyses, in this paper, we attempt to present a broader perspective of the complex geneses (personal, professional and documentational) involved in developing programming –the initial artefact (or resource)– as both a personal instrument for mathematical work, as well as a didactic instrument in the professional teaching activity. The geneses begin with students creating EOs and developing schemes that allow them to appropriate programming as an instrument for mathematical inquiry. Creation of EOs begins in MICA I but continues up to MICA III/III*. Future teachers then develop further their personal and professional geneses by creating LOs. Later, in their design work for the final teaching resources of the MICA III* final project, future teachers learn how to integrate programming with didactic intentions in the design of tasks. In that work, the resource of programming needs to interact with other elements (other resources, that together with programming constitute a system of resources) – a process of documentational genesis. (These processes are schematised in Figure 1).

This resource system is enriched by the constructionist orchestration (Sacristán et al., 2020; Buteau et al., in press; also Buteau, Sacristán & Muller, 2019) offered by the MICA instructor that promotes future geneses: (i) a didactical configuration (based on a previous collective analysis by MICA's instructors –Buteau et al., in press) that centres on selected programming artefacts (e.g.

Python, Scratch, etc.); (ii) an extended didactical configuration that includes assignments and projects to work on collaboratively (with guidelines and lectures on how to design the programming-based teaching resource); and offering the possibility to share MICA III* teaching resources to a professional online network; and (iii) a didactical performance that offers guidance, expert support, discussion sessions, and encouragement to learn as a teacher.

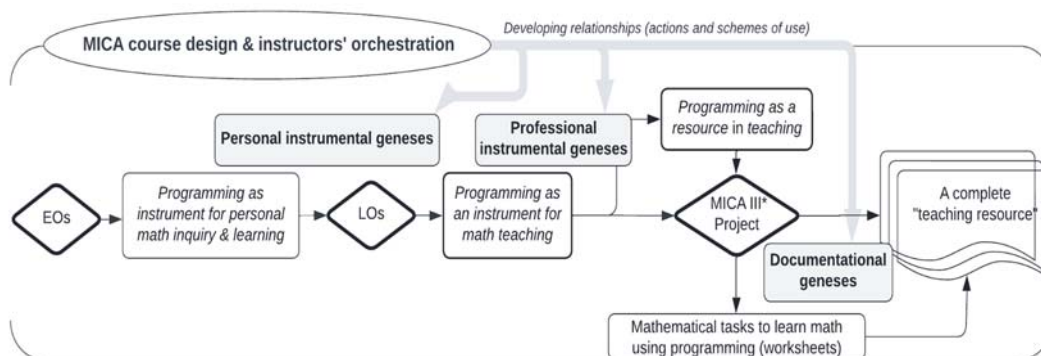

Figure 1. Future teachers' instrumental and documentational genes in the MICA programme

Detailed examples of the various genes of the future teachers, are beyond the scope of this paper, but we exemplify parts of these through data from two students: Kassie and Barbara (pseudonyms).

Personal and professional instrumental genes

Before taking the first MICA course, Kassie had no previous programming knowledge. Through the MICA courses, she not only developed that knowledge, but she developed instrumental schemes relating math and programming (some data illustrating this from Kassie's EOs work in MICA II, is given in Sacristán et al., 2020, and Buteau et al., in press), and later schemes for using programming for teaching math concepts (e.g., a scheme for articulating a learning trajectory in programming language –see Mgombelo et al., in press).

In her personal instrumental genesis (from MICA I to MICA III*), there are two aspects: (i) appropriation of programming as a tool, and (ii) of using programming for mathematics.

In terms of the first, it is interesting how when, in MICA III*, she had to program in Scratch and Python, and she commented that her previous MICA VB.Net programming experience allowed her to “produce a program that works”, although she acknowledged that she also needed to change her perspective (MICA III*, AR1). So, part of a scheme may be: “If I have experience in programming, then it is easier to program (math tasks) in other languages (Python/Scratch).” (This was also found in other students: for instance, Barbara, after recalling her MICA II LO creation, said “*So, we had a lot of VB.net [coding] experience at that point [...] so we didn't struggle that much*” –FI).

In terms of the second, Kassie made reference to the challenges she faced (she wrote: “*connecting what I am programming with the math that is involved in the actual program has been something that is rather difficult*” –MICA III*, AR3). But she explained how, in writing the computer program of an assignment, she had to understand the mathematics and programming concepts and relate them, and how that changed her thinking (“*...the program [...], it teaches you a different way of thinking and allows you to expand your horizons in a subject*” –MICA II; LR1); she later added:

Kassie: ...when working through the program I was able to understand this problem better. This resulted in an increase of my understanding through the program aspect but as well as my math understanding. (MICA III*, AR1).

Also, the reflections promoted by the course orchestration (Trouche, 2004), prompted her to think about how to improve her abilities of programming for mathematics:

Kassie: In regard to the math aspect of programming I want to learn how to question “what if I changed this, what would the result be?” I believe this would further develop my understanding of the problems I am given. (MICA III*, AR3)

At the end of MICA II, Kassie created an LO with her partner for other users to learn about derivative –an interactive tool that would generate random equations and graphs and lead the user to find the derivatives. In Mgombelo et al. (in press), we showed some of Kassie’s instrumented schemes that corresponded to some steps of the development process of an LO and how Kassie developed some schemes, including the above-mentioned one of articulating the learning trajectory in programming language. This illustrated part of her professional geneses. Later, Kassie and her partner designed a teaching resource (for the final MICA III* project) for teaching exponents, that not only included Python tasks, but also Scratch, which shows how she instrumentalised the different programming languages for designing tasks to learn about a mathematics concept.

Documentational genesis in a MICA III* final project

We consider that an extension of the professional genesis, are documentational geneses. Creating LOs already involves a certain degree of documentational genesis. But the final MICA III* project requires deeper interactions of diverse resources and knowledge (including that of programming for math). The orchestration of the project, which has a set of requirements, as outlined above, promotes this. And students respond to those requirements in the “teacher resources” –which are systems of resources with usage schemes, i.e., documents– that they develop for teachers.

Relation Equations and Their Graphs: A Python Exploration -TEACHER RESOURCE-

Programming Knowledge

- It is expected that students have had a basic introduction lesson or tutorial on using Jupyter Notebook
- Most programming done by students is done by example so extensive programming knowledge is not necessary

Learning Objectives

- Envisage** graphical relationships based on numerical data provided
- Explore** the relationships between equations and the shape of their graphs
- Explain** shapes of graphs in terms of linear or nonlinear
- Exchange** techniques and observations of by hand computations and programming based computations

Connections to Ontario Curriculum Expectations

<p>Ontario Curriculum Expectations (MPM1D) Investigating the relationship between the equation of a relation and the shape of its graph</p> <p>Determine, through investigation, the characteristics that distinguish the equation of a straight line from the equations of nonlinear relations (e.g., use a graphing calculator or graphing software to graph a variety of linear and non-linear relations from their equations; classify the relations according to the shapes of their graphs; connect an equation of degree one to a linear relation)</p> <p>Identify, through investigation, the equation of a line in any of the forms $y = mx + b$, $Ax + By + C = 0$, $x = a$, $y = b$</p>	<p>Connection to Relation Equations and Their Graphs: A Python Exploration</p> <ul style="list-style-type: none"> Students are required to build their knowledge of relation equations by investigating graphically and algebraically; Students are required to distinguish the discrepancy between linear and nonlinear relations. Students are required to use their knowledge of linear relations to identify the different forms of an equation of a line visually and numerically.
---	---

Discussion Points

- What did you notice about the graphs of linear relations? What are their characteristics?
- What did you notice about the x and y-values in the corresponding table of values? What did you notice about the graphs of the nonlinear relations? What are their characteristics?
- What did you notice about the x and y-values in the corresponding table of values?
- What did you notice about the graphs of the four different representations of linear equations?
- How did you convert an equation of standard form to slope-intercept form by hand? How did this method differ from using Python?

Teacher Solutions

- Teacher solutions can be found in the file as a separate Jupyter Notebook File called "Relation Equations and Their Graphs -Teacher Solutions"
- Here you will find all code solutions (graphs, tables, etc.) along with some possible student solutions to observation and discussion questions

Things to Note

- Students have tasks to complete under each of the orange headings on the Python worksheet
- Students may have to adjust the boundaries on the graphs in order to properly see their lines
 - The code "plt.xlim(-10,10)" or "plt.ylim(-10,10)" can help students see the graph and lines better (including steepness)
- When graphing lines in Standard Form, Python requires the y to be isolated so the equation is more like slope-intercept form
 - The example shows how to do this
 - Students must do this for the practice question where they are asked to graph $4x + 2y - 14 = 0$
- Simply enter "
" for a line break in Markdown mode on Python
- Students may have to manipulate some code in order to make the results look nicer, but the math and results should all be correct (e.g. they may receive an output of $x = -1$, to which they would have to change the code to just have an output of x)
- Additional resources and information can be found in the Principles of Mathematics 9 textbook (email).

Figure 2. Fragments of Barbara and her partner’s Teacher Resource (MICA III* final project)

For example, Barbara and her partner developed a teacher resource for exploring the relation of equations with their graphs with Python (Figure 2). That resource included the activity summary of

the “Teacher Resource”, together with accompanying self-contained Python worksheets (for students) in Jupyter Notebook (as well as a solution file for the teacher) and additional resources that include the required video, as well as posters, and cards for additional activities. The activity summary begins with the programming knowledge required for students (in this case, the future teachers chose for the programming done by students to be carried out “by example” so that extensive programming knowledge would not be needed, with a code that is re-used and modified); contains clear learning objectives in terms of the math content and alignment to the regional curriculum, as well as “the five Es” of the ScratchMaths pedagogy, activity instructions, discussion points, things to note, etc. Thus, in Barbara’s case, in her documentational genesis, one of her schemes, with the goal (for her teaching resource) of designing math tasks that integrate coding, was based on a previous programming and math (p+m) scheme (Gueudet et al., 2022) developed through her personal instrumental genesis, that now extended to the new situation of designing teaching tasks, which require professional knowledge (e.g., curricular considerations) in interaction with her programming (for math) knowledge.

Concluding remarks

In this paper we have attempted to illustrate how during the MICA activities, future teachers, through a constructionism-based orchestration, have the opportunity to develop both their double instrumental geneses of programming for mathematical investigations, as well as the dual processes of documentational genesis: Their *instrumentalisation* in terms of how programming affordances influence their task design for the programming-based teaching resources that they design, can scaffold other students’ activity. And their *instrumentation* involving usage schemes within the design of the teaching resource; for instance, a usage scheme that guides their task design provides future teachers with the opportunity to interact with a wide and diverse system of resources for their teaching: computer programming, curricular resources, worksheets, specialised software, etc. In this way, we have extended the research presented in our previous papers by analysing the complex geneses involved in teachers’ knowledge development, and illustrate ways for the design of other professional development programmes in the field. Nevertheless, our work continues with more detailed analyses of the data that we have collected.

Acknowledgment

Our research is funded by SSHRC (#435-2017-0367) grant with ethics clearance (REB #17-088).

References

- Buteau, C. & Muller, E. (2010). Student development process of designing and implementing exploratory and learning objects. In V. Durand-Guerrier, S. Soury-Lavergne & F. Arzarello, (Eds.), *Proceedings of CERME 6*, Jan. 28th-Feb. 1st, 2009 (pp. 1111–1120). Lyon, France: INRP. <http://www.inrp.fr/editions/cerme6>
- Buteau, C., Muller, E., Marshall, N., Sacristán, AI., Mgombelo, J. (2016). Undergraduate mathematics students appropriating programming as a tool for modelling, simulation, and visualization: A case study. *Digital Experiences in Mathematics Education*, 2(2), 142–166. <https://doi.org/10.1007/s40751-016-0017-5>

- Buteau, C., Sacristán, A. I. & Muller, E. (2019). Roles and demands in constructionist teaching of computational thinking in university mathematics. *Constructivist Foundations* 14(3): 294–309. <https://constructivist.info/14/3/294>
- Buteau, C., Gueudet, G., Muller, E., Mgombelo, J. & Sacristán, A. I. (2019). University students turning computer programming into an instrument for ‘authentic’ mathematical work. *International Journal of Mathematical Education in Science and Technology*, 1–22. <https://doi.org/10.1080/0020739X.2019.1648892>
- Buteau, C., Muller, E., Santacruz-Rodríguez, M., Mgombelo, J., Sacristán, A., & Gueudet, G. (In Press). Instrumental orchestration of using programming for authentic mathematics investigation projects. In A. Clark-Wilson, O. Robutti, & N. Sinclair (Eds.), *The Mathematics Teacher in the Digital Era* (2nd Edition). Springer Netherlands.
- Gueudet, G., Buteau, C., Muller, E., Mgombelo, J., Sacristán, A. I. & Santacruz-Rodríguez, M. (2022). Development and evolution of instrumented schemes: A case study of learning programming for mathematical investigations. *Educational Studies in Mathematics*, 110(2), 353–377. <https://doi.org/10.1007/s10649-021-10133-1>
- Haspekian, M. (2014). Teachers practices and professional geneses with ICT. *Research Journal of Mathematics and Technology*, 3(1), 96–105.
- Mgombelo, J. Pinar, A., Buteau, C., Muller, E., Sacristán, A. & Santacruz, M. (In press). Pre-service teachers using programming to design learning objects: A case study. *Proceedings. CERME 12, 2 – 6 Feb. 2022*, Bozen-Bolzano, Italy.
- Ontario Ministry of Education (2020). *The Ontario Curriculum Grades 1-8: Mathematics*. Queen's Printer for Ontario. <https://www.dcp.edu.gov.on.ca/en/curriculum/elementary-mathematics/downloads>
- Papert, S. (1980). *Mindstorms: Children, computers, and powerful ideas*. New York, NY: Basic Books.
- Papert, S. (1991). Situating Constructionism. In I. Harel & S. Papert (Eds.), *Constructionism* (pp. 1–12). Norwood, NJ: Ablex Publishing Corporation.
- Rabardel, P. (2002). *Les hommes et les technologies: Approche cognitive des instruments contemporains* [People and technology: A cognitive approach to contemporary instruments]. Paris: Armand Colin. <https://hal.archives-ouvertes.fr/hal-01017462/document>
- Sacristán, A.I., Santacruz-Rodríguez, M., Buteau, C., Mgombelo, J., & Muller, E. (2020). The constructionist nature of an instructor’s instrumental orchestration of programming for mathematics, at university level. In T., Brendan, J.R. Byrne & C. Girvan (Eds.), *Constructionism 2020* (pp. 525–536). TARA. <http://www.tara.tcd.ie/handle/2262/92768>
- Trouche, L., Gueudet, G., & Pepin, B. (2018). Documentational Approach to Didactics. In S. Lerman (Ed.), *Encyclopedia of Mathematics Education* (pp. 1–11). Springer International Publishing. https://doi.org/10.1007/978-3-319-77487-9_100011-1
- Trouche, L. (2004). Managing the complexity of human/machine interactions in computerized learning environments: Guiding students’ command process through instrumental orchestrations. *International Journal of Computers for Mathematical Learning* 9(3), 281–307. <https://doi.org/10.1007/s10758-004-3468-5>
- UCL (2018). *UCL ScratchMaths Curriculum*. IOE, University College London. <https://www.ucl.ac.uk/ioe/research/projects/ucl-scratchmaths/ucl-scratchmaths-curriculum>

Towards a new understanding of ‘agency’ in innovative learning environments

Ulises Salinas-Hernández¹, Birgit Pepin², Ayse Kiliç³ and Zeger-jan Kock⁴

Eindhoven University of Technology, Eindhoven, The Netherlands;

¹u.a.salinas.hernandez@tue.nl, ²b.e.u.pepin@tue.nl, ³a.kilic@tue.nl, ⁴z.d.q.p.kock@tue.nl

In this study we draw on the resources approach in mathematics education and the concept of agency, to develop deeper understandings of university mathematics students’ use of resources in an innovative learning environment. Results show that agency is indeed distributed amongst the students, problem owners, tutors, and resources (e.g., students’ previous knowledge). Moreover, we contend that the agency can be developed and exercises depending on the ‘agentic space’.

Keywords: Agency, innovative learning, learning experiences, resources.

Introduction

The motivation to carry out this research stems from the intention to analyze the relationships between curriculum and innovative learning environments. (1) regarding curriculum Dewey (1938) opposed the idea that the curriculum is a prescription of what learners have to undergo. He argued that learning cannot happen by the external motivation of a prescribed curriculum and the provided resources, but that learning starts with the experiences and interests of the learner and is built up by negotiation (e.g. between teacher and student). (2) Regarding the scope of an environment to shape the self and agency, Radford (2021) notes that “we find ourselves in front of a world with different political, economic, and legal apparatuses and, as a result, with a different *agentic space*” (p. 186). Leaning on these argumentations, we are interested in students’ learning experiences in particular environments [agentic spaces].

Our aim is to investigate how, under which circumstances and in which environments (agentic spaces), ‘agency’ is developed, exercised or ‘negotiated’ (e.g. by students by using particular resources for their learning of mathematics). We are also interested in who are the ‘agents’, which kinds of agency are developed/exercised/negotiated. Hence, our research question (RQ) is the following:

How students’ use of resources and the interaction between the different agents develop agency and help students to solve their mathematics modelling problems?

Theoretical frames

We used two theoretical frames: (a) the ‘lens of resources; and ‘(b) agency’. (a) In terms of the ‘lens of resources’, we draw on Instrumental Approach (IA, Trouche, 2004), to address the question of students’ selection and use of resources. The IA involves the process of instrumentation, where the affordances of resources influence the user/subject’s practice and knowledge; and the process of instrumentalization, where the user/subject adapts the resources to his/her own needs. Moreover, we use the notion of ‘resource/s’ that students have access to and interact with in and for their learning and studying, assuming that the ways students learn mathematics is influenced/shaped by their use of

the various resources at their disposal. As ‘resources’ we include digital curriculum resources (e.g., e-textbooks, e-worksheets), social and cultural resources (e.g., conversations on social media, with tutors, peers and friends), cognitive resources (e.g., concepts and techniques on the web), and general technology resources (e.g., software, internet). (b) In terms of agency, we understand the term ‘agency’ as ‘distributed agency’ (Carlsen et al., 2016), distributed over the different ‘agents’ involved (in the activity): students, teachers, (digital) resources (involved in the learning environment), and the mathematics. We contend that the two theoretical frameworks allow us to answer our RQ as they allow us to understand how the resolution of a mathematical modelling problems involves the interplay between resource affordances and the actual students’ use of resources, and distributed agency among the participants and the resources themselves that influence and shape students' actions and decisions.

Methodology

In this study we used a qualitative case study approach (Cohen et al., 2007). We investigated, at a Dutch university of technology, the learning experiences of applied mathematics students in a master's course: the Modelling week. It is part of a mandatory course in the Applied Mathematics master program on professional skills development.

Modelling week and data collection strategy

The Modelling week allowed students to work for a week (Monday to Friday) on realistic problems proposed by stakeholders from outside the university (problem owners hereafter); these came from regional businesses and industry. As a team, students were expected to propose a solution and recommendations to companies via formulating a mathematical model of the given problem and applying mathematical methods for their solutions. The course consisted of three moments: (1) ‘Kick-off’ (course information and teams set); (2) ‘Lego workshop’ (on team dynamics); and (3) ‘Modelling week’ (students worked on the solution of the problem guided by university tutors and problem owners). The modelling week ended on Friday with the presentation of the results by each team.

The data collection strategies are summarized in Table 1 (below).

Participants	Instrument
Students	Exit Cards, interviews, drawings, and surveys
Tutors	Interviews
Problem owners (PO)	Interviews

Table 1: Instruments for data collection from participants of modelling week

The exit cards were filled out by the students at three different data points (Monday, Wednesday, Friday), and consisted of five questions to be answered by students regarding their: feelings about their work, perceived learnings, and hurdles/difficulties experienced. The interviews were conducted at the end of the week, based on students' drawings of their resource systems (Schematic Representation of Resource system-SRRS; Pepin, et al., 2016). The SRRSs are a schematic representation of how students used and integrated different resources throughout the week. Eight teams of 5-7 students each participated in the course and four of them agreed to participate in our research.

In this paper, we report on results from a team of seven students (S1-7) involved in the problem entitled ‘Design of a cooling plate’, associated with devices that need to maintain an adequate temperature to operate. The PO provided a two-dimensional outline of the cooling plate in which an optimal channel system should be established. According to the objectives of this paper, (1) we identify the different resources mentioned by the students in their SRRS and exit cards, and the ways they were used as part of the interviews; and (2) we analyze the PO and tutor interviews.

Discussion of results and concluding remarks

Due to space limitations, we present the SRRS of one student where we can observe the resources used during the Modelling week; and results from exit cards regarding the interaction of students with some resources, including digital resources.

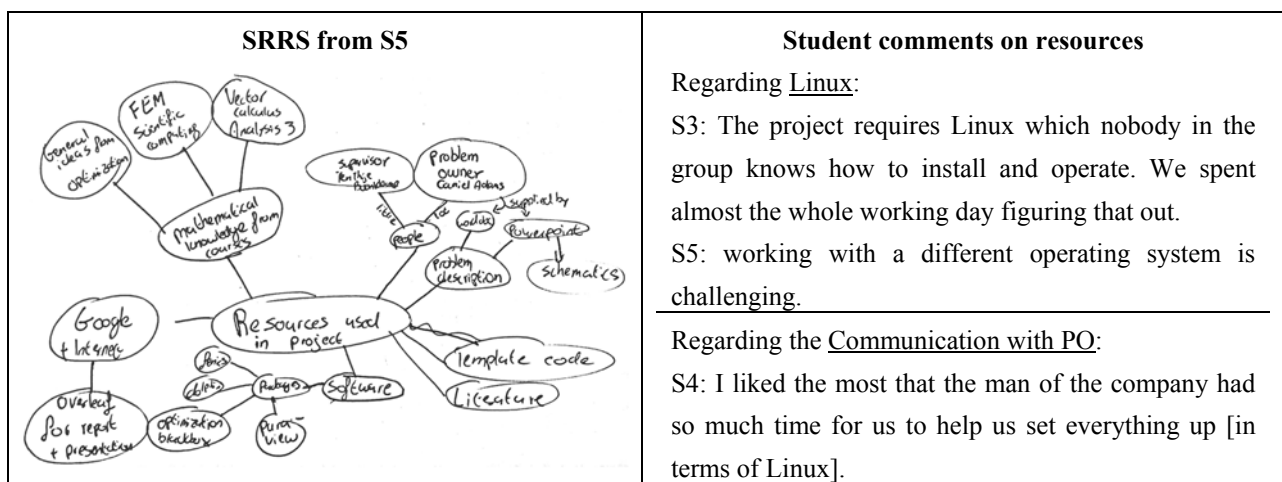

Figure 1: SRRS from S2 (left) and student comments from exit cards (right)

In Figure 1, we observe that S5 grouped the resources used into seven groups. These also include communication with the problem owner and the tutor, mathematical knowledge from previous courses (Vector Calculus), and digital resources (e.g., Internet). The exit cards highlight some difficulties encountered by students at the beginning of the week when using a digital resource: Linux.

On the use of Linux, the problem owner pointed out his reasons for students to use it:

PO: I think it's maybe, at least for mathematicians, it is also good that they have seen Linux some time. Because when they are going to do scripting then they will use it anyway. All companies use Linux when you really do a hardcore scripting or coding, then you should use that.

Some of the guidelines that the PO and the tutor gave to the students are noted in Table 2:

Agent	Guidelines to students
PO	-I provided them with at least two MASH files that they did not have to make that themselves (...) because I think they didn't have just time to make the mashes and do all observations themselves. -Also, the presentation, that was also a bit set up like a tutorial with a lot of text and all the equations in there and also the installations and some links as well. And I provided the task script.
Tutor	-[I said to students] You should work together. You should divide tasks and you should be able to communicate with the problem owner.

	-They had some questions about the mathematical formulations on Tuesday, so they did not understand, and I explained, and I gave them some intuition about the fluid dynamics.
--	--

Table 2: Guidelines to students from two agents: PO and Tutor

Regarding students' use of resources, we observed the instrumentation and instrumentalization processes in two resources: Linux and students' communication with the PO. S3 (Figure 1) states that it was necessary to set up and learn about the use of Linux (instrumentation) to be able to work with it later, according to their own needs, to solve their problem (instrumentalization). On the communication with the PO, S4 points out the help received (instrumentation); and we observe that this communication in turn arises and develops according to the needs of the students, as the tutor also promotes (Table 2). On the development of agency, we observe that (1) human (PO, tutor, and students) and non-human agents (e.g., resources and prior mathematical knowledge) shape students' actions and decisions. This is observed, for example, in the PO's intention for students to use Linux and the subsequent resources it provides (MASH files), in addition to the tutor's guidance.

Answering the RQ the research results show that during the Modeling week for students to solve their mathematics modelling problem, they need, in addition to using various resources, to develop and exercise agency. But this agency does not correspond merely to students' free actions, but is distributed among different agents: students, PO, tutor, digital resources (e.g. Linux) and previous mathematical knowledge. This means that not only persons (e.g. students, problem owners) develop and exercise agency, but also resources can become 'agentic', in particular in 'agentic spaces'.

Acknowledgment

This study was funded by the Innovation Fund of 4TU.CEE at Eindhoven University of Technology. We would like to thank the students, the tutors, and the problem owners for allowing us to conduct the observations and interviews.

References

- Carlsen, M., Erfjord, I., Hundeland, P. S., & Monaghan, J. (2016). Kindergarten teachers' orchestration of mathematical activities afforded by technology: agency and mediation. *Educational Studies in Mathematics*, 93(1), 1–17. <http://www.jstor.org/stable/24830877>
- Cohen, L., Manion, L., & Morrison, K. (2007). *Research methods in education* (6th ed). Routledge.
- Dewey, J. (1938). *Experience in education*. MacMillan.
- Pepin, B., Xu, B., Trouche, L., & Wang, C. (2016). Developing a deeper understanding of mathematics teaching expertise: Chinese mathematics teachers' resource systems as windows into their work and expertise. *Educational studies in Mathematics*, 94(3), 257–274.
- Radford, L. (2021). *The theory of objectification. A Vygotskian perspective on knowing and becoming in mathematics teaching and learning*. Brill/Sense. <https://doi.org/10.1163/9789004459663>
- Trouche, L. (2004). Managing the complexity of human/machine interactions in computerized learning environments. *International Journal of Computers for Mathematical Learning*, 9(3), 281. <https://doi.org/10.1007/s10758-004-3468-5>

What does virtual learning environments afford to mathematics teachers?

Michal Tabach¹ and Jana Trgalova²

¹Tel-Aviv University, School of Education, Tel-Aviv, Israel; tabachm@tauex.tau.ac.il

² Université Claude Bernard, Lyon, France; jana.trgalova@univ-lyon1.fr

There is a rapid growth in the availability of digital platforms specifically designed to allow for mathematical communication between multiple users, to help teaching and learning mathematics. Yet their uptake by mathematics teachers is slow. We seek to explore the affordances of such digital platforms to support mathematics teachers to integrate technology as part of their practice. Specifically, we ask: What are the platforms affordances that may support instrumentation and instrumentalization processes leading to the development of teacher's didactic instrument to plan and enact a mathematical activity in a digital environment? We performed an a priori analysis of STEP and DESMOS platforms attempting to identify their affordances, and found that the platforms afford support to teachers while enacting technology-based mathematics activities. Yet, teachers' ability to make decisions based on data gathered and visualized in dashboard embedded needs to be developed.

Keywords: affordances; learning management systems; teachers' instrumental genesis.

Introduction

The integration of digital technology into everyday school experience in mathematics lessons is still slow (Clark-Wilson, Robutti, & Thomas, 2020). Our previous study highlights that although mathematics teachers use digital technology to search for resources and to plan their lessons, they use it much less in the classroom (Trgalová, & Tabach, 2020). This slow uptake may be due to a gap in teachers' digital competencies (Hegedus et al., 2016). At the same time, there might be a perception of a limited potential afforded by the digital technology to the mathematics teacher.

Norman (2013) used the term *affordances* in the context of Human–Computer Interaction to refer to action possibilities that are readily perceivable by an actor. There is a lack of studies that analyze affordances (and constrains) of digital platforms for mathematics teachers. Research studies focusing on teachers' use of digital technology tend to show an increased complexity of teachers' professional activity, requiring mastering the technology not only for doing mathematics, but also for teaching mathematics (Haspekian, 2011).

We consider specific kinds of technology that provide both a learning environment for students and a system that can support teachers' activity (e.g., planning, monitoring, assessing). We are therefore interested in Virtual Learning Environments (VLE) or Learning Management Systems (LMS) (Borba et al., 2016). Considering this innovative technology, we explore affordances (and constrains) of two platforms specific for mathematics. We also consider the implications of these affordances to the didactic instrument teachers might develop in order to make use of the affordances.

Theoretical background

From a human-computer interaction perspective “An affordance is a relationship between the properties of an object and the capabilities of the agent that determine just how the object could possibly be used” (Norman, 2013, p. 11). Importantly, Norman stresses that an “affordance is not a property. An affordance is a relationship. Whether an affordance exists depends upon the properties of both the object and the agent” (ibid). Hence, while we are studying the affordances of platforms for teaching mathematics, at the same time we envision what the teacher needs to be able to do in order to take benefit from these affordances.

The relational dimension of affordance leads us to choose the instrumental approach as a theoretical framework (Rabardel, 2002). The instrumental approach allows studying processes by which users transform a (digital) tool - an *artefact*, into an *instrument* enabling them to achieve their goals. While the artefact (material or symbolic) is available to the user, the instrument is a personal construct elaborated by the user during her activity with the artefact in the course of the so-called *instrumental genesis*. The process of instrumental genesis comprises two interrelated sub-processes: *instrumentation* leading to the constitution and the evolution of schemes of use of the artefact by the user, and *instrumentalisation* during which the user adapts and personalizes the artefact according to her knowledge and beliefs.

The theoretical construct of *double instrumental genesis* (Haspekian, 2011), developed in line with the instrumental approach, encompasses both the personal and the professional instrumental geneses of teachers who use ICT. Whereas the personal instrumental genesis is related to the development of a teacher’s *personal instrument* for a mathematical activity from a given artefact, the professional instrumental genesis yields a *professional instrument* for a teacher’s didactic activity. This view is resonant with Krumsvik and Jones’s (2013) claim that “digital competence of teachers is more complex than in other occupations” (p. 172) as it embeds ability to (1) use technology (personal use), and (2) use technology in a pedagogical setting (professional use).

To avoid confusion between teacher’s personal and professional activities, we use the term *mathematical instrumental genesis* to refer to teacher’s *personal activities* in relation with their teaching (transforming an artefact into a mathematical instrument, i.e., for doing mathematics with technology), and the term *didactic instrumental genesis* to refer to a teacher’s *professional activities* (transforming the same artefact into a didactic instrument, i.e., for teaching mathematics with technology) (Trgalová, & Tabach, 2020). It is reasonable to assume that these two developmental processes, that is, the mathematical and didactic instrumental geneses, are interconnected. In this paper, we focus on the potential didactic instrumental genesis related to the use of digital platforms.

Being a mathematics teacher includes a number of professional activities, among them lesson planning, enacting, monitoring and assessing students’ activities. Stein, Engle, Smith, and Hughes (2008) aimed at helping teachers to manage instruction based on challenging tasks and students’ suggested solutions. To this end the researchers collect five practices that should be mastered by teachers: anticipating, monitoring, selecting, sequencing, and connecting. The innovative move of Stein et al. was in grouping together these practices as a sequence that together makes the enactment of such instruction more manageable for teachers. *Anticipation*, should be done before the lesson, as

part of the lesson planning. The teacher is invited to anticipate what students might answer, what (mis)conceptions might be expressed in students' work, and what are the teaching goals. The other four practices are enacted during the lesson. *Monitoring* takes place while students work on the chosen challenging task. The teacher observes their actions and as needed provides challenging questions, or help without giving away the procedure that might solve the task. *Selecting* is done in the perspective of a whole class discussion, based on the teacher's observations of students' work while monitoring. The teacher considers which of the solutions she observed to present to the whole class. Next, the teacher needs to consider how to *sequence*, i.e., in which order to present in the whole class discussion the various solutions she selected, to lead the discussion towards the lesson aims. Finally, the teacher needs to *connect* the various solutions among students, and connect them with the lesson aim. Boston and Smith (2011) found connecting to be the hardest practice to enact.

Based on the theoretical framework, we ask: What are the affordances and constraints of the platforms likely to support instrumentation and instrumentalization processes leading to the development of teacher's didactic instrument, to plan and enact a mathematical activity in a digital environment?

Methods

We perform an *a priori* analysis of two platforms specifically designed to support mathematics teaching and learning. We did not observe teachers or students using the platforms, rather, we attempt to identify their affordances in order to understand their potentials and limitations in supporting teachers' instrumental geneses in relation with the five practices, and to infer knowledge and skills mathematics teachers need in order to take benefit from these affordances. This analysis enabled us to foresee the kinds of didactic instruments for mathematics teaching teachers can develop from the platforms.

Method of analysis of virtual learning environments

We assume that platforms as digital artefacts have affordances in the sense that they offer the teacher possibilities for action and interaction. Gueudet et al. (2021) claim that digital education platforms foster specific instrumentation and instrumentalization processes to teachers. The platforms "allow the teacher to design according to his/her pre-existing schemes", which is directly linked to instrumentalization (p. 88). On the other hand,

a platform can structure and support teachers' design practices: through the mathematical content it offers, how the content can be sequenced and through particular features that are offered for the lesson designs. [...] this corresponds to instrumentation processes; its outcome is a modification of the teachers' schemes (ibid.).

Following these authors, we first analyze affordances the platforms offer in terms of potential instrumentation and instrumentalization processes (macro-level analysis). In particular, we are interested in platforms affordances allowing teachers to design their own resources (instrumentalization) and supporting their professional practices (instrumentation).

As we focus more particularly on teachers' planning and enacting a technology-supported mathematical activity in a classroom, referring to the five practices framework leads us to look for a

support the platforms offer to teachers in *anticipating, monitoring, selecting, sequencing* and *connecting*, as described in the theoretical background. Table 1 summarizes our method of analysis.

Table 1. Features of virtual learning environments

Macro-level: Affordances in terms of potential instrumentation and instrumentalization processes	Instrumentation	Affordances likely to make evolve teachers' practices, e.g., differentiation, assessment. Pedagogical principles likely to impact teachers' practices.
	Instrumentalization	Affordances allowing teachers designing resources, either by adapting existing ones or by creating new ones.
Micro-level: Affordances supporting planning and enactment of technology-supported activities	Anticipating	E.g., preview mathematical activities in a students' mode to become aware of the potentialities and constraints of the digital environment in which students will act, suggestion of possible students' answers and description of (mis)conceptions.
	Monitoring	Dashboard features: kind of data provided about (groups of), visualization and interpretation of these data.
	Selecting	Suggestions by the platform of possible answers, correct or not, deemed worthwhile to be addressed in the class.
	Sequencing	Suggestions by the platform of the order of the selected answers in which they should be addressed.
	Connecting	Hints provided by the platform helping teachers link students' strategies and answers with mathematical ideas.

Selection of learning management systems

We chose STEP (Seeing The Entire Picture) and DESMOS. The two platforms afford an interactive environment for students and a support for teachers. The following similar affordances define them as learning management systems: they provide instructors with a way to create and deliver content, monitor student progress and participation, and assess student performance (Borba et al., 2016). *First*, in terms of *organizing*: teachers can create a class, assign students into a class, assign activities to the class, and students can submit their solutions to the system. *Second*, in terms of *creating activities*: the particularities of what information the system needs to be provided with and the specific screens and steps are different, but the teacher can create an activity. *Third*, the platforms include activities to be used and the teacher can *search among the existing activities*: the platforms afford searching based on mathematical topic, and grade level. Each platform might have other unique search fields but these two basic search criteria are common. *Fourth*, in terms of *modifications*: the platforms allow to choose an activity and duplicate it to a particular use, and modify the activity or parts of it. The specific modification options vary between the platforms. *Fifth*, in terms of *following students' progress* along the assigned tasks: the platforms provide the teacher with a dashboard on which she can see for each student at least which tasks she has already done. Becoming familiar with the interface of each platform and mastering its use is part of the didactic instrumental genesis of the teachers. These common affordances are considered at the macro-level analysis; next we highlight the platforms unique affordances in relation with these five aspects. We also provide a brief analysis of both platforms in terms of their affordances supporting the above-mentioned five practices for planning and enacting technology-based activities.

Findings

The STEP platform

STEP was designed by mathematics education researchers from Haifa University and developed by Carmel-Haifa University Economic Corporation Ltd. (Israel). It is

an automatic formative assessment platform in mathematics that helps teachers and students make use of rich and interactive assignments in the classroom in order to empower the teacher's decision making in real time – during the actual course of the lesson¹.

Macro-level analysis. STEP may be used by the teacher for creating assessment activities from scratch. As the STEP platform is built on Geogebra, the teacher needs to create the mathematical situation via Geogebra. The teacher needs to make several decisions along the process of creating a new activity. This is part of the instrumentalization process the teacher is undergoing while creating an activity. The teacher decides on the type of task that is the most relevant to the aims of the assessment. Several types of task can be created: multiple selection items; yes-no questions; provide up to 10 examples of...; provide three examples which fulfill a given set of conditions. While creating an activity the system “walks” the teacher along a sequence of screens. These screens support the design of the activity by the teacher, and are part of the instrumentation process the teacher undergoes. Also, there are existing activities that can be adopted and modified. An activity consists of a sequence of a few tasks. Modifications can be done by removing one or more tasks from the sequence of activities, or modify one or more tasks. Finally, while students are working on a particular activity and submitting parts of it, the platform affords the teacher to follow students' submissions using a dashboard, to analyze these submissions on-line and make decisions on the lesson summary phase.

The DESMOS platform

DESMOS is developed in US by a team of researchers, teachers, software engineers and developers and is available in 18 languages. Besides math software tools such as graphing calculator, scientific calculator or geometry tool to support students' math activity, the platform offers “free digital classroom activities, thoughtfully designed by teachers for teachers to support and celebrate the different ways students come to know mathematics”². These activities are guided by DESMOS “pedagogical philosophy”³ that may have impact on teachers' practices (instrumentation).

Macro-level analysis. The activities provided in the DESMOS platform are guided by DESMOS “pedagogical philosophy”: *Incorporate a variety of verbs* (e.g., not only calculating but also arguing, predicting, comparing, validating) *and nouns* (e.g., not only produce numbers, but also represent them on a number line and write sentences about those numbers); *Ask for informal analysis before formal analysis*, e.g., ask estimation before calculation, sketch before graph, conjecture before proof; *Create an intellectual need for new mathematical skills*; *Create problematic activities*; *Give students opportunities to be right and wrong in different, interesting ways*; *Delay feedback for reflection*,

1 <https://carmel-ltd.haifa.ac.il/index.php/technologies/130-education/mathematics-education/221-step-seeing-the-entire-picture-technology-empowering-formative-mathematics-teaching-in-the-classroom>

2 <https://www.desmos.com/about?lang=en>

3 <https://blog.desmos.com/articles/the-desmos-guide-to-building-great-digital-math/?lang=en>

especially during concept development activities; Connect representations; Create objects that promote mathematical conversations between teachers and students; Create cognitive conflict; Keep expository screens short, focused, and connected to existing student thinking; Integrate strategy and practice; Create activities that are easy to start and difficult to finish; and Ask proxy questions. This set of principles help us understand the nature of the activities in this platform. There is an attempt to move away from drill and practice activities toward encouraging opportunities for conceptual understanding and students’ engagement. From the teacher’s perspective, it seems that the platform encourages teachers to adopt instruction based on students’ mathematical solutions (instrumentation). These solutions are expected to be a starting point for the teacher to make sense of the ways students are thinking.

There is a special website⁴ devoted to helping a teacher learn how to build an activity from the beginning – DESMOS activity builder. An activity can be created by a single teacher or by teams. The site is user-friendly, with short videos and many demonstrations. An important “rule of thumb” is that each screen within the activity will be devoted to one mathematical goal. Creating an activity is part of the instrumentalization process a teacher may undergo while working with the platform.

A comparative micro-level analysis

In Table 2 we summarize affordances STEP and DESMOS offer to teachers in terms of supporting five practices to plan and enact mathematical activities: *italics* highlight indirect affordances; grey cells highlight no affordance.

Table 2. Platforms affordances supporting the five practices

	STEP	DESMOS
Anticipating	Examples of solutions	<i>Prompting during planning (check list)</i>
Monitoring	Correctness of students’ answers (stop light) Access to students’ submissions General class performances Filtering submissions	Correctness of students’ answers (stop light) Individual student performances Aggregated view of the class performance
Selecting	<i>Filtering based on properties</i> <i>Suggestions for discussions</i>	<i>Access to students solutions</i> <i>Recommending to think on it prior to the lesson</i>
Sequencing	No affordance	No affordance
Connecting	<i>Teacher’s guide</i>	<i>Suggesting to think on it before the lesson</i>

Table 2 demonstrates that there is a variety in the platforms affordances to support teacher’s work along the five practices. *Monitoring* is clearly afforded. The platforms provide the teacher with information regarding the correctness of students answers. The support is in the form of indication, mainly color coded, about not-attempted / correct / incorrect response. As one of the roles of teachers is to verify the correctness of student work, this affordance of the platforms takes some of the load off the teacher, allows her to make a better use of her time in class, and supports the monitoring practice. Yet, as noted by Penuel and Shepard (2016), this “stop light” presentation might be an oversimplification of students’ learning. However, DESMOS allows an aggregated view of students’ responses, which provides the teacher with additional valuable information on their students’ actions;

4 <https://learn.desmos.com/create>

STEP platform in addition allows the teacher to filter interactively into the mathematical properties of their students' submissions.

The platforms vary in their affordances for *anticipating* students' answers. While STEP provides examples of possible submissions by students, DESMOS invites the teacher to answer to tasks in the activity using the students' preview, in the form of a check list to do before the lesson, bringing the practice of anticipation into one's mind. The platforms indirectly afford *selecting*. In the STEP platform it is the possibility of filtering students' submissions that might support the teacher in determining which examples to select as a basis for the whole class discussions. DESMOS invites the teacher to think about which productions could be discussed in the whole class while planning.

Sequencing is not supported by the platforms. This practice has to do with the actual submissions of the students in the particular class, and hence this is up to the teacher to consider in a way that leads to the lesson aims. We see the question of how an automatic system can afford help to this important teachers' practice as a challenge for future developments of LMS. Finally, *connecting* is indirectly afforded by the platforms. STEP provides hints for possible connecting actions based on the examples provided as possible answers and a minimal mathematical analysis for each example. The check list provided by DESMOS, specifically the following – “Write a summary of the activity's main ideas: How can you incorporate student work in that summary? What parts of the activity can you skip to ensure there is sufficient time for the summary?” may support teachers in connecting students' answers and the lesson aims.

Concluding remarks

Sinclair and Robutti (2020) brought to the fore two main functions of the use of digital technology, namely “(a) as a support for the organisation of the teacher's work (producing worksheets, keeping grades) and (b) as a support for new ways of doing and representing mathematics” (p. 245). As we show in the presented study, the use of LMS may have a third function: as a support provided to the teacher while enacting technology-based mathematics activities.

Indeed, our analyses of the platforms highlight that teachers' practices related to planning and enacting a technology-based mathematical activity in a classroom can be supported by digital tools to some extent. Yet, the teachers need to be able to take profit from the platform affordances, by enhancing their didactical instrument. Our findings highlight several components of didactic instrumental genesis that mathematics teachers need to develop in order to take benefit from digital platform affordances. These components include the ability to base decision making on data gathered and visualized in dashboard, the decisions pertaining the five practices. In accordance with Hamilton et al.'s (2009) claim that “making sense of data requires concepts, theories, and interpretative frames of reference” (p. 5), we argue that the development of these components needs to be supported in teacher education or professional development programs.

References

Borba, M. C., Askar, P., Engelbrecht, J., Gadanidis, G., Llinares, S., & Aguilar, M. S. (2016). Blended learning, e-learning and mobile learning in mathematics education. *ZDM Mathematics Education*, 48, 589–610. Doi.org/10.1007/s11858-016-0798-4

- Boston, M. D., & Smith, M. S. (2011). A ‘task-centric approach’ to professional development: enhancing and sustaining mathematics teachers’ ability to implement cognitively challenging mathematical tasks. *ZDM, Mathematics Education*, 43(6-7), 965-977.
- Clark-Wilson, A., Robutti, O., & Thomas, M. (2020). Teaching with digital technology. *ZDM Mathematics Education*, 52, 1223–1242. Doi.org/10.1007/s11858-020-01196-0
- Hegedus, S., Laborde, C., Brady, C., Dalton, S., Siller, H. S., Tabach, M., Trgalova, J., & Moreno-Armella, L. (2016). *Uses of technology in upper secondary mathematics education*. Springer.
- Gueudet, G., Pepin, B., Courtney, S., Kock, Z.-J., Misfeldt, M., & Lindenskov Tamborg, A. (2021). Digital platforms for mathematics teacher curriculum design. In A. Clark-Wilson et al. (Eds.), *Mathematics Education in the Digital Age. Learning, Practice and Theory* (pp. 84-98). Routledge.
- Hamilton, L., Halverson, R., Jackson, S. S., Mandinach, E., Supovitz, J. A., Wayman, J. C., ... & Steele, J. L. (2009). *Using student achievement data to support instructional decision making*. Washington, DC: National Center for Education Evaluation and Regional Assistance, Institute of Education Sciences, U.S. Department of Education. Retrieved May 4, 2022 from <http://ies.ed.gov/ncee/wwc/publications/practiceguides/>
- Haspekian, M. (2011). The co-construction of a mathematical and a didactical instrument. In M. Pytlak, E. Swoboda, & T. Rowland (Eds.), *Proceedings of the seventh Congress of the European Society for Research in Mathematics Education. CERME 7*, Rzeszow.
- Krumsvik, R. J., & Jones, L. Ö. (2013). Teachers’ digital competence in upper secondary school. In L. Morris, & C. Tsolakidis (Eds.), *Proceedings of the International Conference on Information Communication Technologies in Education (ICICTE)* (pp. 171-183). Crete.
- Norman, D. (2013). *The Design of Everyday Things Revised and Expanded Edition*. Basic Books.
- Penuel, W. R., & Shepard, L. A. (2016). Social models of learning and assessment. *The handbook of cognition and assessment: Frameworks, methodologies, and applications*, 146-173.
- Rabardel, P. (2002). *People and technology—a cognitive approach to contemporary instruments*. Université Paris 8. Retrieved October 25, 2021 https://hal-univ-paris8.archives-ouvertes.fr/file/index/docid/1020705/filename/people_and_technology.pdf
- Sinclair, N., & Robutti, O. (2020). Teaching practices in digital environments. *Encyclopedia of mathematics education*, 845-849.
- Stein, M. K., Engle, R. A., Smith, M. S., & Hughes, E. K. (2008). Orchestrating productive mathematical discussions: Five practices for helping teachers move beyond show and tell. *Mathematical thinking and learning*, 10(4), 313-340.
- Trgalová, J., & Tabach, M. (2020). Bi-national survey on mathematics teachers’ digital competences. In A. Donevska-Todorova, E. Faggiano, J. Trgalova, Z. Lavicza, R. Weinhandl, A. Clark-Wilson, & H.-G. Weigand (Eds.), *Mathematics Education in the Digital Age* (117-124). Linz, Austria.

3D Printing and GeoGebra as artefacts in the process of studying mathematics through architectural modelling

Mathias Tejera¹, Shereen El Bedewy¹, Gonzalo Galván² and Zsolt Lavicza¹

¹Johannes Kepler University Linz, Austria; mathias.tejera@jku.at,
sheeren_elbedewy@hotmail.com, zsolt.lavicza@jku.at

²Dirección General de Educación Secundaria, Uruguay; profemat.gg@gmail.com

3D printing is a relatively new technology in schools and is becoming popular among teachers and students. Therefore, developing new ways of using this technology in educational settings is needed. In this design-based research, we have developed and tested a process to develop STEAM tasks fostering students' mathematical modelling and problem-solving skills.

Keywords: Mathematical modelling, problem-solving, technology, 3D printing and modelling.

Introduction

In this paper, we share ideas and experiences from our research on using technology as an educational resource. Our goal was to design classroom interventions at the high school level, integrating technology to enable students with new skills and ways of thinking. For this goal, we propose a STEAM teaching approach focusing on architectural modelling and 3D printing.

3D printers are becoming more accessible to schools and are transforming from an emerging technology into reality in a significant number of classrooms all over the world. Therefore, educational researchers must explore this technology's use and propose ways of taking advantage of its possibilities. In that direction, Witzke & Hoffart (2016) presented three ways 3D printing technology is used in Mathematics education. Firstly, using it to reproduce the existing tools for visualisation (Knill & Slavkovsky, 2013). Secondly, for elaborating individualised materials for teachers or students (Lieban et al., 2019). Thirdly, to allow students to model and print objects (El Bedewy et al., 2021a; Tejera et al., 2022). Our proposal is focused on the third use, as it engages students with open-ended modelling tasks.

Our approach for the task design on the modelling process of architectural structures fits mathematical modelling principles, and the tasks can be understood as problem-solving tasks. El Bedewy et al. (2021a) used architectural modelling as a real-life example to foster mathematics learning through problem-solving strategies in a STEAM practice. In that study, the problem-solving approach allowed participants to analyse and model the architectural structures in several ways. Moreover, Donevska-Todoroba & Lieban (2020) explored problem-solving heuristics using digital and 3D printed manipulatives, stating that different tasks produce differences in problem-solving strategies. Furthermore, El Bedewy et al. (2022) used several visualisation tools to allow the 3D transformation process using Augmented Reality and 3D printing. Additionally, Tejera et al. (2022) designed architectural modelling tasks based on mathematical modelling principles showing that the tasks fit the modelling cycle developed by Blum & Leiß (2007).

Methodology

The study was carried out as a cycle of design-based research (Reimann, 2011). Two researchers designed the tasks and structure presented in the *Proposed Work Process* section. We aim to validate and improve the proposed sequence. The tasks were implemented with three groups of high school students in Uruguay (40 students) and one group of high school students in Austria (35 students). We observed the implementation and took field notes in every application of the sequence. The observations were aimed at three elements: The process of technology utilisation, the modelling process, the school content emerging from the modelling process and the interaction with the technological artefacts.

Theoretical Framework

Mathematical modelling principles from Blum & Leiß (2007) and the construct of *Instrumental Genesis* (Rabardel, 1999, 2002; Trouche, 2005) were considered for the task design and the analysis of the students' process. From the Instrumental Genesis theory, we considered *GeoGebra* and *3D printers* as artefacts, which play an essential part in understanding and integrating technology in task design.

Mathematical modelling

Mathematical modelling is “the process of translating between the real world and mathematics in both directions” (Blum & Borromeo, 2009, p.45). We observe these processes through the lenses of the modelling cycle presented by Blum & Leiß (2007), see Figure 1. The framework helped us design the work process and tasks presented to students and analyse their productions as a part of the design cycle. The main reason behind our exceptional attention to modelling processes is that:

Mathematical models and modelling are everywhere around us, often in connection with powerful technological tools. Preparing students for responsible citizenship and for participation in societal developments requires them to build up modelling competency. (Blum & Borromeo, 2009, p.47)

Such modelling could assist students in understanding the world supporting mathematics learning and increase their motivation, concept formation, retention, and contribution to fostering students' mathematical competencies and attitudes. Furthermore, as culture plays a significant role in architecture, we must adopt an approach that considers the *cultural aspects of mathematical modelling* (Villa-Ochoa & Berrío, 2015) because this study was applied in several countries with different teachers and students who considered a wide variety of architectural structures from different regions.

Problem Solving

When referring to problem-solving in this study, we do it in the *wider sense*, as presented in Donevska-Todoroba & Lieban (2020). The three stages of this process are finding the problem, problem-solving (in the traditional way), and further developing the problem. These phases relate to the Blum & Leiß modelling cycle as follows. See Figure 1. *Finding the problem* is present in stages 1, 2 and 3 of the modelling cycle through noticing and simplifying the mathematical objects linked to the architectural structures. *Solving the problem* takes part in phases 3, 4, 5 and 6 when students

participate in the mathematisation, creating and manipulating the mathematical representations to obtain the desired representation of the architectural structure, both in virtual and 3D-printed form. The *solving the problem* phase is also when the use of GeoGebra and the 3D printer takes place, giving place to the instrumental genesis process. For *further developing the problem* part, the cycle stages are 6, 7, 1 and 2, as students explore the results, test them, and post new variations of the problem to improve their models.

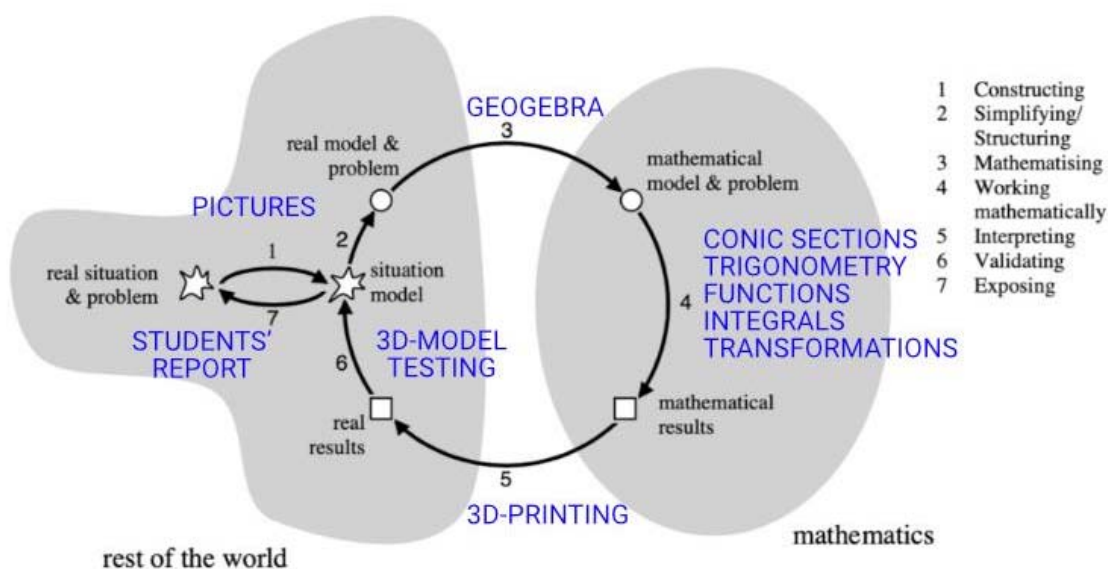

Figure 1: Modelling Cycle seeing through the task

Instrumental Genesis

Instrumental Genesis describes changes in the interaction between a *subject* and an *artefact* as the subject gains experience and practice in using the artefact (Rabardel, 2002). An artefact can be physical or symbolic, as in our case, the commands in GeoGebra software are the symbolic artefact, and the 3D-printer is the physical. The interaction between a subject and an artefact has a physical and a psychological component, for example, in interpreting the information received by the subject and making active decisions on the artefact. Rabardel (1999) introduces of *instrument* to identify the assimilation by the subject of some characteristics of the artefact whose domain allows him to achieve the objective. An instrument is formed by an artefact and by *schemes of use* resulting from the interaction of the subject with the artefact, schemes that may have been elaborated by the subject himself or have been appropriate.

Instrumental genesis has two components: *Instrumentalization* concerns the emergence and evolution of the components of the artefact that are part of the instrument: selection, regrouping, production and institution of functions, the transformation of the artefact into structure and operation and extending the initial conception of the artefacts. *Instrumentation* refers to the emergence and evolution of the schemes of use: their constitution, their operation, their development, and the assimilation of new artefacts to already constituted schemes (Rabardel, 1999, p.9).

In the context of this study, instrumental genesis processes include a variety of elements, among which we focus on handling the GeoGebra's commands necessary to carry out the modelling process and its simplification:

- A necessary command: each command has a certain number of parameters from which it does something, the type and quantity of these parameters for the same command can change depending on the information available; that is, a command admits more than one definition. For example, surface commands has three definitions: Surface(<Expression>, <Expression>, <Expression>, <Parameter Variable 1>, <Start Value>, <End Value>, <Parameter Variable 2>, <Start Value>, <End Value>), Surface(<Function>, <Angle>), Surface(<Curve>, <Angle>, <Line>). This command is necessary for carrying out the modelling process.
- Simplification commands: as some commands perform a single action, such as the symmetry and translation commands, others act in different ways depending on the selected objects, such as the sequence command that allows generating a sequence of constructions that depends on the chosen objects and can even incorporate the use of other commands. We think that these commands could be used as a tool to simplify the modelling process.

Proposed Working Process

The adopted working process applies three main stages that enable us to foster and assess the task outcomes. The process starts with the *teacher's topic introduction*, then the *student-guided work*, and finally, the review of *learning outcomes*. Each stage is divided into smaller tasks that guide us in managing and evaluating the working process. It is vital to share the last part of the task with the students before starting the work process to allow them to begin designing the report and gather all the pieces from the mathematical modelling process, as shown in Figure 2.

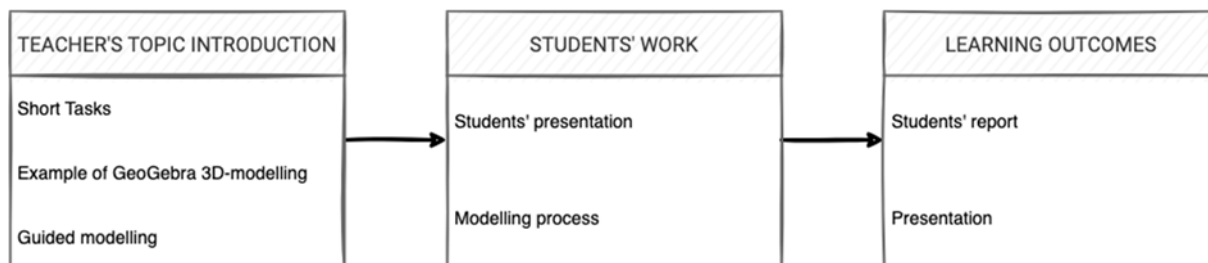

Figure 2: Work process overview

The first part of the working process that includes the Teacher's topic introduction is essential as it consists of a sequence of straightforward tasks such as photos of architectural structures that show mathematical elements. Moreover, this stage includes the questions "What do you notice? What do you wonder?". A proper choice of images can assist students in beginning a dialogue about the factors of interest that may be mathematical, cultural, historical, or architectural, and generates a climate of inquiry withinside the classroom (Rumack & Huinker, 2019). After that, an example of the GeoGebra modelling process must be shown if the group does not have the technical knowledge to perform the task independently.

The second and main stage of the project's working process begins with students bringing ideas to school about what they are interested in for modelling and 3D printing. At this stage, it is essential to give time to students to think and provide their arguments on the relevance of the shape they intend

to model. The students' presentation is a vital moment for the out-of-the-field content to go into the school and enhance the work with knowledge from different disciplines, ways of understanding, and students' abilities. Then the modelling procedure follows the stages of the proposed modelling cycle, as shown in Figure 1.

In this context, often strategic interventions are most adequate, which means interventions which give hints to students on a meta-level ("Imagine the situation!", "What do you aim at?", "How far have you got?", "What is still missing?", "Does this result fit to the real situation?", etc.). (Blum & Borromeo, 2009, p.52)

The final stage of the working process passes in the communication and meta-cognition levels, as in the *develop the problem further* stage (Donevska-Todoroba & Lieban, 2020). Students are requested to arrange and present a document with the architectural structure information, a description of the modelling method used, and reflections on the acquired abilities within the project. The following section displays some examples of the students' work.

Students work

This architectural model is the work process of a 16-year-old student in a vocational school in Austria. The student chose the Pisa tower from Italy as the architectural model to reproduce, studying the cultural and historical aspects of the structure previously. Figure 3 shows the student GeoGebra modelling and the 3D printing of this architectural model.

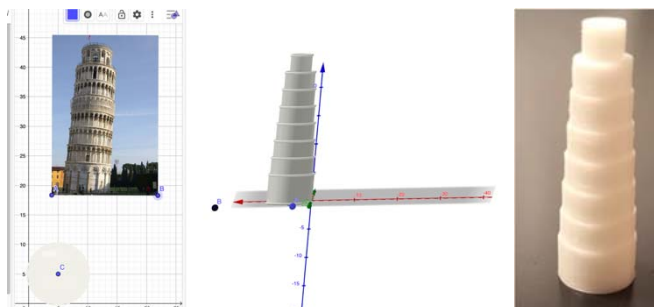

Figure 3: Pisa tower in Italy

The following two examples are from students in Uruguay. The first model is the work of three 17 years old students in the last high school year of the *design and mathematics* path. This group chose the work of the Brazilian architect Oscar Niemeyer and then the Cathedral of Brasilia as the structure to model. As shown in Figure 4, students use GeoGebra commands jointly with complex mathematical concepts to represent the shape of the building and make a 3D printable model. The process of *instrumentalisation* was evident when students started looking for the command needed to generate a revolution surface without knowing about it. Moreover, when they calculated the angles of rotation needed to generate the different building layers through the surface's command, the instrumentation process becomes clear as part of the simplification.

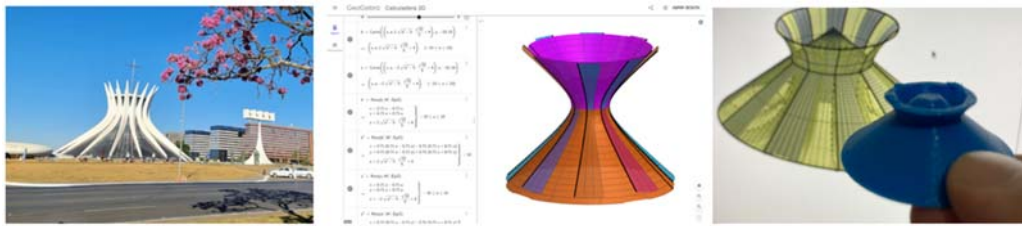

Figure 4: Brasilia's Cathedral in Brazil

Another example from Uruguay is the work of three 15 years old students working in an extracurricular space for mathematics. They completed the task of modelling and printing this astronomical observatory from the fourth century BC in Korea, presented to them as a challenge by the mathematics teacher (El Bedewy et al., 2021b). In Figure 5, the GeoGebra modelling process and the final printed model are presented. In this example, students went further, wondering about the connection between the trigonometric function they used to model the building and the movement of celestial bodies. The situation with this students shows the *development of the problem further* in connection with *interpreting*, *validating*, and *exposing* stages of the modelling cycle and the connection with other subjects outside mathematics.

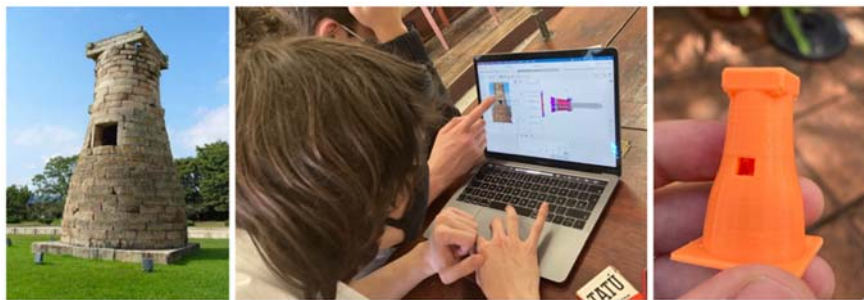

Figure 5: Cheomseongdae in Korea

Discussion and further perspectives

This paper presents a working process to develop architectural modelling tasks in a secondary school setting and the subjacent theoretical framework. We have discussed connections between our proposed process and the modelling cycle, allowing us to consider architectural modelling as a subset of mathematical modelling. The implementation also shows that the selection of GeoGebra as an artefact was proper because the use schemes needed for the task forced the mathematical concepts to emerge in instrumental genesis.

In recent years, words like transdisciplinarity, interdisciplinarity, STEM, and STEAM permeate schools and teaching practices daily. Therefore, contributions to teachers' practices must be made, considering that mathematics does not need to be diluted to be part of these innovations. Our contribution to this matter is a way to teach high-level mathematics integrated with science, engineering, art and culture.

References

- Blum, W., & Borromeo, R. (2009). Mathematical Modelling: Can It Be Taught and Learnt? *Journal of Mathematical Modelling and Application*, 1(1), 45–58.
- Blum, W., & Leiß, D. (2007). How do Students and Teachers Deal with Modelling Problems? In *Mathematical Modelling* (pp. 222–231). Elsevier. <https://doi.org/10.1533/9780857099419.5.221>
- El Bedewy, S., Haas, B., Lavicza, Z. (2022). Architectural Models created with Mixed Reality Technologies towards a new STEAM practice [**Manuscript submitted for publication**]. Dept. of Education, Johannes Kepler University.
- El Bedewy, S., Lavicza, Z., Haas, B., & Lieban, D. (2021a). A STEAM Practice Approach to Integrate Architecture, Culture and History on a Mathematical Problem-Solving Basis. *Education Sciences*, 12(1), 9.
- El Bedewy, S. E., Choi, K., Lavicza, Z., Fenyvesi, K., & Houghton, T. (2021b). STEAM Practices to Explore Ancient Architectures Using Augmented Reality and 3D Printing with GeoGebra. *Open Education Studies*, 3(1), 176–187. <https://doi.org/10.1515/edu-2020-0150>
- Knill, O., & Slavkovsky, E. (2013). Illustrating Mathematics using 3D Printers. *ArXiv.Org*. <https://doi.org/10.48550/arXiv.1306.5599>
- Lieban, D. (2019). *Exploring opportunities for connecting physical and digital resources for mathematics teaching and learning* [Doctoral Thesis]. Johannes Kepler Universität Linz.
- Rabardel, P. (1999). Éléments pour une approche instrumentale en didactique des mathématiques. *Actes de la 10e Université d'Été de Didactique des Mathématiques*, 203–213.
- Rabardel, P. (2002). *Les hommes et les technologies. Une approche cognitive des instruments contemporains*. Paris: Univ. Paris 8. [English translation: Rabardel, P. (2002). *People and technology. A cognitive approach to contemporary instruments*. Paris: Univ. Paris 8]
- Reimann, P. (2011). Design-Based Research. In L. Markauskaite, P. Freebody, & J. Irwin (Eds.), *Methodological Choice and Design: Scholarship, Policy and Practice in Social and Educational Research* (pp. 37–50). Springer Netherlands. https://doi.org/10.1007/978-90-481-8933-5_3
- Rumack, A. M., & Huinker, D. (2019). Capturing Mathematical Curiosity with Notice and Wonder. *Mathematics Teaching in the Middle School*, 24(7), 394–399. <https://doi.org/10.5951/mathteacmidscho.24.7.0394>
- Tejera, M., Aguilar, G., & Lavicza, Z. (2022). Modelling and 3D-printing architectural models—A way to develop STEAM projects for mathematics classrooms. In F. Dilling, F. Pielsticker & I. Witzke (Eds.), *Learning Mathematics in the Context of 3D Printing*. Springer Nature.

- Trouche, L. (2005). Instrumental Genesis, Individual and Social Aspects. In D. Guin, K. Ruthven, & L. Trouche (Eds.), *The Didactical Challenge of Symbolic Calculators* (Vol. 36, pp. 197–230). Springer-Verlag. https://doi.org/10.1007/0-387-23435-7_9
- Villa-Ochoa, J. A., & Berrío, M. J. (2015). Mathematical Modelling and Culture: An Empirical Study. In G. A. Stillman, W. Blum, & M. Salett Biembengut (Eds.), *Mathematical Modelling in Education Research and Practice: Cultural, Social and Cognitive Influences* (pp. 241–250). Springer International Publishing. https://doi.org/10.1007/978-3-319-18272-8_19
- Witzke, I., & Hoffart, E. (2016). *3D-Drucker: Eine Idee für den Mathematikunterricht? Mathematikdidaktische Perspektiven auf ein neues Medium für den Unterricht.*

Engaging with lean Interactive Theorem Prover: Solving a logic task

Athina Thoma¹, Paola Iannone² and Gihan Marasingha³

¹Southampton Education School, United Kingdom; a.thoma@soton.ac.uk

²Loughborough University, United Kingdom; p.iannone@lboro.ac.uk

³Exeter University, United Kingdom; g.marasingha@exeter.ac.uk

In this paper, we report preliminary findings from a pilot study of a first-year mathematics undergraduate student's reasoning when proving tasks with an Interactive Theorem Prover (Lean - <https://leanprover-community.github.io>). Gemma, the participant we discuss in this paper, was interviewed for about one hour via a video conference application. During the interview, she was given a Logic statement and was asked to initially prove it on pen-and-paper and then code the proof in Lean. She was also asked to comment on her engagement with Lean aiming to explore her perceptions of the Interactive Theorem Prover. Our findings show Gemma's perceptions of Lean and its affordances and discuss her interactions with Lean and other resources (e.g., her pen-and-paper proof and Lean notes produced by the lecturer).

Keywords: Interactive theorem prover, Lean, students' reasoning, programming, logic proofs.

Lean theorem prover and related literature

Programming is becoming an essential part of university mathematics. A recent study in the UK discusses the significant increase, observed in the last ten years, in the number of modules that include programming in mathematics degrees (Iannone & Simpson, 2021). However, a study investigating common programming languages taught in UK undergraduate degrees found that commonly used tools were MATLAB and the statistical package R, and that in pure mathematics modules programming was very limited (Sangwin & O'Toole, 2017). Interactive theorem provers have been used in pure mathematics and computer science research since de Bruijn's creation in the late 1960s of the seminal Automath prover (de Bruijn, 1980). However, only recently are they starting to be used in teaching pure mathematics (Avigad, 2019; Thoma & Iannone, 2021). Despite the increased use of programming in university mathematics, further research on the relationship between mathematics learning and programming is still needed (Lockwood & Mørken, 2021).

Lean is an interactive theorem prover which provides instant feedback on the logical coherence of the proof and the symbolisms used. The interface is separated into two sections (see Figure 1 – right hand side B and C). The programming section, where the user writes the code (Figure 1.B), and the feedback section which illustrates the goals at the given line of code and provides feedback via error messages (Figure 1.C). Recent studies on Lean show the potential role that it can play in instruction and the impact it can have on students' mathematical understanding as they focus on the languages at play: natural language, mathematical and programming language (Avigad, 2019). Thoma and Iannone (2021) studied the impact that engaging with Lean may have on students' proof writing. They found that the main differences in the written proofs between Lean users and the non-Lean users were the precise introduction of the mathematical objects involved in the proof, and the often overt breakdown of the proofs in goals. However, the number of students that engaged with Lean in that

project was small and the focus was mainly on the pen-and-paper proofs. In the current study, we investigate further students' engagement with Lean by focusing on students' perceptions and the reasoning skills the students employ when engaging with Lean proofs. Our research questions are: RQ1: What are students' perceptions of the role of Lean in learning mathematics? RQ2: What types of reasoning do students engage with when solving proof tasks with an interactive theorem prover?

Context and methodology

This study took place in the second semester of a first-year undergraduate mathematics module in a UK research-intensive university and was approved by the ethics board of the second authors' institution. The lecturer of the module (the third author of this paper) introduced Lean in the first semester to his students by providing lecture notes on the use of Lean, support material tailored to his module and extra weekly sessions on Lean. The pilot study included a questionnaire (N=43), given to the students during one of the lectures, which asked about their engagement with Lean and invited them to participate in an interview. The subsequent interviews were conducted via video conferencing and they lasted approximately one hour. In this paper, we discuss the case of Gemma (not the participant's real name), one of four students who agreed to be interviewed. During the interview, the students were asked questions regarding their engagement with Lean and the difficulties they had when initially engaging with it. They were then given two tasks and asked to solve them using a think-aloud protocol (Van Someren et al., 1994). In the first task, they were provided with a half-completed proof of the logic statement $((p \vee q) \rightarrow r) \leftrightarrow ((p \rightarrow r) \wedge (q \rightarrow r))$ written in Lean code and they were asked to complete it. For the second task, students were asked initially to prove on a virtual whiteboard the statement: $p \wedge (q \vee r) \leftrightarrow (p \wedge q) \vee (p \wedge r)$ and then prove it in Lean. The interviews were then transcribed and both audio and video data were analysed. An initial analysis showed that Gemma was the only student who consulted many times her pen-and-paper proof while constructing her Lean proof. In this preliminary analysis we focused on identifying instances in the interview where Gemma discussed her perceptions of Lean in terms of proving statements and instances, during the coding process, where she referred to other resources (e.g., her solution on pen-and-paper, her lecturer's notes on Lean).

Preliminary findings and discussion

In her interview, Gemma discusses the affordances of Lean and how it helped to learn about proof:

Gemma: (...) doing the exercises in Lean made me think about the process of proving easier to think about it. It became a lot more, I guess systematic (...) I think the fact that it breaks down after you've done every line, it breaks down what your goal is again and all the hypotheses you've got, I think it made me really bear in mind what I know, what I've got to prove. And it just helped me. Yeah...Go through more systematically I think.

She discusses the affordances of Lean in terms of breaking down the goals (this feature can be seen in Figure 1 – section C). She also notices that for each of the goals Lean also provides the “hypotheses you've got” and how these features allowed her to have a clear image of what is to be proven and what the hypotheses in each of these goals are. It seems Lean provided her with a frame for thinking about proofs in a more structured way.

Also, Gemma discusses the different languages at play, as also noted in Avigad's (2009) study.

Gemma: So when I was doing my proofs initially I was kind of writing them in the way that Lean would write them and then almost translating them back to English.

In the next section, we present Gemma's solution to the second task which she initially wrote on the virtual whiteboard (Figure 1 – section A) and then in Lean (Figure 1 – section B). We observe that her writing on the virtual whiteboard shares similarities with the Lean code and that the assumptions are clearly indicated. Initially (Figure 1 – section A) she breaks the equivalence statement in two implication statements and attempts each one separately. For each of the implication statements she writes her assumptions, indicates how the different hypotheses are connected and how they provide the sub-goals. During the Lean coding process, she refers to her pen-and-paper proof multiple times aiming to identify the next step of the proof. She verifies that Lean accepts her code and is seeking support from her lecturer notes when she is not clear about the syntax of a particular line of code. At one point, Gemma received an error message. In attempting to understand the error, she checked her code initially thinking that there were incomplete brackets after resolving that this was not the case, she then decided to delete all the brackets from her code. This action resulted to a different error message which then triggered another reflection on her code. She returned all the brackets by undoing her previous action and shared the following while double-checking her brackets:

Gemma: So I think when I'm splitting it up into kind of separate subgoals, it's helpful for me to see. (...) it's helpful for me to break it all up. So for example, (...) when I was splitting it into two goals, ohh I wanted then one bracket to be that first goal. And then the second bracket to be the other goal? Ohh it's not because I didn't solve the other. Ohh, that's because I forgot I was too eager, I forgot another goal (...)

During this extra check of the brackets, Gemma identified that she had forgotten one section of her proof and realised that this was the reason she was receiving the error message.

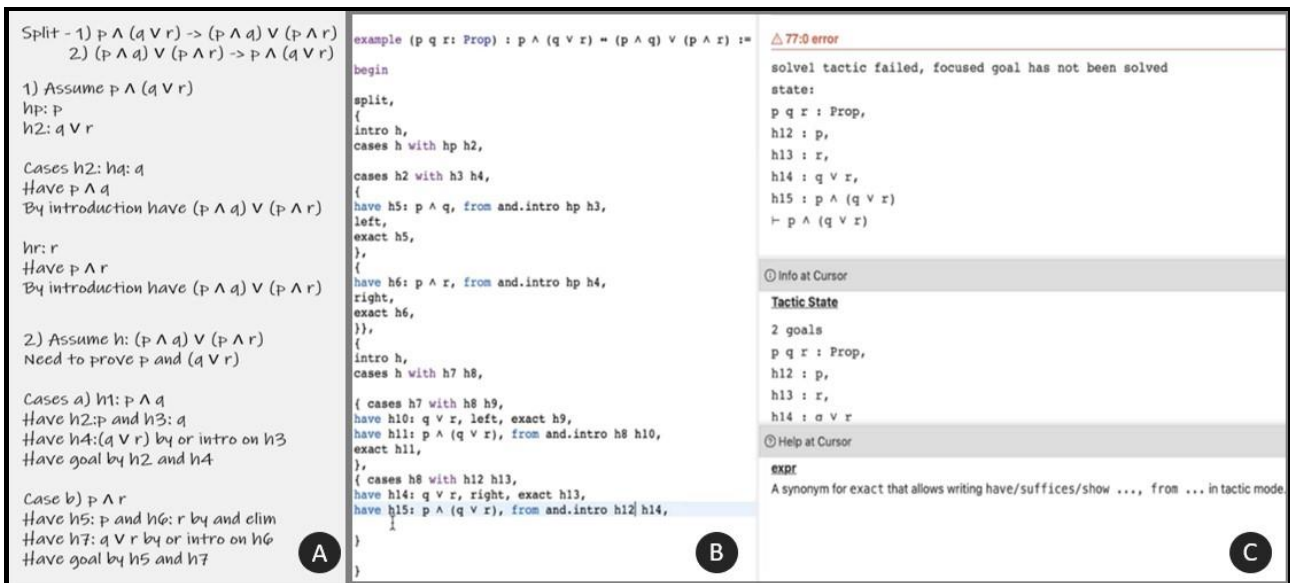

Figure 1: Gemma's solutions. On the left-hand side, Gemma's proof on the virtual whiteboard (section A) and on the right-hand side the Lean coded proof (Sections B and C - Gemma wrote one final line in her proof but here we share a screenshot from the previous line to illustrate the affordances of Lean)

In conclusion, Gemma utilised Lean's features during her proof by engaging with the immediate breakdown of the goals, the hypotheses, the feedback function, and the error messages. These are skills fundamental both to mathematics writing and programming, though in conventional mathematical writing, 'responding to error messages' means engaging with the feedback of a tutor. It is also important to observe that Gemma's pen-and-paper proof is structured in a similar way to that of a Lean proof (e.g., the spacing between the paragraphs which are indicated with brackets in the Lean coded proof) indicating that there is a sort of cross-contamination (if we may call it this way) between the work in Lean and her work on pen-and-paper.

In the next steps of the analysis, we will focus on investigating further the role of Lean in students' proof production and their use of resources when solving Lean proofs, how they engage with their own pen-and-paper proof or the materials provided by their lecturer. Initial analysis of the other students' work on the same task illustrate that other students mainly refer to the feedback they receive from Lean and not much to their pen-and-paper proof. Finally, considering the role of programming and the call for further research on the relationship between mathematics learning and programming (Lockwood & Mørken, 2021) our work aims to investigate further students' reasoning with a programming language which is closely linked to pure mathematics and proof. Students' engagement with Interactive Theorem Provers might have an impact on their epistemologies regarding mathematics and proof. Our future work would seek to provide further insight into these issues.

References

- Avigad, J. (2019). Learning Logic and Proof with an Interactive Theorem Prover. In: G. Hanna, D. Reid, M. de Villiers (Eds), *Proof Technology in Mathematics Research and Teaching. Mathematics Education in the Digital Era* (vol 14, pp. 277-290). Springer.
- Bruijn, de N. G. (1980). A survey of the project Automath. In: J. P. Seldin and J. R. Hindley (eds.), *To H. B. Curry: Essays on Combinatory Logic, Lambda Calculus and Formalism*, p. 579-606. Academic Press Inc.
- Iannone, P., & Simpson, A. (2021). How we assess mathematics degrees: the summative assessment diet a decade on. *Teaching Mathematics and its Applications: An International Journal of the IMA*. Advance online publication. <https://doi.org/10.1093/teamat/hrab007>
- Lockwood, E., & Mørken, K. (2021). A Call for Research that Explores Relationships between Computing and Mathematical Thinking and Activity in RUME. *International Journal of Research in Undergraduate Mathematics Education*, 7(3), 404-416.
- Sangwin, C. J., & O'Toole, C. (2017). Computer programming in the UK undergraduate mathematics curriculum. *International Journal of Mathematical Education in Science and Technology*, 48(8), 1133–1152.
- Thoma, A., & Iannone, P. (2021). Learning about Proof with the Theorem Prover LEAN: the Abundant Numbers Task. *International Journal of Research in Undergraduate Mathematics Education*. Advance online publication. <https://doi.org/10.1007/s40753-021-00140-1>
- Van Someren, M., Barnard, Y. F., & Sandberg, J. (1994). The think aloud method: a practical approach to modelling cognitive. *London: Academic Press, 11*.

Connecting hybrid teaching to hybrid manipulatives by 3D modelling

Eva Ulbrich¹, Shereen ElBedewy², Martin Ertl³, Ingrid Graz⁴ and Zsolt Lavicza⁵

Johannes Kepler University, School of Education, Linz, Austria; ¹eva.ulbrich@gmx.at, ²shereen_elbedewy@hotmail.com, ³martin.ertl@jku.at, ⁴ingrid.graz@jku.at, ⁵lavicza@gmail.com

Hybrid teaching can be challenging due to technological complexity and motivational differences between students attending classes virtually or physically. In hybrid teaching, resources and activities should convey similar content and at the same time motivate students in both setups, however, resources and activities like manipulatives often are optimised for either physical or virtual interactions. By using 3D modelling, we aim to create a hybrid version of manipulatives that can be represented physically and virtually, matching the teaching situation, and offer similar content. In this paper, we outline a workshop, share our experiences, and highlight our design-based research study for such hybrid settings.

Keywords: 3D modelling, augmented reality, 3D printing, geometry, manipulative.

Introduction

When using physical manipulatives and games, students can learn a multitude of skills due to looking at it from different angles (Simon, 2022). However, physical learning resources are not always sufficient for hybrid teaching. Giving resources to students attending class in person and not providing them for those attending virtually leads to different learning experiences and motivation. Emerging technologies can help create virtual and physical manipulative versions that can be used in class and remote. Therefore, we use technologies based on 3D modelling (3DM) for developing manipulative-like resources such as puzzles that can be created by students and visualised virtually by Augmented Reality (AR) or physically by 3D printing (3DP) which gain importance in education (Trust et al., 2021). 3DP and AR have 3DM as prerequisite and have potential assisting in developing and training maths skills, particularly in geometry when working with solids (Ng 2017). They can improve transitions between virtual concepts and physical representations and open possibilities of transporting and visualising mathematics concepts (Lieban et al., 2018; Cahyono et al., 2020;). AR and 3DP can help understanding 2D and 3D projections and switch from digital to physical media which is useful for hybrid teaching (Sholikhah, 2021; Linder et al., 2017). They can help experience concepts such as mirroring, rotation, translation, geometry, or algorithms and support skills like problem solving and critical thinking (Lieban et al., 2018) as they are used to create 3D objects. 3DM followed by AR and 3DP bridges virtual and physical realms and can therefore be subject general and subject specific for cross disciplinarity and hands-on-approaches (Weinhandl et al., 2021).

Students and teachers can profit from integrated multidisciplinary teaching and learning approaches using technologies but despite these potentials, teachers still rarely use them. Teachers had to use technologies during the Covid-19 pandemic to support their lessons, but many educational settings were underprepared for e-learning (Lynch, 2020). Hybrid teaching was described as even more challenging for teachers, one reason was the lack of teaching resources (Tuul, 2022). Switching between dimensions and going from digital to physical can make hybrid teaching situations challenging. We developed a workshop using 3DM to create hybrid manipulatives based on playful interaction in a design-based manner which were tested in hybrid teaching and workshops with pre-

service teachers and collected feedback with questionnaires. This paper outlines connections between technologies, topics in mathematics connected to 3DM, and we highlight the design ideas behind.

Technologies, manipulatives, and connections to hybrid teaching

For teachers to adapt to new technologies, research indicates that the technology and resources for applications need to be available (Holzmann et al., 2018). The technology also needs to be known but a study by Trust et al. (2021) showed that while many teachers are familiar with AR (40%), 3DP is often new (24%). Using technologies in lessons that are not part of everyday teaching processes such as 3DM, AR and 3DP has characteristics of interactive lectures where students solve open questions (Singleton et al., 2020). This, combined with simple exercises to learn 3DM, AR and 3DP, can be useful in hybrid teaching. Since the attention of teachers is often diverted between the two groups of students, technologies like GeoGebra can be used to observe progress, visualise 3D models using AR and provide models usable for 3DP. All students can simultaneously create geometric 3D models with similar support (Lieban & Lavicza, 2019; Haas et al., 2021).

Students are motivated by playing with puzzles and digital games with manipulative like qualities and new technologies can add to the motivation of students (Moral-Sanchez & Cabello-Fortes, 2021). Manipulatives can be physical objects but also virtual as representations on eg. screens (Simon, 2022). Manipulatives can help students to learn about mathematics in a playful way (Ha & Fang, 2013). Before a virtual or physical object can be created, they usually are a virtual 3D idea that can modelled digitally (Lieban et al., 2018). With digital 3DM for virtual AR and physical 3DP, students can combine this and can create their own versions of digital puzzles offering opportunities for game design based on mathematics. The digital, virtual, and physical experience can be useful in hybrid education as all parts of the process from 3DM to AR to 3DP can complement students' experiences.

We propose 3D modelled labyrinths and mazes as puzzles based on mathematical principles which students can create and solve using new technologies for extra motivation and hybrid teaching. Hybrid teachers often utilise concepts such as flipped classroom scenarios where asynchronous teaching happens (Saichaie, 2020). Technology supported hybrid teaching can also be synchronous as many had to teach online and on-site simultaneously during the Covid-19 pandemic (Tuul, 2022). To give both groups adequate attention and learning experiences, resources should be usable in both settings with a similar learning outcome and students' progress should be observable with an available technology known to mathematics teachers. GeoGebra is used by many maths teachers and has a functionality where teachers can observe activities of students (Widada et al., 2021). However, an activity that contains purely virtual manipulatives might not always be the best solution in all settings. Using tactile senses and the body can add to learning experiences (Shvarts et al., 2021).

Mathematical concepts in 3D models

Labyrinths and mazes can be found in architecture, art, as decorations and gardening features, and solving them can be a motivational experience dating back about 4000 years (Saward, 2017). They are usually created based on mathematical principles and algorithmic rules (Fenyvesi et al., 2013). Thompson and Cheng (2015) indicated that creating labyrinths and mazes can help train concepts such as combinatorics, reasoning, or geometrical operations used for spatial thinking. These concepts are part of maths curricula and can be supported by using manipulatives (Simon, 2022). In addition,

students should train spatial orientation and understand the connections between 2D and 3D shapes. They should investigate geometry and quantity theory and concepts such as parallel, intersections, scaling, tilting and angles. These concepts should be developed by students in a playful way by for example creating puzzles or mosaics. Creating mazes requires concepts described in the curriculum like tilting, thinking about symmetries, removing boundaries on surfaces, and thinking about 3D geometry and scaling (Fenyvesi et al., 2013). Creating and modelling a maze puzzle in GeoGebra can help students to learn about the mathematics behind their puzzle ideas and increase their motivations. GeoGebra offers the possibility to observe each student's maze creation with the classroom functionality where a teacher sees both the progress of students in class and at home which helps in hybrid teaching. While creating mosaics might require physical attendance, 3DM and visualising results in AR or 3DP can offer experiences for hybrid teaching. Observing geometrical objects by AR or realising them by 3DP can also be seen as part of a mathematical modelling (MM) process (Ulbrich, 2022). Therefore, this might also strengthen problem-solving skills in maths. The development of technologies requires teachers, amongst fulfilling the role of being a teacher of content, to also use and teach technologies. This generates situations where teachers have new responsibilities when using technologies in their classrooms (Top et al., 2021). A teacher's role is providing content and technology-related knowledge so they should create environments that support technology use (Top et al., 2021). We thought that this exercise might be an activity introducing technology for first steps in 3DM in teacher training courses revolving geometry.

Methodology, methods, and data collection

The initial activity of creating 3DM mazes was created for a science hybrid festival with hundreds of attendees with the idea of making mathematical patterns experienceable. About 120 attendees ranging from 5 to 65 years old tested these pre-modelled labyrinths and mazes at home and on site using mobile devices and inspired us to use the activity as teaching resources. Due to in-service teachers' remarks about the lack of resources for their synchronous hybrid classes, we refined the activity from out of class spaces to fitting classroom settings and hybrid teaching. First, we formalised the activity by creating steps for a workshop from discussion about mathematical features of geometric objects to creating hybrid manipulative which we then tested in online workshops. As we wanted to get feedback on possible use cases and were curious whether the exercise could hold benefits for teachers, we made adaptations for pre-service mathematics teachers (PSMTs). A workshop was created with steps from inspiration by existing labyrinths and mazes to drawing and creating them for AR and 3DP and then discussing and sharing one's maze. We applied design-based research (DBR) principles (Reeves, 2006) and tested in different settings. The workshop was created as mathematics exercise with the curriculum in mind and was refined using feedback and notes we took about our observations and remarks the attendees gave us during and after the activity. The workshop was tested in online workshops, hybrid classes for pre-service teachers (PST) and at presentations where we collected qualitative data by open questionnaires about expectations, possible fields of use, participant's technology use and surprises. Participants filling out the questionnaire were from 16 and 48 years old. First, we conducted online workshops that were attended by a large variety of participants from five to about 40 years to gain a broad view on possible improvements. Groups ranged from five to 20 participants including pupils and in-service and PSTs. Next, we did hybrid classes for PSTs that were

attended by teachers from mostly mathematics. The PSTs attended hybrid workshops embedded in lectures as an introductory exercise. The group sizes reached from 14 to 60 PSTs, depending on the lecture. The initial activity took 20 minutes, emphasising AR while the online workshops took up to two hours because of discussions about mathematical principles due to inspirational pictures of historical labyrinths and focusing on 3DM as well as 3DP. In next iterations, time was reduced to maximum 90 minutes to better fit lectures, participants were asked to develop mazes on pen and paper and GeoGebra Classroom was used to see their progress. We observed that this was also a source for discussing mathematical operations like tilting and scaling when commenting participant's current states of work. Internal discussions about notes from observations and comments from questionnaires helped to find a balance between discussions before and after creating and observing the 3D solids.

As an example, a workshop at a partnering university for one hour with about 13 participants in person and about the same amount online started with introducing connections between mazes and labyrinths and mathematics. Next, we showed a video how we used AR solving mazes. Next, we let participants search for inspirational pictures of existing mazes and encouraged them to discuss their mathematical features. Next, we asked them to first draw and then create their own mazes in 2D and 3D using GeoGebra Classroom. Finally, they used AR to walk through a maze using tablets locally and smartphones remotely. In this instance, 3DP was not possible due to the short time but 3D printed versions of mazes were shown around before sending the link to a questionnaire. We then sat together later discussing our notes and the questionnaire talking about possible changes.

The resulting activity design

Following these ideas, an activity was created that can be used in class, at home, has manipulative like and game features, that inspires to move and can be observed by a teacher using a technology well known by many mathematics teachers. In addition, resources can be created and shared using the activity also enriching it for everyone else by using GeoGebra. 3D models can be created using GeoGebra based on mathematical principles and using mathematical expressions. AR can be used on smartphones and has therefore a high availability. It can be used to visualise existing 3D models created for sharing that can also be downloaded from GeoGebra for 3DP in class or at home.

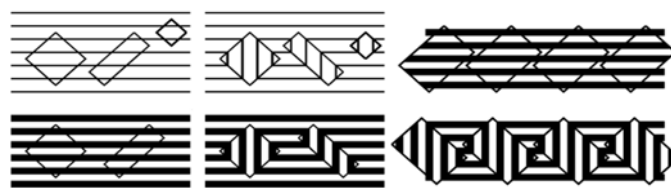

Figure 1: Examples of rectangular and square shapes creating labyrinthic structures by tilting 90 degrees (Reproduced from Fenyvesy, Jablan and Radovic, 2013)

In geometry, students should understand relations of spatial positions and location relations of objects. Concepts such as parallel, intersections, right angles, as well as describing geometric figures by bounding surfaces, edges and corners should be learned. The focus is especially on squares and rectangles, assembling and disassembling them. Fenyvesy et al. (2013) describe how simple mazes can be created by cutting and tilting parallel lines by 90 degrees as seen on Figure 1. Applying this can train geometry concepts. Playful design with solids and surfaces is an activity teachers do in

lectures by eg. folding paper, creating mosaics, drawing symmetrical pictures on grids, investigating edges and forms by performing tilting movements, removing boundary surfaces, and creating symmetrical pictures. Many of these actions can be found in the described exercise which makes it valuable for using with younger children. Another dimension can be added when modelling mazes and investigating them later using AR and 3DP which can train spatial orientation from inside a geometrical object by AR or from the outside as a manipulative in a 3D printed form.

This creates a hybrid form of a manipulative which can be used synchronously by participants that physically and virtually attend a lecture. Students can attend in class or at home, not immersed in a virtual environment and experiencing virtual objects in their surroundings. They can manipulate virtual objects by rotation, scaling, moving in and out as is usual with virtual manipulatives and experience and analyse them (Piekarski & Thomas, 2003). In addition, the 3D models can be turned into physical manipulatives by 3DP which trains skills arching over many subjects and can be seen as part of an MM process (Asempapa & Love, 2021).

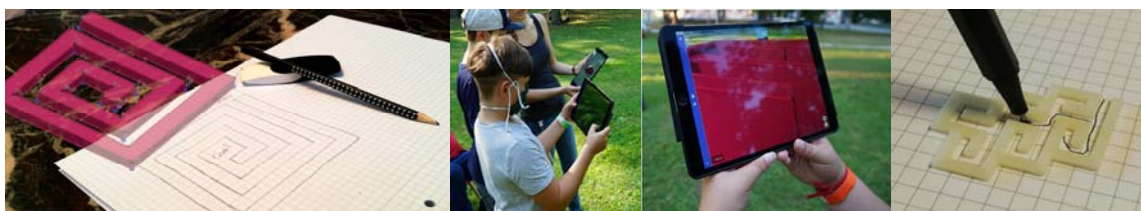

Figure 2: A drawing of a labyrinth and the GeoGebra AR representation

The activity goal was that PSMTs should train their MM and visuospatial skills and learn how to give pupils an introduction to mathematical features of mazes and 3DM lessons in hybrid settings. Inspired by walking through mazes using AR and pictures in art, pupils should start by drawing their maze locally on pen and paper and then create 3D models of them for AR or 3DP as seen in Figure 2.

Results and first findings

In the initial idea, we had 2D and 3D mazes where the 2D mazes were explorable only virtually and the 3D mazes only by AR. We found the activity to be motivating especially for younger children until lower secondary who, in contrast to other attendees, often redid the activity multiple times. Feedback during workshops and from questionnaires gave us the idea that this activity had motivational aspects also contained more potential to train skills connected to geometry and visuospatial orientation within geometrical forms and solids. Therefore, we formalised the activity to a workshop combining 2D and 3D versions of labyrinths and mazes and added 3DM and 3DP as we got feedback that the 3D mazes were more interesting to the attendees of the festival. 3DP was added being shown remotely as we wanted to strengthen the connection to physical manipulatives and searching for images to show and discuss mathematical features. Asked about the participants' expectations in the questionnaire, they said they were interested in learning fun new tools. Remarks ranged from enjoying the combination between history, art and mathematics pointing us towards possible use in lessons to a joyful and motivational way of learning multiple new technologies combined with mathematics. Feedback from attendees was that using mathematics to create puzzles was much fun. They reported that the 3DM part helped them understand the mathematical features. 3DP because of their efforts made attendees proud. The participants engaged in creating mazes and

reported they were inspired to create more mazes and felt more confident with using GeoGebra as a 3DM tool, as well as using these technologies and the exercise in future. The engagement of all participants and the motivation they showed hints to a highly motivational aspect of the workshop. The workshop was then used to introduce PSMTs to 3DM, AR and 3DP in hybrid teaching and as an example they could use for their own teaching. This feedback and other analyses of the data in the future will reveal more connections to mathematics curricula and reactions from pupils will give us ideas on the game qualities combined with mathematically modelling a solid and testing their ideas.

Testing and refining 3D models of solids in an MM manner can be done by either using a mobile device for AR or a 3D printer and then remodel the solid. They can be enlarged to human size by AR to look at it from the inside, solving it as a virtual manipulative or they can be 3D printed to investigate it as a physical version. Finally, pupils should reflect on mathematical concepts they chose by sharing them. Feedback from two PSMTs was that they saw a strong connection towards MM and planned to use the activity with their pupils. Some remarked during lessons they enjoyed connections between scaling and printing time as it shows changes in volume due to operations with vectors. They said they enjoyed thinking about which mathematical operations could be used to create mazes they found beautiful. Our observation was that while students had more fun in creation and exploration of mazes in AR leading to simpler designs, PSMTs were motivated to use many mathematical principles leading to a high complexity and a very long creation time with more focus on developing and creating them using 3DP. We found motivational aspects, connections to geometry by going from 2D to 3D objects, the benefit of having manipulative-like object creation and manipulation and the use of manipulatives in synchronous hybrid lessons with the possibility to observe a student's progress. Moreover, we found that the activity is useful for PSMTs as an introduction to certain technologies and that they as learners themselves feel they better understand certain mathematical principles.

Discussion and future ideas

The created workshop leads to motivation and engagement in hybrid teaching situations by using a playful activity and uncommon technologies. We observed participants in offline, online and hybrid situations finding the use and possible improvements and received feedback in questionnaires about the mathematical concepts used and learnings of participants. The feedback pointed towards a motivational boost and several connections to the mathematics curriculum such as going from 2D forms to 3D forms. Especially the 3D version of mazes led us to develop this further as a hybrid mathematics exercise and refine it with the help of additional feedback. We observed that depending on the age group and teaching situation, the exercise might be presented in varying complexities and with varying emphasis on certain steps. By participants creating their own 3D models, the mathematical complexity is adapted as the mazes can be created either simpler or more complex. The combination of multiple representations with new technologies seemed helpful because especially older participants such as PSMTs learned to use the technologies and use their mathematics skills at the same time. The GeoGebra classroom helps to keep track of how actively engaged participants were and which parts were challenges. The collected data will be processed in more depth exploring which ideas and expectations participants had of connections to the curriculum and analysed more in-depth in the future to find out more about which concepts can be taught.

With more testing we might see which positive learning effects mazes lead to. Using the activity in lessons by the PSMTs can give us data on student's improvements. Improvements of PSMT's MM skills will be explored during lectures about 3DM. We will work on which learning features of mazes and look at how a 3DM maze creation can help with learning goals. Finally, we want to look into which benefits this activity holds for PSMTs apart from learning technologies. We believe that working with 3DM, AR, and printing PSMTs might help develop better MM skills. As 3DP can be seen as part of a MM process, we want to investigate further whether PSMTs profit from this activity.

References

- Asempapa, R. S., & Love, T. S. (2021). Teaching math modeling through 3D printing: Examining the influence of an integrative professional development. *School Science and Mathematics, 121*(2), 85-95. <https://doi.org/10.1111/ssm.12448>
- Cahyono, A.N., Sukestiyarno, Y.L., Asikin, M., Miftahudin, Ahsan, M.G.K., & Ludwig, M. (2020). Learning Mathematical Modelling with Augmented Reality Mobile Math Trails Program: How Can It Work? *Journal on Mathematics Education, 11*(2), 181-192. <http://doi.org/10.22342/jme.11.2.10729.181-192>
- Fenyvesi, K., Jablan, S., & Radovic, L. (2013). Following the Footsteps of Daedalus: Labyrinth Studies Meets Visual Mathematics. *Bridges 2013 proceedings, 361-484*. Enschede, The Netherlands. <http://archive.bridgesmathart.org/2013/bridges2013-361.pdf>
- Ha, O., & Fang, N. (2013). Development of interactive 3D tangible models as teaching aids to improve students' spatial ability in STEM education. *2013 IEEE Frontiers in Education Conference (FIE)*. <https://doi.org/10.1109/fie.2013.6685043>
- Haas, B., Kreis Y., & Lavicza, Z. (2021) Case study on augmented reality, digital and physical modelling with mathematical learning disabilities students in an elementary school in Luxemburg. *The International Journal for Technology in Mathematics Education*.
- Holzmann, P., Schwarz, E. J., & Audretsch, D. B. (2018). Understanding the determinants of novel technology adoption among teachers: The case of 3D printing. *Journal of Technology Transfer, 45*(1), 259-275. <https://doi.org/10.1007/s10961-018-9693-1>
- Lieban, D., Barreto, M. M., Reichenberger S., Lavicza Z., & Schneider R. M. (2018) Developing Mathematical and Technological Competencies of Students Through Remodeling Games and Puzzles. *Bridges Conference Proceedings, 379-382*.
- Lieban, D., & Lavicza, Z. (2019) Dissecting a Cube as a Teaching Strategy for Enhancing Students' Spatial Reasoning: Combining Physical and Digital Resources. *Bridges 2019 proceedings* <https://archive.bridgesmathart.org/2019/bridges2019-319.pdf>.
- Linder, K. E., Bruenjes, L. S., & Smith, S. A. (2017). Hybrid platforms, tools, and resources. *New Directions for Teaching and Learning, 2017*(149), 27-36. <https://doi.org/10.1002/tl.20224>
- Lynch, M. (2020). E-Learning during a global pandemic. *Asian Journal of Distance Education, 15*(1), 189-195.
- Mayhew, M. J., Rockenbach, A. N., Bowman, N. A., Seifert, T. A., & Wolniak, G. C. (2016). *How college affects students: 21st century evidence that higher education works*. John Wiley & Sons.
- Moral-Sanchez, S., & Cabello-Fortes, S. (2021). Manipulative materials and augmented reality: A challenge for the teaching-learning of mathematics in early childhood education. *EDULEARN Proceedings*. <https://doi.org/10.21125/edulearn.2021.2382>

- Ng, O. (2017). Exploring the use of 3D computer-aided design and 3D printing for STEAM learning in mathematics. *Digital Experiences in Mathematics Education*, 3(3), 257-263. <https://doi.org/10.1007/s40751-017-0036-x>
- Reeves, T. C. (2006). Design research from a technology perspective. In J. van den Akker, K. Gravemeijer, S. McKenney, & N. Nieveen (Eds.), *Educational design research*, 52-66, New York, NY: Routledge.
- Rodger, S. H. (1995). An interactive lecture approach to teaching computer science. *ACM SIGCSE Bulletin*, 27(1), 278-282. <https://doi.org/10.1145/199688.199820>
- Saichaie, K. (2020). Blended, flipped, and hybrid learning: Definitions, developments, and directions. *New Directions for Teaching and Learning*, 2020(164), 95-104. <https://doi.org/10.1002/tl.20428>
- Saward, J. (2017). *Mazes or Labyrinths... What's the difference & what types are there?* Labyrinthos. Retrieved 2022, January 19 from <https://labyrinthos.net/Labyrinth%20Typology.pdf>
- Sholikhah, B. U., & Cahyono, A. N. (2021). Augmented reality student worksheets for learning mathematics during the COVID-19 pandemic. *Journal of Physics: Conference Series*, 1918(4), 042063. <https://doi.org/10.1088/1742-6596/1918/4/042063>
- Shvarts, A., Alberto, R., Bakker, A., Doorman, M., & Drijvers, P. (2021). Embodied instrumentation in learning mathematics as the genesis of a body-artifact functional system. *Educational Studies in Mathematics*, 107(3), 447-469. <https://doi.org/10.1007/s10649-021-10053-0>
- Simon, M. A. (2022). Contributions of the learning through activity theoretical framework to understanding and using manipulatives in the learning and teaching of mathematical concepts. *The Journal of Mathematical Behavior*, 66. <https://doi.org/10.1016/j.jmathb.2022.100945>
- Singleton, L., Davishahl, E., & Haskell, T. (2020). Getting your hands dirty in integral calculus. *2020 ASEE Virtual Annual Conference Content Access Proceedings*. <https://doi.org/10.18260/1-2--34707>
- Thompson, D., & Cheng, D. (2015). Square Seeds and Round Paths: Exploring Patterns within the Art of Classical Labyrinths. *Bridges 2015 proceedings: Mathematics, Music, Art, Architecture, Culture, Phoenix, USA*, 555–548. <http://archive.bridgesmathart.org/2015/bridges2015-555.html>.
- Trust, T., Woodruff, N., Checraallah, M., & Whalen, J. (2021). Educators' Interests, Prior Knowledge and Questions Regarding Augmented Reality, Virtual Reality and 3D Printing and Modeling. *TechTrends*, 65(4), 548-561.
- Tuul, M., Fenyvesi, K., Yada, T., Lázár, C., & Ferencz-Salamon, A. (2022). Teaching Practices During the Covid-19 Pandemic in Austria, Estonia, Finland and Romania. In L. Jögi, J. Leoste, S. Vää, M. Tuul, & C. Lazar (Eds.), *A Flexible Framework for Hybrid Lower-Secondary Education: A Vision Book* (pp. 39-43). Tallinna ülikool. <https://free-ed.eu/framework/>
- Ulbrich, E., Haas, B., Andić, B., ElBedewy, S. & Lavicza, Z. (2022) Developing mathematical modelling (MM) skills for mathematics teachers through 3D modelling and 3D printing (3DMP). *CERME 12 proceedings*.
- Weinhandl, R., Houghton, T. & Lavicza, Z. (2021). A case study on learning basic logical competencies when utilising technologies and real-world objects. *Educ Inf Technol* 26, 639–653 (2021). <https://doi.org/10.1007/s10639-020-10282-5>
- Widada, W., Herawaty, D., Nugroho, K. U., & Anggoro, A. F. (2021). Augmented reality assisted by GeoGebra 3-D for geometry learning. *Journal of Physics: Conference Series*, 1731(1), 012034. <https://doi.org/10.1088/1742-6596/1731/1/012034>

Working with a heuristic worked example video – upper secondary students’ perceived advantages and challenges

Laura Wirth¹ and Gilbert Greefrath¹

¹University of Münster, Germany; laura.wirth@uni-muenster.de, greefrath@uni-muenster.de

In this study we developed a heuristic worked example video aiming at enhancing upper secondary students’ modeling competencies based on a theoretically derived framework. The video includes interactive elements such as self-explanation prompts which were implemented using the h5p-plugin in a Moodle-based learning management system. To enable transfer, students solved a related modeling task afterwards. We investigated the perceived advantages and challenges of nine student pairs when working with the video and the modeling task subsequently. A qualitative content analysis revealed that students liked certain design features and the possibility of self-regulating their learning while the latter was also perceived as difficult. Students experienced challenges regarding the duration of the video and the transfer of the content to the subsequent task. The results indicate a great potential of the interactive elements. Also, further ways of improving this kind of video are discussed.

Keywords: Mathematical modeling, interactive video, h5p, heuristic worked examples.

Introduction

Instructional videos are an important medium in the educational context and therefore it is essential to provide carefully designed videos. In order to meet those demands, several frameworks for designing instructional videos have been developed (e.g., Kay, 2014). Due to various advantages of videos, such as the opportunity of dynamic visualizations (Berney & Bétrancourt, 2016), it should also be considered how videos can be used to enhance mathematical learning. One common format employed in mathematics are worked example videos which present a problem and a step-by-step solution (Kay, 2014). In order to make this instructional approach usable for teaching heuristic skills as needed in mathematical modeling, we developed a framework combining recommendations from video and multimedia research (e.g., Fiorella, 2021) with elements of heuristic worked example research (e.g., Reiss & Renkl, 2002). To gain an insight into students’ perception of this kind of video, a heuristic worked example video based on this framework was produced and students were interviewed about their perceived advantages and challenges when working with this video.

Theoretical Background

Instructional videos for teaching mathematics

Producing videos has become easier during the last years and many videos can be found online. A study by Kay and Kletschin (2012) reported undergraduate students’ reasons to watch pre-calculus videos. Due to the visual method of learning, watching videos is easier to follow compared to reading written material. As self-regulation involves learners systematically activating and sustaining their behaviors towards the attainment of their goals (Schunk & Greene, 2018) and videos can be re-watched or paused in contrast to explanations by a teacher, videos offer an opportunity for self-regulated learning. Students like the component of a “student problem” which means that they solve a problem similar to the one in the video while watching it (Kay & Kletschin, 2012). More general, the

opportunity to watch videos anywhere and anytime makes them convenient for studying (Fung et al., 2021). Despite the various reasons to watch videos when learning mathematics mentioned before, students are also confronted with challenges. Students may have difficulties when concepts are explained differently than in class. Moreover, students face problems with the self-regulated use of videos and may watch them only before exams or when the teacher asks them to do so. Students also report issues with a lack of support when watching a video (Fung et al., 2021).

Learning and teaching mathematical modeling

Mathematical modeling can be characterized as the process of translating a real-world problem to a mathematical model and thus using mathematics to solve the real-world problem. It involves steps like structuring information, working mathematically and applying results to the real-world problem (Blum, 2015). As skills in pure mathematics are not sufficient, the process is quite demanding. On the other hand, modeling can be successfully taught and learnt for example through activity rich environments (Niss & Blum, 2020). One instructional approach to teach modeling is having students work with heuristic worked examples. Those usually present a problem and a step-by-step solution while making used heuristics explicit along the way (Reiss & Renkl, 2002). A study by Zöttl et al. (2010) investigated heuristic worked examples in the context of geometric modeling problems in a computer-assisted environment with 8th-graders. Results indicate that this instructional approach enhanced students' modeling competencies. Even though there has been further research regarding heuristic worked examples for teaching modeling, Renkl (2017) still proposes to extend this research.

Heuristic worked example videos for teaching mathematical modeling

In order to combine the potential of instructional videos for learning and the promising approach of heuristic worked examples for teaching modeling, we developed a framework for designing heuristic worked example videos in the domain of modeling (Wirth, in press). In the beginning, the problem is presented through real-world scenes and thereby may provide an authentic task context (Greefrath & Vos, 2021). The *segmentation* of the video using a solution plan supports the step-by-step explanation of the solution. Furthermore, integrated breaks after each step allow to include *self-explanation prompts*, asking students to connect what they have seen to prior knowledge and to clarify open issues. Prompts are also included within the video to let students anticipate the next step. If students anticipate the next step correctly, students are given the opportunity to skip instructional explanations. This design feature aims at avoiding the expertise reversal effect which states that learning can be hindered if students are confronted with unnecessary explanations (Kalyuga, 2021). Follow-up learning tasks make the video part of a *larger concept*. By explaining *heuristic strategies*, it is intended to give an insight into problem-solving methods. *Layout decisions* are based upon design principles for multimedia learning with instructional video (Fiorella, 2021) and, for example, include dynamic drawings. A *conversational language* aims at keeping students engaged. As little is known about using videos to enhance a demanding competency like modeling, this study focuses on students' perception of this certain type of video. Due to the design, the mathematical content and the real-world context of this type of video, there may be different or further perceived advantages and challenges than the above-described. Thus, we decided to focus on the following **research questions**:

1. What are the perceived advantages when students work with a heuristic worked example video on a modeling problem and solve a related task afterwards?
2. What are the perceived challenges when students work with a heuristic worked example video on a modeling problem and solve a related task afterwards?

Method

Sample

To answer the research questions, we conducted a study with 9 pairs of students (11 female, 7 male) from upper secondary schools in Germany between the age of 15 and 20 ($M = 17.17$, $SD = 1.25$).

Procedure and Instruments

We used a qualitative design to collect data. A heuristic worked example video was designed according to the above-described criteria. The video is 29 minutes and 32 seconds long. Implementing the video into a Moodle-based learning management system using the software *h5p* enabled the following interactive design features: Pausing, rewinding, fast-forwarding, system-integrated pauses, self-explanation prompts, skipping explanations at certain points, a table of content displaying the different segments and corresponding bookmarks in order to switch between segments. In the instruction at the beginning, students were informed about the procedure and were made familiar with the interactive design features. Students worked with the heuristic worked example video which included the *lifeguard task* (see Figure 1). As a component of the larger concept, students solved a modeling task afterwards. To enable transfer, the modeling task and the task in the video differed in context and had slightly different mathematical models but both located in the domain of optimization problems. Students worked in pairs in order to enhance communication. They were allowed to revert to the video while solving the task. Afterwards, each pair of students was interviewed regarding their perceived advantages and challenges when working with the video and the task afterwards. The whole session was videotaped.

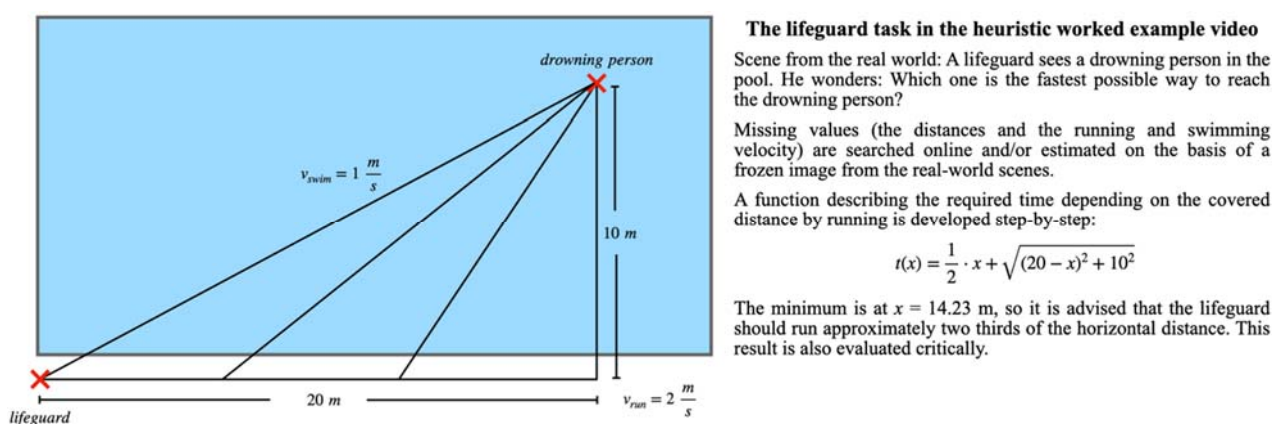

Figure 1: A brief description of the lifeguard task presented in the heuristic worked example video

Data Analysis

For data analysis, we transcribed the interviews. Then, we analyzed the transcripts using Mayring's (2015) content analysis. As little is known about working with heuristic worked example videos and

we could not use an existing elaborated category system, the category system was developed inductively based on the material. In short, a summarizing procedure was used to generate categories with regard to the research questions and thus “perceived advantages” and “perceived challenges” served as main categories. All data were coded by the first author and a second well-trained rater. Interrater reliability was very good (Cohen’s Kappa $\kappa = .83$).

Results

We started by analyzing the perceived advantages. An overview of all categories regarding perceived advantages and challenges is provided in Figure 2.

Perceived advantages

Design. Students reported advantages that closely relate to the design of the video. They liked the overall *structure* of the video. The integrated breaks in between each segment supported concentration. Providing step-by-step explanations following the solution plan helped them to monitor the solution process. Students remembered certain steps of the modeling process with the help of the solution plan and overall, it reminded them to structure their work. The integrated *self-explanation prompts* helped students to concentrate. The prompts served as a starting point to create an own solution. Speaking to a peer about the content helped students to monitor whether they have understood what they have seen so far. Another feature that students rated positively were the *explanations*. Those offer an additional approach to the ones of the teacher but can be re-watched. The explanations made clear why one step led to the next one and were described illustrative because they were connected to scenes from the real world. This closely relates to the perceived advantage of *visualizations*. Working with scenes from the real world underlined the importance of making assumptions while paying attention to the context. This is exemplified in the following excerpt:

Student A: What I also liked is that the paths were drawn on the picture of the pool, so one could visualize that. And not that there is a sketch first but that one kept an eye on different things. Like when it was said “you have to consider the starting platforms”. On a sketch, you wouldn’t have seen that at all.

Moreover, students felt that the real-world scenes made it more realistic to work on a modeling task. Comments on visualizations also related to the way of the dynamically displayed calculations which made it easier to comprehend those.

Self-regulated learning. As the previous described advantages relate to what was predefined through the video’s design, the following categories highlight how students use certain design features in a self-regulated way (see Figure 2). At two points, the video was paused and students were asked to work mathematically. When continuing the video, the result was presented briefly and students got to choose whether they want to skip the information on how to get the solution. Students acknowledged this as a way of *adaption to the level of learning*. It would have been unnecessary to watch the explanation but students still liked that they had the option. Further ways of adapting the video to the level of learning include the possibility of fast-forwarding the video, rewinding the video and pausing the video in order to take notes. Another possibility to use the video in a self-regulated way is the *direct control* of students’ self-created answers. This relates to the above-described brief presentation of the result and the optional explanation. Students compared their own ideas to the result in the video.

Even when students had the correct answer, they still liked the explanation in order to clarify how they got the answer. When they did not answer the question correctly, the explanations helped them to understand how they would have gotten the correct answer.

Perceived advantages			Perceived challenges
Design	<ul style="list-style-type: none"> • Structure (n = 14) • Self-explanation prompts (n = 6) • Explanations (n = 11) • Visualizations (n = 10) 	Self-regulated learning	<ul style="list-style-type: none"> • Adaption to the level of learning (n = 11) • Direct control (n = 3)
			<ul style="list-style-type: none"> • Transfer (n = 3) • Duration (n = 5) • Self-regulation (n = 1)

Figure 2: Perceived advantages and challenges with the number of coded segments

Perceived challenges

The three inductively developed categories regarding the perceived challenges were *transfer*, *duration* and *self-regulation* (see Figure 2).

The category of *transfer* includes the perceived difficulty to transfer the content of the video to the following task. Students reported issues with applying the structure and the general approach of the video when they felt the video was not present (despite the fact that they were allowed to use the video). The second category regarding challenges is the *duration* of the video. Students mentioned that this was too long for their usual reasons to watch a video (e.g., as exam preparation) and wishing the video to be shorter. The third challenge relates to a student stating that she would have difficulties working with this video alone. She would experience the challenge of *self-regulation* having a hard time answering the prompts and thus she would watch the video continuously.

In the following we take a closer look at the perceived challenges when working with the video and how the perceived advantages might affect those.

The challenge of transfer and the advantage of the structure. While students mentioned that they have a hard time transferring what they have seen to the task after the video, students also mentioned that the structure of the video helped with transfer. Especially the step-by-step approach to problem solving may enable working in the different steps of the modeling cycle.

The challenge of duration and the advantage of the structure. The advantages of self-explanation prompts and the adaption to the level of learning were also addressed. While the video is perceived relatively long, the step-by-step structure of the video helped students to focus, as the following excerpt underlines:

Student B: A challenge is maybe that it takes relatively long to watch it. We did it step-by-step, so it was okay for the attention span. But I think for example if you were to watch it in one piece, I think then at some point the patience thread would snap.

Not only the breaks between each segment but also working with the self-explanation prompts supported concentration. Also, the possibility of skipping explanations and thus adapting the video to the level of learning helped students to focus. Students claimed that they would not pay attention to these parts if they had to watch them. Two groups of students still would have liked the video to be shorter.

Discussion and conclusion

When asking students about *advantages* while working with a heuristic worked example video, they indicate various aspects which led to six inductively developed categories (see Figure 2). Many of them relate to the inherent design of the video. The perceived advantage *structure* refers to segmentation which is one category the videos design is based on. Students spoke of the solution plan, the integrated breaks and the step-by-step explanations solving a presented example. They also acknowledged the integrated *self-explanation prompts* as a support to stay focused. Because it is recommended to include generative activities such as opportunities to self-explain in videos (Fiorella, 2021), these answers show that they can help to achieve the desired effect. Moreover, students were able to follow the *explanations*. The mentioned *visualizations* relate to layout decisions made, for example, that the handwriting is building up dynamically. Video-taping scenes from the real-world might be worth the effort since students found them to make it more realistic to solve a modeling task and, thus, offering an authentic approach to modeling tasks in school (Greefrath & Vos, 2021). The possibilities of *adaption to the level of learning* included skipping parts of explanations. Students indicated if having to watch those when it would have been unnecessary, they would not pay attention. This is consistent with the expertise reversal effect (Kalyuga, 2021). It underlines the potential of adaptive elements when implementing a video into a learning management system with software like *h5p*. The instructor can configure the video offering students to skip parts of the video at predefined points. This differs from students being able to fast-forward the video because they might scroll through the video unsystematically. Further ways of adapting the video to the level of learning included pausing. Nevertheless, there might be a gap between the perception and the actual use of the adaptive elements. Taking a closer look at the videotaped phase of working with the video would provide deeper insights into how students actually engaged with the adaptive elements. This could also help to better understand how students used the video as an instrument of *direct control*.

In order to get an idea of the *challenges* while working with the heuristic worked example video, students' answers were grouped into three categories (see Figure 2). One challenge concerns the *transfer* of the content or structure of the video to another modeling task. It was intended to offer the students the opportunity to practice by integrating the video into a larger concept (solving a related task after watching the video). Some students indicated that the structure of the video helped with transfer. Other students still had a hard time to transfer the structure to another task when the video was "not present". Even if a table of content and bookmarks were used to help students switch between individual segments, this may not have helped students to find the part they were looking for. Again, a closer look at the phase of working with the video would provide insights into how search strategies were applied. An option to support students making the transfer could be to supply an overview page of what they have seen in the video. Thereby they can review the solution process at once. The second reported challenge concerns the *duration* of the video. As solving a modeling task can be quite complex, the recommendation to keep videos shorter than six minutes (Guo et al., 2014) could not be followed. To compensate for this, it was ensured that individual segments lasted less than six minutes. As described above, the structure, the self-explanation prompts and the adaption to the level of learning helped students to stay focused but some students still wished for a shorter video. Nonetheless, with a shorter video, other perceived advantages would not be possible. Especially the

step-by-step explanations would have to be reduced, which many students referred to as an advantage of the video. However, giving high-knowledge learners the possibility to skip more parts of the video could help to keep instructional explanations to a minimum for this group of students and thus help with reducing the length of the video. Another option would be to provide meta-knowledge (e.g., on how to look for a comparison value) on demand only. These are instances to further avoid the expertise reversal effect (Kalyuga, 2021) and could be used to provide the same video to students with different levels of modeling competency. The third perceived challenge came from one student putting herself into watching the video alone. Struggling with *self-regulation* could lead to ignoring the self-explanation prompts. As the prompts were mainly designed to discuss concepts with a partner, students could be prompted to write down their answers when watching the video alone. This may help with not rushing through the video and eventually lacking concentration. Overall, when considering the challenges, it is also important to keep in mind that students may not be used to working with a heuristic worked example video. For example, since other videos are often shorter, this could intensify the perception of the duration as challenging.

Our study has some limitations we want to acknowledge. A qualitative research approach with a small sample size was used to gain first insights into students' perceived advantages and challenges when working with a heuristic worked example video and a related task afterwards. The design only allows for hypothetical generalization which need to be confirmed in future studies. Further limitations emerge from the video and task that were used and must be kept in mind when interpreting the results. Nevertheless, the results are consistent with previous research analyzing advantages and challenges when using videos to teach mathematics (Fung et al., 2021; Kay & Kletschin, 2012). Additional perceived advantages mainly resulted from certain design features like the use of interactive elements. The potential of using scenes from the real-world might be especially fruitful within videos for teaching modeling. Further perceived challenges mostly related to the relatively complex content, but these results can be used to improve the design of heuristic worked example videos. Video designers should be aware of students' issues to transfer the content of the video to another task. Moreover, it is important to keep the video short or at least to give the students the opportunity to skip parts. Adapted generative activities for individual learners could involve prompting students to write down a short summary after each step. Overall, this study contributes to heuristic worked example research by taking the potential of instructional videos into account and thereby continuing the proposed research on heuristic worked examples in (mathematical) modeling (Renkl, 2017).

References

- Berney, S., & Bétrancourt, M. (2016). Does animation enhance learning? A meta-analysis. *Computers & Education*, *101*, 150–167. <https://doi.org/10.1016/j.compedu.2016.06.005>
- Blum, W. (2015). Quality teaching of mathematical modelling: What do we know, what can we do? In S. J. Cho (Ed.), *The proceedings of the 12th International Congress on Mathematical Education* (pp. 73–96). Springer. https://doi.org/10.1007/978-3-319-12688-3_9
- Fiorella, L. (2021). Multimedia learning with instructional video. In R. E. Mayer & L. Fiorella (Eds.), *The Cambridge handbook of multimedia learning* (3rd ed., pp. 487–497). Cambridge University Press. <https://doi.org/10.1017/9781108894333.050>

- Fung, C.-H., Besser, M., & Poon, K.-K. (2021). Systematic literature review of flipped classroom in mathematics. *Eurasia Journal of Mathematics, Science and Technology Education*, 17(6). <https://doi.org/10.29333/ejmste/10900>
- Greefrath, G., & Vos, P. (2021). Video-based word problems or modelling projects: Classifying ICT-based modelling tasks. In F. K. S. Leung, G. A. Stillman, G. Kaiser, & K. L. Wong (Eds.), *Mathematical modelling education in east and west* (pp. 489–499). Springer. https://doi.org/10.1007/978-3-030-66996-6_41
- Guo, P. J., Kim, J., & Rubin, R. (2014). How video production affects student engagement: An empirical study of MOOC videos. *Proceedings of the first ACM conference on Learning @ Scale Conference - L@S '14*, 41–50. <https://doi.org/10.1145/2556325.2566239>
- Kalyuga, S. (2021). The expertise reversal principle in multimedia learning. In R. E. Mayer & L. Fiorella (Eds.), *The Cambridge handbook of multimedia learning* (3rd ed., pp. 171–182). Cambridge University Press. <https://doi.org/10.1017/9781108894333.017>
- Kay, R. (2014). Developing a framework for creating effective instructional video podcasts. *International Journal of Emerging Technologies in Learning*, 9(1), 22–30. <https://doi.org/10.3991/ijet.v9i1.3335>
- Kay, R., & Kletskin, I. (2012). Evaluating the use of problem-based video podcasts to teach mathematics in higher education. *Computers & Education*, 59(2), 619–627. <https://doi.org/10.1016/j.compedu.2012.03.007>
- Mayring, P. (2015). Qualitative content analysis: Theoretical background and procedures. In A. Bikner-Ahsbabs, C. Knipping, & N. Presmeg (Eds.), *Approaches to qualitative research in mathematics education* (pp. 365–380). Springer. <https://doi.org/10.1007/978-94-017-9181-6>
- Niss, M., & Blum, W. (2020). *The learning and teaching of mathematical modelling* (1st ed.). Routledge. <https://doi.org/10.4324/9781315189314>
- Reiss, K., & Renkl, A. (2002). Learning to prove: The idea of heuristic examples. *ZDM Mathematics Education*, 34(1), 29–35. <https://doi.org/10.1007/BF02655690>
- Renkl, A. (2017). Learning from worked-examples in mathematics: Students relate procedures to principles. *ZDM Mathematics Education*, 49(4), 571–584. <https://doi.org/10.1007/s11858-017-0859-3>
- Schunk, D. H., & Greene, J. A. (Eds.). (2018). *Handbook of self-regulation of learning and performance* (2nd ed.). Routledge. <https://doi.org/10.4324/9781315697048>
- Wirth, L. (in press). Developing a framework for creating heuristic worked example videos to enhance students' modeling competencies. *Proceedings of the Twelfth Congress of the European Society for Research in Mathematics Education (CERME 12, February 2-5, 2022)*, xxxx–xxxx.
- Zöttl, L., Ufer, S., & Reiss, K. (2010). Modelling with heuristic worked examples in the KOMMA learning environment. *Journal für Mathematik-Didaktik*, 31(1), 143–165. <https://doi.org/10.1007/s13138-010-0008-9>

Poster Annotations

Collaborative creative tasks with iPads

Brigitta Békési, Tony Houghton and Zsolt Lavicza

Linz School of Education, Johannes Kepler University, Austria;

bek@gys.at, ajh249@gmail.com, lavicza@gmail.com

Keywords: iPads, videos, Steam, creativity, teamwork

Introduction

During the Covid-19 epidemic, using modern technology became a necessity, hence the interest in teachers' concerns grew (Keese et al. 2022). Keese found that only teachers confident about applying technology will implement technology. However, the intention to use technology in education has its roots earlier. Since the 1970s there have been studies on using computers creatively (Papert 1972). However, before designing creative tasks, one must understand, what creativity is and how to use technology to enhance creativity. Along these lines, the Austrian government purchased digital devices for all year-five and year-six students in the fall of 2021. This project aims to bridge the gap between the highly digitalised world and the classroom. Convincing teachers to implement technology despite their concerns requires tasks carried out easily. After presenting the theoretical framework, this paper will describe a creative task carried out as a joint project with an art teacher.

Theoretical Framework

Seymour Papert is considered to be the founder of constructionism. The focus of constructionists as indicated by their name is construction. Through constructing an artefact the students gain an insight into mathematical structures and gain an understanding of mathematical phenomena (Harel und Papert 1991). Harel and Papert also claimed that tasks integrating mathematics and art enhance the effectiveness of instruction. However, creativity must be learnt and practised. As Robinson Resnick claimed, the current students will have jobs that do not exist yet and require creativity (Resnick und Robinson 2017). Therefore, it is today's teachers' responsibility to prepare the students for these demands (Holbert et al. 2020). To support the teachers a collection of ready-made tasks is needed. The following paragraph will describe such a task.

Making videos using Clips and GeoGebra

The pandemic changed teaching and learning strategies. Although videos have been utilised during the long lockdown periods, students were to view these videos and not make them. The task described requires the students to make videos applying an easy-to-use App, Clips. There are already studies about the motivating effects of using Clips (Larkin und Jorgensen 2016). However, there seems to be little known about the possibilities for tasks combining mathematics and art. A year-five class had to draw circles using GeoGebra and use Clips. The students had to take a screenshot of the stages and create a short video. STEAM teaching projects intend to show students that mathematical skills are required in science, technology, engineering and art. This video task combines mathematics and art.

You can find some examples at the following links:

https://drive.google.com/drive/folders/1chAMlhc5NBVRbWQT2EDFEilnce_szV-Y?usp=sharing
https://drive.google.com/drive/folders/1_IYDFVvk5BCgJmdyXF5cEKFR33791mCAT?usp=sharing

The students were experimenting with circles while using technology. Additionally, they were collaborating. Further, we took time to evaluate the videos. They showed their creations, praised each other, and practised constructive criticism. A similar task was given to a year-six class. They were to draw triangles which added up to an animal. The rest of the class was to guess what animal would appear. The project was carried out in collaboration with the art teacher. Here you can see some of their screenshots.

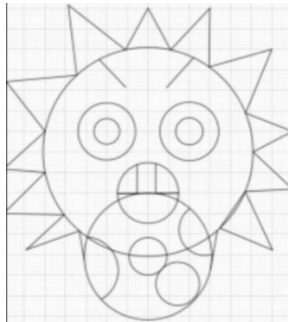

Figure 1 – 2: Cookie monster and a rabbit

Final remarks

All participants found the tasks enjoyable. The joy of creating, collaborating, and gaining acknowledgement from the other students enhanced learning. Further study is required, however, to understand the effect of expectation. The moments when the students were watching the videos and were full of expectations need further research.

Acknowledgement

The authors would like to thank all children who took part in the pilot project.

References

- Harel, I. E., Papert, S. E. (1991). *Constructionism*. Ablex Publishing.
- Holbert, N., Berland, M., Kafai, Y. B. (2020). *Designing constructionist futures: The art, theory, and practice of learning designs*. MIT Press.
- Keese, J., McIntush, K., Waxman, H. (2022). Teaching through crisis: the remote education experiences of PK–12 teachers during COVID-19 campus closures. *Technology, Pedagogy and Education*, S. 1–17. DOI: 10.1080/1475939X.2022.2067589.
- Larkin, K., Jorgensen, R. (2016). ‘I Hate Maths: Why Do We Need to Do Maths?’ Using iPad Video Diaries to Investigate Attitudes and Emotions Towards Mathematics in Year 3 and Year 6 Students. *International Journal of Science and Mathematics Education*, 14(5), S. 925–944. DOI: 10.1007/s10763-015-9621-x.
- Papert, S. E. (1972): Teaching children thinking. *Programmed Learning and Educational Technology* 9(5), S. 245–255.
- Resnick, Mitchel; Robinson, Ken (2017): Lifelong kindergarten: Cultivating creativity through projects, passion, peers, and play: MIT Press.

Software-supported development of visuospatial abilities

Klaus-Peter Eichler^{1,3}, Jiří Břehovský², Daniela Bímová², Moritz Seibold³, and Asif Mushtaq¹

¹NORD University, Bodø, Faculty of Education and Arts, Norway;
klaus-peter.eichler@nord.no, asif.mushtaq@nord.no

²Technical University of Liberec, Faculty of Science, Humanities and Education Czech Republic;
jiri.brehovsky@tul.cz, daniela.bimova@tul.cz

³University of Education Schwäbisch Gmünd, Germany
moritz.seibold@stud.ph-gmuend.de

Keywords: Visuospatial ability, mental rotation, educational software, web-based training.

The poster and its background

Our proposed poster presents the software `mathematikus.de` which we designed to support the development of visuospatial abilities. The importance of these abilities is undisputed and well documented (e.g., Maier 1994). They play a crucial role in many aspects of thinking, and their targeted improvement seems possible (e.g., Gilligan, Thomas, & Farran 2019). However, traditional methods to promote visuospatial abilities are often limited. We discuss three obstacles that impede the development of visuospatial abilities in mathematics lessons and demonstrate how our software could be used to overcome such shortcomings. Students' ways of working with the software and their reasoning strategies are the subject of our research, which we will report later.

Five aspects of “visuospatial ability”

Visuospatial qualification is the ability of humans to perceive objects in their environment and mentally process these sensory impressions. We can create mental pictures of objects without regard for their actual existence and perform mental operations on them, such as mental rotation or spatial perspective-taking (cf. Maier 1994). This complex construct needs to be differentiated into multiple facets or aspects for which concrete tasks can be developed to enable efficient teaching. Since Thurstone's (cf. 1938) conceptualization of visuospatial abilities, there were numerous factor-analytic attempts to identify such composing factors (cf. Carroll 1993). Even though there is no clear consensus about the factor-analytical structure of visuospatial ability, for our purposes, we utilized the following five reappearing aspects to categorize exercises that are meant to foster these abilities: Spatial perception, spatial visualization, the imagination of rotation, the imagination of spatial relations, and spatial orientation.

Reasons for fostering visuospatial abilities

Acquiring visuospatial abilities is by no means merely useful for correctly answering a handful of scholastic geometry-related problems, but rather seems to be of fundamental value in a myriad of areas, including scientific thinking (cf. Castro-Alonso & Uttal, 2019). The ability to imagine numbers, numerical relations and operations is crucial for success in mathematics (cf. Georges, Cornu, & Schiltz 2019). Mental calculation can be seen as an imaginary motion along a number line.

Three obstacles in the development of visuospatial abilities

When fostering visuospatial abilities, e.g., in geometry lessons, *three obstacles* can be observed in praxis: The availability of training materials is usually limited and restricted to widespread solids without atypical variations (1). Often, commonly used exercises contain time-consuming secondary activities. For instance, students must draw, cut, and fold when verifying whether a hexomino forms a cube (2). Lastly, many tasks which require the student's imagination are missing concrete three-dimensional verification methods. Therefore, students can be limited to their teacher's assessment without the possibility to visually comprehend the proposed solution (3).

Mathematikus.de – software-aided development of visuospatial abilities

Utilizing software allows for extensive variability: Virtual solids can be effortlessly created without being restricted to just a few physical solids. Additionally, it is possible to implement immediate visual feedback such as observable animations. We developed *mathematikus.de* based on commonly used exercises for fostering visuospatial abilities. On our poster, we depict various exercises we have implemented and explain our didactical considerations behind these tasks. We show how the implemented informative feedback should support the students' learning process. Our next step is examining the students' work and reasoning-strategies while solving the tasks presented in *mathematikus.de*. One of our key interests is how much prior experience with three-dimensional solids students need to grasp and solve tasks presented on the two-dimensional screen which merely allows for an abstraction of three-dimensional problems.

Acknowledgment

This contribution was created as one of the outcomes of the project iTEM (Improve Teacher Education in Mathematics), EHP-CZ-ICP-2-018.

References

- Carroll, J. B. (1993). *Human cognitive abilities: A survey of factor-analytic studies*. Cambridge University Press.
- Castro-Alonso, J., & Uttal, D. (2019). Science education and visuospatial processing. In J. C. Castro-Alonso (Ed.), *Visuospatial Processing for Education in Health and Natural Sciences* (pp. 53–79). Springer. https://doi.org/10.1007/978-3-030-20969-8_3
- Georges, C., Cornu, V., & Schiltz, C. (2019). Spatial skills first: The importance of mental rotation for arithmetic skill acquisition. *Journal of Numerical Cognition*, 5(1), 5–23. <https://doi.org/10.5964/jnc.v5i1.165>
- Gilligan, K. A., Thomas, M. S. C., & Farran, E. K. (2020). First demonstration of effective spatial training for near transfer to spatial performance and far transfer to a range of mathematics skills at 8 years. *Developmental science*, 23(4), e12909-e12909. <https://doi.org/10.1111/desc.12909>
- Maier, P. H. (1994). *Räumliches Vorstellungsvermögen - Komponenten, geschlechtsspezifische Differenzen, Relevanz, Entwicklung und Realisierung in der Realschule*. Peter Lang
- Thurstone, L.L. (1938): *Primary mental abilities*. Chicago: University of Chicago.

The application of micro-video clips in mathematical teaching in primary school

Yanjun Hong^{1,2}

¹Danish school of education, Aarhus University, Denmark; yjh@edu.au.dk

² Teacher college, Shihezi University, China

Keywords: Micro-Video Clips, History of mathematics, Popular Science, Real slice of life.

Introduction

The video clip teaching, with the characteristics of short and exquisite, lively and convenient, and dynamic and repeatable, has been applied in many education and teaching levels, and is gradually becoming the hotspot and frontier of education and teaching reform (Hong et al. 2016).

In the research, the micro-video clips can be divided into four types: creating situations, reproducing history or life, introducing mathematical ideas and displaying mathematical methods (Li et al., 2019). We select some math-related historical materials, Popular Science, or real slice of life micro-video of educational value, make micro-video clips no more than ten minutes, and apply it to teaching. On the one hand, because the history of mathematics is of great importance to mathematics teaching (Jankvist, U., 2009). However, not enough class time, not sufficient historical materials or not knowing how to use them properly has always been a confusion for primary school teachers. On the other hand, choosing Popular Science knowledge or using real slice of life micro-video is to deepen understanding of knowledge from the perspective of interdisciplinary application, and understand that mathematical knowledge comes from life and serves life. The application of micro-video clips in mathematical teaching has been tested to be an effective way in China (Wang, 2005; Huan, 2021).

The teaching application of micro-video clips

Different types of micro-video clips adapt to different teaching aspects, see Table 1 (Li et al., 2019), and the process is: Design→Making→Application→Assessment, re-circulates based on the feedback.

Types of micro-video	Suitable teaching aspects
Creating Situations	Introduction of the Theme, Exploration of New Knowledge
Reproducing History or life	Exploration of New Knowledge, Application in Examples, Summary
Introducing Ideas	Exploration of New Knowledge, Summary
Displaying Methods	Exploration of New Knowledge, Application in Examples

Table 1: Types of micro-video and teaching aspects

Case 1: Micro-video clips of the history of mathematics in *the area of a circle*

The teacher made a short video clip with animation effects of the historical mathematicians' methods with the researcher's help (see Figure 1), and it was arranged to be shown in the teaching summary session. Based on the cognitive characteristics of the students, the teacher selected the divide-and-patch method that was similar to Liu Hui (C.225-295AD) and Herbert Slaughter (1861-1937) in her class (Hong et al., 2015). Firstly, students divided the circle equally into 4, 8 and 16 parts based on their life experiences, then they put together one by one. Secondly, the teacher used the graphing

software to dynamically demonstrate the complex patchwork of dividing the circle into 32, 68, and 128 parts (see Figure 2). Finally, they inductively derived the formula for the area of a circle together by observation and reasoning. The questionnaire survey of the students after the class showed that all students “liked” this teaching way because it was “lively and interesting”.



Figure 1: Screenshot of the animated micro-video on the history of mathematics



Figure 2: The divide-and-patch of a circle and two circles

Case 2: Life micro-video clips in *the awareness of angles*

In the opening of the teaching, the teacher played a micro-video of a real-life bird feeding, and gave a task which the birds open their mouths to compare sizes (see Figure 3). Interviews with students showed that the use of real slice of life micro-video can enhance the connection between mathematics and life, and develop students’ ability to observe the real world with mathematical vision.



Figure 3: Screenshot of the real-life bird feeding in the video

Conclusion

The teaching effect shows that the application of micro-video clips contributes to develop students' core mathematics competencies. In addition, when designing micro-video clips, we need consider the characteristics of the materials: Interestingness, Scientificity, Validity, Learnability and Humanity (Wang, X., 2018), and the relationship between different teaching aspects and the type of micro-video, choose the appropriate presentation, pay attention to the deep integration of technology and materials, highlight the mathematical ideas or methods, and serve the achievement of teaching objectives.

Acknowledgment

Thanks to professor Jankvist U. T. and his team for their help and support in DPU, Aarhus University.

Presenting references

Jankvist, U. (2009). A categorization of the “whys” and “hows” of using history in mathematics education. *Educational Studies in Mathematics*, 71:235–261.

<https://www.jstor.org/stable/40284598>

Hong, Y. & Wang, X. (2015). History and Epistemology in Mathematics Education, Proceedings of the Seventh European Summer University ESU 7. In Barbin, E., Jankvist, U. T. & Kjeldsen, T. H. (Eds.). *Teaching the area of a circle from the perspective of HPM* (pp. 403–415). Denmark: Aarhus University, DPU. https://pure.au.dk/ws/files/96258079/ESU7_e_version.pdf

Inverse of a function - mathematical and GeoGebra approach

Péter Körtesi¹ and Zsuzsanna Katalin Szabó²

¹ University of Miskolc, Hungary; pkortesi@gmail.com

² George Emil Palade University of Medicine, Pharmacy, Science, and Technology of Targu Mures, Romania; szabo.zs.katalin@gmail.com

Abstract: The notion of function is primordial in teaching mathematics. The inverse of a function has a well-known mathematical definition. However, it is useful to clarify what are the discrepancies between mathematical definition of inverse function, the commands like Invert and NInvert when using GeoGebra as function graphing tool of the software. Some examples to be presented are aimed to underline the right use of ICT tools, the same time to attract the attention on the possible limits, failures in applying them. It is a need for advanced critical thinking both for teachers and students, when applying these tools.

Keywords: Inverse of a function, bijectivity, graphing the inverse function, critical thinking.

The inverse of a function, symmetry problems

There are several definitions of the inverse of a function the teacher can use, depending on the learners' mathematical knowledge level. Teaching the notion of inverse function offers the chance to address questions to students to deepen their understanding when using ICT tools like GeoGebra, see [1], and [2]. There are two distinct commands built in the software for this purpose, Invert and NInvert.

Let us analyze some examples to point out the problems the students will meet.

Example 1. Take the function $p: [-1, 1] \rightarrow [0, 1]$, given by $p(x) = \sqrt{1 - x^2}$. The function is obviously not invertible, as for example $p(-0.6) = p(0.6) = 0.8$.

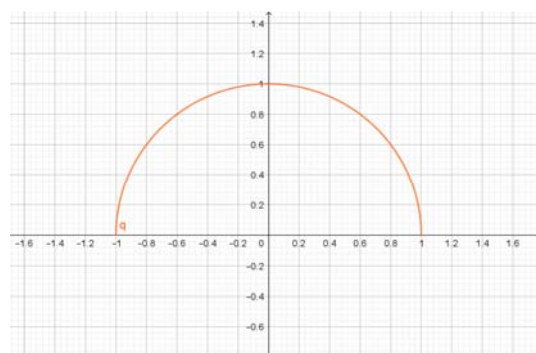
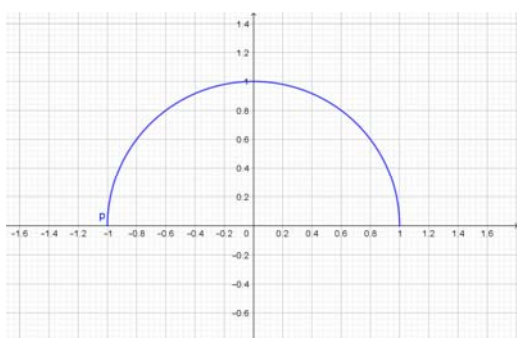

Figure 1. The graph of p in GeoGebra **Figure 2.** The graph of q , invert of p in GeoGebra

Applying the commands Invert or NInvert, GeoGebra returns the q , as invert of p , see Figure.2.

Is this the right answer? No. As the function is not invertible, all what can be done is to take a restriction of it, either $t: [0, 1] \rightarrow [0, 1]$, or $u: [-1, 0] \rightarrow [0, 1]$, given by $t(x) = u(x) = \sqrt{1 - x^2}$.

The first gives the first quadrant, and the inverse overlaps with the initial function, while in the second case the graph of the inverse of the restriction of p belongs to quadrant four, see [3].

Example 2. Let us take now the function $r: (-\infty, \infty) \rightarrow [0, \infty)$ given by $r(x) = x^2$

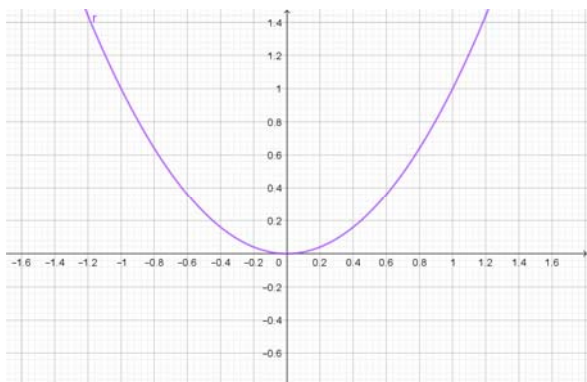

Figure 3. The graph of r in GeoGebra

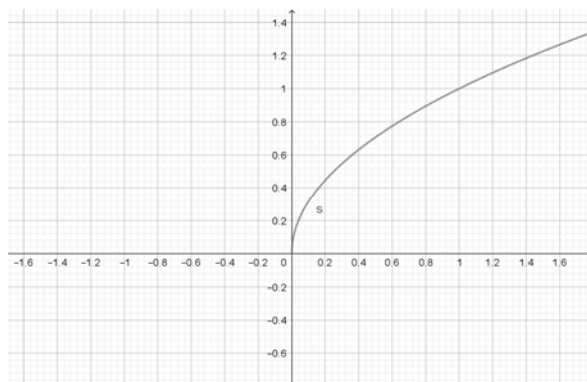

Figure 4. Function s Invert(r)

Applying the commands Invert or NInvert, GeoGebra returns the function s , as invert of r

Again, the question should be: Is this the right answer? No. As the function is not invertible, all what can be done is to take a restriction of it, either $v: [0, \infty] \rightarrow [0, \infty]$, given by $v(x) = x^2$ or $w: [-\infty, 0] \rightarrow [0, \infty]$, given by $w(x) = x^2$, see the page on [4].

Discussion, conclusions

The students need to get experience to use discerningly the available software packages, and to find the reason for the differences which appear as computer program answer, and the mathematics behind. The same rules apply here as in case of any other smart tool, it is important the basic knowledge and the understanding that the computer software will return an answer, but that might be different from what is taught in a theoretical course.

Acknowledgment

The paper is a partial result of discussions with students during the CEEPUS HU 0028 Summer university GeoGebra Summit 2021 organized by the University of Miskolc.

References

Buchberger, B. (2002, March). Computer Algebra: The End of Mathematics? *ACM SIGSAM Bulletin*, 36(1), 3-9. doi:DOI: 10.1145/565145.565147

Tamam, B., & Dasari, D. (2021). The use of Geogebra software in teaching mathematics *Journal of Physics: Conference Series* 1882(1): 012042. <https://doi.org/10.1088/1742-6596/1882/1/012042>

Inverse function on GeoGebra tube: <https://www.geogebra.org/m/ysxxunry>

Inverse function on GeoGebra tube: <https://www.geogebra.org/m/jxujefse>

Support the development of spatial ability of future teachers for primary education through GeoGebra

Katarína Laššová and Veronika Bočková

Constantine the Philosopher University in Nitra, Faculty of Natural Sciences and Informatics,
Nitra, Slovak Republic; katarina.lassova@ukf.sk; veronika.bockova@ukf.sk

Keywords: Geometry, spatial ability, teacher training, GeoGebra, implicative analysis.

Geometry is an integral part of mathematical education in Slovakia and abroad as well. It supports the development of spatial imagination, deductive and logical thinking, and prepares the pupils for world and work. Spatial imagination is some of the most essential human abilities useful for everyday life. However, some current research shows that spatial ability has a declining trend. It can be caused by a reduction in geometry curriculum and geometry education content or the insufficient teacher readiness, who must pass on knowledge to their learners.

The term spatial ability can be understood very subjectively, and we can think it is the proper orientation in the forest, a new city, or reading maps. According to Mohler and Miller (2008), teaching spatial ability is important for “to teach the technical language” and “to develop the students’ ability to visualize and solve problems in three dimensions”. Linn and Petersen (1985) define spatial ability as a „skill in representing, transforming, generating and recalling symbolic, non-linguistic information “.

There are certain groups of people who think that spatial ability can only be innate, we are aware that even in early childhood, it is possible to form a spatial ability. The family has an impact on the formation of the child’s spatial ability. Preschool and primary school education teacher plays in developing spatial ability an important role, too. For that reason, Marchis (2017) states that these teachers must have a very well-developed spatial ability. However, a lot of national studies confirm that these teachers have low levels of spatial ability. The same is true in Slovakia and this fact is confirmed by our research.

This poster aim is to present the GeoGebra applets, which help students to visualize the spatial ability tasks. The applets were designed based on research by future primary school teachers. The research was conducted in September 2021 and the research sample consisted of 78 Bachelor’s students of Teacher training for preschool and primary education at Constantine the Philosopher University in Nitra. The students finished their secondary school studies at various types of schools with various mathematics curricula, and thus had different geometrical skills.

The students solved spatial ability tasks, which were related to the cubes and cube nets. The first task was focused on the rotation of the dice according to the fields of the plan. In the second task, students had to complete the numbers on the cube nets created from the dice in the task assignment. The third task was the same as the second task, but the cube net was nonstandard for the students.

The students had problems with solving the spatial ability tasks, because only 15.4 % of students correctly solved them. The biggest problem was that students could not imagine the rotation of the cube in different directions. They knew how to rotate the cube until they came to the bend and then, they could not imagine the next step. Only 20.5 % of students correctly write the number of all dots

to the plan. Students also had a problem with adding the number of dots on the cube net. More students could insert the suitable number of dots on the dice, when the dice was standard and more used than when the dice was nonstandard for the students.

In the interpretation of the results, we have shown that students have some problems with solving the tasks. Students used paper and pencil while solving the tasks. It is questionable whether students would achieve more correct solutions using some software or tools. For this reason, we decided to design the solved tasks in GeoGebra. Our goal was to show the students how they can solve the tasks with using dynamic geometric software and get acquainted with GeoGebra software.

Solutions of Task A, Task B and Task C are available on our own GeoGebraic profile in a format GeoGebra book called MEDA 2022: <https://www.geogebra.org/m/adsz5sww>.

We know that students have problems with spatial imagination. For this reason, it is necessary to develop students' spatial ability. Armahs writes that (2018) low geometry learning experiences cause low spatial ability. Vallo (2021) about geometry also claims that spatial ability should be constantly evolving. We need to show students the various tools for spatial ability development. We believe that the proposed applets helped students to visualize the task and they support them in creating their own tools in GeoGebra while their teaching practice. We think it is very important to create for students a creative and varied learning environment using non-standard tasks but also a non-standard solution using software to develop spatial ability.

Acknowledgment

This paper was created with support of project UGA: VII/13/2022 and project KEGA: 019UKF-4/2020.

References

- Armah, R. B., Cofie, P. O., & Okpoti, C. A. (2018). Investigating the Effect of van Hiele Phase-Based Instruction on Pre-Service Teachers' Geometric Thinking. *International journal of Research in Education and Science*, 4(1), 314-330.
- Linn, M. C., & Petersen, A. C. (1985). Emergence and characterization of sex differences in spatial ability: A meta-analysis. *Child development*, 56(6), 1479-1498.
- Marchis, I. (2017). Pre-Service Primary School Teachers' Spatial Abilities. *Acta Didactica Napocensia*, 10(2), 123-130.
- Mohler, J. L., & Miller, C. L. (2008). Improving spatial ability with mentored sketching. *The Engineering Design Graphics Journal*, 72(1), 19-27.
- Vallo, D. (2021). *Koncepcia výučby geometrie podporovanej implementáciou dynamických geometrických programov [The concept of teaching geometry supported by the implementation of dynamic geometric programs]*. Nitra: UKF.

Educating pre-service teachers in programming for schools Block-based programming initiative in the teacher education program

Asif Mushtaq¹, Klaus-Peter Eichler¹, Daniela Bímová², Petra Pirklová², and Jiří Břehovský²

¹NORD University, Faculty of Education and Arts, 8047, Bodø, Norway;
asif.mushtaq@nord.no, klaus-peter.eichler@nord.no

²Technical University of Liberec, Faculty of Science, Humanities and Education, Czech Republic;
daniela.bimova@tul.cz, petra.pirklova@tul.cz, jiri.brehovsky@tul.cz

Keywords: pre-service teachers, block programming, revised curriculum, micro:bit

The poster and its environment

The proposed poster presents the block-based programming experiences of the pre-service teachers with their first introduction with programming at university-level education. Our aim is to report the results of the impact of programming workshops on the professional development of pre-service teachers and how this initiative is helping them to become better future teachers. A very positive and impactful learning response from them is a highlighted part of this research. In the last decades, computer technology has changed our society dramatically. The school-going elite of today is meeting and interacting with information technology almost everywhere. Recently, many European countries have introduced basic programming in their national curricula in view of the increasing and futuristic importance of information technology. As a part of the “Digitalization Strategy for Basic Education 2017-2021” (Education & Research, 2017), the Norwegian Ministry of Education has introduced programming (coding) in different courses at primary and secondary school levels. The school year 2020-2021 is the first year with this revised curriculum in Norway. Competence goals for programming in mathematics have been introduced at all levels in primary and lower secondary school in the revised curriculum (Utdanningsdirektoratet, 2020a).

Challenges and collaborative work

The challenges associated with this inclusion in the revised curriculum (LK20) in schools and in the teacher-education institutions are manifold. It is natural for the schools and teacher-education institutions to reflect this reality. In the present research, our focus will remain on the measurements and actions taken by the Nord university and its partner university in their teacher-education program for pre-service teachers. The Nord University is collaborating on a joint research project, improving Teacher Education in Mathematics (iTEM), with the Technical University of Liberec (TUL) in the Czech Republic. One of the main goals of this research is to investigate the perceptions held by pre-service teacher at Nord university in Bodø campus and at TUL Czech Republic towards the use of the block-based programming with micro:bit. Micro:bit is a pocket-sized programmable device that helps the students to get more involved in the world of coding (programming). It targets the young people’s inspiration to be creative with digitalization and develop fundamental skills in Science, Technology, Engineering, and Mathematics (STEM) (Sentance et al., 2017).

Planning and discussion

To help and improve the students' learning skills through programming instruction, it is important to provide appropriate activities and tasks (Popat & Starkey, 2019). We designed and presented activities on micro:bit in the workshops conducted at different levels in teacher education program at Nord University Norway and at TUL Czech Republic. We targeted one of the learning goals from LK20 (Utdanningsdirektoratet, 2020a) related to the programming in the Norwegian revised 7th-grade mathematics curriculum in schools and designed activities that transform the micro:bit into a digital dice. Students performed guided instructions and made a digital dice. Subsequently, students recorded the data on shaking the micro:bit as they do conventionally with a normal cast of dice. To achieve this goal, students learned the art of algorithmic thinking and the basic skills of the programming such as defining the variables, working with loops, understanding of basic logic, and implementing a build-in math module with built-in feature. The feedback of the participants was recorded via an online questionnaire. The contents of this poster are mostly related to the responses of the participants on their experiences with programming. Most of the pre-service teachers who attended the workshops reflected that the micro:bit is a useful tool to develop algorithmic thinking, easy to use, and enjoyable to work with in relation to both its programming environment and problem-solving capabilities. A sizable percentage of teacher-students showed a keen interest in block-based programming with micro:bit and expressed that they learned a lot because of these workshops. Furthermore, they expressed great interest in using the micro:bit in their future teaching programs in schools. It is worth mentioning that few of these students who were writing their research reports in their third-year study program at Nord university designed the micro:bit tasks and presented them in schools during their teaching practice period due to high demands on programming from school sides. Key findings of this research work will be presented in the poster.

Acknowledgment

The authors would like to acknowledge the project iTEM (improve Teacher Education in Mathematics), EHP-CZ-ICP-2-018 for this research work.

References

- Education, M. o., & Research. (2017). Framtid, fornyelse og digitalisering. Digitaliseringsstrategi for grunnsopplæringen 2017-2021.
- Popat, S., & Starkey, L. (2019). Learning to code or coding to learn? A systematic review. *Computers & Education*, 128, 365-376.
- Sentance, S., Waite, J., Hodges, S., MacLeod, E., & Yeomans, L. (2017). "Creating Cool Stuff" Pupils' Experience of the BBC micro: bit. Proceedings of the 2017 ACM SIGCSE technical symposium on computer science education
- Utdanningsdirektoratet. (2020a). <https://www.udir.no/lk20/mat01-05>

The influence of dynamic visualizations on learning derivatives

Hoang Nguyen

University of Münster, Institute of Mathematics Education, Germany; h.nguyen@uni-muenster.de

Keywords: derivative, dynamic visualizations, basic mental models

Theoretical Background

Calculus is an important component of many school curricula for upper secondary grades worldwide, in Germany as well. Students' difficulties regarding calculus concepts, for example the missing conceptual understanding of derivatives, were investigated in several studies. Sari et al. (2018) state that students are not able to explain derivatives but describe the derivation rules for a specific function instead. The concept of basic mental models (BMMs – German: Grundvorstellungen) is well-established and “describes the relationships between mathematical content and the phenomenon of individual concept formation” (vom Hofe & Blum, 2016, p. 230). Thus, BMMs are a requirement for learners to give mathematical concepts meaning. Regarding derivatives, Greefrath et al. (2022) determine the four BMMs “local rate of change”, “tangent slope”, “local linearity” and “amplification factor”. According to educational standards in Germany, applying mathematics in realistic contexts is of high importance. For this reason, the local rate of change, which is based on the idea of instantaneous velocity, has become more important in German schools. Students should develop an understanding of the local rate of change as the limit of the average rate of change. Furthermore, the traditional approach to derivatives was provided through the tangent slope at a point of the graph, which is equal to the slope of the curve at that particular point. Here, the tangent should be understood as a ‘clinging straight line’. The other two BMMs are not focused due to their subordinate role in teaching calculus in German schools. Calculus, and notably derivative is a dynamic concept, so that technology like dynamic geometry software GeoGebra is predestined to help students exploring and acquiring a conceptual understanding (Sari et al., 2018). Especially, the BMM “tangent slope” is in its core a dynamic one, because the transition from the secant to the tangent can be visualized well dynamically. According to the meta-analysis by Berney & Bétrancourt (2016) dynamic, in contrast to statistic visualizations, have a significantly positive influence on students' learning outcomes if they have a representational function. Given the potential of dynamic visualizations, it is significant to find out whether the results of many studies can also be applied to learning derivatives, which has not been investigated in mathematics didactical research yet. From this theoretical background, the following research questions emerge for a project that will be piloted next school year:

1. To what extent do lessons with dynamic visualizations of derivatives have a positive influence on mathematical competencies of learners compared to lessons with the same content but focusing on static visualizations?
2. Are there any differences concerning the influence of dynamic visualizations on the basic mental models “local rate of change” and “tangent slope”?

Method

The project “AdVise” (German: **A**bleitung **d**ynamisch mit **V**isualisierungen **e**ntdecken; English: discovering derivatives through dynamic visualizations) will be conducted with about 250 students

in grade 10 and 11, who have not received an introduction to derivatives yet. The quasi-experimental between-subjects design (Fig. 1) is inspired by Schukajlow et al. (2015) and Brnic (2020).

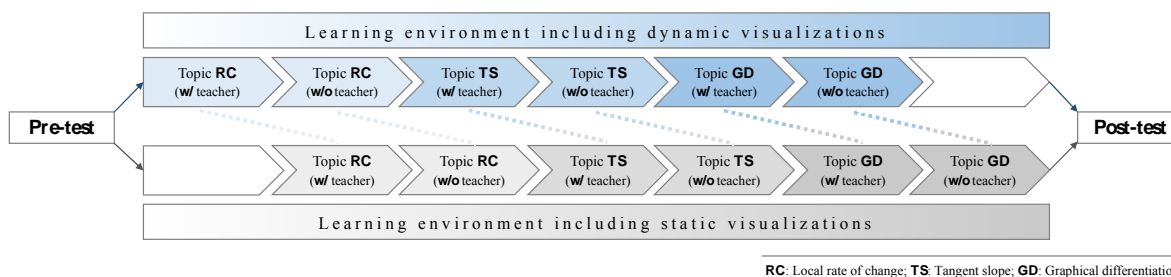

Figure 1: Overview of the pre-post design (own figure based on Brnic (2020))

Classes are split and a similar average level of achievement is aimed at between the two groups. This approach will be realized by using a pre-test, which contains tasks about functional thinking and linear functions, both BMMs “local rate of change”, “tangent slope” and also graphical differentiation. There, the focus lies on the qualitative introduction of derivatives, because this is the framework for the lesson sequence. The test items, focusing on conceptual understanding, are taken (and partly modified) from several validated test instruments, centralised examinations in Germany, and adapted exercises from mathematics school books. The experimental group works with a digital learning environment including dynamic visualizations mostly created with GeoGebra. For example, learners can trace a tangent line along a graph, while the program is plotting the graph of the derivative. The control group is given the same digital learning environment, but only static visualizations are integrated. In order to keep traits constant, the teacher teaches both groups staggered; the lessons without the teacher are planned as practice sessions in order to deepen the content learned prior (Brnic, 2020). A first version of the instrument for measuring conceptual understanding of derivatives as well as the lesson sequence with dynamic (and static) visualizations will be presented and discussed at the conference.

References

- Berney, S., & Bétrancourt, M. (2016). Does animation enhance learning? A meta-analysis. *Computers & Education, 101*, 150–167.
- Brnic, M. (2020). Digital oder analog? Eine Interventionsstudie zur Schulbuchnutzung. In H.-S. Siller, W. Weigel, & J. F. Wörlner (Eds.), *Beiträge zum Mathematikunterricht 2020* (pp. 177–180). WTM-Verlag Münster.
- Greefrath, G., Oldenburg, R., Siller, H.-S., Ulm, V., & Weigand, H.-G. (2022). Mathematics students’ characteristics of basic mental models of the derivative. *Journal für Mathematik-Didaktik*. <https://doi.org/10.1007/s13138-022-00207-9>
- Sari, P., Hadiyan, A., & Antari, D. (2018). Exploring derivatives by means of GeoGebra. *International Journal on Emerging Mathematics Education, 2*(1), 65–78.
- Schukajlow, S., Krug, A., & Rakoczy, K. (2015). Effects of prompting multiple solutions for modelling problems on students’ performance. *Educational Studies in Mathematics, 89*(3), 393–417.
- vom Hofe, R., & Blum, W. (2016). “Grundvorstellungen” as a category of subject-matter didactics. *Journal für Mathematik-Didaktik, 37*, 225–254.

Resources to teach Computational Thinking in primary mathematics education

Siri Krogh Nordby¹, George Gadanidis² and Immaculate Namukasa³

¹Oslo Metropolitan University, Faculty of Education, Oslo, Norway; Siri-Krogh.Nordby@oslomet.no ²Western University, Faculty of Education, Ontario, Canada; ggadanid@uwo.ca ³Western University, Faculty of Education, Ontario, Canada; inamukas@uwo.ca

Keywords: Computational Thinking, mathematics education, primary education, teaching resources.

Aim and rational of the study

Recently, there has been a growing interest in cultivating computational thinking (CT) as a 21st-century skill in mathematics education (Nordby et al., 2022a). However, the interest has resulted in divergent definitions of what CT encompasses in an educational context (Lockwood & Mooney, 2017).

Despite the effort of conceptualising CT in education there is little direct guidance of how to integrate CT into the learning and teaching of core subjects such as mathematics, and research show that CT concepts seems to be an add on appearing on its own in the mathematics classrooms (Nordby et al., 2022b). This goes against the visions of Papert (1980), which highlighted LOGO programming in education already in the 80's. He believed that "...certain uses of very powerful computational technology and computational ideas can provide children with new possibilities for learning..." in subjects such as mathematics (Papert, 1980 p. 17).

There are limited empirical research that show full integration of CT in the teaching and learning of mathematics (Nordby et al., 2022a). As such, there is a need to highlight more of these learning opportunities to inform how CT can be integrated as a tool to enrich mathematical concepts in education. If CT should sustain as a tool in teaching mathematical concepts, it is important that the teaching resources that are available for mathematics teachers, highlights how this integration is possible. Our aim with this paper is twofold: (1) explore how the resources integrate CT and mathematics; and (2) explore in what way the resources provide conceptual understanding in mathematics.

Theoretical framework

This study is inspired by the work of assessing conceptual understanding in mathematics done by Niemi (1996). The key measure of conceptual understanding in this current study goes beyond procedural knowledge of memorizing computational algorithms, focusing more on how representations are used to facilitate meaningful mathematical experiences. Following Niemi's (1996) ideas of mathematical conceptual understanding, we address two major types of analysis; (a) semantic analysis and (b) structural analysis. The semantic analysis is used to identify the type of activity and what central mathematical concept that is represented. The structural analysis gives us the opportunity to investigate how the activity facilitate construction and meaning to the mathematical concepts and how mathematical ideas are created.

Methodology

14 primary mathematics teachers, six in Canada-Ontario and eight in eastern Norway, were contacted with the question of what resources they used when implementing CT in their mathematics teaching. The result was 42 different resources, spanning from interactive robots to teaching books aligned to their specific grade.

Analysis

The 42 resources were analysed, and five different categories was created: (1) unplugged (e.g. step by step instructions to move in a grid on paper); (2) interactive puzzles/games (e.g. codespark); (3) interactive robots (e.g. BitBot); (4) block based interactive environment (e.g. Scratch); and (5) excluded resources (not applicable due to no coding related). In the second level of analysis we used the categories developed by Israel and Lash (2020) to systematise how the different resources were integrated (i.e. no, partial and full integration). In the third level of analysis we followed Niemi's (1996) two major categories of analysing conceptual understanding of mathematics in resources found in the category of full integration: (1) semantic analysis (representations and mathematical concepts); (2) general analysis (how the mathematical representations are connected to promote learning).

Preliminary results and implications

A preliminary analysis suggests that resources in category (4) using Scratch, shows a greater tendency towards full integration than the other categories. Category (1) and (2) shows limited integration, mainly focusing on computational concepts. In relation to conceptual understanding of mathematics in the resources that have full integration, we find that students are given the opportunity to explore mathematical concepts and relationship, be creative and active in the learning, and experience visual representation of the mathematics in action. In the upcoming months we will further investigate the resources with the question: "what ought to be", aiming to look at what possibilities lies in the different resources to enhance mathematical learning.

References

- Israel, M., & Lash, T. (2020). From Classroom Lessons to Exploratory Learning Progressions: Mathematics + Computational Thinking. *Interactive Learning Environments*, 28(3), 362-382.
- Lockwood, J., & Mooney, A. (2017). Computational Thinking in Education: Where does it fit? A systematic literary review. *arXiv preprint arXiv:1703.07659*.
- Niemi, D. (1996). Assessing conceptual understanding in mathematics: Representations, problem solutions, justifications, and explanations. *The Journal of Educational Research*, 89(6), 351-363.
- Nordby, S. K., Bjerke, A. H., & Mifsud, L. (2022a). Computational Thinking in the Primary Mathematics Classroom: a Systematic Review. *Digital Experiences in Mathematics Education*, 1-23.
- Nordby, S. K., Bjerke, A. H., & Mifsud, L. (2022b). Primary Mathematics Teachers' Understanding of Computational Thinking. *KI-Künstliche Intelligenz*, 1-12.
- Papert, S. (1980). *Mindstorms: children, computers, and powerful ideas* Basic Books. Inc. New York, NY.

Mathematics Education in Digital Age 3 (MEDA3)

Proceedings of the 13th ERME Topic Conference (ETC13)
held on 7 – 9 September 2022 in Nitra, Slovakia

Edition: Prírodovedec, no 783

Publisher: Constantine the Philosopher University in Nitra

Editors: Hans-Georg Weigand, Ana Donevska-Todorova, Eleonora Faggiano,
Paola Iannone, Janka Medová, Michal Tabach, Melih Turgut

Format: A4

Year: 2022

Place: Nitra, Slovakia

Pages: 321

ISBN: 978-80-558-1912-9

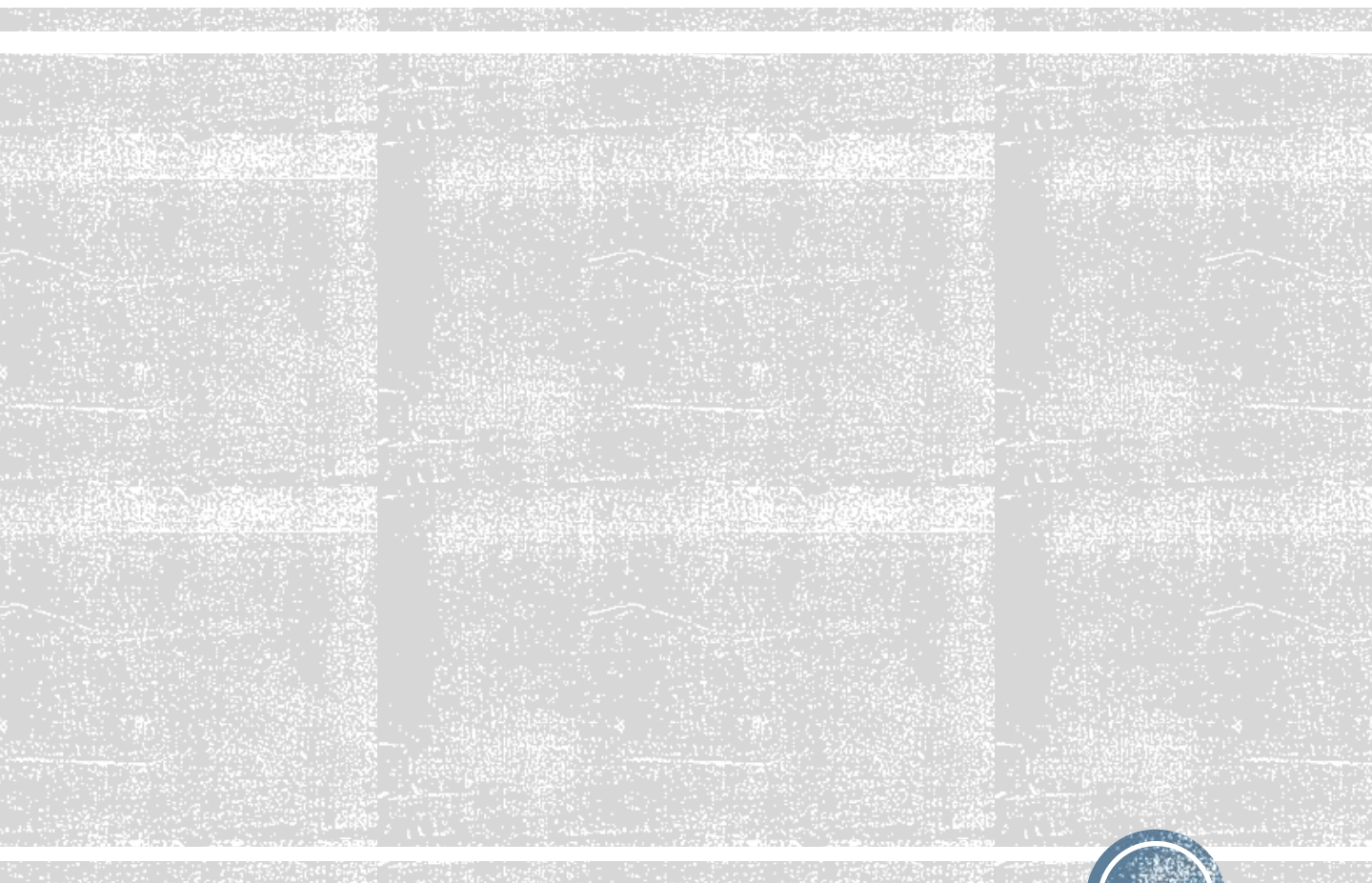

Edition: Prírodovedec no 783
ISBN: 978-80-558-1912-9