



HAL
open science

Determining the geochemical fingerprint of the lead fallout from the Notre-Dame de Paris fire: Lessons for a better discrimination of chemical signatures

Justine Briard, Sophie Ayrault, Matthieu Roy-Barman, Louise Bordier, Maxime L'Héritier, Aurélia Azéma, Delphine Syvilay, Sandrine Baron

► To cite this version:

Justine Briard, Sophie Ayrault, Matthieu Roy-Barman, Louise Bordier, Maxime L'Héritier, et al.. Determining the geochemical fingerprint of the lead fallout from the Notre-Dame de Paris fire: Lessons for a better discrimination of chemical signatures. *Science of the Total Environment*, 2023, 864, pp.160676. 10.1016/j.scitotenv.2022.160676 . hal-03917172

HAL Id: hal-03917172

<https://hal.science/hal-03917172v1>

Submitted on 16 Nov 2023

HAL is a multi-disciplinary open access archive for the deposit and dissemination of scientific research documents, whether they are published or not. The documents may come from teaching and research institutions in France or abroad, or from public or private research centers.

L'archive ouverte pluridisciplinaire **HAL**, est destinée au dépôt et à la diffusion de documents scientifiques de niveau recherche, publiés ou non, émanant des établissements d'enseignement et de recherche français ou étrangers, des laboratoires publics ou privés.

1 **Determining the geochemical fingerprint of the lead fallout from the Notre-Dame de Paris**
2 **fire: lessons for a better discrimination of chemical signatures**

3 Justine Briard ¹, Sophie Ayrault ^{1,*}, Matthieu Roy-Barman ^{1,†}, Louise Bordier ¹, Maxime
4 L'Héritier ², Aurélia Azéma ³, Delphine Syvilay ³, Sandrine Baron ⁴

5 ¹ Laboratoire des Sciences du Climat et de l'Environnement, LSCE UMR 8212, CEA – CNRS -
6 UVSQ, Université Paris Saclay, France

7 ² Archéologie et Sciences de l'Antiquité, ArScAn UMR 7041, CNRS, Université Paris 8, France

8 ³ Laboratoire de Recherche des Monuments Historiques, CRC USR 3224, Muséum National
9 d'Histoire Naturelle - CNRS - Ministère de la Culture, France

10 ⁴ Laboratoire Travaux et Recherches Archéologiques sur les Cultures, les Espaces et les
11 Sociétés, TRACES UMR 5608, CNRS - Université de Toulouse, France.

12 * Corresponding author: Sophie AYRAULT. Address: Laboratoire des Sciences du Climat et de
13 l'Environnement (LSCE), bât 714, Orme des Merisiers, CEA Saclay, 91191 Gif-sur-Yvette, France

14 **Phone** + 33 1 69 08 40 71; **Email:** sophie.ayrault@lsce.ipsl.fr

15 ORCID: 0000-0001-8320-6917 (S.A.); 0000-0002-3986-4549 (M. R.-B.); 0000-0003-3428-2977
16 (M L'H.); 0000-0003-1910-8903 (S.B.)

17
18
19
20
21 † Deceased author
22
23

24 **Determining the geochemical fingerprint of the lead fallout from the Notre-Dame de Paris**
25 **fire: lessons for a better discrimination of chemical signatures**

26

27 **Abstract: (300 words max)**

28 On 2019, the fire of Notre-Dame de Paris cathedral (“NDdP”) spread an unknown
29 amount of lead (Pb) dust from the roof of the cathedral over Paris. No data describing the
30 geochemical fingerprint of the roof lead, as well as no particle collected during the fire, were
31 available: a post-hoc sampling was performed. To discriminate the potential environmental
32 impact of the fire from multiple Pb sources in Paris, it was mandatory to define unequivocally
33 the fire dust geochemical signature. A dedicated and in hindsight geochemistry-based strategy
34 was developed to eliminate any source of potential contamination due to sampling substrates
35 or previously deposited dust. Radiogenic Pb isotopic signatures ($^{206}\text{Pb}/^{207}\text{Pb}$ and $^{208}\text{Pb}/^{206}\text{Pb}$
36 ratios) and elemental ratios were determined in 23 Pb-rich samples collected inside NDdP. We
37 determined that the dust collected on wood substrates on the first floor was most
38 representative of fire emissions. These samples were the analyzed for the 4 Pb isotopes (204,
39 206, 207, 208) and the fire dust signature is characterized by ratio values of $^{206}\text{Pb}/^{207}\text{Pb}$: 1.1669
40 - 1.1685, $^{208}\text{Pb}/^{206}\text{Pb}$: 2.0981-2.1095, $^{208}\text{Pb}/^{204}\text{Pb}$: 38.307 – 38.342, $^{207}\text{Pb}/^{204}\text{Pb}$: 15.633 –
41 15.639 and $^{206}\text{Pb}/^{204}\text{Pb}$: 18.242 – 18.275. In addition, the fire dust presents typical element-
42 to-Pb ratio. This fingerprint was compared to the signatures of the known local Pb sources.
43 The geochemical fingerprint of the fire is significantly different from that of the dominant
44 urban Pb source. This will allow future evaluation of the contribution of the fire to Paris Pb
45 pollution and of the real extent of the area affected by the Pb-containing dust plume.
46 Moreover, the geographical origin of Pb used to for the roof restauration and the spire

47 building was identified. These findings open new ways to study the Pb sources in historical
48 monuments for environmental impacts evaluation, as well as for historical perspectives.

49 **Keywords:** historical monuments; lead isotopes; metals; environmental pollution; tracing
50 pollution

51

52

53 **1. Introduction**

54 Limiting lead pollution in an urban context is a major societal issue because this
55 neurotoxic metal has significant consequences on health, especially for children (e.g., Laidlaw
56 and Taylor, 2011; Landrigan et al., 2017). Notre-Dame de Paris cathedral (hereafter noted
57 “NDdP”), an emblematic monument of the Gothic architecture, is an iconic French monument.
58 The fire that took place on April 15, 2019, destroyed a large part of its lead-made roof and
59 spire. During the following days, citizens and the scientific community took great interest in
60 lead (Pb) pollution in the Parisian environment (Smith et al., 2020; van Geen et al., 2020; Vallée
61 et al., 2021). A tentative estimation suggests that 150 kg of Pb was spread during the fire
62 (Tognet and Truchot, 2019). Another study, based on the analysis of various soil samples,
63 estimated that the fire plume deposited one ton of Pb within 1 km of the cathedral, suggesting
64 that most of the fallouts occurred at a short distance of the cathedral (van Geen et al., 2020).
65 A study was performed, involving adults living or working in the nearby of the cathedral, to
66 highlight a variation in blood Pb levels (BLL). No increase in BLL was observed (Vallée et al.,
67 2021), tending to show that the fire emission did not affect the Parisian population. The reality
68 of an environmental impact of the fire is less clear. The analysis of dusts and soils collected in
69 tree pits, parks and streets surrounding NDdP tends to show higher Pb concentrations for the
70 samples collected under the plume (van Geen et al., 2020). Nevertheless, high Pb
71 concentrations around NDdP after the fire do not necessarily mean that the fire is now the
72 main source of Pb to Parisian soil. Indeed, a considerable spatial heterogeneity of the urban
73 contamination results from the mixture of sources changing over time and space and from
74 accumulation and erosion mechanisms (van Geen et al., 2020).

75 Lead contamination in Paris is an old story as seen in other major cities even though
76 the drivers of contamination (past use of Pb additives in gasoline, deterioration of exterior
77 paint, industrial emission, water supply) may differ from one city to another depending on its
78 historical development (Delile et al., 2016, Laidlaw et al. 2017; Delile et al, 2017). The ban of
79 leaded gasoline and other lead-containing products (e.g., lead paints) has drastically reduced
80 the concentration of Pb worldwide (e.g., Shotyk et al., 2005; Marx et al., 2016). However,
81 pervasive contamination is still observed in urban environments, such as Paris (France) and
82 London (UK) cities, where many sources of Pb still exist (e.g., roofs, paintings, waste
83 incinerators) (Ayrault et al., 2012, 2014; Resongles et al., 2021). To evaluate the potential
84 impacts of the NDdP fire, it is therefore essential to accurately define the geochemical
85 fingerprint of the fire by its Pb isotopic signature (Cheng and Hu, 2010; Ayrault et al., 2012;
86 Rosca et al., 2018) and by its elemental signature (Font et al., 2015; Lin et al., 2015). Such an
87 extended fingerprint is required in the context of urban environments where the Pb
88 concentration alone cannot demonstrate the environmental impact of leaded roofs, an
89 approach that proved valuable only in rural contexts where no other Pb source is observed
90 (Jørgensen and Willems, 1987).

91 Consequently, the use of Pb isotope ratios is mandatory to identify the origin of the
92 high Pb concentrations. Indeed honey samples were collected in Paris in the months following
93 the fire and their composition (Pb isotopes and elements) was analyzed (Smith et al., 2020).
94 Even though the median Pb isotope ratio of the honey samples (median $^{206}\text{Pb}/^{207}\text{Pb}$ ratio of
95 1.157 ± 0.003) similar to the signature of the Pb urban background of Paris ($^{206}\text{Pb}/^{207}\text{Pb}$ ratio
96 of 1.157 ± 0.003 , Ayrault et al., 2014), the Pb content of the honey collected under the plume
97 trajectory was attributed to the NDdP fire (Smith et al., 2020). Such a conclusion cannot be

98 drawn without a comparison of the environmental samples with the fire emission signature.
99 Unfortunately, no atmospheric particle was sampled during the fire.

100 Glouennec et al. (2021) determined the Pb isotope ratio in dust collected during July
101 2020 with wet wipes on different substrates inside NDdP (n=8) and roof remains (n=8). The
102 sampling method used did not allow any elemental analysis or observations of the collected
103 material, which could better constrain the fire emission signature or eliminate the risk of
104 contamination of the samples with pre-fire dust. The determined fire isotopic signature
105 ($^{206}\text{Pb}/^{207}\text{Pb}$: 1.167 ± 0.005) was considered ambiguous, preventing any evaluation of the
106 potential impact of the fire due to the overlapping signature of other Parisian Pb sources.
107 Nevertheless, we notice that this signature is different from today's urban Pb signature, which
108 is distinctly low due to the imprint of leaded gasoline used during the second half of the 20th
109 century.

110 To strip away the ambiguity about the environmental of NDdP fire, we performed a
111 complete geochemical study (elemental and Pb isotope signatures (^{204}Pb , ^{206}Pb , ^{207}Pb , ^{208}Pb))
112 using all the available dust samples collected inside the cathedral. First, (1) we developed an
113 appropriate step-by-step strategy to reveal the samples most representative of the fire
114 emission. In addition, we proposed a robust protocol for future dust sampling in historical
115 monuments. The objective is to be able to compare the data in the future (between
116 monuments, after restoration works, and in case of another tragedy). (2) After selecting the
117 samples representative of the dust emitted during the fire, we determined the geochemical
118 signature of the leaded particles emitted by the fire. We compared the NDdP fire fingerprint
119 with the different Pb sources already identified in the Parisian environment, to help with
120 future environmental evaluation. (3) The geographical origin of the Pb ores used during the

121 restauration of the burnt roof and the construction of the spire was established. It is of interest
122 for historical studies of Pb circulation during the 19th century.

123 A large range of elements were analyzed on the diverse samples collected in NDdP: the
124 elements commonly analyzed in an urban context, such as Cd, Cu, Sb, and Pb (Le Gall et al.,
125 2018; Smith et al., 2019), as well as elements, such as Ag, Sn and Bi, which can be associated
126 with Pb in historical monuments (Sylvilay et al., 2015; L'Héritier et al., 2016; Comite et al.,
127 2019). In addition, to document the signature of Pb used during the first stages of NDdP
128 building, the Pb stable isotope ratio was also measured on "construction" Pb samples from
129 Sainte-Chapelle and Chartres Cathedral, monuments contemporaneous to NDdP whose roofs
130 have already burnt down (Shelby, 1981; Cohen, 2008).

131 2. Historical context

132 NDdP, located on the "Ile de la Cité" in the 4th arrondissement of Paris, is an
133 emblematic monument in France (Figure 1A and 1B). Its construction was initiated in the
134 second half of the 12th century by Maurice de Sully, who designed an exceptional monument
135 that was 127 m long, 40 m wide and 33 m high (Figure 1C) and was the largest Christian
136 monument at that time.

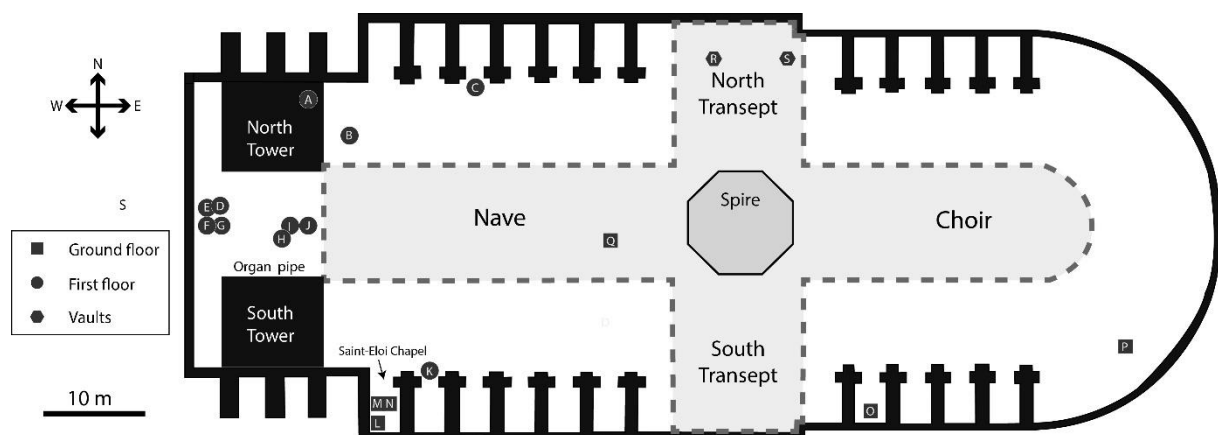

137

138 **Figure. 1. Geographic context of Notre-Dame de Paris.** A. Picture and B. location of this monument in
139 Paris city. C. Map of Notre-Dame de Paris cathedral (modified after Aubert, 1920) and location of
140 samples collected in this study (illustrated by the letters).

141 At the time of this study, NDdP was not yet accessible for sampling Pb joints, which are
142 usually implemented in medieval construction to bind stones or seal iron armatures in early
143 NDdP construction campaigns. Two major monuments coeval with original phases of
144 construction of NDdP (late 12th-mid. 13th centuries) and located in the same region were
145 chosen to determine the extent of the medieval Pb isotopic signature: Chartres cathedral (beg.
146 13th century) and the Sainte-Chapelle of Paris (mid. 13th century).

147 **3. Materials and Methods**

148 *3.1 Fire dust and lead metal sampling*

149 No NDdP sample was collected directly in the smoke plume or around the cathedral
150 during or just after the fire. Indeed, intensive washing of the forecourt and roadway was
151 conducted over the following days. In addition, access into the cathedral for scientists for dust
152 sampling was denied until June 2019, where access was extremely limited. The fire dust
153 deposited in the cathedral appeared to be the most appropriate material to represent the Pb
154 particles likely to contaminate the environment, rather than sampling metallic remains of the
155 burnt roof, which can exhibit different geochemical signatures depending on their
156 construction and restoration phases (L'Héritier et al., 2016; Glorennec et al., 2021). Ideally,
157 the dust samples should have been collected immediately after the fire and only on dedicated
158 supports previously tested for their low element content. In practice, dust samples were
159 collected whenever and wherever it was possible from June 2019 to February 2020 on several
160 substrates (wood, metal, glass, fabric – described in Table S1) at the ground and first floors
161 (Fig. 1). Dust from the vaults falling on the ground with the spire collapse was also collected.

162 Dust was collected with a polypropylene spatula, and the material was stored in a tightly
163 closed polyethylene box. To clarify the comparison with previously published data, Glorennec
164 et al. (2021) further sampled dust by using wet wipes at 8 of the 16 sites in the present study.

165 Subsequent binocular magnifying glass observations of the collected dusts highlight
166 the presence of a “fiber and dust” fraction in 4 samples in addition to the “only dust” fraction
167 present in all samples, e.g., the ND160919-01 sample collected on the stained-glass window
168 revealed dust trapped in a fiber aggregate (Table S1). The two different matrices were
169 analyzed separately. The “fiber and dust” fraction is collected from the original sample box
170 with a plastic clamp; the latter is gently shaken to remove as much dust as possible from the
171 fibers, and then the fibrous aggregate is placed in another plastic box. In addition, a paint
172 fragment was identified and isolated in the dust of sample ND160919-01 collected on the
173 stained glass window during microscopic observation. Two crusts of melted Pb were sampled
174 using a chisel at 2 sites of the vaults (Table S1). To summarize, 23 samples are analyzed in this
175 study: 16 “dust” samples, 4 “fiber and dust” subsamples, 2 “crust” samples and 1 “painting”
176 fragment sample.

177 Metallic Pb samples of less than 1 cm in size were cut with a chisel on Pb joints directly
178 in the studied buildings: Chartres cathedral (n=14) and the Sainte-Chapelle of Paris (n=8).
179 These Pb samples were first analyzed by LA-ICP-MS to determine their element
180 concentrations (L’Héritier et al., 2016). Then, Pb samples with low Sn contents ($< 10 \text{ mg kg}^{-1}$),
181 which are unlikely to come from recycling (Wytttenbach et al., 1973), were selected for Pb
182 isotopic analysis.

183 *3.2. Sample preparation*

184 A total digestion procedure was applied (Le Gall et al., 2018). Samples (~1 to 12 mg)
185 were introduced into closed PTFE beakers heated on a hot block (Digiprep, SCP Science) with
186 ultra-pure concentrated acids (67% HNO₃: Normatom grade, VWR; 34-37% HCl, 47-51% HF,
187 65-71% HClO₄: TraceMetal grade, Fisher Scientific). The first step consisted of adding 4 mL HF
188 and 2 mL HClO₄ for 6 hours at 150 °C, followed by evaporation to dryness. Second, aqua regia
189 (5 mL) was added to the beakers heated at 120 °C for 3 hours. One mL of HNO₃ was added to
190 the solution which was evaporated near dryness (3 times) before it was made up to 50 mL in
191 HNO₃ 0.5 N. The accuracy of the measured concentrations was checked using two certified
192 reference materials (CRM: IAEA lake sediment SL-1 and IRMM road dust BCR-723) and a
193 chemical blank.

194 Construction Pb samples were first scoured with a scalpel blade to remove the
195 encrustation. A second scalpel blade was used to take 20 to 50 mg of pure Pb. These Pb pieces
196 were cleaned 3 times with 1 mL of 5 N HNO₃ for 10 min. The cleaned pieces were then partly
197 dissolved in 1 mL of 5 N HNO₃ for 10 min, and the solution was collected using a pipette.

198 *3.3. Elemental composition analysis*

199 Element concentrations were determined using a Thermo Scientific™ iCAP™ TQ ICP–
200 MS equipped with a Peltier cooled cyclonic spray chamber, glass concentric nebulizer (400 µL
201 min⁻¹) and 2.5 mm internal diameter quartz torch in Laboratory LSCE (Gif-Sur-Yvette, France).
202 Two different measurement modes were selected in this study depending on the analyte
203 analyzed and its interferants (Table S2). The certified riverine water standard SRM-1640a
204 (National Institute for Standard Technology, NIST, USA) is additionally used to judge the
205 calibration curve essential to propose concentration values. The concentration values
206 obtained for the CRMs were within 15% of the certified values, and within 10% (except Mg

207 and Al: 30 %) for BCR-723 and SL-1, respectively. The standard deviation (SD) was lower than
208 5% except for Ag (10 %). For more details, see the Supporting Information.

209 *3.4. Lead isotope composition analysis*

210 LSCE: Pb isotope ratios ($^{208}\text{Pb}/^{206}\text{Pb}$ and $^{206}\text{Pb}/^{207}\text{Pb}$) were analyzed in the solutions that
211 were also used for Pb concentration determinations. Analyses were also made with a Thermo
212 ScientificTM iCAPTM TQ ICP–MS in Laboratory LSCE (Gif-Sur-Yvette, France). Mass bias and drift
213 of the isotope ratios were corrected based on repeated measurements of the Pb reference
214 material NIST SRM-981 that were analyzed between every two samples. The certified values
215 used for the SRM-981 calculation are $^{206}\text{Pb}/^{207}\text{Pb} = 1.0933 \pm 0.0004$ and $^{208}\text{Pb}/^{206}\text{Pb} = 2.1681$
216 ± 0.0008 . The 2σ errors (2SD) of isotope ratios are 0.29% and 0.27% for the $^{206}\text{Pb}/^{207}\text{Pb}$ and
217 $^{208}\text{Pb}/^{206}\text{Pb}$ ratios, respectively. The digestion blank was lower than 0.2 ng mL^{-1} , while the
218 analyzed solutions were at 2 ng mL^{-1} after 100-100000 times dilution of the digestion solution.
219 The $^{206}\text{Pb}/^{207}\text{Pb}$ and $^{208}\text{Pb}/^{206}\text{Pb}$ ratio measured for the CRM agree with the published values:
220 0.13% and 0.09%, 0.16% and 0.16%, for IAEA lake sediment SL-1 and IRMM road dust BCR-
221 723, respectively (Table S3).

222 SARM: Among the whole samples batch, 11 were chosen to measure all the Pb isotopic
223 ratios. These aliquots - which contain $\sim 4 \text{ ng}$ of Pb each - were sent to the SARM laboratory,
224 a National Service of CNRS (<https://sarm.cnrs.fr>). After evaporation, each residue was taken
225 back in bromidic acid (HBr) solution and loaded on anionic resin (AG1X8) to separate Pb from
226 sample matrix (Manhes et al., 1980). Samples were analysed by using an MC-ICP-MS
227 equipment (Neptune+ from Thermo). The NIST SRM 981 and NIST 997 Tl reference materials
228 (ratio 1/10) were used to correct the instrumental mass bias (White et al., 2000). Values used
229 for both reference materials were taken from Thirlwall (2002). The total procedural blank is

230 negligible in the entire session. The NIST-SRM 981 Pb precision and accuracy of all the reported
231 isotopic ratios are better than 250 ppm (2SD). The $^{208}\text{Pb}/^{206}\text{Pb}$ and $^{206}\text{Pb}/^{207}\text{Pb}$ ratio results
232 obtained at LSCE and SARM are in good agreement (supplement information, Fig S1.1).

233 **4. Results**

234 *4.1. Elemental composition of NDdP samples*

235 The Pb concentrations of the NDdP samples ranged from 24.6 to 967.9 g kg⁻¹ (median:
236 160 g kg⁻¹; S3; Figure 2). The concentrations of the samples collected on wood, fabric, stained
237 glass, metal substrates and the painting fragment were very close to the median value
238 compared to the samples collected on crusts and in the vault dusts, where the Pb
239 concentrations were 3 times higher.

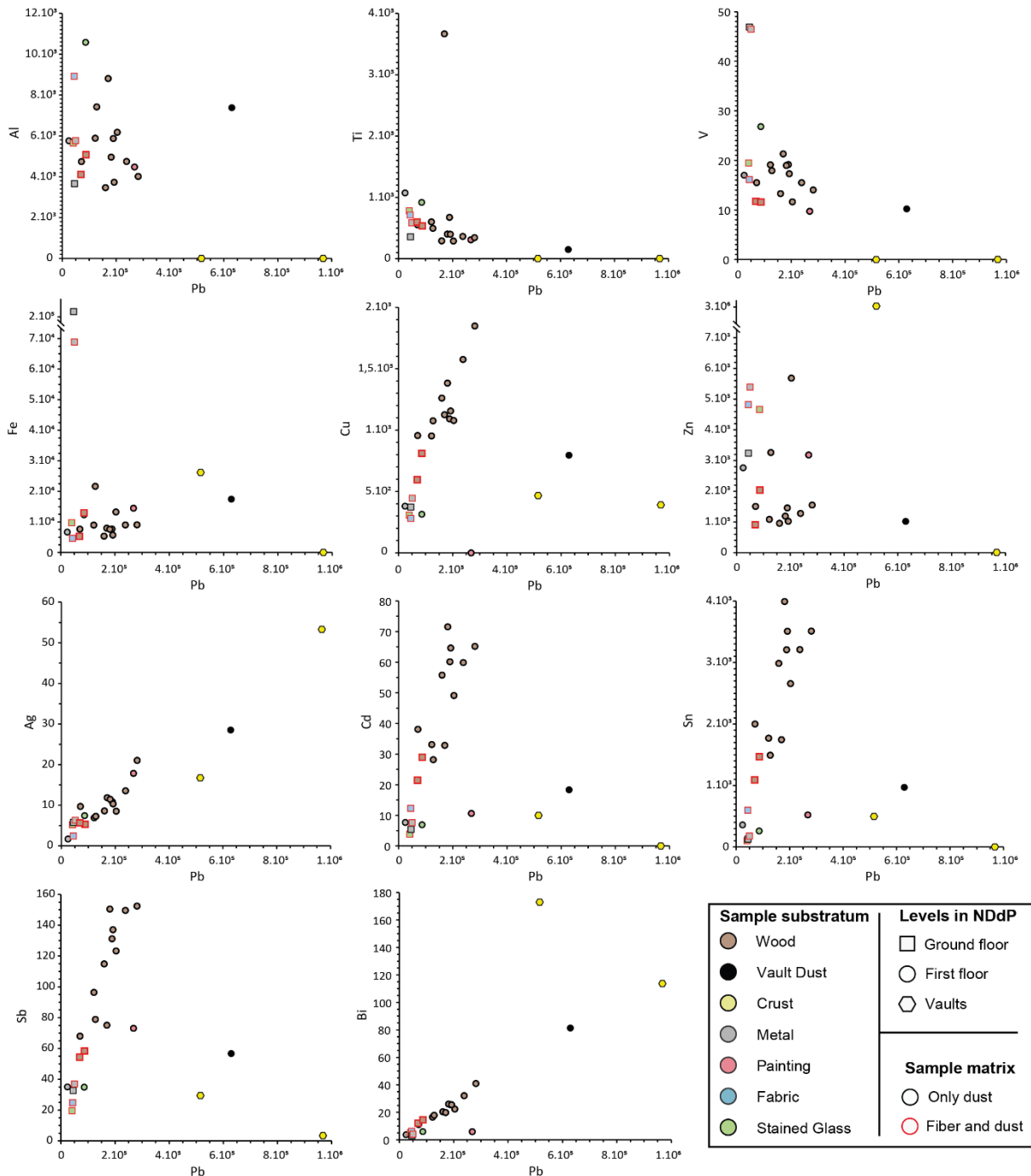

240
 241 **Fig. 2. Bivariate concentration plots of selected element concentrations versus Pb concentrations for**
 242 **NDdP samples collected from 2019–2020 by the LRMH laboratory (unit: mg kg⁻¹).** Each color
 243 corresponds to a substrate type where the dust samples were collected (brown = wood; black = vault
 244 dusts; yellow = crust; gray = metal; pink = painting; blue = fabric; green = stained glass) and the symbol
 245 corresponding to the level of collected substrate in NDdP (square = Ground floor; circle = First floor;
 246 hexagon = Vaults). The sample matrix is represented by the outline color of the dots; the black outlines
 247 correspond to the dust-only fraction, and the red outlines correspond to the fiber and dust fraction.

248 For the other elements, the concentration depended on the substrate (Figure 2). This
 249 was particularly the case for Fe and V, where the most concentrated samples were collected
 250 on the metal substrate. The samples with the highest concentrations in Cu, Cd, Sn and Sb,

251 were collected on wood substrate. The samples collected on crusts and vault dusts were
252 enriched in Ag and Bi. Moreover, Ti and Zn concentrations were very variable, with a single
253 sample collected on wood rich in titanium and a single sample collected on a crust rich in zinc.
254 Al concentrations are generally higher, especially for the dusts collected on the fabric and on
255 the stained glass and with the exception of the two crust samples. Concentrations of the other
256 measured elements are given in Table S4.

257 *4.2. NDdP samples and other historical monuments lead isotope compositions*

258 Each sample analyzed for elements was also measured for radiogenic Pb isotopes to
259 determine the $^{208}\text{Pb}/^{206}\text{Pb}$ and $^{206}\text{Pb}/^{207}\text{Pb}$ ratios at LSCE (Figure 3). The $^{206}\text{Pb}/^{207}\text{Pb}$ values
260 range between 1.1584 ± 0.0040 and 1.1780 ± 0.0033 (median: 1.1684) and $^{208}\text{Pb}/^{206}\text{Pb}$ values
261 ranging between 2.0896 ± 0.0057 and 2.1051 ± 0.0113 (median: 2.0971). The isotopic results
262 highlighted two endmembers depending on the substrate. The first isotopic endmember
263 characterized by a high $^{208}\text{Pb}/^{206}\text{Pb}$ ratio and a low $^{206}\text{Pb}/^{207}\text{Pb}$ ratio was represented by the
264 samples collected on the outdoor crusts and a sample collected on the wood substrate, while
265 the second isotopic endmember characterized by a low $^{208}\text{Pb}/^{206}\text{Pb}$ ratio and a high $^{206}\text{Pb}/^{207}\text{Pb}$
266 ratio was represented by the painting fragment and the samples collected on the stained glass
267 window and metal substrate (Figure 3; Table S4). The Pb isotope ratios of samples collected

268 on wood, fabric and vault dusts vary between these two endmembers.

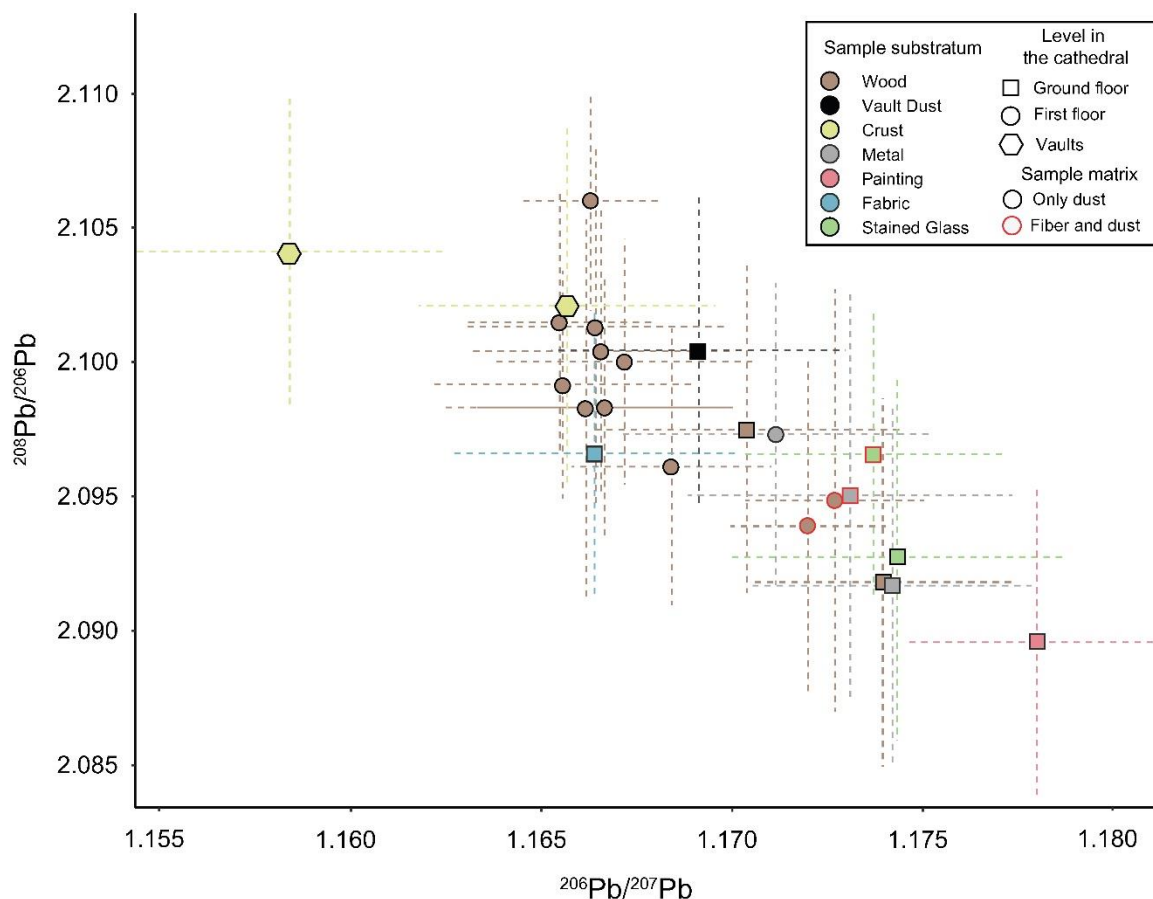

269

270 **Fig. 3. Lead isotopic compositions of all NDdP samples from this study.** The symbol corresponds to
271 the level of collected substrate in NDdP (square = ground floor; circle = first floor; hexagon = vaults),
272 and the color corresponds to substrate type where samples were collected in cathedral (brown =
273 wood; black = vault dusts; yellow = crust; gray = metal; pink = painting; blue = fabric; green = stained
274 glass). The sample matrix is represented by the outline color of the dots; the black outlines correspond
275 only to the dust fraction, and the red outlines correspond to the fiber and dust fraction.

276 The samples representative for the NDdP fire dust (n=9, see section 5.1) were also
277 measured for Pb isotopes to determine the ratios $^{208}\text{Pb}/^{204}\text{Pb}$, $^{207}\text{Pb}/^{204}\text{Pb}$ and $^{206}\text{Pb}/^{240}\text{Pb}$
278 ratios at SARM. The Pb isotopic signatures average (median values) 18.252 ± 0.001 for
279 $^{206}\text{Pb}/^{204}\text{Pb}$, 15.634 ± 0.002 for $^{207}\text{Pb}/^{204}\text{Pb}$ and 38.307 ± 0.007 for $^{208}\text{Pb}/^{204}\text{Pb}$ (Table S7).

280 *4.3. Lead isotope compositions of lead artifacts from other historical monuments*

281 The Pb isotopic signatures obtained in construction Pb of the Sainte-Chapelle ranged
282 between 1.1760 ± 0.0089 and 1.1856 ± 0.0138 (median: 1.1829) for $^{206}\text{Pb}/^{207}\text{Pb}$ values and
283 between 2.0736 ± 0.0086 and 2.1011 ± 0.0259 (median: 2.0828) for $^{208}\text{Pb}/^{206}\text{Pb}$ values. They
284 are generally consistent with the Chartres cathedral results, with values ranging between
285 1.1793 ± 0.0065 and 1.1882 ± 0.0103 (median: 1.1858) for $^{206}\text{Pb}/^{207}\text{Pb}$ ratios and between
286 2.0616 ± 0.0202 and 2.0914 ± 0.0139 (median: 2.0771) for $^{208}\text{Pb}/^{206}\text{Pb}$ ratios (Table S5).

287 5. Discussion

288 5.1. Defining the dust samples representative of the NDdP fire emissions

289 Knowing that no dust sample could be directly sampled in the plume, our first purpose
290 is thus to select samples representative of the dust emitted during the fire and to propose a
291 sampling scheme that could be applied to historical monuments.

292 The first step of the procedure is the binocular observations, which allowed to separate
293 the mixture of fibers and dust for 4 samples revealed primarily a homogeneity of the Pb
294 isotope ratios (Figure S1) unrelated to the substrate but lower elemental concentrations
295 compared to the “only dust” fraction (Figure S2; Table S6), which may suggest dilution and/or
296 contamination of the NDdP fire signature by the presence of fibers. The elemental content
297 and the Pb isotope ratio obtained for the “only dust” fraction with respect to the data
298 obtained in the “fiber and dust” fraction are discussed in depth in the Supporting Information.
299 Following this discussion, we will focus on the “only dust” more representative of the NDdP
300 fire for the remainder of this discussion.

301 The second step relies on the elemental analysis data, to infer any contamination from
302 the sampling substrate (Fig. 2). The observed large concentration scattering can be linked to

303 a potential contamination originating from the substrate. Such contamination is well known,
304 and for atmospheric particle collection, inert (plastic) substrates are recommended (Amodio
305 et al., 2014). This is potentially the case for crust samples. Sample ND140619-01 was collected
306 on ridge crest reinforcements and could only represent the local melted Pb. ND140619-04 was
307 collected on an outdoor upper surface stone where current urban pollution is plausible. Thus,
308 These two samples were no more considered.

309 The vault dust (ND080719-02) collected indoor on the pavement of NDdP could be a
310 mixture of the fire emissions with rubble and other various debris coming from the structure
311 of NDdP roof. The elemental composition of the painting fragment isolated in the dust of
312 sample ND160919-01 testifies to a local signature characteristic of one paint used during one
313 of the numerous renovation episodes of NDdP and cannot represent the fire signature.

314 Elemental concentrations lower than the average of content were found for 3 dust
315 samples: sample ND160919-04 collected on iron armatures, sample ND160919-01 collected
316 on stained glass and sample ND140619-07 collected fabrics (Fig. 2). The first one presents
317 high Fe concentration while the two later present high Al content (Fig. 2). These high Fe and
318 Al concentrations may evidence contamination by the substrate, implying a less obvious
319 contamination for other elements. Moreover, several Pb sources can originate from the
320 stained glass windows: anti-rust paints of the iron armatures, Pb joints of the window
321 masonry and Pb comes. Thus, these three samples were discarded.

322 To approach the fire signature, it is essential to focus on an inert substrate. Figure 2
323 shows that the samples collected on wood show very consistent elemental content. Wood is
324 naturally poor in metals, except in areas with high metal contamination (Watmough and
325 Hutchinson, 1996; Yu et al., 2007; Sawidis et al., 2011). Previous studies exhibited

326 concentrations ranging from 0.1 – 5, 5 – 10, 0.5 – 30 and 1 – 20 mg kg⁻¹ for Pb, Zn, Cu and Ni,
327 respectively, in Scots pine and Norway spruce wood (Harju et al, 1996; Saarela et al., 2005).
328 These values are far lower than the concentrations in NDdP dust. Thus, the potential
329 contamination of the samples by the wood substrate is considered negligible. By estimating
330 that the elemental signature of the NDdP fire corresponds only to the dust fraction of the 9
331 samples collected on wood furniture, the Pb concentration range was between 70.9 and 281.6
332 g kg⁻¹ (median: 181 g kg⁻¹), which is the most concentrated element (Fig. 2; Table S4).

333 To refine the choice of the samples most representative of the fire emission, we
334 combined the elemental ratios with the Pb isotopic ratios. To understand the isotopic
335 variability of the dust collected on the wood substrate (Fig. 3), we questioned the impact of
336 the dust location in the building; namely the ground floor, the first floor or the vault. We
337 observed that the height of the sample in the cathedral affects the Pb isotopic signature: high
338 isotopic values in ²⁰⁶Pb/²⁰⁷Pb for dust sampled at ground level and low isotopic values in
339 ²⁰⁶Pb/²⁰⁷Pb for samples collected at the first floor (Fig. 3). A potential contamination by
340 preexisting accumulated dust can explain this difference between the samples of the first floor
341 and the ground floor. Indeed, while it is complex to estimate the cleaning frequency of all the
342 substrates, the wood-made furniture (such as the altar or the seats) are frequently dusted.
343 This is particularly true for the organist bench (ND140619-06) which is known to be frequently
344 cleaned and the organist was notably performing on the evening of the fire. Furthermore, this
345 isotopic difference could also have been produced by a heterogeneous air flow and dust
346 deposition between upper (first floor) and lower parts (ground floor) during the fire. In
347 particular, the spire fall could have caused the fall of coarser dust (i.e., stone and wood debris)
348 on the lower parts. As a consequence, the dust collected on the cathedral ground floor was
349 not composed only of fire dust. Indeed, with the exception of Zn and Al, the samples from the

350 ground floor seem to have lower Cu, Cd, Sn, Sb, Pb and Bi concentrations than the samples
 351 collected on the first floor, although the difference is subtler (Figure 2). These lower element
 352 concentrations can be explained by a considerable dilution by the important quantity of coal
 353 and rubble in the dust collected at the ground floor. Consistently with the elemental data, the
 354 dust collected on the wood substrate of the first floor shows very congruent Pb isotopic
 355 measurements.

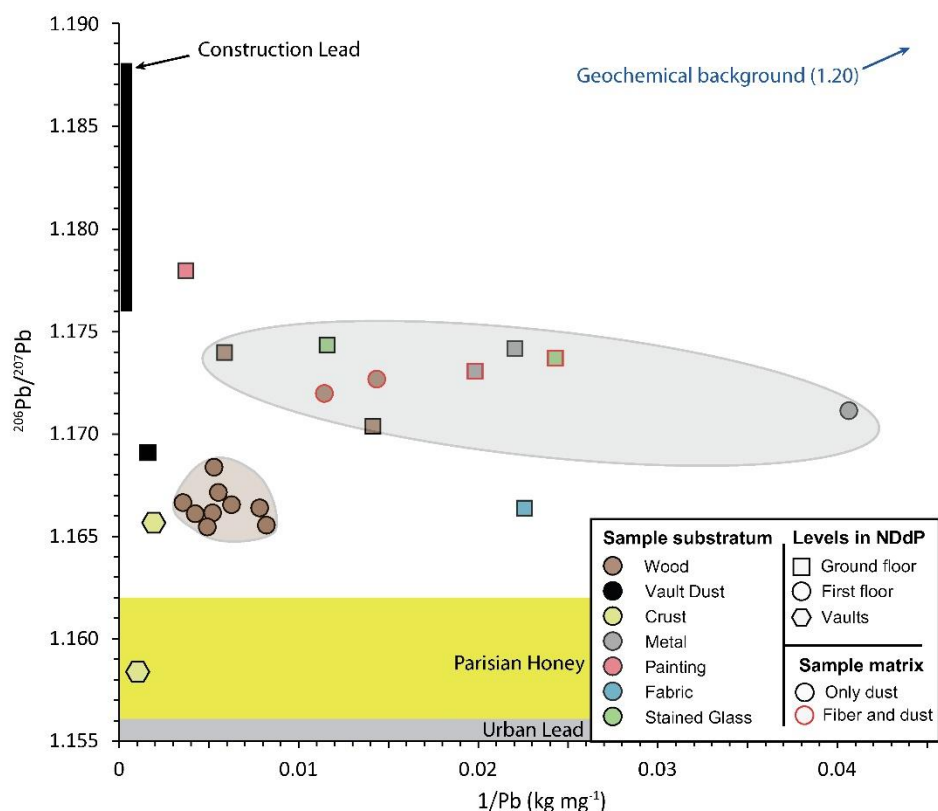

356
 357 **Fig. 4.** $^{206}\text{Pb}/^{207}\text{Pb}$ ratio of all analyzed NDdP dusts as a function of the $1/[\text{Pb}]$ ratio (kg mg^{-1}). The
 358 symbol corresponds to the level of collected substrate in NDdP (square = ground floor; circle = first
 359 floor; hexagon = vaults), and the color corresponds to substrate type where samples were collected in
 360 cathedral (brown = wood; black = vault dusts; yellow = crust; gray = metal; pink = painting; blue = fabric;
 361 green = stained glass). The sample matrix is represented by the outline color of the dots; the black
 362 outlines correspond only to the dust fraction, and the red outlines correspond to the fiber and dust
 363 fraction.

364 We conclude that the fire signature can be better approached by the dust collected on
 365 the wood substrate of the first floor. Figure 4 shows that these samples (brown circles) design
 366 a clearly defined and sharp area with converging Pb isotope ratio and high Pb content. This

367 area is very distinct from the one grouping the other samples collected in NDdP. Those
368 samples, while having a very scattered Pb content, have quite homogeneous Pb isotope ratio
369 which could be interpreted as the signature of the Pb present in the NDdP indoor dust before
370 the fire. The validation of this hypothesis would need a dedicated work, which may rely on a
371 comprehensive comparison of the geochemical signature of dust collected in coeval unburnt
372 monuments such The Sainte Chapelle (Paris).

373 *5.2. Identifying and tracing the leaded NDdP fire emissions in the Parisian environment*

374 The most appropriate samples (i.e., collected on wood substrate at the first floor)
375 defined the signature of the NDdP fire with values in $^{206}\text{Pb}/^{207}\text{Pb}$ between 1.1655 ± 0.0025 and
376 1.1684 ± 0.0043) and values in $^{208}\text{Pb}/^{206}\text{Pb}$ between 2.0961 ± 0.0042 and 2.0961 ± 0.0113 with
377 median values at 1.1664 ± 0.0034 and 2.1000 ± 0.0051 respectively. These ratio values are
378 consistent with those proposed by Glorennec et al. (2021) for dust samples $^{206}\text{Pb}/^{207}\text{Pb}$ ratio:
379 1.167 ± 0.005 . Among the 8 dust samples collected by Glorennec et al (2021), 4 are out of the
380 area defining the NDdP fire signature because of outliers in the determination of the ratio
381 $^{208}\text{Pb}/^{206}\text{Pb}$ (Fig. 5). The here determined signature of the NDdP fire is more accurate, opening
382 the way to a reliable evaluation of its uniqueness among the other sources of Pb in the Parisian
383 environment.

384 During the 20th century, three Pb signatures were identified in Paris city (Ayrault et al.,
385 2012): (1) Pb used during the 19th century for Haussmann's renovation of Paris city, imported
386 from Spain (Lestel, 2012), imprinting the Seine River sediment before 1960 and after 2000
387 which $^{206}\text{Pb}/^{207}\text{Pb}$ ratio is $\approx 1.1650 \pm 0.0025$ and $^{208}\text{Pb}/^{206}\text{Pb}$ ratio is $\approx 2.1047 \pm 0.0046$ (Ayrault
388 et al., 2012); (2) Pb used in leaded gasoline ($^{206}\text{Pb}/^{207}\text{Pb} = 1.08 \pm 0.02$ and $^{208}\text{Pb}/^{206}\text{Pb}$ ratio is \approx
389 2.18 ± 0.02 (Monna et al., 1997; Véron et al., 1999)), used until its ban on 2000, containing

390 high proportions of Australian Pb from the Broken Hill mine; and (3) the local natural
391 background signature ($^{206}\text{Pb}/^{207}\text{Pb}=1.201 \pm 0.001$, $^{208}\text{Pb}/^{206}\text{Pb}=2.0527 \pm 0.0020$; (Elbaz-
392 Poulichet et al., 1986)), which appears negligible in downtown Paris but can be detected in
393 less urbanized areas. A fourth Pb source, the dominant Pb isotopic signature in Paris street
394 dust, called the “urban” Pb, is characterized by relatively high $^{208}\text{Pb}/^{206}\text{Pb}$ ratios (range: 2.088–
395 2.115; median: 2.107) and low $^{206}\text{Pb}/^{207}\text{Pb}$ ratios (range: 1.142–1.166; median: 1.155) (Figs 4
396 and 5) and represents a mixture of urban Pb and leaded gasoline (Ayrault et al., 2014). Indeed,
397 the pervasive contamination of the urban environment due to banned leaded gasoline was
398 also observed in London (Resongles et al., 2021).

399 Not surprisingly, the signature of the NDdP fire is far from the geochemical local
400 background. The fire Pb signature of the burnt roof (XIXe) is logically different from the
401 construction Pb signatures (Fig. 5). The age of historical monuments whose signatures are
402 showed oscillates between the 12th and 13th centuries (e.g., Sainte-Chapelle in Paris and
403 Chartres Cathedral; Table S5) and the 17th century (Versailles Palace; Pons-Branchu et al.,
404 2015) with $^{206}\text{Pb}/^{207}\text{Pb}$ ratios ranging between 1.1760 ± 0.0089 (Sainte-Chapelle de Paris) and
405 1.1882 ± 0.0103 (Chartres Cathedral) (Table S5; Figure 5). Three of the 8 undated Pb artifacts
406 collected by Glorennec et al. (2021) lie in this area drawn by the 12th – 17th construction Pbs.

407 Most importantly, the NDdP fire geochemical signature is significantly different from
408 today’s urban Pb signature (Fig. 5) represented by municipal solid waste combustors (Widory
409 et al., 2004) and wastewater suspended particle matter (Ayrault et al, 2012). On the opposite,
410 the “urban” signature is found on PM₁₀ fine particles collected in Paris in 2003 (Widory et al.,
411 2004) and in honey produced in Paris and collected within 6 months after the fire (Smith et
412 al., 2020). Despite their high Pb content, it shows that the honey samples did not register the

413 NDdP fire emissions but the pervasive urban Pb. Indeed, soils and honeys are potentially likely
 414 to collect all the urban Pb sources present in Paris before, during and after the fire.

415

416

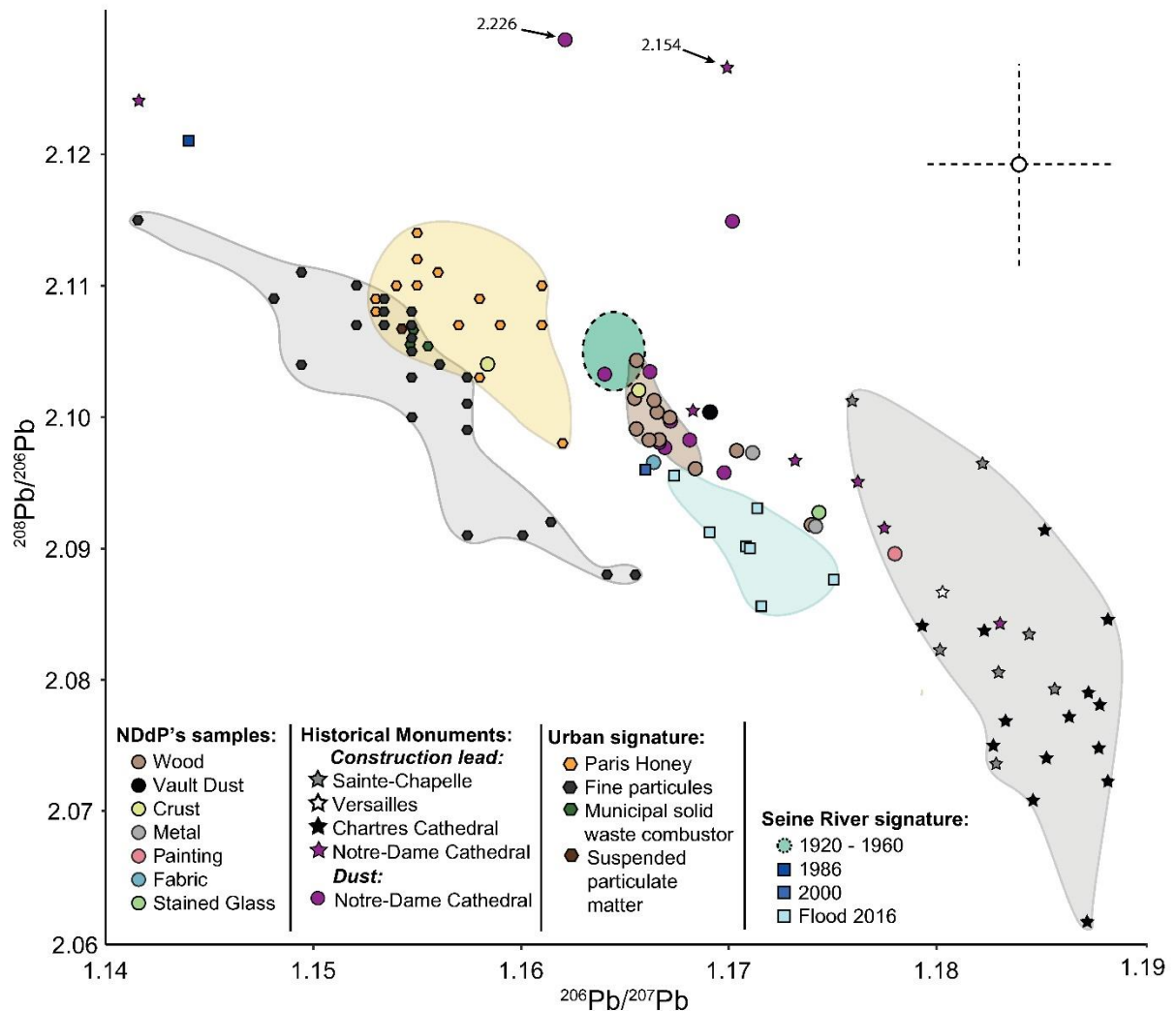

417

418 **Fig. 5. Lead isotopic composition of all analyzed NDdP samples and historical monuments (Sainte-**
 419 **Chapelle and Chartres Cathedral) from this study compared with local anthropogenic sources, and**
 420 **other historical monuments.** Dust and Pb artifacts from a previous study collected in NDdP are also
 421 shown (purple circles and stars, Glorennec et al., 2021). Other sources include Versailles Palace (Pons-
 422 Branchu et al., 2015), Paris honey (Smith et al., 2020), fine particles (Widory et al., 2004), municipal
 423 solid waste combustors (Widory et al., 2004), wastewater suspended particle matter (Ayrault et al,
 424 2012) and separate Seine River signatures with ratios obtained between 1920-1960 in 1986 in 2000

425 (Ayrault et al., 2012) and the Seine River flood in 2016 (Le Gall et al., 2018). The typical errors of NDdP
426 samples (this work) are lower than 0.0044 and 0.0078 in $^{206}\text{Pb}/^{207}\text{Pb}$ and $^{208}\text{Pb}/^{206}\text{Pb}$, respectively.

427 The NDdP fire Pb isotope signature is close to the isotopic signature of the Seine River
428 sediments collected after 2000 (Ayrault et al., 2012). The Seine River Pb contamination results
429 from the Pb used during the construction of the Haussmannian Paris, which is
430 contemporaneous of the last large restauration of the NDdP roof. We hypothesize that the Pb
431 used for ~~the~~ NDdP restauration and its spire construction was of the same origin as Pb used
432 for the Haussmann buildings. Therefore, it will be fundamental to couple the elemental ratios
433 and the Pb isotope ratio, and may be also carbon isotopes (Widory et al, 2004) to evaluate the
434 impact of ~~the~~ NDdP fire on the Seine River sediment contamination.

435 The NDdP fire dust concentrations of Pb and some elements are clearly higher than
436 those found in an urban context (Pio et al., 2013; Font et al., 2015; Smith et al., 2019; 2020).
437 Some are companion elements of Pb (Cu, Ag, Sb, Bi). Consistently, the concentration of Pb and
438 the concentrations of these elements are correlated (Table 1). Tin (Sn) presents also high
439 concentrations in the NDdP fire dust. van Geen et al. (2020) also noted high Sn concentration
440 in the soil samples collected at the proximity of the cathedral and suggested that the Sn/Pb
441 ratio could be used as a fire marker. Unfortunately, no Sn-Pb correlation was found in the dust
442 samples representative of the NDdP fire, preventing the use of Sn/Pb ratios as a fire marker.
443 The origin of Sn in ~~the~~ NDdP fire dust can be the anti-corrosion coating applied on the Pb
444 tables and/or the use of Sn in solder used for welding. These diverse uses of Sn may explain
445 why Sn and Pb are not correlated.

446 The elemental ratios for the NDdP fire dust are compared to ratios observed in urban
447 environmental atmospheric particle and street dust samples Table 1). In literature, several
448 elemental ratios are used to trace the road traffic signature in urban environments. Indeed,

449 road traffic is an important source of inorganic contaminants to the Parisian environment
 450 (Gasperi et al., 2021), and elemental ratios are powerful tools to examine the impact of traffic-
 451 related metal and metalloid sources (e.g., Charlesworth et al., 2011). The Sb/Cu ratio, widely
 452 used in tunnels (Lin et al., 2015), ranges between 0.08 and 0.88 with an average of 0.16 (Gillies
 453 et al., 2001; Pio et al., 2013). The Sb/Cu ratio of NDdP is 0.10 ± 0.02 (0.07 – 0.12), which is not
 454 distinct enough from the road traffic signature to be use as a NDdP fire marker. Interestingly,
 455 the NDdP Sb/Cu ratio appears to be higher than the Sb/Cu ratio of 0.021 determined from
 456 elemental data from the Parisian honey study (Smith et al., 2020), confirming that the honey
 457 collected within 6 months after the fire did not register the fire emissions. The Sn/Cu ratio can
 458 also be used to trace the road traffic signature.

459 **Table 1. Elemental ratio calculated for the NDdP fire signature obtained for the 9 samples**
 460 **representative of the NDdP fire (Pearson test < 0.05) and values proposed in the literature.**

Ratio	This study					Parisian honey (Smith et al., 2020)	Tunnel dust (Lin et al., 2015)
	Median	SD	Range	R ²	p value		
Cu/Pb	0.0066	0.001	0.0053 – 0.0084	0.71	0.004	5.16	-
Sb/Pb	0.00069	0.00009	0.00054 – 0.00083	0.70	0.005	0.114	-
Cd/Pb	0.00027	0.00006	0.00022 – 0.00039	0.47	0.042	0.011	-
Bi/Pb	0.00013	0.00001	0.00011 – 0.00015	0.92	< 0.0001	-	-
Ag/Pb	$\frac{0.00005}{7}$	0.000009	0.000042 – 0.000075	0.82	0.001	-	-
Sb/Cu	0.10		0.07 – 0.12	0.88	0.029	0.021	0.08-0.88

461

462 To conclude, these findings leave some space to use Pb isotopes as an indicator of the
 463 presence or absence of NDdP fire Pb in Parisian environment (streets, playgrounds ...), at least

464 in favorable cases (i.e., low pre-fire Pb contamination). Element (Cu, Sb, Ag, Bi) to Pb
465 concentration ratio can be used as additional marker of the fire dust deposition extent.

466 *5.3. Locating the ore origin(s) of the burnt roof.*

467 To identify the geographic origin of the Pb of the Notre Dame fire dust, the $^{208}\text{Pb}/^{204}\text{Pb}$
468 versus $^{206}\text{Pb}/^{204}\text{Pb}$ ratio and $^{207}\text{Pb}/^{204}\text{Pb}$ versus $^{206}\text{Pb}/^{204}\text{Pb}$ Pb ratio were performed (Table S7) to
469 refine the characterization by the use of ^{204}Pb , which is stable since the Earth formation's.
470 Ellam et al. (2010) demonstrated that several Pb sources are not distinguished if the ^{204}Pb
471 isotope is not considered in the ratio. Indeed, $^{206}\text{Pb}/^{204}\text{Pb}$ ratios coupled with $^{208}\text{Pb}/^{204}\text{Pb}$ and
472 $^{207}\text{Pb}/^{204}\text{Pb}$ ratios are commonly used in mining and chemical geology but also in
473 archaeometry to determine the lead sources and the exchanges between the different
474 countries over time (Baron et al., 2006; Bode et al., 2009).

475 Pb used during the 19th century - very large quantities of Pb were needed for
476 Haussmann's renovation of Paris city and the restoration of NDdP and Sainte Chapelle's roofs
477 - was largely imported in France from Spain (Lestel, 2012). The isotopic signatures obtained
478 on the selected samples from NDdP were compared with those of Pb ores from southern
479 Spain, the most active Pb mines, currently available in the literature.

480 The isotopic signatures of the ores plotted on the $^{208}\text{Pb}/^{204}\text{Pb}$ versus $^{206}\text{Pb}/^{204}\text{Pb}$ diagram
481 (Figure 6) are very heterogeneous, especially for Cartagena mining district. The signatures of
482 the Rio Tinto and La Carolina mining districts are relatively homogeneous, at this scale of
483 study. The La Carolina isotopic signatures overlap one of the three isotopic composition fields
484 of Los Pedroches and the Rio Tinto one. These signatures reflect the complex geological
485 history of these large mining areas in southern Spain. Two different mixing lines are
486 highlighted here. They reflect the signature of two different metallogenic sources. The first

487 one, which is the most radiogenic, is constituted by the isotopic signatures of a part of the
488 ores from Cartagena. The second one, less radiogenic, is composed by the isotopic signatures
489 of Rio Tinto, La Carolina, Los Pedroches and a part of Cartagena ores. This suggests a common
490 origin of the mineralization fluids, which is different from the first one. The isotopic signatures
491 of the NDdP fire dust are aligned with the second mixing line suggesting that its Pb is coming
492 from Rio Tinto, La Carolina, Cartagena and partially from Los Pedroches ores.

493 Nevertheless, with respect to the $^{207}\text{Pb}/^{204}\text{Pb}$ versus $^{206}\text{Pb}/^{204}\text{Pb}$ ratios, different isotopic
494 fields are highlighted within a same mining district which is the case for Los Pedroches and
495 Cartagena. This suggests that the mineralization phase occurred in several episodes of
496 mineralization (3 for Los Pedroches and 2 for Cartagena). In the case of Rio Tinto and La
497 Carolina, the ores come from a single phase of mineralization emplacement and also have a
498 common origin.

499 The isotopic signatures of the NDdP fire dusts are, again, aligned along a mixing line
500 formed by the least radiogenic group of Cartagena ores. The other mining districts of Los
501 Pedroches, La Carolina and Rio Tinto are excluded. One of the phases of Los Pedroches and
502 those of La Carolina and Rio Tinto are almost synchronous. The NDdP fire dust therefore seem
503 to have originated from Cartagena mining district.

504 In addition, the fire dust signature is more precise and comprehensive using the data
505 obtained at SARM. Finally, the Pb isotope ratio of the leaded particles emitted by the 2019 fire
506 are: $^{206}\text{Pb}/^{207}\text{Pb}$: 1.1669-1.1685, $^{208}\text{Pb}/^{206}\text{Pb}$: 2.0981-2.0995, $^{208}\text{Pb}/^{204}\text{Pb}$ ratios: 38.297 -
507 38.342, $^{207}\text{Pb}/^{204}\text{Pb}$: 15.633 - 15.639 and $^{206}\text{Pb}/^{204}\text{Pb}$: 18.242 – 18.275.

508

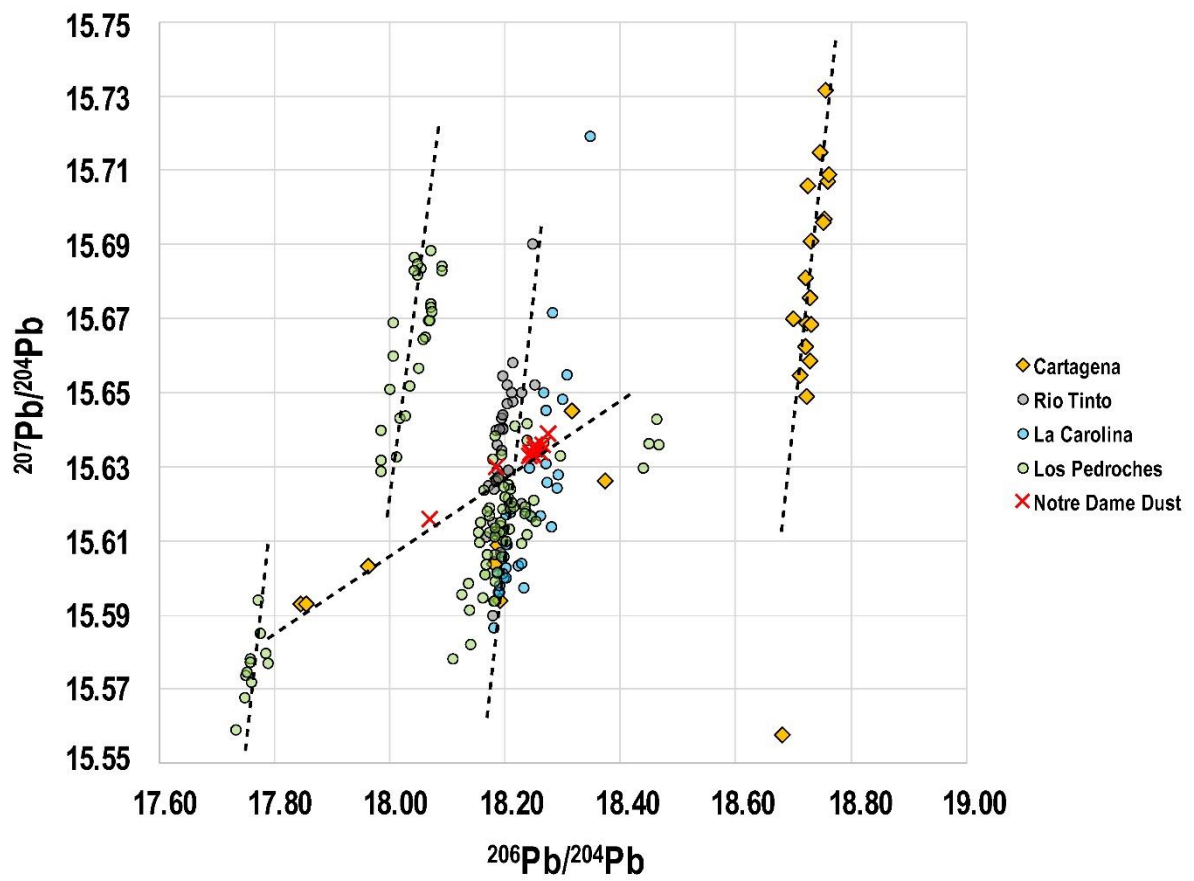
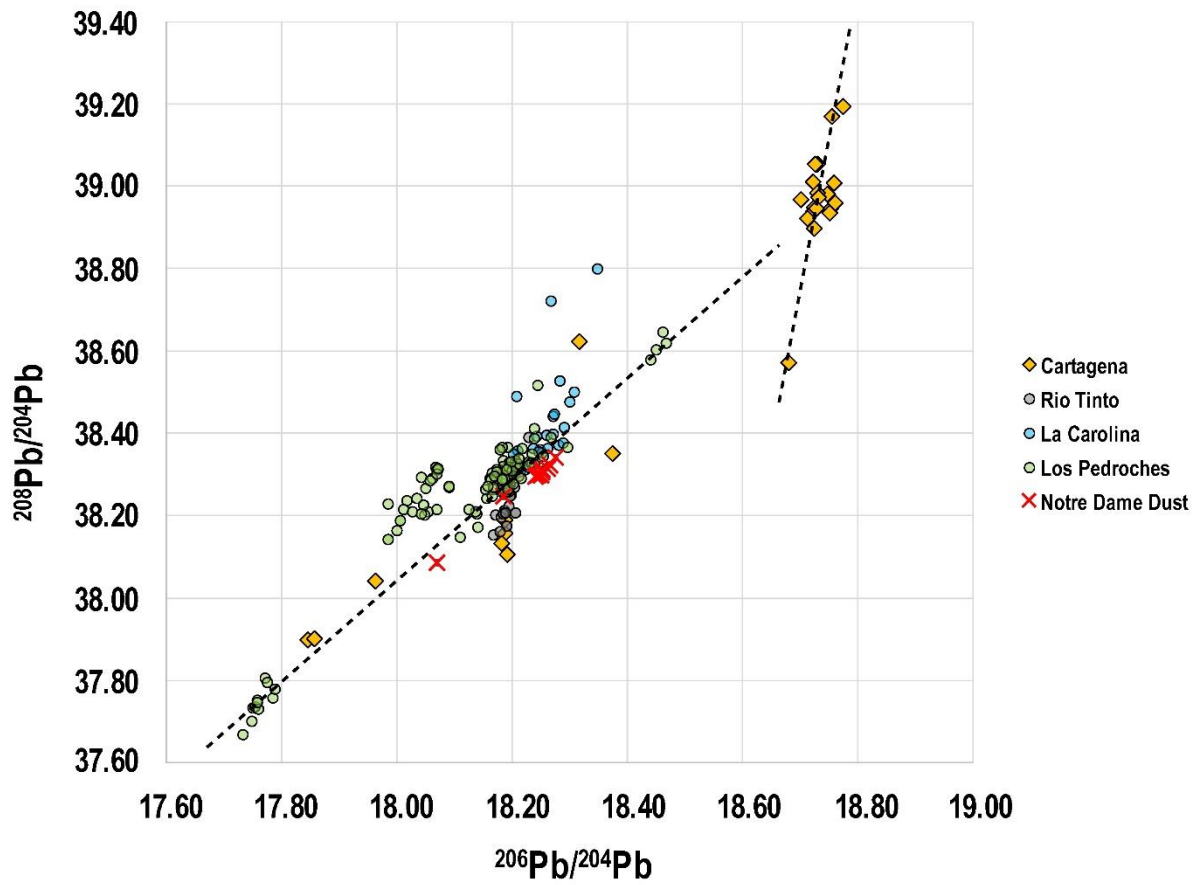

510 Figure 6 : $^{208}\text{Pb}/^{204}\text{Pb}$ versus $^{206}\text{Pb}/^{204}\text{Pb}$ and $^{207}\text{Pb}/^{204}\text{Pb}$ versus $^{206}\text{Pb}/^{204}\text{Pb}$ diagrams of ores signatures
511 from Cartagena (Graeser and Friedrich 1970 ; Marcoux et al., 1992 ; Arribas and Tosdal 1994 ; Stos-
512 Gale and Gale 2009 ; Baron et al., 2017), Rio Tinto (Brill and Wampler 1967 ; Brill et al., 1987 ; Marcoux
513 et al., 1992 ; Marcoux 1998 ; Pomiès et al., 1998 ; Stos-Gale and Gale 2009), La Carolina (Hunt-Ortiz
514 2003 ; Stos-Gale and Gale 2009 ; Santos-Zaldugui et al., 2004), Los Pedroches (Santos-Zaldugui et al.,
515 2004) and Notre Dame fire dust (This study).

516 **6. Conclusions**

517 We developed an appropriate step-by-step strategy to reveal the samples most
518 representative of the fire emission. A careful and systematic evaluation of the bias due to pre-
519 and post-sampling contamination is an essential tool to trace potential Pb pollution in a city
520 such as Paris where the Pb comes from multiple sources (road traffic, industries, waste
521 incinerators, Pb in habitat and the heritage of the “historical Pb”). In addition, we propose a
522 robust protocol for future dust sampling in historical monuments. The objective is to be able
523 to compare the data in the future (between monuments, after restoration works, and in case
524 of another tragedy).

525 A 3-step methodology was developed: (1) binocular observations of the macroscopic
526 heterogeneities and subsequent fractioning of the sample into more homogeneous fractions,
527 (2) elemental composition determination for a large range of elements, mainly used to
528 evaluate the impact of the sampling substrate, (3) Pb isotope ratio analysis enabling to reveal
529 more subtle heterogeneities. The smoke plume signature is better represented by the dust
530 fraction of the samples collected on wood substrate on the cathedral’s first floor. This
531 methodology is applicable to the study of Pb sources in historical monuments, to characterize
532 them in an historical perspective, or to evaluate the impacts of an accidental event.

533 The isotopic and elemental fingerprint highlights the distinctive characteristics of the
534 NDdP fire signature, inherited from the long and rich history of the cathedral. Thus, we
535 propose an uncommon geochemical fingerprint of NDdP fire fallout, characterized by ratios

536 based on Pb substantially different from classic urban ratios. Most importantly, the NDdP fire
537 Pb isotope ratio signature is finely characterized with median values of $^{206}\text{Pb}/^{207}\text{Pb}$ ratio:
538 1.16738 ± 0.00057 and $^{208}\text{Pb}/^{206}\text{Pb}$ ratio: 2.09875 ± 0.00049 .

539 In a further step, this signature will be used to trace this major event in the Parisian
540 environment. The fire Pb signature is distinct from today's urban Pb signature, which is
541 imprinted by the leaded gasoline used during the second half of the 20th century. This leaves
542 some space to distinguish the NDdP fire Pb inputs from the urban contamination preexisting
543 the 2019 fire in environmental reservoirs (soils, river sediments, atmospheric particles).

544 Finally, we showed that the Pb contained in the NDdP fire dusts seems to have
545 originated from Cartagena mining district, more precisely from the least radiogenic group of
546 Cartagena ores.

547 **Acknowledgments**

548 The authors thank the CNRS, more specifically the "Mission pour les Initiatives Transverses et
549 Interdisciplinaires (MITI)" and the Research Group ReMArch « Remploi et Recyclage des
550 Matériaux de l'Architecture », CNRS (GDR 2063) for their financial support. This work is part
551 of the research conducted by the Group Metals of the Chantier Scientifique de Notre-Dame
552 (CNRS/Ministère de la Culture). The authors thank all its members for the scientific
553 discussions.

554 **Supporting information:**

555 Word file:

556 Table S1 Location and description of samples collected in NDdP

557 Table S3. Elemental composition ($\text{mg}\cdot\text{kg}^{-1}$) and lead isotope ratio for the certified reference materials

558 Fig. S1. Lead isotopic compositions determined at LSCE and CRPG laboratories.

559 Fig. S2. Lead isotopic compositions of heterogeneous samples from this study.

560 Fig. S3. Bivariate concentration plots of selected element versus Pb concentrations for
561 heterogeneous samples (*i.e.*, presenting a ‘dust only’ fraction and a ‘fiber and dust’ fraction’)

562 Excel Files:

563 Table S2. Selected isotopes and analysis modes of elements.

564 Table S4. Elemental and lead isotope ratios of NDdP samples.

565 Table S5. Lead isotope ratios of the Sainte-Chapelle and Chartres cathedral lead samples.

566 Table S6. Composition of the “only dust” and “fiber and dust” fractions for four NDdP samples.

567 Table S7. Lead isotope ratios of the dust samples representative of NDdP fire (SARM)

568

569 **References**

570 Amodio, M., Catino, S., Dambruoso, P. R., De Gennaro, G., Di Gilio, A., Giungato, P., Laiola, E.,
571 Marzocca, A., Mazzone, A., Sardaro, A., & Tutino, M. (2014). Atmospheric deposition:
572 sampling procedures, analytical methods, and main recent findings from the scientific
573 literature. *Advances in Meteorology*, 2014. <https://doi.org/10.1155/2014/161730>.

574 Arribas, A., & Tosdal, R. M. (1994). Isotopic composition of Pb in ore deposits of the Betic
575 Cordillera, Spain; origin and relationship to other European deposits. *Economic
576 Geology*, 89(5), 1074-1093. <https://doi.org/10.2113/gsecongeo.89.5.1074>.

577 Aubert, M. (1920). Notre-Dame de Paris: sa place dans l'histoire de l'architecture du XIIIe au
578 XIVe siècle. H. Laurens.

579 Ayrault, S., Roy-Barman, M., Le Cloarec, M. F., Priadi, C. R., Bonté, P., and Göpel, C. (2012).
580 Lead contamination of the Seine River, France: geochemical implications of a
581 historical perspective. *Chemosphere*, 87(8), 902-910.
582 <https://doi.org/10.1007/s11356-013-2240-6>.

583 Ayrault, S., Le Pape, P., Evrard, O., Priadi, C. R., Quantin, C., Bonté, P., & Roy-Barman, M.
584 (2014). Remanence of lead pollution in an urban river system: a multi-scale temporal
585 and spatial study in the Seine River basin, France. *Environmental Science and
586 Pollution Research*, 21(6), 4134-4148. <https://doi.org/10.1007/s11356-013-2240-6>.

587 Baron, S., Carignan, J., Laurent, S., & Ploquin, A. (2006). Medieval lead making on Mont-
588 Lozère Massif (Cévennes-France): tracing ore sources using Pb isotopes. *Applied
589 geochemistry*, 21(2), 241-252. <https://doi.org/10.1016/j.apgeochem.2005.09.005>.

590 Baron, S., Rico, Ch., et Antolinos Marín, J. A. (2017) : "Le complexe d'ateliers du Cabezo del
591 Pino (Sierra Minera de Cartagena-La Unión, Murcia) et l'organisation de l'activité
592 minière à Carthago Noua à la fin de la République romaine. Apports croisés de
593 l'archéologie et de la géochimie", *Archivo Español de Arqueología*, 90, 147-169.

594 Bode, M., Hauptmann, A., & Mezger, K. (2009). Tracing Roman lead sources using lead
595 isotope analyses in conjunction with archaeological and epigraphic evidence—a case
596 study from Augustan/Tiberian Germania. *Archaeological and anthropological
597 sciences*, 1(3), 177-194. <https://doi.org/10.1007/s12520-009-0017-0>.

598 Brill, R.H. and Wampler, J. M. (1967). Isotope studies of ancient lead. *American Journal of
599 Archaeology* 71, 63-77.

600 Brill, R.H., Barnes, I.L., Tong, S.C., Joel, E.C., Murtaugh, M.J., 1987. Laboratory studies of
601 some European artifacts excavated on San Salvador Island, in: Gerace, D.. (Ed.),
602 Columbus and His World: Proceedings of the First San Salvador Conference. San
603 Salvador, Bahamian Field Station, pp. 247–292

604 Charlesworth, S., De Miguel, E., & Ordóñez, A. (2011). A review of the distribution of particulate trace
605 elements in urban terrestrial environments and its application to considerations of risk.
606 *Environmental geochemistry and health*, 33(2), 103-123.

607 Cheng, H., & Hu, Y. (2010). Lead (Pb) isotopic fingerprinting and its applications in lead
608 pollution studies in China: a review. *Environmental pollution*, 158(5), 1134-1146.
609 <https://doi.org/10.1016/j.envpol.2009.12.028>.

610 Cohen, M. (2008). An Indulgence for the Visitor: The Public at the Sainte-Chapelle of Paris.
611 *Speculum*, 83(4), 840-883. <https://doi.org/10.1017/S003871340001705X>.

612 Comite, V., Pozo-Antonio, J. S., Cardell, C., Rivas, T., Randazzo, L., La Russa, M. F., & Fermo, P.
613 (2019, December). Metals distributions within black crusts sampled on the facade of
614 an historical monument: the case study of the Cathedral of Monza (Milan, Italy). In
615 IMEKO TC4 International Conference on Metrology for Archaeology and Cultural
616 Heritage, MetroArchaeo: 4 through 6 December (pp. 73-78). International
617 Measurement Federation Secretariat (IMEKO).

618 Delile, H., Keenan-Jones, D., Blichert-Toft, J., Goiran, J. P., Arnaud-Godet, F., Romano, P., &
619 Albarède, F. (2016). A lead isotope perspective on urban development in ancient
620 Naples. *Proceedings of the National Academy of Sciences*, 113(22), 6148-6153.
621 <https://doi.org/10.1073/pnas.1600893113>.

622 Delile, H., Keenan-Jones, D., Blichert-Toft, J., Goiran, J. P., Arnaud-Godet, F., & Albarède, F.
623 (2017). Rome's urban history inferred from Pb-contaminated waters trapped in its
624 ancient harbor basins. *Proceedings of the National Academy of Sciences*, 114(38),
625 10059-10064. <https://doi.org/10.1073/pnas.1706334114>.

626 Elbaz-Poulichet, F., Holliger, P., Martin, J. M., & Petit, D. (1986). Stable lead isotopes ratios in
627 major French rivers and estuaries. *Science of the Total Environment*, 54, 61-76.
628 [https://doi.org/10.1016/0048-9697\(86\)90256-1](https://doi.org/10.1016/0048-9697(86)90256-1).

629 Ellam, R. M. (2010). The graphical presentation of lead isotope data for environmental source
630 apportionment. *Science of the Total Environment*, 408(16), 3490-3492.

631 Farmer, J. G., Eades, L. J., Atkins, H., & Chamberlain, D. F. (2002). Historical trends in the lead isotopic
632 composition of archival Sphagnum mosses from Scotland (1838– 2000). *Environmental
633 science & technology*, 36(2), 152-157.

634 Font, A., de Hoogh, K., Leal-Sanchez, M., Ashworth, D. C., Brown, R. J., Hansell, A. L., & Fuller,
635 G. W. (2015). Using metal ratios to detect emissions from municipal waste
636 incinerators in ambient air pollution data. *Atmospheric environment*, 113, 177-186.
637 <https://doi.org/10.1016/j.atmosenv.2015.05.002>.

638 Gasperi, J., Le Roux, J., Deshayes, S., Ayrault, S., Bordier, L., Boudahmane, L., ... & Gromaire, M. C.
639 (2022). Micropollutants in Urban Runoff from Traffic Areas: Target and Non-Target Screening
640 on Four Contrasted Sites. *Water*, 14(3), 394.

641 van Geen, A., Yao, Y., Ellis, T., & Gelman, A. (2020). Fallout of lead over Paris from the 2019
642 Notre-Dame cathedral fire. *GeoHealth*, 4(8), e2020GH000279.
643 <https://doi.org/10.1029/2020GH000279>.

644 Gillies, J. A., Gertler, A. W., Sagebiel, J. C., & Dippel, N. W. (2001). On-road particulate matter
645 (PM_{2.5} and PM₁₀) emissions in the Sepulveda Tunnel, Los Angeles, California.
646 *Environmental science & technology*, 35(6), 1054-1063.
647 <https://doi.org/10.1021/es991320p>.

648 Glorennec, P., Peyr, C., Poupon, J., Oulhote, Y., & Le Bot, B. (2010). Identifying sources of
649 lead exposure for children, with lead concentrations and isotope ratios. *Journal of
650 occupational and environmental hygiene*, 7(5), 253-260.
651 <https://doi.org/10.1080/15459621003648281>.

652 Graeser, S., Friedrich, G., 1970. Zur Frage der Altersstellung und Genese der Blei-Zink-
653 Vorkommen der Sierra de Cartagena in Spanien. *Miner. Depos.* 5, 365–374.

654 Hunt-Ortiz, M.A., 2003. Prehistoric Mining and Metallurgy in South West Iberian Peninsula.
655 *British Archaeologica Reports.* S1188. 9781841715544 (paperback) ,
656 9781407325958 (ebook)

657 Harju, L., Lill, J. O., Saarela, K. E., Heselius, S. J., Hernberg, F. J., & Lindroos, A. (1996). Study
658 of seasonal variations of trace-element concentrations within tree rings by thick-
659 target PIXE analyses. *Nuclear Instruments and Methods in Physics Research Section*
660 *B: Beam Interactions with Materials and Atoms*, 109, 536-541.

661 Jørgensen, Søren Storgaard, and Marta Willems. 1987. "The fate of lead in soils: Lead
662 originating from roofs of ancient churches." *Ambio*:16-19.

663 Laidlaw, M. A., and Taylor, M. P. (2011). Potential for childhood lead poisoning in the inner
664 cities of Australia due to exposure to lead in soil dust. *Environmental Pollution*,
665 159(1), 1-9. <https://doi.org/10.1016/j.envpol.2010.08.020>.

666 Laidlaw, M. A., Filippelli, G. M., Brown, S., Paz-Ferreiro, J., Reichman, S. M., Netherway, P.,
667 Truskewycz, A., Ball, A. S., and Mielke, H. W. (2017). Case studies and evidence-based
668 approaches to addressing urban soil lead contamination. *Applied Geochemistry*, 83,
669 14-30. <https://doi.org/10.1016/j.apgeochem.2017.02.015>.

670 Landrigan, P.J., Fuller, R., Acosta, N. J. R., Adeyi, O., Arnold, R., Basu, N., Balde, A.B.,
671 Bertollini, R., Bose-O'Reilly, S., Boufford, J.I., Breyse, P.N., Chiles, T., Mahidol, C.,
672 Coll-Seck, A.M., Cropper, M.L., Fobil, J., Fuster, V., Greenstone, M., Haines, A.,
673 Hanrahan, D., Hunter, D., Khare, M., Krupnick, A., Lanphear, B., Lohani, B., Martin, K.,
674 Mathiasen, K. V., McTeer, M. A., Murray, C. J. L., Ndahimananjara, J. D., Perera, F.,
675 Potocnik, J., Preker, A. S., Ramesh, J., Rockstrom, J., Salinas, C., Samson, L. D.,
676 Sandilya, K., Sly, P. D., Smith, K. R., Steiner, A., Stewart, R. B., Suk, W. A., van Schayck,
677 O. C. P., Yadama, G. N., Yumkella, K., Zhong, M. 2017. The Lancet Commission on
678 pollution and health. *Lancet* 2018, 391:464–512. [http://dx.doi.org/10.1016/S0140-](http://dx.doi.org/10.1016/S0140-6736(17)32345-0)
679 [6736\(17\)32345-0](http://dx.doi.org/10.1016/S0140-6736(17)32345-0).

680 Le Gall, M., Ayrault, S., Evrard, O., Lacey, J. P., Gateuille, D., Lefèvre, I., Mouchel, J. M., and
681 Meybeck, M. (2018). Investigating the metal contamination of sediment transported
682 by the 2016 Seine River flood (Paris, France). *Environmental Pollution*, 240, 125-139.
683 <https://doi.org/10.1016/j.envpol.2018.04.082>

684 Lestel, Laurence. 2012. "Non-ferrous metals (Pb, Cu, Zn) needs and city development: the
685 Paris example (1815–2009)." *Regional Environmental Change* 12 (2):311-323.

686 L'Héritier, M., Arles, A., Disser, A., & Gratuze, B. (2016). Lead it be! Identifying the
687 construction phases of gothic cathedrals using lead analysis by LA-ICP-MS. *Journal of*
688 *Archaeological Science: Reports*, 6, 252-265.
689 <https://doi.org/10.1016/j.jasrep.2016.02.017>.

690 Lin, Y. C., Tsai, C. J., Wu, Y. C., Zhang, R., Chi, K. H., Huang, Y. T., Lin, S. H., & Hsu, S. C. (2015).
691 Characteristics of trace metals in traffic-derived particles in Hsuehshan Tunnel,
692 Taiwan: size distribution, potential source, and fingerprinting metal ratio.
693 *Atmospheric Chemistry and Physics*, 15(8), 4117-4130. [https://doi.org/10.5194/acp-](https://doi.org/10.5194/acp-15-4117-2015)
694 [15-4117-2015](https://doi.org/10.5194/acp-15-4117-2015).

695 Manhes, G., Allègre, C. J., Dupré, B., & Hamelin, B. (1980). Lead isotope study of basic-
696 ultrabasic layered complexes: Speculations about the age of the earth and primitive
697 mantle characteristics. *Earth and Planetary Science Letters*, 47(3), 370-382.

698 Marcoux, E., Leistel, J. M., Sobol, F., Milesi, J. P., & Lescuyer, J. L. (1992). Signature isotopique
699 du plomb des amas sulfurés de la province de Huelva, Espagne. Conséquences
700 métallogéniques et géodynamiques. Comptes rendus de l'Académie des sciences.
701 Série 2, Mécanique, Physique, Chimie, Sciences de l'univers, Sciences de la Terre,
702 314(13), 1469-1476.

703 Marcoux, E., Leistel, J.M., Sobol, J., Milesi, J.P., Lescuyer, J.L., Leca, X., 1992. Signature
704 isotopique du plomb des amas sulfurés de la province de Huelva, Espagne.
705 Conséquences métallogéniques et géodynamiques. C.R. Acad. Sci. Paris 314, 1469–
706 1476.

707 Marcoux, E., 1998. Lead isotope systematics of the giant massive sulphide deposits in the
708 Iberian Pyrite Belt. *Mineralium Deposita*, 33, 45–58.

709 Marx, S. K., Rashid, S., & Stromsoe, N. (2016). Global-scale patterns in anthropogenic Pb
710 contamination reconstructed from natural archives. *Environmental Pollution*, 213,
711 283-298. <https://doi.org/10.1016/j.envpol.2016.02.006>.

712 Monna, F., Lancelot, J., Croudace, I. W., Cundy, A. B., & Lewis, J. T. (1997). Pb isotopic
713 composition of airborne particulate material from France and the southern United
714 Kingdom: implications for Pb pollution sources in urban areas. *Environmental Science
715 & Technology*, 31(8), 2277-2286. <https://doi.org/10.1021/es960870>.

716 Pio, C., Mirante, F., Oliveira, C., Matos, M., Caseiro, A., Oliveira, C., Querol, X., Alves, C.,
717 Martins, N., Cerqueira, M., Camões, F., Silva, H., & Plana, F. (2013). Size-segregated
718 chemical composition of aerosol emissions in an urban road tunnel in Portugal.
719 *Atmospheric Environment*, 71, 15-25.
720 <https://doi.org/10.1016/j.atmosenv.2013.01.037>.

721 Pomiès, C., Cocherie, A., Guerrot, C., Marcoux, E., & Lancelot, J. (1998). Assessment of the
722 precision and accuracy of lead-isotope ratios measured by TIMS for geochemical
723 applications: example of massive sulphide deposits (Rio Tinto, Spain). *Chemical
724 Geology*, 144(1-2), 137-149. [https://doi.org/10.1016/S0009-2541\(97\)00127-7](https://doi.org/10.1016/S0009-2541(97)00127-7).

725 Pons-Branchu, E., Ayrault, S., Roy-Barman, M., Bordier, L., Borst, W., Branchu, P., Douville, E.,
726 & Dumont, E. (2015). Three centuries of heavy metal pollution in Paris (France)
727 recorded by urban speleothems. *Science of the total environment*, 518, 86-96.
728 <https://doi.org/10.1016/j.scitotenv.2015.02.071>.

729 Resongles, E., Dietze, V., Green, D. C., Harrison, R. M., Ochoa-Gonzalez, R., Tremper, A. H., &
730 Weiss, D. J. (2021). Strong evidence for the continued contribution of lead deposited
731 during the 20th century to the atmospheric environment in London of today.
732 *Proceedings of the National Academy of Sciences*, 118(26).
733 <https://doi.org/10.1073/pnas.2102791118>.

734 Rosca, C., Tomlinson, E. L., Geibert, W., McKenna, C. A., Babechuk, M. G., & Kamber, B. S.
735 (2018). Trace element and Pb isotope fingerprinting of atmospheric pollution
736 sources: A case study from the east coast of Ireland. *Applied Geochemistry*, 96, 302-
737 326. <https://doi.org/10.1016/j.apgeochem.2018.07.003>.

738 Saarela, K. E., Harju, L., Rajander, J., Lill, J. O., Heselius, S. J., Lindroos, A., & Mattsson, K.
739 (2005). Elemental analyses of pine bark and wood in an environmental study. *Science
740 of the Total Environment*, 343(1-3), 231-241.

741 Santos Zalduegui, J. F., García de Madinabeitia, S., Gil Ibarguchi, J. I., & Palero, F. (2004). A
742 lead isotope database: the Los Pedroches–Alcudia area (Spain); implications for
743 archaeometallurgical connections across southwestern and southeastern Iberia.
744 *Archaeometry*, 46(4), 625-634. <https://doi.org/10.1111/j.1475-4754.2004.00178.x>.

745 Sawidis, T., Breuste, J., Mitrovic, M., Pavlovic, P., & Tsigaridas, K. (2011). Trees as
746 bioindicator of heavy metal pollution in three European cities. *Environmental*
747 *pollution*, 159(12), 3560-3570. <https://doi.org/10.1016/j.envpol.2011.08.008>.

748 Shelby, L. R. (1981). Review of the book "The contractors of Chartres" by John James, 1979.
749 *Speculum*, 56(2), 395-398.

750 Shotyk, William, Jiancheng Zheng, Michael Krachler, Christian Zdanowicz, Roy Koerner, and
751 David Fisher. 2005. "Predominance of industrial Pb in recent snow (1994–2004) and
752 ice (1842–1996) from Devon Island, Arctic Canada." *Geophysical Research Letters* 32
753 (21).

754 Smith, K. E., Weis, D., Amini, M., Shiel, A. E., Lai, V. W. M., & Gordon, K. (2019). Honey as a
755 biomonitor for a changing world. *Nature Sustainability*, 2(3), 223-232.
756 <https://doi.org/10.1038/s41893-019-0243-0>.

757 Smith, K. E., Weis, D., Chauvel, C., & Moulin, S. (2020). Honey maps the pb fallout from the
758 2019 fire at notre-dame cathedral, paris: A geochemical perspective. *Environmental*
759 *Science & Technology Letters*, 7(10), 753-759.
760 <https://doi.org/10.1021/acs.estlett.0c00485>.

761 Stos-Gale, Z. A. and Gale, N. H. (2009). Metal provenancing using isotopes and the Oxford
762 archaeological lead isotope database. *Archaeological and anthropological Sciences*, 1,
763 195-213.

764 Syvilay, D., Texier, A., Arles, A., Gratuze, B., Wilkie-Chancellor, N., Martinez, L., Serfaty, S., &
765 Detalle, V. (2015). Trace element quantification of lead based roof sheets of historical
766 monuments by laser induced breakdown spectroscopy. *Spectrochimica Acta Part B:*
767 *Atomic Spectroscopy*, 103, 34-42. <https://doi.org/10.1016/j.sab.2014.10.013>.

768 Thirlwall, M. F. (2002). Multicollector ICP-MS analysis of Pb isotopes using a 207Pb-204Pb
769 double spike demonstrates up to 400 ppm/amu systematic errors in Tl-normalization.
770 *Chemical Geology*, 184(3-4), 255-279.

771 Tognet, F., & Truchot, B. (2019). Modélisation de la Dispersion des Particules de Plomb du
772 Panache de L'incendie de Notre Dame. Ineris-200480-879062-v2. 0.

773 Vallée, A., Sorbets, E., Lelong, H., Langrand, J., & Blacher, J. (2021). The lead story of the fire
774 at the Notre-Dame cathedral of Paris. *Environmental Pollution*, 269, 116140.
775 <https://doi.org/10.1016/j.envpol.2020.116140>.

776 Vanderstraeten, A., Bonneville, S., Gili, S., De Jong, J., Debouge, W., Claeys, P., & Mattielli, N.
777 (2020). First Multi-Isotopic (Pb-Nd-Sr-Zn-Cu-Fe) Characterisation of Dust Reference
778 Materials (ATD and BCR-723): A Multi-Column Chromatographic Method Optimised
779 to Trace Mineral and Anthropogenic Dust Sources. *Geostandards and Geoanalytical*
780 *Research*, 44(2), 307-329.

781 Véron, A., Flament, P., Bertho, M. L., Alleman, L., Flegal, R., & Hamelin, B. (1999). Isotopic
782 evidence of pollutant lead sources in Northwestern France. *Atmospheric*
783 *Environment*, 33(20), 3377-3388. [https://doi.org/10.1016/S1352-2310\(98\)00376-8](https://doi.org/10.1016/S1352-2310(98)00376-8).

784 Watmough, S. A., & Hutchinson, T. C. (1996). Analysis of tree rings using inductively coupled
785 plasma mass spectrometry to record fluctuations in a metal pollution episode.
786 *Environmental Pollution*, 93(1), 93-102. [https://doi.org/10.1016/0269-](https://doi.org/10.1016/0269-7491(95)00107-7)
787 [7491\(95\)00107-7](https://doi.org/10.1016/0269-7491(95)00107-7).

788 Widory, D., Roy, S., Le Moullec, Y., Goupil, G., Cocherie, A., & Guerrot, C. (2004). The origin
789 of atmospheric particles in Paris: a view through carbon and lead isotopes.
790 *Atmospheric Environment*, 38(7), 953-961.
791 <https://doi.org/10.1016/j.atmosenv.2003.11.001>.

792 Wyttenbach, A., & Schubiger, P. A. (1973). Trace element content of Roman lead by neutron
793 activation analysis. *Archaeometry*, 15(2), 199-207. [https://doi.org/10.1111/j.1475-](https://doi.org/10.1111/j.1475-4754.1973.tb00090.x)
794 [4754.1973.tb00090.x](https://doi.org/10.1111/j.1475-4754.1973.tb00090.x).

795 Yu, K. F., Kamber, B. S., Lawrence, M. G., Greig, A., & Zhao, J. X. (2007). High-precision
796 analysis on annual variations of heavy metals, lead isotopes and rare earth elements
797 in mangrove tree rings by inductively coupled plasma mass spectrometry. *Nuclear*
798 *Instruments and Methods in Physics Research Section B: Beam Interactions with*
799 *Materials and Atoms*, 255(2), 399-408. <https://doi.org/10.1016/j.nimb.2006.11.127>.

800 White, W. M., Albarède, F., & Télouk, P. (2000). High-precision analysis of Pb isotope ratios
801 by multi-collector ICP-MS. *Chemical Geology*, 167(3-4), 257-270.

802

803

804