



HAL
open science

A method to assess the hygro-mechanical behaviour of original panel paintings, through in situ non-invasive continuous monitoring, to improve their conservation: a long-term study on the Mona Lisa

Luca Uzielli, Paolo Dionisi-Vici, Paola Mazzanti, Lorenzo Riparbelli, Giacomo Goli, Patrick Mandron, Marco Togni, Joseph Gril

► **To cite this version:**

Luca Uzielli, Paolo Dionisi-Vici, Paola Mazzanti, Lorenzo Riparbelli, Giacomo Goli, et al.. A method to assess the hygro-mechanical behaviour of original panel paintings, through in situ non-invasive continuous monitoring, to improve their conservation: a long-term study on the Mona Lisa. *Journal of Cultural Heritage*, 2022, 58, pp.146-155. <10.1016/j.culher.2022.10.002>. <hal-03906420>

HAL Id: hal-03906420

<https://hal.science/hal-03906420v1>

Submitted on 19 Dec 2022

HAL is a multi-disciplinary open access archive for the deposit and dissemination of scientific research documents, whether they are published or not. The documents may come from teaching and research institutions in France or abroad, or from public or private research centers.

L'archive ouverte pluridisciplinaire HAL, est destinée au dépôt et à la diffusion de documents scientifiques de niveau recherche, publiés ou non, émanant des établissements d'enseignement et de recherche français ou étrangers, des laboratoires publics ou privés.



HAL Authorization

Luca Uzielli^{1*}, Paolo Dionisi-Vici^{1*}, Paola Mazzanti^{1*}, Lorenzo Riparbelli^{1*}, Giacomo Goli¹, Patrick Mandron², Marco Togni¹, Joseph Gril^{3,4}

¹ DAGRI, University of Florence, Florence, Italy

² Independent Restorer, Ateliers d'Enghien, 12 rue d'Enghien 75010 Paris, France

³ Université Clermont Auvergne, CNRS, Clermont Auvergne INP, Institut Pascal, Clermont-Ferrand, France

⁴ Université Clermont Auvergne, INRAE, PIAF, Clermont-Ferrand, France

* These Authors contributed equally

Luca Uzielli	luca.uzielli@unifi.it
Paolo Dionisi-Vici	paolo.dionisivici@gmail.com
Paola Mazzanti	paola.mazzanti@unifi.it
Lorenzo Riparbelli	lorenzo.riparbelli@unifi.it
Giacomo Goli	giacomo.goli@unifi.it
Patrick Mandron	pat.mandron@gmail.com
Marco Togni	marco.togni@unifi.it
Joseph Gril	joseph.gril@cnrs.fr

A method to assess the hygro-mechanical behaviour of historic panel paintings, through *in situ* non-invasive continuous monitoring, to improve their conservation: a long-term study on the *Mona Lisa*

Highlights

- Non-invasive methods and equipment to measure and monitor panel painting's behaviour
- Technological analysis and state of conservation of the *Mona Lisa*'s wooden panel
- Studying mechanical properties and conditions of an artwork painted on wood
- Monitoring mechanical response of panel paintings to environmental fluctuations
- Collecting data to feed and reliably calibrate numerical models

Keywords: *Mona Lisa*, technological analysis, panel paintings, conservation, non-invasive monitoring, hygro-mechanical behaviour.

Declarations of interest: The authors declare the absence of any conflict of interest.

Abstract

This paper describes an innovative method, and related equipment, developed by the authors to monitor non-invasively historic panel paintings under museum display conditions. This method permits in-depth knowledge about such artworks, allowing us to understand their reactions to climatic variations, and provides objective data on which conservation decisions can be confidently based, since the data are directly obtained from the individual artwork. Since 2004, following the invitation from the Louvre Museum and the C2RMF (National Centre for Research and Restoration of French Museums), the wooden panel on which Leonardo da Vinci painted his *Mona Lisa* has been studied by an international research team of wood technologists and engineers, including researchers from French and Italian universities and related scientific institutions (Montpellier, Clermont Auvergne, Poitiers, Florence), to understand its mechanical, hygroscopic and shape characteristics and behaviour, to evaluate its present state, and to provide suggestions for optimizing its conservation conditions. Non-invasive methods and equipment were therefore devised and implemented to measure (during the annual opening day of its display case) and automatically monitor (during the time the display case remains closed) both the deformations that the panel undergoes (mainly produced by the inevitable small climatic fluctuations within the case) and the constraining forces acting on the panel itself. The method and the related equipment, improved over the years, are based on miniature load cells and displacement transducers, whose outputs are automatically logged at desired time intervals, typically ranging between 30 minutes for monitoring during the whole year, and a few seconds for manual measurements, calibrations, and other selected events; the stored data can be downloaded both through a cable connection and wirelessly, by means of a specially developed connection apparatus. The panel is confined in a climate-controlled display case, which typically is opened only for a few hours once a year. Additionally, close restrictions must be respected, including absolute non-invasiveness, non-interference with the enjoyment of the artwork by the public, and compliance with strict procedures for safe and secure conservation. The implementation of this

method has provided significant information about the actual behaviour of the panel during the whole year. Comparing several annual force-deformation curves, their good linearity suggests that no unacceptable stress or deformation has taken place in it, showing that the climatic conditions (air temperature and relative humidity) maintained in the display case can be considered favourable to the conservation of the artwork. Moreover, based on the collected data, reliable Finite Element Method (FEM) models are being developed and calibrated, with the aim of describing the mechanical behaviour of the panel and virtually evaluating the risk of damage (including the propagation of an ancient crack) deriving from external conditions or actions to which it would be unthinkable to submit the original historic artwork.

1 Introduction

The *Mona Lisa* was painted by Leonardo da Vinci during the period 1503-1514 on a poplar (*Populus alba* L.) wooden board. Using wood as a support for paintings was a common practice between the 13th and 16th centuries [1, 2]; however, the hygroscopicity [3-5] and susceptibility to degradation [6] of wood pose problems for conservators, as for all wood users. The study of any individual object belonging to the cultural heritage presents complexities, including individual structure, making, history, conservation conditions, constraints related to the conservation and security, restrictions on access and manipulation, decisions related to the public display, and exposure to microclimatic conditions. When the object is made of wood, the intrinsic variability of the material itself makes the problem even more complex [7]. Panel paintings constitute a category of objects whose conservation is particularly critical, since they are formed by wooden panels on which layers of various materials are applied, featuring quite different chemical, mechanical and hygroscopic properties [8, 9]. Conservation of panel paintings includes maintaining integrity of both the wooden support and the superposed layers, which must remain intimately connected while presenting potential problems of compatibility [10]. When the surrounding environment undergoes any thermo-hygrometric variation, panels painted on one face only, like the *Mona Lisa*, tend to exhibit typical distortions [11], better discussed in Section 3.1. This tendency has often been worsened by the introduction of inappropriate heating or air conditioning of the exhibition or storage rooms, as well as by the controversial interventions such as thinning and cradling (*parquetage*) of panels [10]. In summary, today preventive conservation mainly aims at maintaining the thermo-hygrometric conservation conditions stable, while ensuring that mechanical constraints do not lead to damage of panels or paint layers in case of excessive climatic variations. In addition, the presence of crossbeams opposing the increase of the panel's cupping has a significant influence: while on the one hand it prevents the risk of progressively increasing permanent deformations, on the other it generates additional mechanical stresses in the wood [12]. If the stresses become excessive, they can put the artwork's integrity at risk, regarding both the panel (e.g. cracks, open joints, irreversible deformations) and the paint layers (e.g. flaking, cleavage or buckling) [3], [5], [10]. To ensure the best conservation, deformations due to inevitable microclimate fluctuations should be prevented, but, at the same time, the forces counteracting the deformations should be maintained at a safe level even in case of unusually high fluctuations. The problems highlighted so far make it necessary to improve the knowledge of the artwork to be conserved in relation to its deformation dynamics, i.e. how environmental variations influence the state of the forces and deformations to which the panel painting is subjected over time. An appropriate experimental approach therefore requires the continuous recording over time of deformations and forces directly measured on the specific artwork, and of temperature and humidity readings of the surrounding environment. To make a complete analysis, these records need to include the deformations and forces sufficient to characterize the global behaviour of the artwork; and, obviously, all must be carried out non-invasively.

Since 2004, the *Mona Lisa*'s wooden panel (hereinafter "the panel") has been studied by an international research team, including researchers from French and Italian universities and related

scientific institutions (Montpellier, Clermont Auvergne, Poitiers, Florence), which carried out several experimental campaigns to understand the panel's mechanical, hygroscopic and shape characteristics and behaviour, to evaluate its present state, and provide related suggestions in order to optimize its conservation. The following main questions were originally posed by the Louvre conservators in 2004, when the team started its activities: **(a)** evaluating climatic specifications for the new display case (on April 6, 2005 the *Mona Lisa* was moved from its previous location in the *Salle Rose*, to its current location in the *Salle des États*), **(b)** assessing the risk of propagation of the ancient crack affecting the panel, **(c)** suggesting possible improvements to the framing conditions of the panel, and **(d)** improving the technological aspects of the monitoring procedure. To provide answers to these questions, the artwork was studied (i) by direct observation and measurements (once a year, during the few hours available on the occasion of the so called "*Journée Joconde*", when it is removed from its climate-controlled display case), (ii) by automatically monitoring continuously the panel's behaviour while in the display case, using a special ad-hoc equipment, and (iii) by developing numerical models simulating the historic artwork's reactions to actual or potential hygro-mechanical stresses. This paper (i) focuses on the experimental approaches, and (ii) discusses the most significant results obtained.

2 Aims

This paper describes an innovative method whose aim is to apply modern scientific techniques to the conservation of historic panel paintings, based on non-invasive testing and continuous monitoring of the artworks in museum display conditions. This method, applied in the last 18 years on the *Mona Lisa*, provides an in-depth knowledge of the artwork, of its construction features, and of its mechanical and hygroscopic behaviour. To obtain such knowledge, thorough monitoring techniques were developed and improved over time, recording simultaneously the forces to which the panel is subjected and its state of deformation. Such data can provide real time information on the panel's condition, measure its response to environmental variations, and thus contribute substantially to optimize its conservation; data from monitoring can be used for advanced analyses, including the development and calibration of digital numerical models, allowing a reliable simulation of the panel's behaviour under many environmental conditions, for optimisation of its framing constraints, for preventive conservation, and for the exploration of risk scenarios. The possibility of adapting such methods to other artworks is also briefly discussed.

3 Materials and Methods

The design of an artwork's monitoring system cannot disregard its technological and mechanical features. Panel paintings differ one from another in many respects, including wood species, size and shape, manufacturing and painting technique, environmental and conservation history. Constraints and monitoring methods must therefore be examined case by case with extreme care. Below, a short summary of the measurement and monitoring methods chosen for the *Mona Lisa* is outlined; further details are then provided in the following sections.

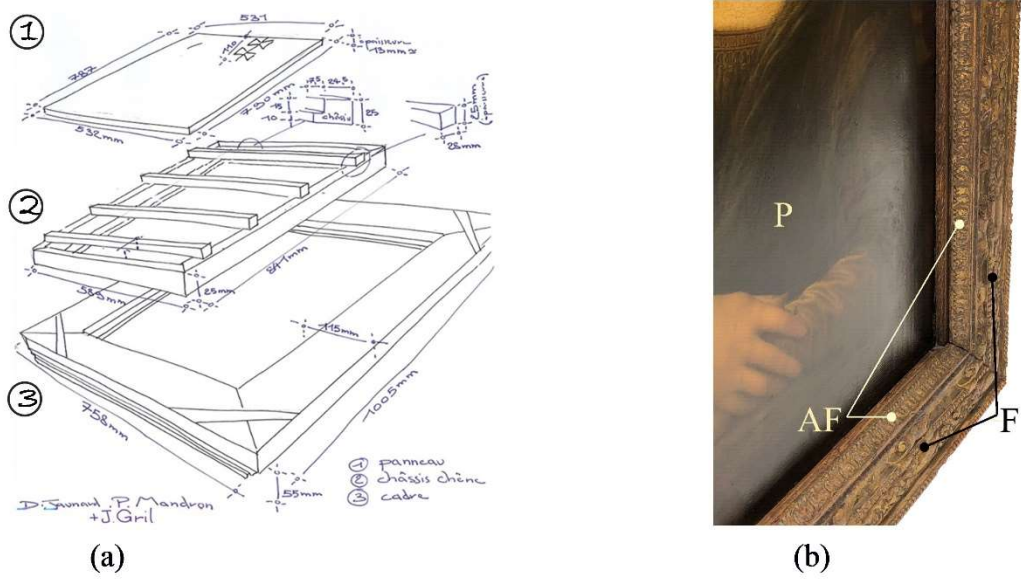

Fig. 1 (a,b) – (a) Exploded view and metric survey by the restorers D. Jaunard and P. Mandron in 2004, later modified by J. Gril, showing the various elements which made up the *Mona Lisa* assembly before 2005. (1) Panel, with both the crack and the butterflies shown. (2) Auxiliary frame (*châssis-cadre*) made of L-section battens, with the four 25 x 28 mm² crossbeams before they were replaced (in 2005 and again in 2013 and 2021), only the top and bottom ones forcing against the panel (see Section 3.2). (3) Sculpted and gilded frame (*cadre*), fully visible from the front, that also exerts some mechanical influences on the panel (see Section 3.3). (b) Close view of the three elements in 2019: (F) Frame, (AF) Auxiliary frame, (P) panel.

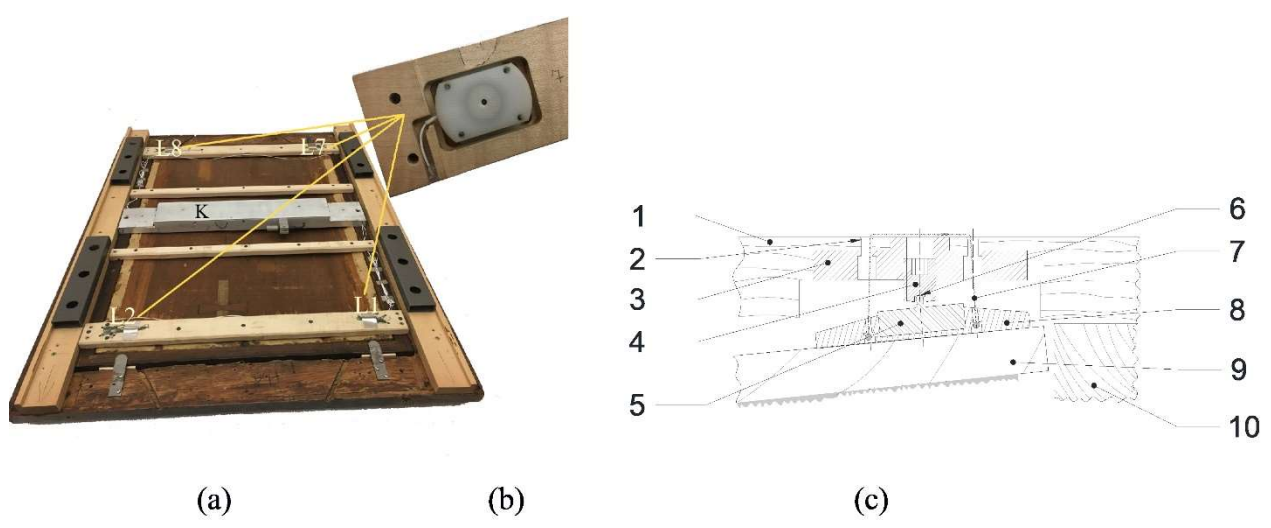

Fig. 2 (a,b,c) – Equipment for measuring and monitoring forces, in use from 2013 to 2021. (a) Overall view of the back of the assembled system. (L1-L2-L7-L8) Locations of the load cells. (K) Aluminium case housing the deflection transducers and the electronic equipment. In the foreground, two of the four metal brackets that secure the auxiliary frame in the gilded frame are clearly visible. (b) View of an end of an overturned crossbeam, and of the swivelling Delrin[®] presser. (c) Partial longitudinal cross-section of a crossbeam at the level of the load cell. (1) Wooden crossbeam (maple wood). (2) Holes for the passage of the strings. (3) Support embedded in the crossbeam. (4) Steel grub screw. (5) Miniature load cell. (6) Contact pin of the load cell. (7) String. (8) Presser. (9) Panel. (10) Batten of the auxiliary frame.

The *Mona Lisa* is painted on a thin (~13 mm) wooden plank (“the panel”). When left free the panel is presently quite distorted (cupping and bowing) (the reasons for this are briefly outlined in other

parts of this paper). To prevent distortions from increasing in time, the panel is maintained flatter than it would be if left free, by compressing it between the auxiliary frame and the crossbeams fixed to this frame with screws (see Fig. 1a and Section 3.2). The auxiliary frame, with the panel inside, is fixed inside the gilded external frame by means of metal brackets (which are not shown in Fig. 1a; two of the four metal brackets are clearly visible in Fig. 2a). A technological analysis of the panel's structure and assembly is presented in Sections 3.1 to 3.3.

When the surrounding climatic conditions change, the panel's shape tends to change as well, however the top and bottom crossbeams tend to prevent any deformation at its top and bottom edges; therefore, the reaction forces and the related internal stresses and strains are also constantly changing. Both to monitor the current state of the panel and to formulate and calibrate a numerical model, an accurate continuous monitoring (i.e., automatic measuring and recording) of the forces acting between crossbeams and panel, and of the panel's deformations, has been implemented (see Sections 3.4-3.7). The data provided by such monitoring proved to be particularly useful for the analysis of the hygro-mechanical behaviour of the panel during its normal display conditions. Additionally, several physical and mechanical measurements on the panel were directly carried out by the authors and by other members of the international team when the conditioned display case was opened (see e.g. [11], [13-15]). This typically takes place on the so-called *Journée Joconde*, when the *Mona Lisa* is subjected to routine checks, observations and measurements by art historians, conservators, and researchers belonging to various disciplines.

3.1 The panel

The panel is a flat-sawn (i.e. subtangential) rectangular board of Poplar wood (*Populus alba* L.), 794 x 534 x 13 mm³, doubly curved (i.e. both transversally and longitudinally) with convexity towards the painted face, which is the "external" one (i.e. the face away from the original log's pith).

The crack. An ancient crack, about 110 mm long, runs through the panel's thickness from the top edge of the panel down to the *Mona Lisa*'s forehead. The crack length runs along the direction of the wood grain, and its plane is parallel to the local radial direction of wood, so it is inclined by about 34° to the painted surface of the panel; two wooden "butterflies" had been inlaid, possibly during the 19th century, into the panel's thickness to prevent any longitudinal propagation of the crack, one of them now missing and being replaced by a glued canvas strip [16, 17].

Near the tip of the crack the craquelure in the paint layers is organized according to a particular pattern, indicating that the crack formed during the first decades of existence of the artwork, and did not advance further [16].

A reasonable hypothesis regarding the formation of the crack could be the following. The presence of a barb of paint and ground running along some parts of the edge of the painted surface testifies that the ground layer was applied when the panel was already inserted into a grooved frame [17]. Such frame was intended to keep it flat despite the important variations in moisture content (MC) caused by the application of the ground layer, and to the unavoidable subsequent environmental fluctuations [16, 17]. It is well known that when a panel painting is subjected to strong variations in moisture content (e.g. during the application of the preparation layers, or during subsequent drying, or in any case following significant climatic changes) it can develop a strong tendency to cupping. If this cupping tendency is prevented by external constraints such as the grooved frame mentioned above, stress states may develop in the wood such as to produce (in a short or long time) transversal bending breakage, which typically occurs along longitudinal radial surfaces, which are structurally weaker. This mechanism could have caused (perhaps some years after the panel was prepared and painted) the formation of the crack, the opening of which would also have modified the shape of the panel and reduced the magnitude of the internal stresses present in it.

The double curvature, which can be considered typical of a thin panel painted on only one face and blocked along its four sides, resulted in a central deflection of about 11 mm. It was presumably caused

by the many MC variations and gradients, producing complex phenomena that can be globally recalled with the term "compression set" [5], [18], combined with the tendency to warp caused by the orientation of the growth rings and of the direction of the wood grain, and with the distortions produced by the formation of the crack. However, a thorough discussion about the localisation and orientation of the wooden panel inside the log from which it was obtained falls outside the scope of this paper and is presented elsewhere [19, 20]

Since its making, the panel underwent only few modifications [17], including: (i) the inlay, possibly during the 19th century, of the two "butterflies", (ii) a light surfacing of the back-face, and (iii) a small width reduction affecting only lateral unpainted parts.

3.2 The restraining system: auxiliary frame and crossbeams

The auxiliary frame is made of oak wood (*Quercus* sp.) battens, whose L-shaped cross section measures 25 x 32 mm² (Fig. 1a). It shows limited stiffness, both flexural and torsional, as compared to those of the panel [21] and of the gilded frame (Section 3.3). It performs important mechanical functions, outlined below. Its rabbet (*feuillure*) is the surface on which the panel rests, and on which the contact forces acting on the front face of the panel are distributed [13]. Together with the crossbeams screwed against its vertical battens it constitutes the system of constraints, which maintains the panel slightly forced in a stable shape and prevents its curvature from gradually increasing over time.

In 2005, the four crossbeams shown in Fig. 1 (25 x 28 mm² in cross-section) were replaced with crossbeams only 15 mm thick, to fit into the extremely narrow space left available in the new location. Due to the double curvature and convexity of the panel the two middle crossbeams do not touch it and merely serve to stiffen the auxiliary frame. On the contrary, the top and bottom crossbeams (both the old and the new ones) force against the panel, and maintain it flatter than it would be otherwise. In 2005, the new top and bottom crossbeams were made 50 mm wide to provide room for the insertion of load cells measuring the contact forces. They were replaced again in 2013, when new load cells were installed, and in 2021 (70 mm wide), when load-limiting devices were installed [20]. Old and new crossbeams were made of maple wood (*Acer* sp.); all the new ones were carefully manufactured at the University of Florence, from bars obtained by splitting air-seasoned boards, to ensure the direction and regularity of the grain. To manufacture the crossbeams, the above-mentioned bars were then brought to size by planing, and finally shaped by milling. In 2013, the machined bars were sterilised by keeping them for about 6 hours in the oven at 60°C. In 2021, to minimize the risk of deformations of the long and quite thin bars resulting from processing, the sterilisation was carried out by keeping the machined wood bars in a freezer at -18°C for seven days [6]. After sterilisation, the crossbeams were brush treated with a permethrin-based insecticide to prevent future insect attacks – a treatment that loses its effectiveness over time and should be repeated when necessary. Most of the auxiliary frame is invisible to the public when the *Mona Lisa* is exhibited; only the thin lateral faces of its rabbets are barely visible, mostly along the vertical battens, where they are separated from the front surface of the panel by a small gap, whose thickness is variable due to the irregular shape of the panel's surface (see Fig. 1b).

3.3 The gilded frame

The sculpted and gilded external frame, fully visible to the public (see Fig. 1b), is made up of wooden elements with a much larger cross-section than the auxiliary frame and is therefore much stiffer. It houses and supports the auxiliary frame, and the aluminium profiles fixed on its rear face, invisible to the public, that support and keep the *Mona Lisa* in its display position. When the auxiliary frame housing the panel is placed in the gilded frame and pressed against its rabbets by means of tightly screwed metal brackets, the auxiliary frame being significantly less stiff [21] can only yield and adapt to the surface of the rabbets of the stiffer gilded frame. Thus, for several years the accurate force and

deformation adjustments obtained by the authors by means of the monitoring system were changed in an unpredictable way when the panel and the auxiliary frame were placed back in the gilded frame, and then in its display case. Finally, during a 2019 opening day, an accurate analysis of the gilded frame's rim surfaces was carried out with pressure sensitive Prescale[®] film, following a procedure like the one implemented by Goli et al. in 2013 [13]. The analysis allowed detecting some significant irregularities on the frame's rabbet, such as some nail's heads slightly protruding from the wooden surface. Their negative effect was promptly eliminated in a totally non-invasive way, by applying on the rabbets (namely in correspondence of the metal brackets) appropriately thin wood spacers, to obtain a regular although discontinuous supporting surface for the auxiliary frame. This precaution avoids unwanted changes in the forces applied to the panel when the auxiliary frame in which the panel is inserted is placed back in the gilded frame.

3.4 The measurement of the forces

The forces exerted by the rabbet of the auxiliary frame on the front face of the panel are balanced by the forces exerted by the crossbeams on the back face, through the four load cells located in L1-L2-L7-L8 (Fig. 2a). In other words, the system formed by the panel, the crossbeams and the auxiliary frame is closed with regards to the contact forces, so that the four load cells are measuring all the significant forces acting on the artwork during the monitoring. Of course, the panel is also subjected to gravity. Therefore, depending on how it is oriented (i.e. vertically in the normal display position, or horizontally as sometimes happens during certain adjustments, measurements or manual tests) gravity can modify the forces measured by the load cells, because of the influence of the panel's weight. Additionally, friction forces can build up on the contact areas between panel and auxiliary frame, both on the panel's face and on its edges. Several tests have been performed to account for these effects, which however do not seem to significantly affect the monitoring results; therefore, they are not discussed here. The equipment described below was designed, repeatedly improved, and implemented to effectively, safely and non-invasively measure and monitor such forces both under normal display conditions and for manual measurements carried out during the yearly openings of the display case. Until 2013 only the forces exerted on locations L1 and L2 (Fig. 2a) were monitored throughout the year by means of only two load cells inserted in the top crossbeam [11]. Starting from 2013, an improved and still now working force monitoring equipment was installed, based on four miniature load cells (P286.C-S-A/100N, 0-100 N, accuracy 0.5 %; diameter 16 mm, height approximately 6 mm, capacity 100 N; made on purpose by Deltatech, Italy) integrated in the top and bottom crossbeams (Fig. 2b). The load cells are of the strain gage type and are equipped with external miniature supplying-conditioning electronics providing analog outputs, hence their resolution is virtually infinite; however, the Pace-Sci[®] logger to which they are connected (see Section 3.7) can discriminate a variation of $2.4 \cdot 10^{-2}$ N.

In 2021, when new load-limiting devices were installed, the load cells and their electronic equipment remained the same, but their mechanical assembly was modified [20].

Here the mechanical assembly which was in use from 2013 until 2021 is described in detail (Fig. 2a). Top and bottom crossbeams were equipped with four miniaturized load cells at the four contact locations L1-L2-L7-L8. Each load cell was fitted in a swivelling presser pushing against the back of the panel. A grub screw (hexagonal hollow, cup end, M6x5 mm, inserted in a threaded support embedded in the wooden crossbeam) accommodated the load cell's contact element (a cylindrical pin with a diameter of 1.25 mm) in its cup-shaped end; therefore the load cell was free to oscillate around its contact element (a virtual spherical hinge with its centre at the cup-shaped end of the grub screw), allowing the presser to swivel and adapt to the local inclination of the panel in the contact area. This arrangement also allowed the adjustment of the position of each presser, and hence of the force acting on it, by operating the corresponding grub screw.

Both the support and the presser were made of Delrin[®], a plastic material chosen to ensure frictionless and chemically inert contact between the load cell and the back face of the panel.

To facilitate the assembly and disassembly of the crossbeams while the presser was not pushing against the panel, the presser itself was held in position by means of thin sliding strings, which allowed it to assume the inclination of the panel's surface.

The equipment described above was also used during the manual measurements as a loading device for the acquisition of data concerning the mechanical characteristics of the panel. Displacements can be imposed at each load cell independently, by rotating the grub screw controlling its approach towards the panel; to adjust with the greatest possible accuracy such displacement, detachable devices (nicknamed *Jocondometers*) equipped with large goniometers were specifically developed so that the rotation of the screw (and hence its axial displacement) could be controlled accurately and repeatably, with a resolution of ± 0.01 mm. Fig. 3 shows one of such devices. During the measurement each device was firmly fixed against the crossbeam by a couple of tie-rods not shown in the drawing; by turning the knob, connected to the handle of a hexagonal key, one could accurately and repeatably control the rotation (and hence the axial displacement) of the grub screw, thus controlling the advancement or backing of the load cell towards the panel, and hence modifying the force acting on it. The large protractor allowed a resolution of 3.6° (sexagesimal degrees) corresponding to the axial displacement of 0.01 mm of the grub screw. A linear graduation on the lateral ruler indicated the number of entire rotations of the grub screw (1 turn = 1 mm). A soft preloaded coil spring ensured the contact between key and screw whichever way the panel was oriented, without affecting the measured load. In this way it became possible to impose on the panel very accurate displacements in conditions of absolute safety and to measure the force variations by means of the already mentioned load cells. Thus, well linear load-displacement curves, reported in Section 4, were obtained for each measurement location (L1-L2-L7-L8).

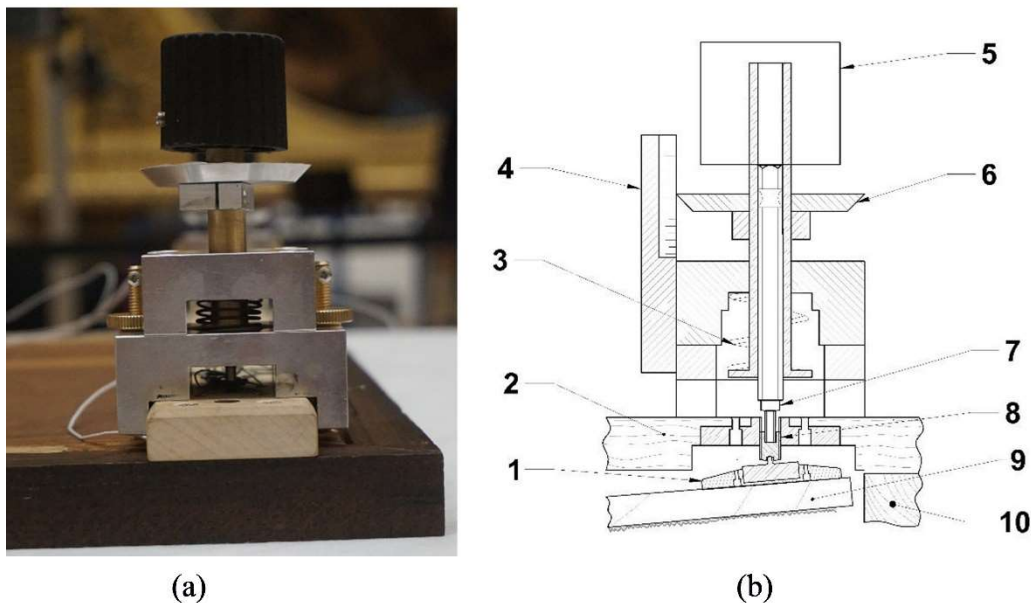

Fig. 3(a,b) – Picture (a), and schematic drawing (b), of one of the four identical removable devices (nicknamed *Jocondometers*), developed to identify the force-displacement relationships. (1) Presser and load cell. (2) Crossbeam, sectioned longitudinally. (3) Coil spring. (4) Lateral ruler. (5) Knob. (6) Protractor. (7) Hexagonal key. (8) Grub screw. (9) Panel. (10) Batten of the auxiliary frame.

3.5 The measurement of the deflections

The auxiliary frame and the crossbeams touch and constrain the panel only near its top and bottom edges; additionally, the panel touches the left vertical batten near its upper end [13]. Otherwise, owing to its longitudinal permanent curvature, the panel's central part does not come in contact with either the crossbeams or the auxiliary frame, and hence is free to move and deform, both transversally (cupping) and longitudinally (bowing). To measure both such deflections three displacement potentiometric transducers (SLS095 by Penny&Giles, stroke 10 mm, independent linearity $\pm 0.5\%$) were installed on the aluminium case fixed on the auxiliary frame (see Fig. 2a). Each transducer measures the deflection through a mechanical system already described in [11], touching the panel's back with a spherical feeler (each contact force amounts to about 1 N, small enough to avoid damaging the wood surface). The contact points of the three feelers are located on the panel's horizontal midline, one at each extreme and one at its centre; the corresponding deflections are thus measured with respect to the rear plane of the auxiliary frame (Fig. 4). Such geometry allows monitoring and computing separately both cupping f_c and bowing f_b as follows:

$$f_c = f_2 - [(f_1 + f_3)/2] \quad (1)$$

$$f_b = (f_1 + f_3)/2 \quad (2)$$

Note. Due to the limited space available behind the *Mona Lisa*, the transducers are positioned parallel to the panel, instead of perpendicular to it. For each of them a twofold pivoting lever system transfers to the cursor the deflection measured by the feeler, which ideally should be perpendicular to the rear plane of the auxiliary frame. Due to this arrangement, the feeler's spherical end moves along a circular rather than a linear path, which causes minor systematic geometric errors. However, given the small entity of the deflection variations (which at most are of the order of 0.5 mm), such non-linearity errors can be neglected, as well as the error produced by the fact that the slight lateral translation of the feeler causes the contact points to move transversally along the back of the panel, which is locally sloping due to its cupping distortion. The system was considered a good compromise to solve the space issue, despite the presence of the above-mentioned geometric errors which were well known to the authors since the beginning of the work; and which were also partly automatically compensated by the calibration of the system, performed with depth templates in correspondence with its actual working positions.

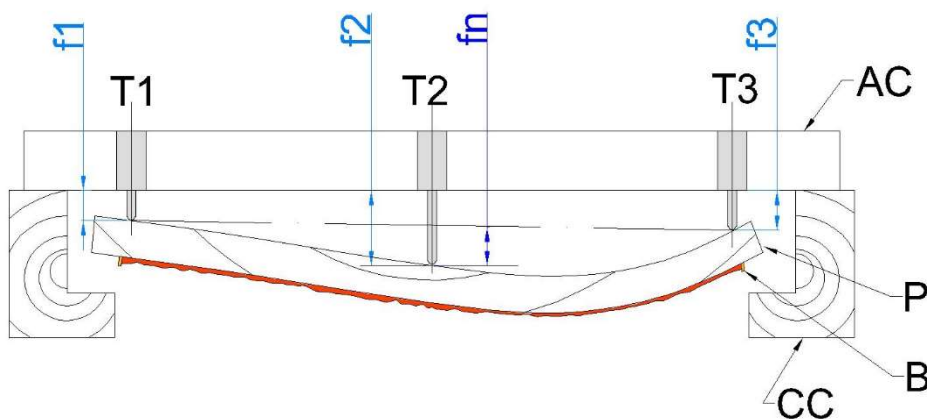

Fig. 4 – Schematic diagram (in cross-section) of the principle and of the equipment for monitoring the panel's deflections and cupping at mid-height. (CC) Batten of the auxiliary frame. (AC) Aluminium case (slightly shorter than the width of the auxiliary frame). (P) Panel. (B) "Barb" of the ground and paint layers (see Section 3.1 and Fig. 1b). (f_1, f_2, f_3) Deflections of the panel. (f_b) Panel bowing. (f_c) Panel cupping. (T1, T2, T3) Transducers (drawing just outlined: for clarity and simplicity, the actual kinematics of the transducers (see [11] have been omitted).

3.6 The measurement of climate inside the display case

The relative humidity (RH) in the display case is monitored and controlled by a dedicated air conditioning system, while air temperature (T) is determined by that of the room where the artwork is exhibited (the *Salle des États*); both systems are managed by the museum's technical department. To thoroughly monitor and analyse the panel's mechanical behaviour and the main factors that determine it, climatic data had to be directly available to the international team, in a format and a timing allowing them to be used in connection with those describing the panel's forces and deformations. Therefore, data on air T and RH near the panel were also collected by ad hoc sensors and recorded by the same data-logger as the other data, all such equipment being placed in the aluminium case (see Section 3.7). Additionally, a self-powered data logger (HOBO U12- 013 by Onset, accuracy ± 0.35 °C and ± 2.5 %) placed inside the display case measured and recorded independently the T and RH, and was used as a further data source in synchronism with the climate, force and displacement data logged by the main monitoring unit.

3.7 Data collection, storage and wireless transmission

Since 2005, the authors developed an instrumented aluminium case, fixed on the auxiliary frame at mid-height, facing but not touching the back face of the panel, with the function of housing, protecting, and shielding both the deflection transducers and the electronics (including the power supply batteries) of the monitoring equipment. This case was re-designed and replaced several times, according to the evolution of the instrumentation. The latest version (see Fig. 2a) houses (a) the three displacement transducers that monitor the deflection of the panel, (b) the sensors measuring T and RH in close proximity to the panel, (c) the electronic equipment of the load cells, (d) the data logger, and (e) the equipment for wireless data transmission.

Initially, the monitoring of the panel's hygro-mechanical response to climate fluctuations was limited by the memory size of the data loggers (two HOBO[®] U12-006 featuring 4 external channels each). In 2006, a new data-logger was adopted, and a new connection apparatus was implemented, as described below. The current data-logger used (XR5-SE by PACE Scientific, 8 external channels + 1 internal monitoring the temperature, 12-bit AD converter, accuracy ± 0.35 % F.S.) reads the RH sensor, the three displacement transducers, and the four load cells, and stores the readings at the desired time intervals (typically, every 30 minutes throughout the year, when the display case is closed, and at shorter intervals - down to 2 seconds - during manual measurements or other tests). The data can be downloaded – depending on the situation – through a cable connection or wirelessly, by means of the connection apparatus. Such apparatus, named LAB-MoB, of which no equivalent equipment was commercially available at that time, was expressly developed and patented [22]. It is based on a Bluetooth RS232 antenna, interfaced to the data logger using a standard serial communication protocol without proprietary communication modifications. Thanks to such device, not only a logging system with greater capacity was used, but it became also possible to interact with it (including data downloading and modifying at will the sample rate) while staying a few meters away, without opening the display case. To ensure data confidentiality, the Bluetooth access is secured by a password. To keep energy requirements reduced, a super-low consumption ($< 90 \mu\text{A}$) switch controlled by a remote transmitter, which allows to turn on the connection only when needed. This further possibility also improves the security, preventing any unauthorized connection to the data-logging system, since without the remote transmitter it is impossible to discover the connection ID in the room.

4 Results and discussion

4.1 The climatic conditions

The data obtained from the continuous monitoring provide significant information about the forces and deformations to which the panel is subjected, and about their variations, caused mainly by the inevitable, albeit small, fluctuations of the climatic parameters, namely of the RH. As an example, the fluctuations monitored for one whole year can be observed in Fig. 5, and possibly derive from external (i.e. of the *Salle des États* hall) temperature fluctuations and from the normal functioning of the conditioning plant. The results presented here refer to only one year of monitoring. However, as the climatic conditions within the display case are fairly stable year-to-year, they can be considered representative of the last 18 years. On the other hand, the rare anomalous deviations, commented on below, are probably attributable to occasional openings of the display case.

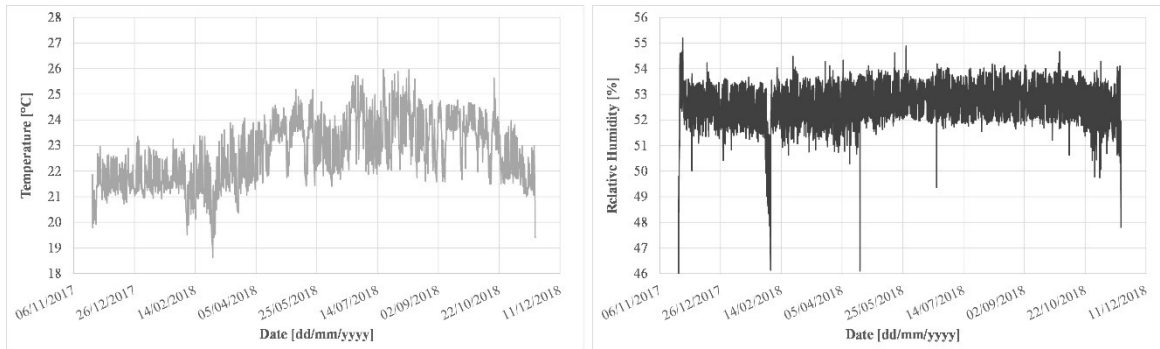

Fig. 5 – Graphs of temperature T (on the left, light grey curve) and relative humidity RH (on the right, dark grey curve) against time, monitored for a period of 12 months (21/11/2017-20/11/2018) in the display case close to the panel's back face, recorded every 30 minutes.

The analysis of the frequencies for both T and RH (see Fig. 6) confirmed the stability of climate conditions inside the display case.

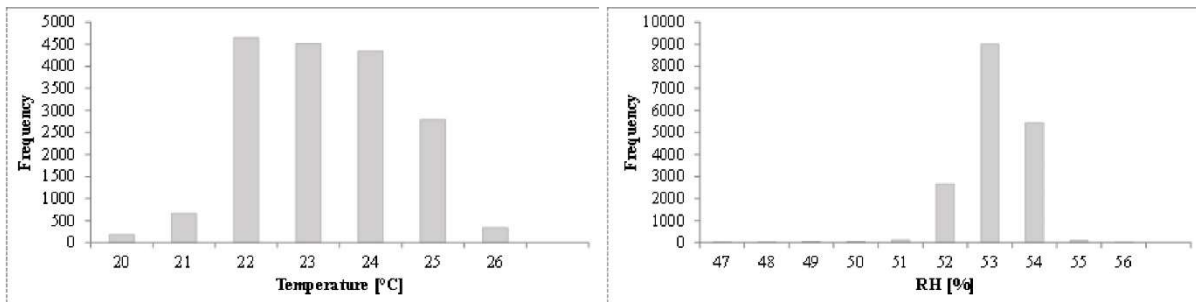

Fig. 6 – Frequency distributions of temperature and relative humidity (RH), with average values of 23 °C (std. dev. ± 1 °C) and 53 % (std. dev. ± 0.7 %) respectively, during the period shown in Fig. 5.

4.2 The mechanical behaviour of the panel

The forces monitored by the four load cells and the deflections measured by the three displacement transducers are shown in Fig. 7 as total force and cupping deflection curves. The yearlong data testify the good quality and reliability of the measurement system, which allows monitoring without interference with the visitor's experience, or the need to access the artwork. For all the monitored years, the same trend is shown by the total force and cupping deflection curves, which represent the hygro-mechanical response of the *Mona Lisa*'s panel (constantly constrained between the auxiliary frame and the crossbeams) under the action of the T and RH variations in the display case.

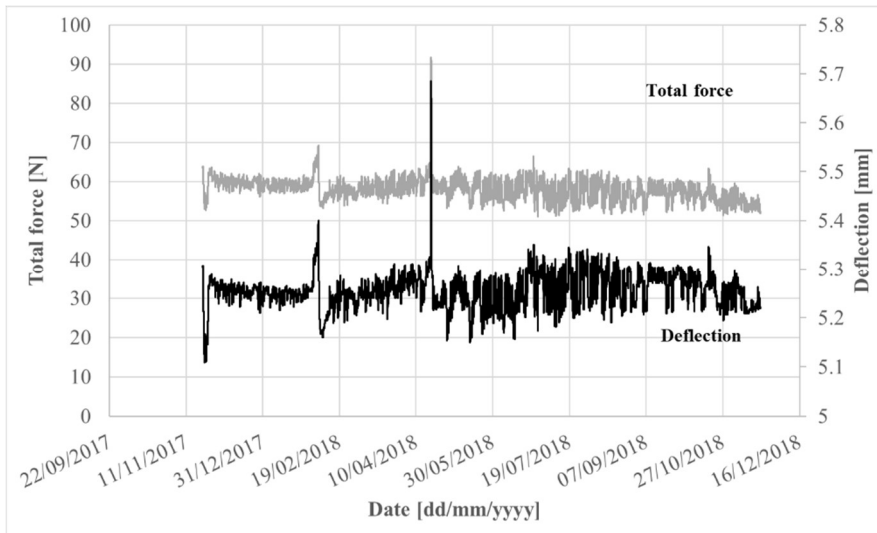

Fig. 7 – Examples of total force (grey line) and cupping deflection (black line) data resulting from the year-long monitoring of the panel's response to the hygrothermal fluctuations in the display case shown in Fig. 5. Cupping deflection (f_c in Fig. 4) and total force (sum of forces measured in locations L1-L2-L7-L8, see Fig. 2a) are plotted against time for the same period. Note. The highest peaks of force (90,7 N) and deflection (5.7 mm) occurring on 19/04/2018 are partially superimposed.

A thorough analysis of the climate conditions inside the display case, and of the resulting panel's response, is beyond the scope of this paper and will possibly be published in a near future.

The minor climatic fluctuations occurring constantly throughout the year are reflected in similar minor fluctuations in the rather constant force and deflection values. A two-dimensional numerical simulation of the effects of such fluctuations was published in [23].

The three following unusual changes of climatic conditions occurred in the year presented. Two climatic spikes occurred on 19/04/2018 and 21/06/2018, and are reflected in two force and deflection spikes, well noticeable although small in absolute value. A longer lasting climatic perturbation occurred on 02/02 to 05/02/2018; a brief examination of the data collected, and the graphs shown here can provide the following simple indications: (i) both the force and deflection variations are quite small in absolute values, (ii) the panel's response starts approximately 4 hours after the onset of the climatic disturbance, and (iii) the panel takes about 6 days after the end of the disturbance, to reach its 'steady state' conditions again.

The mechanical behaviour of the wooden panel can also be represented by means of the force-deflection graphs plotted in Fig. 8, where for each year the point clouds are well fitted by linear trend lines (R^2 consistently > 0.75); the slight deviations from linearity are probably due to friction, visco-elastic phenomena, hysteresis, and mechano-sorption. In addition, the fact that such fitted lines, which can be interpreted as representing a sort of rigidity of the system, remain parallel to each other over the years, suggests that no irreversible processes have occurred in the panel, and that hence the present climatic conditions can be considered favourable to its conservation. Small changes from year-to-year result from slightly different loading conditions, possibly caused by different adjustments of the load cells after disassembly and reassembly of the system at each opening day.

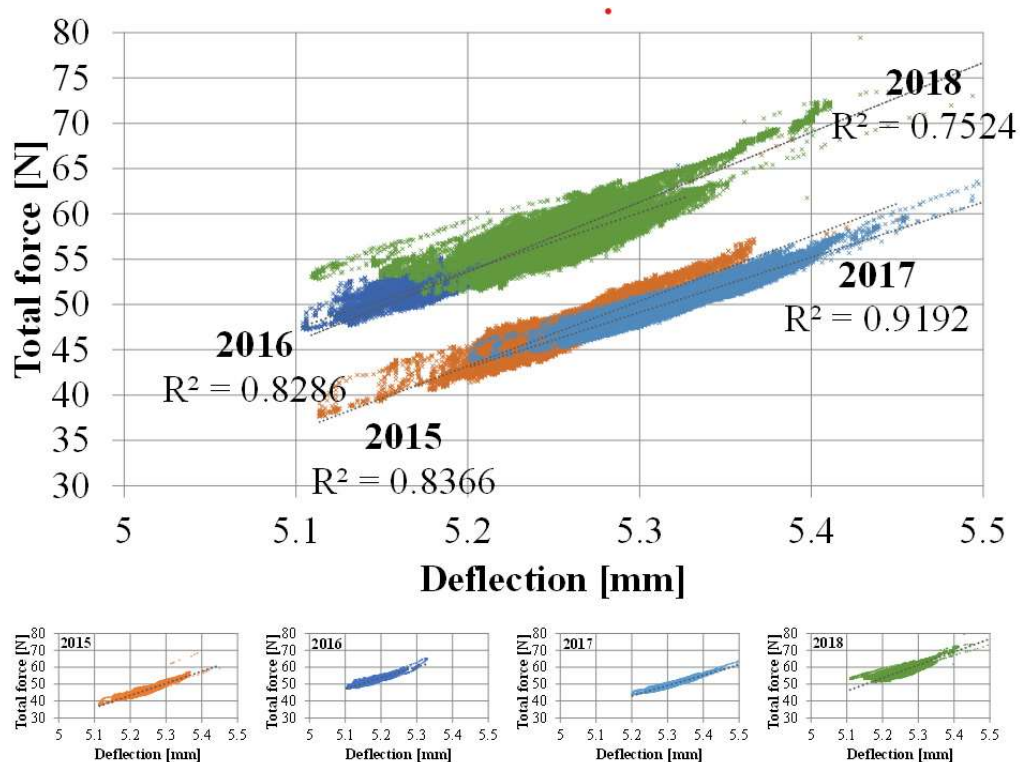

Fig. 8 – Force-deflection graphs plotted for years 2015 to 2018. In the large graph, the data of all years have been presented showing their substantial similarity despite their partial overlapping. The smaller separate graphs enable seeing full data ranges of individual years.

In addition to the yearlong mechanical behaviour shown by the panel while exhibited inside the display case, the results from the punctual test regarding its apparent stiffness (intended as a local ratio between applied force and measured displacement) are presented below. The experimental data (see Section 3.4) were organised in force-displacement curves (see Fig. 9) showing a linear relationship between the displacement imposed on a load cell and the corresponding increase in the load measured by it. The slope of each curve represents the apparent stiffness of the various parts of the panel, as “seen” from the various loading points L1-L2-L7-L8; in fact, the experimental data show a significantly different slope for each of the four locations (see Table 1). These differences can be attributed to many factors, including wood variability, asymmetry of contacts between panel and auxiliary frame, and the presence of the crack, which certainly influences the mechanical response of the panel.

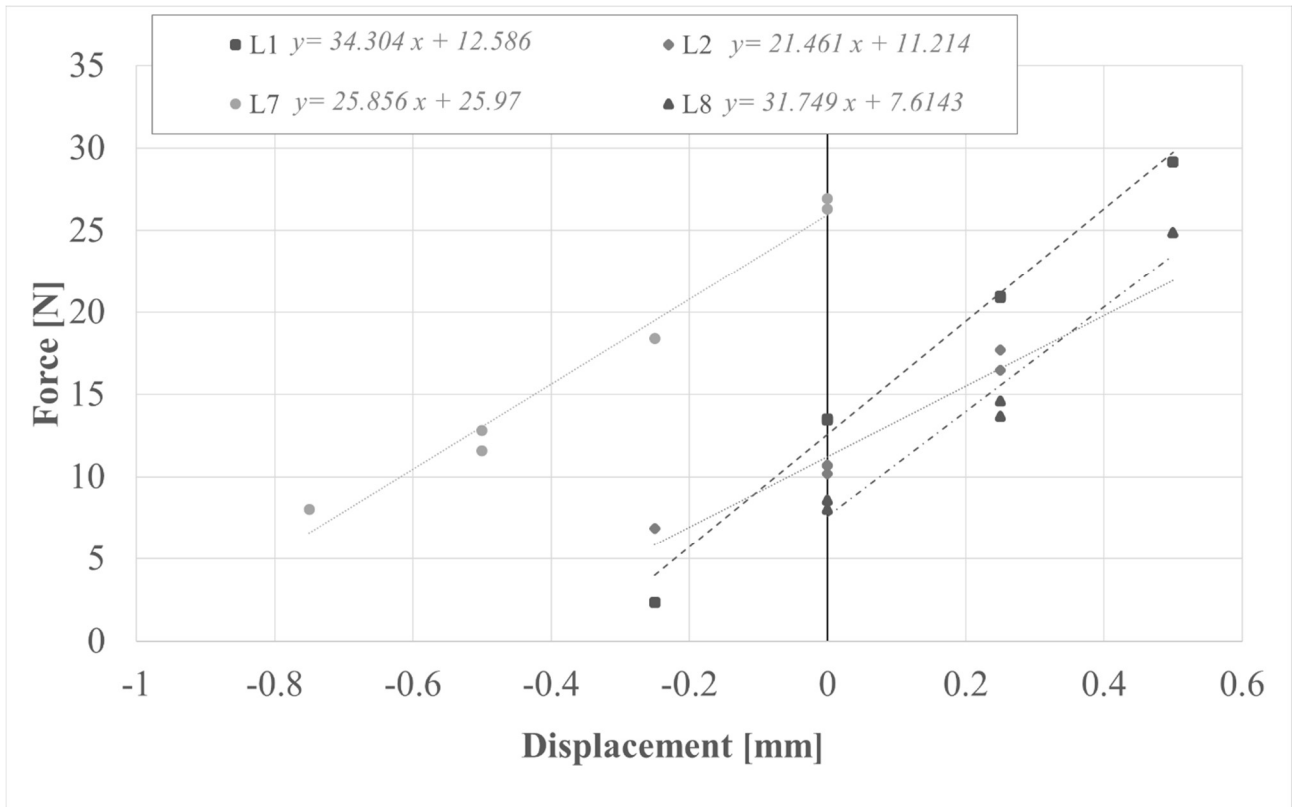

Fig. 9 Force-displacement graphs plotted for each of the four locations (L1-L2-L7-L8); R^2 values larger than 0.95 confirm that the tests were carried out in the elastic range.

Table 1 – Apparent stiffness values of the panel (i.e. force increments produced by 1 mm displacement of the corresponding load cell) in locations L1-L2-L7-L8, derived from the trendline equations shown in Fig. 9.

Location	Force increment per 1 mm displacement [N]
L1	34
L2	21
L7	26
L8	32

It is not the focus of this paper to show comprehensively the results of the monitoring described here; therefore, the above results, derived from elementary graphing and calculations, are reported just by way of example. However, the authors are planning to publish in a near future a further paper, dealing with the mechanical behaviour and the FE-modelling of the *Mona Lisa* panel [24].

5. Conclusions

This paper describes in detail the methods and the equipment developed for continuous monitoring of the mechanical and deformative state of a panel painting under museum display conditions; in our case the panel of the *Mona Lisa* exhibited at the Louvre Museum. This monitoring proved its effectiveness in allowing a more in-depth knowledge of the artwork and of its behaviour, and in providing the data needed for calibrating reliable digital models able to describe accurately the individual panel's response to environmental fluctuations, or to the application of forces and other external actions. Such methods and equipment were developed and improved over time, based on a thorough evaluation of (a) the objectives of the whole project, (b) the constraints constituted by the fact that the research work concerned a famous and delicate historic artwork constantly exhibited to the public, and (c) an accurate technological analysis of the painted panel and of its assembly. After eighteen years of work, it can be concluded that the methods and equipment described in this paper do work correctly and provide reliable results, obtained in a non-invasive way and respecting all the safety and functionality constraints deriving from the artwork's permanent on display status.

A similar approach can be adopted for other panel paintings, to obtain similar results. However, appropriate methods and equipment obviously need to be conceived and adapted to each individual artwork, considering its specific peculiarities and constraints. As for the parameters describing the material properties and the behaviour of wooden artworks, to be used in numerical models and simulations, the author's experience – both on historic panel paintings and on mock-models – indicates that the variability is extremely high, and that using numbers found in the literature provides unreliable, if not completely wrong results.

Some examples of the data collected are also reported in this paper, together with intermediate results deriving from basic processing, such as (a) the force-deformation relationships derived from direct manual tests, (b) the climatic, force and deflection data monitored throughout the whole year, and (c) the force-deflection graphs plotted for years 2015 to 2018, suggesting that the present climatic conditions maintained in the display case can be considered favourable to the panel's conservation. The forces acting on the panel have been monitored in the current constraint conditions and can now be adjusted as required by the conservation needs. The contact conditions between the auxiliary frame and the external gilded frame have been identified and adjusted to prevent the onset of uncontrollable deformations and forces at the time of reassembly.

Acknowledgments

One of the reasons why the work described here can be considered effective, is that it has always been carried out in close, sincere, and fruitful collaboration not only within individual groups, between specialists of different disciplines, and with the expert restorers, but firstly and mostly with the curators in charge of the artwork's management and conservation.

With the hope of not having inadvertently omitted anyone, the authors sincerely thank all those who through cooperation and mutual confidence made in many ways this work possible, including the following (that for practical reasons are divided according to the institutions or professional categories to which they belong, and within them are listed in alphabetical order).

From the Louvre Museum: Sébastien Allard (present head) and Vincent Pomarède (former head) of the Painting Department - Vincent Delieuvin (present chief curator) and Cécile Scaillerez (former chief curator) of Italian painting of the sixteenth century paintings department) – In charge of the climatization equipment: Eric Burgart, Antoine Carnino (†), Olivier Leçon, Philippe Martins

From C2RMF (National Centre for Research and Restoration in French Museums): Michel Menu, Bruno Mottin, Elisabeth Ravaud, Jean-Paul Rioux

From University of Florence (DAGRI, former-GESAAF, University di Florence, Florence, Italy): Linda Cocchi, Marco Fioravanti, Luisa Ghelardini, Lorenzo Vedovato

From University of Lorraine (LerMAB, Univ. Lorraine, Epinal, France): Romain Rémond

From University of Montpellier (LMGC, Univ. Montpellier, CNRS, Montpellier, France): Olivier Arnould, Sandrine Bardet, Delphine Jullien

From University of Paris-Saclay (LGPM, Centrale Supélec, Gif-sur-Yvette, France): Patrick Perré

From University of Poitiers (Institut Pprime, Université de Poitiers, CNRS, Poitiers, France): Fabrice Brémand, Pascal Doumalin, Jean-Christophe Dupré, Franck Hesser, Valery Valle

From INSA Lyon (LaMCos, INSA Lyon, France): Julien Colmars, David Dureisseix

From Art et Métier (LaBoMaP, Arts et Métiers Institut de Technologie, Cluny, France): Bertrand Marcon

Independent restorers and engineers of wooden panels: Jonathan Graindorge-Lamour (Moulins le Carbonnel, 72130 France), Daniel Jaunard (from Paris, one of the historical restorers, retired in 2014), Gilles Tournillon and Cécilia Gauvin (S-MA-C-H, Science and mechanics in conservation of heritage, Le Château, 594 Rte de Suze-la-Rousse, 84290 Sainte Cécile les Vignes)

Florentine Masters of precision machining, having collaborated with competence and passion in practical design and manufacture of the *ad hoc* equipment: Alfredo Canacci (†), Fulvio Smorti

Italian electronic engineers, having collaborated in the design, construction and calibration of the LAB-MoB connection apparatus: Massimo Liggio, Stefano Lucchetti

Manufacturer of the miniature load cells: Gianni Fondriest (†), co-founder of Deltatech (Sogliano al Rubicone, Forlì-Cesena, Italy)

References

- [1] L. Uzielli, Historical overview of panel-making techniques in central Italy, The Getty Conservation Institute, Los Angeles, 1998, pp. 110–135.
- [2] J. Wadum, Historical overview of panel-making techniques in northern countries, The Getty Conservation Institute, Los Angeles, 1998, pp. 149–177.
- [3] R. D. Buck, Some applications of mechanics to the treatment of panel paintings, *Studies in Conservation*, 1961, 6 (1): 156–162.
- [4] R. D. Buck, Some applications of rheology to the treatment of panel paintings, *Studies in Conservation*, 1972, 17:1-11
- [5] B. R. Hoadley, Chemical and physical properties of wood, The Getty Conservation Institute, Los Angeles, 1998, pp. 2–20.
- [6] A. Unger, A. Schniewind, and W. Unger, *Conservation of Wood Artifacts, a Handbook*. Springer Berlin Heidelberg, 2001. doi: <https://doi.org/10.1007/978-3-662-06398-9>.
- [7] J. Gril, Ed., Wood science for conservation COST Action IE0601. *Journal of Cultural Heritage*, 2012.
- [8] K. Dardes and A. Rothe, Eds., *The structural conservation of panel paintings: Proceedings of a Symposium at the J. Paul Getty Museum 24-28 April 1995*, The Getty Conservation Institute, Los Angeles, 1998.
- [9] A. Phenix and S. A. Chui, Eds., *Facing the challenges of panel paintings conservation: trends, treatments, and trainings. Proceedings of the symposium 17-18 May 2009*, The Getty Conservation Institute, Los Angeles, 2011.
- [10] M. Ciatti and C. Frosinini, Eds., *Structural conservation of Panel paintings at the Opificio delle Pietre Dure in Florence: method, theory, and practice*. Florence, Edifir, 2016.
- [11] L. Uzielli, P. Dionisi Vici, and J. Gril, “Physical and Mechanical Characterization of the Support,” in *Mona Lisa, inside the painting*, J. P. Mohen, M. Menu, and B. Mottin, Eds. New York, 2006, pp. 48–49.
- [12] D. Hunt, L. Uzielli, and P. Mazzanti, Strains in gesso on painted wood panels during humidity changes and cupping, *Journal of Cultural Heritage*, 2017, 25:163-169.
- [13] G. Goli, P. Dionisi Vici, and L. Uzielli, Locating contact areas and estimating contact forces between the Mona Lisa wooden panel and its frame, *Journal of Cultural Heritage*, 2013, 15 (4): 391-402.
- [14] F. Brémand, P. Doumalin, J. C. Dupré, F. Hesser, and V. Valle, Measuring the Relief of the Panel Support without Contact, in *Mona Lisa, inside the painting*, J. P. Mohen, M. Menu, and B. Mottin, Eds. New York: Abrams, 2006, pp. 43–47.
- [15] F. Brémand, P. Doumalin, J. C. Dupré, A. Germaneau, F. Hesser, and V. Valle, Mechanical structure analysis by Digital Image Correlation and Fringe Pattern Profilometry, Joint focused meeting, COST Actions IE0601 and FP0601, *Non-destructive techniques to study Wooden Cultural Heritage Objects (WCHOs)*, 2011.
- [16] E. Ravaud, The Complex System of Fine Cracks, in *Mona Lisa, inside the painting*, J. P. Mohen, M. Menu, and B. Mottin, Eds. New York, Abrams, 2006, pp. 38–42.
- [17] N. Volle, G. Aitken, D. Jaunard, B. Lauwick, P. Mandron, and J. P. Rioux, Early Restorations to the Painting, in *Mona Lisa, inside the painting*, J. P. Mohen, M. Menu, and B. Mottin, Eds. New York: Abrams, 2006, p. 18-21.

- [18] P. Mazzanti, J. Colmars, J. Gril, D. Hunt, and L. Uzielli, A hygro-mechanical analysis of poplar wood along the tangential direction by restrained swelling test, *Wood Science and Technology*, 2014, 48 (4): 673-687, doi: 10.1007/s00226-014-0633-4.
- [19] E. Ravaud, The Mona Lisa's Wooden Support, in *Mona Lisa, inside the painting*, J. P. Mohen, M. Menu, and B. Mottin, Eds. New York: Abrams, 2006, pp. 32–37.
- [20] L. Uzielli, Personal communication, paper under preparation, 2022.
- [21] D. Dureisseix, J. Gril and O. Arnould, Mechanical Modeling of the Activity of the Flexible Frame, in *Mona Lisa, inside the painting*, J. P. Mohen, M. Menu, and B. Mottin, Eds. New York, Abrams, 2006, pp. 52–53.
- [22] S. Lucchetti and P. Dionisi Vici, Wireless apparatus for remote monitoring of e.g. art objects and, in general, of inaccessible objects of any kind, 2006
- [23] P. Perré, R. Remond, and J. Gril, Simulation of the Effects of Ambient Variations, in *Mona Lisa, inside the painting*, J. P. Mohen, M. Menu, and B. Mottin, Eds. New York, Abrams, 2006, pp. 50–51.
- [24] L. Riparbelli, Personal communication, paper under preparation, 2022.