



HAL
open science

A novel procedure for CFU plating and counting

Bahram Houchmandzadeh, Patrice Ballet

► **To cite this version:**

Bahram Houchmandzadeh, Patrice Ballet. A novel procedure for CFU plating and counting. 2022.
hal-03890465v1

HAL Id: hal-03890465

<https://hal.science/hal-03890465v1>

Preprint submitted on 8 Dec 2022 (v1), last revised 7 Mar 2023 (v2)

HAL is a multi-disciplinary open access archive for the deposit and dissemination of scientific research documents, whether they are published or not. The documents may come from teaching and research institutions in France or abroad, or from public or private research centers.

L'archive ouverte pluridisciplinaire **HAL**, est destinée au dépôt et à la diffusion de documents scientifiques de niveau recherche, publiés ou non, émanant des établissements d'enseignement et de recherche français ou étrangers, des laboratoires publics ou privés.

A novel procedure for CFU plating and counting

Bahram Houchmandzadeh and Patrice Ballet
*Univ. Grenoble Alpes, CNRS, LIPhy, F-38000 Grenoble, France.**

We present a novel method to automate plating for the Colony Forming Unit (CFU) counting procedure. The apparatus we developed for the application of this method is based on motorized stages and syringe in order to spread fine drops of a liquid containing a solution of interest on a plate without direct contact. The apparatus can be used in two modes : (i) the classical methods of CFU on agar plate and (ii) a novel method we call P_0 of spreading on a solid substrate (plastic or glass). This new method removes the need for preparing agar surfaces and allows for easy disposal of waste and reuse of consumables. The apparatus is simple to build and use, the plating is fast and the CFU count in both type of plating is extremely reproducible and robust.

I. BACKGROUND.

Colony Forming Unit count is the standard method of counting the number of living microorganisms contained in a liquid capable of growth on a specific medium. This very versatile method is the standard technique to measure the number of living bacteria for example in water or milk to insure their safety, in medical samples such as urine or blood to determine the degree of infection and select the antimicrobial agent to use, in microbiology lab to control the outcome of nearly any experiment, ...

This remarkable method, summarized in figure 1 was invented at the birth of microbiology by R. Koch, R.J. Petri and F. Hesse in 1880's[1, 2] and has been used during the past 140 years with practically no modifications[3, 4]. The reliability and various sources of error of this technique have been investigated for more than a hundred years[5]. The manual method's of spreading is robust and simple, necessitates only rudimentary equipment and can be practiced by any skilled worker after some training, hence its success and longevity.

The manual method has also its drawbacks. To list a few: (i) It is a time consuming method and an operator cannot plate more than about 50 plates before being overcome by fatigue. (ii) The liquid drop deposited at the agar surface is small, usually of order of $100\mu\text{L}$, and can hardly be distinguished from the surface; the operator then exerts various streaks in all direction to spread the drop as uniformly as possible on the surface. If the operator does not exert enough care (such as in figure 1.b), the result is a sub-optimal spreading with colonies aggregating more in some part of the Petri dish. Only a homogeneous distribution of colonies will allow a reliable colony count and the sub-optimality increases the errors in the estimation of the true number of living bacteria. While it is relatively easy to carefully spread a few plates, it becomes difficult to keep the quality of spreading when dozens or hundred plates have to be made. (iii) An often neglected phenomenon is the damage induced to some bacteria by the mechanical act of spreading[6]; in fact, the amount of damage increases with the time it takes to

spread the microorganisms, which is often necessary for a good spreading.

We present here a novel technique to automate the spread-plating method. We built a small robot that implements this method.

Presently, there exists one such method called "spiral plating" developed by Gilchrist and Campbell[7] at FDA in 1972, and various robotic setups of this technique (for a price range of up to \$20000) are commercially available. In this method, a pipette in contact with the agar plate dispenses small amount of liquid containing microorganisms on a rotating Petri dish. The rotation of the dish is coupled to the movement of the arm holding the pipette, resulting in a spiral deposition of liquid on the agar surface. There are also much more sophisticated methods for manipulating 96 pipette tips, taking up liquid from 96 well plate and depositing them on the surface of the

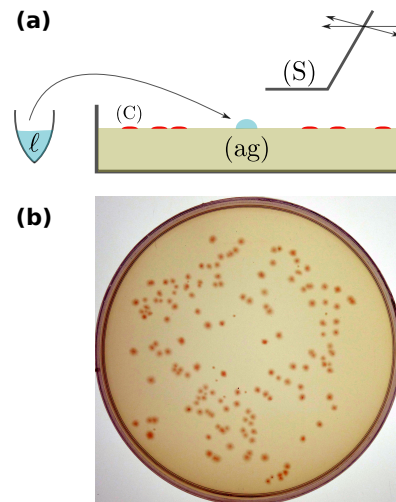

Figure 1. Manual plating method : (a) a drop of liquid (ℓ) containing microorganisms is deposited on an nutriment rich agarose plate (ag) and spread manually using a spreader (S). After incubation for an appropriate amount of time, isolated bacteria on the plate that have duplicated form visible colonies (C). The bacterial concentration is then estimated as N/V , where N is the number of colonies and V the volume of deposited drops. (b) A typical sub-optimal plating obtained by manual method on a 85mm Petri dish.

* bahram.houchmandzadeh@univ-grenoble-alpes.fr

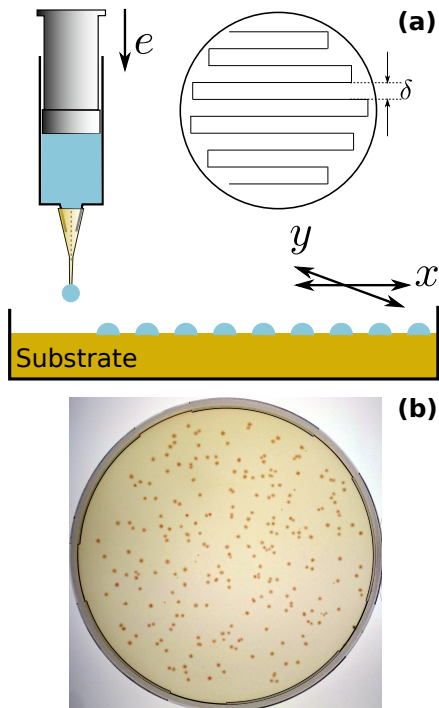

Figure 2. The *Platorix* robot. (a) A Petri dish is placed on a motorized stage and moves sequentially in x and y direction underneath a syringe. The piston of the syringe is driven continuously by a third motor e . When drops reach a critical volume V , depending on the needle size, they detach and fall on the substrate. Synchronizing the speed of the xy scan and the e motor results in a perfect spread. (b) A typical example of automated plating of bacteria on a 150mm Petri dish containing the gelled substrate. The quality of the spreading is close to the theoretical limit (see V G). The liquid sample used for this plating is the same as the one used for the manual example of figure 1.b

agar ; however these are expensive, cumbersome robots not designed for spread plating.

The method we present here (figure 2) consists of *linear* motion of the Petri dish in the $x - y$ direction, while a syringe *not in contact* with the surface deposits micro drops on the surface of the plate. The apparatus that implements this method, dubbed *Platorix* in this article, is simple to operate and to build, as it uses only cheap, commercially available parts (see section V A).

The fact that the drops can be *isolated* and the flow to be discontinuous allows for the apparatus to operate in two different modes called here *autoplate* and P_0 . The autoplate mode is similar in its principle to the manual CFU method (section II) and does not necessitate noticeable change from the methods used currently in microbiology laboratories. The new method (section III) P_0 allows for a completely novel form of CFU counting that is digital in its principle. The P_0 method has many advantages over the autoplate (or manual spread) but necessitates a change of operational habits. In particular, the P_0 method eliminates the need for a gelled growth

substrate, eliminate the waste management problem as the Petri dishes are reused, and accelerate the counting process by the 0/1 readout of a regular grid (fig 4.c).

The autoplate method is described in section II ; section III is devoted to the P_0 method ; section IV contains the discussion of the new procedures and further possible developments. The technical aspects of the procedure are detailed in section V.

II. AUTOPLATE SPREADING METHOD

A. Operational procedure.

In the autoplate method, the Petri dish (usually 90mm or 150 mm in diameter) is filled as usual with the agar gel containing the nutriment appropriate for the given growth. The stage is scanned line by line in the x direction and on each line, a number of small drops are deposited. At the end of each line, the stage is moved by one step of size δ in the y direction and the Petri dish is scanned in the opposite direction while drops fall again on the substrate (figure 2.a). The scanning continues until the entire Petri dish is covered by drops and the preset quantity of liquid has been delivered.

The agar surface is a gel of agarose polymers in water. Therefore, the contact angle of the drops with the agar surface is close to zero: upon falling on the substrate, each drop spreads to about the size δ (the optimal δ is chosen such as to be of the size of the squashed drops) and fuse with adjacent drops, ensuring the perfect distribution of the liquid on the surface of the Petri dish. The spatial distribution of drops is always close to the theoretical limit of homogeneous spreading (figure 2.b). Typical deposition time are of the order of 20 sec and 40 sec for 90mm and 150mm Petri dishes.

B. Precision, reproducibility and linearity of autoplate.

The *Platorix* robot can thus provide a close to ideal spreading of the solution onto the agar plate. However, the precision of CFU count is fundamentally limited by statistical dispersion : if a solution contains particles at concentration C , the number of particles in a volume V of the liquid follows a Poisson law distribution with mean $\bar{n} = CV$ and standard deviation $\sigma = \sqrt{\bar{n}}$. This means that when plating M Petri dishes, the measured number of colonies in each of them falls between one standard deviation of the true value (when \bar{n} is large, ≥ 10) 69% of the times. This is the theoretical limit of the CFU method precision. Usually, human operators using manual spreading do not reach this precision due to the biases described in the preceding section. Figure 3.a shows on the other hand that the *Platorix* robot operates always at the theoretical precision by comparing the standard deviation of the measured number of colonies (error bars)

to the theoretical limit (gray area).

Another important factor for any measurement procedure is its linearity and dynamic range : If a concentration C of organisms is measured from a given sample, is the procedure capable of measuring reliably a concentration xC when then sample is diluted/concentrated by a factor x ?

The autoplate method shows also excellent result for the linearity of CFU count, even at a high number of colonies per plate, as it can be seen in figure 3.b. The dynamic range of 10 fold is made possible by the high uniformity of the automatic spreading.

III. THE P_0 METHOD

A. Drawbacks of spreading on gel surface.

Even though the automated spreading on agar plates greatly improves the precision and reproducibility compared to the manual method, an entirely different approach can substantially improve the counting of viable microorganisms in a sample.

The procedure for standard CFU counting comprises (i) the substrate preparation, (ii) the actual spreading, (iii) counting after incubation and (iv) waste managements. The actual spreading of the liquid on the substrate (step (ii)) takes a small amount of time compared to the other steps.

Substrate preparation seems particularly wasteful. In order to let microorganisms grow on the *surface* of the substrate, a comparatively large amount of gelled substrate, comprising water with appropriate salt, the nutrients (glucose or other carbon sources), and the polymerizing agent (agarose or similar polymers) have to be prepared beforehand by pouring into a Petri dish while still hot and liquid, then letting it cool to form the gel. Typically, a 90mm Petri requires 20-25mL of media in order to uniformly fill the Petri dish and not dry during the incubation period. Of this volume, only the upper layer is actually used by microorganisms.

After the incubation period and CFU counting, it is too time consuming to recycle the filled Petri dishes. Instead, they are collected into special bins that have to be sterilized before being discarded, generating large amount of biological waste and necessitating special logistic for handling.

The counting process can also be time consuming because organisms are dispersed at random on the surface. Care must be taken when counting large number (> 150) of colonies in order to distinguish colonies that have grown close to each other from single colonies. Even though image analysis programs have been developed to automatize this process, they are usually not perfect and may need some degree of manual curation.

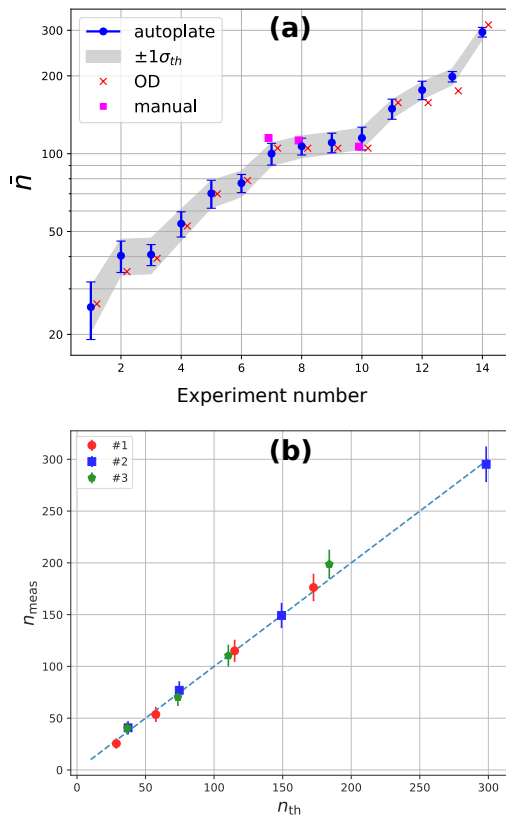

Figure 3. (a) Precision of the CFU counting on the agar plates with the autoplate method for 14 different measurements. Each set of measurements contains 5-8 Petri dishes under the same conditions : bacteria are grown in the M9 media (see section VB), collected at OD $\in [0.2 - 0.8]$, and diluted to obtain the desired expected numbers of bacteria per plate. They are then deposited on the agar surface by the Platorix robot and allowed to form colonies. Filled blue circle (\bullet): average number of colonies (\bar{n}) counted on the agar plates of each measurement, while the error bars indicate the measured standard deviation of the counted number of colonies n in these plates. The gray area shows the $\bar{n} \pm \sigma_{th}$ region where the theoretical standard deviation $\sigma_{th} = \sqrt{\bar{n}}$. The red crosses (\times) indicate the expected number of colonies based on OD measurements and the filled squares (\blacksquare) are manual spread measurements. For clarity, OD and manual measurements are shown with a slight shift on the horizontal axis and their own error bars are omitted.

(b) Three different set of linearity measurements. In each measurement, 4 different dilutions of the same solution of bacteria are prepared and each dilution is autoplated on 5-8 plates. One of the dilution in the series (usually one with around 100 colony per plate) is used as the reference point and the *expected* number of colonies n_{th} in the other solutions of the series are computed from the dilution ratio. On the other hand, the actual number of colonies in each agar plate is measured and their average is called n_{meas} . The above figure shows n_{meas} as a function of n_{th} . Error bars are the theoretical standard deviations $\sigma_{th} = \sqrt{\bar{n}}$.

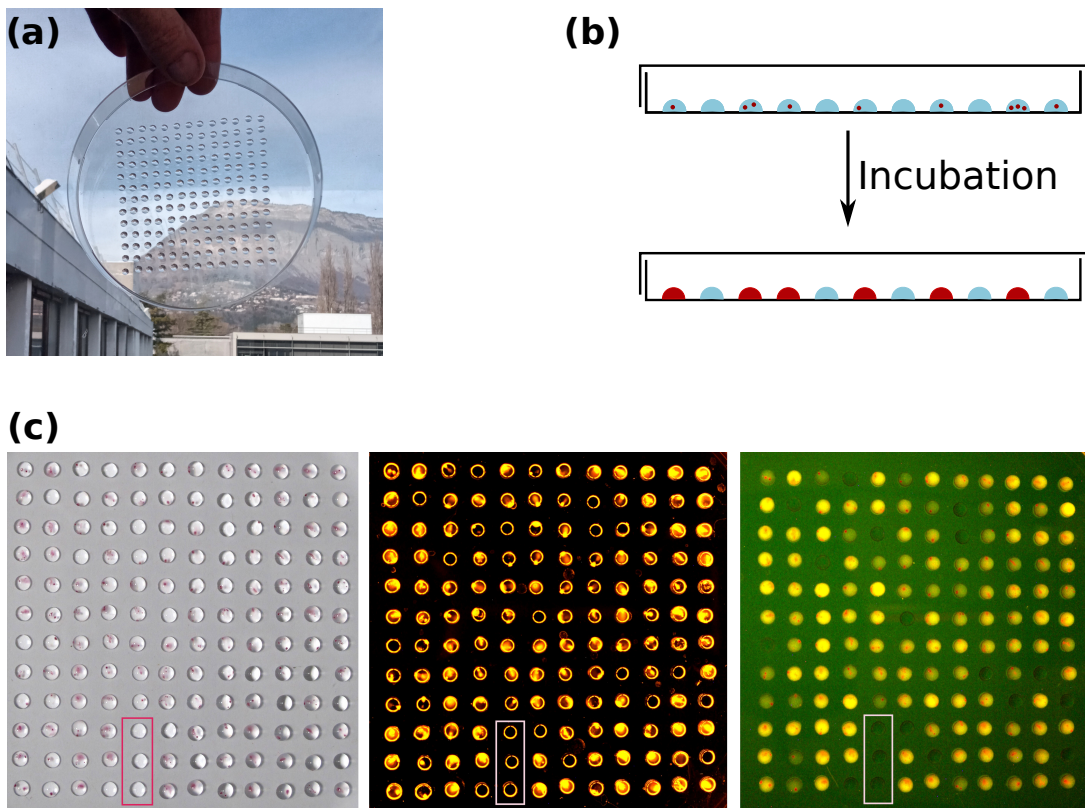

Figure 4. (a) Drops of precisely controlled size deposited directly on the surface of a Petri Dish (see section VC). The Petri dish is treated once with an alkaline detergent to immobilize the drops (see section VE). After use, the Petri is washed with normal soap and sterilized for reuse.

(b) The P_0 method. Equal volume isolated drops, of volume V and containing growth media and microorganisms at concentration C are deposited on the surface of the Petri dish. The actual number of organisms in a drop is a random variable with mean $\lambda = CV$. After incubation, only drops without any organisms remain unchanged. Counting the relative number P_0 of these drops leads to determination of $C = -\ln(P_0)/V$ (relation 5).

(c) A typical result of P_0 plating, using a square grid on a 150mm Petri dish. Distance between two lines is 7.6mm and images are $\approx 80 \times 80$ mm. After incubation, empty/filled drops in the Petri dish can be visualized by (i) direct observation (Bright Field, left panel), (ii) dark field imaging using a light ring (middle panel) or (iii) auto-fluorescence under a standard UV transilluminator with an orange filter (right panel). As an example, the same three empty drops have been enclosed by a rectangle in each panel. In this example, 19 drops out of 144 ones are not filled, leading to $P_0 = 0.13$ and $\lambda = 2.40$. Drops volumes are $V = 10.5\mu\text{L}$, leading to $C = 228.5\text{Bact}/\text{mL}$.

B. The P_0 method principle and realization.

Depositing isolated drops directly on the solid surface allows one to circumvent most of these time consuming processes. In this novel approach to CFU counting, we deposit the drops of precisely controlled volume containing the nutrient medium directly on the solid surface of the Petri dish. As the drops fall on a solid surface, their contact angle is large and they remain isolated from one another (figure 4.a). After the appropriate incubation period, drops that initially contained more than zero microorganism will be filled with a high concentration of bacteria and change their visual aspect, while drops that contained no microorganisms will remain the same and do not change their aspect (figure 4.b). Figure 4.c shows an actual implementation of this procedure.

The P_0 method consists in counting the relative num-

ber P_0 of *unfilled* drops after incubation. From this quantity, we compute the concentration of organisms in the liquid. The method is akin to transforming the “*analog*” method of spread counting into a “*digital*” method of counting zeros and ones on a regular grid. The method is similar in its spirit to the “Most Probable Number” method first developed by McCrady in 1915[8–10]. A somehow similar P_0 method is also used in fluctuation assays to estimate the mutation rate[11].

The mathematical principle of this method is as follows. Consider N isolated drops of a liquid containing microorganisms at concentration C (Number/mL) on a solid substrate. Each drop has a volume V . Defining $\lambda = CV$ as the *mean* number of organisms per drop, the *probability* P_n that a drop initially contains n organisms

is Poisson distributed[12]:

$$P_n = e^{-\lambda} \frac{\lambda^n}{n!} \quad (1)$$

The probability that a drop contains *no organism* is therefore

$$P_0 = e^{-\lambda}. \quad (2)$$

The P_0 method consists in counting the number of drops N_0 that after incubation have stayed empty and determine

$$P_0 = \frac{N_0}{N} \quad (3)$$

Relation (2) is then used to estimate directly the parameter

$$\lambda = -\ln(P_0) \quad (4)$$

which, in turn, leads to the value of the concentration of the microorganism in the drops:

$$C = \lambda/V \quad (5)$$

The method does not necessitate prior preparation of gelled substrate ; the total amount of liquid deposited on the surface is of the order of 1mL ; after the incubation and counting period, the Petri dishes can be easily washed for future use, circumventing waste management ; as the drops are deposited on a regular grid (figure 4.c) and only the filled/unfilled (1/0) information is used, the counting is fast and can be readily automated. The Petri dishes are treated once beforehand with an alkaline soap in order to immobilize the drops on the surface (see V E).

Determining the drops that remain empty after incubation can be achieved by different measurements. One can directly observe the drops that are “filled” and develop a milky halo or spots inside (figure 4, left panel). On the other hand, most bacteria produce fluorescent byproducts[13, 14] that usually are a nuisance to investigators. Here, this background signal can be put to use to observe drops in which growth has occurred under a standard laboratory transilluminator (figure 4 right panel). A third method of visualizing empty drops is to use dark field imaging, using a light ring to illuminate the Petri dishes (figure 4 middle panel) (see section V D for details).

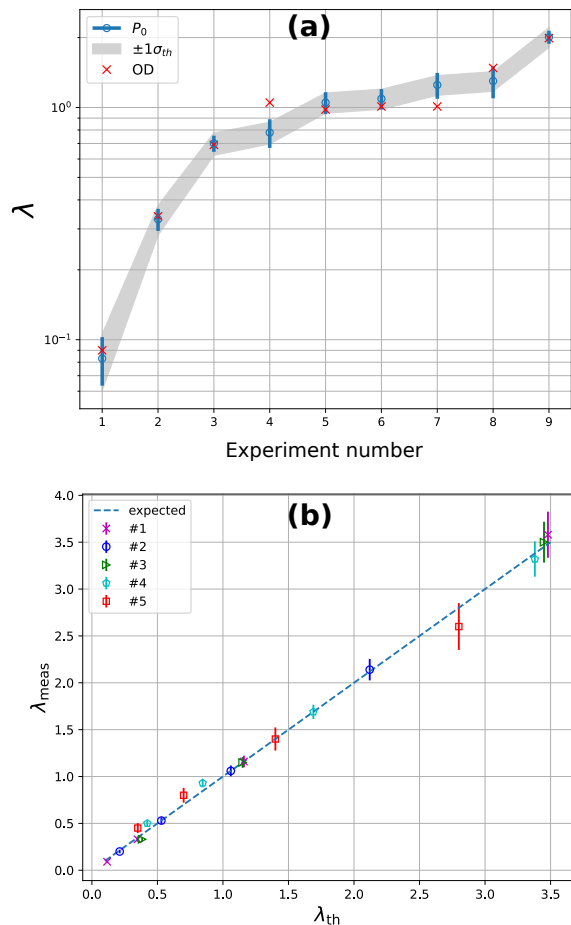

Figure 5. (a) Precision of the P_0 method in 9 different experiment. Each experiment consists of 6-15 Petri dishes cultured under the same conditions. λ is the average number of bacteria per drop present at the time of deposition. Blue circle (\circ): average λ computed over the M Petri dishes of each experiment (expression 4), while the error bar is their measured standard deviation. The gray area shows the $\bar{\lambda} \pm \delta\lambda_{th}$ region where the theoretical standard deviation $\delta\lambda_{th}$ is given by expression (6). The red crosses (\times) indicate the expected λ based on OD measurements, where for clarity, the error bar of OD measurements are omitted.

(b) Five different set of linearity measurements. In each measurement, 4 different dilutions of the same solution of bacteria are prepared and each dilution is P_0 -cultured on $M = 4$ substrates. One of the dilution in the series (usually one with λ close to 1) is used as the reference λ and the *expected* λ_{th} in the other solutions of the series are computed from the dilution ratio. On the other hand, the actual λ_{meas} from the M Petri dishes of each dilution are measured. The above figure shows λ_{meas} as a function of λ_{th} . Error bars are the theoretical standard deviations given by expression (6).

Finally, after the incubation period, Petri dishes can be allowed to dry. Upon drying, filled drops leave very characteristic traces that can be readily identified. The dried Petri dishes can be stored for long periods (>1 month) and living bacteria can be retrieved from them if needed. All these methods, within $< 1\%$, lead to the same deter-

mination of P_0 .

C. Precision, reproducibility and linearity of P_0 method.

As for the CFU and autoplate method, the reproducibility of P_0 method is limited by statistical dispersion. The expression of the uncertainty is however slightly different. If λ is the true number of bacteria per drop, and if N drops have been deposited on the Petri dish, the theoretical uncertainty $\delta\lambda$ of the *measured* λ is (see V F)

$$\delta\lambda = \sqrt{\frac{e^\lambda - 1}{N}} \quad (6)$$

For example, for $\lambda = 1$ and $N = 169$, the relative error in the estimation of λ is 10%.

Figure 5.a shows the actual results of the P_0 method. Nine different experiments with solutions at various concentration of bacteria, determined by OD measurements, have been performed and their λ measured by the P_0 method. As it can be seen, the measured λ and its uncertainty are in agreement with the expected value deduced from the OD and with the theoretical expression (6).

The P_0 method also shows excellent linearity over a dynamic range of 30, as it can be observed in figure 5.b.

IV. DISCUSSION AND CONCLUSION.

We have presented here a versatile apparatus, Platorix, that can automatize the CFU procedure for plating and counting of microorganisms. The robot is simple and cheap to build from commercially available components and can be based, for example, on a 3D printer frame.

The apparatus can be operated in two modes, the autoplate and the P_0 methods, described in detail in the previous sections. The Platorix robot could further be extended to perform serial dilution automatically (see section V H). When used in P_0 mode, dilutions of up to a factor 4 can be achieved directly by depositing n (≤ 4) drops at the same position.

The P_0 method has many advantages compared to spreading on agar gel, circumventing, for example, the need for gel preparation and waste management. Moreover, the P_0 method can measure bacterial concentration as low as 1B/mL, eliminating the need for bacterial concentration and recovery system at these concentrations. Even though apparatuses for efficient bacterial concentration are available[15], their use is still time and resources consuming.

We believe that the new procedure we have developed will find applications in all area of microbiology where the spread plating method is used.

Patent. An application (number WO2022207514) on a “method for counting the number of living microorganisms contained in a specimen sample and apparatuses for implementing such methods” has been filed.

Acknowledgment. We are grateful to Th. Clavier, H. Geiselmann, I. Mihalcescu and N. Scaramozzino for fruitful discussions.

V. MATERIAL AND METHODS.

A. Instrumental realization.

The Platorix robot that implements the autoplate and P_0 method is schematically represented in figure 6. The principle is to use two motor X and Y to move in synchrony the syringe relative to the Petri dish and scan the substrate line after line, while the syringe, driven by a third motor, delivers a precise quantity of the liquid it contains. We use 5 mL glass syringes from Hamilton®company that can be easily cleaned and autoclaved and have good mechanical properties to deliver precise quantity of liquids.

At the smaller speed needed for operation in P_0 mode (1-2 drops per second), drops form at the tip of the needle and detach by gravity, with a precise volume dependent on the needle’s gauge(table I). In this mode, a small and removable photo-detector positioned at the tip of the needle detects detachment of the drops and the controller then moves the needle to the next programmed position. The number of drops delivered to the same position can be used to perform dilution experiment directly on the substrate.

The apparatus could be programmed to move the syringe to the side of the translation stage where vessels containing various solutions are positioned and automatically clean/rinse/load the syringe or perform large automatic dilution.

B. Strain, growth medium, OD calibration

The strain used in this study was E. coli B strain REL606 (NCBI:txid413997) provided by D. Schneider. The culture medium used in our experiments is the standard M9 minimal medium[16]. Calibration experiments were performed by manual plating and we use throughout this paper $1\text{OD}=6.1 \times 10^8\text{B/mL}$ [17]. All measurements are performed on bacteria in exponential growth, with OD in the range of [0.2-0.8].

C. Drop detachment.

When operating the Platorix in P_0 mode, it is crucial to have precise control of the volume of the drops. The apparatus uses standards needles and when the piston of the syringe advances at slow speed (depending on

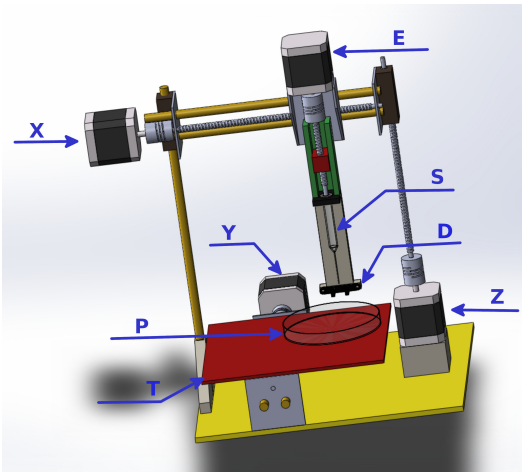

Figure 6. The Platorix robot. The X and Y stepping motors position the syringe (S) and the translation stage (T) relative to each other. A third motor (Z) can adjust the height of the syringe. The motor (E) drives the syringe piston and deliver the liquid inside the syringe to the substrate (P). A small, removable photo-detector (D) (OPB815WZ, Optek technologies) is positioned at the tip of the needle and detects, if needed, drops detachment. All motors and the detector are driven by an ARDUINO electronic board, using a home made C-program.

g	18	22	26	30
$V_d(\mu\text{L})$	19.1	10.5	6.7	3.9

Table I. Calibration of drop size V_d as a function of needle gauge g

the needle gauge, typically $10\mu\text{L/s}$ for gauge 22 needles) drops form individually at the tip of the needle and, upon reaching a critical volume V_c , they detach by gravity and fall on the substrate below the syringe.

The volume V_c depends only on the size of the needle and its relative variation is smaller than 2%. Table I shows the volume V_c for various needles gauge.

D. Drops visualization for the P_0 method.

After incubation for a certain time (typically 24h, same as for the agar plate method), drops have to be inspected to determine the number of empty/filled ones. The simplest way is to inspect the Petri dishes under normal illumination, similar to the agar plate method (fig.4, left panel), or to place the Petri dishes on a white color transilluminator. In order to increase the contrast, contrasting agents, such as TTC[18] can be used.

High contrast can be obtained by dark field imaging (fig. 4, middle) : the Petri Dish is illuminated sideways by a light ring and viewed from above in a dark room. The method is akin to OD measurements: bacteria diffuse light due to the difference between their refractive

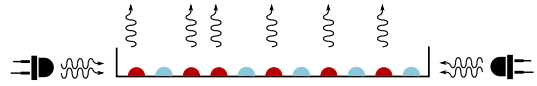

Figure 7. Principle of dark field imaging : A LED light ring illuminates the Petri Dish sideways. Drops that contain microbes (red) scatter the light and appear bright when seen from top. Drops that have no microbes (blue) do not scatter the light and remain dark.

index and that of the medium. A laboratory photometer measures the decrease in the intensity of transmitted light due to diffusion ($OD = \log(I_0/I)$), while dark field imaging directly measures the scattered light.

Many bacteria produce fluorescent molecules that are usually a nuisance[13] when detecting GFP-like proteins. This auto-fluorescence production however can be put to use for empty/filled drops, by fluorescence imaging of the Petri dishes after incubation (figure 4, right). We have used a standard blue ($\approx 480\text{nm}$) transilluminator (DarkReader®DR-195/Clare Chemical Research) equipped with an orange detection filter ($\approx 630\text{nm}$) in our experiments.

E. Petri dish preparation for P_0 method

When operating in the P_0 mode, it is crucial for the drop to be stable and not slide during Petri Dish manipulation. Standard plastic Petri Dishes are prepared to have a smooth, slippery surface. We treat their surfaces by an alkaline detergent (Hellmanex ®III from Hellma, 2% solution at 37C for 30 minutes and rinsing with deionized water). This treatment stabilizes the deposited drops (fig 4.a) and Petri dishes can be manipulated without particular care. This treatment is necessary only once. After an experiment, the Petri Dishes are washed with normal soap, UV sterilized and reused for the next experiment. We use each Petri dish more than 20 times. The Petri Dishes we use are not air tight ; to avoid drying of the drops during incubation, a small reservoir of water (1mL) is deposited in each Petri during incubation.

F. Error analysis.

A crucial question when counting bacteria is the reliability and reproducibility of the estimate. For spreading on agar and colony counting, the statistical error is straightforward : when counting n colonies, the relative error is $1/\sqrt{n}$. When a liquid of volume V (typically $100\mu\text{L}$) containing organisms at concentration C is spread on a surface, the mean number of bacteria in this volume is $\lambda = CV$. The *actual* number of organisms is however Poisson distributed with mean and variance λ . Therefore, if n colonies are counted, the standard deviation $\sigma \approx \sqrt{n}$ and the relative uncertainty is $R = \sigma/n = 1/\sqrt{n}$. When counting 100 colonies, this

statistical uncertainty is $\approx 10\%$ and increases to $\approx 20\%$ for 30 colonies. Below this limit, counting becomes unreliable. Here, we neglect other sources of error such as “collision” between colonies and competition for resources where the number of colonies is large.

The error estimate for the P_0 method is different, as we are not counting colonies but unfilled drops. In this “digital” method, the collisions between colonies and competition for resources has no importance because there is no microbe in unfilled drops. The statistical error of determining the concentration of bacteria when depositing N drops, of which N_0 are empty, can be evaluated as follow.

Consider the Bernoulli random variable X that a drop is empty/not empty with probabilities $p = e^{-\lambda}$ and $1-p$, where $\lambda = CV_d$ and V_d is the drop volume (typically $10\mu L$). When performing N independent measurements (number of drops deposited on the Petri’s surface), p can be estimated by

$$p_e = \frac{N_0}{N}$$

where N_0 is the number of empty drops, with the uncertainty

$$\delta p_e = \sqrt{p_e(1-p_e)/N}$$

As the number of drops is large, we use N instead of $N-1$ for the unbiased estimator

From this estimation, we can determine $\lambda_e = -\ln p_e$ and its absolute error :

$$\delta \lambda_e = -\frac{\delta p_e}{p_e} \quad (7)$$

$$= \sqrt{\frac{1-p_e}{N p_e}} = \sqrt{\frac{e^\lambda - 1}{N}} \quad (8)$$

Figure 8 shows the relative theoretical uncertainty in the estimation of λ as a function of the relative number of unfilled drops. As can be seen, the uncertainty is higher when the majority of the drops are empty. In particular, to obtain an uncertainty below 50%, one has to observe at least five filled drops ($p = (N-5)/N$), whatever the number of deposited drops. On the other hand, when depositing for example 200 drops, observing only 1 empty drop gives the value of $\lambda = 5.3$ with 20% uncertainty.

We note that with the P_0 method, we can measure concentration as low as $C = 1\text{B}/\text{mL} : 5\text{mL}$ of the media contains in average 5 bacteria and therefore their observation leads to the determination of the concentration with a relative error of 50%. On the other hand, This volume of sample corresponds to 500 drops with typical drop volume of $V_d = 10\mu L$ that can be deposited on two Petri dishes in about 5 minutes. The risk of not observing any filled drop is $\exp(-5) = 6.7 \times 10^{-3}$. Using a

sample volume of 10mL increases the accuracy to 30% and it would take only 10 min to perform the drop deposition and would eliminate the danger of not observing any filled drop ($\exp(-5) = 4.5 \times 10^{-5}$).

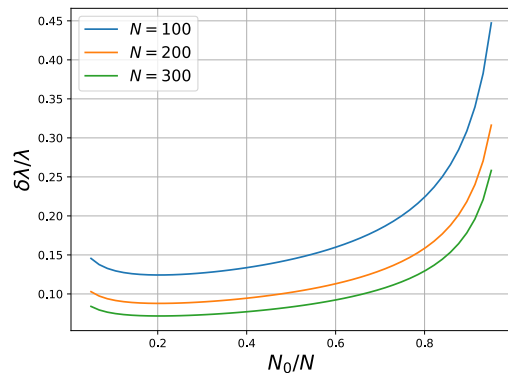

Figure 8. Relative error in the estimation of λ as a function of unfilled drops given by the expression (8), for three different total number of drops.

G. Measuring the quality of spread.

The quality of spreading can be evaluated by the “Coefficient of Variation” method that is used in ecology to measure aggregation : the area of the Petri dish is divided into M squares, numbers n_i of colonies in each square are counted and the average μ and variance Vr of these numbers are computed. A perfect spread corresponds to $C_V = Vr/\mu \approx 1$, while for a sub-optimal spreading, $C_V > 1$. For figure 1.b, corresponding to manual plating, $C_V = 3.8$, while for figure 2.b corresponding to autoplating method, $C_V = 1.1$.

H. Automatic dilution

Further development of the Platorix instrument can be envisaged to perform serial dilutions. Various vessels can be positioned on the side of the motorized stage, and the syringe can move from one vessel to another, load and unload in order to perform the desired dilutions.

Beginning with an initial volume V and depositing a volume v_0 for plating M Petri dishes, a volume v_1 is flushed out of the syringe into a waste collecting vessel and a volume $v_0 + v_1$ is pumped into the syringe from a vial containing a sterile solution by reversing the direction of the motorized piston. The dilution factor ($C_{\text{final}}/C_{\text{initial}}$) is then

$$d = 1 - \frac{v_0 + v_1}{V},$$

and the apparatus is ready to perform a new round of automatic plating.

-
- [1] R. Koch. Zur untersuchung von pathogenen organismen. Robert Koch-Institut, 2010.
- [2] R.J. Petri. Eine kleine Modification des Koch'schen Plattenverfahrens. *Centralblatt für Bakteriologie und Parasitenkunde*, 1:279–80, 1887.
- [3] E. Goldman and L. H. Green. *Practical Handbook of Microbiology*. CRC Press, 2008.
- [4] E. R. Sanders. Aseptic laboratory techniques: Plating methods. *Journal of Visualized Experiments: JoVE*, (63):e3064, 2012.
- [5] R.S. Breed and W. D. Dotterrer. The Number of Colonies Allowable on Satisfactory Agar Plates. *Journal of Bacteriology*, 1(3):321–331, 1916.
- [6] P. Thomas, A. C. Sekhar, and M. M. Mujawar. Non-recovery of varying proportions of viable bacteria during spread plating governed by the extent of spreader usage and proposal for an alternate spotting-spreading approach to maximize the CFU. *Journal of Applied Microbiology*, 113(2):339–350, 2012.
- [7] J. E. Gilchrist, J. E. Campbell, C. B. Donnelly, J. T. Peeler, and J. M. Delaney. Spiral Plate Method for Bacterial Determination. *Applied Microbiology*, 25(2):244–252, 1973.
- [8] M. H. McCrady. The Numerical Interpretation of Fermentation-Tube Results. *The Journal of Infectious Diseases*, 17(1):183–212, 1915.
- [9] R. Rowe, R. Todd, and J. Waide. Microtechnique for Most-Probable-Number Analysis. *Applied and Environmental Microbiology*, 33(3):675–680, 1977.
- [10] Md Latiful Bari and Sabina Yeasmin. Microbes Culture Methods. In Nima Rezaei, editor, *Encyclopedia of Infection and Immunity*, pages 77–98. Elsevier, Oxford, January 2022.
- [11] J. A. Koziol. A note on efficient estimation of mutation rates using Luria-Delbrück fluctuation analysis. *Mutation Research/Fundamental and Molecular Mechanisms of Mutagenesis*, 249(1):275–280, 1991.
- [12] W. Feller. *An Introduction to Probability Theory and Its Applications, Vol. 1*. Wiley, S.I., 3rd edition, 1968.
- [13] N. Billinton and A. W. Knight. Seeing the Wood through the Trees: A Review of Techniques for Distinguishing Green Fluorescent Protein from Endogenous Autofluorescence. *Analytical Biochemistry*, 291(2):175–197, 2001.
- [14] I. Mihalcescu, M. Van-Melle Gateau, B. Chelli, C. Pinel, and J.-L. Ravanat. Green autofluorescence, a double edged monitoring tool for bacterial growth and activity in micro-plates. *Physical Biology*, 12(6):066016, 2015.
- [15] Y. Zhang, Ch.-q. Xu, T. Guo, and L. Hong. An automated bacterial concentration and recovery system for pre-enrichment required in rapid Escherichia coli detection. *Scientific Reports*, 8(1):17808, 2018.
- [16] M9 minimal medium (standard). *Cold Spring Harbor Protocols*, 2010(8):pdb.rec12295, 2010.
- [17] B. Volkmer and M. Heinemann. Condition-Dependent Cell Volume and Concentration of Escherichia coli to Facilitate Data Conversion for Systems Biology Modeling. *PLOS ONE*, 6(7):e23126, 2011.
- [18] R. P. Tengerdy, J. G. Nagy, and B. Martin. Quantitative measurement of bacterial growth by the reduction of tetrazolium salts. *Applied Microbiology*, 15(4):954–955, 1967.