



HAL
open science

LARS2 variants can present as premature ovarian insufficiency in the absence of overt hearing loss

Anne-Sophie Neyroud, Joëlle Rudinger-Thirion, Magali Frugier, Lisa G Riley, Maud Bidet, Linda Akloul, Andrea Simpson, David Gilot, John Christodoulou, Célia Ravel, et al.

► To cite this version:

Anne-Sophie Neyroud, Joëlle Rudinger-Thirion, Magali Frugier, Lisa G Riley, Maud Bidet, et al.. LARS2 variants can present as premature ovarian insufficiency in the absence of overt hearing loss. European Journal of Human Genetics, 2023, 31 (4), pp.453-460. 10.1038/s41431-022-01252-1 . hal-03888946

HAL Id: hal-03888946

<https://hal.science/hal-03888946v1>

Submitted on 16 Mar 2023

HAL is a multi-disciplinary open access archive for the deposit and dissemination of scientific research documents, whether they are published or not. The documents may come from teaching and research institutions in France or abroad, or from public or private research centers.

L'archive ouverte pluridisciplinaire **HAL**, est destinée au dépôt et à la diffusion de documents scientifiques de niveau recherche, publiés ou non, émanant des établissements d'enseignement et de recherche français ou étrangers, des laboratoires publics ou privés.

LARS2 variants can present as premature ovarian insufficiency in the absence of overt hearing loss.

Anne Sophie Neyroud^{1,2}, Joëlle Rudinger-Thirion³, Magali Frugier³, Lisa G. Riley^{4,5}, Maud Bidet⁶, Linda Akloul⁷, Andrea Simpson^{8,9}, David Gilot^{10,11}, John Christodoulou^{5,12,13}, Célia Ravel^{1,2}, Andrew H. Sinclair^{12,13}, Marc-Antoine Belaud-Rotureau^{1,2,8}, Elena J. Tucker^{12,13*} and Sylvie Jaillard^{2,10*}

¹ CHU Rennes, Service de Biologie de la Reproduction-CECOS, F-35033 Rennes, France

² Univ Rennes, CHU Rennes, INSERM, EHESP, IRSET (Institut de recherche en santé, environnement et travail) – UMR_S 1085, F-35000 Rennes, France

³ Université de Strasbourg, Architecture et Réactivité de l'ARN, CNRS, IBMC, Strasbourg, France

⁴ Rare Diseases Functional Genomics, Kids Research, The Children's Hospital at Westmead and The Children's Medical Research Institute, Sydney, Australia

⁵ Specialty of Child and Adolescent Health, Faculty of Medicine and Health, University of Sydney, Sydney, Australia

⁶ Clinique Mutualiste La Sagesse, service of AMP, 35000 Rennes, France

⁷ CHU Rennes, Service de Génétique Clinique, CLAD Ouest, F-35033 Rennes, France

⁸ School of Allied Health, College of Science, Health and Engineering, La Trobe University, Bundoora, Australia

⁹ College of Health and Human Services, Charles Darwin University, Darwin, Australia

¹⁰ CHU Rennes, Service de Cytogénétique et Biologie Cellulaire, F-35033 Rennes, France

¹¹ INSERM U1242, COSS, Université Rennes 1, F-35032, Rennes, France

¹² Murdoch Children's Research Institute, Royal Children's Hospital, Melbourne, VIC Australia

¹³ Department of Paediatrics, University of Melbourne, Melbourne, VIC Australia

* Equal senior authors of the study

Corresponding authors: Elena J Tucker, elena.tucker@mcri.edu.au; Sylvie Jaillard, sylvie.jaillard@chu-rennes.fr
Reproductive Development, MCRI
Royal Children's Hospital
Flemington Rd
Parkville, VIC, Australia, 3055

Short title: *LARS2* in premature ovarian insufficiency

Keywords: Perrault syndrome, *LARS2*, premature ovarian insufficiency, sensorineural hearing loss, genomics

Abstract

Premature ovarian insufficiency (POI) affects 1 in 100 women and is a leading cause of female infertility. There are over 80 genes in which variants can cause POI, with these explaining only a minority of cases. Whole exome sequencing (WES) can be a useful tool for POI patient management, allowing clinical care to be personalized to underlying cause. We performed WES to investigate two French sisters, whose only clinical complaint was POI. Surprisingly, they shared one known and one novel likely pathogenic variant in the Perrault syndrome gene, *LARS2*. Using amino-acylation studies, we established that the novel missense variant significantly impairs *LARS2* function. Perrault syndrome is characterized by sensorineural hearing loss in addition to POI. This molecular diagnosis alerted the sisters to the significance of their difficulty in following conversation. Subsequent audiology assessment revealed a mild bilateral hearing loss. We describe the first cases presenting with perceived isolated POI and causative variants in a Perrault syndrome gene. Our study expands the phenotypic spectrum associated with *LARS2* variants and highlights the clinical benefit of having a genetic diagnosis, with prediction of potential co-morbidity and prompt and appropriate medical care, in this case by an audiologist for early detection of hearing loss.

Introduction

Premature ovarian insufficiency (POI) is characterized by amenorrhea (primary or secondary) and elevated follicle stimulating hormone (FSH) before the age of 40. It affects up to 1 in 100 women by age 40, but is rare in younger women with 1 in 1000 under the age of 30 affected (1). POI can be secondary to medical interventions such as cancer therapy or surgery or can result from genetic variation in one of at least 80 different genes^{1,2}. The known POI genes account for ~25% of cases². Although it seems logical that a genetic diagnosis is more likely in

the younger age-of-onset group of POI, this has not been yet demonstrated. Genetic diagnosis of POI patients, although not part of routine clinical care in most parts of the world, has demonstrated utility in improving patient management ³. In France for example, a national network has been implemented to develop such genetic assessment through massive parallel sequencing (Plan France Médecine Génomique 2025 <https://pfm2025.aviesan.fr>).

POI is not always an isolated condition but can present as a feature of several clinical syndromes, such as galactosemia, BPES syndrome, ovarioleukodystrophy¹. Perrault syndrome (OMIM #233400) is one syndromic form of POI, being a rare autosomal recessive disorder characterized by sensorineural hearing loss in both males and females and POI in affected females. Some patients also have neurologic manifestations, including intellectual disability and cerebellar and peripheral nervous system involvement. It is difficult to comment on the prevalence of neurological symptoms as they can evolve in adult life and may not be evident before initial publication stating a diagnosis of Perrault syndrome. The first 15 patients from eight different families were reported to have Perrault syndrome Type 1 (no neurological involvement), but at least seven patients have since been published with Perrault syndrome Type 2 ⁴⁻⁶. Interestingly, even within a single family there can be variability with respect to neurological involvement, with some individuals having Perrault syndrome Type 1 and relatives having ovarioleukodystrophy ⁵.

The association of gonadal dysgenesis and deafness was first reported in 1951, defining Perrault syndrome ⁷. It is now known that Perrault syndrome has a broad genetic heterogeneity ⁸: the identified causative genes include *CLPP* (OMIM *601119) required for the unfolded protein response and for mitochondrial ribosome biogenesis ⁹, *ERAL1* involved in mitochondrial rRNA chaperoning ¹⁰, *PRORP* involved in mitochondrial tRNA processing ¹¹, *RMND1* (OMIM *614917) involved in mitochondrial translation ¹², *HARS2* (OMIM *600783) ¹³

and *LARS2* (OMIM *604544)¹⁴ responsible for charging mitochondrial tRNAs with histidine and leucine, respectively, *HSD17B4* (OMIM *601860) involved in fatty-acid oxidation and steroid metabolism¹⁵, *PEX6* involved in peroxisomal biogenesis⁸, *GGPS1* required for C20-prenylation¹⁶ and *TFAM* and *TWNK* (OMIM *606075) required for mtDNA replication and maintenance^{8,17,18}. In approximately 60% of patients with Perrault syndrome, a molecular diagnosis cannot be made¹⁹.

In this study, two pathogenic variants of *LARS2* were identified in two young women, from the same French (Caucasian) family, presenting with POI but without known hearing deficit at the time of ovarian assessment. The *LARS2* gene encodes mitochondrial leucyl-tRNA synthetase (*LARS2*), which belongs to the aminoacyl-tRNA synthetase (aaRS) family. AaRSs catalyze the esterification of amino acids on the 3' end of their cognate transfer RNAs (tRNAs) and are essential for efficient translation of mRNAs into proteins²⁰. Via amino-acylation assays, we established that the novel variant shared by these sisters has a significant impact on *LARS2* function. The degree of *LARS2* dysfunction cannot explain their relatively mild phenotype. These two cases and a review of the literature are used to explore the correlation between the phenotype and the *LARS2* genotype.

Material and methods

Editorial Policies and Ethical Considerations

Written informed consent was obtained from the patients. All procedures were in accordance with the ethical standards of the Ethics Committee of Rennes University Hospital and the French law.

Patients

The proband (III1) (Figure 1A) experienced spontaneous puberty with her first menstruation at the age of 14 years. At the age of 20, she experienced secondary amenorrhea, and a hormonal evaluation was performed showing FSH: 64 IU/L (N: 3-9 IU/L), LH: 23 IU/L (N: 2-10 IU/L), estradiol <10 pg/mL (N: 27-161 pg/mL). Imaging via pelvic ultrasound and MRI showed a right ovary to be a fibrous band and two follicles in the left ovary. A second assessment was performed three months later and showed FSH: 64 IU/L (N: 3-9 IU/L), LH: 17 IU/L (N: 2-10 IU/L), estradiol <10 pg/mL (N: 27-161 pg/mL), and AMH: 0.01 ng/mL (N: 0.7-3.5 ng/mL). Anti-21-hydroxylase and anti-thyroid antibodies were not detected.

The diagnosis of POI in the proband prompted evaluation of ovarian function in her younger sister (III2) (Figure 1A), who had experienced spontaneous menarche at age 13 and had continued regular menses with hormonal assessment performed at age 16. Hormonal assessment revealed elevated FSH (80 IU/L) and LH (37 IU/L) along with low estradiol (<10 pg/mL) and AMH (<0.01 ng/mL). This hormone profile was confirmed 6 months later with FSH: 64 IU/L and estradiol <10 pg/mL. Anti-21-hydroxylase and anti-thyroid antibodies were not detected. Imaging showed streak ovaries. A marfanoid morphotype was noted.

For both patients, karyotypes and microarray analysis were normal. No premutation of the *FMR1* gene was found.

Their parents (II1 and II2) were not related. Other more distant relatives reported infertility, including a maternal aunt of the mother as well as one of the daughters of this aunt and the son of a maternal uncle of the mother (Figure 1A). Limited information is available on the nature of this familial infertility and DNA samples were not available for testing.

Whole-exome sequencing (WES)

DNA from patients and their parents were available allowing a quartet/quattro analysis.

Exome capture was performed using the SureSelect Human All Exon V7 kit (Agilent Technologies Inc, Santa Clara, CA, USA) and sequenced on a NextSeq500 instrument (Illumina, San Diego, CA, USA). WES data were processed using C-GeVarA pipeline (Constitutional Genetic Variant Analysis, Bioinformatics Department, Rennes University Hospital) and deposited into SeqR for analysis (<https://seqr.broadinstitute.org/>).

We performed two phases of analysis – the first focused on gene priority and the second focused on variant priority, as previously described ²¹. Recessive mode of inheritance was prioritized (homozygous variants or compound heterozygous). Given there are extended family members with infertility, autosomal dominant inheritance was also explored. Allele frequency and tolerance of genes to missense and/or loss-of-function (LoF) variation were assessed in the public database, gnomAD (<https://gnomad.broadinstitute.org/>). Variant pathogenicity was predicted *in silico* using VarSome (<https://varsome.com>) which gives an overall view on prediction scores including Mutation Taster, Polyphen-2, SIFT, PROVEAN, REVEL, and CADD for example. The conservation of affected residues was assessed by Multiz Alignments of 100 vertebrates (UCSC Genome Browser <https://genome.ucsc.edu/>). The novel *LARS2* variant has been submitted to ClinVar (SCV002099518 and SCV002099519). Variants were confirmed by targeted sequencing with the Sanger method and are described according to the hg19/GrCH37 version of the genome.

Functional studies

Recombinant *LARS2* proteins were produced to assess amino-acylation efficiency of the identified variant. Wild-type and variant *LARS2* proteins were expressed and purified as previously described ^{5,22} in the presence of protease inhibitor cocktail (cOmplete™ tablets EDTA-free, Roche, Merck KGaA, Darmstadt, Germany). In addition to the *LARS2* c.1670A>C, p.(Tyr557Cys) patient variant, a c.351G>C, p.(Met117Ile) variant was produced and assayed as

it was the only variant that has also been reported in compound heterozygosity with the p.(Thr522Asn) variant which has not been functionally evaluated²³. *E. coli* tRNA^{Leu} transcript was prepared according to Perret *et al.*²⁴. *In vitro* leucylation of *E. coli* tRNA^{Leu} transcript was performed according to Sohm *et al.*²⁵ in the presence of 20 μM L-[¹⁴C]leucine at 37°C. Apparent kinetic parameters were determined from Lineweaver-Burk plots with 10 nM of enzyme (LARS2 WT, LARS2 Met117Leu or LARS2 Tyr557Cys) and 0.2 to 12 μM tRNA^{Leu} transcript. Data were expressed as averages of at least three independent experiments. A t-test was performed to compare k_{cat}/K_m ratio of Wt and variant LARS2.

Results

WES identified compound heterozygous missense variants in the LARS2 gene

Variant filtration in the proband and her sister revealed two stand-out candidate variants in the *LARS2* gene. No other candidate variant was identified. The first variant (NM_015340.3:c.1565C>A) was inherited from the mother (rs199589947) (Figure 1B). This variant leads to the substitution of a threonine to asparagine (NP_056155.1:p.(Thr522Asn)) in the catalytic domain of the protein (Figure 1C) and affects an amino acid that is highly conserved between mammals, birds, reptiles and fishes (Figure 1D). This variant has previously been associated with Perrault syndrome in a homozygous or compound heterozygous state and functional analyses have proven its deleterious effect on the activity of the protein^{14,23}. It is also reported in ClinVar as pathogenic/likely pathogenic. It was classified as a pathogenic variant (class 5) according to the American College of Medical Genetics and Genomics (ACMG)²⁶ (Supplementary Table S1).

The second variant (NM_015340.3:c.1670A>G) was inherited from the father (rs1269970737) (Figure 1B). It leads to the substitution of a tyrosine with a cysteine (NP_056155.1:p.(Tyr557Cys)) in the catalytic domain of the protein (Figure 1C). It is a very rare variant with a MAF<0.00001 in gnomAD and not referenced in ClinVar. At the protein level, the variant lies within a highly conserved region, close to the active site (Figure 1C), and is thus probably damaging, which is in accordance with the *in silico* predictions (almost all pathogenic/disease causing/deleterious). It was classified as a likely pathogenic variant (class 4) according to ACMG ²⁶ (Supplementary Table S1).

These two variants are compound heterozygous, consistent with an autosomal recessive mode of inheritance, likely explaining the POI phenotype. Following the molecular diagnosis, the proband and her sister reported some difficulties in hearing conversation, which had not been perceived as significant. The absence of obvious hearing loss at initial clinical assessment expands the phenotypic spectrum of patients with variants in this gene, to include isolated POI, although mild hearing loss may be missed, and progressive hearing loss may occur.

The pathogenic LARS2 variants were associated with mild hearing loss

The proband did not report any hearing difficulties during the initial genetic consultation. Once the molecular diagnosis was disclosed, however, she reported mild difficulties following conversation and when watching television. Prior to genetic diagnosis, these difficulties were not perceived as significant by the patient and did not prompt her to seek medical investigation. Subsequent audiological assessment showed a mild bilateral hearing loss at 250-500 Hz and normal hearing thresholds from 1000-8000 Hz (Figure 2). Tympanometry was normal (Type A) bilaterally.

Her sister similarly retrospectively reported some mild difficulties in hearing (requiring people to repeat themselves during conversation) that had not been of personal concern. Subsequent

audiological assessment revealed a mild mixed bilateral hearing loss in the low frequencies at 125-1000 Hz. Hearing thresholds were found to be within the normal range bilaterally from 1000–8000 Hz. Tympanometry results were within normal limits for the left ear (Type A). A Type C tympanogram was found for the right ear, supportive of a middle ear component to the hearing loss. Speech audiometry was consistent with a mild hearing loss with greater amplification required to reach 100% correct speech understanding. Review of audiological history identified a similar level of hearing loss detected at 9 years of age after recommendation for assessment by the school nurse, however this had not been recalled by the patient and regular follow-up had not been pursued. Had genetic analysis been performed at the time, an early diagnosis of Perrault syndrome could have been achieved and the patient would have been monitored for decline in hearing as well as ovarian function.

The novel p.(Tyr557Cys) LARS2 variant is associated with a reduction in LARS2 function

The effect of the LARS2 p.(Tyr557Cys) variant on leucylation was investigated by generating a recombinant mutant enzyme and measuring its ability to attach radiolabeled leucine to an *E. coli* tRNA^{Leu} transcript *in vitro*, as we have performed previously⁵. The LARS2 p.(Tyr557Cys) variant had a 12.5-fold loss in catalytic efficiency compared to WT LARS2, mainly due to a decreased k_{cat} value (Table 1). This *in-vitro* evidence of a deleterious impact of the variant escalated the variant from a “likely pathogenic” annotation to a “pathogenic” annotation (Supplementary Table S1) and is in keeping with the 9-fold loss in aminoacylation efficiency previously determined for the LARS2 p.(Thr522Asn) variant²⁷.

These two amino acids, Thr 522 and Tyr557 are both highly conserved, even in bacterial leucyl-tRNA synthetase alignments (Figure 1D) and located in the active site, in spatial proximity to the leucyl-AMP binding pocket (Figure 1C).

The *LARS2* p.(Met117Ile) variant was previously reported in compound heterozygosity with p.(Thr522Asn) in a family with Perrault syndrome characterized by severe hearing loss²³. In contrast to Thr522 and Tyr557, the Met117 is located away from the active site (Figure 1C), and as expected p.(Met117Ile) variant had only a marginal effect on amino-acylation efficiency in our conditions (Table 1).

Discussion

Our study describes the identification of one known and one novel *LARS2* variant in association with apparently isolated POI. To date, 24 pathogenic or likely pathogenic single nucleotide variants (SNVs) or small insertions or deletions (indels) have been identified in association with *LARS2* - Perrault syndrome (<https://www.ncbi.nlm.nih.gov/clinvar/>, <https://databases.lovd.nl/shared/genes/LARS2>, <http://www.hgmd.cf.ac.uk/ac/index.php>) and no *LARS2* variants have been associated with isolated POI (Figure 3). A homozygous 4 kb gene deletion has also been recently reported in a patient with hearing loss²⁸. While *LARS2* variants were first identified in patients with Perrault syndrome, the phenotypic spectrum now extends from Perrault syndrome presenting initially as apparently isolated POI to more severe phenotypes (Perrault syndrome with neurological symptoms; hydrops, lactic acidosis, and sideroblastic anemia).

The *LARS2* protein is responsible for loading leucine onto its cognate tRNA^{Leu} within mitochondria to enable mitochondrial protein synthesis. The human mitochondrial genome is limited in size and contains genes encoding only 22 tRNAs, two rRNAs and 13 polypeptides, the latter of which are all subunits of the mitochondrial respiratory chain complexes. Mitochondrial translation is therefore necessary for efficient energy generation. Dysfunctional *LARS2* can impair mitochondrial protein synthesis leading to energy deficit and increased

reactive oxygen species, which can in turn damage oocytes and cause other manifestations of mitochondrial disease. Impaired mitochondrial function has been demonstrated in yeast models harboring LARS2 variants ¹⁴. Impaired mitochondrial translation in mice has been shown to cause hearing loss due to tissue-specific apoptosis ²⁹. Similarly, variants in LARS2 and other genes that disrupt mitochondrial translation, lead to failed ovarian development/function ^{10,12,30}. Clearly, loss of LARS2 function leading to energy deficit and increased reactive oxygen species has the potential to disrupt both ovarian function and hearing. The mechanism by which variants present first as an isolated POI are less clear. Hearing loss can be influenced by environment as well as genetics eg. drug exposure, loud noise exposure, low birth weight. It is possible that the sisters were fortunate to avoid significant environmental insult, protecting their hearing until a later age. The ovaries have a particularly high energy demand, and it remains possible that the level of LARS2 activity is enough to support hearing but not enough for protecting development and integrity of the oocyte pool. Although we measured the level of LARS2 activity *in vitro*, mitochondrial deficiency is known to have high variability and tissue specificity. It could be that LARS2 function and subsequent mitochondrial OXPHOS activity is more severely reduced in the ovaries of this patient.

Here we describe the first cases of variants in a known Perrault syndrome gene, *LARS2*, with POI as an isolated clinical concern on initial consultation. Unlike other *LARS2* cases, the molecular diagnosis for these patients was obtained during the assessment of what had been diagnosed as “isolated” POI instead of the assessment of hearing loss. *LARS2* patients show highly variable bilateral hearing loss, ranging from mild to profound, and sometimes progressive, particularly between the ages of 6 to 25 ³¹. The age of onset also varies from congenital to early adulthood in women ³². Of note, all individuals with the p.(Thr522Asn)

LARS2 variant had Perrault syndrome with sensorineural hearing loss at low frequencies ²³. Audiograms of *LARS2* patients have a distinct upward sloping shape ¹⁴. Such audiograms offer clues to a possible Perrault phenotype in affected girls. Conclusive diagnosis, however, can be achieved via genetic analysis.

The p.(Thr522Asn) *LARS2* variant has now been reported in 10 individuals from 5 families (Table 2). The severity of hearing loss varies across these families, and cannot solely be explained by the variant in trans as phenotypic variability is seen even between families homozygous for the p.(Thr522Asn) variant. We have functionally evaluated the *in vitro* aminoacylation efficiency of the p.(Thr522Asn) variant and variants found in trans with it (²⁷ and this study). The amino-acylation efficiency of the variants does not appear to correlate with disease severity (Table 2) indicating that there may be genetic and/or environmental modifiers of *LARS2*-associated disease. This has been observed in other mitochondrial aminoacyl-tRNA synthetase disorders ³³.

It remains unclear whether *LARS2* can be responsible for truly isolated POI, or whether all patients will experience some form of hearing loss. Audiology follow-up is essential to elucidate hearing ability over time in these individuals. Our patients do, however, demonstrate that *LARS2*-related Perrault syndrome can present as an isolated clinical concern, broadening the phenotypic spectrum associated with this gene. Our results highlight the potential for genetic diagnosis of POI patients to provide insight into future health risks, such as hearing loss. Audiological examination is not recommended for the routine care of all cases of apparently isolated POI ³⁴ as the vast majority have a truly isolated POI, but with genetic indication audiological examination is imperative. Early management of POI-related co-morbidities can improve long-term outcomes. Cascade testing can allow early detection of hearing loss in family members, including male relatives. Conversely, genetic diagnosis of pre-

pubertal girls with hearing loss can identify genetic Perrault syndrome. This allows prediction

Conclusion

Here we described a new presentation of LARS2-related disease of POI without perceived hearing loss. A new likely pathogenic variant of *LARS2* was identified in two affected women, and we demonstrated that it leads to relatively severe functional impairment of the variant protein *in vitro*. This novel variant has further expanded the existing genotypic spectrum of *LARS2* variants, and our results can aid in the molecular diagnosis and genetic counselling of patients with hearing loss and/or POI.

Our cases show that genomic testing is beneficial for the diagnosis of POI, particularly in young women. We demonstrate new considerations for genetic counselling of families carrying *LARS2* variants. Early genetic diagnosis allows prevention or early detection and improved management by pre-emptive screening for associated pathologies (such as hearing loss or neurological pathologies). Preservation of female fertility (ovarian stimulation followed by puncture and oocyte vitrification) can also be proposed to patients and their relatives if the parameters of the ovarian reserve allow it.

Data availability statement

The datasets generated and/or analysed during the current study are contained within the manuscript or available from the corresponding author on reasonable request and within ethical constraints. The *LARS2* variants have been submitted to ClinVar (<https://www.ncbi.nlm.nih.gov/clinvar/>, SCV002099518 and SCV002099519).

References

1. Tucker EJ, Grover SR, Bachelot A, Touraine P, Sinclair AH: Premature Ovarian Insufficiency: New Perspectives on Genetic Cause and Phenotypic Spectrum. *Endocr Rev* 2016; **37**: 609-635.
2. Qin Y, Jiao X, Simpson JL, Chen ZJ: Genetics of primary ovarian insufficiency: new developments and opportunities. *Hum Reprod Update* 2015; **21**: 787-808.
3. Tucker EJ, Grover SR, Robevska G, van den Bergen J, Hanna C, Sinclair AH: Identification of variants in pleiotropic genes causing "isolated" premature ovarian insufficiency: implications for medical practice. *Eur J Hum Genet* 2018; **26**: 1319-1328.
4. Kosaki R, Horikawa R, Fujii E, Kosaki K: Biallelic mutations in LARS2 can cause Perrault syndrome type 2 with neurologic symptoms. *Am J Med Genet A* 2018; **176**: 404-408.
5. Riley LG, Rudinger-Thirion J, Frugier M, Wilson M, Luig M, Alahakoon TI *et al*: The expanding LARS2 phenotypic spectrum: HLASA, Perrault syndrome with leukodystrophy, and mitochondrial myopathy. *Hum Mutat* 2020; **41**: 1425-1434.
6. van der Knaap MS, Bugiani M, Mendes MI, Riley LG, Smith DEC, Rudinger-Thirion J *et al*: Biallelic variants in LARS2 and KARS cause deafness and (ovario)leukodystrophy. *Neurology* 2019; **92**: e1225-e1237.
7. Perrault M, Klotz B, Housset E: [Two cases of Turner syndrome with deaf-mutism in two sisters]. *Bull Mem Soc Med Hop Paris* 1951; **67**: 79-84.
8. Tucker EJ, Rius R, Jaillard S, Bell K, Lamont PJ, Travessa A *et al*: Genomic sequencing highlights the diverse molecular causes of Perrault syndrome: a peroxisomal disorder (PEX6), metabolic disorders (CLPP, GGPS1), and mtDNA maintenance/translation disorders (LARS2, TFAM). *Human genetics* 2020.
9. Jenkinson EM, Rehman AU, Walsh T, Clayton-Smith J, Lee K, Morell RJ *et al*: Perrault syndrome is caused by recessive mutations in CLPP, encoding a mitochondrial ATP-dependent chambered protease. *Am J Hum Genet* 2013; **92**: 605-613.
10. Chatzisprou IA, Alders M, Guerrero-Castillo S, Zapata Perez R, Haagmans MA, Mouchiroud L *et al*: A homozygous missense mutation in ERAL1, encoding a mitochondrial rRNA chaperone, causes Perrault syndrome. *Hum Mol Genet* 2017; **26**: 2541-2550.
11. Hochberg I, Demain L, Urquhart J, Amberger A, Deutschmann A, Demetz S *et al*: A homozygous variant in mitochondrial RNase P subunit PRORP is associated with Perrault syndrome characterized by hearing loss and primary ovarian insufficiency. *bioRxiv* 2017.
12. Demain LA, Antunes D, O'Sullivan J, Bhaskhar SS, O'Keefe RT, Newman WG: A known pathogenic variant in the essential mitochondrial translation gene RMND1 causes a Perrault-like syndrome with renal defects. *Clin Genet* 2018; **94**: 276-277.
13. Pierce SB, Chisholm KM, Lynch ED, Lee MK, Walsh T, Opitz JM *et al*: Mutations in mitochondrial histidyl tRNA synthetase HARS2 cause ovarian dysgenesis and sensorineural hearing loss of Perrault syndrome. *Proc Natl Acad Sci U S A* 2011; **108**: 6543-6548.
14. Pierce SB, Gersak K, Michaelson-Cohen R, Walsh T, Lee MK, Malach D *et al*: Mutations in LARS2, encoding mitochondrial leucyl-tRNA synthetase, lead to premature ovarian failure and hearing loss in Perrault syndrome. *Am J Hum Genet* 2013; **92**: 614-620.
15. Pierce SB, Walsh T, Chisholm KM, Lee MK, Thornton AM, Fiumara A *et al*: Mutations in the DBP-deficiency protein HSD17B4 cause ovarian dysgenesis, hearing loss, and ataxia of Perrault Syndrome. *Am J Hum Genet* 2010; **87**: 282-288.
16. Tucker EJ, Rius R, Jaillard S, Bell K, Lamont PJ, Travessa A *et al*: Genomic sequencing highlights the diverse molecular causes of Perrault syndrome: a peroxisomal disorder (PEX6), metabolic disorders (CLPP, GGPS1), and mtDNA maintenance/translation disorders (LARS2, TFAM). *Hum Genet* 2020; **139**: 1325-1343.

17. Dominguez-Ruiz M, Garcia-Martinez A, Corral-Juan M, Perez-Alvarez AI, Plasencia AM, Villamar M *et al*: Perrault syndrome with neurological features in a compound heterozygote for two TWNK mutations: overlap of TWNK-related recessive disorders. *J Transl Med* 2019; **17**: 290.
18. Ullah F, Rauf W, Khan K, Khan S, Bell KM, de Oliveira VC *et al*: A recessive variant in TFAM causes mtDNA depletion associated with primary ovarian insufficiency, seizures, intellectual disability and hearing loss. *Human genetics* 2021.
19. Pan Z, Xu H, Tian Y, Liu D, Liu H, Li R *et al*: Perrault syndrome: Clinical report and retrospective analysis. *Mol Genet Genomic Med* 2020; **8**: e1445.
20. Rubio Gomez MA, Ibba M: Aminoacyl-tRNA synthetases. *RNA* 2020; **26**: 910-936.
21. Tucker EJ, Jaillard S, Grover SR, van den Bergen J, Robevska G, Bell KM *et al*: TP63-truncating variants cause isolated premature ovarian insufficiency. *Human mutation* 2019.
22. Yao YN, Wang L, Wu XF, Wang ED: Human mitochondrial leucyl-tRNA synthetase with high activity produced from Escherichia coli. *Protein Expr Purif* 2003; **30**: 112-116.
23. Demain LA, Urquhart JE, O'Sullivan J, Williams SG, Bhaskar SS, Jenkinson EM *et al*: Expanding the genotypic spectrum of Perrault syndrome. *Clin Genet* 2017; **91**: 302-312.
24. Perret V, Garcia A, Grosjean H, Ebel JP, Florentz C, Giege R: Relaxation of a transfer RNA specificity by removal of modified nucleotides. *Nature* 1990; **344**: 787-789.
25. Sohm B, Frugier M, Brule H, Olszak K, Przykorska A, Florentz C: Towards understanding human mitochondrial leucine aminoacylation identity. *J Mol Biol* 2003; **328**: 995-1010.
26. Richards S, Aziz N, Bale S, Bick D, Das S, Gastier-Foster J *et al*: Standards and guidelines for the interpretation of sequence variants: a joint consensus recommendation of the American College of Medical Genetics and Genomics and the Association for Molecular Pathology. *Genet Med* 2015; **17**: 405-424.
27. Riley LG, Rudinger-Thirion J, Schmitz-Abe K, Thorburn DR, Davis RL, Teo J *et al*: LARS2 Variants Associated with Hydrops, Lactic Acidosis, Sideroblastic Anemia, and Multisystem Failure. *JIMD Rep* 2016; **28**: 49-57.
28. Morgan A, Lenarduzzi S, Spedicati B, Cattaruzzi E, Murru FM, Pelliccione G *et al*: Lights and Shadows in the Genetics of Syndromic and Non-Syndromic Hearing Loss in the Italian Population. *Genes (Basel)* 2020; **11**.
29. Someya S, Yamasoba T, Kujoth GC, Pugh TD, Weindruch R, Tanokura M *et al*: The role of mtDNA mutations in the pathogenesis of age-related hearing loss in mice carrying a mutator DNA polymerase gamma. *Neurobiol Aging* 2008; **29**: 1080-1092.
30. Chen A, Tiosano D, Guran T, Baris HN, Bayram Y, Mory A *et al*: Mutations in the mitochondrial ribosomal protein MRPS22 lead to primary ovarian insufficiency. *Hum Mol Genet* 2018; **27**: 1913-1926.
31. Lerat J, Jonard L, Loundon N, Christin-Maitre S, Lacombe D, Goizet C *et al*: An Application of NGS for Molecular Investigations in Perrault Syndrome: Study of 14 Families and Review of the Literature. *Hum Mutat* 2016; **37**: 1354-1362.
32. Carminho-Rodrigues MT, Klee P, Laurent S, Guipponi M, Abramowicz M, Cao-van H *et al*: LARS2-Perrault syndrome: a new case report and literature review. *BMC Med Genet* 2020; **21**: 109.
33. Gonzalez-Serrano LE, Chihade JW, Sissler M: When a common biological role does not imply common disease outcomes: Disparate pathology linked to human mitochondrial aminoacyl-tRNA synthetases. *J Biol Chem* 2019; **294**: 5309-5320.
34. European Society for Human R, Embryology Guideline Group on POI, Webber L, Davies M, Anderson R, Bartlett J *et al*: ESHRE Guideline: management of women with premature ovarian insufficiency. *Hum Reprod* 2016; **31**: 926-937.
35. Ren J, Wen L, Gao X, Jin C, Xue Y, Yao X: DOG 1.0: illustrator of protein domain structures. *Cell Res* 2009; **19**: 271-273.

Acknowledgements

We thank the Bioinformatic department of CHU Rennes (UF Bioinformatique et Génétique Computationnelle, Service de Génétique Moléculaire et Génomique, Pr M. De Tayrac and Dr W. Carré) for helpful advice and technical assistance. Dr A. Meyer (otorhinolaryngologist at Polyclinique Sévigné, Cesson-Sévigné) performed audiology assessment.

Funding

This work was supported by a CHU Rennes grant (Appel à Projets Innovations 2019 to SJ), an Australian NHMRC program grant (1074258 to AHS), NHMRC fellowships (1054432 to EJT, 1062854 to AHS) and an Australian Mito Foundation grant (EJT). Part of this work was performed under the Rare Diseases Functional Genomics programme, supported by the Luminesce Alliance – Innovation for Children’s Health, a not for profit cooperative joint venture between the Sydney Children’s Hospitals Network, the Children’s Medical Research Institute, and the Children’s Cancer Institute. It has been established with the support of the NSW Government to coordinate and integrate pediatric research. Luminesce Alliance is also affiliated with the University of Sydney and the University of New South Wales Sydney (LGR). The research conducted at the Murdoch Children’s Research Institute was supported by the Victorian government’s operational infrastructure support program. The Chair in Genomic Medicine awarded to J.C. is generously supported by The Royal Children’s Hospital Foundation.

Author contribution

EJT and SJ contributed to conception and design of the study. MABR, AHS, SJ, and EJT participated in the project supervision. ASN, MB, LA, and CR were involved in patients’ medical care. JRT, MF, LGR, and JC contributed to functional work. All authors contributed to the

acquisition and/or analysis of data. ASN, EJT, DG and SJ wrote the manuscript. All authors revised it critically and approved the final version.

Ethical approval

Written informed consent was obtained from the patients. All procedures were in accordance with the ethical standards of the Ethics Committee of Rennes University Hospital and the French law.

Competing interests

The authors declare no conflict of interest.

PRE-PROOF

Figure legends

Figure 1.

(A) Pedigree of the family. III1 and arrow: proband, III2: affected sister, II1: father, II2: mother.

Black: LARS2 variant segregation. Asterisk indicates individuals with reported infertility, but the nature of this infertility is not known.

(B) Sanger validation of the LARS2 variants. III1: proband, III2: sister, II2: mother, II1: father.

(C) Localization of LARS2 variants in the crystal structure of *E. coli* LARS ortholog (PDB:

4AQ7). The catalytic domain of the enzyme is shown in dark grey and additional domains (editing and tRNA binding) are indicated in light grey. The catalytic domain contains the active site (green) defined by two conserved motifs, HMGH and KMSKS, involved in the binding of the leucyl-adenylate (Leu-AMP). The formation of Leu-AMP is the first step of the aminoacylation reaction, indicated on the bottom of the structure. The second step consists in transferring the activated amino acid on the 3' end of the tRNA molecule (not shown). Variants are indicated in purple.

(D) Multi-species sequence alignment of LARS2 in metazoans. Primates (*Homo sapiens*,

Macaca mulata, *Mandrillus leucophaeus*, *Gorilla gorilla*, *Pongo abelii*); other mammals

(*Trichechus manatus*, *Balaenoptera acutorostrata*, *Monodon monoceros*, *Orcinus orca*); birds:

(*Apteryx rowi*, *Calidris pugnax*, *Aquila chrysaetos*; *Hirundo rustica*); reptiles (*Gopherus*

evgoodei, *Platysternon megacephalum*, *Trachemys scripta elegans*, *Terrapene carolina*

triunguis) and fishes (*Polypterus senegalus*, *Acipenser ruthenus*, *polyodon spathula*,

Lepisosteus oculatus) as well as in bacteria (*Thermus thermophilus*, *Escherichia coli*,

Cyanobacteria bacterium J003, *Fischerella thermalis*). Alignments are restricted to the

domains of eukaryotic LARS2 and bacterial LARS harboring the variants. Color codes are

identical as those used in panel (C).

Figure 2. Audiological data of the proband and her sister. Hearing thresholds at standard audiometric frequencies are shown for air conduction (cross: left ear, open circle: right) and masked bone conduction (open square to left: left ear, open square to right: right ear) of the proband (A) and her sister (B). Speech audiometry shows the percentage of correct word perception at varying presentation level (dB HL, hearing level) in the proband (C) and her sister (D). Tympanometry in the sister (E) demonstrates a Type C profile (conductive hearing loss) in the right ear, and Type A (normal) in the left ear.

MEP: middle ear pressure, ECV: ear canal volume, SC: static compliance

Figure 3. Pathogenic or likely pathogenic variants reported in ClinVar, LOVD or HGMD Pro with DOG tool ³⁵.

Green: Perrault syndrome, Blue: hydrops, lactic acidosis, and sideroblastic anemia, Orange: mitochondrial myopathy, Pink: non-syndromic hearing loss and deafness, Light blue: rare genetic deafness, Grey: Neu-Laxova syndrome, Red: no phenotypic information, Black: VUS, Star: variants carried by the patients of this study, Underscored: novel variant

LARS2 protein with domains, from left to right: The mitochondrial targeting signal (MTS), the catalytic domain (61-243 and 444-649) in the middle of which is inserted the editing domain (244-443) and followed by the tRNA binding domains (650-903). The color code used in Figure 1C is conserved.

Table 1. Kinetic parameters for leucylation of *E. coli* tRNA_{5^{Leu} transcript by LARS2 wild-type and variant recombinant proteins. Values are mean (SEM), n ≥ 3. P-values are shown for k_{cat}/K_m ratio compared to Wt.}

Table 2. Clinical features of patients that harbour at least one LARS2 p.(Thr522Asn) variant (adapted from Demain et al., 2017) ²³

A

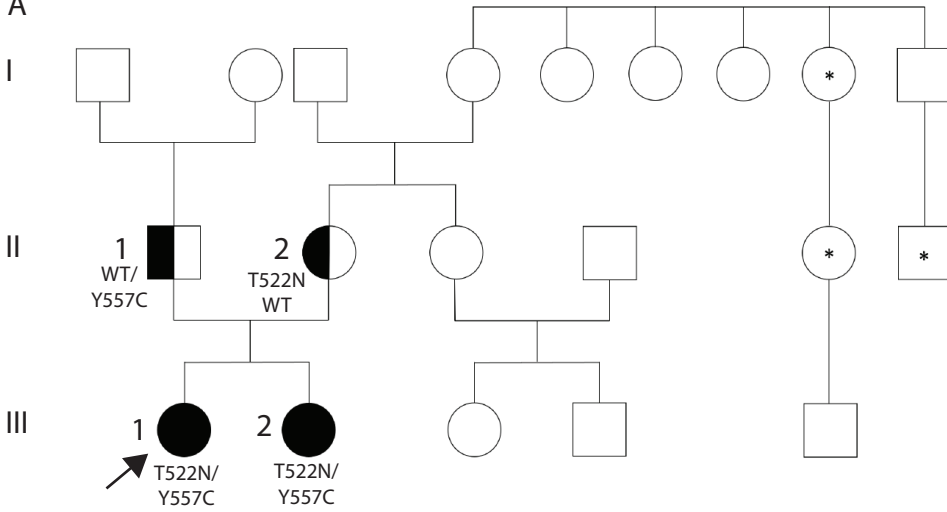

B

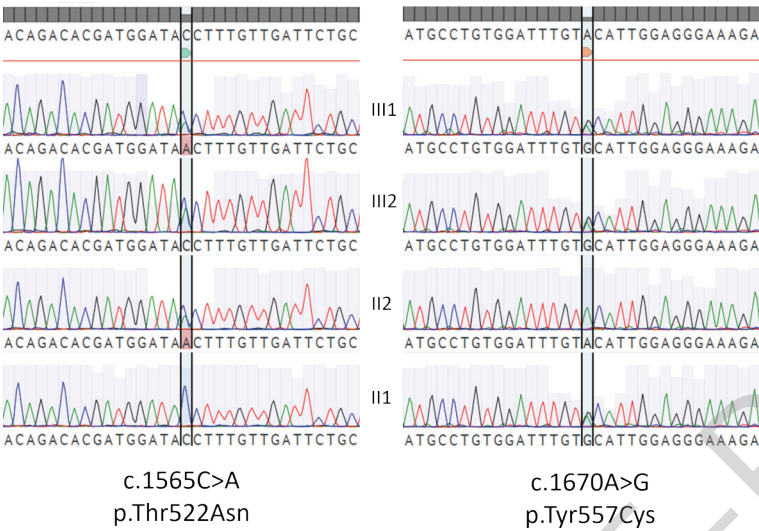

C

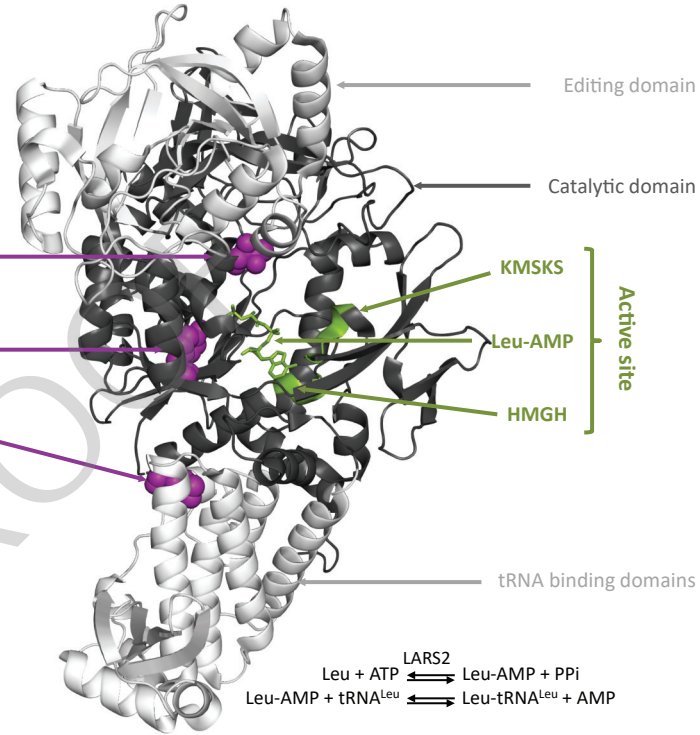

D

Species	94-124	124-517	517-530	530-550	550-590
primates					
<i>H. sapiens</i>	SGK L HM G HVRVY T ISD T IAR F Q K MR G MQ V IN	124-517	TDTMD T FFVDSAWY Y	530-550	YWMPVD L YIGGKEHAVMHLFYAR F FSHFCHDQ K MV K HRE P PF-590
<i>M. mulatta</i>	SGK L HM G HVRVY T ISD T IAR F Q K MR G MQ V IN		TDTMD T FFVDSAWY Y		YWMPVD L YIGGKEHAVMHLFYAR F FSHFCHDQ K MV K HRE P PF
<i>G. gorilla</i>	SGK L HM G HVRVY T ISD T IAR F Q K MR G MQ V IN		TDTMD T FFVDSAWY Y		YWMPVD L YIGGKEHAVMHLFYAR F FSHFCHDQ K MV K HRE P PF
<i>P. abelii</i>	SGK L HM G HVRVY T ISD T IAR F Q K MR G MQ V IN		TDTMD T FFVDSAWY Y		YWMPVD L YIGGKEHAVMHLFYAR F FSHFCHDQ K MV K HRE P PF
other mammals					
<i>T. manatus</i>	SGK L HM G HVRVY T ISD T IAR F Q K MR G MQ V IN		TDTMD T FFVDSAWY Y		FWMPVD L YIGGKEHAVMHLFYAR F FSHFCHDQ K MV K HRE P PF
<i>B. acutorostrata</i>	SGK L HM G HVRVY T ISD T IAR F Q K MR G MQ V IN		TDTMD T FFVDSAWY Y		YWMPVD V YIGGKEHAVMHLFYAR F FSHFCHDQ K MV K HRE P PF
<i>M. monoceros</i>	SGK L HM G HVRVY T ISD T IAR F Q K MR G MQ V IN		TDTMD T FFVDSAWY Y		YWMPVD L YIGGKEHAVMHLFYAR F FSHFCHDQ K MV K HRE P PF
<i>O. orca</i>	SGK L HM G HVRVY T ISD T IAR F Q K MR G MQ V IN		TDTMD T FFVDSAWY Y		YWMPVD L YIGGKEHAVMHLFYAR F FSHFCHDQ K MV K HRE P PF
birds					
<i>A. rowi</i>	SGK L HM G HVRVY T ISD T IAR F Q K MR G MQ V IN		TDTMD T FFVDSAWY Y		YWMPVD L YIGGKEHAVMHLFYAR F FSHFCHD L K M T K HKE P PF
<i>C. pugnax</i>	SGK L HM G HVRVY T ISD T IAR F Q K MR G MQ V IN		IDTMD T FFVDSAWY Y		YWMPVD L YIGGKEHAVMHLFYAR F FSHFCHD L K M T K HKE P PF
<i>A. chrysaetos</i>	SGK L HM G HVRVY T ISD T IAR F Q K MR G MQ V IN		ADTMD T FFVDSAWY Y		YWMPVD L YIGGKEHAVMHLFYAR F FSHFCHD L K M T K HKE P PF
<i>H. rustica</i>	SGK L HM G HVRVY T ISD T IAR F Q K MR G MQ V IN		VDTMD T FFVDSAWY Y		YWMPVD L YIGGKEHAVMHLFYAR F FSHFCHD L K M T K HKE P PF
reptiles					
<i>G. evgoodei</i>	SGK L HM G HVRVY T ISD T IAR F Q K MR G MQ V IN		TDTMD T FFVDSAWY Y		YWMPVD L YIGGKEHAVMHLFYAR F FLSHFCYDQ K M T K H KE P PF
<i>P. megacephalum</i>	SGK L HM G HVRVY T ISD T IAR F Q K MR G MQ V IN		TDTMD T FFVDSAWY Y		YWMPVD L YIGGKEHAVMHLFYAR F FLSHFCYDQ K M T K H KE P PF
<i>T. scripta elegans</i>	SGK L HM G HVRVY T ISD T IAR F Q K MR G MQ V IN		TDTMD T FFVDSAWY Y		YWMPVD L YIGGKEHAVMHLFYAR F FLSHFCYDQ K M T K H KE P PF
<i>T. carolina triunquis</i>	SGN L HM G HVRVY T ISD T IAR F Q K MR G MQ V IN		TDTMD T FFVDSAWY Y		YWMPVD L YIGGKEHAVMHLFYAR F FLSHFCYDQ K M T K H KE P PF
fish					
<i>P. senegalus</i>	SGK L HL G HVRVY T ISD T IA I GH F Q R MR G Q V LN		TDTMD T FFVDSAWY Y		RWLPVD L YIGGKEHAVMHLFYAR F FM S H F CK D L K L T K H RE P PF
<i>A. ruthenus</i>	SGK L HM G HVRVY T ISD T IA I H F Q R MR G N V LN		TDTMD T FFVDSAWY Y		HWMPVD L YIGGKEHAVMHLFYAR F FSHFCKD Q N L V K HRE P PF
<i>P. spathula</i>	SGK L HM G HVRVY T ISD T IA I H F Q R MR G Y V LN		TDTMD T FFVDSAWY Y		HWMPVD L YIGGKEHAVMHLFYAR F FSHFCKD Q N L V K HRE P PF
<i>L. oculatus</i>	SGK L HM G HVRVY T ISD T IG H FQ R MR G K V LN		TDTMD T FFVDSAWY Y		YWMPVD L YIGGKEHAVMHLFYAR F FSHFCKD K N L V S HRE P PF
bacteria					
<i>T. thermophilus</i>	SGD L HM G HL K NY T MG D VLAR F RR M Q G Y E VLH		TDTMD T FFVDSAWY Y		AWMPVD Q YIGGVEHA-----GT L HL L W K PA V M S K S K G NG
<i>E. coli</i>	45-SGR L HM G HVRVY T IG D VIAR F Q R ML G K N V L Q	75-489	TDT F DM S SWY Y	500-520	YWLPVD L YIGGIEHA-534-----610HEL V Y T GM S K M S K SN G -627
<i>C. bacterium</i>	SGN L HM G HVRVY T IG D VIAR C RR M Q G Y R VLH		TDTMD T FFVDSAWY Y		DWLPVD Q YVGGIEHA-----EAL E -V V Y E K M S K S K Y N G
<i>F. thermalis</i>	SGS L HM G HVRVY T IG D VIAR L K R M Q G Y R V LH		TDTMD T FFVDSAWY Y		DLMPVD Q YVGGIEHA-----EPL Q -R I Y A T M S K S K G N G

A

Pure tone audiometry (proband)

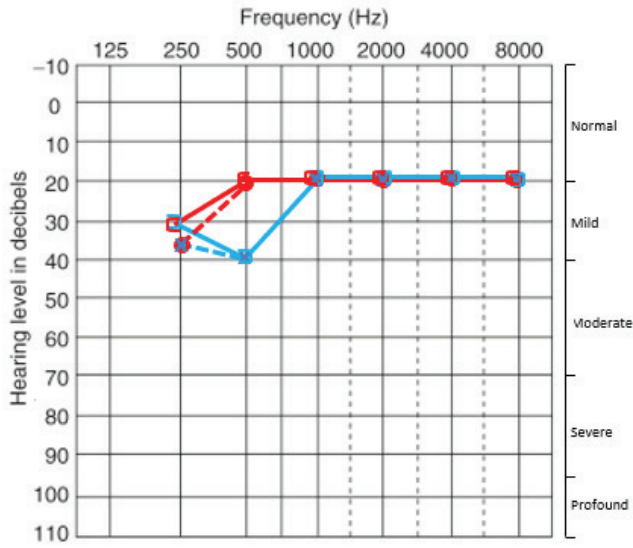

B

Pure tone audiometry (sister)

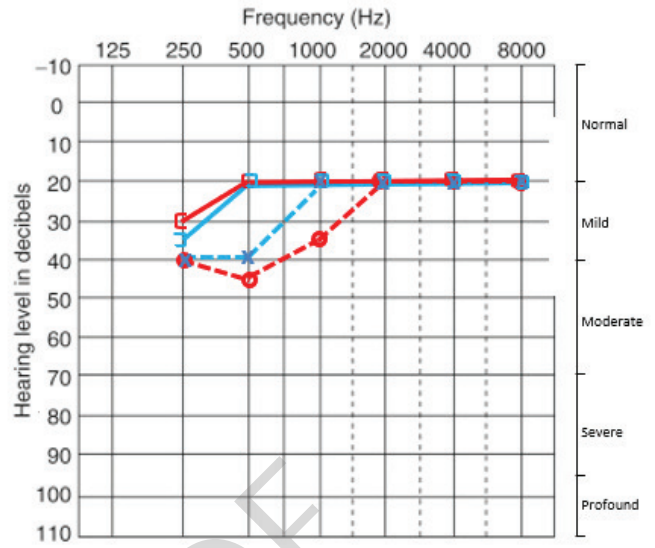

C

Speech audiometry (proband)

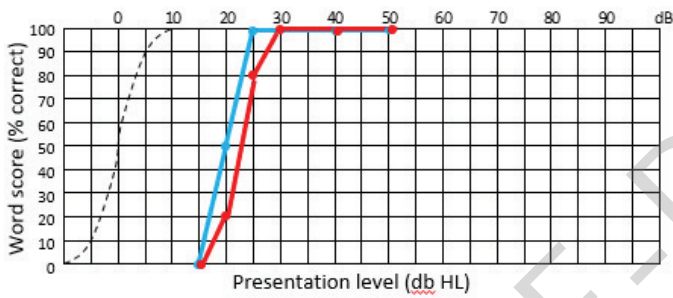

D

Speech audiometry (sister)

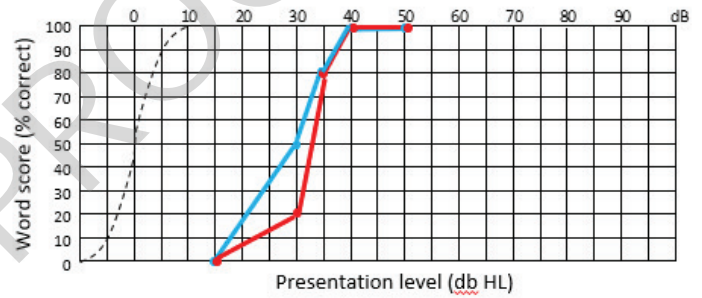

E

Tympanometry (sister)

	MEP (daPa)	ECV (mL)	SC (mL)	Type
Right ear	-125	0.6	0.3	C
Left ear	-77	0.6	0.5	A

Table 1. Kinetic parameters for leucylation of *E. coli* tRNA_{5^{Leu} transcript by LARS2 wild-type and variant recombinant proteins.}

LARS2	K_m (μM)	k_{cat} (min^{-1})	k_{cat}/K_m ($\text{min}^{-1} \mu\text{M}^{-1}$)	Loss of catalytic efficiency*
Wt	2.0 (0.3)	13.7 (0.8)	6.85 (1.38)	1
Tyr557Cys	2.6 (0.4)	1.5 (0.3)	0.55 (0.02 ; P=.024)	12.5
Met117Ile	2.0 (0.5)	10.1 (0.9)	5.05 (0.74 ; P=.045)	1.4

*Loss of efficiency is calculated as a fold-change relative to wild-type (Wt) LARS2

Wt: wildtype

Values are mean (SEM), $n \geq 3$. P-values are shown for k_{cat}/K_m ratio compared to Wt

Table 2. Clinical features of patients that harbour at least one LARS2 p.(Thr522Asn) variant (adapted from Demain et al., 2016)

ID	III-1 (This study)	III-2 (This study)	P3:II-1 (Demain et al., 2017)	P3:II-2 (Demain et al., 2017)	P2:II-1 (Demain et al., 2017)	P2:II-2 (Demain et al., 2017)	F1:II-2 (Pierce et al., 2013)	F1:II-1 (Pierce et al., 2013)	F1:II-3 (Pierce et al., 2013)	Proband (Riley et al., 2016)
Ethnicity	French	French	British	British	Argentinian	Argentinian	Palestinian	Palestinian	Palestinian	Pakistani
Sex	F	F	F	M	F	M	F	M	M	F
Karyotype	46, XX	46, XX	46, XX	NR	46, XX	NR	46, XX	NR	NR	46, XX
Age at genetic diagnosis (y)	21	16	25	26	30	27	30	32	27	Post-mortem
LARS2 variants	p.((Thr522Asn)); [(Tyr557Cys)]	p.((Thr522Asn)); [(Tyr557Cys)]	p.((Thr522Asn)); [(Met117Ile)]	p.((Thr522Asn)); [(Met117Ile)]	p.((Thr522Asn)); [(Thr522Asn)]	p.((Thr522Asn)); [(Thr522Asn)]	p.((Thr522Asn)); [(Thr522Asn)]	p.((Thr522Asn)); [(Thr522Asn)]	p.((Thr522Asn)); [(Thr522Asn)]	p.((Thr522Asn)); [(Ala430Val)]
Loss of amino-acylation efficiency for each variant (fold-change)	9; 12.5	9; 12.5	9; 1.4	9; 1.4	9; 9	9; 9	9; 9	9; 9	9; 9	9; 18
<u>Sensorineural hearing loss</u>										
Age at hearing loss diagnosis (y)	23	19	2.5	2.5	8	26	3-5	3-5	3-5	NR
Degree of hearing loss	Sub-clinical	Sub-clinical	Severe / profound	Severe / profound	Moderate	Mild / moderate	Mild / moderate / severe Right ear more affected than left	Severe at low frequency Less severe at high frequency	Severe at low frequency Less severe at high frequency	NR
<u>Gonadal dysfunction</u>										

Pelvic ultrasound/MRI	Right ovary = fibrous band, two follicles on the left ovary	Streak ovaries	Small uterus and ovaries	NA	Small uterus and ovaries	NA	Small uterus, ovaries not detected	NA	NA	NR
Menarche	Yes	Yes	Yes	NA	No	NA	No	NA	NA	NA
POI	Yes	Yes	Yes	NA	Yes	NA	Yes	NA	NA	NA
FSH IU/L	64	80	74 (≤ 30)	3.1 (1-11)	99.6 (2.3-29)	NR	76.9	NR	NR	NA
LH IU/L	23	37	63 (≤ 30)	3.9 (1-11)	48.0 (1.7-52)	NR	30.3	NR	NR	NA
Estradiol pg/mL	<10	<10	24.8 (>49)	NA	7.0 (10-388)	NA	NR	NA	NA	NA
Neurological features	No	No	No	No	No	No	No	NR	NR	Seizures
Other features	No	Marfanoid habitus	Hemidystrophy, mild facial dysmorphism	Hypospadias, mild facial dysmorphism	No	No	No	NR	NR	Hydrops, lactic acidosis, sideroblastic anemia. Multi-system failure. Death at 5 days.