

Selecting generalized continuum theories for nonlinear periodic solids based on the instabilities of the underlying microstructure

Christelle Combescure

*Académie Militaire Saint-Cyr Coëtquidan
Institut de Recherche Dupuy de Lôme*

USNC/TAM 2022 – UT Austin

1. Context
2. Research Question
3. Our Study

Architected Materials

Definition and applications

Scale separation in conventional materials

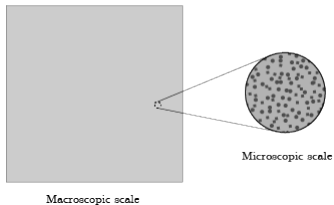

Scale separation in architected materials

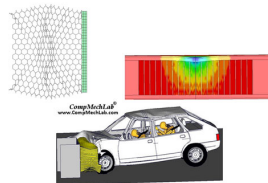
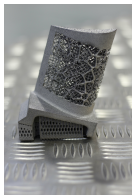
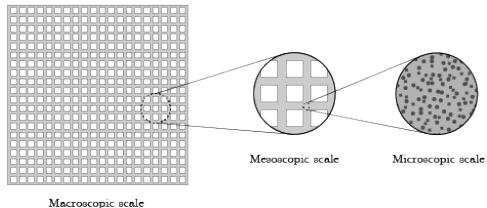

Architected Materials

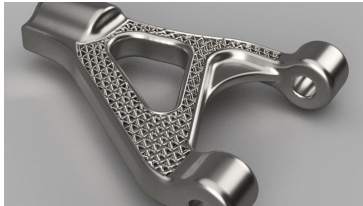

Prohibitive computational cost for full modeling
⇒ Need for equivalent continuum media

Architected Materials & Instabilities

Buckling when compressed

Effect of cell geometry : commensurate vs structural

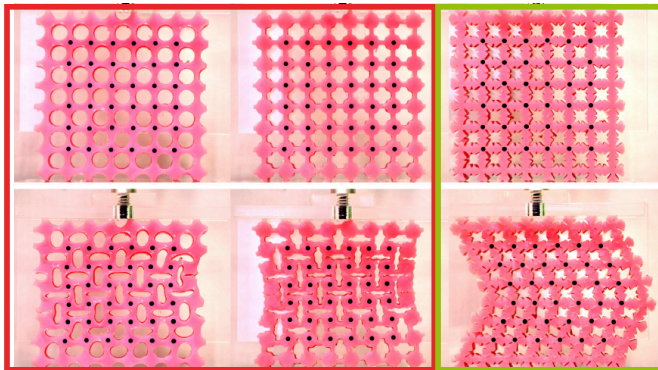

[Overvelde J.T.B. & Bertoldi K. 2014]

Architected Materials & Instabilities

Buckling when compressed

Effect of cell geometry : commensurate vs structural

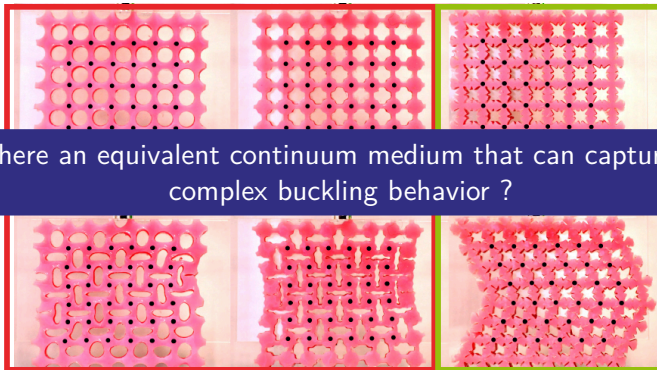

Is there an equivalent continuum medium that can capture the complex buckling behavior ?

[Overvelde J.T.B. & Bertoldi K. 2014]

Literature review

Family of equivalent media

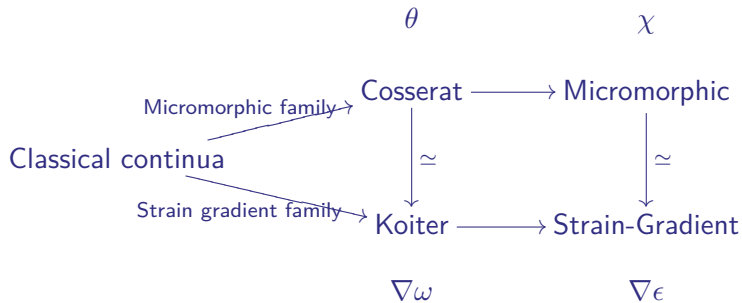

Basic extensions of a classical continuum.
Adapted from [Auffray et al. 2015].

Literature review

Higher-order gradient continuum model

$$W^s(\varepsilon) = \mathcal{E}(\varepsilon) + \frac{\ell^2}{2} \mathcal{H}(\varepsilon) \nabla \varepsilon^2$$

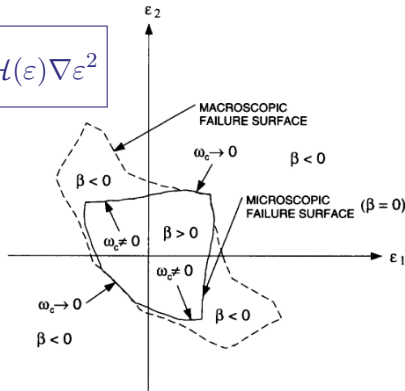

if $\mathcal{H}(\varepsilon) < 0$ at macroscopic buckling, commensurate instability happens before

[Triantafyllidis & Bardenhagen 1994-1996]

Literature review

Micromorphic continuum model

$$\mathcal{W}^m(\varepsilon, \phi_i)$$

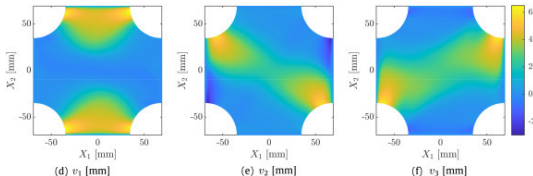
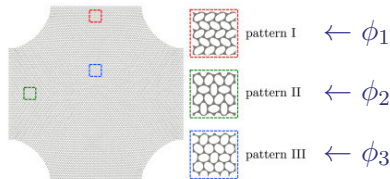

[Rokos et al. 2014]



Research Question



Research Question

[Auffray et al. 2015]

Rotation:

Stretch:

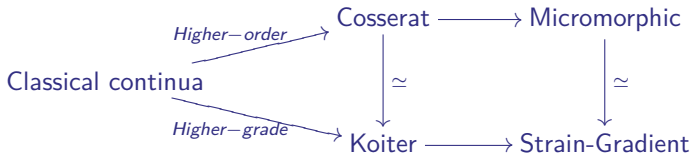

Research Question

[Auffray et al. 2015]

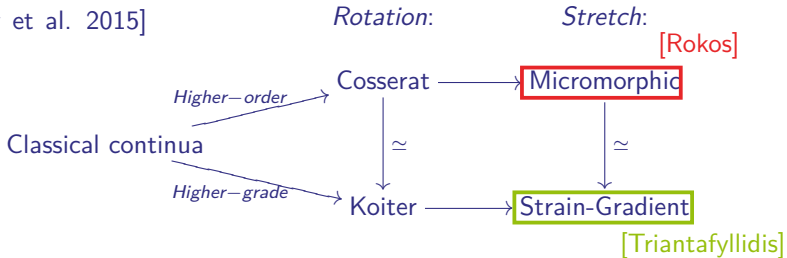

Research Question

[Auffray et al. 2015]

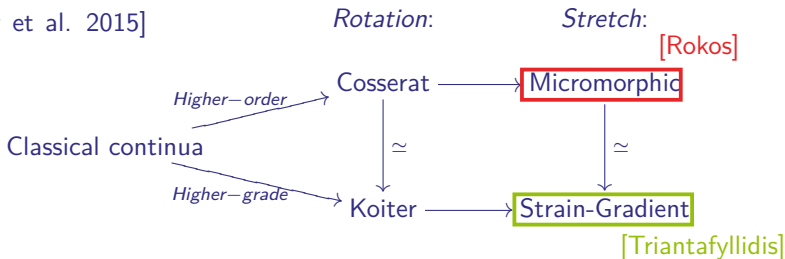

Which generalized continuum model is better suited to capture both commensurate and macroscopic instabilities in periodic media?

Our Study



Very simple example



Mesoscopic study

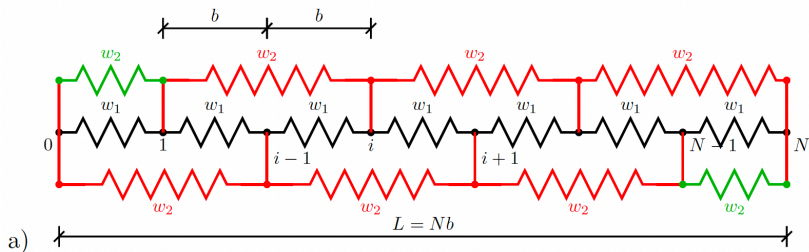

non-linear stored energy density in a spring $p = 1$ or $p = 2$

$$w_p(\varepsilon) = \frac{1}{2} K_p \varepsilon^2 - \frac{1}{4} M_p \varepsilon^4 + \frac{1}{6} N_p \varepsilon^6$$

inspired from [Triantafyllidis & Bardenhagen 1994]

[Truskinovsky & Vainchtein 2014]

Mesoscopic study

alternate example with springs on 3 nodes

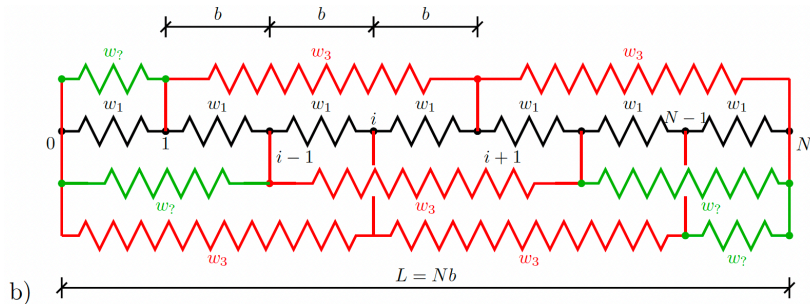

Mesoscopic study

non-linear stored energy density in a spring $p = 1$ or $p = 2$

$$w_p(\varepsilon) = \frac{1}{2} K_p \varepsilon^2 - \frac{1}{4} M_p \varepsilon^4 + \frac{1}{6} N_p \varepsilon^6$$

Stored energy density of the full system

$$\mathcal{W} = \frac{1}{2b} \sum_{n=0}^{n=N} \sum_{p=1}^q p [w_p(\varepsilon_p^{n+}) + w_p(\varepsilon_p^{n-})]$$

Total energy

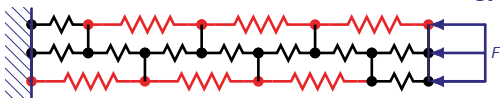

$$\mathcal{E} = \mathcal{W} - \frac{1}{Nb} F \cdot u_N$$

F end forces associated with end displacement u_N

Mesoscopic study

Equilibrium \Rightarrow principal path $\varepsilon^0 =$ uniform strain of all springs

Bloch-wave perturbation predicts 2 possible unstable regimes

- macroscopic : $g_1(\varepsilon^0) + \rho g_2(\varepsilon^0) = 0$
- commensurate ($\lambda = \rho \ell$) : $g_1(\varepsilon^0) = 0$

$$\text{with } g_p(\varepsilon) = K_p - 3M_p\varepsilon^2 + 5N_p\varepsilon^4$$

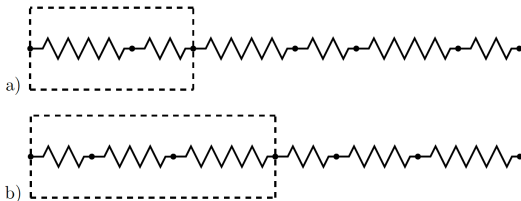

Mesoscopic study

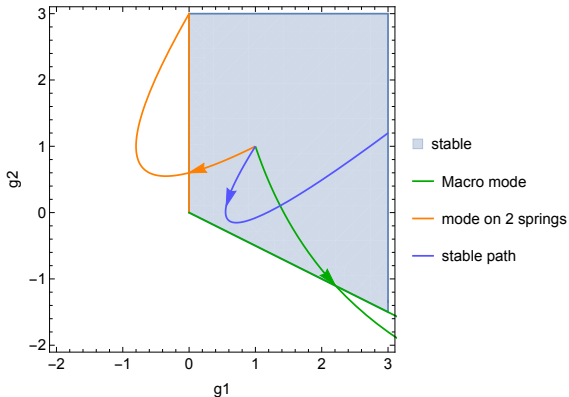

Stability of paths depends on the values of parameters K_p , M_p and N_p

commensurate mode :

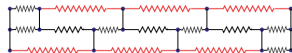

Macro mode :

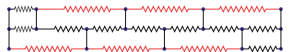

Mesoscopic study

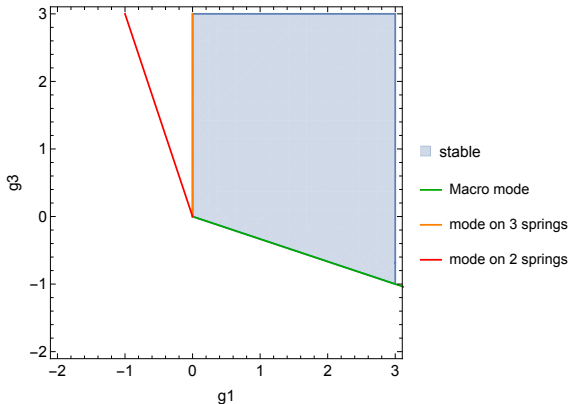

Stability of paths depends on the values of parameters K_p , M_p and N_p

commensurate mode :

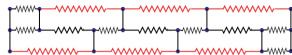

Macro mode :

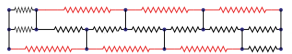

Mesoscopic study

commensurate mode :

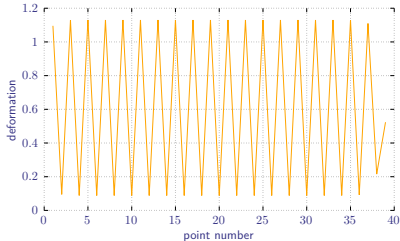
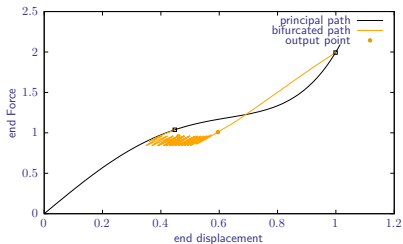

Macro mode :

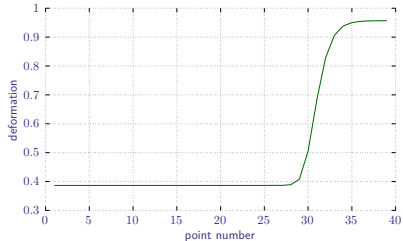
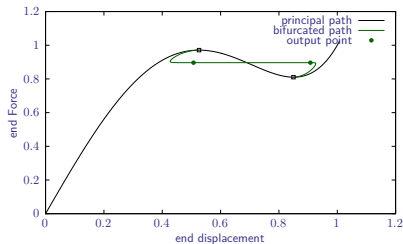

Equivalent media

Micromorphic

from mesoscopic study : commensurate wavelength mode $\lambda = 2\ell$

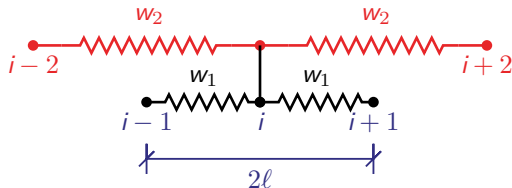

Cauchy-Born kinematics : $u(\vec{x}) = \mathbf{E} \cdot \vec{x} + \mathbf{s}(\vec{x})$

macroscopic strain

internal shift
 \approx bif. mode

Equivalent media

Micromorphic

Micromorphic energy : $u(X)$ macroscopic displ. & $s(X)$ internal shift

$$\mathcal{W}^m(u, s) = \int_0^L w_1(u, x) + 2w_2(u, x) + G_1(u, x) \left(\frac{s}{\ell}\right)^2 + k_1(u, x) \left(\frac{s}{\ell}\right)^4 + \frac{N_1}{6} \left(\frac{s}{\ell}\right)^6 dX$$

Equilibrium equations

$$\frac{\partial \mathcal{W}^m}{\partial u} \quad \text{and} \quad \frac{\partial \mathcal{W}^m}{\partial s}$$

Macro

internal

Stability condition

$$\left[\begin{array}{cc} \frac{\partial^2 \mathcal{W}^s}{\partial u^2} & \frac{\partial^2 \mathcal{W}^s}{\partial u \partial s} \\ \frac{\partial^2 \mathcal{W}^s}{\partial u \partial s} & \frac{\partial^2 \mathcal{W}^s}{\partial s^2} \end{array} \right] \Big|_{s=0}$$

def positive

Equivalent media

Micromorphic

Stability condition

$$\det \begin{bmatrix} \frac{\partial^2 W^s}{\partial u^2} & \frac{\partial^2 W^s}{\partial u \partial s} \\ \frac{\partial^2 W^s}{\partial u \partial s} & \frac{\partial^2 W^s}{\partial s^2} \end{bmatrix} \Bigg|_{s=0} = 0 \quad \Leftrightarrow \quad g_1(u, x) (g_1(u, x) + 2g_2(u, x)) = 0$$

Exact same 2 conditions as for the mesoscopic case:

- $g_1(u, x) + 2g_2(u, x) = 0$
- $g_1(u, x) = 0$

Micromorphic medium able to capture both instabilities

≈ vibration where micromorphic media can capture optical branches

Equivalent media

Micromorphic

Numerical solutions : discrete vs micromorphic

commensurate mode :

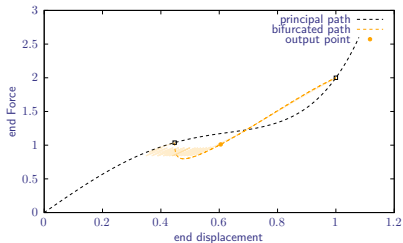

Macro mode :

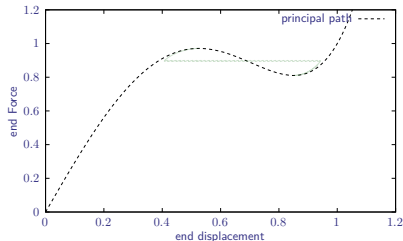

Equivalent media

Micromorphic

Numerical solutions : discrete vs micromorphic

commensurate mode :

Macro mode :

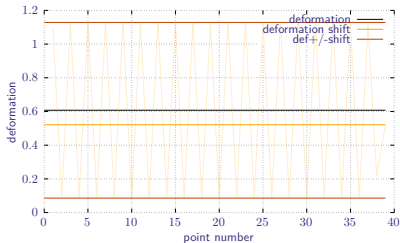

Equivalent media

Second gradient

[Triantafyllidis & Bardenhagen 1994]

Taylor-series expansion of displacement in strain expression

$$\epsilon_n^{p+} = \frac{u_{n+p} - u_n}{pl} = u_{,x} + \frac{1}{2}pl u_{,xx} + \frac{1}{6}(pl)^2 u_{,xxx} + \dots$$

$p = 1, 2$

$$\epsilon_n^{p-} = \frac{u_n - u_{n-p}}{pl} = u_{,x} - \frac{1}{2}pl u_{,xx} + \frac{1}{6}(pl)^2 u_{,xxx} - \dots$$

Second gradient energy density:

$$\mathcal{W}^s(u_{,x}) = w_1(u_{,x}) + 2w_2(u_{,x}) + (u_{,xx})^2 \frac{\ell^2}{2} h(u_{,x})$$

Equivalent media

Second gradient

[Triantafyllidis & Bardenhagen 1994]

Second gradient energy:

$$\mathcal{E}^s(u, x) = \int_0^L w_1(u, x) + 2w_2(u, x) + (u,_{xx})^2 \frac{\ell^2}{2} h(u, x) dx$$

Equilibrium equation: $\mathcal{E}_{,u}^s \delta u = 0$

$$w'_1(u, x) + 2w'_2(u, x) - \ell^2 \left(\frac{h'(u, x)}{2} (u,_{xx})^2 + h(u, x) u,_{xxx} \right) = F$$

Stability condition: $\mathcal{E}_{,uu}^s \delta u \delta u = 0$

$$g_1(u, x) + 2g_2(u, x) + \left(\frac{\ell n \pi}{L} \right)^2 h(u, x) = 0 \quad \forall n \in \mathbb{Z}$$

Equivalent media

Second gradient

Numerical solutions : discrete vs second gradient (AUTO)

commensurate mode :

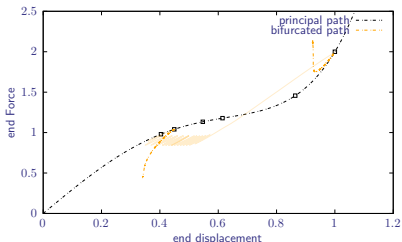

Macro mode :

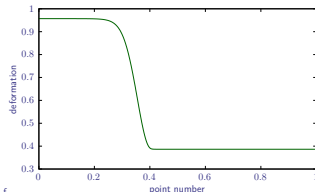
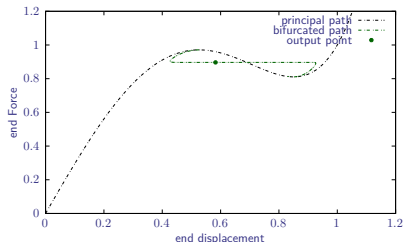

Conclusions

Comparing generalized continua vs instabilities

Micromorphic:

- Can capture patterning modes with criterion = mesoscopic
- Cannot capture localization
- Requires *a priori* knowledge of buckling mode wavelength

Second gradient:

- Can capture localization with criterion = mesoscopic
- Cannot capture commensurate mode
- Does not require any *a priori* knowledge & systematic construction

A mixte model might be useful to capture localization and commensurate mode !

C. Combescure, *Selecting generalized continuum theories for nonlinear periodic solids based on the instabilities of the underlying microstructure*, 2022, J. of El

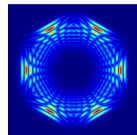

Coss&Vita

MOMAP
ANR-19-CE10-
0005



ANR-19-CE08-
0005