



**HAL**  
open science

# An Archaeological Account of Nyarma and its Surroundings, Ladakh

Quentin Devers

► **To cite this version:**

Quentin Devers. An Archaeological Account of Nyarma and its Surroundings, Ladakh. Christian Jahoda; Christiane Kalantari. Early West Tibetan Buddhist Monuments: Architecture, Art, History and Texts, 29, Österreichischen Akademie der Wissenschaften, pp.201-224, 2021, Veröffentlichungen zur Sozialanthropologie, 978-3-7001-8777-6. hal-03884565

**HAL Id: hal-03884565**

**<https://hal.science/hal-03884565v1>**

Submitted on 5 Dec 2022

**HAL** is a multi-disciplinary open access archive for the deposit and dissemination of scientific research documents, whether they are published or not. The documents may come from teaching and research institutions in France or abroad, or from public or private research centers.

L'archive ouverte pluridisciplinaire **HAL**, est destinée au dépôt et à la diffusion de documents scientifiques de niveau recherche, publiés ou non, émanant des établissements d'enseignement et de recherche français ou étrangers, des laboratoires publics ou privés.



Distributed under a Creative Commons Attribution 4.0 International License

Quentin Devers

## An Archaeological Account of Nyarma and its Surroundings, Ladakh\*

The village of Nyarma, located on the left bank of the Indus a little upstream of Thikse (see Fig. 1: map), houses a rich archaeological heritage (Figs. 2 and 3). It stands out as having been the place that had both the most numerous and the largest temples before the mid-fifteenth century. As a comparison, whilst the temples in Alchi (inside and outside the Choskor) add up to a total surface of about 350 m<sup>2</sup>, the ruins of Nyarma and its surrounding area come to roughly 860 m<sup>2</sup> (Devers 2015, forthcoming). The village has received attention mainly for its famous complex of temples in ruins, reportedly founded by Rinchen Zangpo (958–1055).<sup>1</sup> Various studies of this complex—including the *chörten* (Tib. *mchod rten*, Skt. *stūpa*)—have been conducted, the most important one being by Panglung (1983), Neuwirth and his team (see Neuwirth 2008), Kozicz (2007a-d, 2011), and myself (2015, forthcoming).<sup>2</sup> Further investigating the antiquity of

the complex, B. R. Mani of the Archaeological Survey of India found five clay tablets “datable to about eleventh century AD” (Director General Archaeological Survey of India 2006: 184). The second site that has been researched is the little fort, described by Howard in his study of the fortresses of Ladakh (Howard 1989: 269–71). Beside

\* The fieldwork for this paper was funded by the *Centre de Recherche sur les Civilisations de l'Asie Orientale* (UMR8155, CNRS/EPHE/Paris Diderot-Paris 7/Collège de France) in 2009, and by the *École Française d'Extrême-Orient* in 2010 and 2011. I would like to thank Olivier Tochon, who accompanied me for the documentation of some of the structures described in this paper.

<sup>1</sup> Also known and referred to as the Great Translator (*lo chen*) Rin chen bzang po [editors' note].

<sup>2</sup> Earlier descriptions and reports on Nyarma are by Joseph Gergan (bSod nams Tshe brtan) (see Jahoda, “Joseph Thsertan Gergan's report on Nyarma, 1917”, this volume) and by Rāhula Sāṅkrtyāyana. Mention of Gergan's report (although with reference to Francke) is also made in Kozicz (2007b: 1, 4). Concerning the activities by Rāhula Sāṅkrtyāyana in Nyarma, John Bray kindly indicated to me that he mentions the excavations he made at the complex in the 1930s with the help of a young member of the Moravian mission, Tsetan Phuntshog (personal communication by John Bray, January 2012). If such digs did take place, it would be ground breaking to know which part of the complex was excavated and where the report or the results could be consulted.

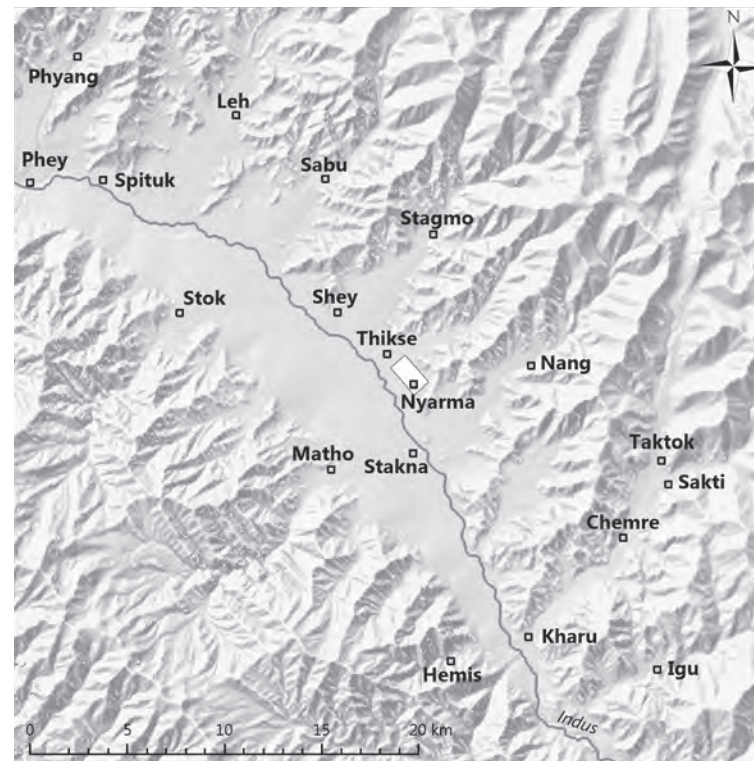

1. Map of Central Ladakh with the area of study highlighted in white (Q. Devers, 2012).



these, there are other structures that haven't received the same attention yet: overlooking Nyarma on the east is a small hill-temple complex, and north of the rocky formation on which the fort stands is a series of four ruins of temples.

The goal of this paper is not to comment on and confront what has already been written on Nyarma, instead it is to bring a much-needed fresh archaeological look at the ruins, especially at Temple 1, whose relative complex chronology has been the source of confusion in the existing literature as regards the reconstruction of its original plan and the distinction of its successive transformations. To close this introduction, it should be noted that the numerous *mchod rten* found in this area of study, though of indubitable interest, are, like modern structures, intentionally left aside: we will focus exclusively on the ruins of temples and on the fort.

2. General view of the area of study from the south-south-east: a) main complex, b) fort, c) hill temple complex, d) Thikse-Nyarma area. The monastery of Thikse can be seen in the background (Q. Devers, 2011).



### The Main Complex of Temples

Nowadays only five temples are left in the main complex, along with

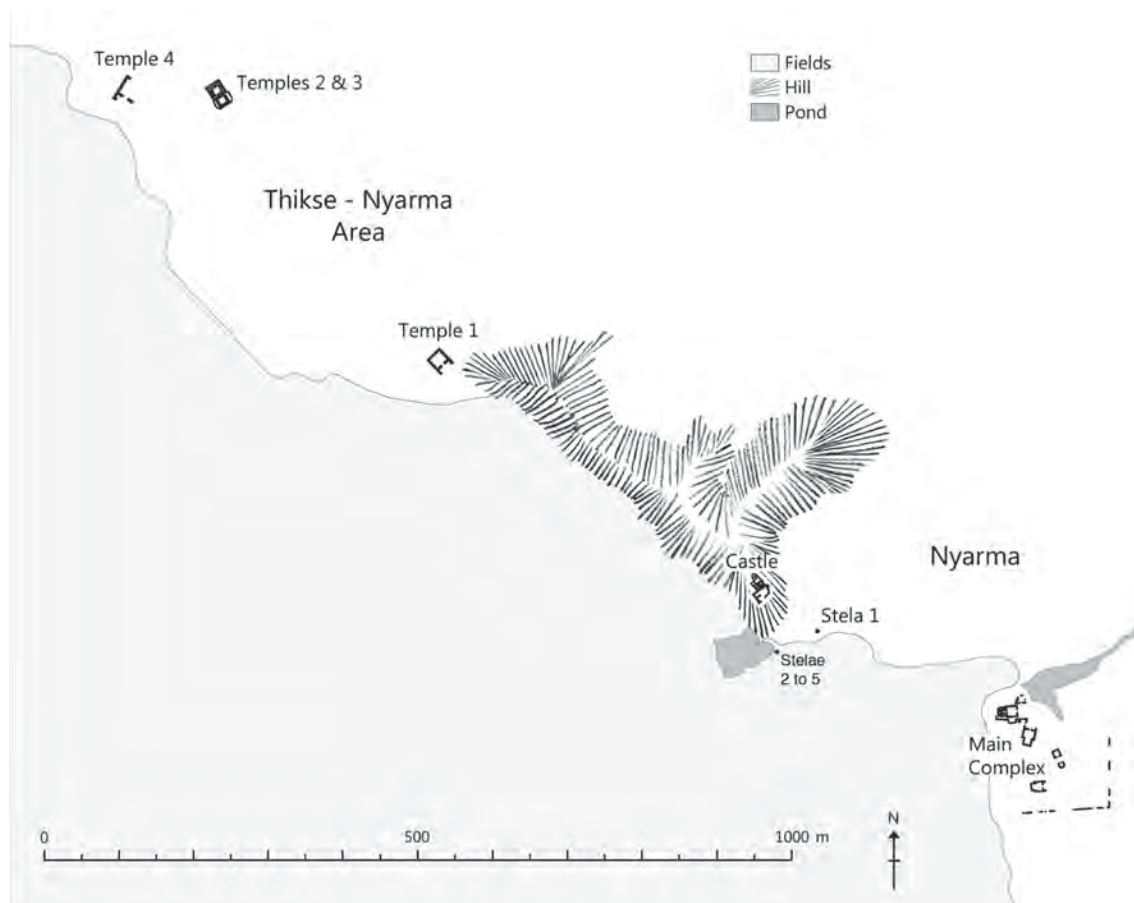

3. Sketch map of area of study (Q. Devers, 2012; topography drawn by Martin Vernier, 2012).



4. Satellite view of Nyarma (American Corona Space Mission, October 4 1965). Courtesy of Abram Pointet, Cartographer.

some portions of the original enclosure on the southern and eastern edges (Figs. 5 and 6). These structures are all built with unbaked bricks, none of the walls are in stone. As the different sizes and textures of the bricks indicate (Fig. 29), these constructions were likely erected at different times.

From an archaeological perspective, important recent activity has damaged the complex, the most important being the construction of a new temple and the extraction of construction material from most of the southern and eastern part of the complex. This is carried on an industrial scale, with trucks coming on a daily basis to carry the extracted material. The size and the depth of the pit is growing every year—in 2011 it was about 50 x 70 m and over 2 m deep (on Fig. 21, a truck and the beginning of the pit on the left can be seen; the same pit is also visible on Fig. 5 on the right).

The complex is constructed on a location that has a clear water-drainage problem. Indeed, the little pond on the northern side does not flow anywhere: water comes both from the pond down the fort





5. General view of the main complex from the south-south-east (Q. Devers, 2011).

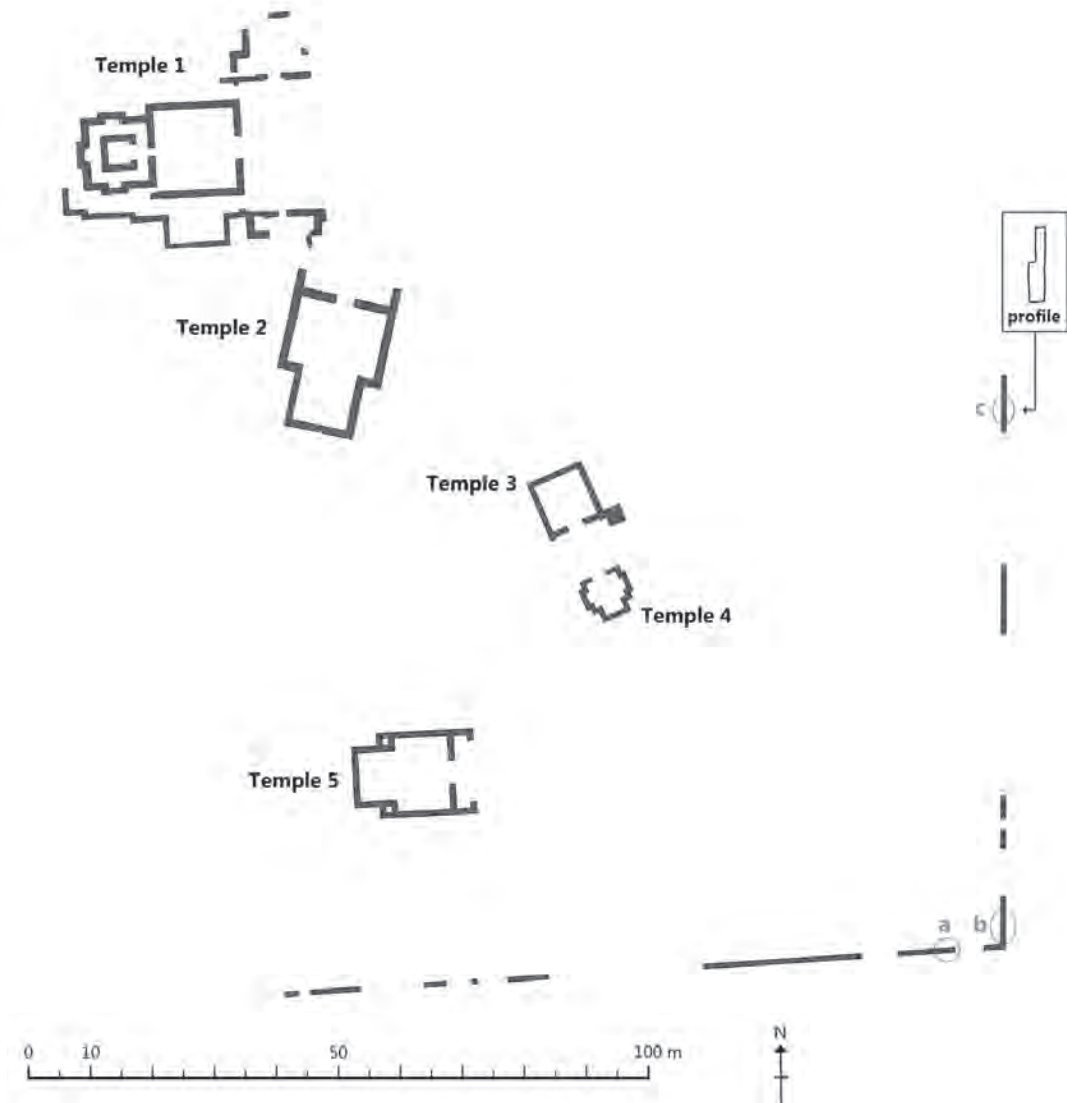

6. Plan of the main complex (Q. Devers, 2012).

on the west and from the mountains on the east. The builders must have faced this difficulty, and it is to be wondered if they had any water-management system to overcome it, and, if they did, what it was. A reservoir has recently been built—as it does not appear on the satellite view of Fig. 4, this would have been after 1965—near the hill with the hill temple complex, with a drain that goes straight to the main complex. This installation, now unused, could have only aggravated the drainage situation.<sup>3</sup>

<sup>3</sup> It can be suspected that it is indirectly responsible for the collapse of some of the walls of Temple 1 (walls of Space B and Chapel C, i.e. walls 15, 16 and 17

With the extraction pit, the fluctuations of the pond and the construction of the new temple there is probably no chance of retrieving the foundations of the three missing temples that once stood in the complex (see Panglung 1983: 283) along with the five that are cur-

on Fig. 7): while these walls were still standing in 1965 as can be seen on Fig. 4, they have now dissolved into the ground. A possible scenario is that on the completion of this installation large quantity of water likely ended up rushing to the complex, where it had nowhere to escape, as the topography goes slightly uphill in all directions, provoking an increase in the size of the pond which dissolved the base of walls 15, 16 and 17, resulting in turn in their eventual collapse.

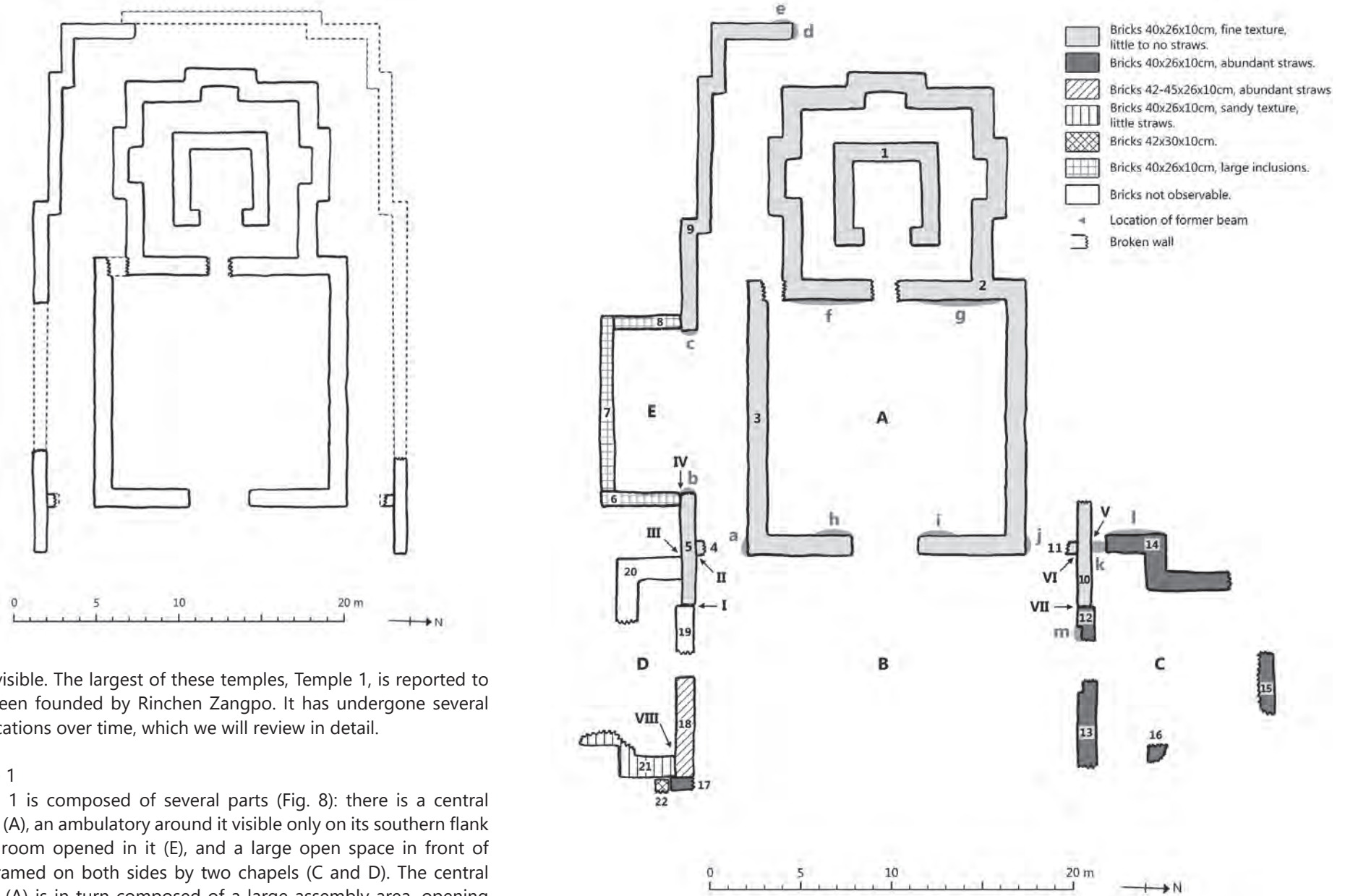

rently visible. The largest of these temples, Temple 1, is reported to have been founded by Rinchen Zangpo. It has undergone several modifications over time, which we will review in detail.

### Temple 1

Temple 1 is composed of several parts (Fig. 8): there is a central temple (A), an ambulatory around it visible only on its southern flank with a room opened in it (E), and a large open space in front of it (B) framed on both sides by two chapels (C and D). The central temple (A) is in turn composed of a large assembly area, opening on the west on an inner ambulatory that contains a central cella. A small temple was built in the relatively recent past (most probably in the 1840s, see Jahoda, "Joseph Thsertan Gergan's report on Nyarma, 1917", this volume, p. 175) above this cella and above part of the inner ambulatory, as can be seen in Fig. 9.

In order to reconstruct the original plan and to trace the various changes, the walls need to be studied by looking at their various

components like the bricks—both size and texture—the mud coats, the beam marks etc.

In Fig. 8, the walls are differentiated according to their chaining, and according to the traces of mud coats. For example, the sections of wall 2 are chained together, making it one long single wall. On the other hand, while they are straight and contiguous, walls 5 and 19 are not the same,

7. Reconstruction of the original plan of Temple 1 (Q. Devers, 2012).

8. Plan of Temple 1. Roman numerals indicate specific mud-coat marks and grey lower-case letters locations referred to in the text (Q. Devers, 2012).



9. Assembly area of Temple 1 from south-east. Numbers indicate the walls numbers according to Fig. 8. The white arrows show the recesses where the beams used to fit on wall 2. The opposite wall has its top levelled (wall 3) (Q. Devers, 2009).

10: Different types of deambulatory roofing. After original drawings by Martin Vernier (Q. Devers, 2012).

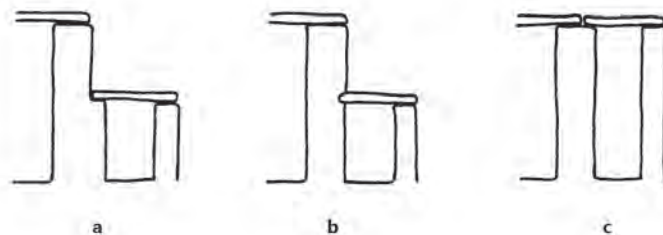

11. Temple 1: drawing of the halo in *i*. Scale approximate. The halo is in white, holes in the wall are in black (Q. Devers, 2012).

12. Temple 1: drawing of the halos in *g*. Scale approximate. The halos are in white, holes in the wall are in black (Q. Devers, 2012).

because the external mud coat of wall 5 goes all around its tip at its juncture with wall 19, thus separating them. In addition, in Fig. 8, the walls are coloured according to the size and texture of the bricks.

### *The Original Temple*

The original plan is easily visible: it is drawn by the walls coloured in light grey (walls 1, 2, 3, 4, 5, 9, 10 and 11). It is made with 40 x 26 x 10 cm bricks that have a fine texture without straw inside.

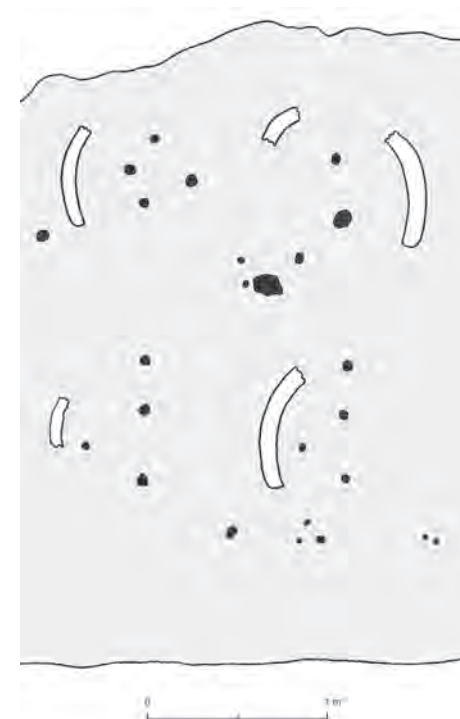

The study of the mud coats corroborates this plan: in II and VI they tie these original walls together (walls 4 and 6 on the one hand, 10 and 11 on the other), while in I, III, IV, V and VII they clearly separate them from those added later. The preserved walls are about 4 m high.

Some elements allow for reconstructing the missing walls of the ambulatory. In Fig. 8, in *b* and *c* the tips of walls 5 and 9 are not coated, and they are made with bricks that have a rougher texture, with pebbles inside like those of walls 6, 7 and 8. Walls 5 and 9 were as such very likely a single wall that was cut at *b* and *c* in order to build room E. In *d*, the mud-coat on the tip of the wall indicates that it ended there, while in *e* a break in this coat shows that the wall protruded here. From there, if we consider that the temple was symmetrical, then we can reconstruct the walls all the way to wall 10, as shown on Fig. 7. In *a* and *j* the mud coats are continuous: walls 4 and 11 had as such no protruding counterparts from walls 2 and 3.

There is a small wall in the assembly area that is not represented in the plan. This is usually said to testify to the existence the former inner *mchod rten* of the temple.<sup>4</sup> As its bricks are not directly observable, it is difficult to venture whether it is original or not.

The positions of the beams that once supported the roof of the assembly area are still visible: they correspond to the vertical recesses at the top of the walls. There were four of these, about 2.5 m apart (Fig. 8: indicated by the small grey triangles in wall 2; Fig. 9: indicated by the white arrows). These can be seen only on wall 2: the upper part of wall 3 was levelled (Fig. 9).

The roof of the ambulatory is more difficult to assess. Like wall 3, the tops of walls 5 and 9 were levelled, and, as the rest of the ambulatory wall is missing, no trace of a roof is left. If there was one, it could not have been lower than that of the temple: it would have otherwise required either a wall with a recessing profile (Fig. 10: *a*) or a wall with holes to fix the beams (Fig. 10: *b*)—the walls of the temple are straight and without holes. As such, if the ambulatory had a roof, the only possibility is that it was at the same height as that of the temple, as illustrated in *c* in Fig. 10.<sup>5</sup>

The external top of the entrance walls has small marks of a porch roof (Fig. 8: small holes on the upper part of wall 3). However, given the later development that took place in front of the temple (see below) one must remain cautious as to whether these marks are

original or if they are due to this later development.

There are two sets of halos visible on the walls of the assembly area, and a third inside the central cella.<sup>6</sup> The first set consists of a large halo on either side of the main door, at *h* and *i* in Fig. 8. They are 1.5 m wide (Fig. 11). The second set of halos is in *g*. It has four smaller halos, 80 cm wide, in two registers (Fig. 12). The lower halos seem to have had three vertical fixings with another one on the left near the halo. The holes of the upper halos are not as clear, they seem to have had fewer fixings spread in a different fashion. The elevation of the wall in *f* is missing: as such the existence of another four halos is a matter of speculation. A third set composed of at least one small halo can be seen on the back of the central cella (wall 1).

#### *Frontal Development: Space B and Chapel C*

In a second phase, a development took place in front of the temple with the construction of a large space (B) along with at least one lateral chapel (C) (Fig. 8). Another chapel was likely on the other side of space B, but, as we will see, in its current state it is not from the same period as chapel C.

As there is no direct relationship between walls 12-13 on the one hand and walls 14-15-16 on the other, it is questionable to state whether the development of space B is contemporaneous with that of chapel C. But the fact that they are made from the same bricks, and that walls 12-13 use special bricks shaped with a recess in order to fit a doorframe (Fig. 13) indicates that it was designed with a door right from the beginning. As such, chapel C is likely contemporaneous with space B.

Two elements in chapel C are worthy of discussion. First, an opening in the wall suggests that there was a narrow door about 80 cm wide leading outside of the chapel in *k*. The second element is that in *l* wall 14 has no external mud coat, whereas the rest of the wall does. These two elements raise the question of the existence of a former room there. Fig. 15 shows a possible reconstruction of this stage with the hypothesis of a chapel in D similar to that in C, and with the hypothesis of an adjacent room north of chapel C.

#### *Alteration of Chapel D*

If chapel D as it currently stands had been built at the same time as chapel C, it would likely have had the same floor plan, the same dimensions and the same bricks. Instead, it is quite the opposite: the layout is different, it is much smaller, and the walls are built with

<sup>4</sup> In his report from 1917, Gergan referred to it as a “broken clay throne with lotus leaves and rear wall” where “perhaps” the main cult image was located (see Jahoda, “Joseph Thsertan Gergan’s report on Nyarma, 1917”, this volume, p. 176).

<sup>5</sup> I would like to thank my colleague Martin Vernier with whom this question of the roof of the ambulatory was discussed.

<sup>6</sup> During my fieldwork, my main focus was to understand the chronology of Temple 1. As such, I did not closely record the traces of stucco halos on the walls. It is only at the request of Christiane Kalantari that I am describing those I documented in my notes: it is possible that other halos are to be accounted for.



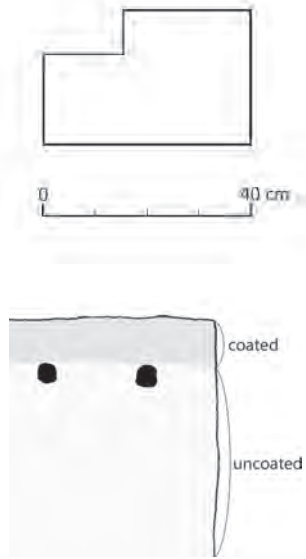

13. Temple 1: brick used for the door jambs of walls 12 and 13 (Q. Devers, 2012).

14. Temple 1: elevation of the rear wall of room E. The holes of the former beams are in black (Q. Devers, 2012).

15. Temple 1: reconstruction of space B, chapel C, possible room north of chapel C and possible original chapel D (Q. Devers, 2012).

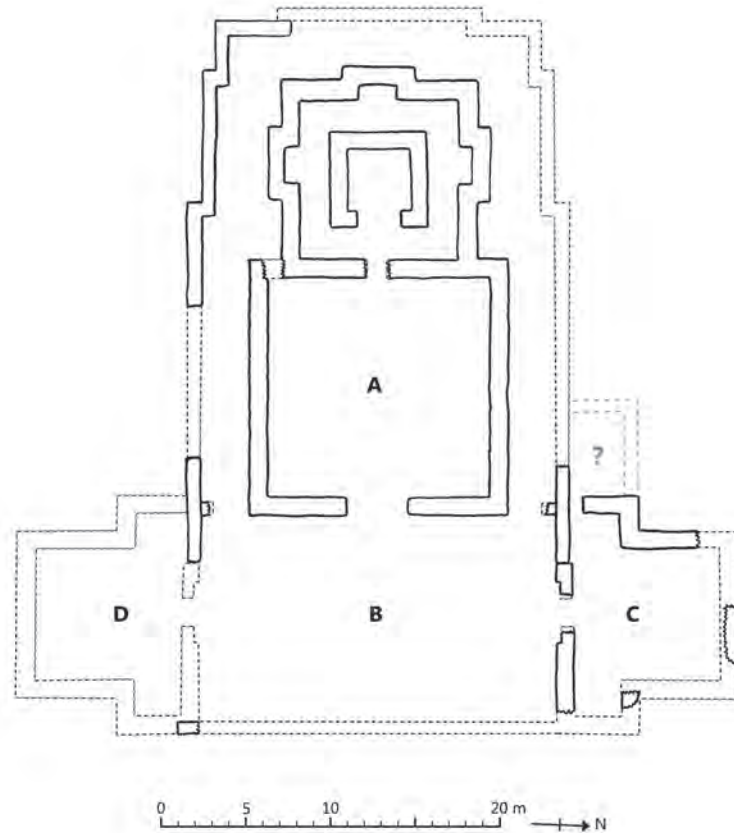

at least three different types of bricks. Indeed, wall 18 is made with bricks surprisingly larger, 42-45 cm long, wall 17 is made with bricks like those of chapel C but is only 75 cm thick, wall 21 has a unique thickness of 115 cm, is made with bricks that have a unique sandy texture, and it is the only wall that was built with timber lacing—in walls 19 and 20 no bricks are directly accessible to be properly measured. In addition, wall 22 is, as we will see, a true enigma.

In order to see into this structure more clearly it is necessary to examine the different elements separately.

Wall 17, with bricks of a texture similar to those used in the walls of chapel C, could have been built at the same time. However, with no direct visible stratigraphical relationship it is not possible to assert this definitively.

Walls 18 and 21 seem to be tied together by the coat in VIII. However, the drips of dissolved bricks there make the reading of the relationship between the two walls difficult and open to debate. Even if the mud coat between these two walls is the same, they were

still clearly not built at the same time: they are far too different, with different bricks, different thicknesses, and even different techniques, as wall 21 featured timber lacing.

A relationship between walls 20 and 21 is difficult to assert as a mass of dissolved bricks separates them, but they are probably from the same state.

As for wall 19, it is the same thickness as wall 18 and, from what is visible, its bricks seem to be larger than 40 cm: as such it is probably the continuation of wall 18.

An element in favour of an original chapel similar to chapel C is the position of the door. As it is now, it is not centred: it is closer to the right-hand wall, creating a right/left asymmetry. However, if we reconstruct a layout similar to chapel C, then the door is exactly at the location where it would have been.

As we will see, the modifications of chapel D have to be considered in relation to the construction of Temple 2. Indeed, if it was originally similar to chapel C it would have overlapped with Temple 2 (Fig. 17).

Wall 22 is the most bewildering in the complex. With its length of about 1 m, it is more of a wall fragment. It is slightly inclined: it lies against wall 17. It has no mud coat, and at 42 cm long and 30 cm wide its bricks are both longer and wider than those of the other walls. Its thickness is not constant: it decreases as the height of the wall increases. Two bricks thick at the base, it is about only one brick thick at the top. No further trace of it can be observed on the ground around: it is as if this wall never went farther than the metre it currently stretches. Its function and former layout are quite enigmatic.

With these elements, the following chronology can be proposed:

- In a first step, a chapel similar to chapel C was likely built along with temple B. Wall 17 is the last testimony to this development.
- Then, for some reason, the chapel underwent two modifications that led to the construction of walls 18-19 on one hand and walls 20-21 on the other.
- As for wall 22, it is an open question to why it ended there and what its function was. The only element that can be stated is that it was built after walls 17 and 21.

#### Room E

As seen earlier, the section from wall 5 to 9 was dismantled for the construction of room E. As there is no direct stratigraphical relationship with the other walls of B, C and D, it is not possible to relate its construction to the other later developments of Temple 1. As it stands now, the room has undergone at least one change since its construction. Originally made of apparently unchained walls, it is coated outside but not inside. Rear wall 7 has a line of holes: above it the wall is coated, below it is not (Fig. 14). These holes are probably

those of the timbers of the original roof: the upper part of the wall was coated as it was outdoors, while the lower part was not. This roof was then destroyed or dismantled, before being rebuilt along with new parting and entrance walls.

### Temple 2

Temple 2 is immediately south of Temple 1 (Figs. 16 and 20). It has the thickest walls of the complex, which are 125 cm. They are made with bricks that are 45 x 26 x 10 cm—some are 45 x 20 x 10 cm. Its porch was roofed with one large transversal beam as indicated by a large recess on the left wall, and a series of smaller beams as the profile of the exterior entrance walls show. The doorjambs of the entrance wall were straight, accounting for a straight doorframe.

Inside, the walls of the assembly area have a series of small holes closely spread in line about half way above the current ground (Fig. 18). The holes on the entrance walls are slightly lower. The lateral walls of the rear niche have two parallel lines of small holes: one about half way, and one near the top of the wall (it can be seen on Fig. 16). The rear wall has an upper line of small holes only on its right third (Fig. 19). The walls of the rear niche are higher than those of the assembly area: they are 5 m rather than of 3.7 m. The positions of the beams that once supported the roof are not clearly visible, except on the rear wall where there used to be two beams about 4 m apart and 2.5 m from the lateral walls.

This temple does not have an external mud coat. According to Kozicz, “the most proper explanation would be it had never been finished” (2007b: 4). Though it is true that they rarely miss external coat, temples do not necessarily need to have one in order to be functional. As we will see later, one ruin of temple in the area between Nyarma and Thikse, which has no reason to be considered unfinished, also lacks external mud coat.

The western wall of the porch of Temple 2 is only a few meters away from the rear wall of chapel D (Fig. 17). If in its original state chapel D had the same layout and size as chapel C, then its rear wall and Temple 2 would have overlapped.

This raises the question of the chronology between chapel D and Temple 2. To sum up, there are four events that took place, given here in a non-chronological order:

- a) Construction of original chapel D.
- b) Modification of chapel D, which saw the construction of walls 18-19.
- c) Modification of chapel D, which saw the construction of walls 20-21.
- d) Construction of Temple 2.

In the current state of research it is impossible to know the exact



16. Temple 2 from the hill temple complex (Q. Devers, 2011).



17. Temple 1: possible reconstruction of original Chapel D in relation to Temple 2 (Q. Devers, 2012).

18. Temple 2: right-hand wall of the ambulatory area (Q. Devers, 2009).



19. Temple 2: rear wall (Q. Devers, 2009).



sequence in which these events took place. Indeed, even stating that Temple 2 was built after the original chapel D is speculative. For instance, we could imagine that Temple 2 was built just after Temple 1. In that case, when the development in front of Temple 1 took place, the two lateral chapels would have been built in different sizes: one on the northern side, which would have been larger as there was space there for building a large chapel, and one on the southern side, which would have been smaller because of the constraint of space imposed by Temple 2. Then, at some point, some problem could have led to the reconstruction of walls 18-19, followed by another problem leading to the reconstruction of walls 20-21. In this scenario we would have exactly the same remains as those currently observable.

As such, the only sequence that can be established is that events b) and c) happened after a). Then, the construction of Temple 2 (event d) could have taken place at any point before or after any of these events.<sup>7</sup> And in the absence of excavations, events b) and c) could have happened in any order.

#### Temples 3 and 4

Though facing each other and looking as two coherent parts of a same whole, Temples 3 and 4 were probably not built at the same time (Fig. 21). Indeed, while Temple 3 is built with large bricks that are 45-47 x 26 x 10 cm, those of Temple 4 are 40 x 26 x 10 cm.

<sup>7</sup> For all we know, Temple 2 could even be older than Temple 1. As far as material evidence is concerned, nothing proves that Temple 1 was necessarily the first one built in the area.

The walls of Temple 3 (Fig. 22) are built in two different thicknesses: the entrance wall is 90 cm thick, while the other walls are 82 cm—they are 4.2 m high. The roof used to be supported by two beams 3.4 m apart, 2.3 m from the entrance and rear walls. There are no apparent traces of stucco halos or fixation holes. The door jambs are not straight: they are wider on their upper parts, indicating for a particular type of door frame that used to fit there, different from that used in Temple 2. As can be seen on Fig. 21, one *mchod rten* is built against its right wall. The wall of the temple is not coated where the *mchod rten* is: the latter was as such not built after Temple 3. The temple was either built against this existing *mchod rten*, or both were built at the same time. To sort this chronology one would need to see whether the *mchod rten* is coated on the side touching the temple: if it is, then it means that it was finished before the temple was constructed, if it is not then both the temple and the *mchod rten* were likely built at the same time. When I conducted my field survey, the drips of dissolved bricks prevented me from seeing whether the *mchod rten* was coated. Temple 3 is currently used to store various materials, such as long wooden sticks whose pressure against the walls tends to damage the internal mud coat.

Temple 4 (Fig. 24) is the smallest of the temples still standing in the complex and has the thinnest walls—only 70 cm thick. It is one of only three temples in all Ladakh with a plan with three niches—the other two are the famous three-storied temples in Alchi Choskor and in Wanla, leaving this one as the only single-floored example (Devers, forthcoming).

Its walls do not exhibit clear signs of stucco halos or of fixation holes, except maybe for one hole that goes right through the rear

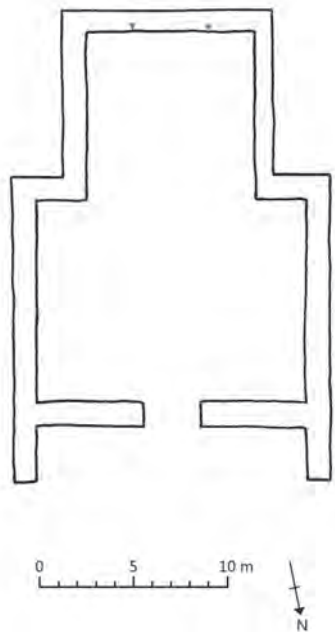

20. Plan of Temple 2 (Q. Devers, 2012).

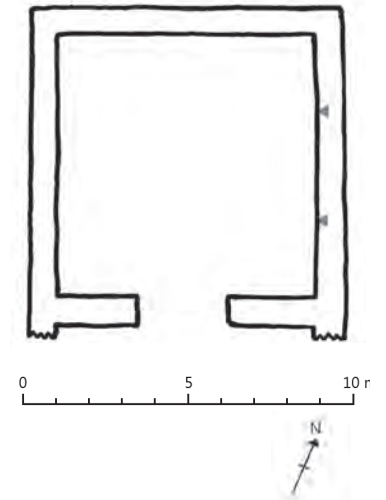

21. Temples 3 (right), Temple 4 (middle) and Temple 5 (left) from the hill temple complex (Q. Devers, 2011).

22. Plan of Temple 3 (Q. Devers, 2012).

wall. The door jambs are larger towards the top, as in for Temple 3. Some type of low podium ran along the walls (Fig. 23).

#### Temple 5

Temple 5 is the southernmost in the complex (Fig. 21 and 26). Its walls are 90 cm thick, built with bricks that are 40–42 x 26 x 10 cm. The porch shows signs of the beams of its former roof both on the side walls and on the entrance walls. In addition, a series of vertically aligned small holes can be seen in the left corner (Fig. 27). The door jambs are straight. The roof of the assembly area was supported by two beams about 3 m apart, 2.6 m from the entrance wall and 3 m from the rear wall. The rear niche, which has walls 5.9 m high rather than 4.6 m for the assembly area, appears to have had one beam. The inner walls do not show clear signs of stucco halos or of fixation holes. The access to the two closed rooms on each side of the rear niche (A and B on Fig. 25) is open to question: the room on the right

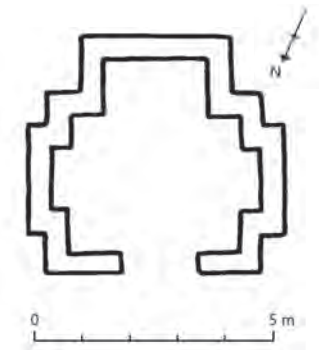

23. Temple 4: low podiums running along the walls (Q. Devers, 2009).

24. Plan of Temple 4 (Q. Devers, 2012).

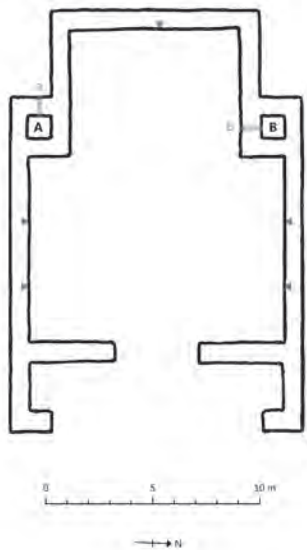

25. Plan of Temple 5 (Q. Devers, 2012)

26. Temple 5: *mchod rten* inside the rear niche (Q. Devers, 2009).

27. Porch of Temple 5 (Q. Devers, 2009).



can be seen only through a hole in the wall in *a*, while one on the left can be entered only through a hole at the base of the wall outside in *b*. As of now it is not possible to state whether these holes are original or if they were added later on, raising the issue of whether the interior of these rooms was designed to be accessed or even seen.

A *mchod rten* is in the middle of the rear niche. As can be seen on Fig. 26, this *mchod rten* is made of stones that were apparently left uncoated and as such undecorated. This element is somewhat surprising and opens the question of the dating of this *mchod rten*: is it contemporaneous with the temple or was it built afterwards?<sup>8</sup>

#### Enclosure

Only small sections of the enclosure that once delineated the complex are still preserved on the eastern and southern sides. They are 70 cm thick, built with bricks 40 x 26 x 10 cm. They are mainly uncoated on both faces, except in two, maybe three, places as indicated in Fig. 6 (sections indicated with *a*, *b* and *c*). Furthermore, in *b* and *c* additional elements indicate that structures were likely constructed there.

In *b*, the wall has a small recess at its base, which is not due to a recent removal of bricks as its coating indicates (Fig. 28). The coat on this section, which is a little over 5 m long, does not go all the way to the top of the wall, it stops somewhere above the middle of the elevation.



28. Enclosure: recess at the base of the wall in *b*, 0.6 m wide and 0.3 m high (Q. Devers, 2009).



In *c*, the section of the wall that is coated also has a different profile, with an upper half that is thinner, as indicated in Fig. 6. This section is about 4 m long, but it is not complete, as the wall is broken on its southern end. The function of the coat of these two sections and of their recesses is open to question.

#### General Observations

The door jambs of the temples have two shapes: they are either straight or with a recess making them wider towards the top. Fixation holes can usually be seen on them: a study of them could possibly enable a reconstruction of the type of door frame that was used. Finally, the door jambs are always uncoated, showing the importance of wooden door frames the presence of which made coating unnecessary. In the temples that do not have such frames, such as the small hill temple and temples 2 and 3 between Nyarma and Thikse, which we will see further below, the door jambs on the other hand are duly coated.

The thicknesses of the walls seems directly related to the size of the temples, and more specifically to the span of the roof. As such, the smallest temple has the thinnest walls (Temple 4 has a span of less than 5 m and walls 70 cm thick), while the largest temple has the thickest walls (Temple 2 has a 14.4 m span and walls 125 cm thick). The other temples also fit in this scheme: Temple 3 has a 7.8 m span with walls 82 cm thick, Temple 5 has a 12 m span and walls 90 cm thick, while Temple 1 has a 13 m span and walls 100 cm thick.<sup>9</sup>

<sup>8</sup> For example, it is conceivable that it was built when the site was being abandoned, to bury sacred objects that were not being carried elsewhere, such as pieces of broken statues or other broken sacred objects. Other such explanations could well explain a later origin for this inner *mchod rten*.

<sup>9</sup> After measuring bricks in all types of ruins throughout Ladakh, I could see that their dimensions are highly irregular. In length, bricks vary from 24 to 52 cm;

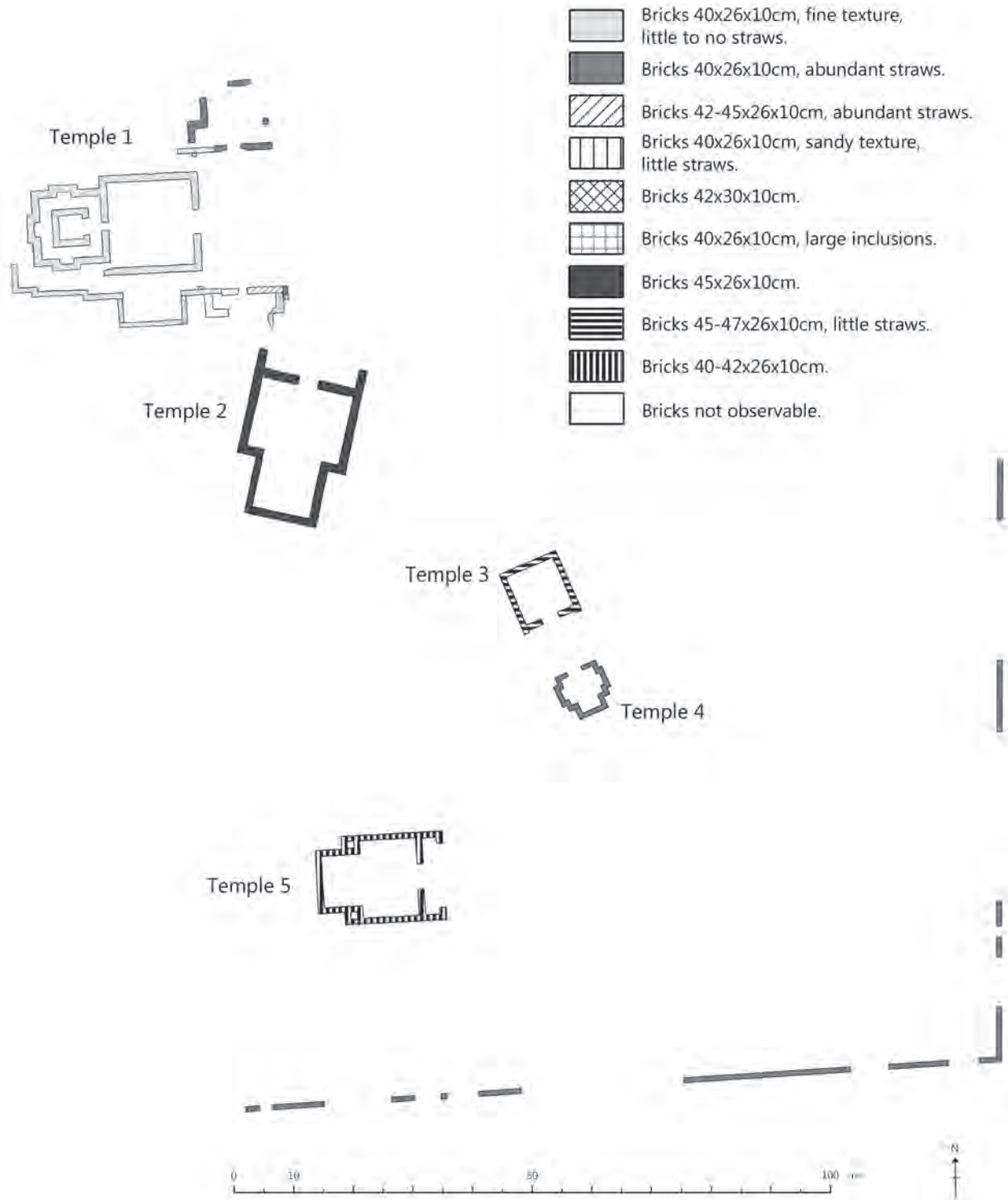

29. Walls of the main complex coloured according to their type of bricks (Q. Devers, 2012).



30. The fort (indicated by the red arrow in the foreground) and the small square structure at the other end of the rocky formation (indicated by the upper red arrow), with the monastery of Thikse in the background from the south-east (Q. Devers, 2011).

### The Fort

The fort of Nyarma (Figs. 30, 31 and 32) was described by Howard in his article on the fortifications of Ladakh (Howard 1989: 269–271). As such we will proceed only to a brief general description be-

in width, from 13 to 35 cm; in thickness, from 7 to 15 cm. I came to notice that in order to understand them, one should not look at their absolute dimensions, but instead at the ratio between the length and the width. Three groups can thus be distinguished: 1) bricks with a length-width ratio under 1.7 appear characteristic of monuments built before the fifteenth century; 2) bricks with a ratio between 1.7 and 2.2 seem to have been used during all periods; 3) those with a ratio of 2.2 or above appear to have been used only after the fifteenth century. For a full history of Ladakh, another size can be added: contemporary bricks have a square section—width and thickness are equal. See Devers 2016 for a more detailed account of bricks.

From the results of the study I conducted for my dissertation, in the complex of Nyarma (see Fig. 29), all the bricks belong to the first group with ratios under 1.7, except for those of Temple 2 that have a ratio of about 1.8. If the proposed categorisation is correct, this means that Temple 1, 3, 4, 5 and the enclosure were likely built before the fifteenth century, while Temple 2 could have been built at any time.

fore reviewing its roofing technique and chronology in greater detail.

The rear of the main building consists of a tower (level +3) that appears to be D-shaped—not round as described by Howard (*ibid.*: 269)—the upper elevation of which is made of bricks reported by Howard as being 40 x 25 x 10 cm (*ibid.*: 269). In front of the tower is a succession of narrow rooms (level 0). An enclosure delineates an open space in front of the buildings with two entrance structures (A and B), while two spaces are delimited by more recent walls on the western side (C and D).

The layout of the rooms of level 0 is dictated by the technique used for the roof. Culminating at 3.1 m above the ground in the front rooms, it is made only of stones (Fig. 36). It is built with a technique based on three structural levels: a first level of spaced corbels supports a second level of stones bridging the distance between the two facing walls, while the third level is made of transversal stones that cover the remaining space (Figs. 33 and 35). This technique is the most widely encountered in stone-roofed structures in Ladakh. It imposes particular constraints on the design of the buildings: the rooms cannot be more than 1 m to 1.5 m wide in order to have walls close enough to be bridged by the stones of the second level. This conception of space applied to multiple rooms can also be observed in the Kadam *mchod rten* in Stok (Fig. 34). Beyond Ladakhi frontiers, stone-roofs are a main feature in ancient buildings of Upper Tibet, where they can attain important expressions (cf. Bellezza 2008: 32–37).<sup>10</sup>

The two entrance structures A and B were also stone-roofed: structure A has only its corbels left, while structure B has its high stone-roof intact. It is made of a single level of lintels that directly bridge the space, except for the middle stone, which rests on corbels (Fig. 33).

The walls of spaces C and D are later additions. They use more mortar than the main building, and some shards of ceramics can be seen in it, as was observed by Howard (1989: 269). Another clear indication that the walls of space D are later additions are the stone corbels protruding from the main building (Fig. 33): there are no similar corbels protruding from its facing wall, and no stones can be found fallen on the ground. This means that the roof that used to rest on the corbels protruding from the main building was dismantled at some point and that the facing wall that had been built with stone

<sup>10</sup> In some sites bridging stones can be as long as 2 m (Bellezza 2008: 33), and among unique examples is the large lantern-like ceiling at gZims phug (*ibid.*: fig. 1, p. 33) and the no less than three-storey high tower at Thophu, which uses stone ceilings for all three levels (personal communication, Nov. 10, 2010).

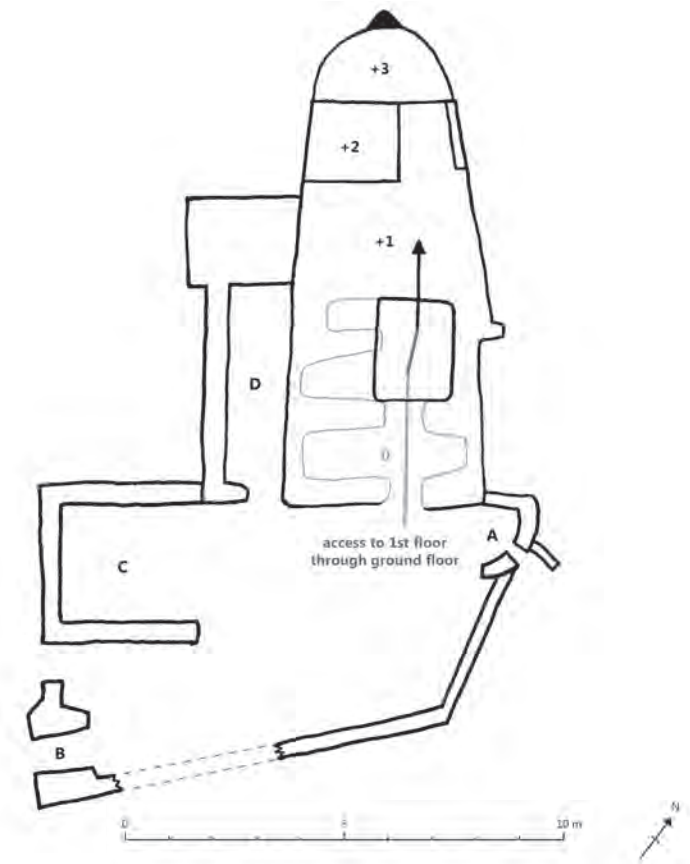

corbels was either destroyed or dismantled before being replaced by the current one. This restored space D was then either left open or roofed with wooden beams resting on the corbels of the main building on one side, and on top of the new wall on the other.

Finally, the walls of space C were built after those of space D, as they lie against them. Another larger entrance to the site was likely open then, delineated on one side by the wall of space C and on the other by the former entrance B.

In large buildings, this type of stone-roof is undoubtedly ancient. The main reason is the constraint of layout it imposes: rooms need to be very narrow. However, this type of roofing had a more perennial use in smaller structures, in which rooms did not need to be more important, the most common of which were the *mchod rten*. This longer use in smaller structures is also noted by Bellezza in Upper Tibet (Bellezza, personal communication, Nov. 10, 2010).

To understand further the antiquity of this fort, one can look at two sites. The first, taken in the corpus of fortifications, is the castle of

Wanla. From its woodcarving, this can be dated roughly to the same period as the three-storied temple near it, i.e. to the late thirteenth or early fourteenth century (Luczanits 2005: 89, Martin 2015). One can appreciate the radical difference in design. There is an abundant and ostentatious use of wood for roofing three stories (instead of one), for timber lacings, for woodcarvings and for balconies.

The second site to bear in mind is in the complex of temples just below the fort: this is Temple 1. Datable to the eleventh century through its supposed foundation by Rinchen Zangpo, it was already making important use of wood to span no less than the 13 m of the assembly area, showing that, if needed, wood could be obtained in this village at that time.

The use of wood in these two sites shows the radical difference in design from the fort at Nyarma, and gives an idea of its greater antiquity.<sup>11</sup>

<sup>11</sup> For more details about the evolution of fortifications in Ladakh, see Devers 2016.

31. Fort viewed from the hill temple complex (Q. Devers, 2011).

32. Sketch plan of the fort. It is built on four levels, indicated by the numbers (Q. Devers, 2012).



33. Plan of the stone roof of the fort: the corbels and the lintels are viewed from underneath, looking up (Q. Devers, 2012).

34. Plan of the stone roof of Kadam *mchod rten* in Stok: the corbels and the lintels are viewed from underneath, looking up. Drawn after the original floor plan made by the Tibet Heritage Fund in 2011 (Q. Devers, 2012).

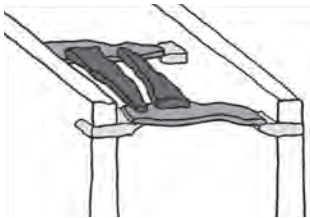

35. The three structural levels of the stone roof in the fort: corbels (light grey) support lintels (mid-grey), supporting in turn another level of lintels (dark grey) (Q. Devers, 2012).

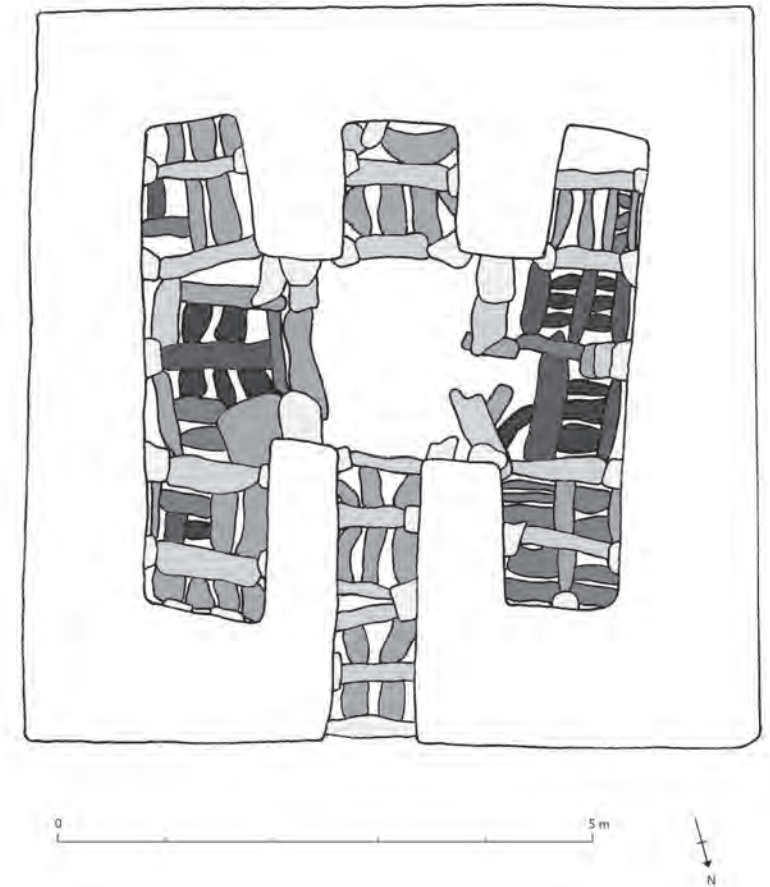
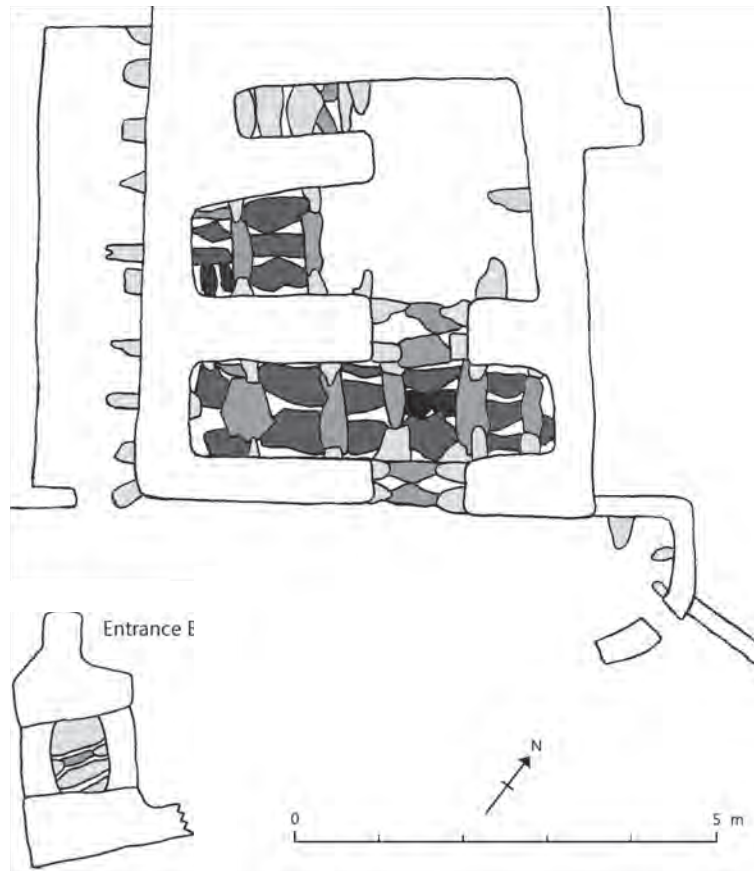

36. Stone roof in the fort (Q. Devers, 2009)

37. Small square structure at the other end of the rocky formation viewed from the north-west (Q. Devers, 2009).



At the other end of the rocky formation on which the fort stands are the ruins of a small square structure covered with prayer flags (Fig. 37). It would be hazardous to venture the nature of this ruin. One possibility is that it was a watch post linked to the fort: as there is no view downstream from there towards Thikse and Shey it could have been an intermediary watch post as the eyes of the fort.

Down the hill, amidst the ruins of the former village there is a very weathered stela, while to the west, near the pond are four other stelae—three lie against a *mani* wall, one is on top of it (Fig. 38a-e; see also Fig. 3 for the location of the stelae). They are (width x height) ca. 98 x 130 cm (a), ca. 70 x 120 cm (b), ca. 68 x 113 cm (c), ca. 60 x 90 cm (d) and ca. 27 x 86cm (e).<sup>12</sup>

<sup>12</sup> The author is currently working on a comprehensive account of Ladakhi Buddhist stelae and rock reliefs with Laurianne Bruneau and Martin Vernier.



38. Stela amidst the ruins of the ancient village (a) and the three stelae against (b, c, d) and standing on (e) the *mani* wall (a: Q. Devers, 2012b; b, c, d, e: Q. Devers, 2009).



39. The hill temple complex from the south (Q. Devers, 2011).

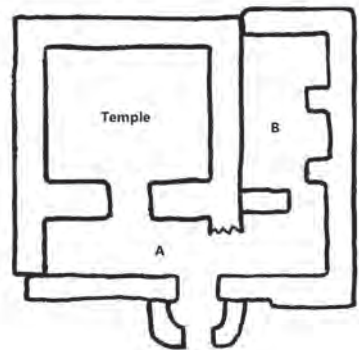

40. Sketch plan of the hill temple complex (Q. Devers, 2012).

41. Plan of the hill temple (Q. Devers, 2012).

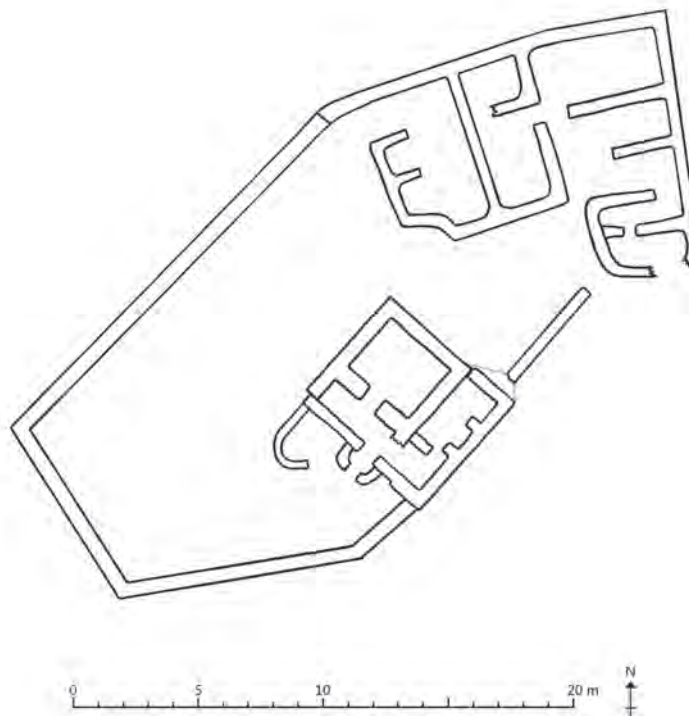

### The Hill Temple Complex

The small temple complex on the hill to the east of the main complex has so far received little attention (Fig. 39, Fig. 40). However, in my opinion it is an important site, the study of which could potentially shed exclusive new information on the history of Nyarma. The hill is covered with several structures, including a temple, a series of small rooms and several *mchod rten*.

Two to three stages can be observed in the temple (Fig. 41). The first corresponds to the construction of the temple itself. It is very small, only 2.6 x 3.2 m. The door, with a stone lintel, is also very narrow, only 80 cm wide. The walls, 2.6 m high, are of stone masonry. In a second step, a wall was built around the temple on its south-eastern and south-western sides. This creates two distinct spaces, A and B. The floor of space A is at the same level as that of the temple, while the floor of space B is one level above it. The external coat of the temple in B was either removed or never existed. Finally, in what seems to be a third step, an additional structure was built at the entrance with two walls protruding from the building, reducing the doorway to only 60 cm in width.

The sort of corridor created by space A is only about a metre wide. The corridor-like space B is slightly wider, about 1.8 m, but it features two buttresses protruding from the wall, reducing the distance to the temple to only a little over a metre. The distance between these two buttresses is 1.1 m. These lead to consider the possibility that spaces A and B were originally roofed with bridging stones, the metre being the key distance for the use of this technique in other edifices. However, no stones can be seen on the floor, so this possibility has to be treated with caution.

North of the temple are the ruins of several rooms (Fig. 42). Some parts still have the stones of their roof. The technique used is the same as that in the fort, with three levels of corbels and bridging stones (Fig. 43). The ceilings are low, only 1.2 m high. The rooms used to be coated, as can be seen in the spaces still roofed.

Several elements are surprising in this complex:

- The temple is of stone masonry while all the other temples of the main complex down below are strictly brickwork.
- The door to the temple has a stone lintel—the only temple ruin I surveyed in Ladakh that clearly has one (the only others may be Temples 2 and 3 between Nyarma and Thikse, but their lintels are not directly visible).
- The rooms behind the temple are stone-roofed.

These points raise the question of the dating of this small complex. Its overall design and the material used are radically different from what can be seen in the main complex. Instead, these create more parallels with the fort. In that way, the possibility that it could

predate the complex founded by Rinchen Zangpo has to be considered. The local tradition says that the Translator used to meditate on this hill. If there is any truth to this, could he have come to meditate in an already established Buddhist installation? The answer to this question can potentially provide important new elements in the study of Nyarma and of Buddhism in Ladakh in general.<sup>13</sup>

### From Nyarma to Thikse

North of the rocky formation on which the fort stands, in the direction of Thikse, are several ruins of ancient temples (Fig. 3). By their proximity to the structures described so far they can be considered as being part of the archaeological environment of Nyarma. For this reason, I have chosen to include their description in this paper.

#### Temple 1

This stands immediately after the rocky formation (Fig. 44 and 45). Built of some of the longest bricks I have measured in Ladakh—52 x 22 x 10 cm—its walls are quite thin compared with those of the main complex: they are only one brick thick, i.e. 55 cm when adding the thickness of the mud coat.<sup>14</sup> They are 4.9 m high. The shape of the door jambs is not visible, both having deteriorated. The right half of the porch is marked with a line of small holes on the entrance and side wall (Fig. 44). The roof of the temple was supported by one main beam in the middle of the side walls. There are still stones in the recesses into which the timber used to fit, protecting the bricks from the pressure it created. These stones show the width of the former

<sup>13</sup> Indeed, while the large corpus of Buddhist stelae and of rock carvings of *mchod rten* found throughout Ladakh point to the presence of Buddhism in Ladakh before the “Later Diffusion of Buddhism” (for an excellent summary see “Le *stūpa* au Ladakh” by Bruneau 2010: 266–286), the earliest temples known so far are only from this “Later Diffusion”. It would not be a big surprise if one or more of the ruins of temples scattered across Ladakh was found to predate Rinchen Zangpo.

<sup>14</sup> This wall thickness is probably the reason for the unusually long bricks: indeed, the thickness of walls determines the type of bond that can be used. In this way, a wall can only be the thickness of one brick length or of one brick length plus one brick width; no in between variation is possible. As such, if the builders were intending to build a wall of this precise thickness, they had only two choices: to mould bricks in the length of which was just the thickness of the wall, or to mould bricks in proportions that one length and one width would equal the thickness of the wall. In this case the former solution was chosen. Fig. 50 shows a comparison of the different walls described in this paper and their brick bonds. One can see the different bonds used according to the thicknesses of the walls. It can be noticed that when the walls are just two lengths of brick thick the builders did not know how to chain the rows of bricks together: in one case they push the bond used for thinner walls to its limits where the stretchers no longer overlap, on the other they do not even alternate them with headers—the bricks are only laid as two piles of stretchers side by side.

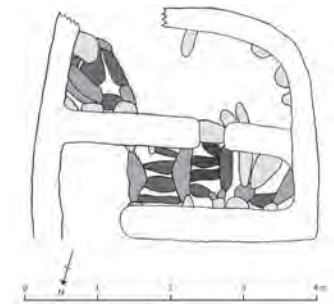
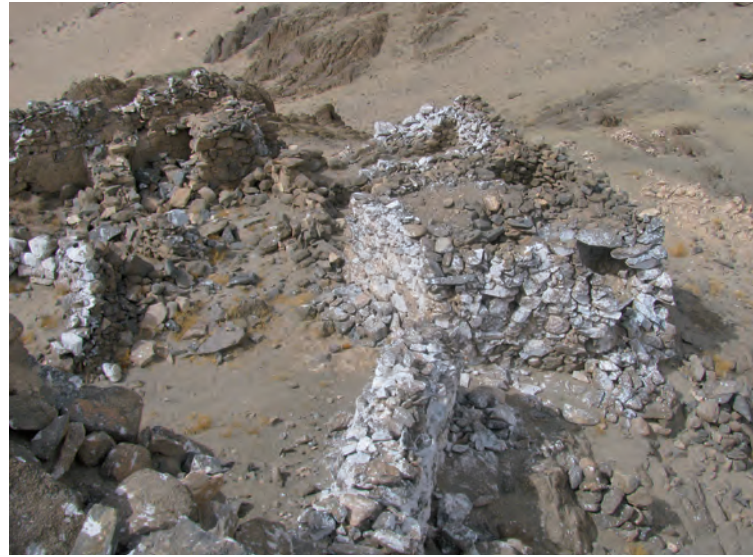

42. Rooms behind the hill temple viewed from the temple (Q. Devers, 2011).

43. Plan of one of the room's stone roof: the corbels and the lintels are viewed from underneath, looking up (Q. Devers, 2012).

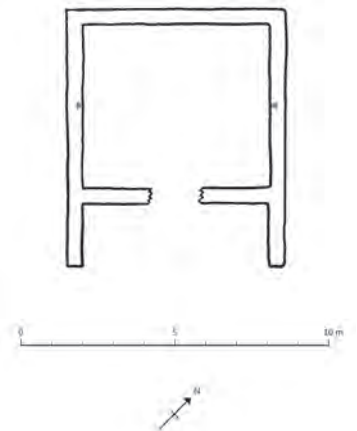

45. Thikse-Nyarma: Temple 1 from the south (Q. Devers, 2009).

44. Thikse-Nyarma: plan of Temple 1 (Q. Devers, 2012).

beam: about 50 cm. The walls do not have clear marks of stucco halos or of fixation holes.

Compared to the brick walls of the other temples described in this paper, the relative thinness of the walls of Temple 1, while there is still a 6 m span denotes a technique and custom of construction that differs from the other temples. This may be a sign that this construction is from a later period.<sup>15</sup>

This temple is currently used to enclose Dzos (*mdzo*) when need-

<sup>15</sup> If the categorisation of bricks mentioned in a footnote above is correct, this later dating is corroborated by the ratio between the length and the width of the bricks, which in this case is 2.3.



46. Thikse-Nyarma: Temple 2 and Temple 3 from the south-south-west (Q. Devers, 2010).

47. Thikse-Nyarma: door of Temple 2 (a) and 3 (b) (Q. Devers, 2010).

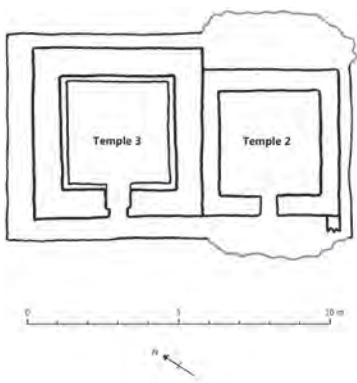

48. Thikse-Nyarma: plan of Temple 2 and Temple 3 (Q. Devers, 2012).

ed. Following the footpath to Thikse, about 300 m away, are three small painted *mchod rten*, on which Kozicz (2007c) has published.

#### Temples 2 and 3

About 180 m further north-west of these *mchod rten* are the ruins of two temples side by side. Built on a raised platform—1.3 m at its highest point—they are both made in stone masonry (Figs. 46 and 47).

Temple 2 is the least well preserved; its walls are falling to pieces. Due to their degradation, their thickness is now variable, from 50 cm to 70 cm, for a height of 2.2 m. Except for the front façade, the walls do not have an external mud coat. Its door is very narrow and low—only 55 cm wide and 1.15 m high. Its frame is decorated with four successive recesses, the outermost of which is T-shaped (Fig. 47[a]). Its intact mud coat conceals the material used for the lintel of the door. Only one small porch wall protrudes on the right: made of bricks, it is possibly a later addition. However, from the side one can see one long stone sticking out from the masonry to penetrate into the bricks: this may be an indication that although it is made of brick it is contemporaneous with the temple (Figs. 48 and 49).

Temple 3 is coated both inside and outside. It has the particularity of having an additional inner brick wall built against the outer stone wall. This brick wall is a later addition, as the internal coat of the stone wall shows. The inner brick-wall is only 21 cm thick, made of bricks that are 40 x 20 x 8 cm. It has the marks of the single beam that used to support the roof. The stone walls are 90 cm thick and 2.8 m high. The door is also very small, though a little bigger than that of Temple 2: it is 75 cm wide and 1.25 m high. The door frame is decorated in a similar way, with four successive recesses and a T-shaped outer one (Fig. 47[b]). Similarly, its intact coat makes it impossible to see which material has been used for the lintel.

Both temples are small: their inner spaces are about 3.4 x 3.4 m. The relative chronology of these two temples is difficult to assess. One would need to see whether the right-hand wall of Temple 3, which is side by side with the left-hand wall of Temple 2, has an external coat: if it does it would mean that Temple 3 was built before Temple 2; if not then it is most likely that Temple 2 is the earliest.

Several characteristics separate these temples from the other temples presented in this paper, and more generally from the ruins of temples recorded throughout Ladakh, which are:

- The raised platform: none of the ruined temples of this area are built on one.
- The decoration of their door frame, which is not encountered elsewhere.
- The reduced size of their door.
- Their stone masonry

To these characteristics one can add their orientation: they face south-west, like the temple on the hill above the main complex. Instead of an absolute direction, these temples could be seen as being oriented towards the Indus river—several early temples with such orientation appear to be linked to older funerary sites (about

Thikse - Nyarma Temple 1  
(55cm)

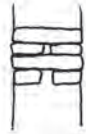

**One length of brick thick**

Temple 4 &  
Enclosure  
(70cm)

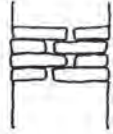

Original Temple deambulatory walls  
& Space B  
(75cm)

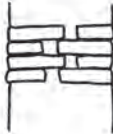

**From one length and one width of brick thick  
to two lengths of brick of thick**

Temple 3 side and back walls  
(82cm)

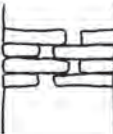

Temple 3 entrance walls  
(90cm)

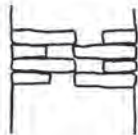

Chapel D wall 18  
(90cm)

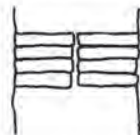

**Two lengths  
of brick thick**

Temple 5 &  
Thikse - Nyarma Temple 4  
(90cm)

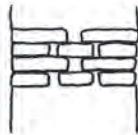

**Over two lengths of brick thick**

Original Temple  
& Chapel C  
(100cm)

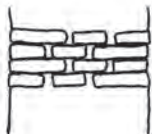

Chapel D wall 21  
(115cm)

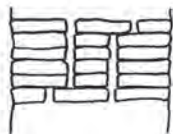

**Over two lengths and one width of brick thick**

Temple 2  
(125cm)

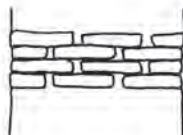

49. Thikse-Nyarma: Temple 2 from the south-east. The porch wall in bricks can be seen on the left, with a stone in the middle that sticks out of the masonry to penetrate into it (Q. Devers, 2010).

50. Brick bonds of the profile of the walls categorised by thicknesses (Q. Devers, 2012).



51. Thikse-Nyarma: Temple 4 from the south-west (Q. Devers, 2009).

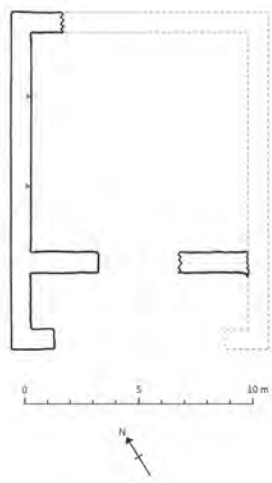

52. Thikse-Nyarma: plan of Temple 4 (Q. Devers, 2012).

the orientation of temples in Ladakh until the mid-fifteenth century, see Devers, forthcoming). Their dating would probably be a subject of interest, potentially providing complementary information on the history of the area by seeing how they are positioned chronologically in relation with the hill temple and the main complex.

#### Temple 4 “Kiki *lha khang*”

About a hundred metres to the north-west is the ruin of Temple 4, said to be called “Kiki *lha khang*”. It is in a very bad state of conservation, with only its entrance and left walls still standing (Figs. 51 and 52). These are 90 cm thick and 5.2 m high. Their bricks are highly irregular, varying from 40 cm to 47 cm in length, with a width and a height of 26 cm and 10 cm. The door jambs are straight. The roof of the temple was supported by two beams 4 m apart, 2.8 m from the entrance and rear walls. Given its state of preservation, the holes in the walls are difficult to interpret as being fixation holes for statues or simply as normal marks of degradation. Like Temples 2 and 3, it faces south-west.

To the west, at the edge of the vegetation, there is a collapsing *mchod rten* (see also Kozicz 2007a, 2011 (Nyarma Northern Section:

Stupa with the Hidden Chamber) and Devers et al. (2014). It has a constructional feature of interest to us: like Temple 3, it has an internal brick wall built against the original outer stone wall.

#### Conclusion

Carrying archaeological work only from ground observations, without excavation, is always a difficult task. In Ladakh it is made more laborious by the absence of existing studies with dated material. Indeed, in other places archaeologists can date shards of ceramics gathered on the surface just by examining them. When they observe standing buildings, they can form a fair idea of their date through their different architectural features: the objects and structures they study fit into defined chronological frameworks. In Ladakh this is not possible: the chronological frameworks are still to be constructed.

In this study, relative chronologies between elements were established whenever possible using the methods developed by the discipline of the archaeology of buildings. However, when there are no physical contacts that make it possible to establish stratigraphical relationships, the task was to observe the characteristics and compare them in order to create groups that share similar traits. Hopefully, in the future the chronology will also be revealed when proper lab dating can be carried out.

In this process, the following groups were outlined. The oldest structure is probably the little fort, whose design evokes ancient construction customs without wood. The hill temple complex and the two small temples side by side between Nyarma and Thikse have characteristics that bring them closer to the fort than to the other temple ruins. Surprisingly, the rooms behind the hill temple are stone-roofed, while the temple combines a reduced size, stone masonry and a stone door lintel. The two small temples between Nyarma and Thikse, on their raised platform, share similar characteristics. Here we probably have a group of early Buddhist temples, possibly predating the foundation of Rinchen Zangpo—but only carbon dating can determine this. The third group is formed by the temples of the main complex, to which should be added Temple 4 between Thikse and Nyarma. Though probably all erected at different times, they are built in similar ways, with some coherent fashion as for the thicknesses of the walls in relation to their size. Finally, following this distinction, Temple 4 between Nyarma and Thikse seems to conform to a different type of construction custom, and probably belongs to a later development.

It is now to be hoped that the on-going study of the other archaeological remains of Ladakh will lead to the refining of this tentative chronology, and that series of lab datings will help to anchor it in time.

53. Comparison of the different temples (Q. Devers, 2012).

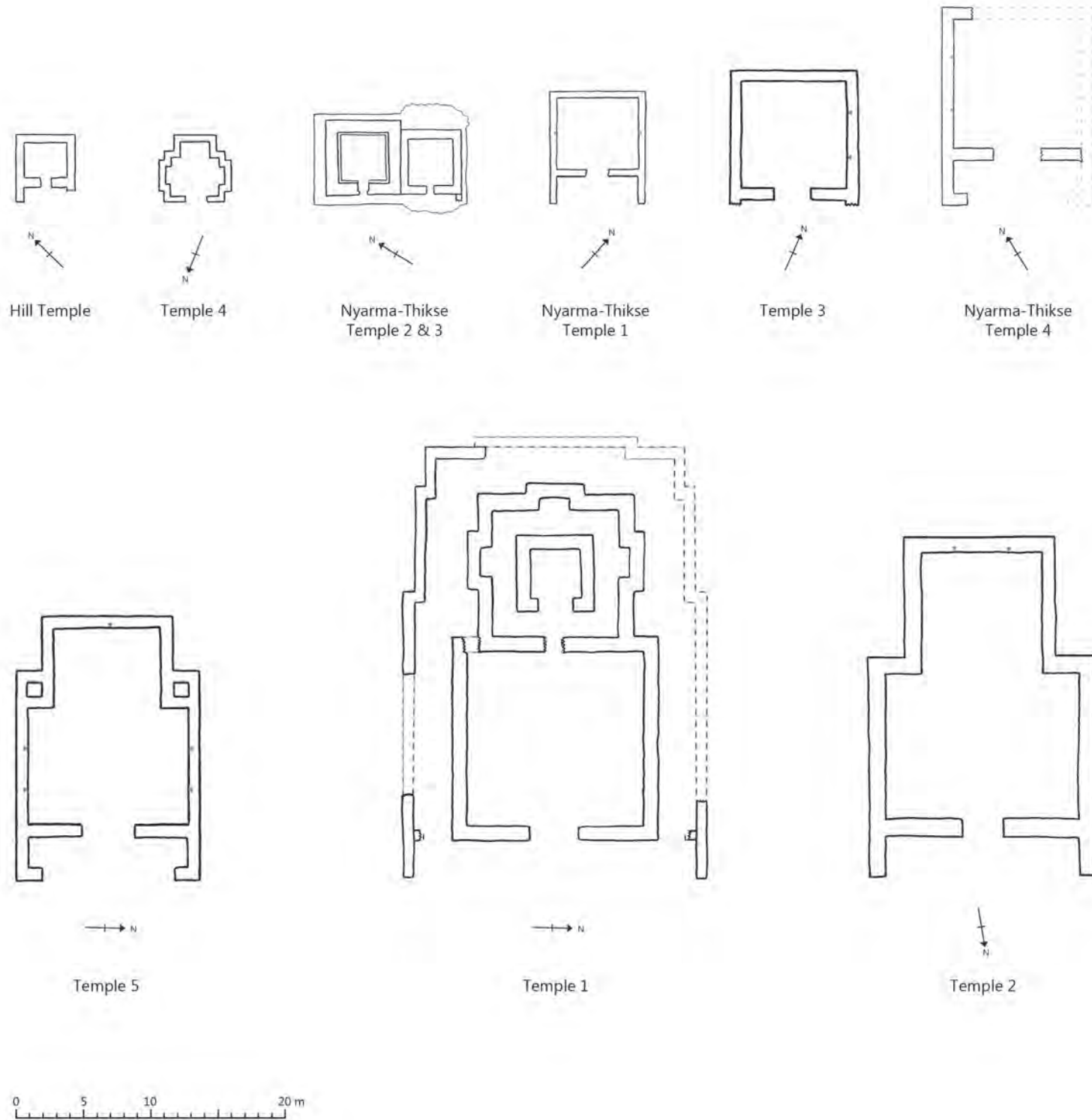



## References

- BELLEZZA, John Vincent. 2008. *Zhang Zhung: Foundations of Civilization in Tibet: A Historical and Ethnoarchaeological Study of the Monuments, Rock Art, Texts, and Oral Tradition of the Ancient Tibetan Upland*. Vienna: Verlag der Österreichischen Akademie der Wissenschaften.
- BRUNEAU, Laurianne. 2010. *Le Ladakh (état de Jammu et Cachemire, Inde) de l'Âge du Bronze à l'introduction du Bouddhisme: une étude de l'art rupestre*. (4 tomes: Tome 1-Texte, 190 pages; Tome 2-Catalogue des sites rupestres, 309 pages; Tome 3-Répertoire des pétroglyphes du Ladakh, 210 pages et Tome 4-Annexes et illustrations, 255 pages). Dissertation defended at the Université Paris 1 Sorbonne-Panthéon (Paris) in 2010.
- DEVERS, Quentin. 2015. The temples of Ladakh, ruined and intact, till the mid-fifteenth century: An archaeological perspective. Paper presented at the 17<sup>th</sup> Colloquium of the International Association of Ladakh Studies held at Kargil, 2015.
- . 2016. Fortifications of Ladakh: A brief chrono-typology. In: Linrothe, Rob and Heinrich Poell (eds) *Visible Heritage: Essays on the Art and Architecture of Greater Ladakh*. Delhi: Biblia Impex.
- . Forthcoming. The temples of Ladakh, ruined and intact, till the mid-fifteenth century: An archaeological perspective. In: Luczanits, Christian and Heinrich Poell (eds) *Proceedings of the 17<sup>th</sup> Colloquium of the International Association of Ladakh Studies*. Delhi: Biblia Impex.
- DEVERS, Quentin, BRUNEAU, Laurianne and Martin VERNIER. 2014. An archaeological account of ten early painted chortens in Ladakh and Zaskar. In: Lo Bue, Erberto and John Bray (eds) *Art and Architecture in Ladakh*. Leiden: Brill, 100–140.
- DIRECTOR GENERAL ARCHAEOLOGICAL SURVEY OF INDIA. 2006. *Indian Archaeology: A Review 2000-2001*. Delhi: Archaeological Survey of India, Government of India.
- HOWARD, Neil. 1989. The development of the fortresses of Ladakh c.950 to c. 1650 A.D. *East and West*, 39/1–4, 217–88.
- KOZICZ, Gerald. 2007a. A 12th Century Stupa related to the Monastery of Nyarma. Paper presented at the 13th Conference of the International Association of Ladakh Studies held in Rome in 2007.
- . 2007b. Do the Wrong Thing. Some Remarks on the Architectural History of the Former Sacred Compound of Nyarma and Current Construction Activities. Paper presented at the workshop “Cultural Heritage and Sustainable Development of Historic Cities in Asia Safeguarding Traditions and Ancient Knowledge to Promote Development” held in Berlin on the 4th of December 2007; [http://www.tibetheritagefund.org/media/forum/Berlin\\_conf\\_paper07/kozicz\\_berlinpap.pdf](http://www.tibetheritagefund.org/media/forum/Berlin_conf_paper07/kozicz_berlinpap.pdf) (last accessed February 10th, 2012)
- . 2007c. Documenting the last surviving murals of Nyarma. In: *Orientalia*, 38/4, 60–64.
- . 2007d. The architecture of the empty shells of Nyarma. In: Heller, Amy and Giacomella Orofino (eds) *Discoveries in Western Tibet and the Western Himalayas: Essays on History, Literature, Archeology and Art*: PIATS 2003: Tibetan Studies. Proceedings of the Tenth Seminar of the International Association for Tibetan Studies, Oxford, 2003. Leiden: Brill, 41–54.
- . 2011. Stupa Project. <http://stupa.arch-research.at/cms/> [accessed October 21, 2011].
- LUCZANITS, Christian. 2005. The early Buddhist heritage of Ladakh Reconsidered. In: Bray, John (ed.) *Ladakhi Histories: Local and Regional Perspectives*. Leiden: Brill, 65–96.
- MARTIN, Nils. 2015. The Wanla Group of Monuments. Paper presented at the monthly workshop organised by Achi Association in Leh, on the 15th of August 2015.
- NEUWIRTH, Holger. 2008. Buddhist Architecture in the Western Himalaya. <http://www.archresearch.tugraz.at/> [accessed October 5, 2008].
- PANGLUNG, Jampa Losang. 1983. Die Überreste des Klosters Āarma in Ladakh. In: Steinkellner, Ernst and Tauscher, Helmut (eds) *Contributions on Tibetan Language, History and Culture, Proceedings of the Csoma de Kőrös Symposium held at Velm-Vienna, Austria, 13-19 September, 1981*. Wien: Arbeitskreis für Tibetische und Buddhistische Studien, Universität Wien, 281–87.