



HAL
open science

12 T Insulated REBCO Magnet Used as 1 MJ SMES: Protection Strategies and Preliminary Assembly Tests

Julien Vialle, Arnaud Badel, Pascal Tixador

► **To cite this version:**

Julien Vialle, Arnaud Badel, Pascal Tixador. 12 T Insulated REBCO Magnet Used as 1 MJ SMES: Protection Strategies and Preliminary Assembly Tests. *IEEE Transactions on Applied Superconductivity*, 2022, 32 (6), pp.4702307. 10.1109/TASC.2022.3180979 . hal-03875431

HAL Id: hal-03875431

<https://hal.science/hal-03875431>

Submitted on 28 Nov 2022

HAL is a multi-disciplinary open access archive for the deposit and dissemination of scientific research documents, whether they are published or not. The documents may come from teaching and research institutions in France or abroad, or from public or private research centers.

L'archive ouverte pluridisciplinaire **HAL**, est destinée au dépôt et à la diffusion de documents scientifiques de niveau recherche, publiés ou non, émanant des établissements d'enseignement et de recherche français ou étrangers, des laboratoires publics ou privés.

12 T insulated REBCO magnet used as 1 MJ SMES: protection strategies and preliminary assembly tests

Julien Vialle, Arnaud Badel, Pascal Tixador

University Grenoble Alpes, CNRS, GRENOBLE INP, G2ELab—Institut Néel, 38000 Grenoble, France

Abstract— In the framework of the BOSSE project, a 12 T insulated REBCO solenoid is being manufactured. This magnet will be used as a SMES with the objective to reach 1 MJ and a specific energy of 20 kJ/kg for the winding. To manufacture this solenoid and reach such performances, 21 insulated REBCO Double Pancakes (DPs) will be assembled and cooled in a liquid helium bath at 4.2 K. To validate the solenoid's electromagnetic design, a prototype DP tested in self-field up to its critical current (972 A), thanks to a sensitive protection system, was presented in a previous work. Here we present the background magnetic field test of this prototype DP which allowed to validate the coil's mechanical design. In order to validate the electromagnetic performances of the 21 DPs, each of them is tested in liquid helium up to its rated current. The performances of the 17 DPs already tested and validated will also be presented. Finally, we will present the tests and results of 2 preliminary assemblies of 3 and 5 DPs. These assemblies were tested with two different protection philosophies. The results of these tests show that an individual protection of each DP is to be preferred in order to obtain a better sensitivity on the protection signal.

Index Terms—SMES, Superconducting magnet, Insulated REBCO magnet, High Magnetic field, Protection system.

I. INTRODUCTION

A 12 T REBCO solenoid with a 188.5 mm wide inner bore tapes was designed in the framework of the BOSSE Project, using 12 mm-wide single insulated SuperOx tape. This 814 mm high coil can be used as a compact 1 MJ – 2 MW inductive energy storage, with an 850 A rated current. A first objective is to surpass the record for mass energy density, held by a NbTi coil (13 kJ/kg) [1] by reaching 14 kJ/kg (mass of conductor only). The final goal is to, push the operating current further to reach 20 kJ/kg in the winding, which requires 890 A. Tab. I summarizes the different important quantities according to the objective in specific energy density to be reached.

This solenoid is composed of 21 Double Pancakes (DPs) with a soldered inner joint. Its geometry is optimized at the coil ends where the spacing between the pancakes is progressively increased in order to reduce the transverse field distribution and thus improve the critical current. The important rated values of the SMES for the most ambitious operation point, 20 kJ/kg, are listed in Tab. II. More specifications on the solenoid design and DP manufacture can be found in [2].

Insulated REBCO windings are known to be difficult to protect in case of local thermal runaway. In order to discharge the magnet before destruction, it is necessary to detect at an early

TABLE I: OBJECTIVES TO ACHIEVE AT 4.2 K

| Energy | 0.775 MJ 14 kJ/kg | 1 MJ 18.1 kJ/KG | 1.105 MJ 20 kJ/KG |
|-----------------------------------|----------------------|--------------------|----------------------|
| I (A) | 745 | 850 | 890 |
| J (MA/m ²) | 460 | 523 | 550 |
| B _Z ^{max} (T) | 10.14 | 11.53 | 12.12 |
| B _r ^{max} (T) | 3.7 | 4.2 | 4.4 |
| Max. hoop stress (MPa) | 306 | 396 | 437 |

stage the beginning of the dissipation in the winding [3,4]. This remains a delicate operation because the inductive voltage when ramping up the magnet is often several orders of magnitude higher than the voltage related to the onset of a transition. The electromagnetic noise itself is often higher in amplitude than the signal of interest. A detection concept using pickup coils to compensate the inductive component of the signal and some of the noise during current ramps, as well as numerical low pass filtering was introduced [4]. The sensitivity of the quench detection system is in the 100 μV range, which made it possible to test a first full-scale prototype of DP at 4.2 K up to its limiting critical current (972 A with 0.18 A/s) without any degradation [2]. The test of this DP prototype under background field is presented in part II, validating the mechanical design. This project started in 2015 and all conductor lengths were procured at that time. Considering the uncertainty on tape performances from this period in low temperature/high field and the low critical current margin of the design (14 % see [2]), it was decided to test all DPs in liquid helium to the rated current before assembly. The results of the evaluation campaign for the 21 DPs are presented part III.

TABLE II: RATED SMES OPERATION VALUES FOR 20 KJ/KG AT 4.2 K

| | |
|-------------------------------|-----------------------|
| Energy | 1100 kJ |
| Height | 814 mm |
| Inner diameter | 188.5 mm |
| Outer diameter | 240 mm |
| B _Z ^{max} | 12 T |
| B _r ^{max} | 4.4 T |
| I operating | 890 A |
| J _e | 550 MA/m ² |
| Max. hoop stress (full cond.) | 421 MPa |
| Specific energy | 20 kJ/kg |
| Pancake number | 42 |

Finally, part IV presents partial assembly tests. Our approach to operate safely the full-size magnet in spite of its high operating current density is to detect thermal runaway in each DPs independently or grouped by two or three, using the same detection concept used for the prototype pancake. Two partial assemblies of 3 and 5 DPs were tested in order to configure and validate the simultaneous protection of a growing number of DPs. During these tests, the transient voltage is carefully monitored to detect dissipation. The various phenomena contributing to this transient voltage have been studied with the help of detailed electromagnetic modelling results [5].

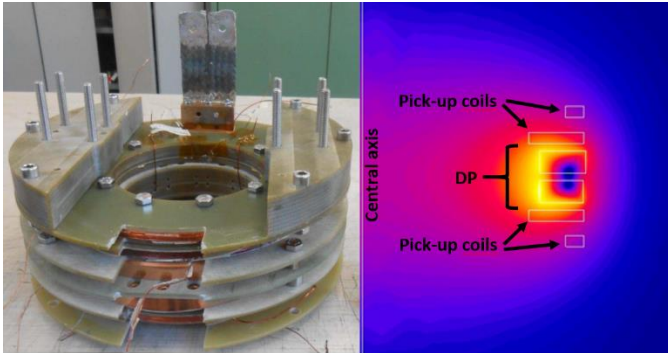

Fig. 1. Photo of the prototype DP and its axisymmetric magnetic field map with its compensation coils. The current density is assumed to be homogeneous.

II. MECHANICAL DESIGN VALIDATION OF THE BOSSE MAGNET

According to the Virial theorem, the specific energy is proportional to the stress on the conductor [6]. In order to reach ultimately 20 kJ/kg the BOSSE solenoid must operate at high levels of mechanical stress and current density. Fig. 2 shows the stress distribution in the winding at the rated current.

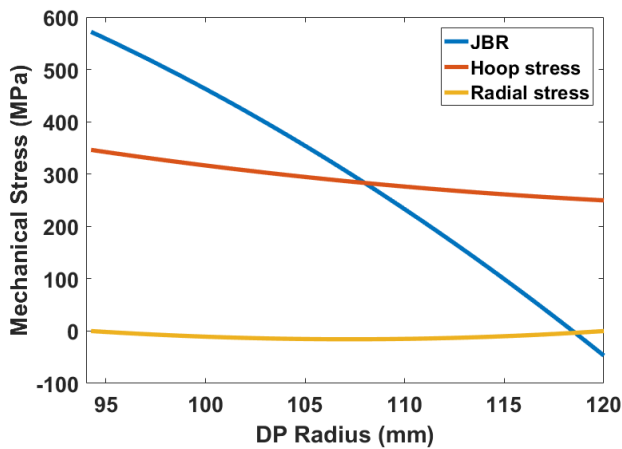

Fig. 2. Mechanical stress distribution in the winding of a DP at the center of the SMES for a stored energy of 1MJ. Hoop stress and radial stress are calculated with the Wilson formula.

Fig. 2 shows the mechanical stress calculated with the JBR (independent turns) and Wilson formulas where the latter assumes "dependent" turns [7,8]. For these calculations, the rated values of the SMES were used. That is to say a current density of 525 A/mm², a magnetic field of 11.55 T at the inner

turn and a magnetic field of -0.77 T at the outer turn. The mechanical stress calculated with Wilson is smaller at the inner turn and larger at the outer turn than with the JBR formula. This can be explained by the fact that the inner turns are subject to much larger Laplace forces and are therefore supported on the outer turns. In a way we can say that the mechanical stress is homogenized over the width of the winding in this magnetic field configuration. The radial stress is therefore negative and indicates a winding in compression.

From the conductor's point of view, it is mainly made of Hastelloy C 276, a very rigid material that has excellent mechanical properties with a high Young's modulus (YM) of 220 GPa. However, the copper stabilizer, which has a lower YM (124 GPa), weakens the mechanical properties of the conductor. This leads the conductor to an average YM of 172 GPa.

Calculations of the winding mechanical stress as well as the conductor YM allow us to estimate the conductor elongation. For the SMES to achieve the first target of 1 MJ, the conductor elongation on the central windings of the solenoid will reach 0.345%, and 0.38% for 1.1 MJ, corresponding to a specific energy density of 20 kJ/kg. This is very close to the maximum mechanical stresses allowed for the conductor since irreversible degradation may occur above 0.4 % in conductors from this period (2015) [9].

For this reason, before launching the production of the 21 DPs, it was necessary to validate the design and manufacturing process by testing electro-mechanical performances. Therefore, after the test in self-field operating current limit (mentioned in introduction), the prototype DP already was also tested in background magnetic field under larger mechanical stress. As the pancake is large (240 mm outer diameter), the 376 mm diameter resistive magnet (12 MW/30 kA/10 T) from the LNCMI in Grenoble was used. Additional pick-up coils were added to this test (ramp rate: 2 then 1 A/s Fig. 3) in order to compensate the important electromagnetic noise (hundreds of mV) generated by the resistive background magnet and to keep a high sensitivity on the protection signal [4]. A photo of the prototype DP with its pick-up coils and the axisymmetric magnetic field map showing the positioning of each coil is shown in Fig. 1.

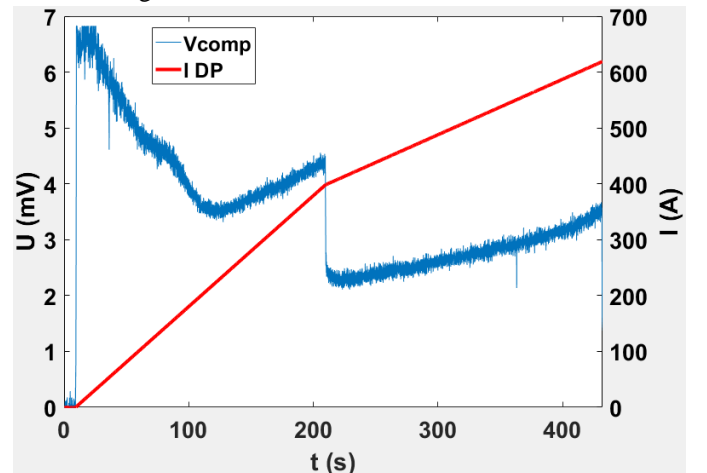

Fig. 3. The current cycle and the compensated voltage signal during the test under magnetic field background of 6 T.

The prototype DP reached a current of 623 A under 6 T, for a total magnetic field at the center of the DP of 7.6 T, and 9.7 T on the conductor (Fig. 3). We stopped the experiment at this value, as the stress on the outer diameter could become higher than in the final assembly, and the outer contacts are not designed for it [4]. The stress could be concentrated on the outer contact ends (Fig. 4). Still, under 623 A the stress reached 350 MPa on the inner turns of the DP, corresponding to an elongation of 0.3% of the conductor (calculated data). This represent already 83% of the maximum hoop stress at the rated current for the SMES solenoid.

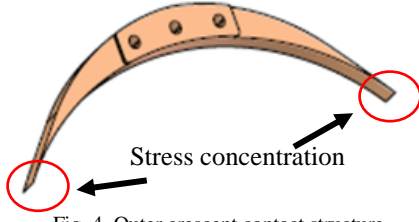

Fig. 4. Outer crescent contact structure

III. INDIVIDUAL ELECTROMAGNETIC VALIDATION OF DPs

Once the solenoid design was validated by extensive tests of the prototype DP, the 21 DPs of the solenoid were produced by Sigmaphi [10], the industrial partner of the project.

Each of the DPs was then tested at 4.2 K above the rated current of the final solenoid in 1 MJ configuration (850 A) in order to validate their electromagnetic performance. For quality control, the contact resistances are measured. Note is also taken of the voltage spikes indicating wire movement. At this stage of the BOSSE project, 17 DPs have been validated for integration in the assembly, with successful operation at current plateau of 863 A during 180 s at least, and acceptable contact resistances: 11 of the 13 DPs with a 4 mm gap, 1 of the 2 DPs with a 6 mm gap, 1 of the 2 DPs with a 10 mm gap, the 2 DPs with a 15 mm gap and the 2 DPs with a 30 mm gap.

A summary table of the important quantities achieved during the tests of the central DPs are presented in Tab. III.

TABLE III
VALUES REACHED DURING THE VALIDATION TESTS OF THE
CENTRAL DPs (4 MM GAP)

| | |
|-------------------------------------|-------|
| Average number of turns per pancake | 180 |
| L (mH) | 42.64 |
| I (A) | 863 |
| B_z^{\max} (T) | 5.28 |
| B_r^{\max} (T) | 4.17 |
| Max. hoop stress (MPa) | 263 |

The main cause of concern for the series-produced DPs is the inner joint. The inner resistance of the prototype was very low (< 20 n Ω), but the resistance values obtained in series-produced DPs was much higher. This is surprising as a soldered-joints validation campaign was organized with the industrial partner prior to the winding phase, to define the procedure and tooling to be used. During this campaign, joint resistance of 4 n Ω were routinely achieved, in good agreement with the prototype and

literature [11]. It is suspected that a tension spike when starting the winding could be the origin, or an excessive time spent soldering the joint due to the more awkward position of the operator when soldering on an actual pancake. The average resistance of the 17 validated DPs reaches 367 n Ω , spreading from a minimum of 19 n Ω to a maximum of 700 n Ω . Several of them had higher values during their first tests and were rewound for this reason, and 4 are still waiting to be rewound.

IV. PROTECTION OF DPs IN ASSEMBLIES

In principle, two voltage taps across the superconducting winding and a single pickup coil for compensation are sufficient to ensure the protection of any DP assembly, just as it is done for a single DP. Nevertheless, the length of the winding between two voltage taps is important. Indeed, the amplitude of the residual voltage noise increases with the winding length. On the contrary, dissipative state in REBCO tapes will appear very locally, so that the amplitude of the dissipative voltage that needs to be detected does not depend on the coil length.

In order to increase sensitivity, it was decided for this project to equip each DP with voltage taps and an independent pickup coil. This makes it possible to protect the DPs either independently or by sub-groups. Individual protection of DPs also has the important advantage of accurately locating a faulty DP among the assembly in case of an early protection discharge event, making it possible to replace it or repair it.

For the final assembly the protection system presented in [2] will therefore be multiplied by up to 21 (Fig. 5). The compensated voltage signals of each DP or sub groups of DPs are analyzed simultaneously in real time in order to detect the occurrence of a dissipative zone.

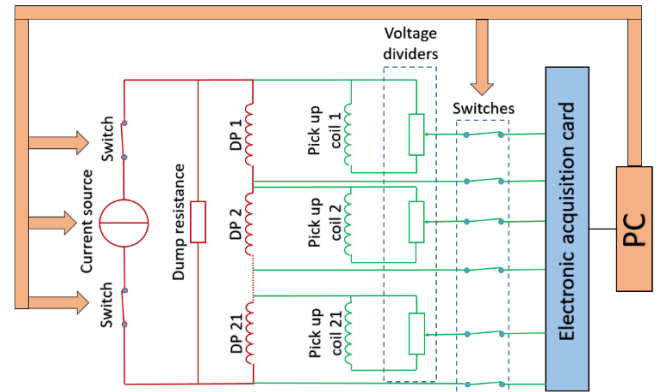

Fig. 5. Electrical circuit diagram of the BOSSE solenoid protection system.

The BOSSE solenoid will be discharged under 5 kV (± 2.5 kV) to get to its rated power; the acquisition electronics is disconnected when the discharge is triggered to protect it from overvoltage, making it possible to operate without high voltage differential units that are costly and generate noise [3].

The signals from the DPs and subassemblies tested in self-field, which are presented in this paper, were monitored using an oscilloscope controlling the protection switch through a 0 – 5 V TTL output. The compensated voltage signals were manually adjusted using a voltage divider bridge. This method

is easily manageable for testing a single DP or "small" assemblies. For future, larger assemblies, the signals will have to be treated automatically, taking into account the transient components of the signals as well as the voltage peaks due to winding movements. Modeling efforts have been made in this direction [5,13].

V. TEST OF A 3 DPs ASSEMBLY

A. Assembly characteristics and test result

The main step left before the final magnet is to succeed in protecting several DPs in an assembly. Two partial assemblies were tested. The first one used 3 DPs. This assembly was made using DPs from the BOSSE solenoid heads, so they are separated by a larger gap than the central DPs. Moreover, these coil head DPs were wound with the tape lengths having the best average I_c at 77 K (>500 A) to keep sufficient current margins in transverse field. The 2 DPs at the ends of this assembly have a spacing of 30 mm between pancakes and the DP at the center a spacing of 15 mm. Between these three DPs a 15 mm spacing is chosen to homogenize the field distribution as well as possible. As in the final assembly, each DP is connected to the adjacent one by their outer contacts, which are pressed together using three M4 screws. Indium is used to reduce the contact resistance. An axisymmetric magnetic field map of the assembly of these 3 DPs and their respective pick-up coils is shown in Fig. 6 as well as a picture of a DP pancake coil where the inner and outer contacts of the DP can be distinguished.

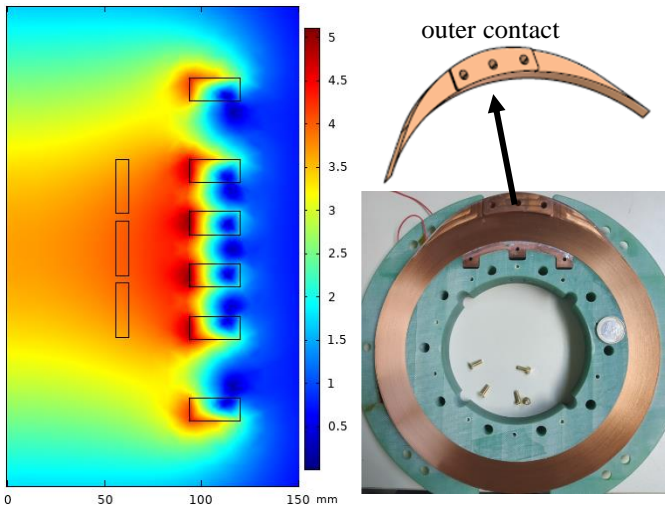

Fig. 6. The magnetic field map of the 3 PDs assembly and its pick-up coils as well as the picture of a DP pancake winding and its outer crescent contact.

The pickup coils are inserted in the center of the solenoid. This saves space and minimizes the size of the cryostat, at no cost for SMES application, as the center bore does not have to be accessible for energy storage. They are however designed to be removable if the full magnet was to be used for other purpose in the future. They have 1200 turns of Φ 0.36 mm insulated copper wire with an inner radius of 56 mm, an outer radius of 63 mm and a height of 28 mm. The number of turns of the

pickup coils is much larger than the number of turns of the DPs, in order to enable full inductive voltage cancellation even though the coupling is limited due to the large thickness of the DPs mandrels.

For this first assembly, we evaluate the possibility to protect the three DPs together. Their three pick-up coils were connected in series in order to perform a global compensation of the assembly and analyze the sensitivity of the protection signal. In order to minimize the risks of damage in such preliminary work, it was decided to limit the operating current to 745 A, corresponding to the first project target of 14 kJ/kg.

TABLE IV
VALUES ACHIEVED DURING THE TESTING OF THE
3 DPs ASSEMBLY

| | |
|---------------------------------|------|
| Number of DPs | 3 |
| L (mH) | 172 |
| I (A) | 763 |
| B_z^{\max} (T) | 5.23 |
| B_r^{\max} (T) | 3.4 |
| Max. hoop stress (MPa) | 203 |
| Specific energy density (kJ/kg) | 6.35 |

We exceeded the first target of 745 A and reached 763 A (see summary Table IV) which corresponds to a stored energy of 52.3 kJ and a specific energy density of 6.35 kJ/kg. A first current ramp at 2 A/s is performed up to 600 A where a short plateau of about 100 s is maintained (to evaluate steady state dissipation), then the current ramp is increased with a ramp of 1 A/s up to 763 A where another plateau of about 160 s was achieved before the magnet discharge. During both current plateaus, the voltage returned close to zero, proving the safe operation of the assembly. Fig. 7 shows the individual voltages of the 3 DPs as well as current cycle of this test. The voltages of the DPs at the ends of the assembly are expected to be superimposed as they are identical and symmetrical. The slight difference observed in their voltage is due to a small variation in turn number: 360 for the upper one and 368 for the lower one. The voltage of the central DP is logically higher: its inductance is higher due to its smaller gap between pancakes (15 mm instead of 30 mm). It also has higher coupling with both others.

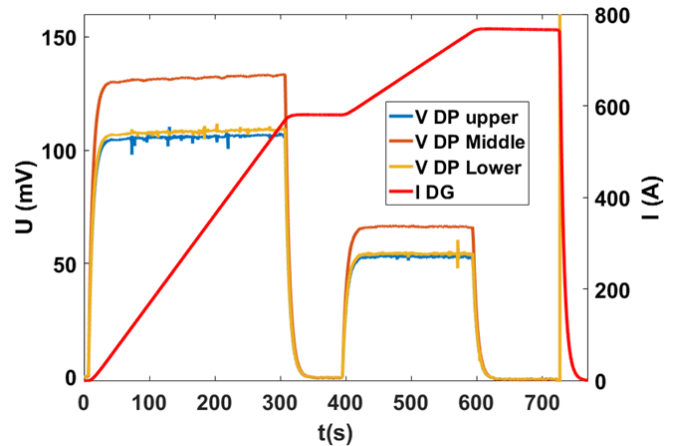

Fig. 7. The current cycle and the individual voltage across each DP.

Fig. 8 shows the compensated voltage signal of the assembly used to protect the winding (in blue). The triggering threshold

of the protection is set at 1.5 mV. This triggering value is fixed based on simulations of the thermal runaway phenomenon developed in our group [3,12]. Of course, the lower the transition detection threshold, the longer and more comfortable the time for the protection to be triggered.

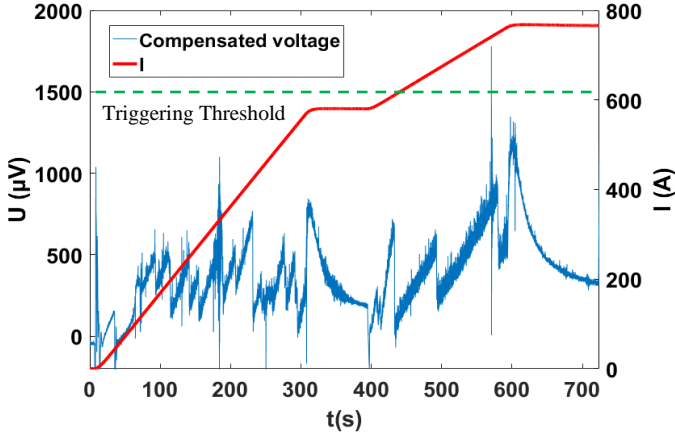

Fig. 8. The current cycle and the compensated voltage signal of the 3 DPs assembly

The voltage drift observed on the protection signal from the beginning of the ramp on the whole voltage profile is not due to a resistive component. It is due to the variation of the current density distribution in the width of the superconducting layer of the conductor as the current or the magnetic field varies, inducing a change of the superconducting coil inductance as well as AC losses. As such, it rapidly decays to zero during a current plateau (stabilization of the current density distribution). This phenomenon, first observed in [4], has been modelled and studied in detail [5,13]. This drift forces us to perform a dynamic signal compensation. This explains the discontinuities in the protection signal curve Fig. 8. Each of these discontinuities correspond to a readjustment of the compensation in order not to exceed the triggering threshold due to this signal drift.

The remaining voltage of about 250 μV at the end of the plateau at 763 A is due to the inner and outer connection of the windings which are resistive. This gives us a global resistance of the assembly of 327 $\text{n}\Omega$ at this operating current. The outer pressed contacts connecting the DPs together are very good and paradoxically better than the inner soldered contacts of the DPs. The latter are still satisfying, with an estimated resistance of about 60 $\text{n}\Omega$ in average.

The main result of this assembly test is that it was possible to reach sufficient sensitivity (well below 200 μV) in the thermal runaway detection system when observing a group of three DPs. This way the number of signals to monitor in a larger assembly can be reduced. Of course, the drawback of this solution is that identifying the defective DP is impossible if the protection triggers during a current transient. Moreover, an excellent energy efficiency, 98.6 %, was obtained over the full charge-discharge cycle of this assembly (the discharge time constant was set to 6 s, slower than the 1 s target in the final configuration [2]). The losses are AC losses and connection losses.

B. Inner contact damage and discussion

During a discharge of the 3 DPs assembly test, one of the inner contacts was degraded. Nevertheless, we reached several times this operating current of 763 A showing that the superconducting winding was not damaged. As mentioned in part III, the inner contacts were a source of concern from the beginning of the series DP manufacturing, with joint resistance measured well above what was expected from the prototype. Still, this degradation occurred at the discharge and therefore neither at the maximum applied current nor stress. The reason may come from the inner contact structure (Fig. 9).

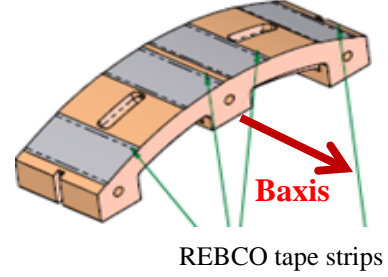

Fig. 9. Inner contact structure

It was originally designed with large copper thickness to guarantee thermal stability, acting as a radiator in the helium bath. Eddy current heating during fast discharge was expected but the estimated temperature rise was acceptable [14]. Superconducting strips were added on the copper to reduce the joint resistance, but this may have been counterproductive. The improvement in terms of joint resistance was negligible but during transients, the induced current circulating in the copper contacts pass through these strips. When the transport current is decreased, this induced current is added to the transport current, with two potentially detrimental effects.

First, the total current may exceed the critical current of the strips. Second, this high current in the strips may cause abnormally high mechanical stress and the delamination of the conductor. A simpler, thinner inner contact without REBCO tape strips will be considered in the future.

VI. TEST OF A 5 DPs ASSEMBLY

A. Assembly characteristics and test result

The main goal of the 5 DPs assembly was to test the concept of individual protection of each DP. The deterioration of the inner contact on one of the DPs was judged acceptable to perform tests with reduced operating current, and a good test case for the protection system. As for the previous assembly the DPs corresponding to the heads of the complete solenoid were used. Starting from the bottom, the stack included DPs with inner gaps of 30, 15, 10, 15, and 30 mm. The spacing between the DPs starting from the bottom was the following: 15, 11, 11 and 15 mm. The position of the DPs and their respective pick-up coils can be found on the magnetic field map Fig. 10, with a picture of the assembly.

We did not set any current target for this experiment, but rather tested the coil up to the current for which the dissipation appeared unstable (inner contact heating). A current ramp of 8 A/s was performed up to 592 A where a plateau of about 300 s was achieved (Fig. 11). You will find below a summary table of this test and Fig. 10 the axisymmetric magnetic field map of this assembly of 5 DPs with its pick-up coils and a picture of the assembly.

TABLE V
VALUES ACHIEVED DURING THE TESTING OF THE
5 DPs ASSEMBLY

| | |
|---------------------------------|-----|
| Number of DPs | 5 |
| L (mH) | 370 |
| I (A) | 592 |
| B_z^{\max} (T) | 5.2 |
| B_r^{\max} (T) | 3.5 |
| Max. hoop stress (MPa) | 140 |
| Specific energy density (kJ/kg) | 5 |

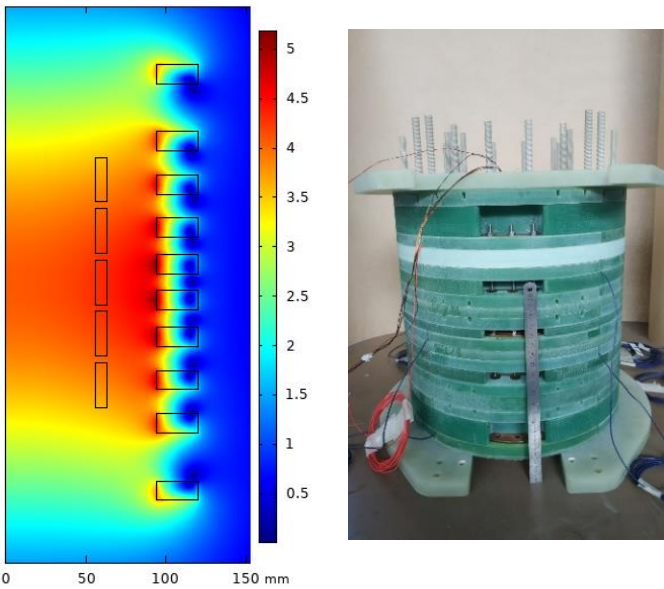

Fig. 10. The axisymmetric magnetic field map of the 5 DPs and their pickup coils as well as a photo of the assembly.

In order not to degrade any other inner contact of DPs a very slow full discharge of 320 s was performed. The display of the compensated voltage signals of each DP is shown in Fig. 12. We can see that the signals of 4 DPs return to 0 V once the plateau has started except for one corresponding to the degraded DP of the previous assembly. The voltage is quite high and approaches 4 mV. Yet it remains stable, which means that it is due to the inner contact resistance of the DP. If a thermal runaway was occurring it would have shown another dynamic. However, the dissipation of this contact was so high (2.37 W) that we considered it too dangerous to go higher in current.

The sensitivity of the individual DP compensation signals is very good: the noise envelopes after compensation and filtering (numerical low pass with 15 Hz cut-off) is about 45 μ V.

B. Discussion

Here, in this assembly of 5 DPs, an individual protection of each DP has been successfully realized. We were able to perform several tests up to a current density of 365 A/mm² and this

despite a degraded internal contact, which proves the robustness of the winding. The major benefit of this solution (in addition to the ability to clearly locate a defective DP) is the sensitivity level achieved below 50 μ V. This advantage is all the more important as we are currently obliged to perform slow discharges. It is therefore of the utmost importance to have the finest possible transition detection sensitivity. This is why this protection solution will be adopted for the final solenoid protection.

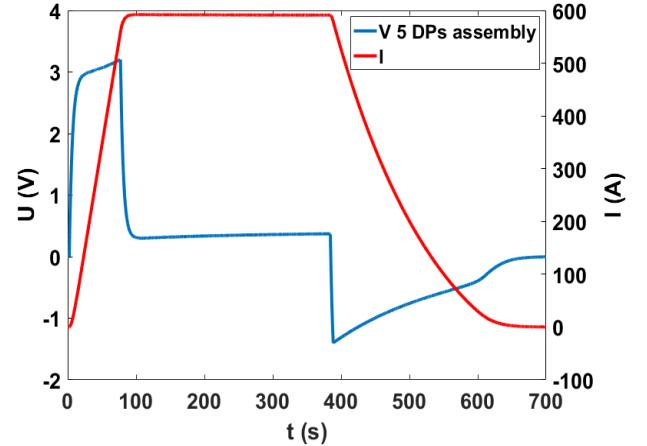

Fig. 11. The current cycle and the voltage measured across the 5 DPs assembly.

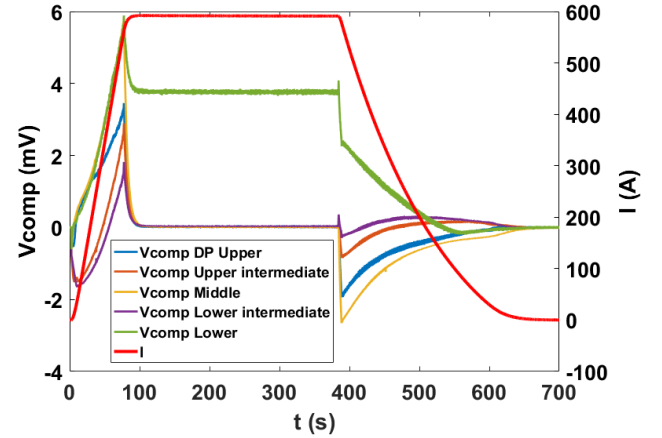

Fig. 12. The current cycle and the compensated voltage signals of the 5 DPs.

VII. CONCLUSION

In this work, the electromechanical design of the BOSSE SMES was validated by testing a full scale Double Pancake under background field. All series-produced DPs were tested at 4.2 K up to their rated current for quality control. This test campaign study highlighted the difficulty to obtain low resistance consistently in an industrial setting with the chosen inner contact design. Further work will be conducted on that point. An important step was the development and validation of a detection/protection system to protect an assembly of several DPs. It highlighted the benefit of monitoring DPs in small groups or individually using multiple pick-up coils to obtain high detection sensitivity. The high sensitivity we obtained practically during the 5 DPs assembly test – in the 50 μ V range- makes us confident in the possibility to test the full assembly of the BOSSE solenoid reliably to its operation limits.

REFERENCES

- [1] A. Yamamoto et al., "A thin superconducting solenoid magnet for particle astrophysics", *IEEE Trans. Appl. Supercond.*, vol. 12, no. 1, pp. 438-442, Mar. 2002.
- [2] J. Vialle, A. Badel, P. Tixador, J. Ciceron, F. Forest and R. Pasquet, "Preliminary Tests of Pancakes From a 12 T REBCO Insulated Solenoid Magnet," in *IEEE Transactions on Applied Superconductivity*, vol. 31, no. 5, pp. 1-5, Aug. 2021, Art no. 4600805, doi: 10.1109/TASC.2021.3057837.
- [3] A. Badel *et al.*, "Detection and Protection Against Quench/Local Thermal Runaway for a 30 T Cryogen-Free Magnet," in *IEEE Transactions on Applied Superconductivity*, vol. 31, no. 5, pp. 1-5, Aug. 2021, Art no. 4700705, doi: 10.1109/TASC.2021.3059604.
- [4] J. Ciceron, A. Badel, P. Tixador, R. Pasquet and F. Forest, "Test in Strong Background Field of a Modular Element of a REBCO 1 MJ High Energy Density SMES," in *IEEE Transactions on Applied Superconductivity*, vol. 28, no. 4, pp. 1-5, June 2018, Art no. 5701005, doi: 10.1109/TASC.2018.2820906.
- [5] Julien Vialle et al., "Transient voltages and energy balance in REBCO insulated magnet: experimental and numerical studies", 2021 *Supercond. Sci. Technol.* **34** 115012.
- [6] F. C. Moon, "The virial theorem and scaling laws for superconducting-magnet systems," *J. Appl. Phys.*, vol. 53, no. 12, pp. 9112-9121, 1982.
- [7] ARP, V: Stresses in superconducting solenoids. In: *Journal of Applied Physics Bd. 48 (1977)*, Nr. 5, S. 2026-2036
- [8] WILSON, MARTIN N: Superconducting magnets (1983)
- [9] C Barth et al., "Electro-mechanical properties of REBCO coated conductors from various industrial manufacturers at 77 K, self-field and 4.2 K, 19 T", 2015 *Supercond. Sci. Technol.* **28** 045011.
- [10] "Nov. 2021. [Online]", [online] Available: <https://www.sigmaphi.fr/>.
- [11] J. Fleiter and A. Ballarino, "In-Field Electrical Resistance at 4.2 K of REBCO Splices," in *IEEE Transactions on Applied Superconductivity*, vol. 27, no. 4, pp. 1-5, June 2017, Art no. 6603305, doi: 10.1109/TASC.2017.2659618.
- [12] Arnaud Badel et al., "Modeling of 'quench' or the occurrence and propagation of dissipative zones in REBCO high temperature superconducting coils", 2019 *Supercond. Sci. Technol.* **32** 094001
- [13] Rozier Blandine et al., « Calculation of the local current density in high-temperature superconducting insulated rare earth-barium-copper oxide coils using a volume integral formulation and its contribution to coil protection », 2019 *Supercond. Sci. Technol.* **32** 044008.
- [14] J. Ciceron, "High energy density Superconducting Magnetic Energy Storage with second generation high temperature superconductors", thesis, Grenoble Alpes University, 2019.