



**HAL**  
open science

# Using reverse correlation to study individual perception: Including an auditory model in the experimental design loop

Alejandro Osses, Léo Varnet

## ► To cite this version:

Alejandro Osses, Léo Varnet. Using reverse correlation to study individual perception: Including an auditory model in the experimental design loop. ARCHES meeting, Nov 2022, Oldenburg, Germany. , 2022. hal-03866646

**HAL Id: hal-03866646**

**<https://hal.science/hal-03866646v1>**

Submitted on 22 Nov 2022

**HAL** is a multi-disciplinary open access archive for the deposit and dissemination of scientific research documents, whether they are published or not. The documents may come from teaching and research institutions in France or abroad, or from public or private research centers.

L'archive ouverte pluridisciplinaire **HAL**, est destinée au dépôt et à la diffusion de documents scientifiques de niveau recherche, publiés ou non, émanant des établissements d'enseignement et de recherche français ou étrangers, des laboratoires publics ou privés.



Distributed under a Creative Commons Attribution 4.0 International License



## Phoneme discrimination using the ACI method

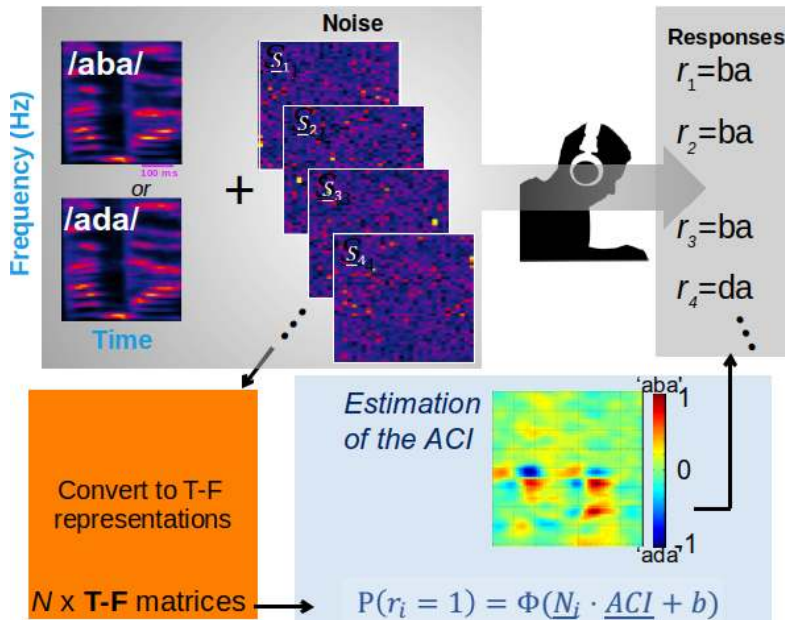

- $N$  trials needed
- $N$  is too high (> 4000)

## Phoneme discrimination using the ACI method: Optimisation?

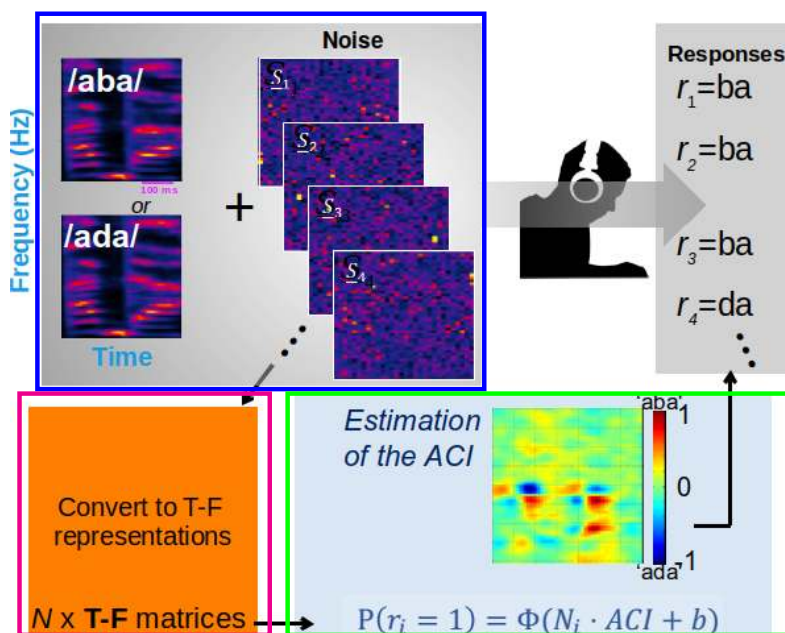

- Other speech samples
- Other noises
- Another T-F transformation
- Another statistical fitting scheme

- Reviewed and unified for all our previous studies  
[Osses et al. (2022, ICA)]

## Phoneme discrimination using the ACI method: Optimisation?

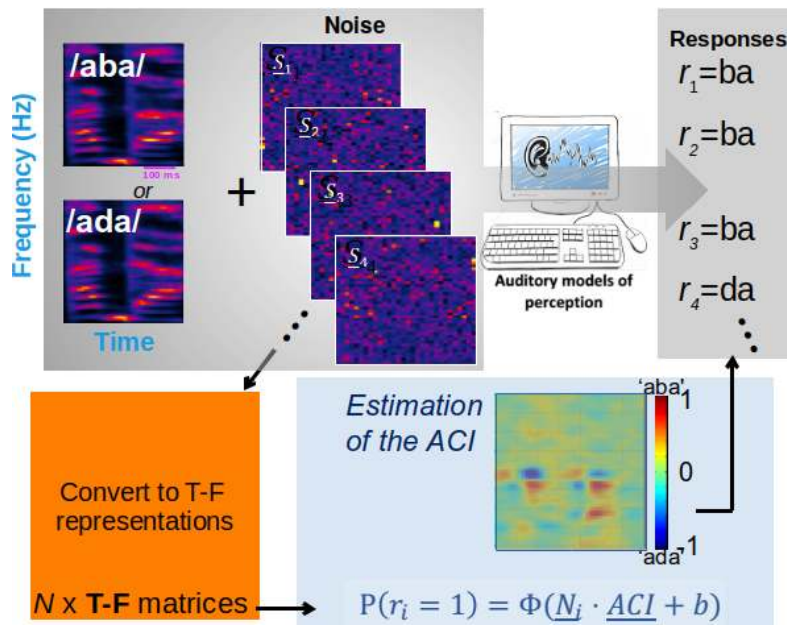

- Other speech samples
- Other noises
- Another T-F transformation
- Another statistical fitting scheme
- Previous studies: White noise
- We wanted other noises

## Outline

- 1 Introduction
- 2 Algorithm for noise generation
- 3 Results
- 4 Discussion & conclusions
- 5 (Supplementary)

## Rationale: speeding up the ACI assessment

Fig. 1

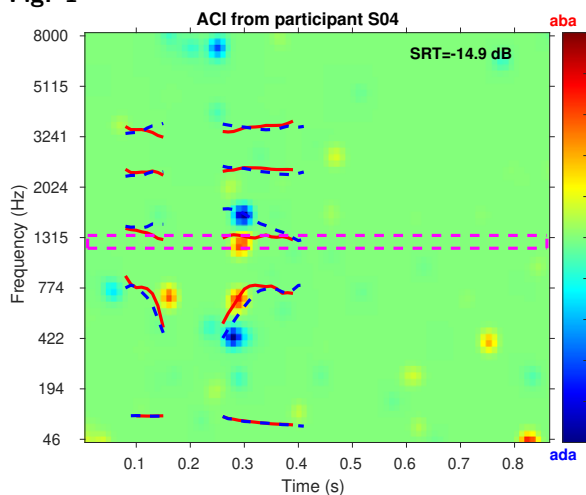
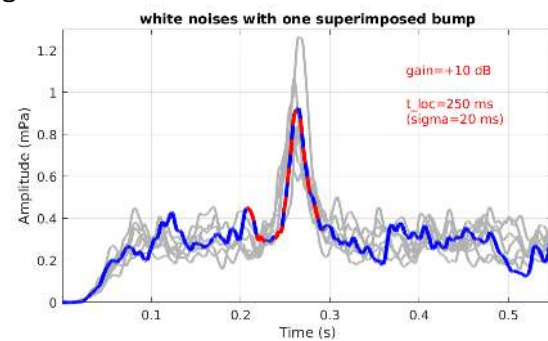

Fig. 2



- In the end: 30 bumps for each noise
- Random locations along time and frequency

## Rationale: Hypotheses

Using bump noises:

- H1: We will be able to obtain clean ACIs: [pilots with one participant](#)
- H2: Different sets of noises will lead to the same ACIs: [to be checked by the model](#)

Experimental design:

- Baseline: White noises
- Data collection from 12 participants (4000 trials  $\approx$  4h sessions x noise type x participant)



## Outline

- 1 Introduction
- 2 Algorithm for noise generation
- 3 Results
- 4 Discussion & conclusions
- 5 (Supplementary)

## H1 – Experiments

- H1: Yes, we were able to obtain clean ACIs, but...

Fig. 3

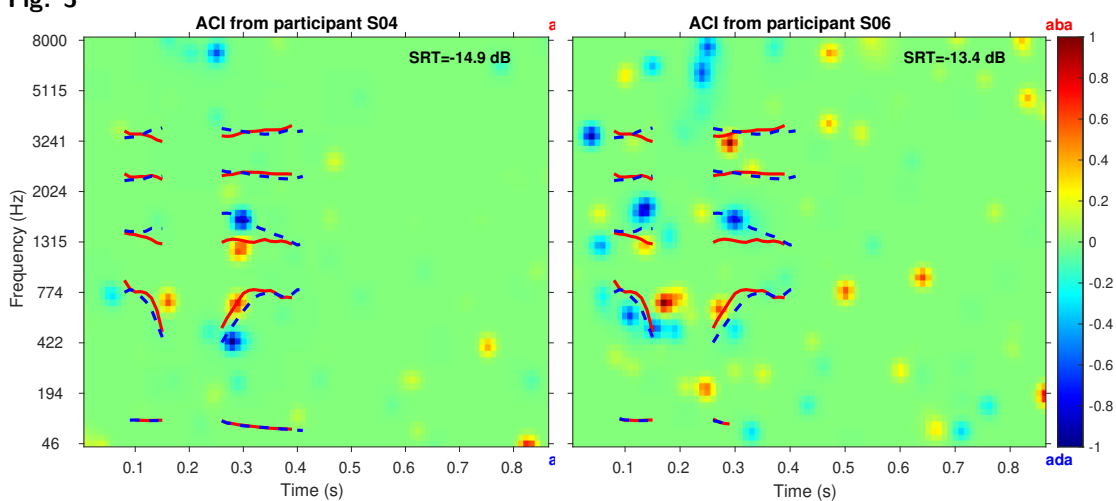

Maybe: Individual differences related to the specific set of bump noises (H2)?

## H2 – ACIs from simulations: The auditory model

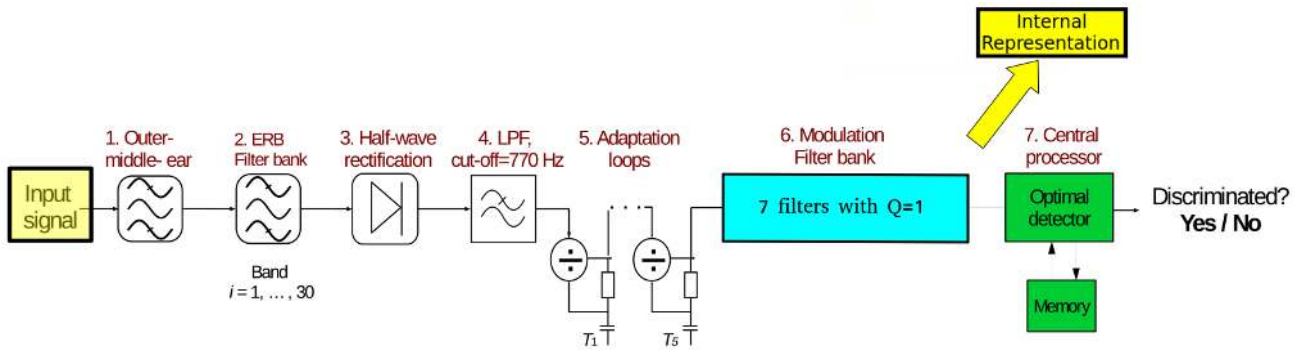

- Perceptual model based on the modulation-filter-bank model by *Dau et al. (1997)*
- Updated parameters, updated modulation filter bank
- Two template-approach as detailed by *Osses & Kohlrausch (2021)*, here:
  - Template 1: /aba/; Template 2: /ada/. Obtained from 1000 noisy samples
  - Supra-threshold level: SNR= -6 dB

## H2 – ACIs from simulations

- H2: Yes, the ACIs were independent from the set of bump noises

Fig. 4

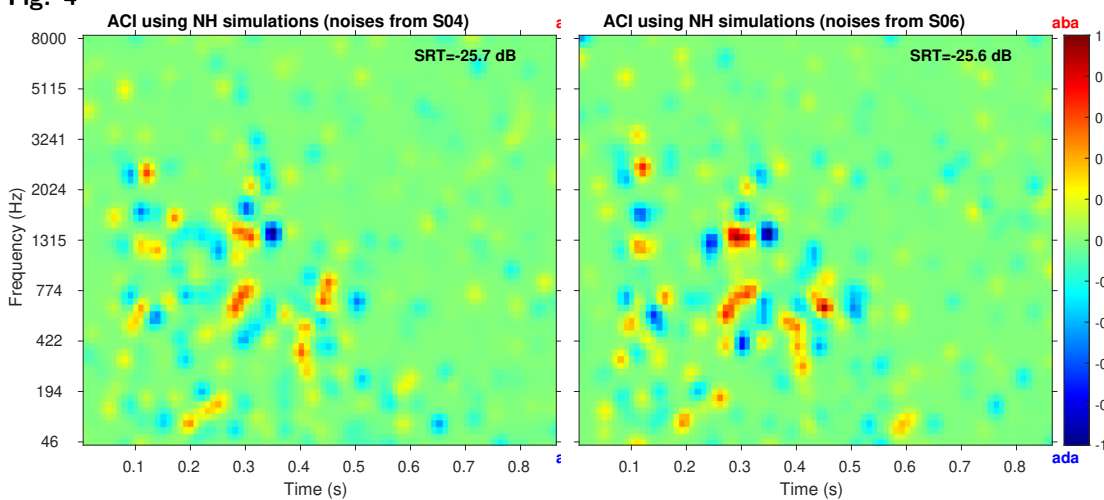

## Comparing ACIs from experiments/simulations (1 of 2)

Fig. 4a

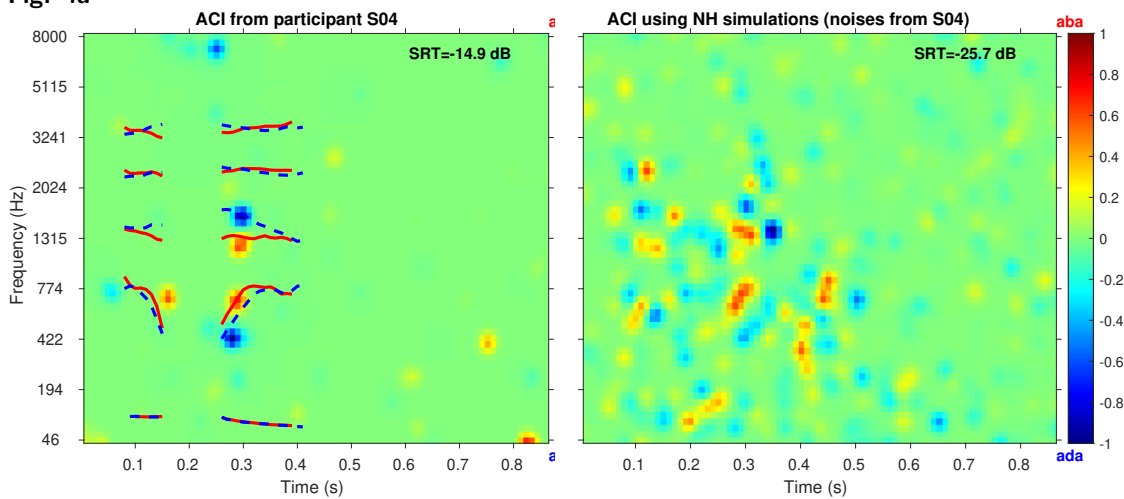

## Comparing ACIs from experiments/simulations (1 of 2)

Fig. 4a

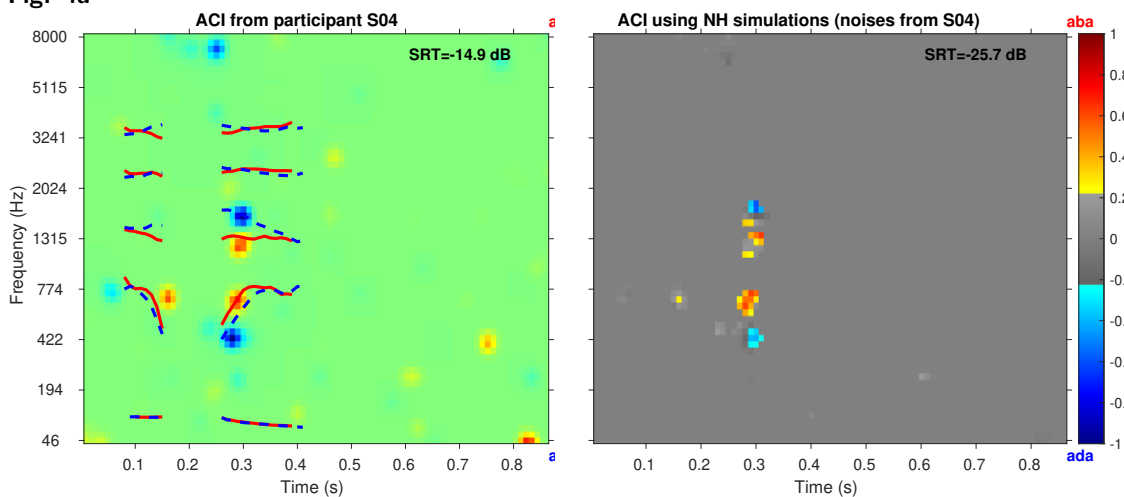



## Comparing ACIs from experiments/simulations (2 of 2)

Fig. 4b

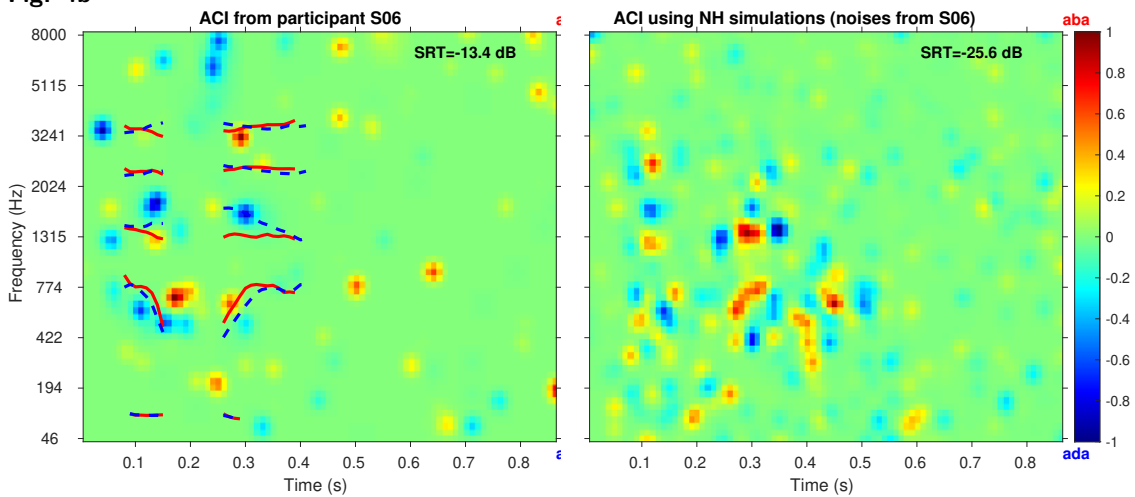

This means that all the cues in the experimental ACIs are a subgroup of the cues from ACIsim

## Comparing ACIs from experiments/simulations (2 of 2)

Fig. 4b

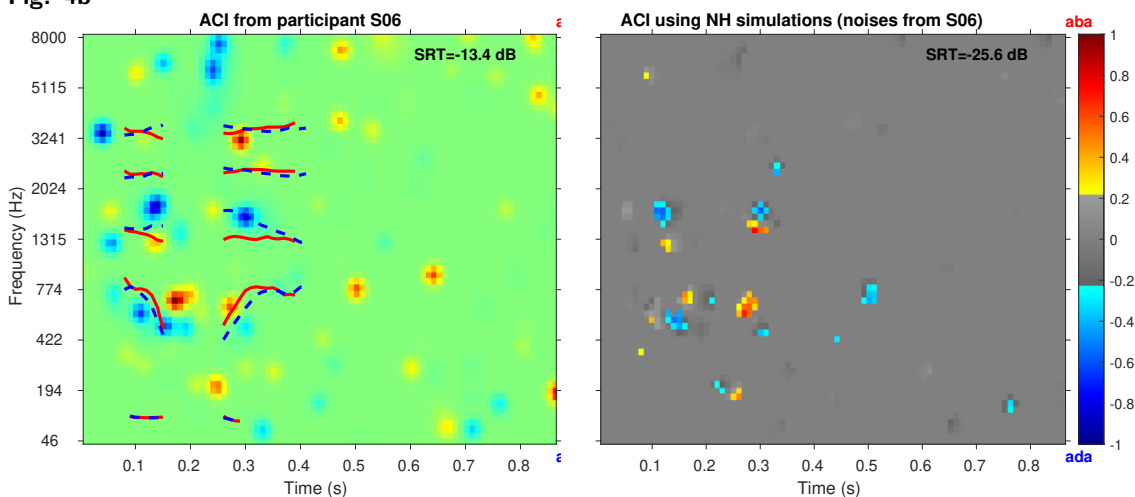

This means that all the cues in the experimental ACIs are a subgroup of the cues from ACIsim



## Using the auditory model: possibilities and limitations

- Template matching: based on the idea of “optimal detection” (*Green & Swets, 1966*)
- A very simple top-down decision back-end
- The auditory model as shown here: simulates a normal-hearing listener
- **Are these results related to the specific auditory model (front end)?**

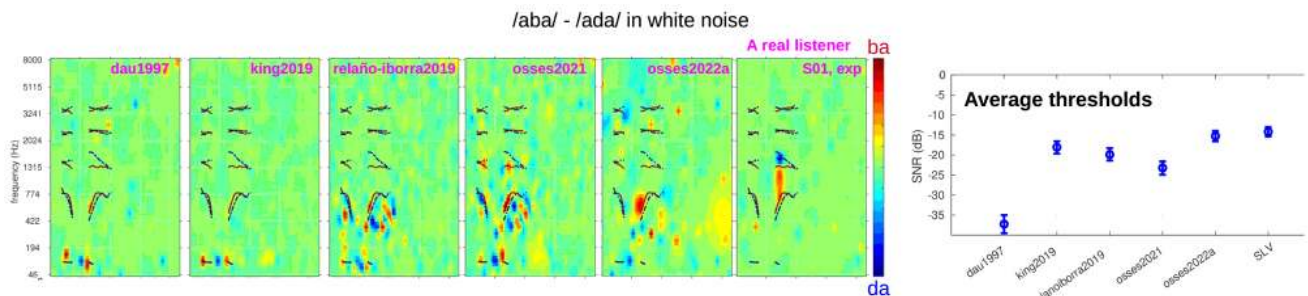

AMT models using the two-template matching (Figure taken from *Osses et al. 2022 (AABBA)*)

## Using the auditory model: possibilities and limitations

- Template matching: based on the idea of “optimal detection” (*Green & Swets, 1966*)
- A very simple top-down decision back-end
- The auditory model as shown here: simulates a normal-hearing listener
- **Are these results related to the specific decision (back end)?**

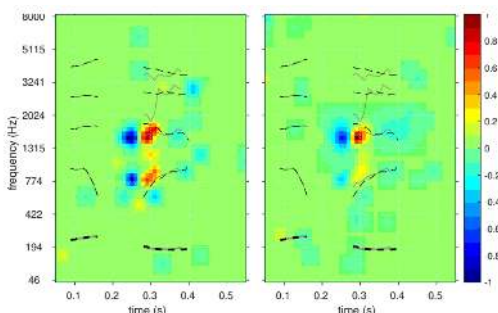

**Figure 3:** (Colour online) ACIs for the artificial listeners, i.e., the auditory model using the decision device 1 with  $K=0.39$  MU (left panel) and using the decision device 2 (right panel). The colour codes and axis legends are as in Fig. 1.

osses2021.m model using cross correlations (left) or two-dim Pearson correlations (right)  
 [Figure taken *Osses & Varnet (2021, DAGA)*]

## Using the auditory model: possibilities and limitations

- Individualisation of the model?
- This model was developed to simulate psychoacoustic tasks
- Hearing impairment can be introduced, but it is not straightforward:
  - 1 We cannot introduce an audiogram as in other models (e.g., from AMT [Majdak et al. (2022)]: zilany2014, bruce2018)
  - 2 Impairment can be introduced by this requires a careful understanding of the model stages and their expected effect (Holube & Kollmeier (1996))

## Using the auditory model: possibilities and limitations

- Individualisation of the model?
- **HI model:** Model with wider auditory filters and modified time constants in the adaptation loops (inspired by Holube1996)

Fig. 5:

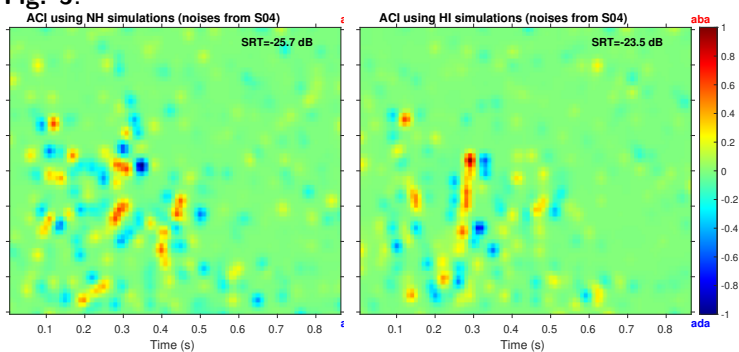

But, big advantage:

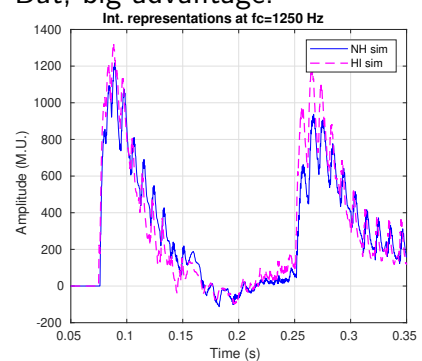



## References

- Dau, T., Kollmeier, B., & Kohlrausch, A. (1997). Modeling auditory processing of amplitude modulation. I. Detection and masking with narrow-band carriers. *J. Acoust. Soc. Am.*, *102*, 2892–2905. <https://doi.org/10.1121/1.420344>
- Holube, I., & Kollmeier, B. (1996). Speech intelligibility prediction in hearing-impaired listeners based on a psychoacoustically motivated perception model. *J. Acoust. Soc. Am.*, *100*, 1703–1716. <https://doi.org/10.1121/1.417354>
- Majdak, P., Hollomey, C., & Baumgartner, R. (2022). AMT 1.x: A toolbox for reproducible research in auditory modeling. *Acta Acustica*, *6*, 19. <https://doi.org/10.1051/aacus/2022011>
- Osses, A., & Varnet, L. (2021). Consonant-in-noise discrimination using an auditory model with different speech-based decision devices. *DAGA*, 298–301. <https://hal.archives-ouvertes.fr/hal-03345050>
- Osses, A., & Kohlrausch, A. (2021). Perceptual similarity between piano notes: Simulations with a template-based perception model. *J. Acoust. Soc. Am.*, *149*, 3534–3552. <https://doi.org/10.1121/10.0004818>
- Osses, A., Lorenzi, C., & Varnet, L. (2022). Assessment of individual listening strategies in amplitude-modulation detection and phoneme categorisation tasks. *International Congress on Acoustics*. Gyeongju, South Korea (Presentation: [click here](#))
- Osses, A., & Varnet, L. (2022). *fastACI toolbox: the MATLAB toolbox for investigating auditory perception using reverse correlation (v1.2)*. <https://doi.org/10.5281/zenodo.7314014>
- Osses, A., Varnet, L., & Lorenzi, C. (2022). Simulating the perception of soundscapes, speech-, AM- and FM- sounds. *AABBA*. Vienna, Austria. <https://hal.archives-ouvertes.fr/hal-03554232>