



HAL
open science

Modelisation of Light Transmission through Surfaces with Thin Film Optical Coating in Geant4

L. Cappellugola, S. Curtoni, M. Dupont, C.H. Sung, V. Sharyy, C. Thibault,
D. Yvon, C. Morel

► To cite this version:

L. Cappellugola, S. Curtoni, M. Dupont, C.H. Sung, V. Sharyy, et al.. Modelisation of Light Transmission through Surfaces with Thin Film Optical Coating in Geant4. 2021 IEEE Nuclear Science Symposium (NSS) and Medical Imaging Conference (MIC) and 28th International Symposium on Room-Temperature Semiconductor Detectors, Oct 2021, Yokohama, Japan. pp.1-5, 10.1109/NSS/MIC44867.2021.9875513 . hal-03863051

HAL Id: hal-03863051

<https://hal.science/hal-03863051>

Submitted on 5 Apr 2023

HAL is a multi-disciplinary open access archive for the deposit and dissemination of scientific research documents, whether they are published or not. The documents may come from teaching and research institutions in France or abroad, or from public or private research centers.

L'archive ouverte pluridisciplinaire **HAL**, est destinée au dépôt et à la diffusion de documents scientifiques de niveau recherche, publiés ou non, émanant des établissements d'enseignement et de recherche français ou étrangers, des laboratoires publics ou privés.

Modelisation of light transmission through surfaces with thin film optical coating in Geant4

L. Cappellugola, S. Curtoni, M. Dupont, C.-H. Sung, V. Sharyy, C. Thibault, D. Yvon and C. Morel, *Member, IEEE*

Abstract—Surfaces with optical coating may be used to improve light transmission between a scintillating crystal and a photodetector. For the ClearMind project, we develop a detection module made of a PbWO_4 crystal and a photocathode directly deposited on a thin passivation film coating the crystal face. Scintillation photons will then be transmitted through this thin film that has a thickness of the order of the scintillation light wavelength. Interference phenomena and frustrated transmission beyond the limit angle have then to be considered. We present the modelisation of light transmission through surfaces with optical coating with Geant4, which is achieved by defining a new method that provides a probability of transmission of a visible-UV photons through the coated interface

I. INTRODUCTION

THE aim of the ClearMind project is to develop a *scintronic* crystal (Fig. 1) that combines scintillation and photoelectron generation for ultra-fast time-resolved gamma detection [1]. For this, we use a lead tungstate (PWO) crystal [2] of refractive index $n_{\text{PWO}} = 2.3$ at 420 nm, which has fast scintillation constants and acts as well as a Cerenkov radiator, and a photocathode of refractive index $n_{\text{PC}} = 3.0$ at 420 nm [3] deposited directly on the crystal face encapsulated within a Micro-Channel Plate-Multiplier Tube (MCP-MT). To protect the photocathode from oxidation induced by PWO, it must be deposited on a thin passivation film coating the crystal face. Since the passivation film thickness is smaller than the wavelength of the generated photons (350 to 700 nm, with a scintillation maximum around 420 nm), interference phenomena have to be considered for the optical tracking of the scintillation and Cerenkov photons. Moreover, frustrated transmission beyond the limit incidence angle θ_{lim} (Eq. 1) is possible instead of the sole total reflection. Indeed, when a total reflection occurs at an interface between two dielectric media, an evanescent wave appears within the skin depth of the second medium propagating along the interface [4]. If a thin film is deposited between the two media, and if its thickness is small enough relatively to the skin depth (Eq. 2 for a dielectric-dielectric interface) and the wavelength of the incident wave (λ), the energy of the evanescent wave may be transmitted across this film into the next medium. From a photon particle tracking point of view, this translates into a transmission probability of the photon through the thin film, known as the transmittance of the interface.

L. Cappellugola, S. Curtoni, M. Dupont and C. Morel are with Aix-Marseille Univ, CNRS/IN2P3, CPPM, Marseille, France.

C.-H. Sung, V. Sharyy, C. Thibault and D. Yvon are with Univ Paris-Saclay, CEA, Institut de recherche sur les lois Fondamentales de l'Univers, 91191, Gif-sur-Yvette, France.

$$\theta_{lim} = \arcsin\left(\frac{n_2}{n_1}\right) \quad (1)$$

$$\delta = \frac{\lambda}{2\pi\sqrt{n_1^2 \sin^2 \theta_1 - n_2^2}} \quad (2)$$

The Geant4 Monte Carlo code [5] does not account for thin film interfaces. Therefore, we have developed a new method called `CoatedDielectricDielectric()`, considering two media – a crystal and a photocathode – and the refractive index and thickness of the thin film separating these two media.

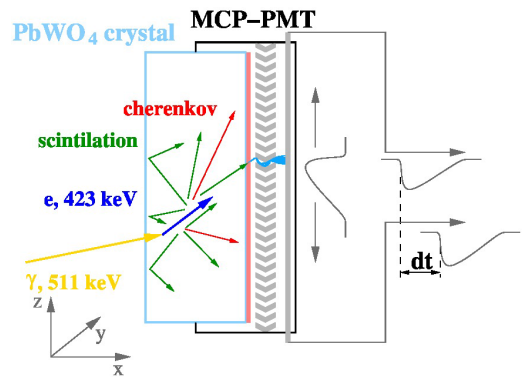

Fig. 1. Schematic of the *scintronic* crystal composed by a photocathode directly deposited on a PWO crystal. The scintronic crystal is embedded within a MCP-PMT.

II. MATERIAL AND METHODS

The reflectance $R = rr^*$ and the transmittance $T = \frac{n_t \cos(\theta_t)}{n_i \cos(\theta_i)} tt^*$ represent the probability of a photon to be either reflected or transmitted through the interface ($R + T = 1$), with r and t the Fresnel reflection and transmission coefficients, respectively, and θ_i and θ_t the angle of incidence and refraction of the photon on the interface plane, respectively.

A. Theoretical reflectance and transmittance through thin film

Reflection coefficients depend on the refractive indices of the dielectric media, on the polarization of the electromagnetic wave, on its wavelength and on the thickness of the thin film. Let r_{ij} be the Fresnel coefficient describing an interface between media i and j , with refractive indices n_i and n_j . If $n_i > n_j$ and if the incidence angle θ_i is superior to the limit angle θ_{lim} , the term $n_j \cos(\theta_j)$ in the Fresnel coefficients will be replaced by $i\gamma = \sqrt{n_i^2 \sin^2 \theta_i - n_j^2}$ [6]. Hence we get:

TABLE I

REFLECTANCE AND TRANSMITTANCE FORMULAS THROUGH STANDARD INTERFACE AND THIN FILM INTERFACE. THE PART FRAMED IN RED HIGHLIGHTS FORMULAS USED IN THE CONTEXT OF AN INTERFACE CONTAINING A THIN LAYER AS MEDIUM 2. TE AND TM STAND FOR *transverse electric* AND *transverse magnetic* POLARIZATIONS, RESPECTIVELY.

Feuille1

		Reflection	Transmission		R and T	
Simple interface	Normal incidence	$r_{ij,TE}=r_{ij,TM}=\frac{n_i-n_j}{n_i+n_j}$	$t_{ij,TE}=t_{ij,TM}=\frac{2n_i}{n_i+n_j}$	Relation between Fresnel coefficients	$R= r ^2$	
	Oblique incidence	$\theta_i < \theta_{lim}$	$r_{ij,TE}=\frac{n_i \cos \theta_i - n_j \cos \theta_j}{n_i \cos \theta_i + n_j \cos \theta_j}$ $r_{ij,TM}=\frac{n_i \cos \theta_j - n_j \cos \theta_i}{n_i \cos \theta_j + n_j \cos \theta_i}$	$t_{ij,TE}=\frac{2n_i \cos \theta_i}{n_i \cos \theta_i + n_j \cos \theta_j}$ $t_{ij,TM}=\frac{2n_i \cos \theta_i}{n_i \cos \theta_j + n_j \cos \theta_i}$	$r_{TE}+1=t_{TE}$ $n_1(1-r_{TM})=n_2 t_{TM}$	$T=\frac{n_i \cos \theta_t}{n_i \cos \theta_i} t ^2$
		$\theta_i > \theta_{lim}$	Total internal reflection			
Thin layer	Normal incidence	$r=\frac{r_{12}+r_{23} \cdot e^{2i\beta}}{1+r_{12} \cdot r_{23} \cdot e^{2i\beta}}$	$t=\frac{t_{12} t_{23} e^{i(k_2-k_3)d}}{1+r_{12} r_{23} e^{2i\beta}} \approx \frac{t_{12} t_{23} e^{i\beta}}{1+r_{12} r_{23} e^{2i\beta}}$	$\beta=k_2 d$ $k_2=n_2 \frac{2\pi}{\lambda_0}$	$R+T=1$	
	Oblique incidence	$\theta_i < \theta_{lim}$	$r=\frac{r_{12}+r_{23} \cdot e^{2i\beta'}}{1+r_{12} \cdot r_{23} \cdot e^{2i\beta'}}$	$t=\frac{t_{12} t_{23} e^{i\beta'}}{1+r_{12} r_{23} e^{2i\beta'}}$	$\beta'=k_2 d \cos \theta_2$	
		$\theta_i > \theta_{lim}$	$r=\frac{r_{12}+r_{23} \cdot e^{2\beta''}}{1+r_{12} \cdot r_{23} \cdot e^{2\beta''}}$	$t=\frac{t_{12} t_{23} e^{\beta''}}{1+r_{12} r_{23} e^{2\beta''}}$	$\beta''=-k_0 d \gamma$	
			Δ Taking r_i for simple interface for $\theta < \theta_{lim}$ and replacing $n_j \cos(\theta_j)$ by $i\gamma$	$r_{12,TE}=\frac{n_1 \cos \theta_i - i\gamma}{n_1 \cos \theta_i + i\gamma}$ $r_{12,TM}=\frac{n_1 i\gamma - n_2^2 \cos \theta_i}{n_1 i\gamma + n_2^2 \cos \theta_i}$	$t_{12,TE}=\frac{2n_1 \cos \theta_i}{n_1 \cos \theta_i + i\gamma}$ $t_{12,TM}=\frac{2n_1 n_2 \cos \theta_i}{n_1 i\gamma + n_2^2 \cos \theta_i}$	$k_0=\frac{2\pi}{\lambda_0}$ $\gamma=\sqrt{n_1^2 \sin^2 \theta_1 - n_2^2}$

Droite représentative de la variation de T en fonction de d pour un angle incident de 60° et lambda = 300nm

$$r_{ij,\theta > \theta_{lim},TE} = \frac{20n_i \cos(\theta_i) - i\gamma}{30n_i \cos(\theta_i) + i\gamma} \quad (3)$$

$$r_{ij,\theta > \theta_{lim},TM} = \frac{n_i i\gamma - n_j^2 \cos(\theta_i)}{n_i i\gamma + n_j^2 \cos(\theta_i)} \quad (4)$$

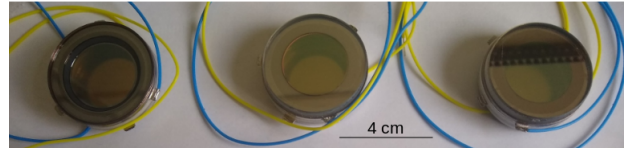

Page 1

Fig. 2. Picture of the three test cells

where TE and TM stand for *transverse electric* and *transverse magnetic* polarizations, respectively. In case of a transmission from the crystal (medium 1 with refractive index n_1) to the photocathode (medium 3 with refractive index $n_3 > n_1$) through a thin passivation film (medium 2 with refractive index $n_2 < n_1 < n_3$), the reflection coefficient for incidence angles inferior and superior to the limit angle $\theta_{lim} = \arcsin(\frac{n_2}{n_1})$ is given by:

$$r_{\theta < \theta_{lim}} = \frac{r_{12} + r_{23} e^{2i\beta'}}{1 + r_{12} r_{23} e^{2i\beta'}} \quad (5)$$

$$r_{\theta > \theta_{lim}} = \frac{r_{12} + r_{23} e^{2\beta''}}{1 + r_{12} r_{23} e^{2\beta''}} \quad (6)$$

where $\beta' = k_2 d \cos \theta_2$ and $\beta'' = -k_0 d \gamma$ as presented in Table. I, and $k_m = \frac{2\pi}{\lambda_m} = n_m \frac{2\pi}{\lambda_0}$ the wavenumber in medium m , k_0 and λ_0 the wavenumber and the wavelength in the vacuum, and d the film thickness.

All the reflectance and transmittance formulas are listed in the Table. I.

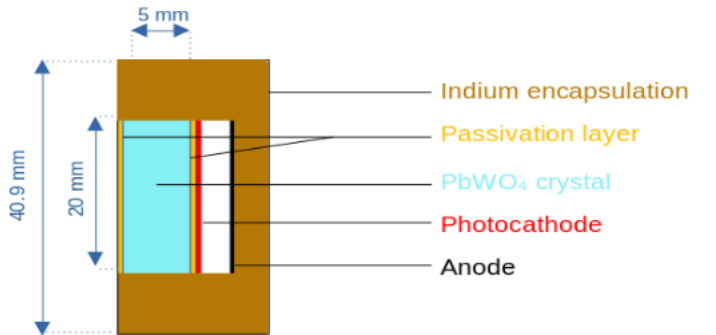

Fig. 3. Layout of the PWO test cell

B. Integration of frustrated transmission in Geant4

The main method allowing the description of frustrated transmission of the `G4OpBoundaryProcess` class is the `PostStepDoIt()` method. This method starts by getting refractive indices of both the media on either side of the interface, instantiating the `Type`, `Model` and `Finished` properties of this optical surface and calling the corresponding function in order

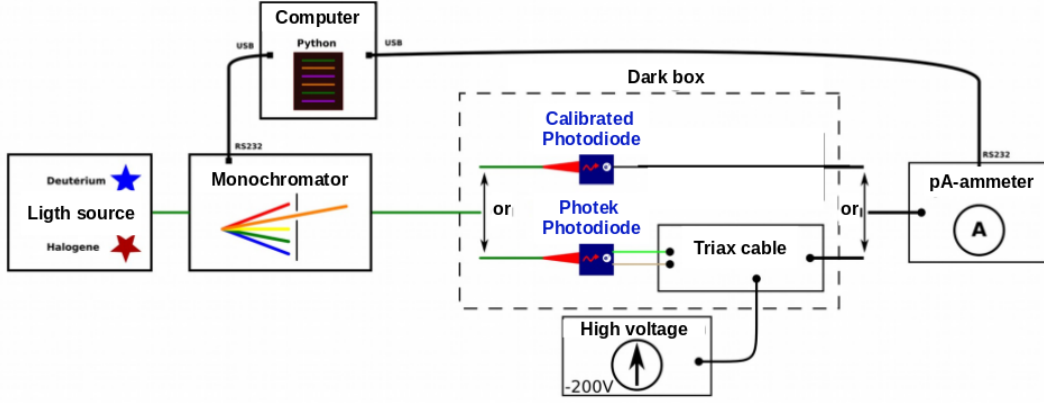

Fig. 4. Sketch of the setup used to measure the detection efficiencies of the experimental test cells.

to analyse the interaction on the interface correctly.

We have introduced a new surface type named `coating` used for an interface between two dielectric volumes separated by a thin film and a new method named `CoatedDielectricDielectric()`, which is called by `PostStepDoIt()` and is implemented within the `UnifiedGeant4` model. Only two volumes have to be defined: the crystal and the photocathode. The surface can be parametrized with two arrays named `RindexTL` and `ThicknessTL`, which correspond to the thin film refractive index and thickness, respectively. Please note that the roughness of the interface is not taken into account by the model that treats the surface as perfectly polished. Frustrated transmission for incidence angles superior to the limit angle can be enabled or disabled via the boolean parameter `frustrated` in order to assess the impact of frustrated transmission.

C. Measurements with experimental test cells

Three experimental test cells, which are shown on Fig. 2, have been manufactured by Photek Ltd (St Leonards-on-Sea, UK). The first one is made of a cylindrical 5 mm-thick quartz crystal with a photocathode directly deposited on its rear face sealed in a vacuum tube. Both the other ones are made of a 5 mm-thick PWO crystal with a thin film deposited on its front and rear faces and a photocathode directly deposited on its rear face sealed in a vacuum tube, as is illustrated on Fig. 3.

For these measurements, we have used a beam from an halogen and a deuterium lamps with 0.8 mm diameter and 3° divergence defined by the use of a converging lens of focal length 6 mm followed by an iris. The wavelength is selected thanks to a `Omni- λ 2047i` monochromator with a bandwidth of 10 nm. The test cell is characterized against calibrated photodiodes from Thorlabs. The test cells were biased using -200 V. Photodiode currents were measured using a Keithley pico-ammeter as sketched on Fig. 4.

Currents I_{CAL} and I_{PHOTEK} of the calibrated photodiode and test cells, respectively, were averaged over four measurements as a function of wavelength for different incidence

angles. Then the sensitivity of the test cell S_{PHOTEK} [A/W] is estimated as from by following the Eq. 7.

$$S_{PHOTEK} = \frac{I_{PHOTEK} S_{CAL}}{I_{CAL}} \quad (7)$$

Finally, Detection Efficiency (DE) is defined by Eq. 8.

$$DE = S_{PHOTEK} \frac{hc}{e\lambda} \quad (8)$$

with $\frac{hc}{e\lambda}$ the energy of the photon expressed in eV. The detection efficiency takes into account the quantum efficiency of the photocathode multiplied by the probability of transmission of the beam from the air to the photocathode through the different media composing the test cell.

III. RESULTS

A. Theoretical comparison of transmission through different thin passivation film materials

The transmittance of visible light photons from PWO to a photocathode was computed through several thin passivation films: oxides of silicon (SiO_2), aluminum (Al_2O_3), titanium (TiO_2), tantalum (Ta_2O_3) and zirconium (ZrO_2), considering their refractive indices (Fig. 5) as a function of wavelength. Figure. 6 presents the average transmittance calculated for TE polarization light impinging isotropically on the PWO/oxide interface. Note that TiO_2 has a higher transmittance since its refractive index superior to the refractive index of PbWO_4 (Fig. 5). Since the refractive indices of the four other materials are smaller than the PWO refractive index, frustrated transmission will occur for incidences larger than the limit angle. The contribution of frustrated transmission is highlighted on Fig. 6 by comparing the dashed and solid lines that correspond to the transmittance calculated without and with frustrated transmission, respectively. For instance, at least 60% of transmittance results from frustrated transmission with SiO_2 .

B. Assessment of the Monte Carlo implementation

If we fix n_{PWO} , n_{PC} and the refractive index and thickness of the thin passivation film to $n_{TL} = 1.5$ and $d_{TL} = 100$ nm, the fraction of photons transmitted through the interface estimated

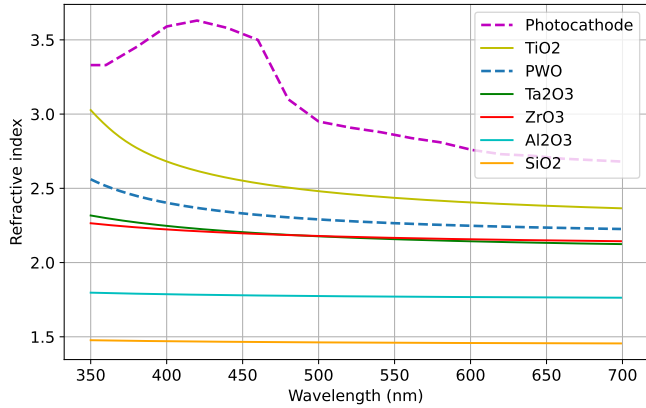

Fig. 5. Refractive index as a function of a wavelength for several passivation materials under study

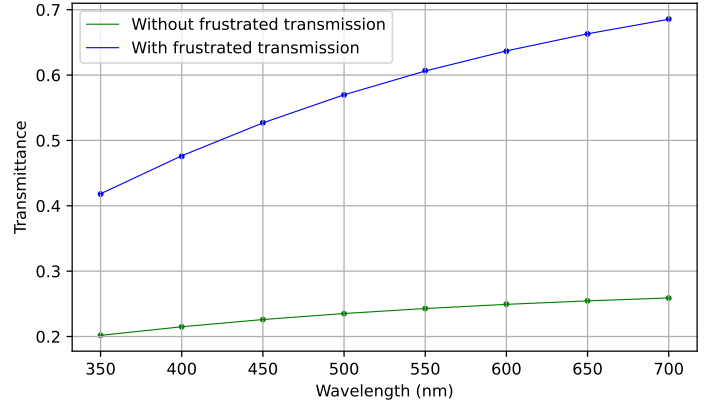

Fig. 7. Comparison between theoretical transmittance (line) and collection efficiencies (points) estimated from the simulation of 750,000 photons as a function of wavelength for a 100 nm thick thin film.

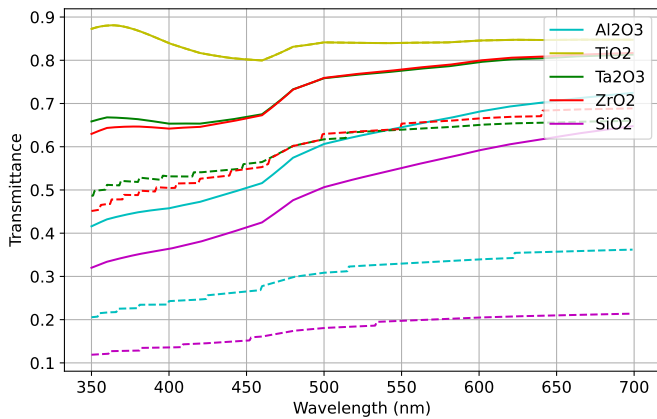

Fig. 6. Average transmittance for TE polarization as a function of wavelength impinging isotropically on the PWO/oxide interface for 100 nm thick films. Solid and dashed lines correspond to the transmittances averaged with and without taking into account frustrated transmission, respectively.

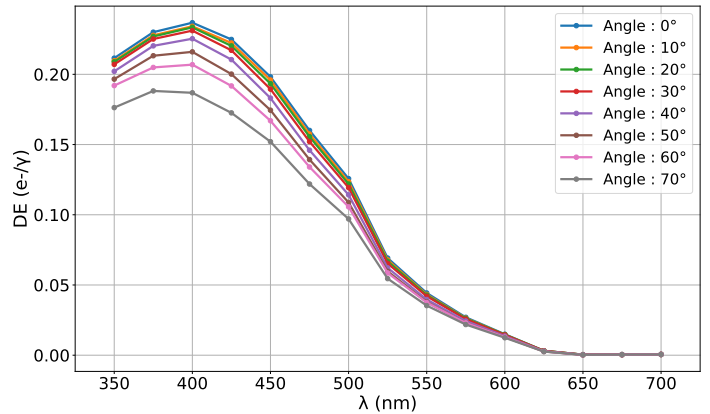

Fig. 8. Detection efficiency of PWO test cells measured as a function of wavelength and for different incidence angles.

by the Monte Carlo simulation of 750,000 visible light photons with Geant4 as a function of their wavelength is shown on Figure 7 and compared to the calculated theoretical transmittance curves. Like for Figure 6, we note that more than 50% of the photon collection probability through the interface is granted by frustrated transmission.

C. Experimental results analysis

The detection efficiency of the test cells was computed thanks to the Eq. 8. The results are represented on the Figure. 8. Note the maximum of detection efficiency at 400 nm, which matches well the 420 nm peak emission of the PWO.

DISCUSSION

We foresee to validate our Monte Carlo model against measurements of test cells in a future work.

All the theoretical and simulated transmittances will be estimated for a unpolarized light, while only the Transverse Electric polarization was taken into account up to now.

CONCLUSION

For the ClearMind project, we are developing a model for light transmission through surfaces with thin film optical coating within Geant4. The transmittance of visible light through a thin film has been computed and quantified as a function of the wavelength, the angle of incidence, and the refractive indices of the thin film and both two media enclosing it. Then, we have developed a new C++ method for Geant4 to model interference phenomena and frustrated transmission through a thin film. This C++ method will be proposed to the Geant4 collaboration in view of its incorporation into the official release of the Monte Carlo software. Despite the necessity to use thin passivation layers of refractive indices smaller than the PWO refractive index in order to protect the photocathode deposited on the crystal surface, frustrated transmission of light impinging beyond the limit angle increases transmittance considerably and hence the scintillation and Cerenkov photon collection efficiency through the interface.

ACKNOWLEDGMENT

This work was funded by the French National Research Agency (ANR) under reference, ANR-19-CE19-0009-03.

REFERENCES

- [1] D. Yvon *et al.*, “Design study of a ”scintronic” crystal targeting tens of picoseconds time resolution for gamma ray imaging: the clearmind detector,” *J. Instrum.*, vol. 15, pp. 250–303, 6 2020.
- [2] S. Baccaro *et al.*, “Measurements of refractive index in PbWO_4 ,” in *Proc. of the Int. Conf. on Inorganic Scintillators and their Applications* (P. Dorenbos and C.W.E. van Eijk, eds.), pp. 293–295, Delft University Press, Dec. 1996.
- [3] D. Motta and S. Schönert, “Optical properties of bialkali photocathodes,” *NIMA*, vol. 539, pp. 217–234, 2005.
- [4] J.-M. Vigoureux, *De l’onde évanescente de Fresnel au champ proche optique*, vol. 28, pp. 525–545. Annales de la Fondation Louis de Broglie, 2003.
- [5] S. Agostinelliae *et al.*, “Geant4—a simulation toolkit,” *Nucl. Instrum. Methods A*, vol. 506, pp. 250–303, 6 2003.
- [6] M. Born and E. Wolf, *Principles of Optics: Electromagnetic Theory of Propagation, Interference and Diffraction of Light*, ch. Basic properties of electromagnetic field. Elsevier, June 2013.