



**HAL**  
open science

# A Bacterial Two-Hybrid System for In Vivo Assays of Protein-Protein Interactions and Drug Discovery

Daniel Ladant

► **To cite this version:**

Daniel Ladant. A Bacterial Two-Hybrid System for In Vivo Assays of Protein-Protein Interactions and Drug Discovery. Paola Sperandeo. Lipopolysaccharide Transport: methods and protocols, 2548, Springer US, pp.145-167, 2022, Methods in Molecular Biology, 978-1-0716-2581-1 (ebook). 10.1007/978-1-0716-2581-1\_10 . hal-03858761

**HAL Id: hal-03858761**

**<https://hal.science/hal-03858761v1>**

Submitted on 25 Nov 2022

**HAL** is a multi-disciplinary open access archive for the deposit and dissemination of scientific research documents, whether they are published or not. The documents may come from teaching and research institutions in France or abroad, or from public or private research centers.

L'archive ouverte pluridisciplinaire **HAL**, est destinée au dépôt et à la diffusion de documents scientifiques de niveau recherche, publiés ou non, émanant des établissements d'enseignement et de recherche français ou étrangers, des laboratoires publics ou privés.



Distributed under a Creative Commons Attribution - NonCommercial 4.0 International License

## **Chapter in Lipopolysaccharide Transport-Methods and Protocols book**

### **A bacterial two-hybrid system for *in vivo* assays of protein-protein interactions and drug discovery.**

**Daniel Ladant**

Unité de Biochimie des Interactions Macromoléculaires,  
Département de Biologie Structurale et Chimie, CNRS UMR 3528  
Institut Pasteur, 28, rue du Dr Roux, Paris, Cedex 15, France  
tel: +33145688400 - daniel.ladant@pasteur.fr

#### **i. Summary/Abstract**

The Bacterial Adenylate Cyclase-based Two-Hybrid (BACTH) system is a robust and simple genetic assay to monitor protein-protein interactions *in vivo*. This system is based on functional complementation between two fragments from the catalytic domain of *Bordetella pertussis* adenylate cyclase (AC) to reconstitute a cyclic AMP (cAMP)-signaling cascade in *Escherichia coli*. Interaction between two chimeric proteins results in synthesis of cAMP that activates transcription of various catabolite operons leading to selectable phenotypes. One advantageous feature of this signalling cascade is that the physical association between the two interacting hybrid proteins is spatially separated from the transcriptional activation readout. Consequently the BACTH system can detect protein-protein interactions occurring at various subcellular localizations. The system has been used to characterize interactions between soluble or membrane proteins, from prokaryotic, eukaryotic, or viral origin. The BACTH assay can be used to uncover the region(s), domain(s) or amino acid residue(s) of a protein involved in the interaction with a specific partner. The BACTH system can also be adapted for high-throughput screening of small molecules able to interfere with protein-protein interactions.

#### **ii. Key Words**

Bacterial two-hybrid system, *Escherichia coli*, cyclic AMP, protein interaction, multimolecular complex, membrane proteins.

## 1. Introduction

Two-hybrid systems are genetic assays that permit the detection and characterization of protein-protein interactions *in vivo*. Specific protein-protein interactions are implicated in most biological processes. Characterization of such interactions is therefore essential for better understanding of living organisms at the molecular level [1]. Various two-hybrid systems or protein-complementation assays (PCA) have been elaborated in the past decades [2,3], following the pioneering work of Fields & Song who designed the yeast two-hybrid [4]. All these techniques are based on the co-expression, in the same cell, of two hybrid proteins that produce a characteristic trait when they associate [2]. In the bacterial two-hybrid system (BACTH, for "Bacterial Adenylate Cyclase-based Two-Hybrid"), the interactions result in the functional complementation between two fragments from an adenylate cyclase enzyme, to reconstitute a cAMP signaling cascade in *E. coli* [5]. The BACTH system is particularly appropriate to analyze interactions between membrane proteins and is now widely used in the scientific community as a tool to characterize protein-protein interactions *in vivo* [6–9]. I describe below the basic principles of this genetic system and provide robust protocols for a rapid set up and application of the technique to particular research project. Advantages and potential problems/difficulties of the technique for the characterization of specific protein-protein interactions (PPI) are briefly discussed as well as possible application in high-throughput screening of small molecule able to inhibit a PPI of interest.

### *Principle of the BACTH system*

The BACTH system takes advantage of the biochemical properties of the catalytic domain of the adenylate cyclase (AC) from *Bordetella pertussis*, the causative agent of whooping cough [10]. AC has a modular structure, made of two complementary fragments, T25 and T18 [11–13]. As the enzyme active site is located at the T25/T18 interface, the fragments are inactive when physically separated. When the T25 and T18 fragments are expressed in an *E. coli cya* strain (i.e. lacking endogenous adenylate cyclase) as separate entities, they are unable to recognize each other and cannot reconstitute a functional enzyme (Figure 1A). When the T25 and T18 moieties are

genetically fused to interacting polypeptides, say X and Y, heterodimerization of these hybrid proteins results in a functional complementation between the T25 and T18 fragments leading to cAMP synthesis (Figure 1B). Cyclic AMP produced by the reconstituted chimeric enzyme binds to the catabolite activator protein, CAP. The cAMP/CAP complex is a pleiotropic regulator of gene transcription in *E. coli* [14]: it activates the transcription of several resident genes, including genes of the *lac* and *mal* operons involved in lactose and maltose catabolism (Figure 1C). Therefore, bacteria that express interacting hybrid proteins become able to utilize lactose or maltose. This can be easily monitored on indicator and/or selective media. Moreover, quantification of the relative efficiency of complementation can be easily achieved by measuring the  $\beta$ -galactosidase activity in bacterial cultures, as the expression of this *E. coli* workhorse enzyme is strongly cAMP-dependent [5,9,15].

#### *Overview of the procedure*

Characterization of *in vivo* interactions between two proteins of interest is easily achieved with the BACTH system following a three-step procedure (Figure 2), involving:

1 - Construction of recombinant plasmids expressing the two proteins of interest (e.g. X and Y) as fusions with T25 or T18. This is performed *via* standard molecular genetic techniques. Various vectors can be used to express the T25 (pKT25 or pKNT25), or the T18 (pUT18 or pUT18C) hybrid proteins with fusions at either the N or the C terminus end of the cyclase moieties.

2 - Co-transformation of a pair of recombinant plasmids encoding the T25 and T18 fusions into an *E. coli cya* reporter strain. The co-transformed cells are plated on indicator or selective media to reveal the resulting *Cya*<sup>+</sup> phenotype (Figure 2). Appropriate controls with parental empty BACTH vectors for example or with BACTH plasmids expressing non-interacting fusions should be run in parallel to ascertain the validity of the assay.

3 - The efficiency of complementation between specific hybrid proteins can be then easily quantified by measuring the  $\beta$ -galactosidase enzymatic activities in bacterial extracts, using many well-known, colored (ONPG, X-gal) or fluorescent substrates. The cAMP production (the direct readout of the reconstituted adenylate cyclase enzymatic

activity) can also be monitored although the assay is more tedious and rarely done [5,15].

The hybrid proteins expressed in *E. coli* can be further characterized by using diverse biochemical approaches, such as immunodetection, immunoprecipitation, copurification, etc, to better define the interacting proteins.

The BACTH system is now commonly used by many laboratories to reveal a wide variety of interactions between small polypeptides, bacterial, eukaryotic, or viral proteins [9,16]. A major advantage of this genetic assay is that, thanks to the use a cAMP signaling cascade, the interaction between the two hybrid proteins can be spatially separated from the transcriptional readout. Hence, the BACTH system has gained popularity to study interactions between membrane proteins and is currently widely exploited to characterize multimolecular bacterial machineries involved in secretion, signaling, cell division, cell wall biogenesis, etc (for some selected references see [9]).

## **2. Materials**

### **2.1. Solutions and Buffers**

**2.1.1** Ampicillin: 100 mg/mL in water, stored at  $-20^{\circ}\text{C}$ .

**2.1.2** Kanamycin: 50 mg/mL in water, stored at  $-20^{\circ}\text{C}$ .

**2.1.3** Maltose (glucose-free) : 20% in water, sterilized by filtration, stored at room temperature.

**2.1.4** IPTG (isopropyl-b-D-thiogalactopyranoside) : stock solution of 100 mM in deionized water, sterilized by filtration, stored at  $-20^{\circ}\text{C}$ .

**2.1.5** X-gal (5-Bromo-4-chloro-3-indolyl-b-D-galactopyranoside ;  $\beta$ -galactosidase chromogenic substrate) : stock solution of 20 mg/ml in dimethyl formamide, stored at  $-20^{\circ}\text{C}$ .

**2.1.6** ONPG (o-nitrophenol- $\beta$ -galactoside ;  $\beta$ -galactosidase chromogenic substrate) : stock solution of 4 mg/ mL in PM2 buffer, stored at  $-20^{\circ}\text{C}$ .

**2.1.7** PM2 buffer ( $\beta$ -galactosidase assay medium) : 70 mM  $\text{Na}_2\text{HPO}_4 \cdot 12 \text{H}_2\text{O}$ , 30 mM  $\text{NaH}_2\text{PO}_4 \text{H}_2\text{O}$ , 1 mM  $\text{MgSO}_4$ , 0.2 mM  $\text{MnSO}_4$ , pH 7.0, stored at room

temperature, and supplemented with 100 mM  $\beta$ -mercaptoethanol just before use.

**2.1.8** Chloroform.

**2.1.9** 20% sodium dodecyl sulfate (SDS).

**2.1.10** 1 M  $\text{Na}_2\text{CO}_3$ .

## **2.2. Bacterial media**

2.2.1 Luria-Bertani (LB) broth : 5 (or 10) g/L NaCl, 10 g/L tryptone, 10 g/L yeast extract, pH adjusted to 7.0 with NaOH, sterilized with an autoclave, kept at room temperature.

2.2.2. M63 minimal medium (5 times concentrated) : 10 g/L  $(\text{NH}_4)_2\text{SO}_4$ , 68 g/L  $\text{KH}_2\text{PO}_4$ , 2.5 mg/L  $\text{FeSO}_4 \cdot 7\text{H}_2\text{O}$ , 5 mg/L vitamin B1, pH adjusted to 7.0 with KOH, sterilized with an autoclave, kept at room temperature.

2.2.3 MacConkey agar base medium: preferentially from Difco Laboratories (cat # 216830)

## **2.3. Bacterial strains and plasmids**

- . 2.3.1. *E. coli* reporter strain carrying a deletion of the *cya* gene : Table 1 lists several strains that have been used in BACTH assays but other *E. coli cya* strains (see *E. coli* strain collection at <http://cgsc.biology.yale.edu>) can also be used. Other recently described strains include, oxi-BTH a *cya* strain that carries additional mutations allowing disulfide bonds formation in the cytoplasm and KV1, a *cya* strain that harbors the *Photorhabdus luminescens luxCDABE* operon under control of the LacZ promoter, to monitor protein-protein interactions by light emission [17,18].
- . 2.3.2. BACTH vectors for expression of the hybrid proteins in BACTH *cya* bacteria. Two sets of compatible BACTH plasmids are available (Table 2 and Fig. 3) to construct genetic fusions of the proteins of interest at either the N- or the C-terminus of the T25 fragment (pKT25, pKNT25 and other derivatives) or T18 fragment (pUT18, pUT18C, and other derivatives). In both cases, the T25 fragment (corresponding to the first 224 amino acids of *B. pertussis* cyclase CyaA) and T18 fragment (amino acids 225 to 399 of CyaA) are expressed under

the control of a *lac* promoter and are appended to a multi-cloning site sequence (MCS) to allow construction of in-frame fusions at either their N-terminal or C-terminal extremities (Fig 3). Various derivatives of these plasmids have been designed and their characteristics are summarized in Table 2. Of note, a serie of plasmid can be used to probe periplasmic proteins thanks to the insertion of a hydrophobic transmembrane segment between the cyclase fragments and the MCS [19] .

#### **2.4 Materials and equipments for microbiology and standard molecular biology techniques**

- . Biosafety cabinet, chemical fume hood, Incubators, shakers, heat block, PCR thermocycler, electroporator, spectrophotometer, equipment for gel electrophoresis, gel imaging system, centrifuge, and other common equipments for molecular biology (plasticware, micropipets, tubes, etc...).

### **3. Methods**

The general methodology to analyze interactions between two proteins of interest with the BACTH system is schematized in Figure 2. Readers are expected to have a background knowledge in basic molecular biology techniques (including common microbiological techniques, DNA manipulations, basic enzymology, etc) or should seek appropriate advices and/or training otherwise. Additional protocols for molecular cloning, PCR, DNA analysis, and transformation can be found in many textbooks [20,21] or on Internet.

3.1 : Step 1: construction of recombinant plasmids expressing the two proteins of interest (say, X and Y) as fusions with T25 and T18. This is achieved by cloning the corresponding genes into the T25 and T18 expressing vectors (described in Table 2 and Figure 3) using a standard cloning approach [21].

- 1- Design appropriate primers to amplify the genes X and Y. The primers should contain specific restriction sites (ideally unique ones, e.g. *Bam*HI on 5' primer and *Kpn*I on 3' primer for example) so that the PCR amplified DNA fragment can be cloned in proper orientation into the BACTH vectors. It is critical to correctly position these cloning sites to insert the genes X and Y in frame with the T25 and T18 coding region.
- 2- PCR amplify the genes encoding X and Y using a standard protocol (Note 1) and purify the DNA fragments using any commercial PCR purification kit available from various companies (for example, MinElute PCR Purification Kit from Qiagen, <https://www.qiagen.com/>).
- 3- Digest the amplified fragments as well as the BACTH vectors with the appropriate restriction enzymes (e.g., *Bam*HI and *Kpn*I); check for full digestion by gel electrophoresis, then inactivate the enzymes (usually by heating) and finally ligate the digested fragments and vectors with T4 DNA ligase (Note 2).
- 4- Transform the ligation mixtures into *E. coli* competent cells (any standard *E. coli* K-12 cloning strain can be used, preferentially *recA* – to increase plasmid stability - and *lacI<sup>q</sup>* – to repress expression of hybrid proteins) and plate transformants on LB plates supplemented with appropriate antibiotics. Incubate plates at 30 °C for 24 - 36 h.
- 5- Pick few colonies (4–12) for each construction and grow them overnight at 30 °C in 4 mL of LB medium plus antibiotics. Purify plasmid DNA using a standard kit (e.g., QIAprep Spin Miniprep Kit from Qiagen), and identify recombinant plasmids by restriction analysis (Note 3). Verify by DNA sequencing that the PCR amplification and cloning steps have not introduced any unwanted mutations in the genes of interest.

Alternative methods to construct the BACTH plasmids using the Gibson cloning methods [22] or the Gateway recombineering techniques [23,24] are described in Note 4 and Note 5, respectively.



Control plasmids encoding the unfused T25 and T18 fragments, as well as plasmids encoding the T25 and T18 fused to control interacting proteins (e.g. the leucine zipper motifs from GCN4) should also be prepared in parallel in order to serve as negative and positive controls in BACTH assays [5,25].

### 3. 2 : Step 2: Assay of interaction between hybrid proteins in *E. coli cya* cells.

Probing of interactions is straightforwardly achieved by simple co-transformation of a pair of recombinant plasmids encoding the T25-X (or X-T25) and T18-Y (or Y-T18) hybrid proteins into competent BACTH cells (Table 1) and plating the transformed cells on indicator plates (supplemented with appropriate antibiotics) to reveal the resulting *Cya*<sup>+</sup> phenotype (Figure 2).

1 - Prepare electro-competent or chemically competent *E. coli Δcya* cells (e.g., DHM1 strain) using a standard procedure [20,21] (see Note 6).

2 – To co-transform the competent cells (e.g. DHM1) with the purified pKT25-X and pUT18C-Y plasmid DNA, chill a microcentrifuge tube in ice, add 50 μl of chemically competent cells, 1 μl (or 5-10 ng) of purified pKT25-X, and 1 μl (or 5-10 ng) of purified pUT18C-Y plasmid, and incubate about 20-30 min at 4°C. Transfer the tube to a heat block equilibrated at 42°C for 2 min, add 1 ml of LB broth and incubate the cell suspension 60 to 90 min at 30 - 37 °C (to permit expression of the antibiotic resistance marker).

3 - Plate the transformation mixture on either LB-X-gal-IPTG or on MacConkey-maltose-IPTG agar plates supplemented with appropriate antibiotics (Note 7). Depending upon the competency level of the prepared competent cells, different volumes of the transformation mixtures may be plated in order to obtain about 100 to 300 colonies/plate. Incubate the plates at 30°C for 24 to 48 hr. Plates can also be incubated at 37°C, but in general complementation is less efficient than at 30°C.

The cells expressing interacting hybrid proteins form blue colonies on LB-X-gal-IPTG, as the expression of the β-galactosidase is positively controlled by cAMP/CAP. X-gal is a widely used chromogenic substrate for β-galactosidase: it yields a dark blue precipitate at the site of enzymatic activity. Cells expressing non-interacting hybrids remain white or

pale blue (Fig. 2). IPTG is added to the medium to increase the expression of the  $\beta$ -galactosidase reporter gene as well as that of the hybrid proteins T25-X (or X-T25) and T18-Y (or Y-T18) that are transcribed under the control of a pLac promoter.

On MacConkey/maltose/IPTG, the cells expressing interacting hybrid proteins form red colonies. This results from the ability of the  $Cya^+$  cells to ferment maltose leading to an acidification of the medium and color change of the phenol red dye present in the MacConkey medium. The cells that express non-interacting proteins (i.e.,  $Cya^-$ ) are unable to ferment maltose and form white or pale pink colonies.

It is important to plate in parallel on the same lot of indicator plates, BACTH cells transformed with plasmids encoding interacting hybrid proteins as positive control, and cells transformed with plasmids coding for non-interacting fusions as negative control, in order to properly appreciate the phenotypic readout of colony staining on these media and thus reliably interpret the results of the two-hybrid assay. Depending upon the efficiency of complementation between the proteins of interest, the staining may be more or less pronounced and comparison with known controls is essential for avoiding any misinterpretation (Note 8).

Many published studies are relying solely on this phenotypic assay to characterize interactions among different hybrid proteins and/or to identify region(s) or sub-domain(s) or even specific amino acid residues implicated in interaction of a protein with a given partner. This is usually carried out by replicating or spotting side by side the different transformants that are to be compared, in parallel with positive and negative control (see examples in some recently published works [26–32]).

A more stringent phenotypic assay can be carried out by using a selective medium that consists in a synthetic minimal medium supplemented with maltose as a unique carbon source (Note 9). Because the *mal* regulon involved in maltose catabolism is strictly cAMP/CAP dependent, only  $Cya^+$  bacteria can utilize maltose as a carbon source. Therefore, in the BACTH system, only cells that express interacting hybrid proteins are  $Cya^+$  and thus able to grow on a minimal medium plus maltose (Figure 2). X-gal and IPTG are also commonly added to the medium to facilitate the early visualization of the  $Cya^+$  colonies as these cells should also be  $Lac^+$  and turn blue on X-gal containing medium [33–36].

Actually, the selection procedure on minimal medium/maltose is more particularly appropriate for screening libraries in order to isolate potential partners of a protein of interest, as a large number of transformants can be plated on a single plate [7,37]. Detailed protocol for constructing BACTH libraries and performing screening experiments can be found elsewhere [9,16,38].

3. 3 Step 3 : Quantification of functional complementation between hybrid proteins by  $\beta$ -galactosidase assays.

Although many studies are relying solely on phenotypic assays on indicator plates for qualitative analysis of interactions between hybrid proteins, a more quantitative evaluation of the functional complementation can be easily obtained by measuring the  $\beta$ -galactosidase activity in bacteria cells. Many methods for measuring  $\beta$ -galactosidase activities in liquid cultures of bacterial cells are reported in literature [20,21]. A simple protocol to assay  $\beta$ -galactosidase activity in permeabilized cells in a 96-well array format is described below (and schematized in Figure 4) :

- 1- Distribute 300 to 400  $\mu$ l/well of sterile LB broth supplemented with 0.5 mM IPTG and appropriate antibiotics, in a 96-well microtiter plate (2.2-ml 96-well sterile, polypropylene deep-well block).
- 2- With a sterile toothpick (or pipet tip), inoculate single colonies into individual wells. Several (commonly eight) independent colonies from each set of transformations should be tested in parallel. Positive and negative control cells (eg DHM1/pKT25-zip/pUT18-zip and DHM1/pKT25/pUT18) are grown in parallel and several wells are kept non-inoculated for background measurements.
- 3- Seal the plate with a microporous tape sheet (e.g., AirPore from Qiagen) to allow gas exchange, and incubate overnight at 30°C on a rotary shaker. Position of the plate should be adjusted (eventually tilted) to allow appropriate agitation of the cultures in the microwells.
- 4- After the overnight incubation, dilute the cultures 5-fold by adding an appropriate volume of M63 medium to the deep-well microplate.

- 5- Transfer 200 µl of the diluted cultures into a flat-bottom 96-well microtiter plate. Record the absorbance at 600 nm (or similar wavelengths) ( $A_{600}$ ) with a microplate reader and store data in a spreadsheet program.
- 6- Transfer 200 µl of the diluted cultures into a new microtiter plate (1.2-ml polypropylene 96-well storage block) and permeabilize the bacteria. This is preferentially carried out under a fume hood. To each well, add 7 µl of 0.05% SDS (sodium dodecyl sulfate) and 10 µl of chloroform and then, mix vigorously by pipetting up and down several times. Finally, the plate is left at room temperature under a fume hood for 30 to 40 min to allow chloroform evaporation.
- 7- In a new microtiter plate, distribute 105 µl/well of PM2 buffer containing 100 mM 2-mercaptoethanol (freshly added just before use) and 0.1% (w/v) *o*-nitrophenol- $\beta$ -galactoside (ONPG). Add 20-µl aliquots of the permeabilized cell suspensions (from step 6) into each well to initiate the enzymatic reaction, and incubate the plate at room temperature for 20 to 60 min or until sufficient yellow color has developed (note the time). Blank assays should be run in parallel by adding 20 µl of M63 medium instead of permeabilized cells.
- 8- Stop the enzymatic reactions by adding 50 µl of 1 M  $\text{Na}_2\text{CO}_3$ . Read the absorbance at 405 nm ( $A_{405}$ ) with a microplate reader and store data in a spreadsheet program
- 9- Analyze data with appropriate software (e.g., Microsoft Excel or other spreadsheet program). For each well, calculate the enzymatic activity,  $E$  (in relative units), according to:
 
$$E = 1000 \times ( (A_{405} \text{ in sample wells} - A_{405} \text{ in control wells}) / (A_{600} \text{ in sample wells} - A_{600} \text{ in control wells}) ) / \text{min of incubation}$$

With this a 96-well array format, the results are generally expressed in relative units (RU) of  $\beta$ -galactosidase activity for each sample of interest, and therefore positive and negative controls (e. g. cells expressing interacting and non-interacting hybrid proteins) must be included in the assay.

The  $\beta$ -galactosidase activity of the positive control cells - generally, the *cya* host cells transformed with plasmids expressing T25 and T18 fused to the leucine zipper of GCN4 (T25-*zip* and T18-*zip*, Table 2, [5,15]) – is conveniently set as 100%. The  $\beta$ -galactosidase activity of the negative control cells (e.g. expressing the unfused T25 and T18 fragments) is usually below 2 - 3 % of that of the positive cells (depending also upon the genetic background of the host cell).

An interaction in BACTH assay can be safely considered positive when the cells expressing the hybrid proteins exhibit a  $\beta$ -galactosidase activity at least 5 times that of the negative control cells (e.g. expressing unfused T25 and T18 fragments), that is when the relative activity is above 10-15 % if the  $\beta$ -galactosidase activity of the negative control cells amounts to 2-3 %. Yet, lower levels of  $\beta$ -galactosidase activation may be interpreted as signature of interactions if proper controls are rigorously performed. Unfortunately some misinterpreted data may be found sometimes in the literature. An important point to keep in mind is that the lack of complementation between two hybrid proteins does not necessarily means that the two proteins do not associate: this can be due to the misfolding or instability of the hybrid proteins or their inability to form an active enzyme upon association (see for example [25]). Note that this restriction applies similarly to all two-hybrid techniques.

Conversely, false positive results may be observed with certain proteins that associate (or « stick ») to many other partners in a relatively nonspecific manner. This can be observed, in particular, with some integral membrane proteins that may generate positive complementation signal with other unrelated membrane proteins. Actually, such results may not even be considered as authentic “false positive,” because the BACTH complementations do correspond to a real association between the hybrid proteins, eventhough their interaction may be irrelevant from a physiological point of view. This reminds that caution should always be taken for proper interpretation of two-hybrid assays.

The measurement of the  $\beta$ -galactosidase activities in liquid cultures of cells expressing the hybrid proteins, as described above, offers a rapid and easy way to quantify the efficiency of functional complementation between two different hybrid

proteins. Quantification of  $\beta$ -galactosidase activity could also be done by fluorescent or chemiluminescent detection using appropriate substrates (e.g. MUG, FDG), either on bulk cultures or by using flow cytometry [39,40].

Recently, Volkwein and colleagues [18] described a *cya* strain in which the luxCDABE operon from *Photobacterium luminescens* is integrated downstream to the LacZ promoter. In this strain, interactions between hybrid proteins can be easily monitored by direct light emission from the lux operon in addition to the colorimetric detection of  $\beta$ -galactosidase activity [18].

Alternatively it is also possible to measure the production of cAMP (the direct readout from the association of the two interacting hybrid proteins) using ELISA assays (kits can be purchase from several companies), although the technique is a rather cumbersome and time consuming (and expensive when using a commercial kit !) so it is rarely performed.

### **3.4 Further characterization of hybrid proteins.**

In many cases, it is important to characterize biochemically and/or immunologically the hybrid proteins and eventually to quantify their level of expression in the complementing cells. Western blot analysis of the hybrid proteins is carried out using standard protocols [7,21]. A specific monoclonal antibody recognizing the T18 fragment is commercially available (Mab 3D1 or sc-13582 from Santa Cruz Biotechnology, Inc., <https://www.scbt.com/>). Other tags recognized by specific monoclonal antibodies (e.g. myc, HA, T7 etc) or an hexa-histidine motif can also be introduced in the cyclase fragments [41,42] to facilitate detection of the hybrid proteins and/or to perform immunoprecipitation experiments or pull-down assays in order to further demonstrate the physical association of the hybrid proteins [8,9].

### **3.5 Applications of BACTH assays.**

During the past 20 years, the BACTH technique has been widely applied for characterizing protein-protein interactions, in particular in the bacterial kingdom. In that case, the hybrid proteins can be expressed in a biological environment that is similar to their native one (including membrane or periplasm). Consequently, the BACTH assay

has become a popular method to decipher interactions involved in the assembly of multi-molecular machineries, and notably membrane-associated complexes implicated in diverse processes such as secretion, transport, signaling, cell division, etc [6,43–47]. It can be used to define the region(s) or domain(s) of a polypeptide implicated in the association with a partner protein and more precisely help to identify specific amino acids residues involved in the interaction [6,32,48–50]. This can be done straightforwardly by screening for mutations (introduced by error-prone PCR or other mutagenic methods) able to abolish the interaction. Another interesting application of the BACTH two-hybrid system is in drug discovery, where the technique can be implemented for high-throughput screening of small molecules able to block a given interaction [51] or characterize antibacterial molecules that interfere with the assembly of protein complexes [52,53]. It may thus be applied to search for novel antibiotics targeting interactions involved in the assembly of essential prokaryotic machineries.

#### 4. Notes

**Note 1 :** A typical PCR amplification of bacterial genes is carried out using 10-50 ng of purified chromosomal DNA as target, 1 - 2 pmol of primers, 100  $\mu$ M of each dNTPs and one of the many commercially available thermostable polymerases, in total volume of 100  $\mu$ l of appropriate buffers (provided with the polymerase). Twenty-five to 30 cycles of denaturation (1 - 3 min at 95 to 98°C, depending upon the thermostability of the polymerase), annealing (0.5 - 1 min at 50 to 68°C depending upon melting temperature of the particular primers, and elongation (1 min at 72°C) are usually carried out.

**Note 2:** Detailed protocols for performing restriction enzyme digestion of plasmids and PCR fragments, analysis by gel electrophoresis, and can be found in [20,21] as well as on the web sites of addgene (<https://www.addgene.org/protocols/pcr-cloning/>) or of the companies selling molecular biology reagents.

**Note 3 -** Vectors and recombinant plasmids are usually propagated at 30°C in standard *E. coli* K12 *recA* strains, preferentially in a strain that overproduces the LacI repressor to

prevent expression of the hybrid proteins (such as XL1-Blue). Plasmid DNA is routinely purified with commercial kits used for mini-preparation of DNA, according to manufacturer's instructions. Plasmid pKT25 and derivatives are low to middle copy-number plasmids so that the overall yield of DNA is not very high (about 50  $\mu$ L of purified DNA at 30-60 ng/ $\mu$ L may be obtained from a 2 ml overnight culture using standard Qiagen miniprep kits) while larger amount of DNA (about 5 to 10 times higher) can be obtained with the high copy-number vectors from the pUT18 series.

**Note 4 :** The Gibson Assembly Cloning method can easily assemble multiple linear DNA fragments and is a very efficient method for cloning the PCR-amplified genes into the BACTH plasmids (<https://www.addgene.org/mol-bio-reference/cloning/>). It only requires that the amplified DNA fragment contains ~20-30 base pair extensions (added *via* the PCR primers) that overlap with the sequences of insertion on the destination BACTH plasmid (linearized by one or preferentially 2 restriction enzymes, eg. *Bam*HI and *Kpn*l). The DNA fragments are joined in a single reaction, with three different enzymes, into a fully ligated double-stranded DNA molecule (see for detailed set up or the websites of companies selling molecular biology reagents). One major advantage of this approach is that, as the amplified DNA fragment is not any more digested before cloning, the presence in that fragment of restriction sites commonly used for cloning has not incidence.

**Note 5 :** The Gateway cloning technology (Thermo Fisher Scientific) technique is convenient for transferring genes of interest, cloned into a so-called "entry clone" into diverse "destination vectors" *via* a site-specific recombination reaction [23,24]. We [19,35] and others [42] implemented the BACTH system to make it compatible with the Gateway technique by designing BACTH destination vectors (BACTH<sub>GW</sub>), pST25-DEST, pSNT25-DEST, and pUT18C-DEST in which one can easily transfer genes from any Gateway entry clone. Cloning of genes of interest into Gateway entry clones is achieved by standard restriction or Gibson cloning [9,19,54]. Besides, synthetic genes cloned into entry vectors can nowadays be ordered from various companies for an affordable price, while clonal collections of genes or open-reading frames (orfs) encoded in Gateway



vectors are readily available from several companies or various academic institutions or scientific consortia. Further description of the Gateway cloning technique can be found on the manufacturer's Web site (<https://www.thermofisher.com/>) or other internet resources (e.g. <https://blog.addgene.org/plasmids-101-gateway-cloning> ; Cold Spring Harb Protoc; doi:10.1101/pdb.prot094938).

**Note 6:** Electro-competent or chemically competent *E. coli*  $\Delta cya$  cells (can be prepared using standard procedure [20,21]. Briefly, to prepare competent cells with the  $\text{CaCl}_2$  technique, first re-streak the cells (DHM1, DHT1, or BTH101) from a LB-DMSO stock solution (kept at  $-80^\circ\text{C}$ ) on a LB/X-gal/IPTG plate and grow overnight at  $37^\circ\text{C}$ . The next day, pick a white colony (i.e., *cya*; any blue colonies, likely  $\text{Lac}^+$  revertants or contaminants, should be discarded) and inoculate 5 ml of LB broth and grow overnight at  $30^\circ\text{C}$ . From the overnight preculture inoculate 0.4 liter LB broth and grow with vigorous agitation at  $37^\circ\text{C}$  to reach an  $\text{OD}_{600}$  of 0.25 to 0.3. Rapidly chill the culture on ice and pellet the cells by centrifugation for 10 min at  $3000 \times g$ ,  $4^\circ\text{C}$  (be careful to maintain cells, buffers, and culture flasks at  $4^\circ\text{C}$  at all stages of the process). Wash the cells two times in 50 ml ice-cold 0.1 M  $\text{CaCl}_2$  solution, and resuspend them in 6 to 8 ml ice-cold 0.1 M  $\text{CaCl}_2$  and incubate overnight at  $4^\circ\text{C}$ . The competency level ( $>10^6$  cfu/ $\mu\text{g}$ ) obtained with this procedure is sufficient for routine transformations. Protocol for preparing electrocompetent cells can be found in [21] and on internet (e.g. <https://www.addgene.org/protocols/bacterial-transformation/>).

**Note 7:** Preparation of indicator plates for monitoring BACTH complementation:

To prepare LB/X-gal plates, add 15 g of agar per liter of LB broth and autoclave. Allow the medium to cool down to less than  $45^\circ\text{C}$ , then add appropriate antibiotics (ampicillin at a final concentration of 100 mg/L; kanamycin at a final concentration of 50 mg/L) and just before pouring plates, 40 mg/L of the X-gal chromogenic substrate (5-Bromo-4-chloro-3-indolyl-b-D-galactopyranoside) and 0.5 mM IPTG (isopropyl-b-D-thiogalactopyranoside, added to induce full expression of the hybrid proteins and the  $\beta$ -galactosidase reporter enzyme).

To prepare MacConkey/maltose plates, dissolve 40 g of MacConkey agar base media (preferentially from Difco Laboratories - cat # 216830) in 1 liter of deionized water and autoclave. Allow the medium to cool down to less than 45°C, then add appropriate antibiotics (as above), IPTG (0.5 mM) and maltose (1% final concentration, from a stock solution of 20% glucose-free maltose in water, is sterilized by filtration).

**Note 8 :** When plating cells on indicator plates, the number of colonies should not exceed 300-500, otherwise it may be more difficult to visualize positive clones. It should be noted that after prolonged incubation (4 - 5 days), negative colonies (*i.e. cya<sup>-</sup>*) will show a weak red (on MacConkey-maltose) or blue spot (on LB-X-Gal) in the center, but will remain colorless at the periphery. It may be worth testing also the complementation at 37°C, although in most cases, complementation is much less efficient at this temperature than at 30°C.

**Note 9:** Preparation of selective plates for BACTH screening assay.

To prepare M63 minimal medium/maltose plates, first prepare a 5x concentrated M63 minimal medium. For this mix 10 g (NH<sub>4</sub>)<sub>2</sub>SO<sub>4</sub>, 68 g KH<sub>2</sub>PO<sub>4</sub>, 2.5 mg FeSO<sub>4</sub>·7H<sub>2</sub>O, 5 mg vitamin B1, into to a final volume of 1 liter of deionized H<sub>2</sub>O, adjust pH to 7.0 with KOH, and autoclave (16). To prepare M63/maltose plates, autoclave 15 g of agar in 800 ml H<sub>2</sub>O. Then add 200 ml sterile 5x M63 medium, 0.2-0.4 % maltose, 0.5 mM IPTG, 40 µg/ml X-gal (in order to better visualize the Cya<sup>+</sup> colonies (that are also Lac<sup>+</sup>) and the appropriate antibiotics at half the usual concentrations (*i.e.* ampicillin 50 µg/ml, kanamycin 25 µg/ml) just before pouring plates.

Depending upon the genetic background of the *cya* strain used, other essential nutrients may be needed for allowing growth on minimal medium. For example, the DHT1 strain needs to be supplemented with casamino acids to grow on minimal medium, due to its *ilv* genotype. When the minimal medium is supplemented with casamino acids, the DHT1 cells expressing non-interacting proteins may also exhibit a residual growth due to their ability to use these amino acids as carbon sources (see [34]).

Tables references:[55][56]

## Acknowledgments

This work was supported by Institut Pasteur and the Centre National de la Recherche Scientifique CNRS UMR 3528 (Biologie Structurale et Agents Infectieux). DL would like to thank the present and past members of the laboratory for their contributions to the development of the BACTH technology. DL is co-inventor of patents on the bacterial two-hybrid system.

## 5. References

1. Cafarelli, T.; Desbuleux, A.; Wang, Y.; Choi, S.; De Ridder, D.; Vidal, M. Mapping, Modeling, and Characterization of Protein–protein Interactions on a Proteomic Scale. *Curr. Opin. Struct. Biol.* **2017**, *44*, 201–210, doi:10.1016/j.sbi.2017.05.003.
2. Stynen, B.; Tournu, H.; Tavernier, J.; Van Dijck, P. Diversity in Genetic in Vivo Methods for Protein-Protein Interaction Studies: From the Yeast Two-Hybrid System to the Mammalian Split-Luciferase System. *Microbiol. Mol. Biol. Rev. MMBR* **2012**, *76*, 331–382, doi:10.1128/MMBR.05021-11.
3. Miller, K.E.; Kim, Y.; Huh, W.-K.; Park, H.-O. Bimolecular Fluorescence Complementation (BiFC) Analysis: Advances and Recent Applications for Genome-Wide Interaction Studies. *J. Mol. Biol.* **2015**, *427*, 2039–2055, doi:10.1016/j.jmb.2015.03.005.
4. Fields, S.; Song, O. A Novel Genetic System to Detect Protein-Protein Interactions. *Nature* **1989**, *340*, 245–246, doi:10.1038/340245a0.
5. Karimova, G.; Pidoux, J.; Ullmann, A.; Ladant, D. A Bacterial Two-Hybrid System Based on a Reconstituted Signal Transduction Pathway. *Proc. Natl. Acad. Sci. U. S. A.* **1998**, *95*, 5752–5756.
6. Karimova, G.; Dautin, N.; Ladant, D. Interaction Network among Escherichia Coli Membrane Proteins Involved in Cell Division as Revealed by Bacterial Two-Hybrid Analysis. *J. Bacteriol.* **2005**, *187*, 2233–2243, doi:10.1128/JB.187.7.2233-2243.2005.
7. Karimova, G.; Robichon, C.; Ladant, D. Characterization of YmgF, a 72-Residue Inner Membrane Protein That Associates with the Escherichia Coli Cell Division Machinery. *J. Bacteriol.* **2009**, *191*, 333–346, doi:10.1128/JB.00331-08.
8. Battesti, A.; Bouveret, E. The Bacterial Two-Hybrid System Based on Adenylate Cyclase Reconstitution in Escherichia Coli. *Methods San Diego Calif* **2012**, *58*, 325–334, doi:10.1016/j.ymeth.2012.07.018.
9. Ouellette, S.P.; Karimova, G.; Davi, M.; Ladant, D. Analysis of Membrane Protein Interactions with a Bacterial Adenylate Cyclase-Based Two-Hybrid (BACTH) Technique. *Curr. Protoc. Mol. Biol.* **2017**, *118*, 20.12.1–20.12.24,

doi:10.1002/cpmb.36.

10. Chenal, A.; Ladant, D. Bioengineering of Bordetella Pertussis Adenylate Cyclase Toxin for Antigen-Delivery and Immunotherapy. *Toxins* **2018**, *10*, doi:10.3390/toxins10070302.
11. Guo, Q.; Shen, Y.; Lee, Y.-S.; Gibbs, C.S.; Mrksich, M.; Tang, W.-J. Structural Basis for the Interaction of Bordetella Pertussis Adenylyl Cyclase Toxin with Calmodulin. *EMBO J.* **2005**, *24*, 3190–3201, doi:10.1038/sj.emboj.7600800.
12. Ladant, D. Interaction of Bordetella Pertussis Adenylate Cyclase with Calmodulin. Identification of Two Separated Calmodulin-Binding Domains. *J. Biol. Chem.* **1988**, *263*, 2612–2618.
13. O'Brien, D.P.; Durand, D.; Voegelé, A.; Hourdel, V.; Davi, M.; Chamot-Rooke, J.; Vachette, P.; Brier, S.; Ladant, D.; Chenal, A. Calmodulin Fishing with a Structurally Disordered Bait Triggers CyaA Catalysis. *PLoS Biol.* **2017**, *15*, e2004486, doi:10.1371/journal.pbio.2004486.
14. Busby, S.; Ebright, R.H. Transcription Activation by Catabolite Activator Protein (CAP). *J. Mol. Biol.* **1999**, *293*, 199–213, doi:10.1006/jmbi.1999.3161.
15. Karimova, G.; Ullmann, A.; Ladant, D. A Bacterial Two-Hybrid System That Exploits a cAMP Signaling Cascade in Escherichia Coli. *Methods Enzymol.* **2000**, *328*.
16. Karimova, G.; Gaudiard, E.; Davi, M.; Ouellette, S.P.; Ladant, D. Protein-Protein Interaction: Bacterial Two-Hybrid. *Methods Mol. Biol. Clifton NJ* **2017**, *1615*, 159–176, doi:10.1007/978-1-4939-7033-9\_13.
17. Houot, L.; Navarro, R.; Nouailler, M.; Duché, D.; Guerlesquin, F.; Lloubes, R. Electrostatic Interactions between the CTX Phage Minor Coat Protein and the Bacterial Host Receptor TolA Drive the Pathogenic Conversion of Vibrio Cholerae. *J. Biol. Chem.* **2017**, *292*, 13584–13598, doi:10.1074/jbc.M117.786061.
18. Volkwein, W.; Krafczyk, R.; Jagtap, P.K.A.; Parr, M.; Mankina, E.; Macošek, J.; Guo, Z.; Fürst, M.J.L.J.; Pfab, M.; Frishman, D.; et al. Switching the Post-Translational Modification of Translation Elongation Factor EF-P. *Front. Microbiol.* **2019**, *10*, 1148, doi:10.3389/fmicb.2019.01148.
19. Ouellette, S.P.; Gaudiard, E.; Antosova, Z.; Ladant, D. A Gateway((R)) -Compatible Bacterial Adenylate Cyclase-Based Two-Hybrid System. *Environ. Microbiol. Rep.* **2014**, *6*, 259–267, doi:10.1111/1758-2229.12123.
20. Miller, J.H. *A Short Course in Bacterial Genetics: A Laboratory Manual and Handbook for Escherichia Coli and Related Bacteria*; Cold Spring Harbor Laboratory Press.; CSHL Press: Cold Spring Harbor, NY., 1992; Vol. Volume 1;.
21. Sambrook, J.; Russell, D.W.; Sambrook, J. *The Condensed Protocols from Molecular Cloning: A Laboratory Manual*; Cold Spring Harbor Laboratory Press: Cold Spring Harbor, N.Y, 2006; ISBN 0-87969-772-5.
22. Gibson, D.G.; Young, L.; Chuang, R.-Y.; Venter, J.C.; Hutchison, C.A.; Smith, H.O. Enzymatic Assembly of DNA Molecules up to Several Hundred Kilobases. *Nat. Methods* **2009**, *6*, 343–345, doi:10.1038/nmeth.1318.

23. Hartley, J.L.; Temple, G.F.; Brasch, M.A. DNA Cloning Using in Vitro Site-Specific Recombination. *Genome Res.* **2000**, *10*, 1788–1795.
24. Sands, B.; Brent, R. Overview of Post Cohen-Boyer Methods for Single Segment Cloning and for Multisegment DNA Assembly. *Curr. Protoc. Mol. Biol.* **2016**, *113*, 3.26.1–3.26.20, doi:10.1002/0471142727.mb0326s113.
25. Karimova, G.; Ullmann, A.; Ladant, D. Protein-Protein Interaction between *Bacillus Stearothermophilus* Tyrosyl-tRNA Synthetase Subdomains Revealed by a Bacterial Two-Hybrid System. *J. Mol. Microbiol. Biotechnol.* **2001**, *3*, 73-82.
26. Logger, L.; Aschtgen, M.-S.; Guérin, M.; Cascales, E.; Durand, E. Molecular Dissection of the Interface between the Type VI Secretion TssM Cytoplasmic Domain and the TssG Baseplate Component. *J. Mol. Biol.* **2016**, *428*, 4424–4437, doi:10.1016/j.jmb.2016.08.032.
27. Krasteva, P.V.; Bernal-Bayard, J.; Travier, L.; Martin, F.A.; Kaminski, P.-A.; Karimova, G.; Fronzes, R.; Ghigo, J.-M. Insights into the Structure and Assembly of a Bacterial Cellulose Secretion System. *Nat. Commun.* **2017**, *8*, 2065, doi:10.1038/s41467-017-01523-2.
28. Thongsomboon, W.; Serra, D.O.; Possling, A.; Hadjineophytou, C.; Hengge, R.; Cegelski, L. Phosphoethanolamine Cellulose: A Naturally Produced Chemically Modified Cellulose. *Science* **2018**, *359*, 334–338, doi:10.1126/science.aao4096.
29. Vega, D.E.; Margolin, W. Direct Interaction between the Two Z Ring Membrane Anchors FtsA and ZipA. *J. Bacteriol.* **2019**, *201*, doi:10.1128/JB.00579-18.
30. Fogg, P.C.M.; Younger, E.; Fernando, B.D.; Khaleel, T.; Stark, W.M.; Smith, M.C.M. Recombination Directionality Factor gp3 Binds  $\phi$ C31 Integrase via the Zinc Domain, Potentially Affecting the Trajectory of the Coiled-Coil Motif. *Nucleic Acids Res.* **2018**, *46*, 1308–1320, doi:10.1093/nar/gkx1233.
31. Caccamo, P.D.; Jacq, M.; VanNieuwenhze, M.S.; Brun, Y.V. A Division of Labor in the Recruitment and Topological Organization of a Bacterial Morphogenic Complex. *Curr. Biol. CB* **2020**, *30*, 3908–3922.e4, doi:10.1016/j.cub.2020.07.063.
32. Cook, J.; Baverstock, T.C.; McAndrew, M.B.L.; Stansfeld, P.J.; Roper, D.I.; Crow, A. Insights into Bacterial Cell Division from a Structure of EnvC Bound to the FtsX Periplasmic Domain. *Proc. Natl. Acad. Sci. U. S. A.* **2020**, *117*, 28355–28365, doi:10.1073/pnas.2017134117.
33. Pearce, M.J.; Mintseris, J.; Ferreyra, J.; Gygi, S.P.; Darwin, K.H. Ubiquitin-like Protein Involved in the Proteasome Pathway of *Mycobacterium Tuberculosis*. *Science* **2008**, *322*, 1104–1107, doi:10.1126/science.1163885.
34. Ouellette, S.P.; Karimova, G.; Subtil, A.; Ladant, D. *Chlamydia* Co-opts the Rod Shape-Determining Proteins MreB and Pbp2 for Cell Division. *Mol. Microbiol.* **2012**, *85*, 164–178, doi:10.1111/j.1365-2958.2012.08100.x.
35. Gauliard, E.; Ouellette, S.P.; Rueden, K.J.; Ladant, D. Characterization of Interactions between Inclusion Membrane Proteins from *Chlamydia Trachomatis*. *Front. Cell. Infect. Microbiol.* **2015**, *5*, 13, doi:10.3389/fcimb.2015.00013.

36. Lee, J.; Cox, J.V.; Ouellette, S.P. Critical Role for the Extended N Terminus of Chlamydial MreB in Directing Its Membrane Association and Potential Interaction with Divisome Proteins. *J. Bacteriol.* **2020**, *202*, doi:10.1128/JB.00034-20.
37. Darwin, K.H. The Proteasome of Mycobacterium Tuberculosis Is Required for Resistance to Nitric Oxide. *Science* **2003**, *302*, 1963–1966, doi:10.1126/science.1091176.
38. Karimova, G.; Davi, M.; Ladant, D. The Beta-Lactam Resistance Protein Blr, a Small Membrane Polypeptide, Is a Component of the Escherichia Coli Cell Division Machinery. *J. Bacteriol.* **2012**, *194*, 5576–5588, doi:10.1128/JB.00774-12.
39. Miao, F.; Todd, P.; Kompala, D.S. A Single-Cell Assay of B-Galactosidase in Recombinant Escherichia Coli Using Flow Cytometry. *Biotechnol. Bioeng.* **1993**, *42*, 708–715, doi:10.1002/bit.260420605.
40. Van Poucke, S.O.; Nelis, H.J. Development of a Sensitive Chemiluminometric Assay for the Detection of Beta-Galactosidase in Permeabilized Coliform Bacteria and Comparison with Fluorometry and Colorimetry. *Appl. Environ. Microbiol.* **1995**, *61*, 4505–4509, doi:10.1128/AEM.61.12.4505-4509.1995.
41. Battesti, A.; Bouveret, E. Improvement of Bacterial Two-Hybrid Vectors for Detection of Fusion Proteins and Transfer to pBAD-Tandem Affinity Purification, Calmodulin Binding Peptide, or. *Proteomics* **2008**, *8*, 4768–4771, doi:10.1002/pmic.200800270.
42. Wille, T.; Barlag, B.; Jakovljevic, V.; Hensel, M.; Sourjik, V.; Gerlach, R.G. A Gateway-Based System for Fast Evaluation of Protein-Protein Interactions in Bacteria. *PLoS One* **2015**, *10*, e0123646, doi:10.1371/journal.pone.0123646.
43. Georgiadou, M.; Castagnini, M.; Karimova, G.; Ladant, D.; Pelicic, V. Large-Scale Study of the Interactions between Proteins Involved in Type IV Pilus Biology in Neisseria Meningitidis: Characterization of a Subcomplex Involved in Pilus Assembly. *Mol. Microbiol.* **2012**, *84*, 857–873, doi:10.1111/j.1365-2958.2012.08062.x.
44. Cisneros, D.A.; Bond, P.J.; Pugsley, A.P.; Campos, M.; Francetic, O. Minor Pseudopilin Self-Assembly Primes Type II Secretion Pseudopilus Elongation. *EMBO J.* **2012**, *31*, 1041–1053, doi:10.1038/emboj.2011.454.
45. Falord, M.; Karimova, G.; Hiron, A.; Msadek, T. GraXSR Proteins Interact with the VraFG ABC Transporter To Form a Five-Component System Required for Cationic Antimicrobial Peptide Sensing and Resistance in Staphylococcus Aureus. *Antimicrob. Agents Chemother.* **2012**, *56*, 1047–1058, doi:10.1128/AAC.05054-11.
46. Rowlett, V.W.; Margolin, W. The Bacterial Divisome: Ready for Its Close-Up. *Philos. Trans. R. Soc. Lond. B. Biol. Sci.* **2015**, *370*, doi:10.1098/rstb.2015.0028.
47. Mehla, J.; Caufield, J.H.; Sakhawalkar, N.; Uetz, P. A Comparison of Two-Hybrid Approaches for Detecting Protein–Protein Interactions. In *Methods in Enzymology*; Elsevier, 2017; Vol. 586, pp. 333–358 ISBN 978-0-12-809743-4.
48. Luo, Z.-Q.; Isberg, R.R. Multiple Substrates of the Legionella Pneumophila Dot/Icm System Identified by Interbacterial Protein Transfer. *Proc. Natl. Acad. Sci.* **2004**,

101, 841–846, doi:10.1073/pnas.0304916101.

49. Qin, R.; Sang, Y.; Ren, J.; Zhang, Q.; Li, S.; Cui, Z.; Yao, Y.-F. The Bacterial Two-Hybrid System Uncovers the Involvement of Acetylation in Regulating of Lrp Activity in *Salmonella Typhimurium*. *Front. Microbiol.* **2016**, *7*, doi:10.3389/fmicb.2016.01864.
50. Gonzalez, G.M.; Durica-Mitic, S.; Hardwick, S.W.; Moncrieffe, M.C.; Resch, M.; Neumann, P.; Ficner, R.; Görke, B.; Luisi, B.F. Structural Insights into RapZ-Mediated Regulation of Bacterial Amino-Sugar Metabolism. *Nucleic Acids Res.* **2017**, *45*, 10845–10860, doi:10.1093/nar/gkx732.
51. Paschos, A.; den Hartigh, A.; Smith, M.A.; Atluri, V.L.; Sivanesan, D.; Tsolis, R.M.; Baron, C. An in Vivo High-Throughput Screening Approach Targeting the Type IV Secretion System Component VirB8 Identified Inhibitors of *Brucella Abortus 2308* Proliferation. *Infect. Immun.* **2011**, *79*, 1033–1043, doi:10.1128/IAI.00993-10.
52. Olvera, M.R.; Garai, P.; Mongin, G.; Vivès, E.; Gannoun-Zaki, L.; Blanc-Potard, A.-B. Synthetic Hydrophobic Peptides Derived from MgtR Weaken *Salmonella* Pathogenicity and Work with a Different Mode of Action than Endogenously Produced Peptides. *Sci. Rep.* **2019**, *9*, doi:10.1038/s41598-019-51760-2.
53. Moura, E.C.C.M.; Baeta, T.; Romanelli, A.; Laguri, C.; Martorana, A.M.; Erba, E.; Simorre, J.-P.; Sperandio, P.; Polissi, A. Thanatin Impairs Lipopolysaccharide Transport Complex Assembly by Targeting LptC–LptA Interaction and Decreasing LptA Stability. *Front. Microbiol.* **2020**, *11*, doi:10.3389/fmicb.2020.00909.
54. Olson, M.G.; Goldammer, M.; Gauliard, E.; Ladant, D.; Ouellette, S.P. A Bacterial Adenylate Cyclase-Based Two-Hybrid System Compatible with Gateway((R)) Cloning. *Methods Mol. Biol. Clifton NJ* **2018**, *1794*, 75–96, doi:10.1007/978-1-4939-7871-7\_6.
55. Dautin, N.; Karimova, G.; Ullmann, A.; Ladant, D. Sensitive Genetic Screen for Protease Activity Based on a Cyclic AMP Signaling Cascade in *Escherichia Coli*. *J. Bacteriol.* **2000**, *182*, 7060–7066.
56. Karimova, G.; Ladant, D.; Ullmann, A.; Selig, L.; Legrain, P. Bacterial Two-Hybrid System for Protein-Protein Interaction Screening, New Strains for Use Therein, and Their Applications 2002. US Patent US20020045237A1

**Table 1: Commonly used BACTH reporter strains**

Strain	Genotype	Comments	Ref
DHT1	$F^-$ , <i>cya-854</i> , <i>ilv 691::Tn10</i> , <i>recA1</i> , <i>endA1</i> , <i>gyrA96 (Nal<sup>r</sup>)</i> , <i>thi1</i> , <i>hsdR17</i> , <i>spoT1</i> , <i>rfbD1</i> , <i>glnV44(AS)</i>	A <i>recA</i> strain that exhibits a high BACTH complementation efficiency and fast growth, but needs to be supplemented with casamino acids to grow on minimal medium (due to <i>ilv</i> phenotype)	55
DHM1	$F^-$ , <i>cya-854</i> , <i>recA1</i> , <i>endA1</i> , <i>gyrA96 (Nal<sup>r</sup>)</i> , <i>thi1</i> , <i>hsdR17</i> , <i>spoT1</i> , <i>rfbD1</i> , <i>glnV44(AS)</i>	A <i>ilv+</i> derivative of DHT1. This <i>recA</i> strain can grow on minimal media plus sugars. Yet it shows a slower growth and lower complementation efficiency as compared to the parental DHT1 strain.	6
BTH101	$F^-$ , <i>cya-99</i> , <i>araD139</i> , <i>galE15</i> , <i>galK16</i> , <i>rpsL1 (Str<sup>r</sup>)</i> , <i>hsdR2</i> , <i>mcrA1</i> , <i>mcrB1</i>	A $Rec^+$ strain that displays an intermediate BACTH complementation efficiency and fast growth. Useful for BACTH library screening on minimal media plus sugars.	56
Oxi-BTH	$F^-$ , <i>cya°</i> , <i>fhuA2 lacZ::T7 gene1 [lon]</i> <i>ompT ahpC gal <math>\lambda</math>att::pNEB3-r1-cDsbC</i> <i>(SpecR, lacIq) <math>\Delta</math>trxB sulA11 R(mcr-73::miniTn10--TetS)2 [dcm] R(zgb-210::Tn10 --TetS) endA1 <math>\Delta</math>gor <math>\Delta</math>(mcrC-mrr)114::IS10.</i>	A derivative of Shuffle T7 Express (New England Biolabs) resulting from P1-transduction of an <i>E. coli</i> K12 <i>cya°</i> mutation. This <i>cya</i> strain is deleted for glutaredoxin reductase ( <i>gor</i> ) and thioredoxin reductase ( <i>trxB</i> ) genes, and consequently disulfide bonds can form in the cytoplasm.	17
KV1	$F^-$ $\lambda$ - <i>ilvG rfb50 rph-1 rpsL150; Strpr ;</i> <i>LacZ::luxCDABE ; <math>\Delta</math>cya.</i>	A derivative of MG1655 <i>rpsL150</i> carrying a <i>cya</i> deletion and the <i>luxCDABE</i> operon from <i>Photobacterium luminescens</i> integrated downstream to the LacZ promoter. In <i>E. coli</i> KV1, protein-protein interactions can be simultaneously monitored by light emission ( <i>lux</i> operon) and colorimetric detection ( <i>lacZ</i> ).	18

The frequencies of spontaneous reversion of DHT1, DHM1 and BTH101 strains toward  $Lac^+$  or  $Mal^+$  phenotypes (due to cAMP/CAP independent promoter mutations) are below  $10^{-7}$  and  $10^{-18}$ , respectively.



**Table 2 : Commonly used BACTH vectors**

<b>Plasmids</b>	<b>Resistance &amp; Replication origin</b>	<b>Comments</b>	<b>Ref</b>
pKT25	Kanamycin P15A	A low copy-number plasmid that expresses the T25 fragment under <i>lac</i> promoter control and harboring a multicloning site sequence (MCS) at the 3' end of T25 for fusing protein of interest (POI) to the C-terminus of T25	25
pKNT25	Kanamycin P15A	similar to pKT25 but with the MCS located at the 5' end of T25 coding region for fusing POI to the N-terminus of T25	25
pKT25- <i>zip</i>	Kanamycin P15A	A positive control plasmid that expresses T25 fused to the leucine zipper of GCN4	25
pST25	Spectinomycin P15A	similar to pKT25 but with a Spectinomycin resistant cassette instead of Kanamycin for fusion of POI to the C-terminus of T25	19
pSNT25	Spectinomycin P15A	similar to pST25 but with MCS located at the 5' end of T25 coding region for fusion of POI to the N-terminus of T25	19
pSMT25	Spectinomycin P15A	similar to pST25 but with an hydrophobic segment (from OppB) inserted between T25 and MCS for expressing fusion of T25 to POI targeted to the periplasm	19
pST25-DEST	Spectinomycin Chloramphenicol P15A	similar to pST25 but with attR recombination sites at 3' end of T25 Orf for fusion of POI to the C-terminus of T25 by the Gateway® technique (1).	19
pSNT25-DEST	Spectinomycin Chloramphenicol P15A	similar to pST25 but with attR recombination sites at 5' end of T25 Orf for fusion of POI to the N-terminus of T25 by the Gateway® technique (1)	19
pSMT25-DEST	Spectinomycin Chloramphenicol P15A	similar to pSMT25 but with attR recombination sites instead of MCS at 3' end of T25 Orf for construction, by the Gateway® technique, of fusion of T25 to periplasmic POI	19

---

pUT18	Ampicillin ColE1	A high copy-number plasmid that expresses the T18 fragment under <i>lac</i> promoter control and harboring a MCS at the 5' end of T18 for for fusing POI to the N-terminus of T18	25
pUT18C	Ampicillin ColE1	similar to pUT18 but with the MCS at the 3' end of T18 for fusing POI to the C-terminus of T18	25
pUTM18C	Ampicillin ColE1	similar to pUT18 but with an hydrophobic segment (from OppB) inserted between T18 and MCS for expressing fusion of T18 to POI targeted to the periplasm	25
pUT18C- <i>zip</i>	Ampicillin ColE1	with the MCS at the 3' end of T18 for fusing POI to the C-terminus of T18 A positive control plasmid that expresses T18 fused to the leucine zipper of GCN4	25
pUT18C- <i>DEST</i>	Ampicillin Chloramphenicol ColE1	similar to pUT18C but with attR recombination sites at 3' end of T18 Orf for fusion of POI to the C-terminus of T18 by the Gateway® technique (1)	19
pUTM18C- <i>DEST</i>	Ampicillin Chloramphenicol ColE1	similar to pUTM18C but with attR recombination sites instead of MCS at 3' end of T25 Orf for construction, by the Gateway® technique, of fusion of T25 to periplasmic POI	19

---

(1) The Gateway® vectors must be propagated in *E. coli* strains that are resistant to the lethal effect of the CcdB toxin (i.e. harboring the CcdB resistant, *gyrA462* gyrase mutation) such as the DB3.1™ *E. coli* strain (see manufacturer's guidelines at <https://tools.thermofisher.com/content/sfs/manuals/gatewayman.pdf>).

## Figure caption.

### Figure 1. Principle of BACTH system.

Upper part: When co-expressed as separate polypeptides the two fragments of *B. pertussis* adenylate cyclase, T25 and T18, cannot associate and are inactive (left); when the T25 and T18 fragments are fused to interacting protein X and Y, the hybrid proteins T25-X and T18-Y can associate into an active complex that produces cAMP (middle) while no activity is restored when the T25 and T18 fragments are fused to non-interacting protein X and Z (right). Lower part: the catabolite activator protein (CAP) upon binding cAMP can bind to the promoters of catabolite operons (such as *lac* operon or *mal* regulon) to activate their transcription.

**Figure 2. General methodology to analyze interactions between two proteins of interest with the BACTH system.** See main text for detailed explanations.

### Figure 3. Schematic structure of BACTH plasmids.

The cyan and green arrows represent the T25 and T18 genes, respectively, expressed under the control of the *lac* promoter, the orange and blue arrows the antibiotic selectable markers, kanamycin and ampicillin, respectively, while the magenta and brown boxes indicate the origin of replication. The position and sequence of the multicloning sequences (MCS) used for insertion of genes of interest are shown for each plasmid.

**Figure 4: Basic protocol for  $\beta$ -galactosidase assay in a 96-well array format.** See main text for detailed explanations.

In *E. coli*  $\Delta cya$

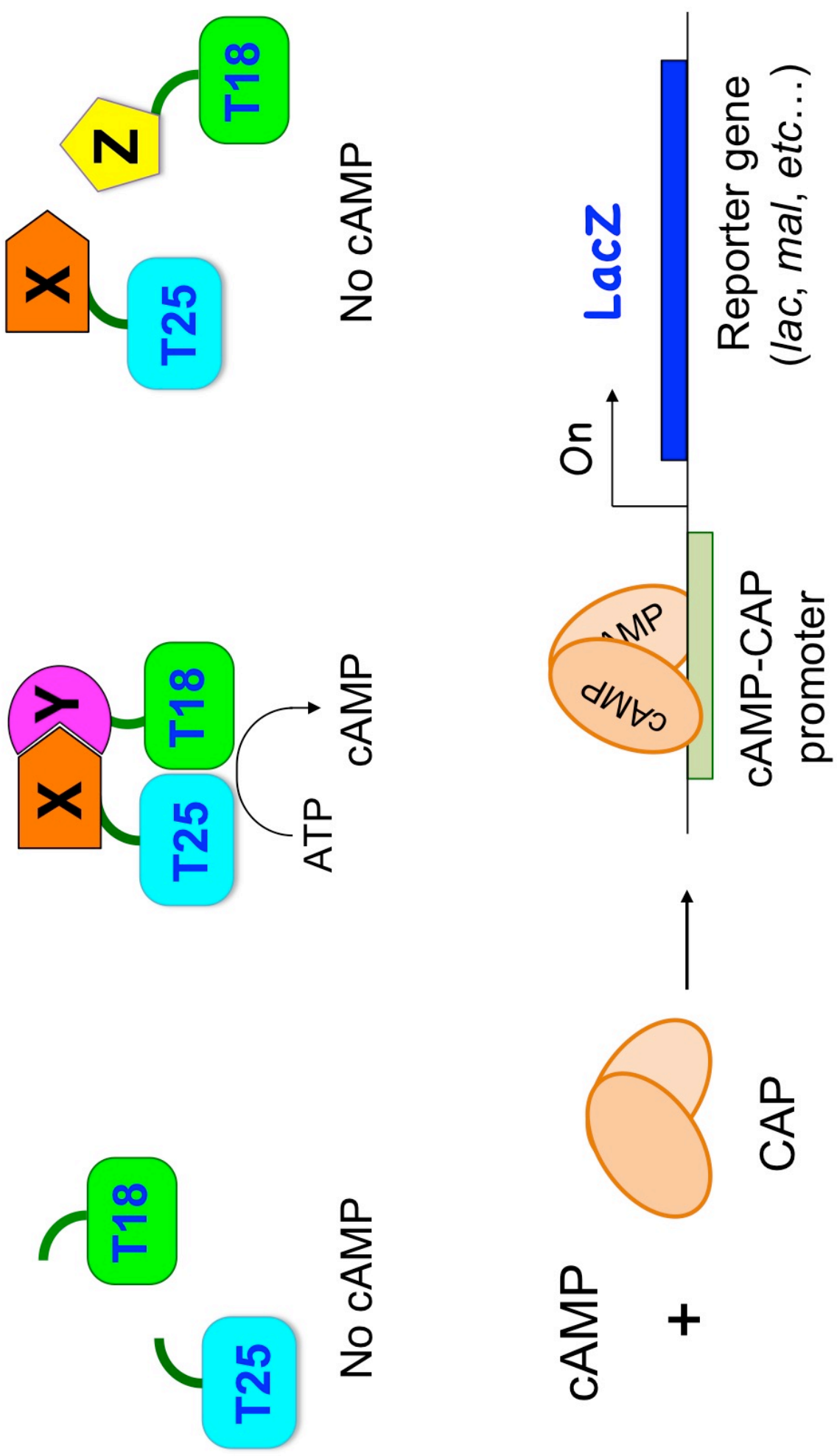

Interaction between T25-X / T18-Y  $\Rightarrow$   $\beta$ -galactosidase expression

## 1 - Construction of recombinant plasmids

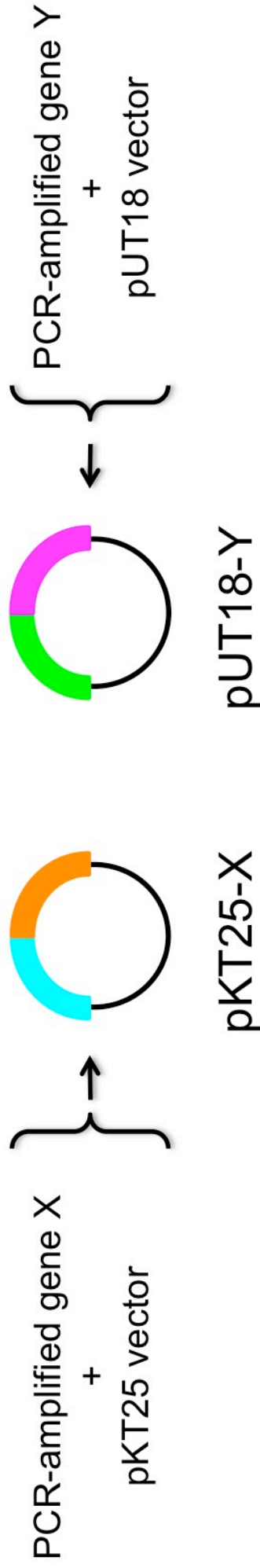

## 2 - Assay of interaction between hybrid proteins in *E. coli cya*

2-1 Co-transform pKT25-X & pUT18-Y into competent *E. coli cya*

2-2 Phenotypic detection of interaction: plate co-transformants on indicator or selective media.

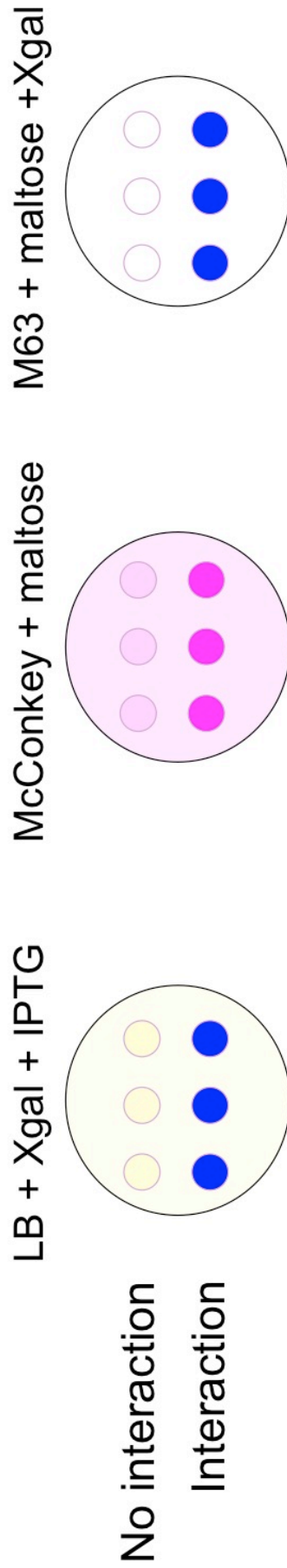

## 3 - Quantification of complementation with $\beta$ -galactosidase assays

*Pst*I   *Sa*II   *Xba*I   *Bam*HI   *Kpn*I  
 gctgcagggtcgactctagaggatccccgggtacctaagtaactaagaattc  
 A A G S T L E D P R V P K stop



pKT25

*Hind*III   *Sph*I   *Pst*I   *Sa*II   *Xba*I   *Bam*HI   *Kpn*I   *Sac*I   *Eco*RI  
 ccaagcttgcattgcctgcaggctgactctagaggatccccgggtaccgagctcgaattca  
 P S L H A C R S T L E D P R V P S S N S



pKNT25

Kan<sup>R</sup>   Ori p15A

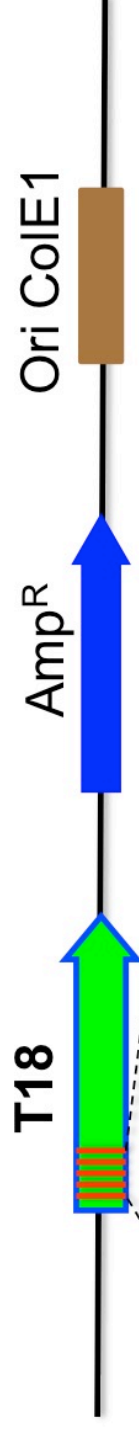

pUT18

Amp<sup>R</sup>   Ori ColE1

*Hind*III   *Sph*I   *Pst*I   *Sa*II   *Xba*I   *Bam*HI   *Kpn*I   *Sac*I   *Eco*RI  
 ccaagcttgcattgcctgcaggctgactctagaggatccccgggtaccgagctcgaattca  
 P S L H A C R S T L E D P R V P S S N S



pUT18C

1 - Distribute 300-400  $\mu\text{l}$ /well of LB + IPTG + antibiotics into 2.2-ml 96-well block

2 - Inoculate single colonies into individual wells

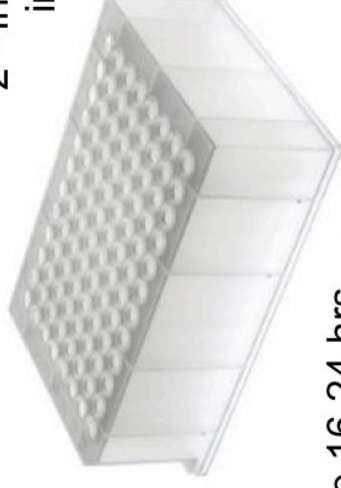
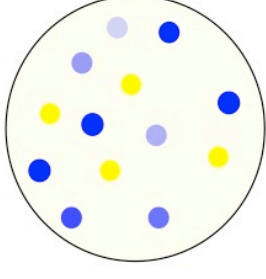

3 - Incubate 16-24 hrs at 30°C on a shaker

4- Dilute 5-fold in M63 medium

200  $\mu\text{l}$ /well of diluted cultures

200  $\mu\text{l}$ /well of diluted cultures

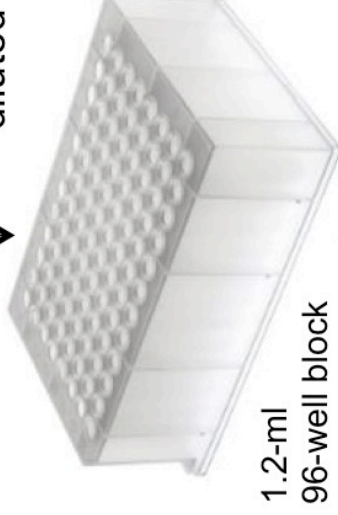

6 - Permeabilize the bacteria :  
add SDS & chloroform, mix well

5 - Record absorbance at 600 nm

7 -  $\beta$ -gal. assay :

Add 20- $\mu\text{l}$  of the permeabilized cells to 105  $\mu\text{l}$ /well of PM2 + ONPG &

Incubate at room temp (20 - 60 min )

8 - Add  $\text{Na}_2\text{CO}_3$  to stop the reaction &

Record absorbance at 405 nm

9 - Calculate the  $\beta$ -gal. activity, E, from Abs405 & Abs600