



HAL
open science

The OPTICON A2IM Cookbook: an introduction to additive manufacture for astronomy

Carolyn Atkins, Bart van de Vorst, Andrew Conley, Szigfrid Farkas, Emmanuel Hugot, György Mező, Katherine Morris, Mélanie Roulet, Robert M Snell, Fabio Tenegi-Sanginés, et al.

► To cite this version:

Carolyn Atkins, Bart van de Vorst, Andrew Conley, Szigfrid Farkas, Emmanuel Hugot, et al.. The OPTICON A2IM Cookbook: an introduction to additive manufacture for astronomy. SPIE astronomical telescopes and instrumentation, Jul 2022, Montreal, Canada. 10.1117/12.2627244 . hal-03852671

HAL Id: hal-03852671

<https://hal.science/hal-03852671v1>

Submitted on 15 Nov 2022

HAL is a multi-disciplinary open access archive for the deposit and dissemination of scientific research documents, whether they are published or not. The documents may come from teaching and research institutions in France or abroad, or from public or private research centers.

L'archive ouverte pluridisciplinaire **HAL**, est destinée au dépôt et à la diffusion de documents scientifiques de niveau recherche, publiés ou non, émanant des établissements d'enseignement et de recherche français ou étrangers, des laboratoires publics ou privés.

The OPTICON A2IM Cookbook: an introduction to additive manufacture for astronomy

Carolyn Atkins^{a*}, L.T.G. (Bart) van de Vorst^b, Andrew Conley^c, Szigfrid Farkas^d, Emmanuel Hugot^e, György Mező^d, Katherine Morris^a, Mélanie Roulet^e, Robert M. Snell^f, Fabio Tenegi-Sanginés^g, Iain Todd^f, Afrodisio Vega-Moreno^g, and Hermine Schnetler^a

^aUK Astronomy Technology Centre, Royal Observatory, Edinburgh, EH9 3HJ, UK

^bSOLLIANCE / TNO, High Tech Campus 21, NL-5656 AE Eindhoven, The Netherlands

^cCampus Technology Hub, Daresbury Laboratory, Keckwick Lane, Daresbury, WA4 4FS, UK

^dKonkoly Observatory, Research Centre for Astronomy and Earth Sciences, MTA Centre for Excellence, 1121 Konkoly-Thege Miklós út 15-17, Budapest, Hungary

^eAix Marseille Univ, CNRS, CNES, LAM, Marseille, France

^fDept of Materials Science and Engineering, University of Sheffield, Sheffield, S1 3JD, UK

^gInstituto de Astrofísica de Canarias (IAC), 38200, La Laguna, Tenerife, Spain

ABSTRACT

Additive manufacture (AM), also known as 3D printing, builds an object, layer-by-layer, from a digital design file. The primary advantage of the layer-by-layer approach is the increase in design-space, which enables engineers and scientists to create structures and geometries that would not be practical, or possible, via conventional subtractive machining (mill, drill and lathe). AM provides more than prototyping solutions: there are a broad range of materials available (polymers, metals and ceramics); software capable of creating lightweight structures optimised for the physical environment; and numerous bureaux offering AM as a service on a par with subtractive machining. In addition, AM is an ideal method for bespoke, low-count parts, which are often the foundation of astronomical instrumentation.

However, AM offers many challenges as well as benefits and, therefore, the goal of the OPTICON A2IM Cookbook is to provide the reader with a resource that outlines the scope of AM and how to adopt it within astronomical hardware, with an emphasis on the fabrication of lightweight mirrors. The Cookbook was an open access deliverable of the EU H2020 funded OPTICON (Optical Infrared Coordination Network for Astronomy; grant agreement #730890) A2IM (Additive Astronomy Integrated-component Manufacturing; PI H. Schnetler) work package and it was completed in June 2021. This paper will introduce the Cookbook, its scope and methodology, and highlight the paradigm shift required to design and AM lightweight mirrors for astronomy and space-science.

Keywords: Additive manufacture, 3D printing, lightweight mirrors, metal mirrors, OPTICON, open access

1. INTRODUCTION

Additive manufacture (AM), also known as 3D printing, builds an object layer-by-layer from a digital design file. The primary advantage of the layer-by-layer approach is the increase in design-space, which enables engineers and scientists to create structures and geometries that would not be practical, or possible, via conventional subtractive machining (mill, drill and lathe). AM provides more than prototyping solutions, for example: there are a broad range of materials available (polymers, metals and ceramics); dedicated software capable of creating lightweight structures optimised for the physical environment; and numerous bureaux offering AM as a service on a par with subtractive machining. In addition, AM is an ideal method for bespoke, low-count parts, which are often the crux of astronomical instrumentation.

Further author information:

e-mail: carolyn.atkins@stfc.ac.uk

In recognition of the potential disruptive effect of AM within the astronomical instrumentation, one of the work packages (WP) within the EU H2020 OPTICON (Optical Infrared Coordination Network for Astronomy) project was dedicated to this theme: Additive Astronomy Integrated-component Manufacturing (A2IM). The A2IM WP brought together European expertise in both AM and astronomical instrumentation, so that both communities could learn the limitations and opportunities on offer.¹ The core A2IM research was undertaken from 2017 to 2021 and the WP delivered a series of prototypes and concepts related to astronomical instrumentation.^{2–6} In addition, two open access documents were created for the community, a *Report on Additive Manufacturing Materials*⁷ and the *OPTICON A2IM Cookbook*,⁸ it is the latter of these documents (termed ‘the Cookbook’) that is discussed herein.

The goal of the Cookbook is to provide the astronomical instrumentation community, engineers and scientists, with a practical foundation in *why* and *how* to implement additive manufacture within future astronomical instrumentation. The document is split into four sections: reference material, paradigm shift, case studies, and the A2IM test geometry. The *reference material* highlights the fundamental considerations when using AM, such as the role of support material and the need for post-processing. The *paradigm shift* uses AM mirror development as an example and highlights how the considerations described in the reference material have been applied to create a first generation of prototype mirrors. The *case studies* provide practical examples, including production cost, post-processing and material choice, for a range of different applications. Finally, the *A2IM test geometry* provides a description of a benchmark piece created for the project and how different printers and materials affect the quality of the print. It is hoped that by providing a broad range of reference material, which is supported by practical examples, the goal of the Cookbook can be realised. The Cookbook is open access under a Creative Commons license and available in the online repository Zenodo:

The OPTICON A2IM Cookbook: <https://doi.org/10.5281/zenodo.5041819>

The objective of this paper is not to reproduce the Cookbook, but rather present some of fundamental considerations in the adoption of AM within astronomical instrumentation, which can then be further expanded upon using the Cookbook. The focus of this paper is the reference material (Section 2), but the paper also includes short introductions to the paradigm shift (Section 3) and the A2IM test geometry (Section 4), the latter of which was previously discussed at SPIE AT&I in 2020.¹ Although the authors have tried to deliver up-to-date information within the Cookbook, AM is a rapidly redeveloping field and it is unlikely that all new technologies and methods have been captured.

2. ADDITIVE MANUFACTURE FOR ASTRONOMY & SPACE SCIENCE

This section presents the reference material in the *approximate* chronological steps in which it is applied in the creation of an AM part.

2.1 Additive manufacture as a methodology

As shown in Figure 1 *left*, methods of manufacture can be divided into four categories: subtractive (mill, drill and lathe), formative (casting and forming), fabricative (bonding, welding and fixings), and additive (AM). When building astronomical instrumentation, it is common for all of these to be applied in creating components. Although the category *additive* almost solely implies additive manufacture - the creation of a part layer-by-layer from a digital design file - there are other processes that build a structure layer-by-layer without bonding, for example, the Si-Si bond in silicon pore optics.⁹

The selection of the optimum method of manufacture is often dependant on budget, quantity, geometry and time. Although AM is a versatile method and can create a wide range of geometries, it is not practical, for example, in the creation of a solid block, where subtractive or formative methodologies would be favourable. Figure 1 *right* highlights the case for metals where a variety of methodologies are shown in relation to part count and geometric complexity. AM (termed layer manufacturing in the figure) inhabits the domain where there is a need for geometric complexity, but only a few parts are required.¹⁰ When astronomical instrumentation is considered, where typically only a single instrument or telescope is required (low part count), the design freedom of the additive manufacture has a clear benefit for reducing mass and enabling part consolidation (merging previously individual parts into a single component).

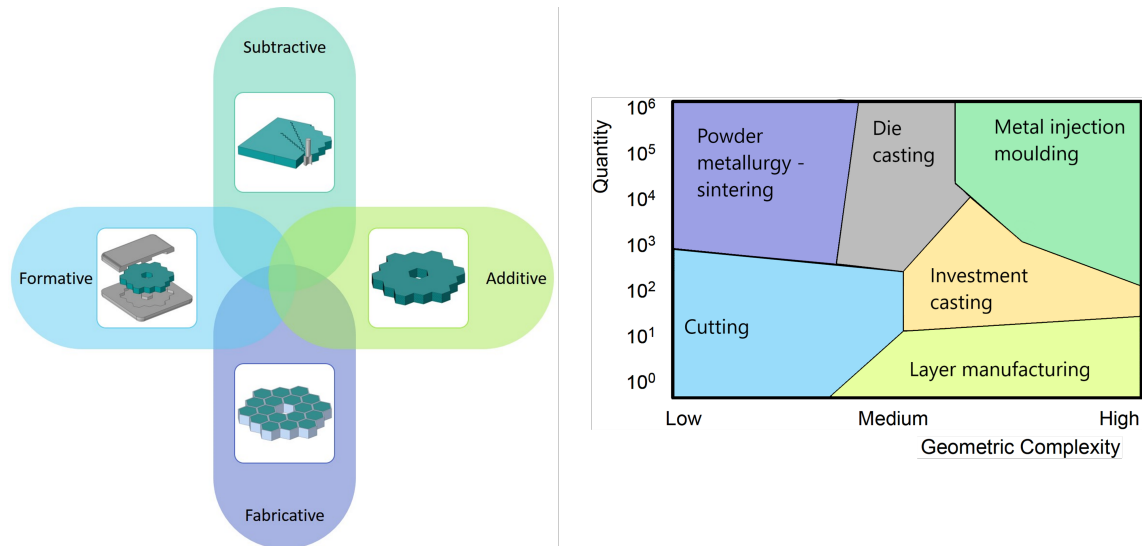
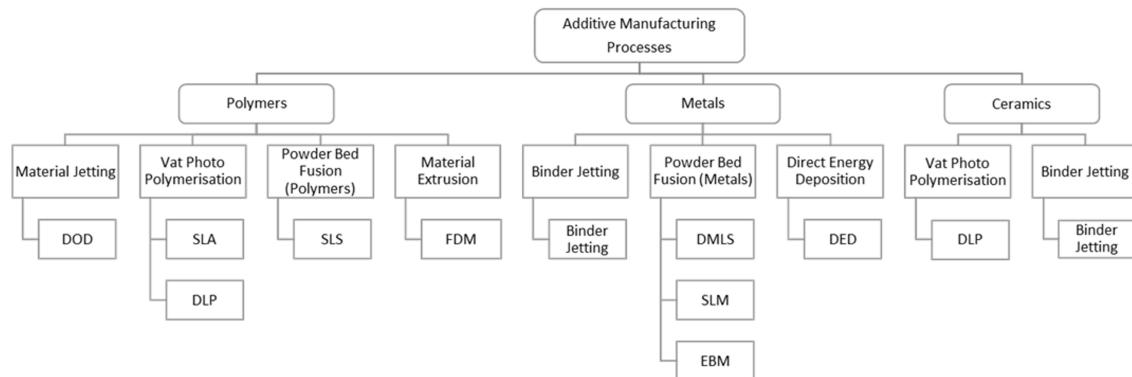


Figure 1. *Left* - the interplay between the four manufacture methodologies. *Right* - the role of process selection for metal components when considering quantity required and geometric complexity, image adapted from *Levy et al.*, (2003).¹⁰



Acronym	Definition	Acronym	Definition
DOD	Drop on Demand	DMLS	Direct Metal Laser Sintering
SLA	Stereolithography	SLM	Selected Laser Melting
DLP	Digital Light Processing	EBM	Electron-Beam Melting
SLS	Selected Laser Sintering	DED	Direct Energy Deposition
FDM	Fused Deposition Modelling		

Figure 2. The dependence of material choice in down-selecting AM method and technology.

2.2 Printing processes and material

There is a broad range of engineering materials available to be used within additive manufacture, including metals, polymers, ceramics and a variety of composite materials.

To deliver this broad range there are considered to be seven AM methods which can be employed: sheet lamination, vat photopolymerisation, material jetting, material extrusion, binder jetting, powder bed fusion, and directed energy deposition. Each of these methods can be further subdivided by the specific technology used - for example, stereolithography (SLA) is a common technology used to deliver vat photopolymerisation. The selection of the optimum process is linked to the material that is required, a solid metal component would not be possible via vat photopolymerisation, likewise, a low roughness plastic component would not favour powder bed fusion. Figure 4 highlights the different methods and technologies related to metals, polymers and ceramics.

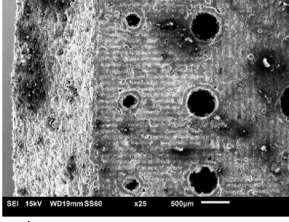
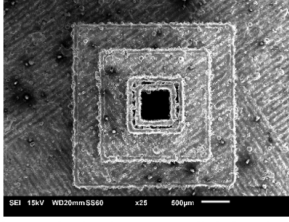
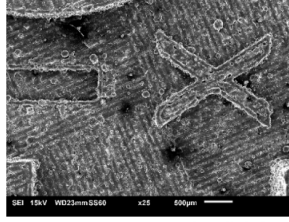
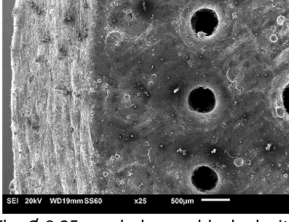
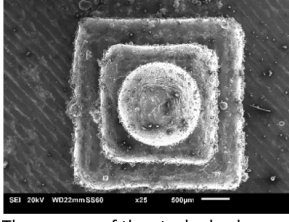
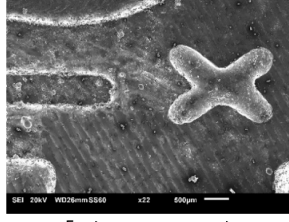
Feature	Vertical holes	Cube Pyramid	Debossing & Embossing
High Resolution system AISI10Mg	 <p>The \varnothing 0.25 mm hole is present and has a diameter of 0.218 mm. The diameter of the large hole is 0.49 mm.</p>	 <p>The stacked cubes are well defined and hole in the middle is open</p>	 <p>Features are present and well defined.</p>
Industrial System AISI10Mg	 <p>The \varnothing 0.25 mm holes are blocked with powder.</p>	 <p>The corners of the stacked cubes are rounded and the middle hole is not present</p>	 <p>Features are present. Corners are rounded.</p>

Figure 3. The comparison between a single CAD file built using two metal L-PBF printers: the *upper row* presents a high resolution print and the *lower row* presents a low-resolution print.

After an initial down selection of processes based upon the material required, a further down selection on technology to deliver the AM component is needed. Considering the example of polymers (Figure 2), how do you choose between material jetting, vat photopolymerisation, powder bed fusion and material extrusion? Like selecting a process in conventional manufacture, it is the priority of the part requirements that drives the selection. For example - if a low cost prototype is required, then a desktop filament 3D printer (material extrusion) might be preferred; if the part has a complex geometry and support material (Section 2.6) cannot be removed, then powder bed fusion could be preferable; or, if high accuracy, smooth parts are required then vat photopolymerisation might be required.

Different processes will deliver different quality end parts and this is also true within specific processes and technologies. Figure 3 highlights the difference in print fidelity between a high resolution laser powder bed fusion (L-PBF) print and a low resolution L-PBF print, when building the same part in the same material (aluminium). The differences between the printers that created these parts are that the high resolution has a small build volume, smaller laser spot, thinner layer thickness and a slower build rate, which results in small scale accurate prints, whereas the opposite is true for the low resolution printer, which is optimised for building large numbers of parts, or single large components, quickly and efficiently, but with a loss of fidelity. The component in Figure 3 is further described in Section 4.

In addition to the broad range of machines that each provide different operating modes, within each machine there is a plethora of parameters that can be altered by the user, for example, layer thickness, beam diameter, speed and temperature. Furthermore, the raw materials in use - powders, filaments and resins - although they are listed as the same material, they may vary in performance depending on the AM method and technology used. Considering the metallic powders used in PBF, the accuracy of the powder, in terms of size and sphericity, affects how the powder is drawn in layers during the build process. Contamination of powders by either remnant foreign powders, which may occur when using different powders within a given machine, or through the oxidation of powders, which may have been recycled several times, both have the potential to lower build quality and ultimately material performance. The mechanical material properties listed by an AM bureau assume ideal AM material storage and a given set of machine parameters, deviating from these parameters can lead to a change

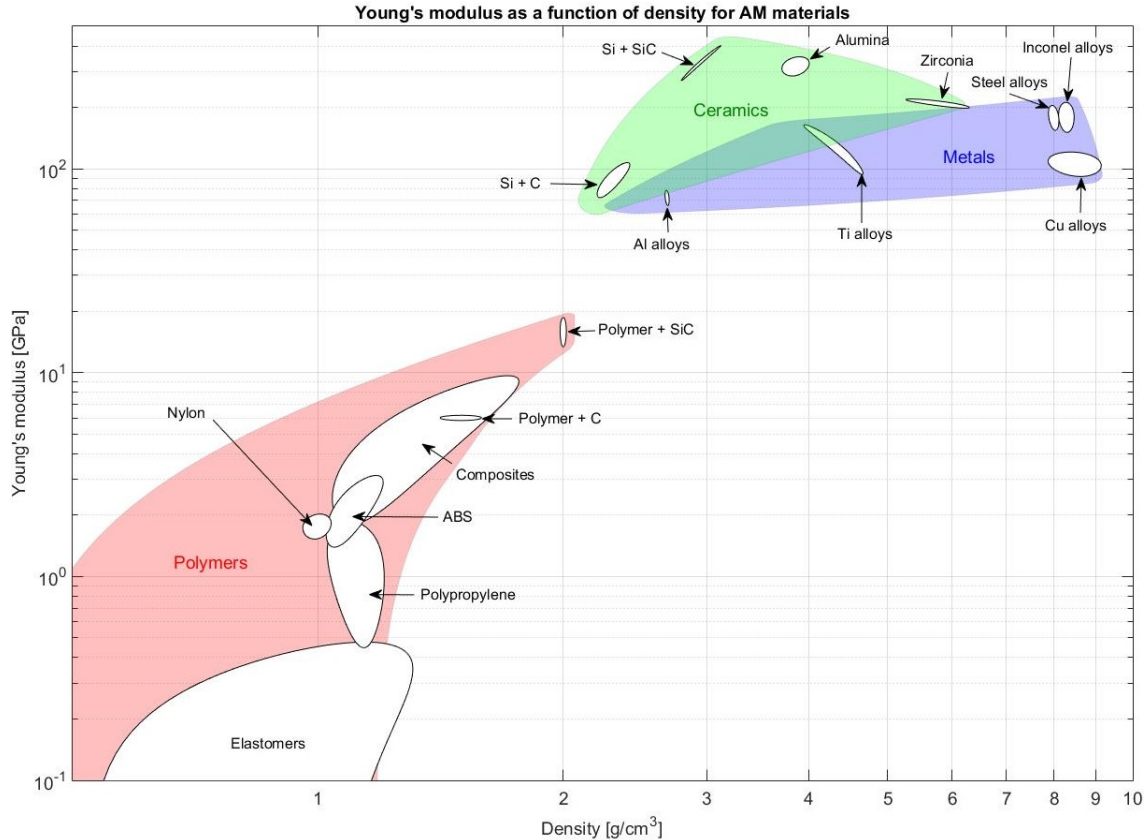


Figure 4. Young's modulus and density for different AM materials grouped within polymers, metals and ceramics. The data from this graph was collated from AM material data sheets.

in material properties. Due to the layer-by-layer nature of AM, material properties are often anisotropic, where the material has two property values, one in the build plane and a one in the build direction. Figure 4 plots two AM material mechanical properties, Young's Modulus and density, which have been collated from datasheets from AM bureau or AM material providers, to highlight the variability in mechanical performance under ideal conditions.

2.3 Design Freedom

The key benefit of AM is the design freedom, which removes the constraints that necessitate access for tools to extract material. Design freedom is realised in a number of ways, from the application optimised lightweight structures, to part consolidation and using organic-styled structures. Design for AM (DfAM) requires a shift in mindset not only to capture the design benefits of AM, but to also create a design that can be post-processed. The following subsections will describe some of the design benefits that can be created.

2.3.1 Lattices

A lattice is a 3D structure that occupies a percentage of a set volume (a unit) and can be tessellated along different axes of a coordinate system to create a larger structure. Figure 5 highlights four different examples of lattices: a 2D grid structure, a periodic lattice, a formula driven lattice and a stochastic lattice. With the exception of the 2D grid structure, each of the 3D lattices structures are challenging to achieve via subtractive machining, but are ideal structures to be built using AM. However, there are challenges in using lattices within a design, for example, because the lattice is not intended to be machined, the struts of the lattice will have a roughness which may prove problematic for an given application; furthermore, modelling lattices via parametric computer aided design (CAD) is slow and leads to large file sizes, therefore modelling lattices requires a high performance computer and preferably software specialised in lattice generation.

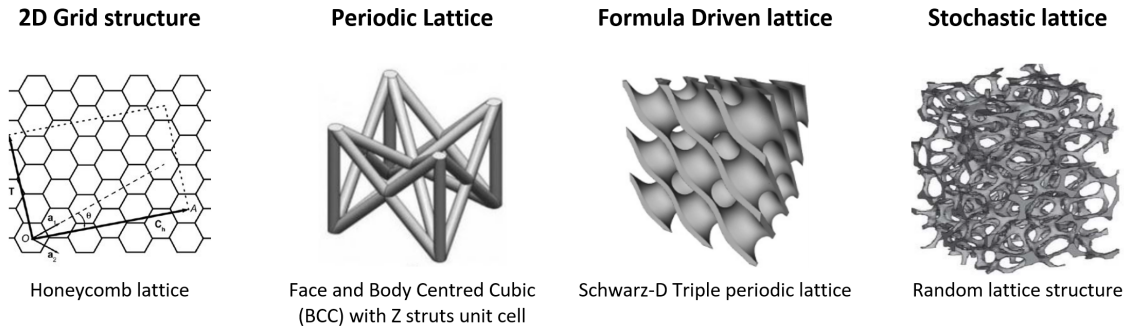


Figure 5. Examples of four different lattice configurations commonly used within AM.

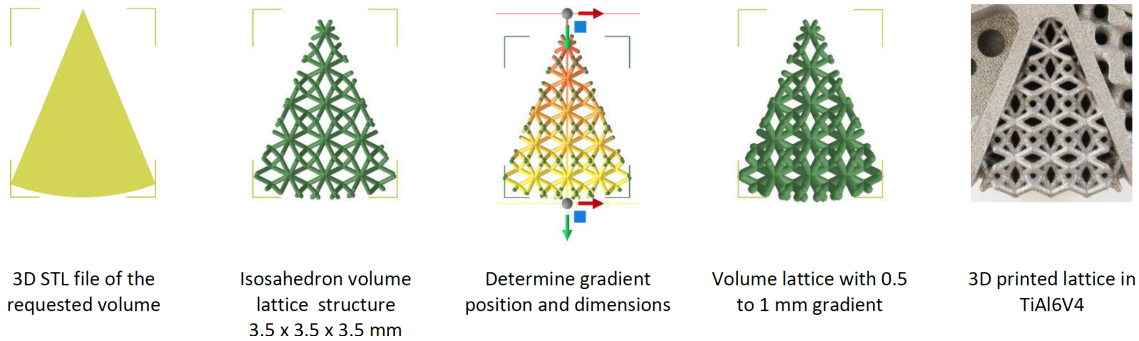


Figure 6. The process steps used to create a density graded lattice for the A2IM test geometry, an example of the printed lattice is shown at the far right.

One of the benefits of using software specialised in lattice generation is the ability to edit the lattice thickness, or ‘density’ of the unit volume, to the required application. For example, the lattice struts near a loaded surface can be thickened to reduce deformation. Figure 6 highlights four steps in the creation of a thickness graded lattice for the A2IM test geometry (Section 4). Thickness gradients are not limited to a linear change as shown, the thickness of the lattice can be combined with a simulation of the part under a load, allowing for an optimisation of the lattice thickness.

2.3.2 Software optimisation

Topology optimisation and generative design are simulation-based design tools that take a series of inputs (fixed constraints, materials, boundary loads etc.) and converges on the optimum design (topology optimisation), or a series of design options (generative design). The designs created by these tools are often organic in structure and typically are not favoured for subtractive machining. Figure 7 highlights the application of topology optimisation to a flexure, where the goal was to reduce the mass of the flexure by 50% without compromising the performance. A full description of this study is presented by *K. Morris et al.* at this meeting.⁶ The advantage of using optimisation tools is the prioritisation of structures that will directly benefit the function of the part; however, challenges can be encountered in the integration of the optimised structure with existing parametric CAD and in the machining, where organic structures are difficult to mount and index accurately.

2.3.3 Biomimicry

In this context, biomimicry is the adoption of structures found in nature to solve engineering challenges. There are a number of examples of biomimicry within astronomical instrumentation, for example the use of honeycomb structures for mass reduction,¹¹ or the use of the lobster eye geometry for large field of view X-ray optics.¹² The benefit of biomimicry is the use of evolution to suggest an optimised solution to an engineering challenge and although biomimicry has been used before the advent of AM, with the additional design freedom offered, AM is capable of realising a broader variety of nature inspired solutions. However, as with optimisation software, there is a limit on the structures that can be printed and machined, furthermore AM can only offer a snapshot of the

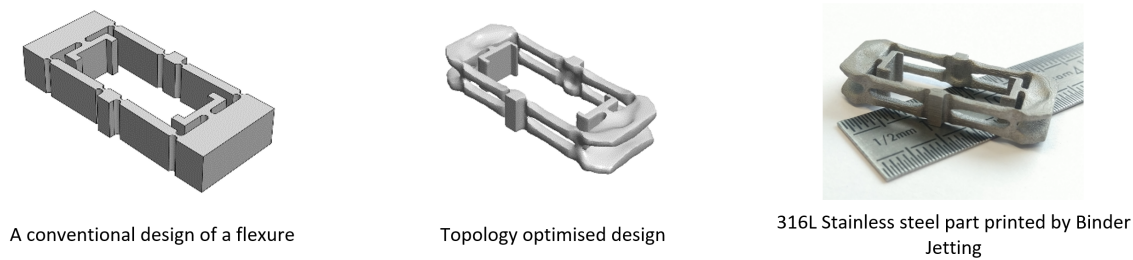


Figure 7. A topology optimised design where the mass of a flexure has been reduced by 50% while maintaining mechanical performance.

natural structure over its lifetime. Finally, unlike optimisation software, the inclusion of biomimicry in a design is either a simulated or a manually constructed approximation.

2.4 Design for AM (DfAM)

The previous sections described the benefits offered by the AM design freedom; however, there are practical limitations which affect a structure's 'printability' and these are termed *the design rules*. As discussed in Section 2.2, there are considered to be seven methods for implementing AM and for each method there will be a given set of design rules. There is a broad range of resources available outlining the different design rules for the different AM methods; a selection of resources are referenced within the Cookbook⁸ and therefore not repeated in this paper. However, given the ready application of metal AM in lightweight mirrors and complex structures, a summary of the design rules for metal PBF technologies is provided in Figure 8.

A further design consideration for metal PBF technologies is the role that support structures have in heat dissipation. When the laser fuses the metal powder to form a solid at high temperature, the heat needs a route to dissipate otherwise thermal defects can occur (Section 2.5.2) and these defects occur because the un-fused metal powder acts as an insulator.¹³ Therefore, although the engineer may have designed a structure that adheres closely to the design rules and as such requires minimal support material, additional support may be required to dissipate heat.

2.5 Defects within AM substrates

Defects within printed parts are a common occurrence, these defects can be due to poor adherence to the geometric design rules, poor thermal management, or non-optimal print parameters.

2.5.1 Geometric defects

Figure 9 highlights a variety of geometric defects resulting from a poor adherence to DfAM rules. As observed, some defects are cosmetic, such as increased roughness on the overhangs, but some defects are potential points of failure, such as distorted geometries or loss of structure. To remove the majority of these defects either the application of DfAM rules (Figure 8), part orientation on the build platform, or the inclusion of support material can be applied.

2.5.2 Thermal defects

Thermal defects can arise in a broad range of AM methods; however this section focusses on the PBF and defects within metals. Figure 10 presents the thermal defects caused due to over heating as the laser (or electron beam) fuses the metal powder into a solid. As discussed in Section 2.4, there is a difference in thermal conductivity between the loose metal powder (insulator) and the fused metal structure. If the heat cannot be dissipated during the print process, excess heat leads to a swelling of the fused metal which frequently results in a failed build. The optimum method for reducing the effect of thermal defects in metal PBF is to ensure that there is a conductive path along which the heat can dissipate, this can be achieved by either reorientating the part or through the use of support material.



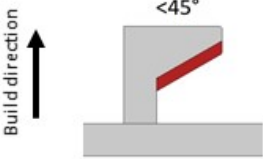
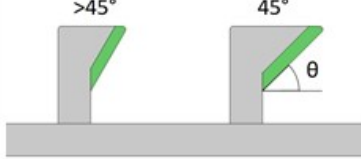

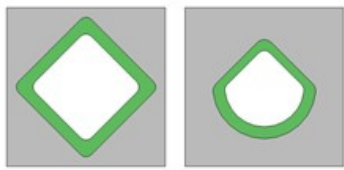
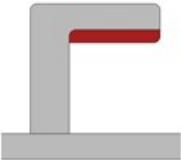
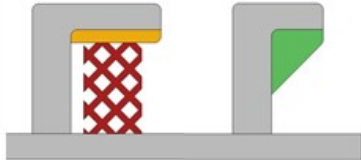








Powder bed fusion (PBF) Metals AM		
Unsupported geometries		
Overhangs at an angle $< 45^\circ$ lead to increased roughness and risk of failure.		
Unsupported circles/bores lead to increased roughness, deformed shape and risk of failure.		
Supported geometries		
Overhangs at an angle $< 45^\circ$ require support material or a redesign.		
Support material is temporary; adequate access should be ensured to remove supports, or redesign if necessary.		
For metal PBF, supports are required to provide heat dissipation.		
Orientation independent		
Enclosed volumes should be avoided as unsintered material cannot be removed.		
Sharp corners will not be accurately reproduced and lead to the potential for increased internal stress; fillets minimise these effects.		

Figure 8. A summary graphic highlighting the design rules for powder bed fusion AM technologies.

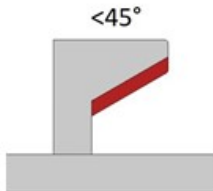



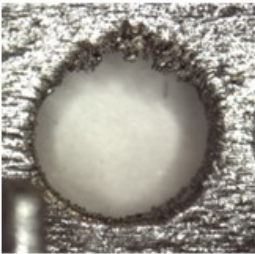
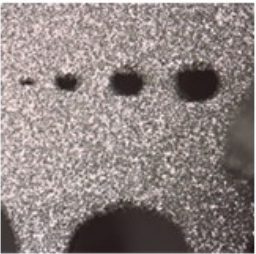
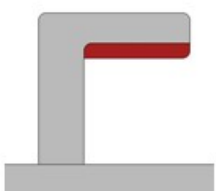


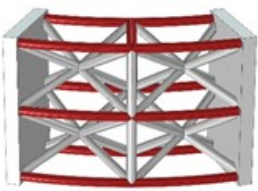
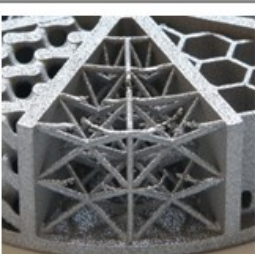
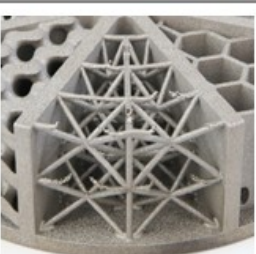
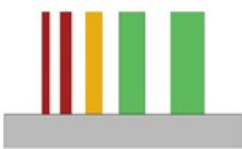


Geometric defects			
Unsupported geometries			
<p>Increasing roughness observed on the underside of the ledge for decreasing angle relative to the build plate.</p>	 <p><math><45^\circ</math></p>		
<p>Roughness and distortion observed on unsupported horizontal bores.</p>			
<p>Increased roughness and distortion observed on an unsupported slot.</p>			
<p>Distortion and loss of structure for unsupported horizontal lattice struts.</p>			
<p>Loss of object definition due to AM machine resolution – layer thickness, laser spot size, etc..</p>			

Figure 9. A summary graphic highlighting geometric design defects which have resulted from poor adherence to DfAM guidelines, part orientation on the build platform, or poor use of support structures.

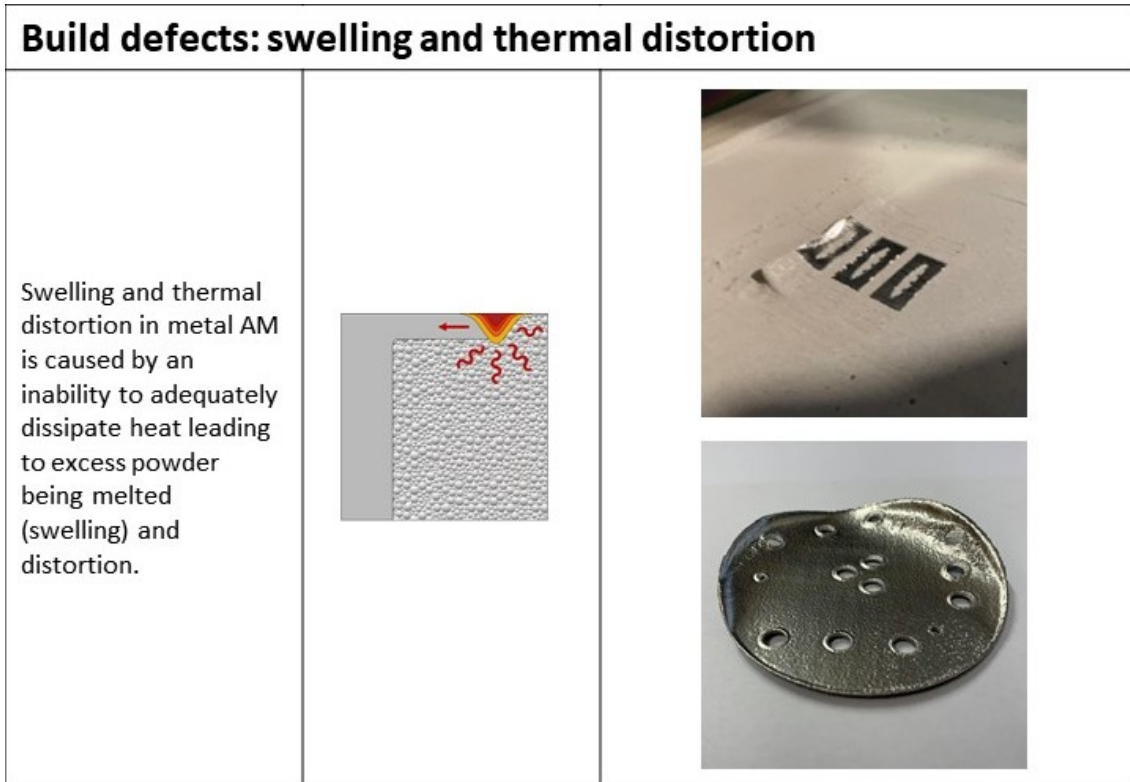


Figure 10. Thermal defects encountered within powder bed fusion print technology.

2.5.3 Porosity

Figure 11 presents high magnification images of three different AM metal substrates with the same geometry. Three of the images (Figure 11, *bottom row*) highlight the internal structure of the printed AM material, demonstrating the presence of porosity - voids within the printed material. Each of the three AM metal substrates highlights a different type of porosity which is linked to the different AM method/technique used. Porosity within AM substrates is non-desirable as it leads to anisotropic material performance, the potential for out-gassing within a vacuum, and, in AM mirror fabrication, leads to increased roughness within the optical surface. The common root cause of porosity is within the print parameters used by a given machine, typical effects that lead to porosity include, the part becoming too hot (keyholing), the part not being hot enough (lack of fusion), and the laser path not leading to a suitable in-fill. Therefore, some of the challenges of porosity can be solved in optimising the print parameters for a given material and printer; however, post-processing, such as hot isostatic pressing (HIP), can be employed to reduce the effect of porosity.^{6,14}

2.6 Support material

Support material, also termed support structure or scaffold, generally has one or two roles in the AM build process. First, across all materials and processes, it acts to support overhangs to ensure geometric fidelity to the CAD and second, for metal PBF specifically, it is used for heat dissipation. The geometric structure of the support material will depend on the printer technology and the material printed - polymer FDM supports, will be different to polyjet support, which will be different to metal PBF supports. Some AM technologies (FDM and polyjet) will print the support material in a different material to that of the main build and commonly in a material that is water soluble. Where the support material is not soluble, it is physically removed by hand or by using pliers. Figure 12 presents two different styles of support material, *left* is water soluble support material used in polyjet printing and *right* is a metal support structure providing both geometric support and heat dissipation.

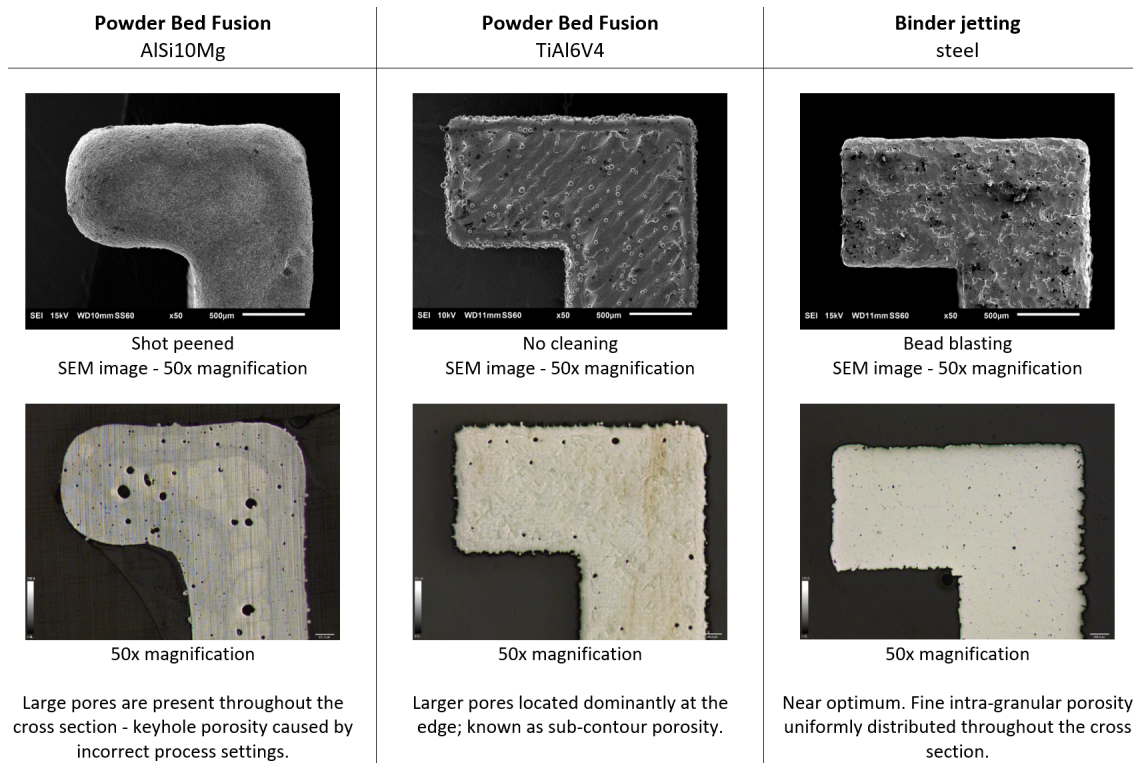


Figure 11. The microstructure and porosity differences between three metal print methods: the *upper row* presents external scanning electron microscope images highlighting the microstructures; and *lower row* presents the internal microstructure which highlights the presence of porosity.

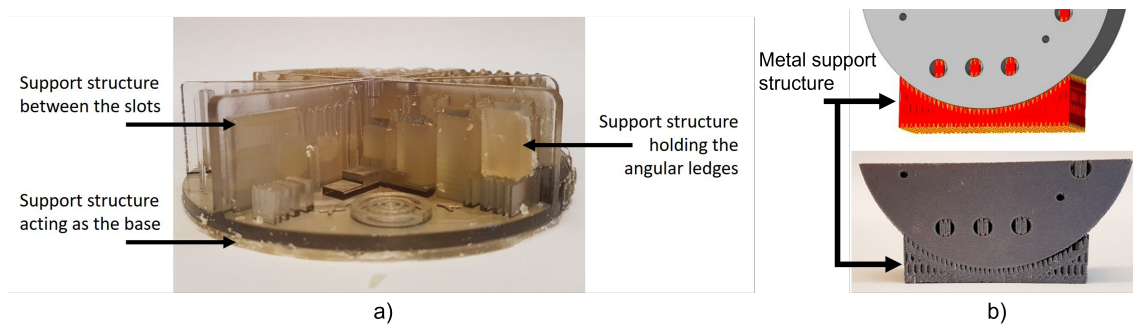


Figure 12. Examples in the use of support material: *left* presents the use of soluble support material within a polyjet build; and *right* the use of metallic supports within a L-PBF build.

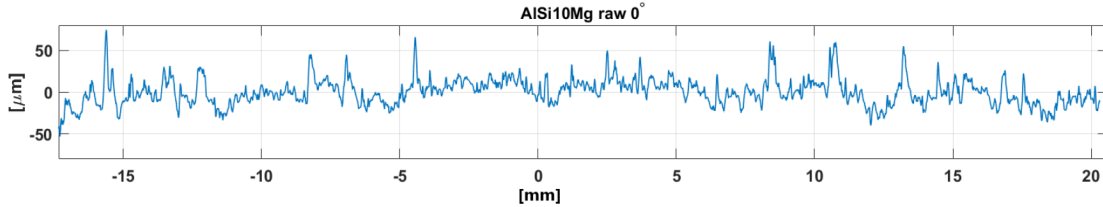


Figure 13. Contact profilometry data describing the surface roughness and form error of a un-processed (raw) L-PBF aluminium alloy build.

2.7 Post-processing

In the majority of engineering applications, post-processing of the AM build is necessary due to poor macro- and microscopic fidelity to the CAD model. Figure 13 highlights an example of the surface profile of a raw L-PBF aluminium build, qualitatively the surface is rough in comparison to machined components and it would not facilitate a close interface between components. Therefore, where the AM component interfaces with another component some post-processing is required and this can take the form of subtractive, formative or fabricative methods. However, most commonly subtractive finishing, such as bead blasting or CNC machining, is used. In AM mirror fabrication, the macro- and microscopic defects are removed to render a functional mirror surface.

2.8 Metrology

Metrology is important in all types of manufacture to ensure that the finished parts meet the original requirements and tolerances. In additive and formative manufacturing methods, where a near net shape is created, metrology is important to know how the part should be finished, for example, how to create interfaces or how to smooth inaccessible areas. Ultimately, AM substrates will most likely interface with conventional components and metrology is an important tool to achieve this. The type of metrology needed is dependant upon the tolerances required, calipers and rulers are adequate in obtaining low accuracy short dimensions, whereas a coordinate measuring machine is capable of providing large and accurate global dimensions. To evaluate small features, microscopes are capable of providing a broad range of resolutions. Figures 3 and 11 highlight how a scanning electron microscope was used to evaluate the microstructure of a selection of A2IM AM prototypes. A second example of metrology is shown in Figure 13, where a contact profilometer has been used to quantify the magnitude of roughness, this data can be important as it informs the designer how much material may have to be removed to achieve a good interface.

Metrology is not only external evaluation, internal metrology is beneficial to understand inaccessible regions within a geometry and to quantify the internal material characteristics, for example, is there porosity? Figure 11 lower row presents microscope images taken from cross-sections of an AM part - the parts were potted within a resin, then ground and 'polished' to present the internal face. The three internal cross-sections highlight the presence of porosity resulting from the different AM technologies; however, this is a single cross section, an alternative method is to use x-ray computed tomography (XCT). XCT is a powerful tool for AM as it provides digital internal data which can be used to evaluate porosity, but also allows for the reconstruction of the external skin of the part so that it can be compared against the CAD.

3. PARADIGM SHIFT

What is the paradigm shift? Simply, it is the change in mindset that is required to effectively implement AM within production. Prior to AM, there was a known process chain between design and manufacture: requirements → CAD & FEA → final design → technical drawings & tolerances → machining & post-processing → evaluation. The introduction of AM within the process chain increases the steps in the design phase and in the machining/post-processing phase. Subtractive machining of a near-net shape is a different process to machining out of a block of metal. Therefore in this section, a summary of the paradigm shift is described using the case study of lightweight mirrors; however a thorough review of the process steps with several referenced examples is provided within the Cookbook.

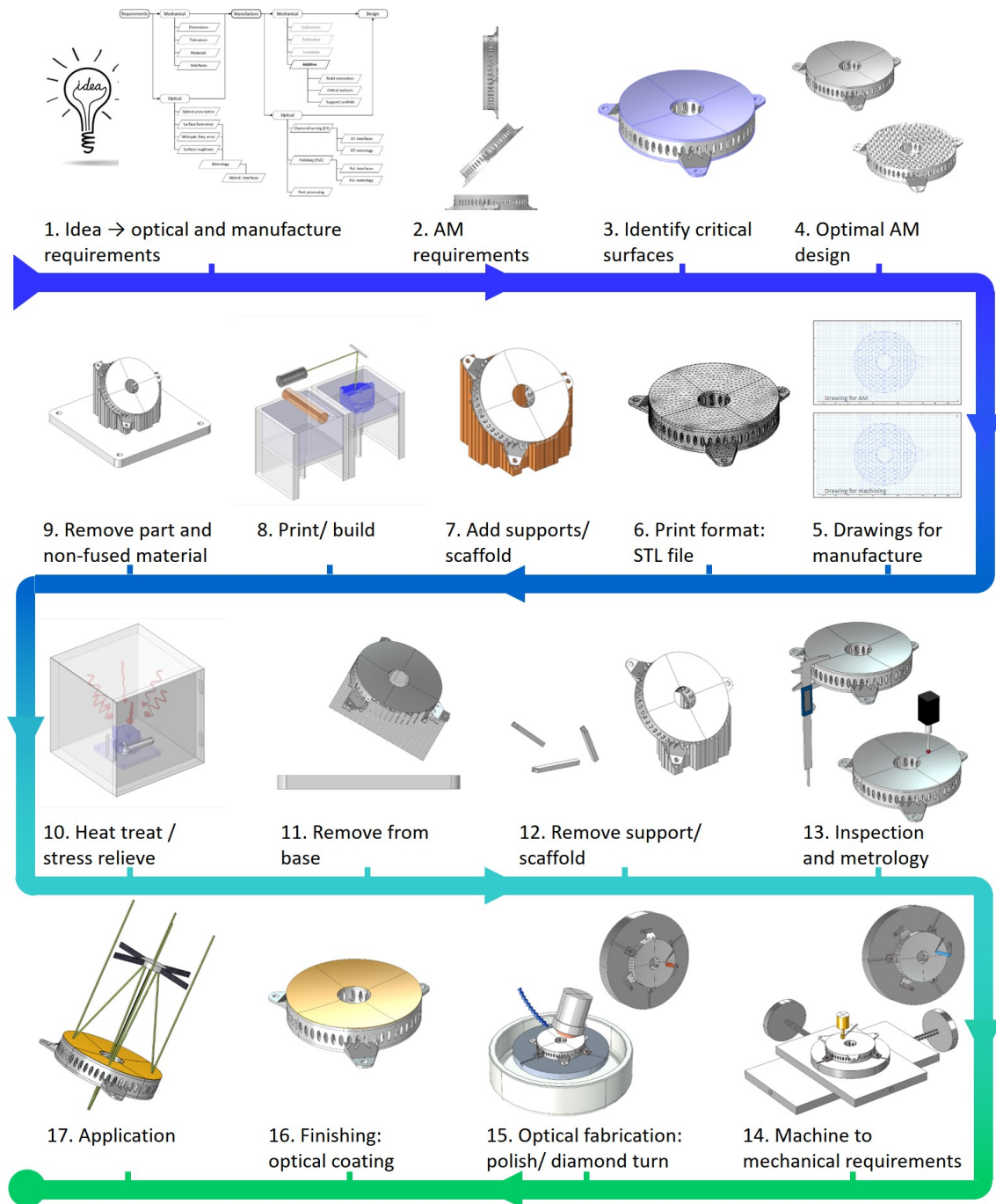


Figure 14. A description of the process chain required to use AM to create a lightweight mirror.

Figure 14 highlights the process/fabrication chain for the production of lightweight metal mirrors using AM. The example of mirror fabrication was selected as several groups have independently investigated AM metal mirrors for astronomical, Earth observation, or aerospace applications, and therefore provide a broad example range to select from. In addition, lightweight metal mirrors have clear benefits that can be gained through AM, such as mass reduction, optimisation of stiff structures and part consolidation. Although Figure 14 demonstrates mirror fabrication the process chain is generic and can be applied across a broad range of components.

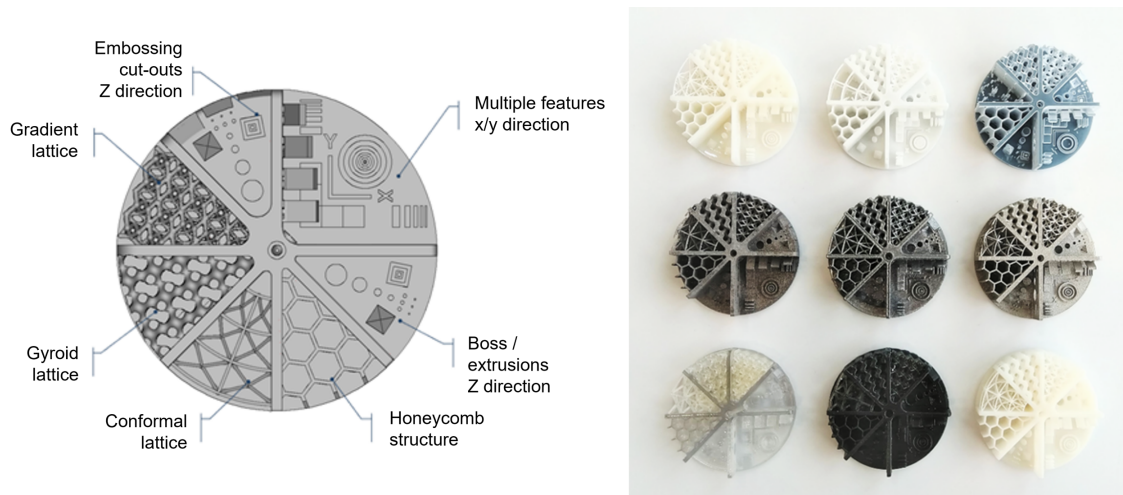


Figure 15. The OPTICON A2IM test geometry: *left*, a description of the key features; and *right*, nine test prints which were dimensionally evaluated for the project.

4. A2IM TEST GEOMETRY

Test geometries, or benchmarks, are built by AM users to assess the performance of their 3D printers. The OPTICON A2IM test geometry (Figure 15 *left*) was developed specifically for the astronomical engineering community by considering the type of geometries that might be of use in lightweight mirror design, such as lattice structures for mass reduction. In addition to the creation of the test geometry model, nine test geometries in different materials and via different AM methods were printed (Figure 15 *right*) and seven of the test geometries were dimensionally evaluated. The evaluation of the test geometries, highlighted the fidelity of the printed part to the CAD and therefore highlights which features can be printed with, or without support structures. This section briefly summarises the test geometry and the dimensional evaluation, for further information, including cost analysis, the reader is directed to the A2IM Test Geometry chapter within the Cookbook.

4.1 Design

The objective of the OPTICON A2IM test geometry was to create an artefact that could be printed using a variety of print methods and materials, and incorporating features and geometries of interest to the astronomical community, such as lattices. In the design of the test geometry, AM standards and existing benchmarks were investigated to ensure key features were included. A full discussion of the features is provided within the Cookbook, but an example of how the features were defined is shown in Figure 16.

4.2 Evaluation

Each of the features within the printed test geometries were evaluated both in the macroscopic and the microscopic domains. The macroscopic evaluation quickly identifies large geometric distortions, such as the presence of support material, or geometric defects. Microscopic analysis identifies the resolution and the limitation of the selected print method to accurately represent the CAD model. Using these techniques, each printed feature could be compared against the CAD in terms of dimensional fidelity; Figure 17 highlights an example of the type of evaluation that was undertaken.

4.3 An open source test geometry

The A2IM test geometry is open access and available for download under a Creative Commons license. The .STL and .STEP files can be accessed from the following online repositories.

GrabCad community: <https://grabcad.com/library/opticon-test-geometry-1>

Thingiverse: <https://www.thingiverse.com/thing:4893659>

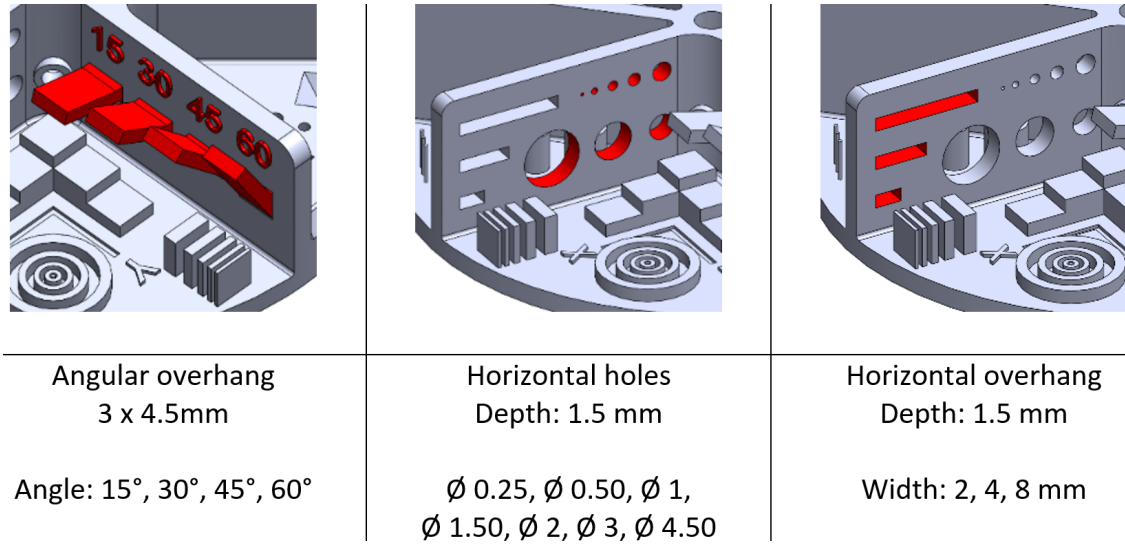


Figure 16. A subset of features within the test geometry and how they were defined.

5. THE FUTURE

The objective of this paper was to present some of fundamental considerations in the adoption of AM within astronomical instrumentation, which could then be expanded upon using the Cookbook. The goal of this paper, in conjunction with the Cookbook, was to assist engineers and scientists in the implementation of AM within astronomical instrumentation by removing some of the barriers that limits AM's wider adoption. The use of AM is expected to rise across the majority of industries in the future; however, AM does not replace subtractive, formative and fabricative methodologies, rather it exists in parallel, to be used where it is most effective, such as for mass reduction and part consolidation.

Although, it is hoped, that this paper and the Cookbook can help tackle some of the practical barriers in AM usage; it is the author's opinion that the biggest barrier to AM adoption is suitably trained engineers and scientists. AM is now common place within many engineering undergraduate degrees; however, without suitably trained senior engineers to mentor future graduates, uptake in future instrumentation will be slow, especially within the risk adverse field of astronomical instrumentation.

ACKNOWLEDGMENTS

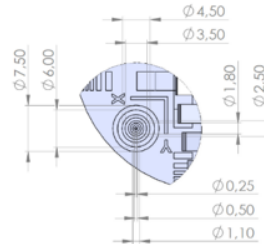
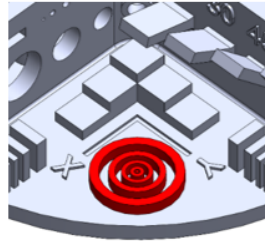
This project has received funding from the European Union's Horizon 2020 research and innovation programme under grant agreement # 730890. This material reflects only the authors views and the Commission is not liable for any use that may be made of the information contained therein. C. Atkins acknowledges the UKRI Future Leaders Fellowship program, grant # MR/T042230/1, for enabling delivery of this research. The authors acknowledge the generous support of David Bogg at the STFC - Campus Technology Hub for enabling the production of several A2IM test geometries.

REFERENCES

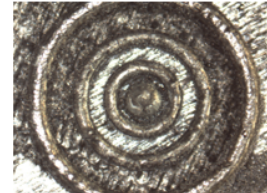
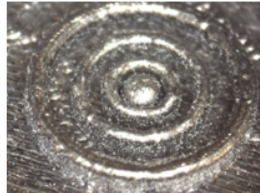
- [1] Schnetler, H., Atkins, C., Miller, C., Morris, K., Hugot, E., Roulet, M., Tenegi, F., Vega-Moreno, A., Farkas, S., Mező, G., Snell, R. M., Dufils, J., and van de Vorst, B., "H2020 OPTICON project overview: Investigating the use of additive manufacturing for the design and build of multi-functional integrated astronomical components," *Proc. of SPIE* **11451**, SPIE Astronomical Telescopes + Instrumentation (2020).
- [2] Roulet, M., Atkins, C., Hugot, E., Snell, R., van de Vorst, B., Morris, K., Marcos, M., Todd, I., Miller, C., Dufils, J., Farkas, S., Mezo, G., Tenegi, F., Vega-Moreno, A., and Schnetler, H., "Use of 3D printing in astronomical mirror fabrication," in [*3D Printed Optics and Additive Photonic Manufacturing II*], **11349**, International Society for Optics and Photonics, SPIE (2020).

Feature: Wall Thickness

Vertical wall thickness and spacings are determined laser spot size and melt pool. Side wall quality may cause powder removal problems.



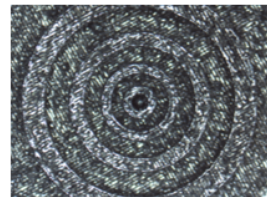
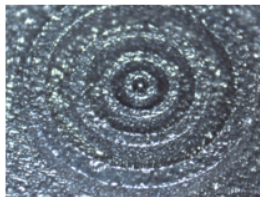
Powder Bed Fusion *Industrial* – AlSi10Mg



The outer three rings are free. The middle pillar is fused with the adjacent ring. Domed top surface topology.

Ring 1 Ø7.5 x 0.75 mm	Ring 2 Ø4.5x 0.5 mm	Ring 3 Ø2.5 x 0.35 mm	Ring 4 Ø1.1 x 0.3 mm	Middle Pillar Ø 0.25 mm
Present	Present	Present	fused	
7.48 mm	4.5 mm	2.58 mm		

Powder Bed Fusion *High Resolution* – AlSi10Mg



All circles are present and no excess material. Middle pillar of Ø 0.25 mm is present.

Ring 1 Ø7.5 x 0.75 mm	Ring 2 Ø4.5x 0.5 mm	Ring 3 Ø2.5 x 0.35 mm	Ring 4 Ø1.1 x 0.3 mm	Middle Pillar Ø 0.25 mm
Present	Present	Present	Present	Present
7.58 mm	2.54 mm	2.52 mm	1.10 mm	0.34 mm

Figure 17. Evaluation of the the printed test geometries to explore how the printed geometries matched the CAD.

- [3] Snell, R., Atkins, C., Schnetler, H., Todd, I., Hernández-Nava, E., Lyle, A. R., Maddison, G., Morris, K., Miller, C., Roulet, M., Hugot, E., Sanginés, F. T., Vega-Moreno, A., van de Vorst, L. T. G. B., Dufils, J., Brouwers, L., Farkas, S., Mező, G., Beardsley, M., and Harris, M., “An additive manufactured CubeSat mirror incorporating a novel circular lattice,” **11451**, International Society for Optics and Photonics, SPIE (2020).
- [4] Vega, A., Tenegi, F., Márquez-Rodríguez, J. F., van de Vorst, B., Dufils, J., Brouwers, L., Snell, R. M., Schnetler, H., Atkins, C., Miller, C., Morris, K., Roulet, M., Hugot, E., Farkas, S., and Mező, G., “Design for Additive Manufacturing (DfAM): The ‘Equivalent Continuum Material’ for cellular structure analysis,” *Proc. of SPIE* **11451**, SPIE Astronomical Telescopes + Instrumentation (2020).
- [5] Farkas, S., Agócs, T., Atkins, C., Bouwers, L., Dufils, J., Joó, A., Mező, G., Morris, K., Rodenhuis, M., Roulet, M., Schnetler, H., Snell, R., Tenegi, F., Vega-Moreno, A., and van de Vorst, B., “Freeform active mirror designed for additive manufacturing,” *Proc. of SPIE* **11451**, SPIE Astronomical Telescopes + Instrumentation (2020).
- [6] Morris, K., Atkins, C., Reynolds, L., Walpole, J., van de Vorst, L. T. G. B., Snell, R., Miller, C., Farkas, S., Mező, G., Roulet, M., Hugot, E., Vega-Moreno, A., Sanginés, F. T., and Schnetler, H., “Additively manufactured flexure for astronomy instrumentation,” **12188**, International Society for Optics and Photonics, SPIE (2022).
- [7] Snell, R. M., Atkins, C., Brouwers, L., Farkas, S., Feenstra, F., Kroes, G., Haynes, R., Holland, W., Hugot, E., Jáger, D., Mezo, G., Miller, C., Morris, K., Roulet, M., Schnetler, H., Tenegi, F., and Todd, I., [*Report on Additive Manufacturing Materials*], Zenodo (June 2020).
- [8] Atkins, C. and van de Vorst, B., [*OPTICON A2IM Cookbook and Test Geometry: an introduction to additive manufacture for astronomy*], Zenodo (Jun 2021).
- [9] Collon, M. J., Vacanti, G., Günther, R., Yanson, A., Barrière, N., Landgraf, B., Vervest, M., Chatbi, A., Beijersbergen, M. W., Bavdaz, M., Wille, E., Haneveld, J., Koelewijn, A., Leenstra, A., Wijnperle, M., van Baren, C., Müller, P., Krumrey, M., Burwitz, V., Pareschi, G., Conconi, P., and Christensen, F. E., “Silicon pore optics development for ATHENA,” in [*Society of Photo-Optical Instrumentation Engineers (SPIE) Conference Series*], *Society of Photo-Optical Instrumentation Engineers (SPIE) Conference Series* **9603** (Sept. 2015).
- [10] Levy, G. N., Schindel, R., and Kruth, J., “Rapid manufacturing and rapid tooling with layer manufacturing (LM) technologies, state of the art and future perspectives,” *CIRP Annals* **52**(2), 589–609 (2003).
- [11] Atkins, C., Brzozowski, W., Dobson, N., Milanova, M., Todd, S., Pearson, D., Brooks, D., Bourgenot, C., Snell, R. M., Sun, W., Cooper, P., Alcock, S. G., and Nistea, I.-T., “Lightweighting design optimisation for additively manufactured mirrors,” *Proc. of SPIE* **11116-42** (2019).
- [12] Angel, J. R. P., “Lobster eyes as x-ray telescopes,” *Astrophysical Journal* **233**, 364–373 (1979).
- [13] Xiang, Z., Wang, L., Yang, C., Yin, M., and Yin, G., “Analysis of the quality of slope surface in selective laser melting process by simulation and experiments,” *Optik* **176**, 68–77 (2019).
- [14] Snell, R. M., Atkins, C., Schnetler, H., Saunders, H., Beardsley, M., Harris, M., and Todd, I., “Towards understanding and eliminating defects in additively manufactured CubeSat mirrors,” **12188-28**, International Society for Optics and Photonics, SPIE (2022).