



**HAL**  
open science

# Frequency Reuse in IAB-based 5G Networks using Graph Coloring Methods

Matthieu Silard, Philippe Fabian, Georgios Papadopoulos, Patrick Savelli

► **To cite this version:**

Matthieu Silard, Philippe Fabian, Georgios Papadopoulos, Patrick Savelli. Frequency Reuse in IAB-based 5G Networks using Graph Coloring Methods. GIIS 2022: Global Information Infrastructure and Networking Symposium, Sep 2022, Argostóli, Greece. 10.1109/GIIS56506.2022.9937005 . hal-03844951

**HAL Id: hal-03844951**

**<https://hal.science/hal-03844951>**

Submitted on 9 Nov 2022

**HAL** is a multi-disciplinary open access archive for the deposit and dissemination of scientific research documents, whether they are published or not. The documents may come from teaching and research institutions in France or abroad, or from public or private research centers.

L'archive ouverte pluridisciplinaire **HAL**, est destinée au dépôt et à la diffusion de documents scientifiques de niveau recherche, publiés ou non, émanant des établissements d'enseignement et de recherche français ou étrangers, des laboratoires publics ou privés.

# Frequency Reuse in IAB-based 5G Networks using Graph Coloring Methods

Matthieu Silard<sup>1</sup>, Philippe Fabian<sup>1</sup>, Georgios Z. Papadopoulos<sup>1,2</sup>, Patrick Savelli<sup>1</sup>

<sup>1</sup>B-com, Rennes, France

<sup>2</sup>IMT Atlantique, IRISA, Rennes, France

**Abstract**—Integrated Access and Backhaul (IAB) is a new standard for multi-hop 5G networks. It allows to use cellular frequencies for both backhaul and access purposes. Furthermore, wireless backhauling reduces deployment costs for cellular network densification compared to fiber. However, the fact millimeter Wave (mmWave) frequencies have shorter range and considering the additional interference from backhaul links, the deployment of such a solution is a complicated issue. In our vision, a solution for frequency allocation using a graph coloring approach is key in improving performance. In this paper, we propose a semi-centralized algorithm where the IAB-Donor computes the pairs of interfering nodes in the network to determine conflicting frequency usage. Nodes are then allocated specific bands and can locally adjust them to communicate with their children. Simulation results show that the proposed solution is more than 50% efficient in terms of throughput compared to a centralized allocation by link coloring.

**Index Terms**—Integrated Access and Backhaul, IAB, 5G, Interference Management, Graph Coloring, 3GPP.

## I. INTRODUCTION

The number of devices connected to wireless networks is constantly growing. The increase in traffic as well as user requirements must be taken into account to maintain Quality of Service (QoS). 5G has been designed to meet the constraints of densification of cellular networks. It allows to satisfy the users demand thanks to new radio frequency bands. The introduction of millimeter waves brings a big gain in throughput, however, at the cost of very high pathloss and shadowing [1]. To address this, more base stations (gNBs) must be deployed so that the user is always in Line-of-Sight (LoS). Since gNBs require fiber-connected backhaul, densifying a network can be very expensive. One solution is to use wireless links for communication between gNBs.

Since 2017, the 3rd Generation Partnership Project (3GPP) in charge of the 5G New Radio (NR) specification started standardizing the IAB solution [2]. IAB allows the usage of cellular frequencies for both the backhaul and the access links. This eases the deployment of gNBs by removing the need to install fiber to connect the antennas to one another.

This implies more radio traffic and therefore may lead to more interference. However, the QoS for the users must be maintained. Time Division Duplex (TDD) allows communication within the network to be divided by slot in time domain. This allows different devices to be coordinated to prevent interference. In the same way, we can do resource division on the frequency domain (FDD).

The focus of this contribution is on frequency allocation in IAB 5G mesh networks and how to mitigate the interference between devices. We present a way to divide the set of routing

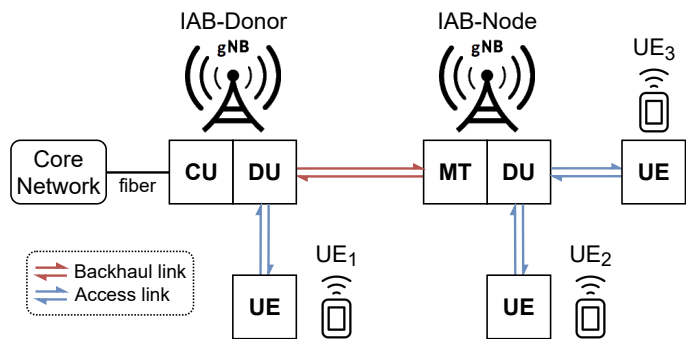

Fig. 1: An IAB network structure example.

links into slots in a half-duplex ST topology, as well as a frequency allocation method that prevents interference using graph coloring. We test our approach using omnidirectional antennas, which is more general and potentially usable outside of an IAB topology.

This paper is structured as follow: in Section II, we detail the functioning of an IAB network and present the state of the art. Then, in Section III, the motivations are discussed and the solution we propose is detailed. The performance evaluation is done in Section IV. Section V concludes this paper and gives some indications about future work.

## II. TECHNICAL BACKGROUND & RELATED WORK

### A. Integrated Access and Backhaul

IAB is a novel 5G-NR network deployment solution introduced in the release 16 of the 3GPP specifications. It is designed to support wireless backhauling of gNBs, using the same radio resources and air interface as the access link between gNBs and User Equipments (UEs). The performance of 5G makes it possible to have several hops across the Radio Access Network (RAN). This approach allows fast and cost effective deployments avoiding fiber installation, whenever there is a need to increase the network capacity by adding base stations to the network. In the context of Frequency Range 2 (FR2) deployments, this is of particular interest since the gNBs densification is required due to the inherent reduced range of the transmitted RF signal at these frequencies.

As shown in Fig. 1, an IAB network contains 3 types of device:

- The IAB-Donor is a gNB connected by fiber to the core network. It is composed of a Central Unit (CU), and a Distributed Unit (DU), as defined in the 5G RAN architecture [3]. The CU has a global knowledge of both the network

and device capabilities thanks to the Information Elements (IEs) broadcasted by all DUs (see [4] section 9.3.1.10). It is able to manage the network topology by connecting UEs or reconnecting them following the breaking of a link for example. It also configures all DUs by sending them an IE in order to coordinate them together (see [4] section 9.3.1.89).

- The IAB-Node is a modified gNB that operates as a relay with a DU and a Mobile Termination (MT) component. The MT implement similar fonctions as a UE, that allows the IAB-Nodes to connect to the Donor, either by a direct wireless link or through another IAB-Node.
- UEs are conventional terminals with 5G-NR capabilities.

Throughout the paper, the term gNB can designate both an IAB-Donor or an IAB-Node.

If a UE or IAB-MT implements the Dual Connectivity (DC) feature, the devices can have two IAB-DUs as parents (see [5] section 4.7.4.3). It is also possible for an IAB-Node to have multiple MTs in order to have different backhaul links. These two techniques are useful for load balancing or responsiveness in case of link failure for example. IAB networks may have a Directed Acyclic Graph (DAG) topology if a node has several parents. In contrast, we have a Spanning Tree (ST) topology if each node only has one parent (see [2] section 9.2).

Backhaul links are wireless communications between gNBs, and access links are between the UE and its serving DU (see Fig. 1). UpLink (UL) goes from UEs to the Donor and DownLink (DL) from the Donor to UEs.

Half-duplex constraints means that a device cannot transmit and receive at the same time due to self interference. The multiplexing capabilities between the MT and DU parts of an IAB-node are sent to the CU over an IE ([4] section 9.3.1.108). For a given IAB-Node, it is possible for DU and MT to operate at the same time with half-duplex constraints by either receiving or transmitting simultaneously. Thanks to this, the MT can operate in UL while the DU operates in DL and vice versa.

Frequencies within FR1 and FR2 can be used for an IAB network. The backhaul and access links can have separate frequency bands (out-of-band mode) or they can share a common frequency band (in-band mode).

### B. Related Work

Since the publication of the specifications in 3GPP Release 16, several performance evaluations of IAB networks have been conducted. They allow to understand the functioning of these networks and confirm the benefits of this type of architecture [6], [7].

Path establishment is performed during the construction or adaptation of the network topology. It interconnects all the devices of the network by linking them in an optimal way. It is different from path selection which consists in forwarding a packet to its destination over a DAG topology (e.g. with DC features). In order to optimize the routing in the network, we can give weights to the nodes or links according to their capacity, their number of children or their depth from the donor. In [8], the authors assign weights to links to find the most profitable path in a DAG topology. In [9], a bottom-up approach

is employed for path selection and frequency allocation in a DAG topology. This method assumes perfect beam alignment and a noise limited system.

The frequency distribution problem has also been studied in different forms to avoid interference between devices. In [10], a mobile IAB (mIAB) scenario is considered. The proposed solution is to mute the MT or DU to avoid interference. There are slots during which the MT or the DU does not perform any DL or UL. This paper discusses the possibility of having the MT and the DU of a gNB operating at the same time according to different multiplexing constraints as explained in II-A. However, no solution is proposed for this option.

In [11], a given set of links must be selected according to their priority. At each iteration, this subset of directed routing links must be allocated in time and frequency. This allocation allows these links to respect the half-duplex and interference constraints. It was accomplished using a conflict graph considering these constraints. This paper uses an IAB ST topology and involves the use of beamforming. However, it does not minimize the number of simultaneously scheduled group links. This would allow for longer operating periods for each link.

Interference management has already been studied prior to the IAB introduction in the context of mesh networks with the same constraints. The hidden terminal problem is introduced in [12]. This problem occurs when a device will not be able to receive properly due to radio interference with another nearby device using the same resources. More generally, these interference are also referred to as Cross-Link Interference (CLI).

The graph coloring approach has been investigated in order to optimize resource allocation. In [13], the authors introduce the concept of interference graph (called conflict graph in [11]) In addition, different coloring techniques are also mentioned.

Mesh networks have also been studied in Internet of Things (IoT) networks. [14] uses the graph coloring approach applied to Time Slotted Channel Hopping (TSCH) networks. Different sets of links split in time domain are used to create interference graphs. It uses receiving devices of the slot as nodes in interference graph. Frequency assignment is performed on these graphs using a coloring algorithm. This allocation avoids CLI, but does not allow any spatial reuse as it is done in [11]. Without spatial reuse, this solution will be less efficient the more devices there are in the network.

Research on IAB networks often considers that every device is equipped with directional antennas using Multiple-Input and Multiple-Output (MIMO) capabilities. We believe a more general approach considering omnidirectional antennas is relevant, and could be extended to other use cases.

### III. CLI MANAGEMENT WITH SPATIAL REUSE

In this section, we discuss in a first part why omnidirectional antennas are considered and explain the increased number of possible CLIs in IAB compared to conventional cellular networks (III-A). Then in III-B, we present our proposed solution to avoid interference in an IAB ST topology. Finally, the details of our allocation scheme based on interference graphs are described in III-C.

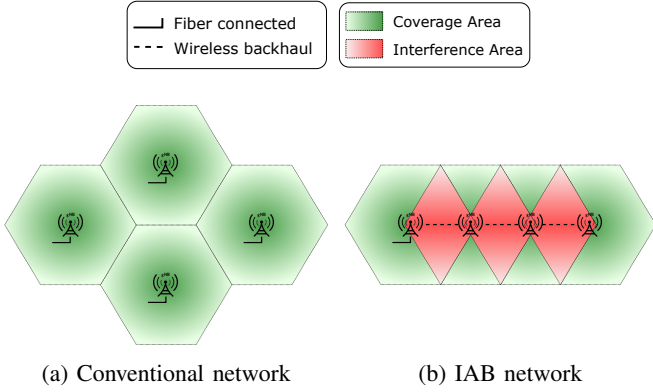

Fig. 2: Interference in IAB using an hexagonal representation.

### A. Motivations

The idea is to create a model for interference management in mesh networks with omnidirectional antennas and with half-duplex capability. To the best of our knowledge, no IAB interference management solution using omnidirectional antennas has been investigated. These antennas are cheaper to produce and may allow the deployment of networks at lower cost [15]. Moreover, working with directional antennas may prove more difficult in supporting gNBs with continuous mobility as in future mIAB networks [10].

Unlike a conventional cellular network (Fig. 2a), the gNBs in IAB must be within range of each other. As a result, the amount of interference area increases significantly (see Fig. 2b). An interference area occurs when two nearby transmitters use the same resources (same frequency at the same time). If a receiver is in an interference zone its capacity to receive will be badly impacted. This results in a higher number of errors in the received messages, so more retransmissions. As a result, the receiver's throughput will decrease and its latency will increase. In a ST network, if an intermediate node is interfered, it will impact all children in its branch. We have to take interference into account in order to preserve the QoS of the whole network.

### B. Proposed Solution

The goal is to find a way to divide the frequency band into sub-bands and distribute them between the different devices. The idea is to reuse the same sub-bands for gNBs if they will not interfere the same receiver. In this paper, we call this notion "Spatial Reuse". It should not be confused with the notion of spatial reuse already defined in beamforming technology. With beamforming, spatial reuse can be performed locally by a gNB with Multi-User MIMO (MU-MIMO) capabilities [16].

In IAB, the donor-CU provides frequency resources to each DU and MT according to the CLI constraints. The CU has a global knowledge of the network topology, and it decides when devices can transmit or receive. It knows all the nodes that interfere with each other thanks to IEs sent by each DU (see [4] section 9.3.1.91).

We consider interference to be bidirectional: If a device  $A$  is interfered by one of its neighbors  $B$  when  $B$  transmits,  $A$  will also interfere  $B$  when  $A$  transmits.

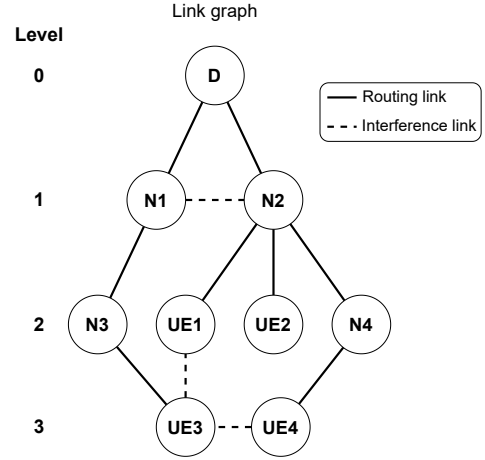

Fig. 3: Link graph including all network devices which are linked if they interfere one another.

We consider the simple directed graph of devices that interfere with each other in the network. We call it the link graph as shown in Fig. 3 and denote it  $G(V, E)$ .  $V$  is the set of devices and  $E$  the set of bidirectional interference links.

In Fig. 3, the solid lines represent the links in  $E$  that are used for routing. The IAB ST topology of the routing links overlaps the link graph.

Instead of using a centralized method as in [11], which allocates specific frequency to each radio link, we propose a semi-centralized solution. The allocation is made in two steps. First, the CU gives sub-bands to each device, then each of them can allocate its resources according to its own scheduling algorithm. By doing this, the gNBs use more up-to-date link quality information than if they had to report it all the way back to the CU. Therefore, resource allocation is more efficient as it is performed locally.

Since gNBs can use the same scheduling algorithms as in a conventional cellular network, this contribution relates to the frequency allocation performed by the CU. Hence, our solution can be used with a smart local allocation algorithm (at the IAB-Node) to improve performance even more.

We use the same idea of interference graph for our frequency allocation as in [14]. At each slot  $S$ , we build the interference graph  $IG_S(V_S, E_S)$ .  $V_S$  is a subset of  $V$  and  $E_S$  a subset of scheduled routing links during slot  $S$  that satisfy the half duplex constraints.

In IABs, gNBs have the ability to receive from multiple neighbors, unlike TSCH networks studied in [14]. Using a receiver-oriented interference graph, a receiver will only have one color (sub-band) and its transmitters cannot agree on which resources they should use. Due to this specificity,  $V_S$  must contain the transmitting devices of slot  $S$ .

A simple model can be written to represent our approach. A link is considered active when it is allowed to transmit data during a slot. A routing link  $e_{x,y} \in E$  with transmitter  $x$  and receiver  $y$  will be active or inactive on frequency  $F$  at slot

$S$  (Eq. 1).

$$e_{x,y}(F, S) = \begin{cases} 1 & \text{if active} \\ 0 & \text{if inactive} \end{cases} \quad \text{With } x, y \in V \mid x \neq y \quad (1)$$

Consider a pair of links with  $e_{x_1, y_1}(F_1, S_1) = 1$  and  $e_{x_2, y_2}(F_2, S_2) = 1$ . In our assumptions, any pair of active links must respect two constraints. The first one (Eq. 2) takes into account the half duplex. A node cannot be a transmitter and a receiver at the same time:

$$(S_1 = S_2) \Rightarrow x_1 \neq y_2 \wedge x_2 \neq y_1 \quad (2)$$

The second one (Eq. 3) prevents the use of the same resources if there is an interference link between the first (respectively second) transmitter and the second (respectively first) receiver.

$$(e_{x_1, y_2} \in E \vee e_{x_2, y_1} \in E) \Rightarrow F_1 \neq F_2 \vee S_1 \neq S_2 \quad (3)$$

As we use a ST routing topology, each device has a depth in the network according to its distance from the Donor  $D$  (noted **Level** in Fig. 3). The sets of active links are chosen to minimize the number of slots. Thus, a device will have to wait less time before it can transmit/receive again and the latency of the UEs will decrease. By using a ST topology and multiplexing capabilities of MT and DU, it is possible to assign all UL and DL connections in only two slots while respecting the half duplex constraints. These two slots are represented in Fig. 4a.

To avoid interfering a Receiver (Rx), it is necessary that the Rx's neighboring transmitters in the link graph use different frequencies than those received by the Rx. As an example, in slot 1 of Fig. 4a, when  $UE1$  transfers data to its parent  $N2$ , it interferes with  $UE3$  which is receiving data from its parent  $N3$ . Thus,  $UE1$  and  $N3$  must operate on different frequencies.

### C. Interference Graph Construction

Our scheduling algorithm (Algo. 1) takes as input the set of active links during a slot, as well as the set of interferences in the network thanks to Remote Interference Management (RIM) Reference Signal (RS). They are both visible in Fig. 4a, which represents the same network as Fig. 3.

All active links are scheduled in two slots according to the half duplex constraints. Based on them, we create interference graphs for each slot (Fig. 4b). As said in section III-B, each of them contains all devices transmitting during the slot. Two transmitters are linked if one of them interferes with one of the receivers of the second transmitter inside the link graph.

To allocate the frequencies, we apply the same coloring algorithm on each interference graph as in [14]. Each color represents a unique set of frequencies that may have different sizes. Thus, we avoid that two interfering devices share the same frequency while reusing them as much as possible.

The coloring of the two slots are completely independent. The colors between slot 1 and slot 2 in Fig. 4c do not need to share the same frequencies or have the same size. This can be seen in Fig. 5 where  $D$  and  $N2$  are both in blue.

Finally, we describe the algorithm used to create the interference graphs (Algo. 1). The link graph is denoted as  $G(V, E)$  as in section III-B, where  $V$  represents the set of devices in the

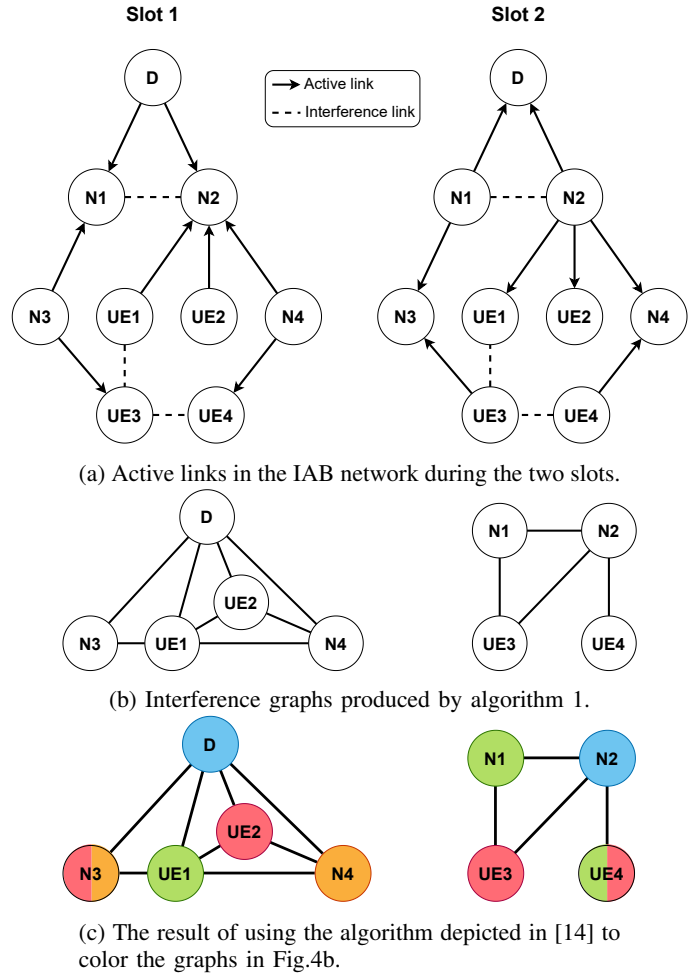

Fig. 4: The different steps for frequency band distribution.

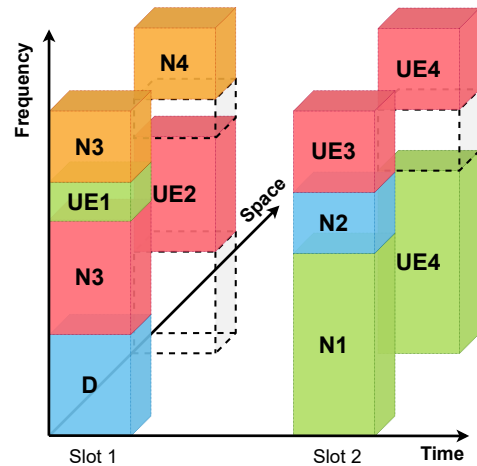

Fig. 5: Example of frequency band distribution in 3D.

---

**Algorithm 1:** Interference Graph computation per Slot.

---

**Input** :  $G(V, E)$  - Link Graph $ActiveLinks_S$  - set of directional  $Tx$  to  $Rx$  routing links during slot  $S$ **Output:**  $IG_S(V_S, E_S)$  the interference graph of slot  $S$ 

```
1 begin
2   while  $ActiveLinks_S \neq \emptyset$  do
3      $link1 \leftarrow ActiveLinks_S.pop()$ ;
4     Add  $link1.Tx$  to  $V_S$ ;
5     for  $link2 \in ActiveLinks_S$  do
6       if  $link2.Tx \in N_{link1.Rx}$  then
7         Add  $(link1.Tx, link2.Tx)$  to  $E_S$ ;
8       end
9     end
10  end
11  return  $IG_S(V_S, E_S)$ ;
12 end
```

---

IAB network and  $E$  is the set of linked devices that interfere with each other. The set of neighbors of a vertex  $v$  in  $G$  is noted  $N_v$ .  $ActiveLinks$  is the set of links that are simultaneously active during the considered slot (respecting the half duplex constraints). These links are directional, the first node is the transmitter and the second the receiver, noted respectively  $Tx$  and  $Rx$ .

As long as there are links in the  $ActiveLinks$  set, we randomly remove one of the them and assign it as  $link1$  (lines 2 and 3). In line 4, we add the transmitter of  $link1$  to  $V'$ . For each other link in  $ActiveLinks$ , denoted  $link2$ , we check if the transmitter of  $link2$  is neighboring the receiver of  $link1$  (lines 5 and 6). If it is, we add a link between the transmitters of  $link1$  and  $link2$  to  $E'$  in line 7. Then we repeat until the  $ActiveLinks$  set is empty. As an output, we finally obtain the undirected interference graph  $IG_S(V_S, E_S)$  of the slot (Fig. 4b).

#### IV. PERFORMANCE EVALUATION

##### A. Simulation Setup

In order to evaluate the performance of our semi-centralized frequency allocation method, we use a simple fixed routing topology (see Fig. 6). We assume that this topology has been computed by the CU. When possible according to our assumptions, we use parameters from 3GPP specifications for the evaluation of IAB systems (see [2] table A.1-1). These parameters are shown in Table I.

Instead of integrating Urban Micro (UMi) Street Canyon channel model from 3GPP specification that considers many factors, we use the one detailed in [17]. It is simpler to implement and will allow to take into account the possible interference on a device, when two antennas are transmitting on the same frequency.

Since we only operate in downlink, uplinks will only be used as interference links. In the topology (Fig. 6), the uplink links from  $Node_1$  to  $Donor$  and from UE to  $Node_3$  have no impact:

- The donor does not receive, it will not be interfered.

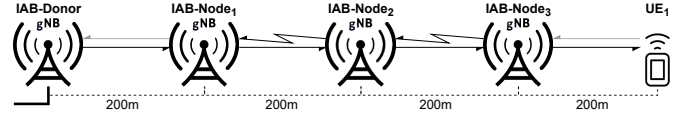

Fig. 6: The topology used in the simulations.

TABLE I: Values of the parameters used in the simulations.

Parameter	Value
# of IAB-Donor	1
# of IAB-Node	3
# of UE	1
Inter-BS distance	200 m
Duplex mode	TDD DownLink
Packet per slot	1
Packet size	From 20 to 2400 bits
Carrier frequency	30 GHz
System bandwidth	400 MHz
Subcarrier Spacing (SCS)	120 kHz
# of Resource Block (RB)	264 (see [18] table 5.3.2-1)
# of subcarrier per RB	12
# of OFDM symbols per RB	14
Slot Duration	0.125 ms
Simulation duration	50 000 slot (6.25 s)
BS Tx power	33 dBm
BS noise figure	7 dB
Thermal noise power density	-174 dBm/Hz
Device Scheduler	MaxSNR
Path-loss exponent	3.5 (urban context)
Target BER	$5 \cdot 10^{-5}$
Multipath fading	Rayleigh fading
Shadowing	Log-normal distribution
Standard deviation of shadowing	8 dB

- The UE does not transmit, it will not interfere anyone.

On the other hand,  $Node_2$  will interfere  $Node_1$  when it transmits to  $Node_3$ . In the same way,  $Node_3$  will interfere  $Node_2$  when it transmits to UE.

To simulate an increasing load, the size of packets generated at each slot increases linearly. It starts at 20 bits and reaches 2400 bits at the end of the simulation. When 100% of the resources of a link are used, the system becomes saturated and the maximum throughput is reached.

Real simulation time is 6.25 seconds. It is assumed that during this time no interference links (including access and backhaul links) are broken or established. As in [17], we use Shannon's formula to calculate the spectral efficiency of the UE, i.e. the number of bits it is able to receive taking into account the radio conditions. Each device has the same scheduler, which is a standard MaxSNR.

##### B. Scheduling Algorithms

In this paper, we compare the following methods:

**Reuse 1:** is not performing any interference management. Each device has access to the entire bandwidth of the network. It is used as a base case to verify the correct operation of the interference model.

**Link Coloring with Spatial Reuse [11]:** is a centralized allocation approach, which is achieved by graph edge coloring. As in [11], sub-bands are allocated to each link and are reused when it does not involve interference. Contrary to [11], the

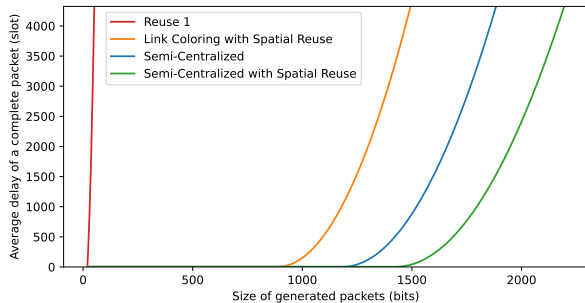

(a) Average packet delay depending on load.

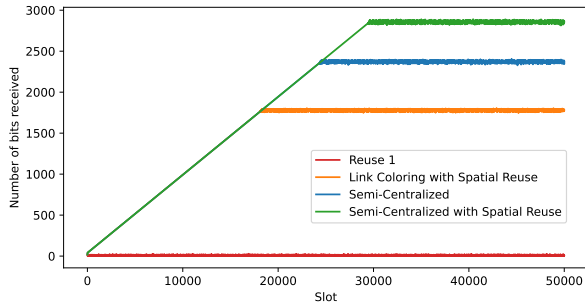

(b) Receiver throughput according to time.

Fig. 7: Results of the simulations. **Reuse 1** is the base case and **Semi-Centralized with Spatial Reuse** represents our solution.

allocation is adapted with omnidirectional antenna constraints and avoids interference.

**Semi-Centralized:** consists in allocating bands to each device, but without spatial reuse. This is done by dividing the entire band by the number of devices. Similar to [14] but with the multi-user IAB capability as described in section III-B.

**Semi-Centralized with Spatial Reuse:** Our frequency allocation solution explained in section III-C combines the frequency reuse of Link Coloring, but the sub-bands are allocated to the devices as in Semi-Centralized.

### C. Simulation Results

In Fig. 7a, we compare the delay of the packets according to the load of the system. The load is increased by growing the size of the packets sent to the UE. Fig. 7b shows the received throughput of the UE during the simulation. The throughput increases according to the size of the packets until all resources on a link are allocated. When this happens, the link becomes congested. All the children on this link are impacted. At this point, the user’s throughput depends only on the radio conditions of the congested link. When congestion occurs, the remaining fluctuations are due to the randomly generated multipath.

The Reuse 1 solution in red has the worst performance. This is due to the absence of interference management. The spectral efficiency of the interfered links is very low. At each hop, few bits arrive at their destination without error (Fig. 7a). The antennas near the UE are not transmitting at the beginning of the simulation. Hence, the first packets will not suffer any

interference. That’s why the red line starts with the same delay as the others (Fig. 7b). However, these packets interfere with other ones when they are transmitted.

The centralized solution in orange, which corresponds to the link coloring, considers interference. However, since the allocation was made by a CU, it uses outdated radio conditions. The CU must then send the available frequencies to each device according to these radio conditions. The frequencies assigned by the CU may not be the most optimal when they are received by the devices. This solution does not allow devices to allocate the best resources to their receivers. Delay increases at 930 bits of packet size because of a congested link (see Fig. 7a). In Fig. 7b, congestion is reached around slot 18300 and the capacity is limited to 1800 bits/slot for the aforementioned reasons.

Instead of providing link-specific resources like the previous algorithm, the blue solution allows gNBs to use their own scheduler. The resources are allocated dynamically by each DU in a given frequency band. Thus, they can use more up-to-date radio conditions. Congestion happens later. Here, the delay starts to increase from 1210 bits of packet size (see Fig. 7a). In Fig. 7b, we reach the congestion at slot 24500 with a constant throughput for the UE of 2350 bits/slot.

Our solution, in green, is the one that delays congestion the most. The first packets with a significant delay have a size of 1450 bits. The system is congested after slot 30000. By reaching 2860 bits/slot, this solution beats the semi-centralized solution by 21.7% and link coloring solution by 58.8%. It maximizes the throughput for the user.

## V. CONCLUSION AND FUTURE WORK

The increasing number devices and the shorter range of mmWave frequencies make challenging the issue of resource allocation in an IAB-based 5G network. We have demonstrated that the proposed solution is the most efficient in terms of packet delay and throughput for an equivalent load. We are convinced a semi-centralized graph coloring approach with frequency reuse allows to increase performance in a more general way. Future work will focus on the integration of the UMi Street Canyon channel model described in [19] section 7.4. This will allow for instance to add mobility to the IAB node and UEs, have a 3D simulation environment or add LoS and Non-LoS UEs. Our solution can also be evaluated in other mesh networks to test its adaptability, given the more general approach in using omnidirectional antennas.

## REFERENCES

- [1] S. A. Busari, S. Mumtaz, S. Al-Rubaye, and J. Rodriguez, “5g millimeter-wave mobile broadband: Performance and challenges,” *IEEE Communications Magazine*, vol. 56, no. 6, pp. 137–143, 2018.
- [2] 3GPP, “TR 38.874 v16.0.0, Study on Integrated Access and Backhaul (Release 16),” December 2018.
- [3] —, “3GPP TS 38.401 V16.8.0, NG-RAN; Architecture description (Release 16),” December 2021.
- [4] —, “TS 38.473 V16.8.0, NG-RAN; F1 application protocol (F1AP) (Release 16),” December 2021.
- [5] —, “TS 38.300 V16.8.0, NR and NG-RAN Overall Description; Stage 2 (Release 16),” December 2021.
- [6] V. F. Monteiro, F. R. M. Lima, D. C. Moreira, D. A. Sousa, T. F. Maciel, B. Makki, and H. Hannu, “Paving the way towards mobile iab: Problems, solutions and challenges,” 2022. [Online]. Available: <https://arxiv.org/abs/2206.14946>

- [7] P. Fabian, G. Z. Papadopoulos, P. Savelli, and B. Cousin, "Performance Evaluation of Integrated Access and Backhaul in 5G Networks," in *2021 IEEE Conference on Standards for Communications and Networking (CSCN)*, 2021, pp. 88–93.
- [8] M. Simsek, M. Narasimha, O. Orhan, H. Nikopour, W. Mao, and S. Talwar, "Optimal Topology Formation and Adaptation of Integrated Access and Backhaul Networks," *Frontiers in Communications and Networks*, vol. 1, 2021.
- [9] H. Alghafari and M. S. Haghghi, "Decentralized joint resource allocation and path selection in multi-hop integrated access backhaul 5G networks," *Computer Networks*, vol. 207, p. 108837, 2022.
- [10] V. F. Monteiro, F. R. M. Lima, D. C. Moreira, D. A. Sousa, T. F. Maciel, B. Makki, R. Shreevastav, and H. Hannu, "TDD frame design for interference handling in mobile IAB networks," 2022. [Online]. Available: <https://arxiv.org/abs/2204.13198>
- [11] Y. Li, J. Luo, R. A. Stirling-Gallacher, and G. Caire, "Integrated access and backhaul optimization for millimeter wave heterogeneous networks," 2019. [Online]. Available: <https://arxiv.org/abs/1901.04959>
- [12] S. Gandham, M. Dawande, and R. Prakash, "Link scheduling in wireless sensor networks: Distributed edge-coloring revisited," *Journal of Parallel and Distributed Computing*, vol. 68, no. 8, pp. 1122–1134, 2008.
- [13] J. Riihijarvi, M. Petrova, and P. Mahonen, "Frequency allocation for WLANs using graph colouring techniques," in *Second Annual Conference on Wireless On-demand Network Systems and Services*, 2005, pp. 216–222.
- [14] V. Kotsiou, G. Papadopoulos, P. Chatzimisios, and F. Theoleyre, "Adaptive Multi-Channel Offset Assignment for Reliable IEEE 802.15.4 TSCH Networks," in *2018 Global Information Infrastructure and Networking Symposium (GIIS)*. Thessaloniki, Greece: IEEE, Oct. 2018, pp. 1–5.
- [15] P. Moberg, A. Osseiran, and P. Skillermark, "Cost comparison between siso and mimo deployments in future wide area cellular networks," in *VTC Spring 2009 - IEEE 69th Vehicular Technology Conference*, 2009, pp. 1–5.
- [16] J.-S. Park, A. Nandan, M. Gerla, and H. Lee, "Space-mac: enabling spatial reuse using mimo channel-aware mac," in *IEEE International Conference on Communications, 2005. ICC 2005. 2005*, vol. 5, 2005, pp. 3642–3646 Vol. 5.
- [17] C. Merlhe, C. Gueguen, and X. Lagrange, "Hybrid joint-transmission multi-point coordination for inter-cell interference management," in *2021 IEEE 93rd Vehicular Technology Conference (VTC2021-Spring)*, 2021, pp. 1–7.
- [18] 3GPP, "3GPP TS 38.101-2 V17.6.0, NR; User Equipment (UE) radio transmission and reception; Part 2: Range 2 Standalone (Release 17)," June 2022.
- [19] —, "3GPP TR 38.901 V17.0.0, Study on channel model for frequencies from 0.5 to 100 GHz (Release 17)," March 2022.