



Influence of topography on the optical performances of a Fresnel linear concentrator array: the case of the eLLO solar power plant



PhD student: MONTANET Edouard ^a

Thesis director: RODAT Sylvain ^a

Thesis co-supervisor: FALCOZ Quentin ^a

Industrial supervisor: ROGET Fabien ^b

^a Laboratory PROMES - CNRS, Odeillo, France

^b eLLO solar power plant - SUNCNIM, Llo, France

Summary :

- I. eLLO solar power plant overview
- II. Optical modelling of eLLO solar collector
- III. Influence of LFC arrays topography on their optical performances

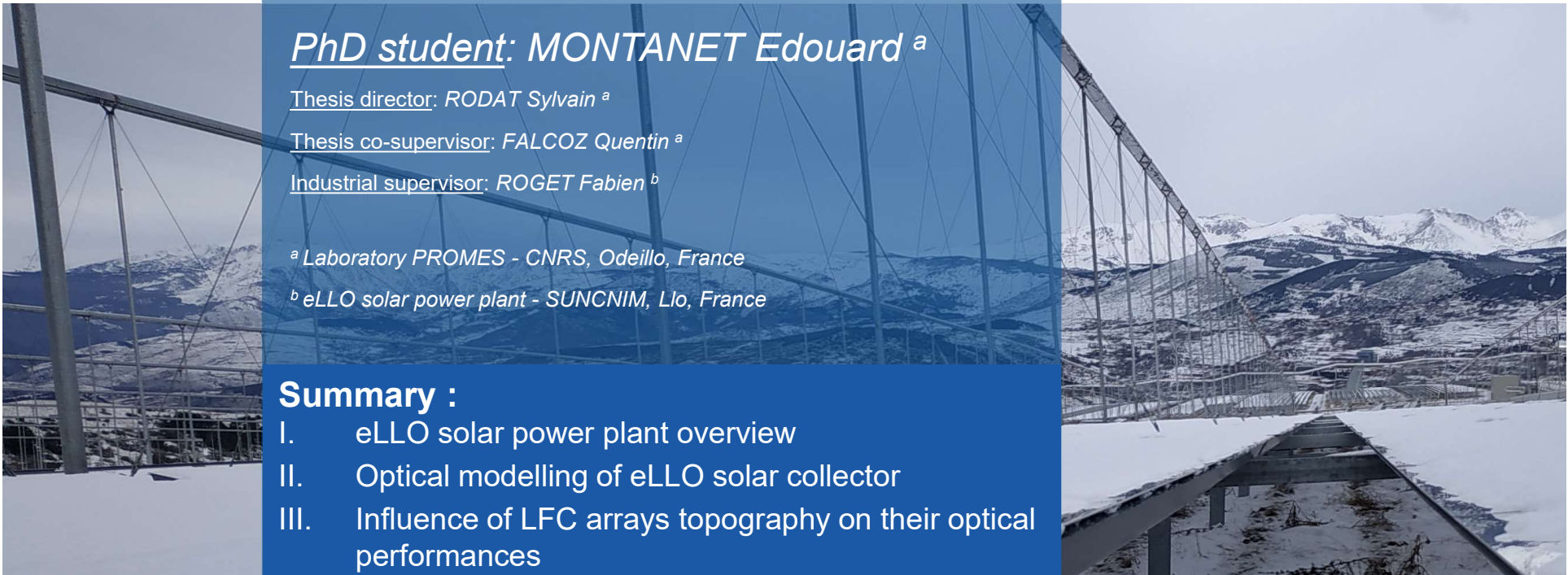

I. eLLO Solar Power plant project overview

Background:

- Inaugurated in **September 2018**
- Operated by:



- Located in a **mountainous region** in **South of France**
- **9 MW** solar power plant
- Expected generation: **20.2 MWh_e / year**

PROMES

Solar fields:



- **27 solar lines** consisting of **170 LFC modules**

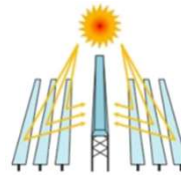

Linear Fresnel concentrator - LFC

- **Total collection area** of **153 442 m²**
- Operates in **Direct Steam Generation** - DSG
- Operating pressure and temperature of: **70 bars ; 286°C**

Storage system:



- **9 parallel Ruth's steam accumulator** of **120 m³** each
- Storage of **sensitive energy** in the form of **pressurized water**
- Maximum load equivalent to **4 hours of production** at full power
→ **World premiere**

Power block:



- **9 MW superheated steam turbine**
- **Dry air condenser** *no water consumption*
- Several pumps and water heaters

I. eLLO Solar Power plant project overview

The eLLO's module configuration is imposed by the topography of the implementation site:



Satellite view of the eLLO solar power plant



Photo of the transversal plane of eLLO's solar line

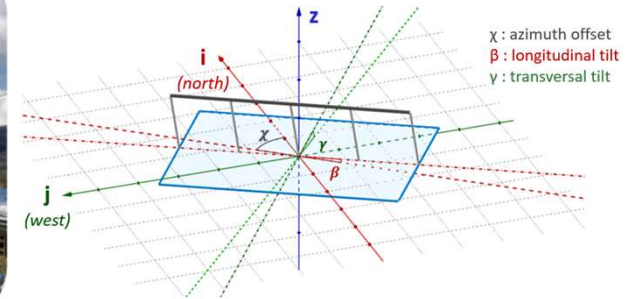

Schematic of eLLO's module configuration

- **Solar field orientation is offset** by 50.9° from the north-south axis
azimuth offset χ
- **Modules are individually inclined** to follow the slope of the land in the **transversal and longitudinal planes**
longitudinal tilt β and transversal tilt γ



II. Optical characterization of eLLO's module

Optical yield:

$$\eta_{opt} = \frac{\text{Total absorbed power on the absorber}}{\text{Total incident solar power}}$$

Incidence Angle Modifier – IAM:

$$IAM(\theta_{\parallel}, \theta_{\perp}) = \frac{\eta_{opt}(\theta_{\parallel}, \theta_{\perp})}{\eta_{opt,max}}$$

With θ_{\parallel} the longitudinal angle, θ_{\perp} the transversal angle and θ_i the incidence angle.

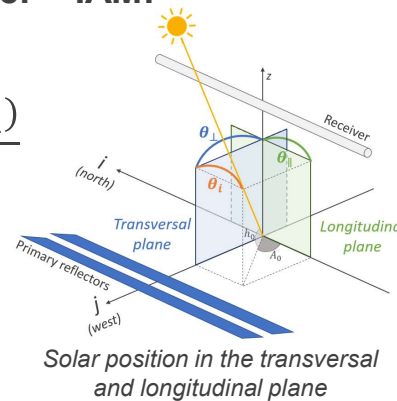

Factorized IAM for LFC modules^[1]:

$$IAM(\theta_i, \theta_{\perp}) = IAM_{\parallel}(\theta_i) \cdot IAM_{\perp}(\theta_{\perp})$$

Note that θ_i is equal to θ_{\parallel} when $\theta_{\perp} = 0$

Tonatiuh^[2] software overview:

Open-source Monte Carlo Ray-Tracing - MCRT software developed by the CENER and fully available on Github.

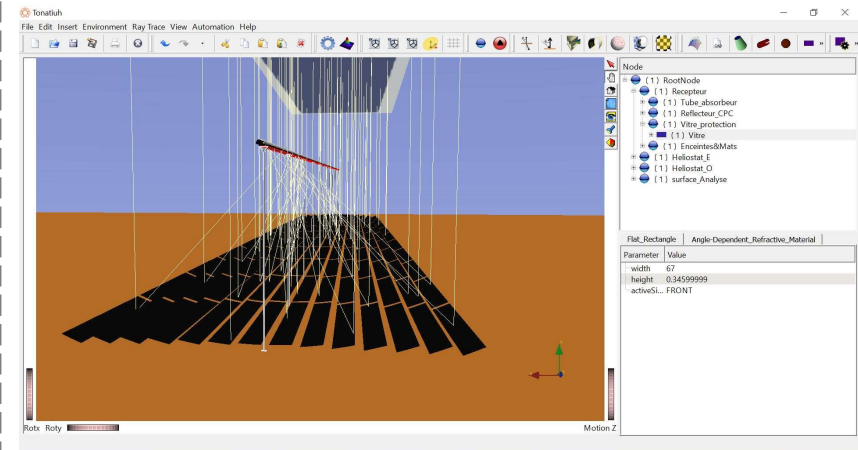

Tonatiuh interface

Main advantages:

- Intuitive interface,
- Active community,
- Automate the modelling of multiple reflectors.

[1] Mertins, M., 2009, "Technische Und Wirtschaftliche Analyse von Horizontalen Fresnel-Kollektoren," p. 127.

[2] Blanco, M., Mutuberria, A., Monreal, A., and Albert, R., 2011, "Results of the Empirical Validation of Tonatiuh at Mini-Pegase CNRS-PROMES Facility.," Proc SolarPACES.



II. Optical characterization of eLLO's module

Simulated longitudinal and transversal IAM of eLLO's module:

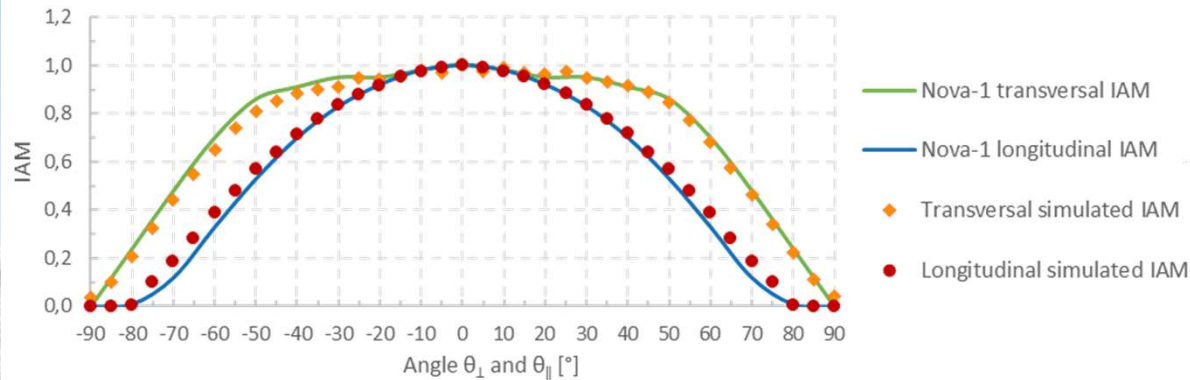

eLLO's simulated IAMs compared to Nova-1 IAMs defined by Frenell (formerly Novatec)

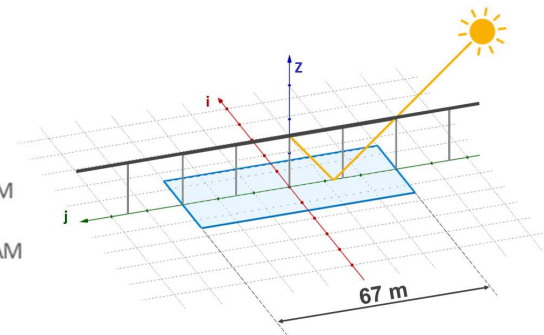

Module with solar receiver of infinite length

Simulated IAM with end-line losses:

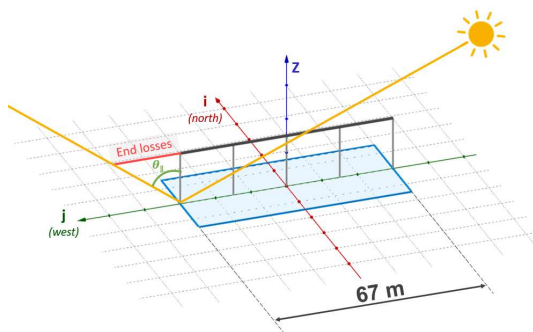

Module with 67 m long solar receiver

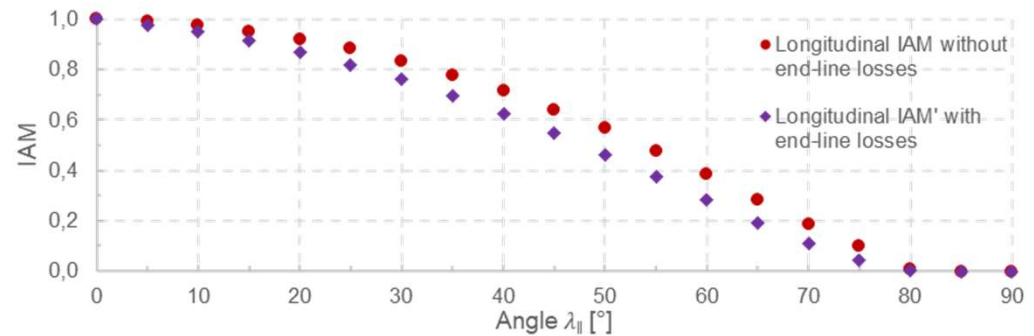

One-side study of simulated longitudinal IAMs with and without end-line losses



III. Influence of LFC arrays topography on their optical performances

Orientation and inclination impact on optical performance:

- 4 solar lines configurations are studied for both solstices and then on an annual basis,
- The sun position is calculated in the reference systems of modules to identify the corresponding IAMs,
- A clear sky model is used.

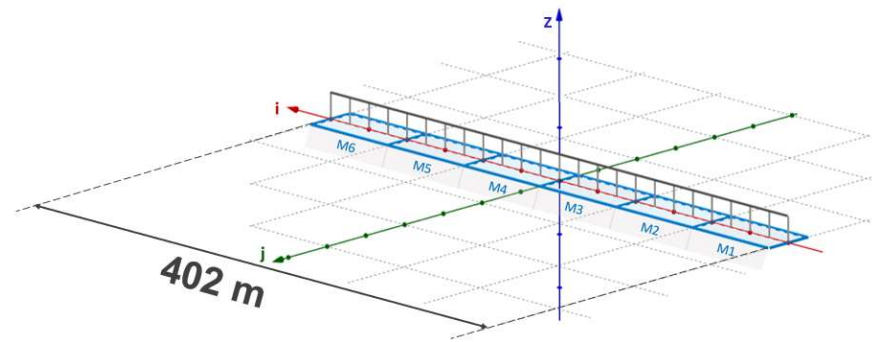

Solar line with 402 m length receiver

NS flat configuration

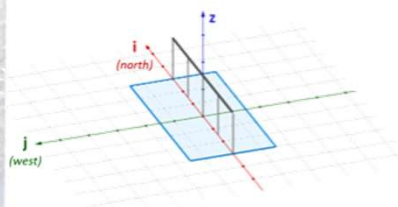

EW flat configuration

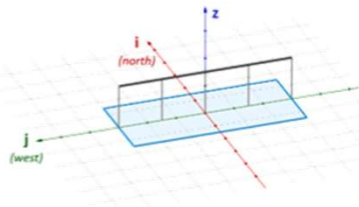

eLLO-like flat configuration

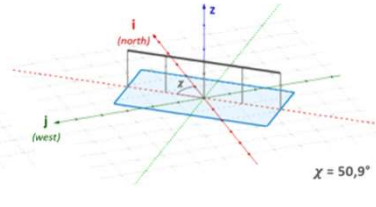

eLLO-like tilted configuration

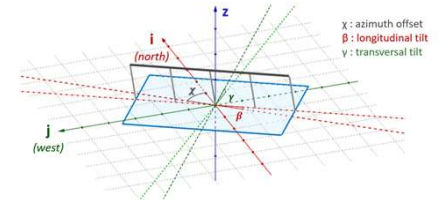

Schematic representation of the NS, EW and eLLO-like flat configuration and eLLO-like tilted configuration





III. Influence of LFC arrays topography on their optical performances

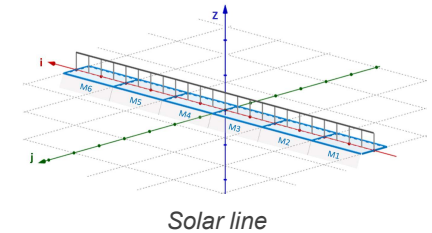

Orientation impact on optical performance: NS / EW / eLLO orientation

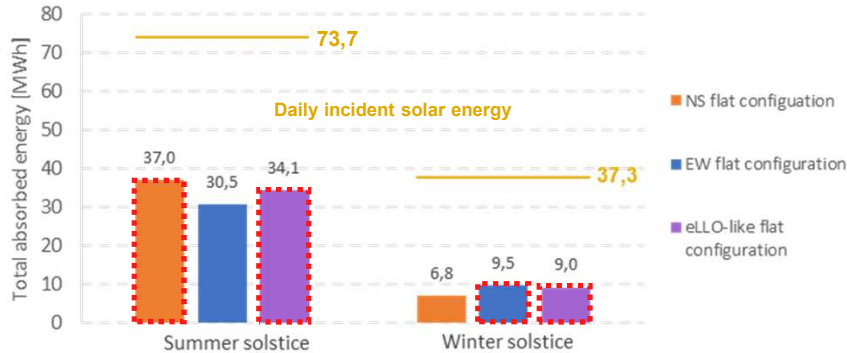

- The optimal configuration:
 - for **summer solstice** is the **NS flat configuration**,
 - for **winter solstice** is the **EW flat configuration**,
- eLLO-like flat configuration** allows to obtain optical performances close to the one of the optimal implementation for the given season.

Daily optical performance for the NS, EW and eLLO-like flat configuration for both solstices

Inclination impact on optical performance: eLLO-like flat and tilted configurations

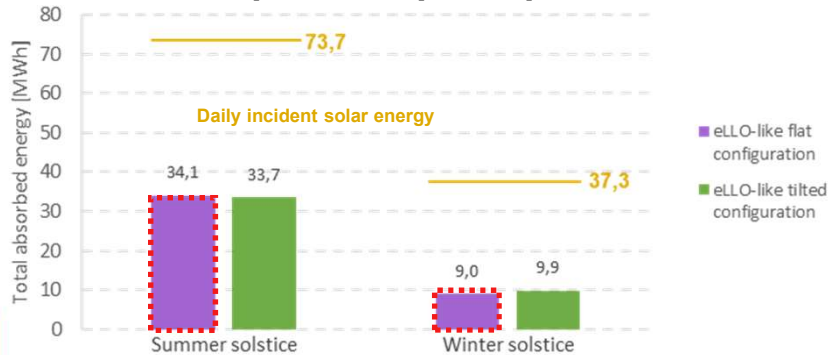

- For winter solstice, **eLLO-like tilted configuration** allows greater solar energy capture than flat configuration.
- And for summer solstice, **eLLO-like tilted configuration** allows slightly lower energy capture than flat configuration.

Daily optical performance for the eLLO-like flat and tilted configuration for both solstices





III. Influence of LFC arrays topography on their optical performances

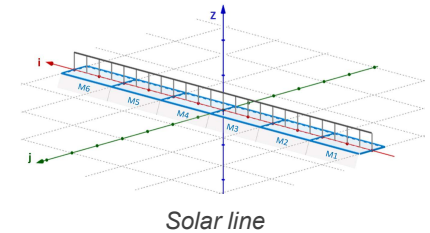

Annual optical study for each configuration:

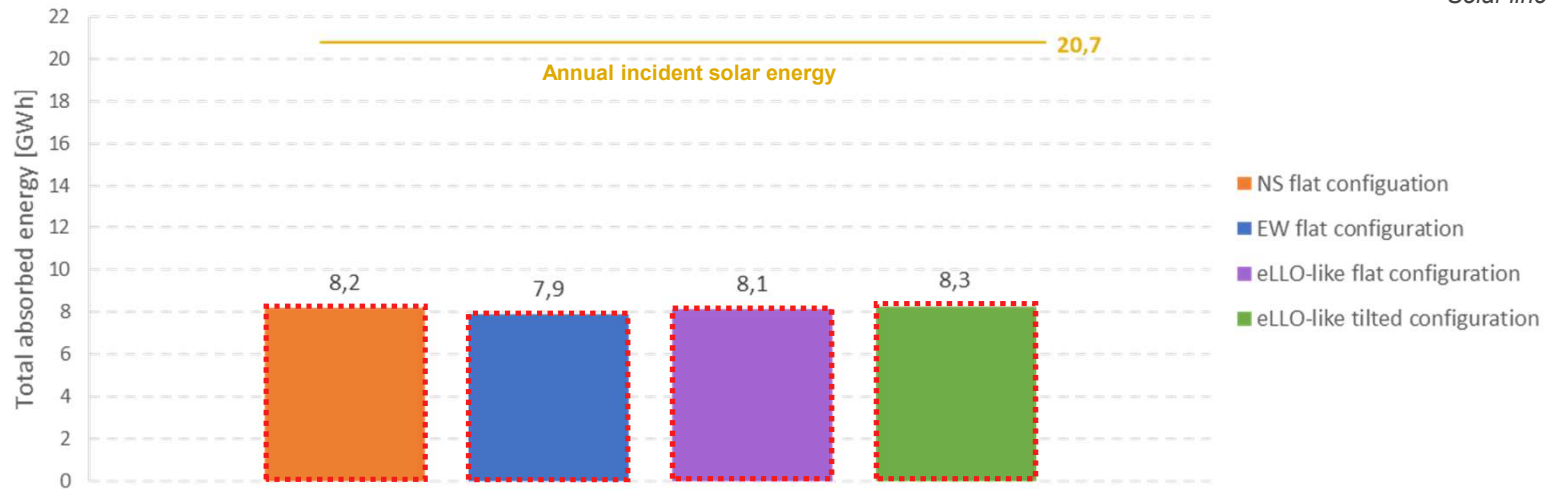

Annual optical performance for the NS, EW and eLLO-like flat configuration and eLLO-like tilted configuration

Table of the annual optical yield for the NS, EW and eLLO-like flat configuration and eLLO-like tilted configuration

	NS flat configuration	EW flat configuration	eLLO-like flat configuration	eLLO-like tilted configuration
Annual optical yield	39.6%	38.2%	39.1%	40.1%

- **NS orientation** is the most efficient flat configuration for the **eLLO solar power plant localization**,
- **eLLO-like tilted configuration** can achieve higher optical efficiency.

III. Influence of LFC arrays topography on their optical performances



Case study: the eLLO solar power plant

- Solar line modeled with the **orientation and tilt** of an eLLO's solar line,
- The sun position is calculated in the **reference systems** of each modules to identify the corresponding IAMs,
- A **clear sky model** is used and a **solar mask** is added.

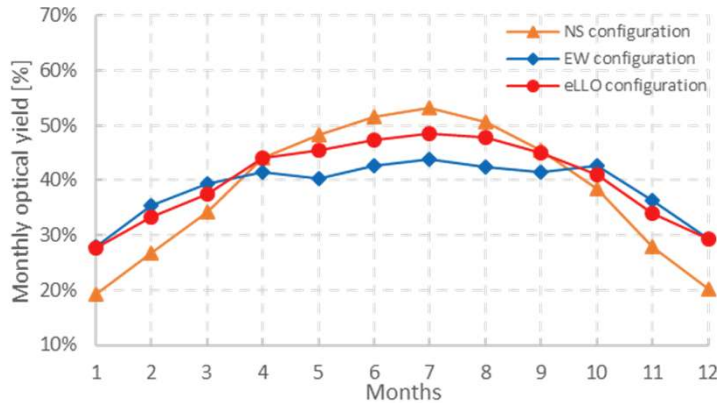
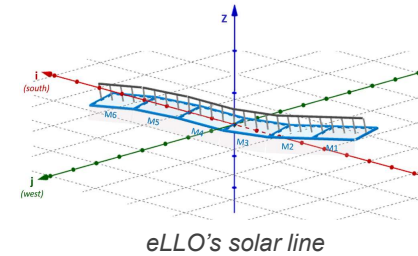

Monthly optical yield for the NS, EW and eLLO configuration

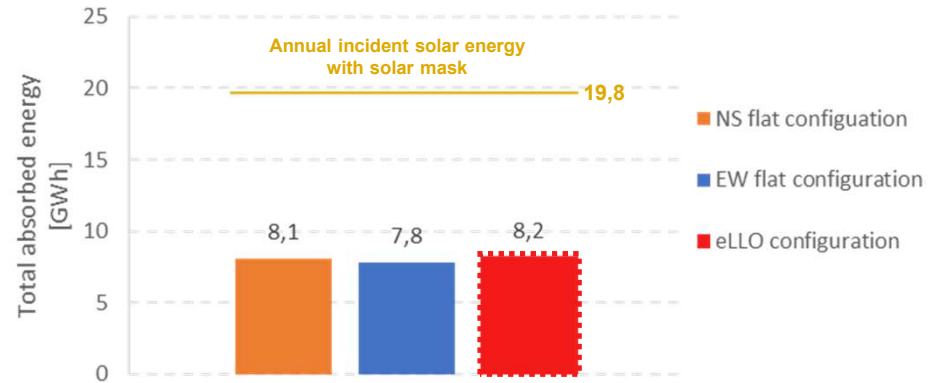

Annual optical performance for the NS, EW and eLLO configuration

Table of annual optical yield for the NS, EW and eLLO configuration

	NS flat configuration	EW flat configuration	eLLO configuration
Annual optical yield with solar mask	40.9%	39.4%	41.4%

Despite the topographical constraints, SUNCNIM has defined a **specific configuration** to achieve optical efficiency close to the efficiency of the **conventional NS implementation**.





Conclusion

- **MCRT models**, together with a **mathematical model** for calculating the solar position in the module reference system, allow **any possible LFC configuration** modules to be studied,
- **eLLO orientation** allows to obtain optical performances close to the efficiency of the optimal implementation for the given season.
- **eLLO-like tilted configuration** can achieve higher optical efficiency than **eLLO-like flat configuration**
- On an annual basis, **NS orientation** is the most efficient orientation for the **eLLO solar power plant localization**,
- **eLLO-like tilted configuration** achieve higher optical efficiency due to modules **inclination toward the south-west**,
- The **specific configuration defined by SUNCNIM** achieve high optical efficiency close to the **NS flat configuration** which was not convenient for the eLLO site topography.

Perspective

Global numerical model of a linear Fresnel solar power plant with direct steam generation and energy storage

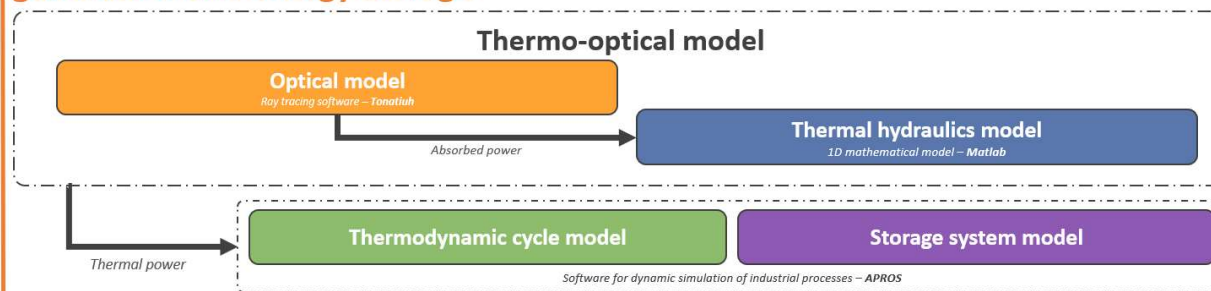

Global model output: Instantaneous plant performance ; Predicting annual electricity production



Thank you for your attention

This work is supported by the programme "Investissements d'Avenir" **Labex Solstice** managed by the National Research Agency under the code ANR-10-LABX-22-01 and by the **National Agency for Technological Research** (CIFRE contract n° 2020/0451)

edouard.montanet@promes.cnrs.fr





Simplified schematic diagram of the eLLO plant

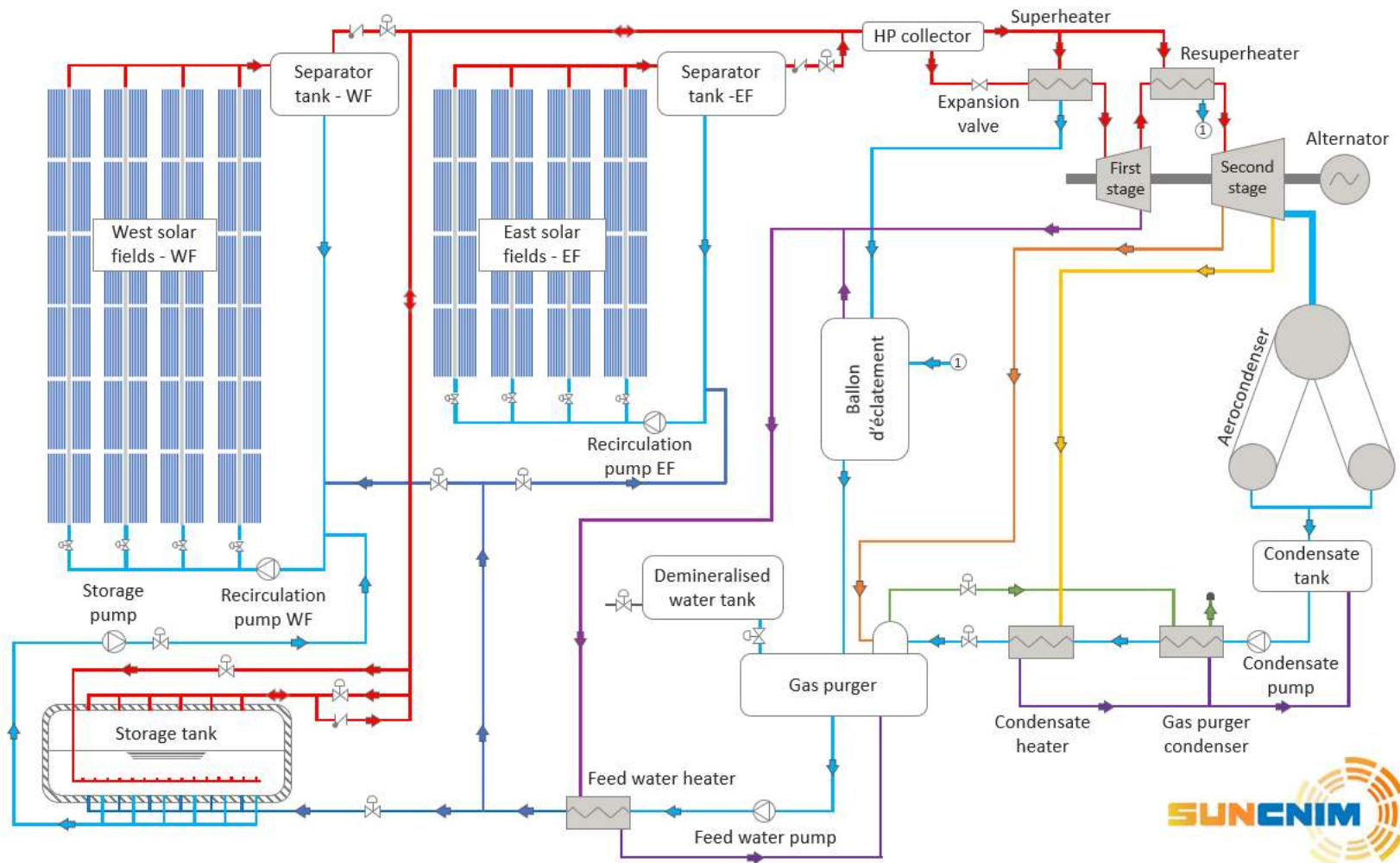

Asymmetrical module impact on optical performance



Focal length of primary reflector:
 1) 9.03 m 2) 9.46 m 3) 10.12 m 4) 10.88 m 5) 11.31 m 6) 12.45 m 7) 15.30 m

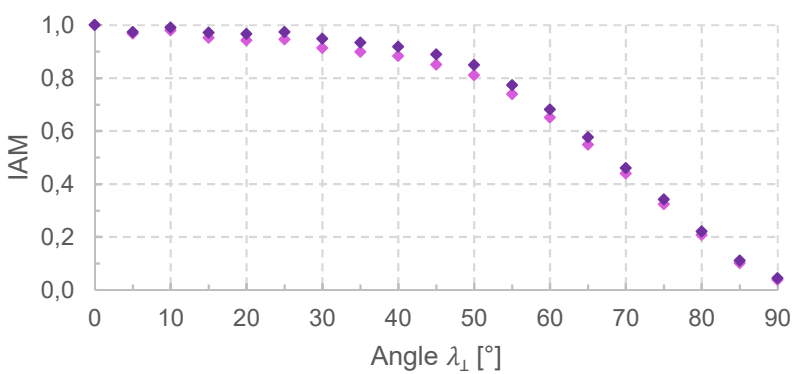
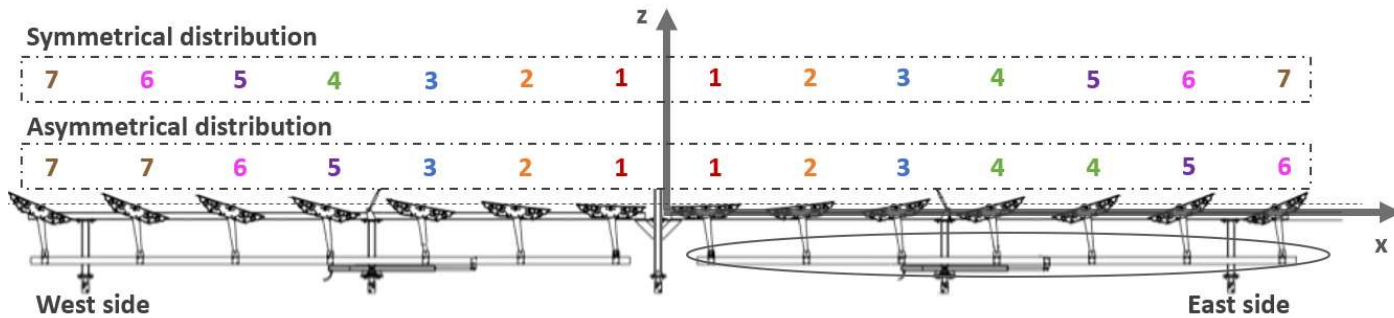

- ◆ Transversal IAM for solar position at the East side of eLLO module
- ◆ Transversal IAM for solar position at the West side of eLLO module

