



**HAL**  
open science

## Whole-genome sequencing as a tool for studying the microevolution of drug-resistant serial *Mycobacterium tuberculosis* isolates

Jaciara de Lourdes Do Carmo Guimarães Diniz, Andrea von Groll, Gisela Unis, Elis Regina Dalla-Costa, Maria Lúcia Rosa Rossetti, Júlia Silveira Vianna, Daniela Fernandes Ramos, Ana Júlia Reis, Priscila Cristina Bartolomeu Halicki, João Luis Rheingantz Scaini, et al.

### ► To cite this version:

Jaciara de Lourdes Do Carmo Guimarães Diniz, Andrea von Groll, Gisela Unis, Elis Regina Dalla-Costa, Maria Lúcia Rosa Rossetti, et al.. Whole-genome sequencing as a tool for studying the microevolution of drug-resistant serial *Mycobacterium tuberculosis* isolates. *Tuberculosis*, 2021, 131, pp.102137. 10.1016/j.tube.2021.102137 . hal-03836718

**HAL Id: hal-03836718**

**<https://hal.science/hal-03836718v1>**

Submitted on 3 Nov 2022

**HAL** is a multi-disciplinary open access archive for the deposit and dissemination of scientific research documents, whether they are published or not. The documents may come from teaching and research institutions in France or abroad, or from public or private research centers.

L'archive ouverte pluridisciplinaire **HAL**, est destinée au dépôt et à la diffusion de documents scientifiques de niveau recherche, publiés ou non, émanant des établissements d'enseignement et de recherche français ou étrangers, des laboratoires publics ou privés.

# Whole-genome sequencing of serial *Mycobacterium tuberculosis* isolates from previously treated patients

\*Jacira Diniz<sup>a</sup>, Andrea von Groll<sup>a</sup>, Gisela Unis<sup>b</sup>, Elis Regina Dalla-Costa<sup>b</sup>, Maria Lúcia Rossetti<sup>b</sup>, Júlia Vianna<sup>a</sup>, Daniela Fernandes Ramos<sup>a</sup>, Ana Júlia Reis<sup>a</sup>, Priscila Halicki<sup>a</sup>, João Luis Rheingantz Scaini<sup>c</sup>, Yasmin Ibrahim Castillos das Neves<sup>a</sup>, Jody Phelan<sup>f</sup>, Ana Rita Gomes<sup>f</sup>, Susana Campino<sup>f</sup>, Karina dos Santos Machado<sup>e</sup>, Adriano V. Werhli<sup>e</sup>, Arnab Pain<sup>g,h</sup>, Taane G. Clark<sup>f</sup>, João Perdigão<sup>i</sup>, Miguel Viveiros<sup>j</sup>, Isabel Portugal<sup>i</sup>, Pedro Eduardo Almeida Silva<sup>a</sup>.

a- Núcleo de Pesquisa em Microbiologia Médica, Faculdade de Medicina, Universidade Federal do Rio Grande, Rio Grande, Rio Grande do Sul, Brazil

b- Hospital Sanatório Partenon, Secretaria Estadual de Saúde do Rio Grande do Sul (HSP SES/RS), Porto Alegre, Rio Grande do Sul, Brazil

c- Centro de Desenvolvimento Científico e Tecnológico, Porto Alegre, Rio Grande do Sul, Brazil

d- Programa de Pós-graduação em Biologia Celular e Molecular, Universidade Luterana do Brasil, Porto Alegre, Brazil

e- Combi-Lab – Grupo de Biologia Computacional, Centro de Ciências Computacionais C3, Universidade Federal do Rio Grande, Rio Grande, Rio Grande do Sul, Brazil

f- London School of Hygiene and Tropical Medicine, Keppel Street, London, WC1E 7HT, United Kingdom

g- Pathogen Genomics Laboratory, BESE Division, King Abdullah University of Science and Technology (KAUST), Thuwal, Saudi Arabia

h- Research Center for Zoonosis Control, Global Institution for Collaborative Research and Education (GI-CoRE), Hokkaido University, Sapporo, Japan

i- Research Institute for Medicines - iMed.Ulisboa, Faculdade de Farmácia, Universidade de Lisboa, Lisboa, Portugal

j- Unidade de Microbiologia Médica, Global Health and Tropical Medicine, GHTM, Instituto de Higiene e Medicina Tropical, IHMT, Universidade Nova de Lisboa, UNL, Lisboa, Portugal

## **ABSTRACT**

Treatment of drug-resistant tuberculosis requires extended use of more toxic and less effective drugs and may result in retreatment cases due to failure, abandonment or disease recurrence. It is therefore important to understand the evolutionary process of drug resistance in *Mycobacterium tuberculosis*. We here describe the microevolution of drug resistance in serial isolates from six previously treated patients. Drug resistance was initially investigated through phenotypic methods, followed by genotypic approaches. The use of whole-genome sequencing allowed the identification of mutations in the *katG*, *rpsL* and *rpoB* genes associated with drug resistance, including the detection of rare mutations in *katG* and mixed populations of strains. Molecular docking simulation studies of the impact of observed mutations on isoniazid binding were also performed. Whole-genome sequencing detected 266 single nucleotide polymorphisms between two isolates obtained from one patient, suggesting a case of exogenous reinfection. In conclusion, sequencing technologies can detect rare mutations related to drug resistance, identify subpopulations of resistant strains, and identify diverse populations of strains due to exogenous reinfection, thus improving tuberculosis control by guiding early implementation of appropriate clinical and therapeutic interventions.

**Keywords:** Catalase assay, Exogenous reinfection, Microevolution, Resistance, Whole genome sequencing.

## 1. INTRODUCTION

Tuberculosis (TB) is the second leading cause of death from infectious disease worldwide. This scenario is aggravated by the increase of TB cases with drug-resistant (DR) strains of *Mycobacterium tuberculosis* [1-3]. Particularly disturbing is the increase of cases with multidrug-resistant (MDR) strains, defined as resistant at least to rifampicin and isoniazid, and extensively resistant strains, which in addition to MDR, are also resistant to a fluoroquinolone and an injectable second-line drug. TB with DR strains requires a prolonged treatment regimen and the use of more expensive, toxic and less effective drugs, which increases the number of cases of retreatment [4].

TB with DR strains is most frequent in previously treated patients, and it is important to know the susceptibility profile of the strains obtained from these patients [5, 6]. Identifying whether retreatment cases are caused by failure, abandonment or even by a new episode of the disease after clinical cure (recurrence) is important for therapeutic success as well TB control in the community [7-11]. Recurrent cases are the result of endogenous reactivation (relapse of primary infection) or exogenous reinfection (infection with a new bacillary load) [4, 12-14].

Several methods have been used to evaluate the genetic diversity of *M. tuberculosis* strains, although for molecular epidemiology proposals Mycobacterial Interspersed Repeating Unit - Variable Number of Tandem (MIRU-VNTR) is a useful tool [15-17]. More recently, whole-genome sequencing (WGS), in addition to identifying the genetic relationships among strains with high accuracy [18-22], is an important tool to recognize the evolution of different populations of microorganisms [23, 24], drug susceptibility and resistance profiles [25-28].

Furthermore, WGS has allowed us to more deeply understand the evolutionary process that involves drug resistance in *M. tuberculosis*, identify single nucleotide polymorphisms (SNPs) related to drug resistance and biological cost mitigation [29-31]. Here, we describe the microevolution of drug resistance of serial isolates of *M. tuberculosis* from patients who previously underwent TB treatment.

## 2. METHODOLOGY

### 2.1 Samples

Thirteen strains of *M. tuberculosis* obtained from six patients who previously underwent TB treatment that showed drug resistance evolution during treatment were studied. These strains were recovered from the strain collection of the Hospital Sanatorio Partenon (HSP), the Center of Reference for Cases of Treatment of TB Resistance in the state of Rio Grande do Sul, located in southern Brazil. TB patients recruited at HSP were sampled at different times during treatment with two or more isolates obtained.

## 2.2 Data collection

Clinical and epidemiological data of the six patients included in this study were obtained from the Department of Phthysiology of HSP. This study was approved by the Research Ethics Committee of the State Foundation for Production and Health Research (no. 04/2012).

## 2.3 Cultivation and extraction of DNA

The strains were cultivated in Ogawa-Kudoh medium and incubated at 37°C for approximately four weeks. After growth, the cultures were used to perform the drug susceptibility test (DST) and extraction of genomic DNA by the cetyl-trimethyl-ammonium bromide-sodium chloride method [32].

## 2.4 Drug susceptibility testing

The DST was initially performed by the proportion method (PM) [33] in the central laboratory of HSP during the treatment of the patients studied before the realization of this study. In this work, DST was performed on first-line anti-TB drugs by a BATEC 320 MGIT (Mycobacteria Growth Indicator Tube) system according to the manufacturer's instructions (Becton, Dickinson and Company-USA). The concentrations used for each antimicrobial tested were 0.1 µg/ml for isoniazid, 1.0 µg/ml for streptomycin and rifampicin, 5.0 µg/ml for ethambutol and 100 µg/ml for pyrazinamide. Replication of these methods was performed to confirm conflicting results detected by WGS.

## 2.5 Catalase assays

We performed two tests in duplicate to evaluate the activity of the catalase enzyme in strains of *M. tuberculosis* (A1 and A2), in which one presented a mutation in a stop codon in the *katG* gene and was susceptible to isoniazid and the second presented a mutation in the same codon and was resistant to isoniazid by phenotypic methods.

### 2.5.1. Catalase test

Colonies of *M. tuberculosis* strains were removed from Ogawa-Kudoh cultures after 7 to 10 days of growth and inoculated in 0.5 mL of phosphate solution (0.041 M Na<sub>2</sub>HPO<sub>4</sub>, 0.02 M KH<sub>2</sub>PO<sub>4</sub> [pH 7.0]). A solution containing equal amounts of 30% hydrogen peroxide and 10% Tween 80 was prepared, and 0.5 mL of this solution was added to a 0.5 mL suspension of mycobacteria. Foam production is indicative of catalase enzyme activity, while its absence demonstrates the loss of enzyme activity [34].

### 2.5.2. Semiquantitative catalase test

For the semiquantitative analysis of catalase enzyme activity, *M. tuberculosis* strains were grown on Ogawa-Kudoh medium cultures in screw-capped tubes for 14 days. One milliliter of a 30% hydrogen peroxide and 10% Tween 80 solution in a 1:1 ratio was added to the surface of growth. After 5 minutes, the height (in millimeters) of the produced column of foam was measured with a ruler, and the results were interpreted. Foam production in excess of 45 mm is considered catalase positive and < 45 mm catalase negative [35].

## 2.6 Genotyping

To study the evolution of drug resistance, all strains were genotyped by the MIRU-VNTR 24 loci method [16], to evaluate whether serial isolates of each patient had the same genotypic profile. Alterations in the MIRU-VNTR profile in two or more *loci* were considered different clonal populations [14,36].

## 2.7 Whole-genome sequencing

The genomic DNA extracted from each strain of *M. tuberculosis* was sequenced using the Illumina HiSeq 2500 (paired-end 100-150 bp reads) platform, according to the manufacturer's instructions (Illumina, San Diego, CA, USA).

## 2.8 Bioinformatics analysis of whole-genome sequencing

The raw reads obtained through WGS were submitted to the Trimmomatic program to remove low-quality bases and assure the robustness of the analysis effectuated and as quality control of the sequences obtained [37]. The sequence data were mapped with the reference genome of *M. tuberculosis* H37Rv (GenBank, Ref. NC000962.3) using the Burrows-Wheeler Aligner program. The average reading coverage was approximately 99% of the whole reference genome, and the mean depth ranged from 2.7x to 671.2x (median: 283.7x) [38].

The allele variants, SNPs and insertions/deletions (INDELs) were identified through the SAMTools and Genome Analysis Toolkit programs based on the mapping performed [39, 40]. We analyzed genes and their promoter regions that are known to be associated with resistance to anti-TB drugs and compensatory mutations by the presence of SNPs and their percentages in all mapped reads. In this study, we assumed that cases were exogenous reinfections when there was a difference of >10 SNPs, but reinfections with the same clonal strain cannot be excluded [41].

## 2.9 In silico spoligotyping

Spoligotypes were generated in silico using SpolPred software [42]. Lineages (CLADE) and Spoligotype International Type (SITs) were classified according to the online SITVIT WEB database

[43]. Changes in the profile of spoligotyping were considered to identify different clonal populations [14, 36].

### 2.10 Definitions

First-line anti-TB drugs: ethambutol, isoniazid, pyrazinamide, rifampicin and streptomycin.

Retreatment cases: patients who have already been treated for TB for 30 days or more. There are three types of retreatment cases: (1) a patient previously treated for TB and their most recent course of treatment failed (treatment after failure); (2) a patient previously treated for TB who returns to treatment having previously defaulted (treatment after abandonment); and (3) a patient who was previously declared cured or treatment completed and is diagnosed with bacteriologically positive (sputum smear or culture) TB (relapse) [4].

Treatment cure: Patients who presented two bacilloscopy negatives during treatment. In the absence of expectoration, the cure is based on clinical data and complementary tests [44].

### 2.11 Molecular docking simulations

To study the effect of the identified mutations on *katG* protein structure (A1 and A2 strains) and to evaluate how these mutations can impact the molecular interactions with isoniazid, we generated models for these protein structures and performed molecular docking simulations. For this, we needed the protein and ligand structures. The isoniazid (INH, ligand) structure was obtained from PubChem with CID 3767. The three protein structures of *katG*: wild type (wt), A1 D375 stop codon (D375X) and A2 (D735Y), were modeled by Phyre 2 [45]. The *katG* wt is available in the Protein Data Bank (PDB ID: 1SJ2); however, this structure has missing residues (1-23) and was included in the modeling step. To validate our models, the software Verify3D [46] and Procheck [47] were used. Procheck is a suite of programs to check the stereochemical quality of protein structures by analyzing overall and residue-by-residue geometry. Verify3D measures the compatibility of a protein model with its own amino acid sequence and according to this evaluation; a good model has at least 80% of the amino acids with scores  $\geq 0.2$  in the 3D/1D profile.

After obtaining the structures, we prepared them for docking using Auto Dock Tools [48]. We decided to perform docking simulations with and without HEM as part of the receptor structures. Thus, to prepare these for docking, we used VMD [49] to superpose the protein models with PDB ID 1SJ2 to pose the HEM on these structures.

The molecular docking simulations were performed with Vina [50] considering a grid box defined with size of  $x=36 \text{ \AA}$ ,  $y=24 \text{ \AA}$  and  $z=40 \text{ \AA}$ , center in  $x= 74.067$ ,  $y=38.579$  and  $z=41.149$  and exhaustiveness equal to 256. VMD and Discovery Studio [51] were used to analyze the results and generate the figures.

### 3. RESULTS

Because the study evaluated the microevolution of serial isolates obtained from each patient, the results are presented individually, with each patient identified by a letter. The clinical data of these patients were collected from medical records and are presented in Table 1.

#### 3.1 Patient A

The first episode of TB in patient A occurred in 2010/03, when the treatment regimen with first-line antimicrobials: rifampicin, isoniazid and pyrazinamide (RHZ) was started. In the fifth month, the patient abandoned the treatment. Three months (2010/11) after the first episode, the patient returned to the health service, when the first strain (A1) was isolated and characterized as susceptible to first-line anti-TB drugs. It is not known if the patient began treatment at this moment, but after five months (2011/04), the patient returned to the health service with clinical signs of TB. At this time, a second strain (A2) was isolated (2011/04), which showed resistance to isoniazid by proportion and MGIT methods; treatment with RHZ was reintroduced and optimized by the addition of ethambutol. However, after five months, treatment failure was identified, with recurrence of symptoms and positive microscopy for acid-fast bacilli. For this reason, in 2011/10, a new therapeutic regimen was introduced with streptomycin, ethambutol, levofloxacin, terizidone and pyrazinamide (SELTZ) [44]. The treatment was successfully completed after 18 months with clinical cure (Figure 1).

The spoligotyping data were identical for both isolates, A1 and A2 (Table 2), in addition, MIRU-VNTR had variation in a single locus, and WGS presented a difference of 4 SNPs/year (Table 3). These genotypic data allowed us to infer that both episodes of disease were caused by the same strain [19, 52-56].

The WGS data analysis detected two mutations in *katG* in a codon already described as associated with resistance to isoniazid [57-63]. Interestingly, the first isolate was phenotypically susceptible and presented a stop codon (D735X) in 100% of the population. In the second isolate (A2), the D735Y mutation was identified in 41% of the population and was phenotypically resistant to isoniazid (Table 4). In addition, G594E *rpoC* was identified in both A1 and A2, and a mutation in the *ahpC* promotor region (C-54T) was found only in A2 (Table 4) [64-67].

Considering the difference in the susceptibility profiles of both strains, with a variation in the same codon in relation to H37Rv, we more deeply investigated these differences. Table 5 presents the results concerning new tests performed with a new culture of both strains. The MIC confirmed the susceptibility profile determined previously by PM. Using the Sanger method, mutations in *katG* were confirmed with the stop codon in the susceptible strain and tyrosine in the resistant strain. In relation to the catalase test, A2 did not present catalase activity. This same strain presented a mutation in the *ahpC* promoter region (C-54T).



We also performed molecular docking simulations to investigate the differences between *katG* wt, A1 (D735X) and A2 (D735Y) mutation interactions with isoniazid. First, we generated protein structure models for *katG* wt, A1 (D735X) and A2 (D735Y) using Phyre2 [45]. We evaluated the obtained models using the Verify3D averaged 3D-1D score, where *katG* wt has 94.59% of its residues  $\geq 0.2$ , D735X has 92.10% of its residues  $\geq 0.2$  and D735Y has 91.22% of the residues  $\geq 0.2$  [46]. According to Procheck evaluation (Ramachandran plots), *katG* wt has 89.6% residues in most favorable regions, 9.2% in additional favorable regions, 0.7% generously favorable regions and only 0.7% disallowed regions; *katG* D735X presented 89.6% residues in most favorable regions, 9.1% in additional favorable regions, 0.8% generously favorable regions and only 0.5% disallowed regions; and *katG* D735Y Ramachandran plots showed 89.8% residues in most favorable regions, 9.0% in additional favorable regions, 1.0% generously favorable regions and only 0.2% disallowed regions [45, 46].

Thus, based on the evaluation results, we can consider the proposed models for *katG* wt, A1 (D735X) and A2 (D735Y) to be good for docking simulations. We performed docking simulations with Vina [50] considering the three protein models with HEM as part of their structures (with HEM) and not (without HEM) and INH as ligand. Table 6 presents the docking results: columns 2 and 4 describe the best free energy of binding (FEB) scored predicted by Vina (in kcal/mol), and columns 3 and 5 describe the protein residues interacting with INH (predicted by Discovery Studio [51]). Regarding FEB, we can observe that all of the scores are similar and varied from -6.4 to -7.0 kcal/mol.

Figure 2 shows the best docked positions for INH – *katG* models, with HEM (A, C, E) and without HEM (B, D, F). In terms of the final docked INH position, for *katG* wt with and without HEM (Figure 2 A and B), the best position is close to amino acid 735 highlighted in yellow, a different region observed for both A1 (D735X) (Figure 2 C and D) and A2 (D735Y) (Figure 2 E and F). Although A1 (D735X) and A2 (D735Y) interact with INH at another site, there are no key differences between them even though we observe variations in their susceptibility profiles. The results for simulations without HEM (Table 6, Figure 2 D and F) showed that both mutations interacted with the amino acids ASP93, ASP94, HIS97, LEU101, GLY273 and LYS274. However, considering the docking results with HEM, we can observe that A2 D735Y TRP 107 shares a hydrogen bond with INH and is not present in A1 D735X-INH.

### 3.2 Patient B

The first episode of TB in patient B occurred in 2005/03, when the first-line treatment regimen with RHZ was started. In the ninth month, treatment failure was detected with positive bacilloscopy. A new therapeutic regimen was then introduced with streptomycin, ethambutol, ethionamide and pyrazinamide (SEEtZ). However, the patient abandoned this treatment four months later. In 2006/09,

he returned to the health service with clinical signs of TB, when the first strain (B1) was isolated and characterized as susceptible to first-line anti-TB drugs by both phenotypic methods. Therefore, the previous SEEtZ treatment was reintroduced but proved to be ineffective eight months later, with bacilloscopy positivity detected. In 2007/06, treatment was optimized by the addition of rifampicin and isoniazid (RHSEEtZ). At this time, a second strain (B2) was isolated, which showed susceptibility to first-line anti-TB drugs by PM. However, in this study, resistance to streptomycin was detected by the MGIT method. As PM did not detect, streptomycin resistance in strain B2, the therapeutic regimen with RHSEEtZ was continued. After 12 months, treatment failure was diagnosed with positive bacilloscopy. In 2008/07, a third strain (B3) was isolated that was resistant to streptomycin and was now also detected by PM. A new therapeutic regimen was introduced with amikacin, ethambutol, ofloxacin, terizidone and pyrazinamide (AEOTZ). The treatment was successfully completed after 18 months, achieving a clinical cure (Figure 3).

The MIRU-VNTR and spoligotyping data were identical for the three isolates (Table 2), in addition the WGS presented a difference of 2.7 SNPs/year between B2 and B3 (Table 3). These genotypic data allowed us to infer that all episodes of disease were caused by the same strain [19, 52-56].

The WGS data analysis detected a K43R mutation in the *rpsL* gene related to streptomycin resistance [68-74]. Interestingly, this mutation was identified in 29% of the population of B1 and B2 strains, while 100% of the population of B3 presented the same mutation (Table 4).

### 3.3 Patient C

The first episode of TB of patient C occurred in 2009/05, when the regimen with RHZ was started. After the sixth month, treatment failure was diagnosed with positive bacilloscopy. This patient only returned to the health service in 2010/06, presenting clinical signs of TB, and treatment with RHZ was reintroduced and optimized by the addition of ethambutol. In 2010/09, the first strain (C1) was isolated, and PM was identified as susceptible to all first-line drugs, however resistance to isoniazid was detected by MGIT. As isoniazid resistance was not detected at the time of isolation, the therapeutic regimen with RHZE was maintained. After five months treatment failure was detected. In 2011/03, a second strain (C2) was isolated, which was resistant to isoniazid by proportion and MGIT methods. A new therapeutic regimen was then introduced with SELTZ, resulting in clinical cure after 18 months (Figure 4).

The MIRU-VNTR and spoligotyping data were identical for both isolates, C1 and C2 (Table 2), and there was no difference in the numbers of SNPs/year among isolates (Table 3). These genotypic data allowed us to infer that both episodes of disease were caused by the same strain [19, 52-56].

The WGS data analysis detected a Y337C mutation in the *katG* gene, described as associated with resistance to isoniazid [35, 60, 75]. This mutation was identified in both strains phenotypically resistant to isoniazid (C1 and C2) in 99% and 100% of the population, respectively (Table 4).

### 3.4 Patient D

The first episode of TB of patient D occurred in 2008/05, when the first-line treatment regimen with RHZ was started; however, a month later, the patient abandoned the treatment. After two months (2008/08), the patient returned to the health service, where treatment with RHZ was reintroduced; however, a month later, the patient abandoned treatment again. In 2008/11, the patient returned to health service with clinical signs of TB, when the first strain (D1) was isolated and showed susceptibility to all first-line anti-TB drugs. At this time, the treatment with RHZ was reintroduced, but in the second month, the patient was missing. In 2009/09, this patient returned, still presenting clinical signs of TB, and was treated with RHZ, but after three months (2009/12), the patient abandoned the treatment again. The patient was missing until 2010/05, at this time, when he returned to the health service. At this time, a new strain (D2) was isolated, a new therapeutic regimen was introduced with SEEtZ, and the D2 strain was phenotypically identified as isoniazid resistant. The treatment was successfully completed after 18 months with clinical cure (Figure 5).

The MIRU-VNTR data were identical for both isolates, D1 and D2, but the spoligotyping profile was different in the second strain (Table 2). The WGS data also showed a large difference in the number of SNPs (204.6 SNPs/year) between the D1 and D2 strains (Table 3). These genotypic data allowed us to infer that the episodes of disease may have been caused by two genetically distinct strains [14, 36, 41, 52, 76-78].

The WGS data analysis detected a N138H mutation in the *katG* gene, described as associated with resistance to isoniazid [60, 79-81]. This mutation was identified in 100% of the population of the strain phenotypically resistant to isoniazid (D2) (Table 4). In addition, G594E *rpoC* was identified in both D1 and D2 (Table 4) [64-67].

### 3.5 Patient E

The first episode of TB of patient E occurred in 2005/06, when the first-line treatment regimen with RHZ was started. However, this patient developed hepatic side effects, and a new therapeutic regimen was introduced with streptomycin, ofloxacin and ethambutol (SOE) [44]. This treatment was successfully completed after 12 months with clinical cure. In 2007/12, he returned to the health service and was diagnosed with a new case of TB, where a new therapeutic regimen was introduced with streptomycin, isoniazid and ethambutol (SHE). During the eighth month, treatment failure was diagnosed with positive bacilloscopy. This patient was missing and returned in 2009/09; at this time,

a new therapeutic regimen was introduced with streptomycin, rifampicin and pyrazinamide (SRZ). After twelve months (2010/09), this treatment proved to be ineffective when a first strain (E1) was isolated and showed resistance to isoniazid. In 2011/01, a new therapeutic regimen was introduced with amikacin, levofloxacin, terizidone, ethambutol, ethionamide and pyrazinamide (ALTEEtZ). Due to the persistence of clinical signs of TB after three months, a second strain (E2) was isolated, and additional resistance to rifampicin was detected. Treatment with ALTEEtZ was maintained for nine months, resulting in a clinical cure (Figure 6).

The MIRU-VNTR and spoligotyping data were identical for both isolates, E1 and E2 (Table 2), in addition the WGS presented a difference of 3.3 SNPs/year (Table 3). These genotypic data allowed us to infer that both episodes of disease were caused by the same strain [19, 52-56].

The WGS data analysis detected the mutations N138H in the *katG* gene and H445D in the *rpoB* gene, described as associated with resistance to isoniazid and rifampicin, respectively [60, 79-87]. The N138H mutation was identified in 100% of the population of the strains phenotypically resistant to isoniazid (E1 and E2). Only the E2 strain presented the H445D mutation in 99% of the strain population phenotypically resistant to rifampicin. In addition, the G594E mutation was also identified in the *rpoC* gene (Table 4) [64-67].

### 3.6 Patient F

The first episode of TB in patient F occurred in 2006/01, when the first-line treatment regimen with RHZ was started. The treatment was successfully completed after six months, with clinical cure. In 2009/04, the patient returned to the health service with clinical signs of TB, when the first strain (F1) was isolated and was susceptible to first-line anti-TB drugs. At this time, treatment with RHZ was reintroduced but proved to be ineffective six months later, with recurrence of bacilloscopy positivity. In 2009/11, a new therapeutic regimen was introduced with SEEtZ. After eight months, treatment failure was diagnosed with positive bacilloscopy. A second strain (F2) was then isolated (2011/08) and showed resistance to isoniazid, and a new therapeutic regimen was introduced with AEOTZ. The treatment was successfully completed after 18 months with clinical cure (Figure 7).

The MIRU-VNTR and spoligotyping data were identical for both isolates, F1 and F2 (Table 2), in addition the WGS presented a difference of 3.6 SNPs/year (Table 3). These genotypic data allowed us to infer that all episodes of disease were caused by the same strain [19, 52-56].

The WGS data analysis detected a S315T mutation in the *katG* gene, described as associated with resistance to isoniazid [88-99]. This mutation was identified in 100% of the population of the strain phenotypically resistant to isoniazid (F2) (Table 4).

## 4. DISCUSSION

Here, by molecular and phenotypic approaches, we studied *M. tuberculosis* strains obtained from six patients with different histories of TB retreatment, including cases of abandonment and therapeutic failure and relapse. Previously TB treatment was a major risk factor for DR TB, and resistant strain subpopulations were selected by exposure to drugs through ineffective therapeutic regimens [100-103].

DST by phenotypic methods has the advantage of detecting drug resistance independent of the associated molecular basis. However, they are laborious and can present late results. In this study, we used the BATEC 320 MGIT system, while PM was routinely used. Some discrepancies between these methods were observed, and the resistances (C1 for isoniazid, B1 and B2 for streptomycin) were undetectable by PM. Although PM is low-cost, its accuracy in detecting drug resistance is lower than that of other phenotypic methods, such as MGIT or Resazurin microtiter assays, as well as molecular methods [104-107].

In this study, WGS allowed the identification of mutations in the *katG*, *rpsL* and *rpoB* genes, associated with resistance to isoniazid, streptomycin and rifampicin, respectively [58, 72, 81, 86, 87, 90, 94]. Furthermore, we identified DR subpopulations that can be imperceptible by phenotypic methods. Streptomycin resistance was identified in 29% of the population of B1 and B2 strains; however, this resistance was undetectable by phenotypic methods. This may be related to mutations that confer a low level of drug resistance (border line), the presence of more than one strain in the same clinical sample [106, 108, 109], or that the population of strains extracted from the crop and that was used in the STD may not represent the total population [25, 110]. Black et al. (2015) showed that the selection of only one to three single colonies for each patient isolate would have limited the analysis of the true heterogeneity in the total population and resulted in the loss of variants representing susceptible colonies.

S315T (*katG* gene), the most common mutation reported to be associated with resistance to isoniazid [88-99], was detected in the F2 strain. In addition, rare mutations in the *katG* gene associated with resistance were also identified at codons D735Y, Y337C and N138H in different strains. Although the introduction of a line probe assay in routine diagnosis for detecting isoniazid-resistant *M. tuberculosis* is useful to control TB cases, it should be considered that these commercial platforms do not detect rare mutations, and thus WGS and/or phenotypic methods should be part of the investigation of DR TB [35, 57-63, 75, 79-81, 112].

Furthermore, in relation to the position at codon 735 in the *katG* gene, in A1, there was an amino acid variation of D to a stop codon, but the strain continued to be susceptible to INH. However, in A2, a part of the population (41%) presented a mutation at position 2153907 in relation to A1, and the strain became resistant. Previous studies have reported that mutations at this codon (735) occur in the C-terminal domain of the *katG* gene, a site that is required for catalase activity. Thus, in general,

mutations in the *katG* gene at this position are associated with a reduction in catalase enzyme activity [57, 60, 61, 63]. In this way, we evaluated the activity of the catalase enzyme in strains A1 and A2, and the results showed a loss of enzymatic activity in strain A2. This fact can explain the presence of a mutation in the promotor region of the *ahpC* gene in strain A2, which is considered a compensatory mutation to hyperexpression of *ahpC*, an alkyl peroxidase that also protects bacilli against the toxic effects of organic peroxides. All these results were confirmed in a new culture of both strains from the stock tube, with new genomic DNA extraction, *ahpC* promoter and *katG* gene sequencing, minimal inhibitory concentration determination and catalase activity evaluation [57, 60, 61, 63, 88, 90].

Analyzing the docking results, we observed that the mutants A1 (D735X) and A2 (D735Y) and *katG* wt presented different results in terms of the best INH docking region scored, showing the impact of the mutations in *katG*-INH interactions (Table 6 and Figure 2). In addition, when we compared A1 (D735X) with HEM (Figure 2C) and A2 (D735Y) with HEM (Figure 2E) interactions, we noticed a hydrogen bond between TRP107 in A2 (D735Y) and INH that was not present in A1 D735X-INH. According to Mo et al., this amino acid is an important residue of the Met255-Tyr229-Trp107 triad conserved in many catalase peroxidases next to HEM, and TRP 107 plays a crucial role in compound reductions mediated by H<sub>2</sub>O<sub>2</sub> [113,114]; thus, this difference can explain, at least in part, the differences observed in the susceptibility tests.

It is important to mention that we could not observe more differences between *katG* mutants because we performed protein docking simulations with rigid receptors; thus, the impact of mutations on protein flexibility was not properly considered. In future work, we will perform molecular dynamics simulations to evaluate the impact of these mutations on receptor structures and flexibility [113,114].

The E2 strain, the unique MDR strain of this study, was rifampicin resistant with a mutation in the 81 bp RRDR of the *rpoB* gene (H445D) [81-86, 115]. Its previous strain (E1) only had the mutation N138H in the *katG* gene, which, although rare, had already been described as being related to isoniazid resistance [60, 79-81]. Resistance to isoniazid generally arises before rifampicin resistance, and its early detection could help control MDR tuberculosis.

Mutations in the *rpoC* gene have been proposed to be compensatory mutations by rifampin resistance-conferring mutations in the *rpoB* gene. However, in this study, we found the mutation G594E in the *rpoC* gene in strains isolated from patients with resistance (E) and susceptibility to rifampicin (A and D). This mutation was previously described as a marker specific for the Haarlem lineage [64] and not associated with rifampicin resistance because it is also present in isolates susceptible and resistant to rifampicin [65-67].

According to the data obtained by WGS and SpolPred, patient D presented TB with two genetically distinct strains during the period evaluated. Genetic variation was determined by WGS, and 266 SNPs between D1 and D2 were identified, indicating the occurrence of exogenous reinfection [14, 36, 41, 52, 76-78]. Interestingly, 24 *loci* MIRU-VNTR that present discriminatory power higher than spoligotyping did not differentiate D1 and D2 strains. However, the spoligotype profiles presented by the SpolPred tool showed the absence of a single spacer, and this fact could be a systematic tool error, as already reported in previous studies [36, 42, 78].

Patient D was a prisoner during treatment, a site of overpopulation and high TB burden, which can facilitate infection with more than one strain of *M. tuberculosis*. In addition, the patient was a user of crack cocaine, which can predispose to immunosuppression [14, 78, 116-119].

In conclusion, sequencing technologies can improve TB control by detecting rare and new mutations related to detection of drug resistance, as well as identifying subpopulations of DR strains allowing early clinical and therapeutic intervention. In addition, WGS can unequivocally identify diverse populations of strains, allowing the detection of exogenous reinfection cases, which is particularly important due to the high burden of TB and drug resistance [24, 76, 120].

## References

- [1] WHO. Global Tuberculosis Report 2016. World Health Organization, 2016.
- [2] Perdigão J, Portugal I. Genetics and roadblocks of drug resistant tuberculosis. *Infect Genet Evol.* 2019 Aug; 72:113-30.
- [3] Tacconelli E, Carrara E, Savoldi A, Harbarth S, Mendelson M, Monnet DL. et al. Discovery, research, and development of new antibiotics: the WHO priority list of antibiotic-resistant bacteria and tuberculosis. *Lancet Infect Dis.* 2018 Mar; 18(3): 318-27.
- [4] WHO. Definitions and reporting framework for tuberculosis – 2013 revision. Document WHO/HTM/TB/2013.2. World Health Organization, 2013.
- [5] Rifat M, Hall J, Oldmeadow C, Husain A, Hinderaker SG, Milton AH. Factors related to previous tuberculosis treatment of patients with multidrug-resistant tuberculosis in Bangladesh. *BMJ Open.* 2015 Sep; 5(9): e008273.
- [6] Desissa F, Workineh T, Beyene T. Risk factors for the occurrence of multidrug-resistant tuberculosis among patients undergoing multidrug-resistant tuberculosis treatment in East Shoa, Ethiopia. *BMC Public Health.* 2018 Apr; 18(1): 422.
- [7] Köser Cu, Bryant Jm, Becq J, Török Me, Ellington Mj, Marti-Renom Ma. et al. Whole-genome sequencing for rapid susceptibility testing of *M. tuberculosis*. *N Engl J Med.* 2013 Jul; 369(3): 290-2.
- [8] Brown AC, Bryant JM, Einer-Jensen K, Holdstock J, Houniet DT, Chan JZ. et al. Rapid whole-genome sequencing of *Mycobacterium tuberculosis* isolates directly from clinical samples. *J Clin Microbiol.* 2015 Jul 53(7): 2230-7.
- [9] Smith SE, Ershova J, Vlasova N, Nikishova E, Tarasova I, Eliseev P. et al. Risk Factors for Acquisition of Drug Resistance during Multidrug-Resistant Tuberculosis Treatment, Arkhangelsk Oblast, Russia, 2005–2010. *Emerg Infect Dis.* 2015 Jun; 21(6): 1002-11.
- [10] Varma-Basil M, Nair D. Molecular epidemiology of tuberculosis: Opportunities & challenges in disease control. *Indian J Med Res.* 2017 Jul; 146(1): 11-14.
- [11] Nimmo C, Shaw LP, Doyle R, Williams R, Brien K, Burgess C, Breuer J. et al. Whole genome sequencing *Mycobacterium tuberculosis* directly from sputum identifies more genetic diversity than sequencing from culture. *BMC Genomics* 2019 May; 20(1): 389.



- [12] Lambert ML, Hasker E, Van deun A, Roberfroid D, Boelaert M, Van der Stuyft P. Recurrence in tuberculosis: relapse or reinfection? *Lancet Infect Dis*. 2003 May; 3(5): 282-7.
- [13] Pandolfi JR, Malaspina AC, Santos ACB, Suffys PN, Oellemann MAC, Valentini SR. et al. Tuberculose e o estudo molecular da sua epidemiologia. *Rev Ciênc Farm Básica Apl*. 2007; 28(3): 251-7.
- [14] Guerra-Assunção JA, Houben RM, Crampin AC, Mzembe T, Mallard K, Coll F. et al. Recurrence due to Relapse or Reinfection With *Mycobacterium tuberculosis*: A Whole-Genome Sequencing Approach in a Large, Population-Based Cohort With a High HIV Infection Prevalence and Active Follow-up. *J Infect Dis*. 2015 Apr; 211(7): 1154-63.
- [15] Kamerbeek J, Schouls L, Kolk A, Van Agterveld M, Van Soolingen D, Kuijper S. Simultaneous detection and strain differentiation of *Mycobacterium tuberculosis* for diagnosis and epidemiology. *J Clin Microbiol*. 1997 Apr; 35(4): 907-14.
- [16] Supply P, Allix C, Lesjean S, Cardoso-Oelemann M, Rüsch-Gerdes S, Willery E. et al. Proposal for standardization of optimized mycobacterial interspersed repetitive unit-variable-number tandem repeat typing of *Mycobacterium tuberculosis*. *J Clin Microbiol*. 2006 Dec; 44(12): 4498-510.
- [17] Oudghiri A, Chaoui I, Elmezibri M. Molecular Epidemiology of Tuberculosis: A review of Tolls and Applications. *J Infect Dis Ther*. 2018 Oct; 6(6):386.
- [18] Schurch AC, Van Soolingen D. DNA fingerprinting of *Mycobacterium tuberculosis*: from phage typing to whole-genome sequencing. *Infect Genet Evol*. 2012 Jun; 12(4): 602-9.
- [19] Walker TM, Ip CL, Harrell RH, Evans JT, Kapatai G, Dedicoat MJ. et al. Whole-genome sequencing to delineate *Mycobacterium tuberculosis* outbreaks: a retrospective observational study. *Lancet Infect Dis*. 2013 Feb; 13(2): 137-46.
- [20] Iketleng T, Lessells R, Dlamini MT, Mogashoa T, Mupfumi L, Moyo S. et al. *Mycobacterium tuberculosis* Next-Generation Whole Genome Sequencing: Opportunities and Challenges. *Tuberc Res Treat*. 2018 Dec: 1298542.
- [21] Jajou R, de Neeling A, van Hunen R, de Vries G, Schimmel H, Mulder A. et al. Epidemiological links between tuberculosis cases identified twice as efficiently by whole genome sequencing than conventional molecular typing: A population-based study. *PLoS One*. 2018 May; 13(5): e0197556.
- [22] Werf MJ, Kodmon C. Whole-Genome Sequencing as Tool for Investigating International Tuberculosis Outbreaks: A Systematic Review. *Front Public Health*. 2019 Apr; 7(87).

- [23] Pérez-Lago L, Comas I, Navarro Y, González-Candelas F, Herranz M, Bouza E. et al. Whole Genome Sequencing Analysis of Inpatient Microevolution in *Mycobacterium tuberculosis*: Potential Impact on the Inference of Tuberculosis Transmission. *J Infect Dis*. 2014 Jan; 209(1): 98-108.
- [24] Feliciano CS, Praça JR, Peronni K, Silva WA Jr, Bollela VR. Evaluation of resistance acquisition during tuberculosis treatment using whole genome sequencing. *Braz J Infect Dis*. 2016 May-Jun; 20(3): 290-3.
- [25] Clark TG, Mallard K, Coll F, Preston M, Assefa S, Harris D. et al. Elucidating Emergence and Transmission of Multidrug-Resistant Tuberculosis in Treatment Experienced Patients by Whole Genome Sequencing. *PLoS One*. 2013 Dec; 8(12): e83012.
- [26] Zhang H, Li D, Zhao L, Fleming J, Lin N, Wang T. et al. Genome sequencing of 161 *Mycobacterium tuberculosis* isolates from China identifies genes and intergenic regions associated with drug resistance. *Nat Genet*. 2013 Oct; 45(10): 1255–60.
- [27] Walker TM, Kohl TA, Omar SV, Hedge J, Elias CDO, Bradley P. et al. Whole-genome sequencing for prediction of *Mycobacterium tuberculosis* drug susceptibility and resistance: a retrospective cohort study. *Lancet Infect Dis*, 2015 Oct; 15 (10): 1193-1202.
- [28] Witney AA, Gould KA, Arnold A, Coleman D, Delgado R, Dhillon J. et al. Clinical application of whole-genome sequencing to inform treatment for multidrug-resistant tuberculosis cases. *J Clin Microbiol*. 2015 May; 53(5): 1473-83.
- [29] Billington OJ, Mchugh TD, Gillespie SH. Physiological cost of rifampin resistance induced in vitro in *Mycobacterium tuberculosis*. *Antimicrob Agents Chemother*. 1999 Aug; 43(8): 1866-9.
- [30] Wagner A. Robustness, evolvability, and neutrality. *FEBS Lett*. 2005 Mar; 579(8): 1772-8.
- [31] Von Groll A, Martin A, Felix C, Prata PF, Honscha G, Portaels F. et al. Fitness study of the RDRio lineage and Latin American Mediterranean family of *Mycobacterium tuberculosis* in the city of Rio Grande, Brazil. *FEMS Immunol Med Microbiol*. 2010 Feb; 58(1): 119-27.
- [32] van Soolingen D, Hermans PW, de Haas PE, Soll DR, van Embden JD. Occurrence and stability of insertion sequences in *Mycobacterium tuberculosis* complex strains: evaluation of an insertion sequence-dependent DNA polymorphism as a tool in the epidemiology of tuberculosis. *J Clin Microbiol*. 1991 Nov; 29(11): 2578-86.

- [33] Canetti G, Fox W, Khomenko A, Mahler HT, Menon NK, Mitchison DA. et al. Advances in Techniques of Testing Mycobacterial Drug Sensitivity, and the Use of Sensitivity Tests in Tuberculosis Control Programmes. *Bull World Health Organ.* 1969; 41(1): 21-43.
- [34] Rouse DA, Morris SL. Molecular Mechanisms of Isoniazid Resistance in *Mycobacterium tuberculosis* and *Mycobacterium bovis*. *Infect Immun.* 1995 Apr; 63(4): 1427-33.
- [35] Cockerill FR, Uhl JR, Temesgen Z, Zhang Y, Stockman L, Roberts GD. et al. Rapid identification of a point mutation of the *Mycobacterium tuberculosis* catalase-peroxidase (*katG*) gene associated with isoniazid resistance. *J Infect Dis.* 1995 Jan; 171(1): 240-5.
- [36] Witney AA, Bateson AL, Jindani A, Phillips PP, Coleman D, Stoker NG. et al. Use of whole-genome sequencing to distinguish relapse from reinfection in a completed tuberculosis clinical trial. *BMC Med.* 2017 Mar 29; 15(1): 71.
- [37] Bolger AM, Lohse M, Usadel B. Trimmomatic: a flexible trimmer for Illumina sequence data. *Bioinformatics.* 2014 Aug 1; 30(15): 2114-20.
- [38] Li H, Durbin R. Fast and accurate short read alignment with Burrows-Wheeler transform. *Bioinformatics.* 2009 Jul 15; 25(14): 1754-60.
- [39] Li H, Handsaker B, Wysoker A, Fennell T, Ruan J, Homer N. et al. The Sequence Alignment/Map format and SAMtools. *Bioinformatics.* 2009 Aug 15; 25(16): 2078-9.
- [40] McKenna A, Hanna M, Banks E, Sivachenko A, Cibulskis K, Kernytsky A. et al. The Genome Analysis Toolkit: a MapReduce framework for analyzing next-generation DNA sequencing data. *Genome Res.* 2010 Sep; 20(9): 1297-303.
- [41] Parvaresh L, Crighton T, Martinez E, Bustamante A, Chen S, Sintchenko V. Recurrence of tuberculosis in a low-incidence setting: a retrospective cross-sectional study augmented by whole genome sequencing. *BMC Infect Dis.* 2018 Jun 7; 18(1): 265.
- [42] Coll F, Mallard K, Preston MD, Bentley S, Parkhill J, McNERNEY R. et al. SpolPred: rapid and accurate prediction of *Mycobacterium tuberculosis* spoligotypes from short genomic sequences. *Bioinformatics.* 2012 Nov 15; 28(22): 2991-3.
- [43] Demay C, Liens B, Burguière T, Hill V, Couvin D, Millet J. et al. SITVITWEB – a public available international multimarker database for studying *Mycobacterium tuberculosis* genetic diversity and molecular epidemiology. *Infect Genet Evol.* 2012 Jun; 12(4): 755-66.

- [44] BRASIL, Ministério da Saúde. Secretaria de Vigilância em Saúde, Departamento de Vigilância Epidemiológica. Manual de Recomendações para o Controle da Tuberculose no Brasil. Brasília (BR): Ministério da Saúde; 2011, 288 p.
- [45] Kelley LA, Mezulis S, Yates CM, Wass MN, Sternberg MJ. The Phyre2 web portal for protein modeling, prediction and analysis. Nat Protoc. 2015 Jun; 10(6): 845-858.
- [46] Bowie JU, Luthy R, Eisenberg D. A method to identify protein sequences that fold into a known three-dimensional structure. Science. 1991 Jul; 253(5016): 164-170.
- [47] Laskowski RA, MacArthur MW, Moss DS, Thornton JM. (1993). PROCHECK: a program to check the stereochemical quality of protein structures. J Appl Crystallogr. 1993 Apr; 26(2): 283-291.
- [48] Morris GM, Huey R, Lindstrom W, Sanner MF, Belew RK, Goodsell DS, Olson AJ. AutoDock4 and AutoDockTools4: Automated docking with selective receptor flexibility. J Comput Chem. 2009 Dec; 30(16): 2785-2791.
- [49] Humphrey W, Dalke A, Schulten K. VMD: visual molecular dynamics. J Mol Graph. 1996 Feb; 14(1): 33-38.
- [50] Trott O, Olson AJ. AutoDock Vina: improving the speed and accuracy of docking with a new scoring function, efficient optimization, and multithreading. J Comput Chem. 2010 Jan; 31(2): 455-461.
- [51] BIOVIA, Dassault Systèmes, Discovery Studio. San Diego: Dassault Systèmes, 2021.
- [52] Bryant JM, Harris SR, Parkhill J, Dawson R, Diacon AH, van Helden P. et al. Whole-genome sequencing to establish relapse or re-infection with *Mycobacterium tuberculosis*: a retrospective observational study. Lancet Respir Med. 2013 Dec; 1(10): 786–92.
- [53] Kato-Maeda M, Ho C, Passarelli B, Banaei N, Grinsdale J, Flores L, Anderson J. et al. Use of Whole Genome Sequencing to Determine the Microevolution of *Mycobacterium tuberculosis* during an Outbreak. PLoS One. 2013; 8(3): e58235.
- [54] Roetzer A, Diel R, Kohl TA, Rückert C, Nübel U, Blom J. et al. Whole Genome Sequencing versus Traditional Genotyping for Investigation of a *Mycobacterium tuberculosis* Outbreak: A Longitudinal Molecular Epidemiological Study. PLoS Med. 2013; 10(2): e1001387.
- [55] Luo T, Yang C, Peng Y, Lu L, Sun G, Wu J. et al. Whole-genome sequencing to detect recent transmission of *Mycobacterium tuberculosis* in settings with a high burden of tuberculosis. Tuberculosis. 2014 Jul; 94(4): 434-40.

- [56] Walker TM, Merker M, Knoblauch AM, Helbling P, Schoch OD, van der Werf MJ. et al. A cluster of multidrug-resistant *Mycobacterium tuberculosis* among patients arriving in Europe from the Horn of Africa: a molecular epidemiological study. *Lancet Infect Dis*. 2018 Apr; 18(4): 431-440.
- [57] Wei CJ, Lei B, Musser JM, Tu SC. Isoniazid Activation Defects in Recombinant *Mycobacterium tuberculosis* Catalase-Peroxidase (*katG*) Mutants Evident in *inhA* Inhibitor Production. *Antimicrob Agents Chemother*. 2003 Feb; 47(2): 670-5.
- [58] Gagneux S, Burgos MV, DeRiemer K, Encisco A, Muñoz S, Hopewell PC. et al. Impact of Bacterial Genetics on the Transmission of Isoniazid-Resistant *Mycobacterium tuberculosis*. *PLoS Pathog*. 2006 Jun; 2(6): e61.
- [59] Ando H, Kondo Y, Suetake T, Toyota E, Kato S, Mori T. et al. Identification of *katG* mutations associated with high-level isoniazid resistance in *Mycobacterium tuberculosis*. *Antimicrob Agents Chemother*. 2010 May; 54(5): 1793-9.
- [60] Cade CE, Dlouhy AC, Medzihradzky KF, Salas-Castillo SP, Ghiladi RA. Isoniazid-resistance conferring mutations in *Mycobacterium tuberculosis katG*: Catalase, peroxidase, and INH-NADH adduct formation activities. *Protein Sci*. 2010 Mar; 19(3): 458-74.
- [61] Purkan P, Ihsanawati, Yana MS, Debbie SR, Achmad SN, Shigeru S. Novel mutations in *katG* gene of a clinical isolate of isoniazid-resistant *Mycobacterium tuberculosis*. *Biologia*. 2012; 67(1): 41-7.
- [62] Coelho T, Machado D, Couto I, Maschmann R, Ramos D, von Groll A. et al. Enhancement of antibiotic activity by efflux inhibitors against multidrug resistant *Mycobacterium tuberculosis* clinical isolates from Brazil. *Front Microbiol*. 2015 Apr 28; 6 (330): 1-12.
- [63] Purkan P, Ihsanawati, Natalia D, Syah YM, Retnoningrum DS, Kusuma HS. Mutation of *katG* in a clinical isolate of *Mycobacterium tuberculosis*: effects on catalase-peroxidase for isoniazid activation. *Ukr Biochem J*. 2016 Sep-Oct; 88(5): 71-81.
- [64] Comas I, Borrell S, Roetzer A, Rose G, Malla B, Kato-Maeda M. et al. Whole-genome sequencing of rifampicin-resistant *M. tuberculosis* strains identifies compensatory mutations in RNA polymerase. *Nat Genet*. 2011 Dec 18; 44(1): 106-10.
- [65] Bergval I, Coll F, Schuitema A, de Ronde H, Mallard K, Pain A. et al. A proportion of mutations fixed in the genomes of in vitro selected isogenic drug-resistant *Mycobacterium tuberculosis* mutants can be detected as minority variants in the parent culture. *FEMS Microbiol Lett*. 2015 Jan; 362(2): 1-7.

- [66] Cohen KA, Abeel T, Manson McGuire A, Desjardins CA, Munsamy V, Shea TP. et al. Evolution of Extensively Drug-Resistant Tuberculosis over Four Decades: Whole Genome Sequencing and Dating Analysis of *Mycobacterium tuberculosis* Isolates from KwaZulu-Natal. PLoS Med. 2015 Sep 29; 12(9): e1001880.
- [67] Li QJ, Jiao WW, Yin QQ, Xu F, Li JQ, Sun L. et al. Compensatory Mutations of Rifampin Resistance Are Associated with Transmission of Multidrug-Resistant *Mycobacterium tuberculosis* Beijing Genotype Strains in China. Antimicrob Agents Chemother. 2016 Apr 22; 60(5): 2807-12.
- [68] Honoré N, Marchal G, Cole ST. Streptomycin Resistance in Mycobacteria. Antimicrob Agents Chemother. 1995 Mar; 39(3): 769-70.
- [69] Meier A, Kirschner P, Bange FC, Vogel U, Böttger EC. et al. Genetic alterations in streptomycin-resistant *Mycobacterium tuberculosis*: mapping of mutations conferring resistance. Antimicrob Agents Chemother. 1994 Feb; 38(2): 228-33.
- [70] Sreevatsan S, Pan X, Stockbauer KE, Williams DL, Kreiswirth BN, Musser JM. Characterization of *rpsL* and *rrd* mutations in streptomycin-resistant *Mycobacterium tuberculosis* isolates from diverse geographic localities. Antimicrob Agents Chemother. 1996 Apr; 40(4): 1024-6.
- [71] Katsukawa C, Tamaru A, Miyata Y, Abe C, Makino M, Suzuki Y. Characterization of the *rpsL* and *rrs* genes of streptomycin-resistant clinical isolates of *Mycobacterium tuberculosis* in Japan. J Appl Microbiol. 1997 Nov; 83(5): 634-40.
- [72] Spies FS, Ribeiro AW, Ramos DF, Ribeiro MO, Martin A, Palomino JC. et al. Streptomycin Resistance and Lineage-Specific Polymorphisms in *Mycobacterium tuberculosis gidB* Gene. J Clin Microbiol. 2011 Jul; 49(7): 2625-30.
- [73] Nhu NT, Lan NT, Phuong NT, Chau Nv, Farrar J, Caws M. Association of streptomycin resistance mutations with level of drug resistance and *Mycobacterium tuberculosis* genotypes. Int J Tuberc Lung Dis. 2012 Apr; 16(4): 527-31.
- [74] Sun H, Zhang C, Xiang L, Pi R, Guo Z, Zheng C. Characterization of mutations in streptomycin-resistant *Mycobacterium tuberculosis* isolates in Sichuan, China and the association between Beijing-lineage and dual-mutation in *gidB*. Tuberculosis. 2016 Jan; 96: 102-6.
- [75] Chen X, Kong F, Wang Q, Li C, Zhang J, Gilbert GL. Rapid Detection of Isoniazid, Rifampin, and Ofloxacin Resistance in *Mycobacterium tuberculosis* Clinical Isolates Using High-Resolution Melting Analysis. J Clin Microbiol. 2011 Oct; 49(10): 3450-7

- [76] Narayanan S, Swaminathan S, Supply P, Shanmugam S, Narendran G, Hari L. et al. Impact of HIV Infection on the Recurrence of Tuberculosis in South India. *J Infect Dis.* 2010 Mar; 201(5): 691-703.
- [77] Hasnain SE, O'Toole RF, Grover S, Ehtesham NZ. Whole genome sequencing: A new paradigm in the surveillance and control of human tuberculosis. *Tuberculosis.* 2015 Mar; 95(2): 91-4.
- [78] Korhonen V, Smit PW, Haanperä M, Casali N, Ruutu P, Vasankari T. et al. Whole genome analysis of *Mycobacterium tuberculosis* isolates from recurrent episodes of tuberculosis, Finland, 1995–2013. *Clin Microbiol Infect.* 2016 Jun; 22(6): 549-54.
- [79] Rouse DA, DeVito JA, Li Z, Byer H, Morris SL. Site-directed mutagenesis of the *katG* gene of *Mycobacterium tuberculosis*: effects on catalase–peroxidase activities and isoniazid resistance. *Mol Microbiol.* 1996 Nov; 22(3): 583-92.
- [80] Morlock G1, Metchock B, Sikes D, Crawford JT, Cooksey RC. *ethA*, *inhA*, and *katG* Loci of Ethionamide-Resistant Clinical *Mycobacterium tuberculosis* Isolates. *Antimicrob Agents Chemother.* 2003 Dec; 47(12): 3799-805.
- [81] Unissa AN, Selvakumar N, Narayanan S, Narayanan PR. Molecular analysis of isoniazid-resistant clinical isolates of *Mycobacterium tuberculosis* from India. *Int J Antimicrob Agents.* 2008 Jan; 31(1): 71-5.
- [82] Bolotin S, Alexander DC, Chedore P, Drews SJ, Jamieson F. Molecular characterization of drug-resistant *Mycobacterium tuberculosis* isolates from Ontario, Canada. *J Antimicrob Chemother.* 2009 Aug; 64(2): 263-6.
- [83] Evans J, Stead MC, Nicol MP, Segal H. Rapid genotypic assays to identify drug-resistant *Mycobacterium tuberculosis* in South Africa. *J Antimicrob Chemother.* 2009 Jan; 63(1): 11-6.
- [84] Dymova MA1, Cherednichenko AG, Alkhovik OI, Khrapov EA, Petrenko TI, Filipenko ML. Characterization of extensively drug-resistant *Mycobacterium tuberculosis* isolates circulating in Siberia. *BMC Infect Dis.* 2014 Sep 3;14 (478): 1-14.
- [85] Jaksuwan R, Tharavichikul P, Patumanond J, Chuchottaworn C, Chanwong S, Smithtikarn S. et al. Genotypic distribution of multidrug-resistant and extensively drug-resistant tuberculosis in northern Thailand. *Infect Drug Resist.* 2017 Jun 10; 10: 167-74.

- [86] Sebastian J, Swaminath S, Nair RR, Jakkala K, Pradhan A, Ajitkumar P. De Novo Emergence of Genetically Resistant Mutants of *Mycobacterium tuberculosis* from the Persistence Phase Cells Formed against Antituberculosis Drugs In Vitro. *Antimicrob Agents Chemother.*, v. 61, n. 2, p. 1-25, 2017.
- [87] Miotto P, Cabibbe AM, Borroni E, Degano M, Cirillo DM. Role of Disputed Mutations in the *rpoB* Gene in Interpretation of Automated Liquid MGIT Culture Results for Rifampin Susceptibility Testing of *Mycobacterium tuberculosis*. *J Clin Microbiol.* 2018 Apr 25; 56(5): e01599-17.
- [88] Silva MS, Senna SG, Ribeiro MO, Valim AR, Telles MA, Kritski A. et al. Mutations in *katG*, *inhA*, and *ahpC* Genes of Brazilian Isoniazid-Resistant Isolates of *Mycobacterium tuberculosis*. *J Clin Microbiol.* 2003 Sep; 41(9): 4471-4.
- [89] Cardoso RF, Cooksey RC, Morlock GP, Barco P, Cecon L, Forestiero F. et al. Screening and Characterization of Mutations in Isoniazid-Resistant *Mycobacterium tuberculosis* Isolates Obtained in Brazil. *Antimicrob Agents Chemother.* 2004 Sep; 48(9): 3373-81.
- [90] Dalla Costa ER, Ribeiro MO, Silva MS, Arnold LS, Rostirolla DC, Cafrune PI. et al. Correlations of mutations in *katG*, *oxyR-ahpC* and *inhA* genes and in vitro susceptibility in *Mycobacterium tuberculosis* clinical strains segregated by spoligotype families from tuberculosis prevalent countries in South America. *BMC Microbiol.* 2009 Feb 19; 9(39): 1-11.
- [91] Siqueira HR, Freitas FA, Oliveira DN, Barreto AM, Dalcolmo MP, Albano RM. Isoniazid-resistant *Mycobacterium tuberculosis* strains arising from mutations in two different regions of the *katG* gene. *J Bras Pneumol.* 2009 Aug; 35(8):773-9.
- [92] Huyen MN, Cobelens FG, Buu TN, Lan NT, Dung NH, Kremer K. et al. Epidemiology of Isoniazid Resistance Mutations and Their Effect on Tuberculosis Treatment Outcomes. *Antimicrob Agents Chemother.* 2013 Aug; 57(8): 3620-7.
- [93] Jagielski T, Bakula Z, Roeske K, Kamiński M, Napiórkowska A, Augustynowicz-Kopeć E. et al. Detection of mutations associated with isoniazid resistance in multidrug-resistant *Mycobacterium tuberculosis* clinical isolates. *J Antimicrob Chemother.* 2014 Sep; 69(9): 2369-75.
- [94] Tseng ST, Tai CH, Li CR, Lin CF, Shi ZY. The mutations of *katG* and *inhA* genes of isoniazid-resistant *Mycobacterium tuberculosis* isolates in Taiwan. *J Microbiol Immunol Infect.* 2015 Jun; 48(3): 249-55.



- [95] Torres JN, Paul LV, Rodwell TC, Victor TC, Amallraja AM, Elghraoui A. et al. Novel *katG* mutations causing isoniazid resistance in clinical *M. tuberculosis* isolates. *Emerg Microbes Infect.* 2015 Jul; 4(7): e42.
- [96] Unissa AN, Selvakumar N, Narayanan S, Suganthi C, Hanna LE. Investigation of Ser315 Substitutions within *katG* Gene in Isoniazid-Resistant Clinical Isolates of *Mycobacterium tuberculosis* from South India. *Biomed Res Int.* 2015; 2015: 257983.
- [97] Oliveira CLN, Muniz-Sobrinho Jda S, Viana-Magno LA, Oliveira Melo SC, Macho A, Rios-Santos F. Detection of multidrug-resistant *Mycobacterium tuberculosis* strains isolated in Brazil using a multimarker genetic assay for *katG* and *rpoB* genes. *Braz J Infect Dis.* 2016 Mar-Apr; 20(2): 166-72.
- [98] HELDAL, E. A *katG* 315 mutation alone should not lead to exclusion of isoniazid in treatment of multidrug-resistant tuberculosis. *Eur Respir J.* 2017 Oct 12; 50(4): 1701696.
- [99] Lempens P, Meehan CJ, Vandelannoote K, Fissette K, de Rijk P, Van Deun A. et al. Isoniazid resistance levels of *Mycobacterium tuberculosis* can largely be predicted by high-confidence resistance-conferring mutations. *Sci Rep.* 2018 Feb 19; 8(1): 3246.
- [100] Woodford N, Ellington MJ. The emergence of antibiotic resistance by mutation. *Clin Microbiol Infect.* 2007 Jan; 13(1): 5-18.
- [101] Hofmann-Thiel S, van Ingen J, Feldmann K, Turaev L, Uzakova GT, Murmusaeva G. et al. Mechanisms of heteroresistance to isoniazid and rifampin of *Mycobacterium tuberculosis* in Tashkent, Uzbekistan. *Eur Respir J.* 2009 Feb; 33(2): 368-74.
- [102] Schürch AC, Kremer K, Kiers A, Daviena O, Boeree MJ, Siezen RJ. et al. The tempo and mode of molecular evolution of *Mycobacterium tuberculosis* at patient-to-patient scale. *Infect Genet Evol.* 2010 Jan; 10(1): 108-14.
- [103] Merker M, Kohl TA, Roetzer A, Truebe L, Richter E, Rüscher-Gerdes S. et al. Whole Genome Sequencing Reveals Complex Evolution Patterns of Multidrug-Resistant *Mycobacterium tuberculosis* Beijing Strains in Patients. *PLoS One.* 2013 Dec; 8(12): e82551.
- [104] Ravibalan T, Samrot AV, Maruthai K, Kommoju V, Kesavan S, Muthaiah M. Clinical Evaluation of Automated BACTEC MGIT 960 System for Identification, Recovery and Drug Susceptibility Testing of *Mycobacterium tuberculosis* Clinical Isolates. *Indian J Sci Technol.* 2016 Feb; 9(8): 1-5.

- [105] Doyle RM, Burgess C, Williams R, Gorton R, Booth H, Brown J. et al. Direct whole genome sequencing of sputum accurately identifies drug resistant *Mycobacterium tuberculosis* faster than MGIT culture sequencing. *J Clin Microbiol*. 2018 Jul; 56(8): e00666-18.
- [106] Feliciano CS, Namburete EI, Rodrigues Praça J, Peronni K, Dippenaar A, Warren RM. et al. Accuracy of whole genome sequencing versus phenotypic (MGIT) and commercial molecular tests for detection of drug-resistant *Mycobacterium tuberculosis* isolated from patients in Brazil and Mozambique. *Tuberculosis*. 2018 May; 110: 59-67.
- [107] Ruesen C, Riza AL, Florescu A, Chaidir L, Editoiu C, Aalders N. et al. Linking minimum inhibitory concentrations to whole genome sequence-predicted drug resistance in *Mycobacterium tuberculosis* strains from Romania. *Sci Rep*. 2018 Jun; 8(1): 9676.
- [108] Banu S, Rahman SM, Khan MS, Ferdous SS, Ahmed S, Gratz J. et al. Discordance across Several Methods for Drug Susceptibility Testing of Drug-Resistant *Mycobacterium tuberculosis* Isolates in a Single Laboratory. *J Clin Microbiol*. 2014 Jan; 52(1): 156-63.
- [109] Papaventsis D, Casali N, Kontsevaya I, Drobniewski F, Cirillo DM, Nikolayevskyy V. Whole genome sequencing of *Mycobacterium tuberculosis* for detection of drug resistance: a systematic review. *Clin Microbiol Infect*. 2017 Feb; 23(2): 61-68.
- [110] KIM SJ. Drug-susceptibility testing in tuberculosis: methods and reliability of results. *Eur Respir J*. 2005 Mar; 25(3): 564-9.
- [111] Black PA, de Vos M, Louw GE, van der Merwe RG, Dippenaar A, Streicher EM. et al. Whole genome sequencing reveals genomic heterogeneity and antibiotic purification in *Mycobacterium tuberculosis* isolates. *BMC Genomics*. 2015 Oct; 16:857.
- [112] Vilchèze C, Jacobs WR Jr. Resistance to Isoniazid and Ethionamide in *Mycobacterium tuberculosis*: Genes, Mutations, and Causalities. *Microbiol Spectr*. 2014 Aug; 2(4): MGM2-0014-2013.
- [113] Mo L, Zhang W, Wang J, Weng XH, Chen S, Shao LY, Pang MY, Chen ZW. Three-dimensional model and molecular mechanism of *Mycobacterium tuberculosis* catalase-peroxidase (*KatG*) and isoniazid-resistant *KatG* mutants. *Microb Drug Resist*. 2004; 10(4): 269-279.

- [114] Regelsberger G, Jakopitsch C, Furtmüller PG, Rueker F, Switala J, Loewen PC, Obinger C. The role of distal tryptophan in the bifunctional activity of catalase-peroxidases. *Biochem Soc Trans.* 2001 May; 29(2): 99-105.
- [115] Maningi NE, Daum LT, Rodriguez JD, Said HM, Peters RPH, Sekyere JO. et al. Multi- and Extensively Drug Resistant *Mycobacterium tuberculosis* in South Africa: a Molecular Analysis of Historical Isolates. *J Clin Microbiol.* 2018 Apr; 56(5): e01214-17.
- [116] Mallard K, McNerney R, Crampin AC, Houben R, Ndlovu R, Munthali L. et al. Molecular Detection of Mixed Infections of *Mycobacterium tuberculosis* Strains in Sputum Samples from Patients in Karonga District, Malawi. *J Clin Microbiol.* 2010 Dec; 48(12): 4512-8.
- [117] Marx FM, Dunbar R, Enarson DA, Williams BG, Warren RM, van der Spuy GD. et al. The Temporal Dynamics of Relapse and Reinfection Tuberculosis After Successful Treatment: A Retrospective Cohort Study. *Clin Infect Dis.* 2014 Jun; 58(12): 1676-83.
- [118] Kay GL, Sergeant MJ, Zhou Z, Chan JZ, Millard A, Quick J. et al. Eighteenth-century genomes show that mixed infections were common at time of peak tuberculosis in Europe. *Nat Commun.* 2015 Apr; 6:6717.
- [119] Shin SS, Modongo C, Baik Y, Allender C, Lemmer D, Colman RE. et al. Mixed infections are associated with poor treatment outcomes among newly diagnosed tuberculosis patients independent of pre-treatment heteroresistance. *J Infect Dis.* 2018 Nov; 218(12): 1974-1982
- [120] Dookie N, Rambaran S, Padayatchi N, Mahomed S, Naidoo K. et al. Evolution of drug resistance in *Mycobacterium tuberculosis*: a review on the molecular determinants of resistance and implications for personalized care. *J Antimicrob Chemother.* 2018 May; 73(5): 1138-1151.

## Tables

**Table 1.** Clinical and epidemiological data from the six patients studied

Patients	Gender	Alcoholic	Smoker	Drug user	HIV	HCV	HBsAg	Diabetes	Prisoner
A	Male	Yes	Yes	No	No	No	No	No	No
B	Female	*	*	No	Yes	No	No	No	No
C	Male	Yes	Yes	No	No	No	No	No	No
D	Male	No	*	Yes	No	No	No	No	Yes
E	Male	*	*	*	Yes	Yes	No	No	No
F	Male	Yes	*	*	No	No	No	Yes	No

HBsAg: hepatitis B surface antigen, HCV: hepatitis C virus, HIV: human immunodeficiency virus. \*Not informed.

**Table 2.** Genotypic profile of the *Mycobacterium tuberculosis* strains by the MIRU-VNTR and Spoligotyping methods

Samples	MIRU-VNTR	SPOLIGOTYPING	SIT	CLADE
A1	254343332493254221136243	777776777760601	137	X2
A2	254343332493254221136243	777776777760601	137	X2
B1	263142232432241221234223	677777607760771	20	LAM1
B2	263142232432241221234223	677777607760771	20	LAM1
B3	263142232432241221234223	677777607760771	20	LAM1
C1	252333332553262221234233	777777777760700	51	T1
C2	252333332553262221234233	777777777760700	51	T1
D1	244345332373254221334233	777777777760671	245	T1
D2	244345332373254221334233	777777777760471	65	T1
E1	244345332373254221334233	777777777760471	65	T1
E2	244345332373254221334233	777777777760471	65	T1
F1	263142234442251221234123	677737607760711	179	LAM2
F2	263142234442251221234123	677737607760711	179	LAM2

MIRU-VNTR: mycobacterial interspersed repetitive units-variable number of tandem repeat, SIT: spoligotype international type.

**Table 3.** Difference of Single Nucleotide Polymorphisms (SNPs) among serial isolates of *Mycobacterium tuberculosis*

<b>Sample/Patient</b>	<b>SNP distance (number)</b>	<b>Time between isolation (years)</b>
<b>A1/A2</b>	1	0.25
<b>B1/B2</b>	0	0.75
<b>B2/B3</b>	3	1.1
<b>C1/C2</b>	0	0.3
<b>D1/D2</b>	266	1.3
<b>E1/E2</b>	2	0.6
<b>F1/F2</b>	4	1.1

SNP: *single nucleotide polymorphism*.

**Table 4.** SNPs in genes related to antibiotic resistance and the percentage of base composition in all mapped reads from each position

Patient	Position	Mutation	Gene	Reference	Isolate 1					Isolate 2					Isolate 3				
					A (%)	C (%)	G (%)	T (%)	Phenotypic Resistance	A (%)	C (%)	G (%)	T (%)	Phenotypic Resistance	A (%)	C (%)	G (%)	T (%)	Phenotypic Resistance
A		C-54T	<i>ahpC</i>	C	0	100	0	0		0	0	0	100						
	765150	G594E	<i>rpoC</i>	G	100	0	0	0		100	0	0	0						
	2153907	D735X*/Y	<i>katG</i>	G	0	0	100	0	S	0	41	59	0	INH					
	2153909		<i>katG</i>	C	100	0	0	0		100	0	0	0						
B	781687	K43R	<i>rpsL</i>	A	71	0	29	0	S	71	0	29	0	STR	0	0	100	0	STR
C	2155102	Y337C	<i>katG</i>	T	0	99	0	1	INH	0	100	0	0	INH					
D	765150	G594E	<i>rpoC</i>	G	100	0	0	0	S	100	0	0	0	INH					
	2155700	N138H	<i>katG</i>	T	0	0	0	100		0	0	100	0						
E	761139	H445D	<i>rpoB</i>	C	0	100	0	0		0	0	100	0						
	765150	G594E	<i>rpoC</i>	G	100	0	0	0	INH	99	0	1	0	MDR					
	2155700	N138H	<i>katG</i>	T	0	0	100	0		0	0	100	0						
F	2155168	S315T	<i>katG</i>	C	0	100	0	0	S	0	0	100	0	INH					

\*Point mutations in positions 2153907 and 2153909 that together resulted in a stop codon (X). These positions in WGS are showed in antisense and in complement strand. INH: isoniazid, MDR: multidrug-resistant, S: susceptible, SNP: single nucleotide polymorphism, STR: streptomycin.

**Table 5.** Confirmatory results related to the molecular and phenotypic variation of A1 and A2 strains

Strain	INH MIC (µg/mL)	Catalase activity	Sequencing by Sanger Method	
			<i>ahpC</i>	<i>katG</i> 735
H37Rv	0.25	+	Wt	D
A1	0.125	+	Wt	Stop
A2	16.0	-	C-54T	Y

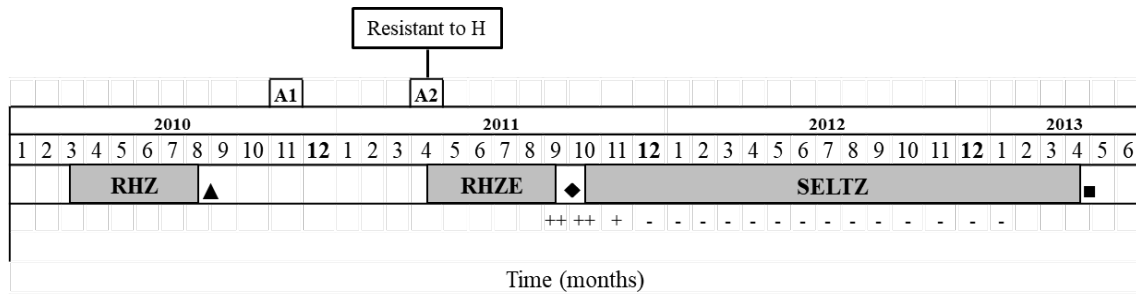
INH: *isoniazid*, MIC: *minimal inhibitory concentration*, WT: *wild type*.

**Table 6.** Free energy of binding predicted by molecular docking simulations with Vina and approximated final docked position

Gene/Strain	With HEM		Without HEM	
	Score (in kcal/mol)	Amino acids / HEM interacting with INH	Score (in kcal/mol)	Amino acids interacting with INH
<i>katG</i> H37Rv wt	-6.5	PRO422, LYS488, GLY490, ASN493, ASP 735, ASP738	-6.5	PRO422, LYS488, GLY490, ASP 735, ASP738
<i>katG</i> D735X	-6.5	HEM, ASP137, ILE228, TYR229, VAL230, PRO232,	-6.4	ASP93, ASP94, HIS97, LEU101, GLY273, LYS274,
<i>katG</i> D735Y	-7.0	HEM, TRP107, ASP137, PRO232	-6.4	ASP93, ASP94, HIS97, LEU101, GLY273, LYS274,

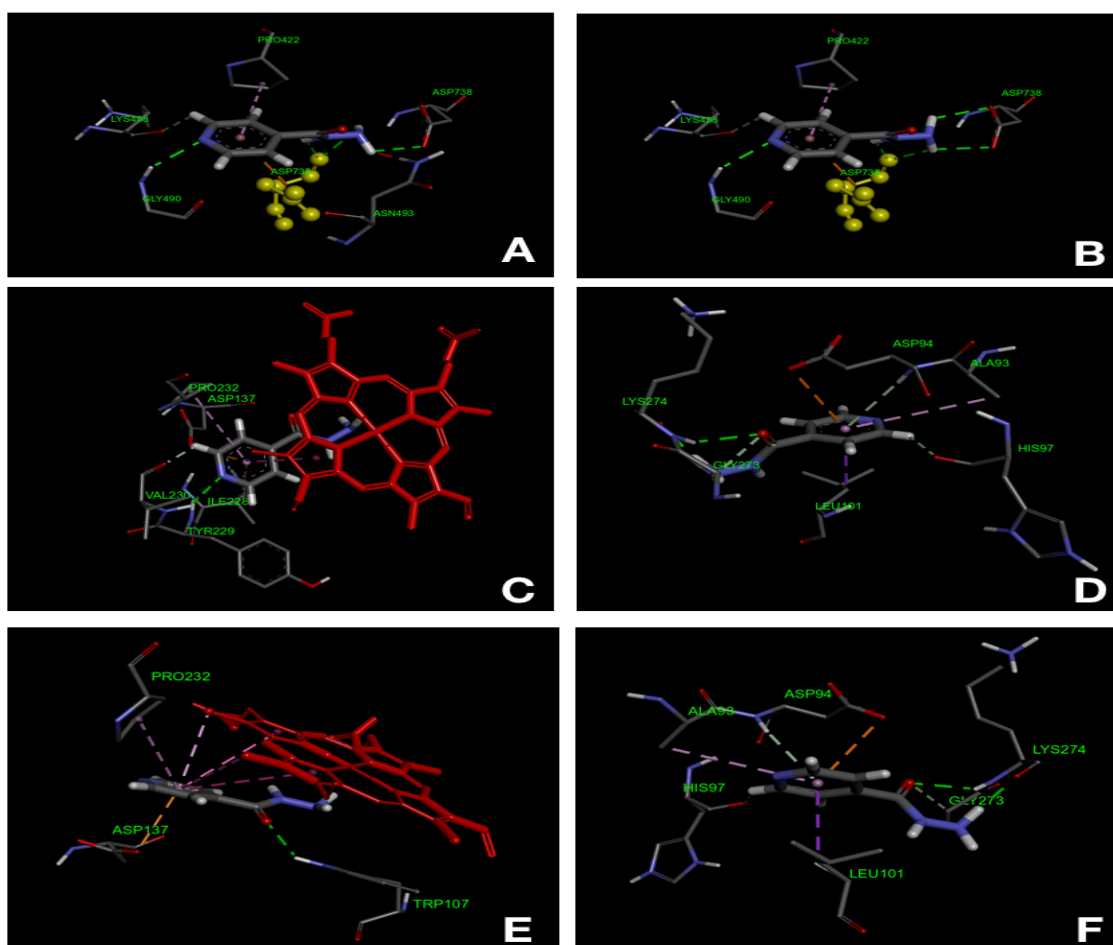
ASN: *asparagine*, ASP: *aspartate*, GLY: *glycine*, HIS: *histidine*, ILE: *isoleucine*, INH: *isoniazid*, KCAL: *kilocalorie*, LEU: *leucine*, MOL: *mole*, LYS: *lysine*, PRO: *proline*, TRP: *tryptophan*, TYR: *tyrosine*, VAL: *valine*, WT: *wild type*.

### Captions to illustrations

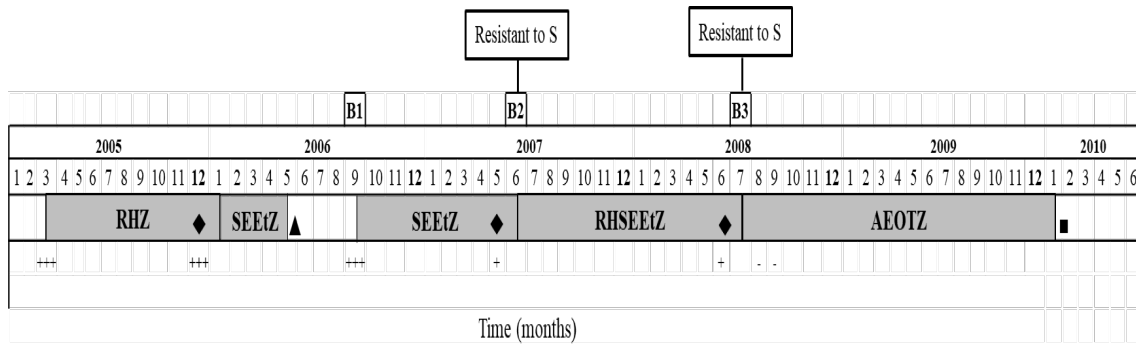


**Figure 1.** Treatment history and susceptibility profile of first-line anti-TB drugs by BATEC 320 MGIT system from patient A. E: ethambutol, H: isoniazid, L: levofloxacin, R: rifampicin, S: streptomycin, T: terizidone, Z: pyrazinamide. ▲: abandonment treatment, ■: treatment cure, ◆: treatment failure, +: positive bacilloscopy, -: negative bacilloscopy. Letters in box are the strains isolated.

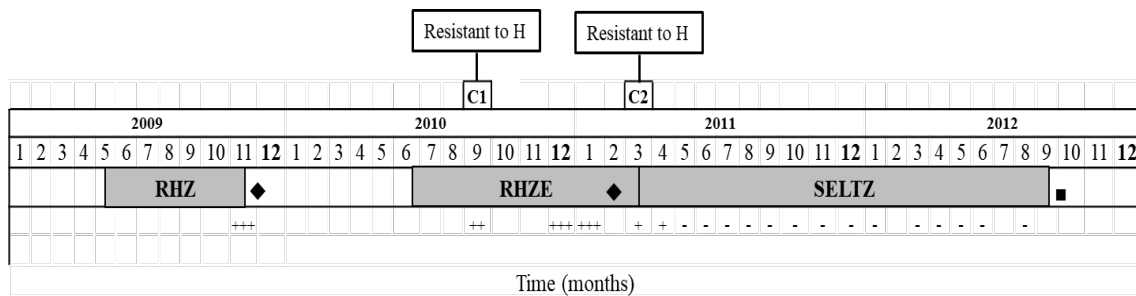




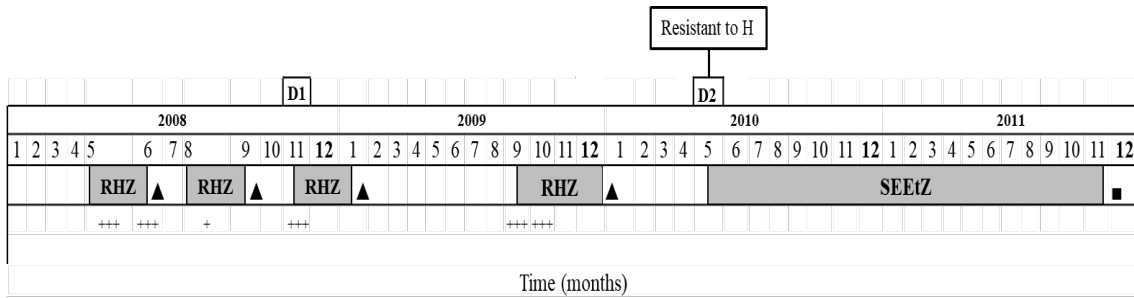
**Figure 2.** The best docking positions for INH-*katG*. (A) *katG* wt with HEM-INH, (B) *katG* wt-INH, (C) A1 D735X with HEM-INH, (D) A1 D735X-INH, (E) A2 D735Y with HEM-INH, (F) A2 D735Y-INH. The *katG* amino acids are labeled in green, where we highlighted in yellow in (A) and (B) the Asp 735 (the point mutation). HEM is colored in red. INH is in the center of the figures. The colors of the bonds in dotted lines corresponds to: green (conventional hydrogen bond), light green (carbon hydrogen bond or Pi-donor hydrogen bond), orange (Pi-anion), magenta (Pi-sigma or Pi-Pi stacked), rose (Pi-alkyl). Figure and analyses generated by Discovery Studio.



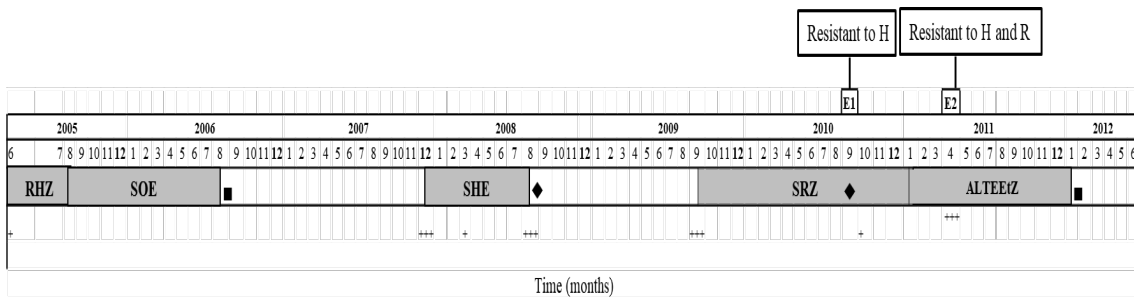
**Figure 3.** Treatment history and susceptibility profile of first-line anti-TB drugs by BATEC 320 MGIT system from patient B. A: amikacin, E: ethambutol, Et: ethionamide, H: isoniazid, O: ofloxacin, R: rifampicin, S: streptomycin, T: terizidone, Z: pyrazinamide. ▲: abandonment treatment, ■: treatment cure, ♦: treatment failure, +: positive bacilloscopy, -: negative bacilloscopy. Letters in box are the strains isolated.



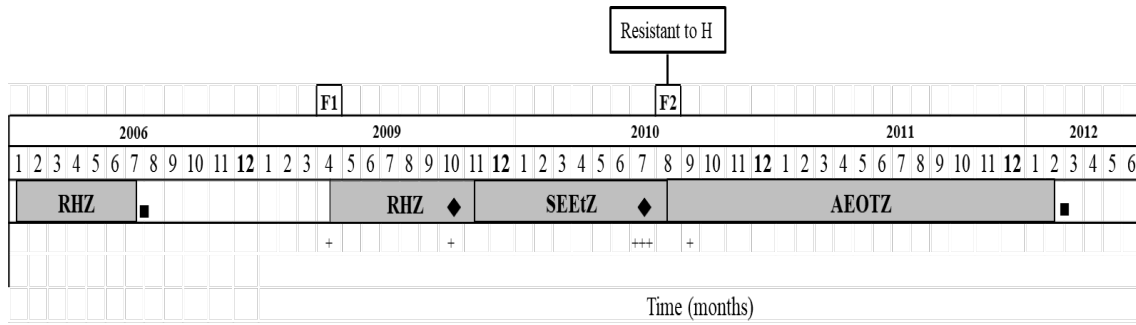
**Figure 4.** Treatment history and susceptibility profile of first-line anti-TB drugs by BATEC 320 MGIT system from patient C. E: ethambutol, H: isoniazid, L: levofloxacin, R: rifampicin, S: streptomycin, T: terizidone, Z: pyrazinamide. ▲: abandonment treatment, ■: treatment cure, ♦: treatment failure, +: positive bacilloscopy, -: negative bacilloscopy. Letters in box are the strains isolated.



**Figure 5.** Treatment history and susceptibility profile of first-line anti-TB drugs by BATEC 320 MGIT system from patient D. E: ethambutol, H: isoniazid, L: levofloxacin, R: rifampicin, S: streptomycin, T: terizidone, Z: pyrazinamide. ▲: abandonment treatment, ■: treatment cure, ♦: treatment failure, +: positive bacilloscopy, -: negative bacilloscopy. Letters in box are the strains isolated.



**Figure 6.** Treatment history and susceptibility profile of first-line anti-TB drugs by BATEC 320 MGIT system from patient E. A: amikacin, E: ethambutol, Et: ethionamide, H: isoniazid, L: levofloxacin, R: rifampicin, S: streptomycin, T: terizidone, Z: pyrazinamide. ▲: abandonment treatment, ■: treatment cure, ♦: treatment failure, +: positive bacilloscopy, -: negative bacilloscopy. Letters in box are the strains isolated.



**Figure 7.** Treatment history and susceptibility profile of first-line anti-TB drugs by BATEC 320 MGIT system from patient F. A: amikacin, E: ethambutol, Et: ethionamide, H: isoniazid, O: ofloxacin, R: rifampicin, S: streptomycin, T: terizidone, Z: pyrazinamide. ▲: abandonment treatment, ■: treatment cure, ◆: treatment failure, +: positive bacilloscopy, -: negative bacilloscopy. Letters in box are the strains isolated.

**Funding:** JLCGD was a Fellow of Coordenação de Aperfeiçoamento de Pessoal de Nível Superior (CAPES), PEAS is a Fellow of **Conselho Nacional de Desenvolvimento Científico e Tecnológico** (CNPq) productivity. The study had financial support by **Project CNPq/Universal (401963/2016-0)**, CAPES (PVE-CAPES, 88881.064961/2014-01) and iMed.Ulisboa from Fundação para a Ciência e Tecnologia (SFRH/BPD/95406/2013). JEP is funded by a Newton Institutional Links Grant (British Council, no. 261868591). TGC is funded by the Medical Research Council UK (Grant no. MR/M01360X/1, MR/N010469/1, MR/R025576/1, and MR/R020973/1) and BBSRC (Grant no. BB/R013063/1). SC is funded by Medical Research Council UK grants (ref. MR/M01360X/1, MR/R025576/1, and MR/R020973/1).

**Competing interests:** The authors report no conflicts of interest.

**Ethical approval:** This work was approved by the Research Ethics Committee of the State Foundation for Production and Health Research (n. 04/2012).