



**Laboratoire Ampère**  
Unité Mixte de Recherche CNRS  
Génie Électrique, Automatique et Bio-Ingénierie

# Design and realisation of a test system for two-dimensional magnetic testing including temperature influence

Clémentine Delaunay - PhD Student

Fabien Sixdenier & Charles Joubert

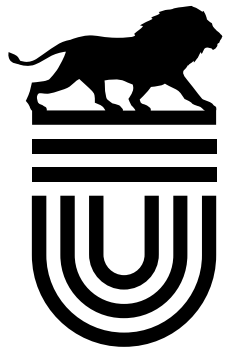

**UNIVERSITÉ  
DE LYON**

Université Claude Bernard  Lyon 1

 ÉCOLE  
**CENTRALE LYON**

**INSA** | INSTITUT NATIONAL  
DES SCIENCES  
APPLIQUÉES  
LYON



# Introduction & context

---

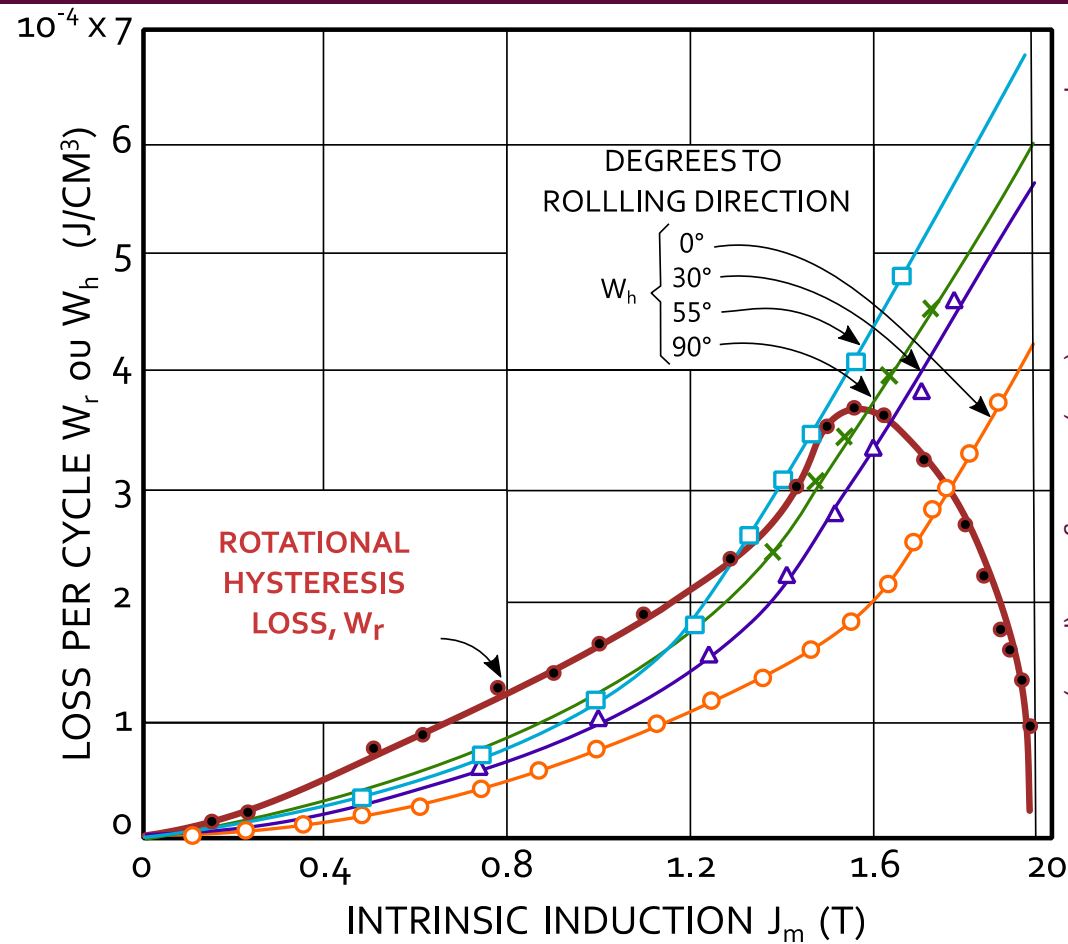
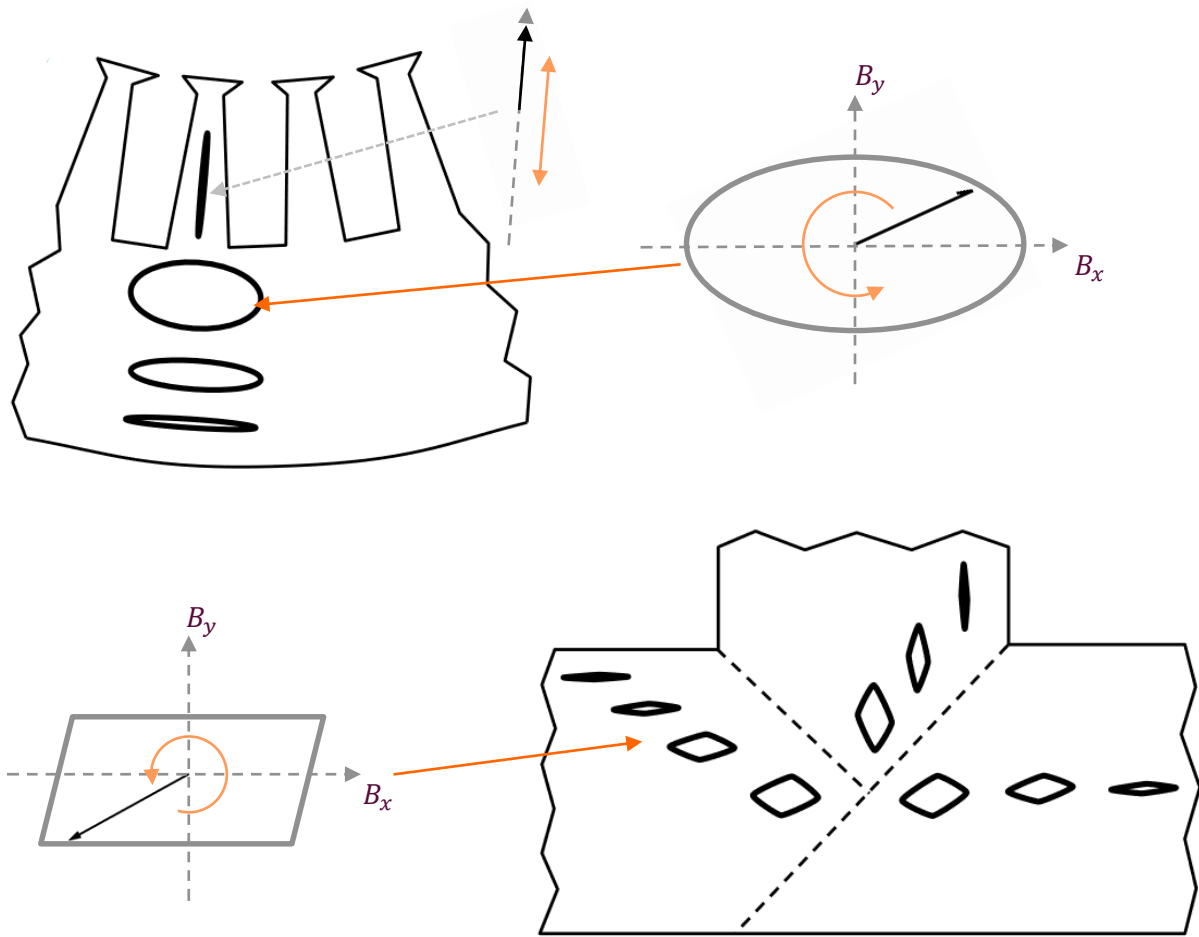

Adapted from : R.M. Bozorth (1993). Ferromagnetism (p. 517)

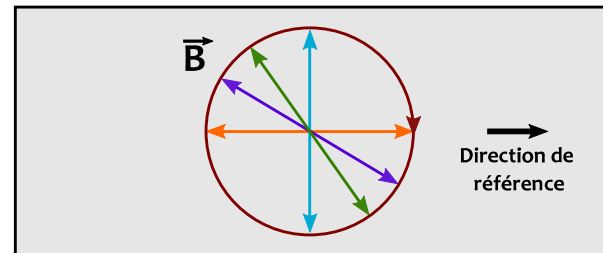

Schematics adapted from : S. Zurek (2017). Characterisation of Soft Magnetic Materials Under Rotational Magnetisation.



# Context : Temperature dependant magnetic properties

$T \nearrow \Rightarrow$

**Thermal agitation**

$W_{th} \nearrow \Rightarrow \vec{m}$  organisation  $\searrow$   
 $B_s \searrow, H_c \searrow, \dots$

$\rho \nearrow \Rightarrow Loss \searrow$

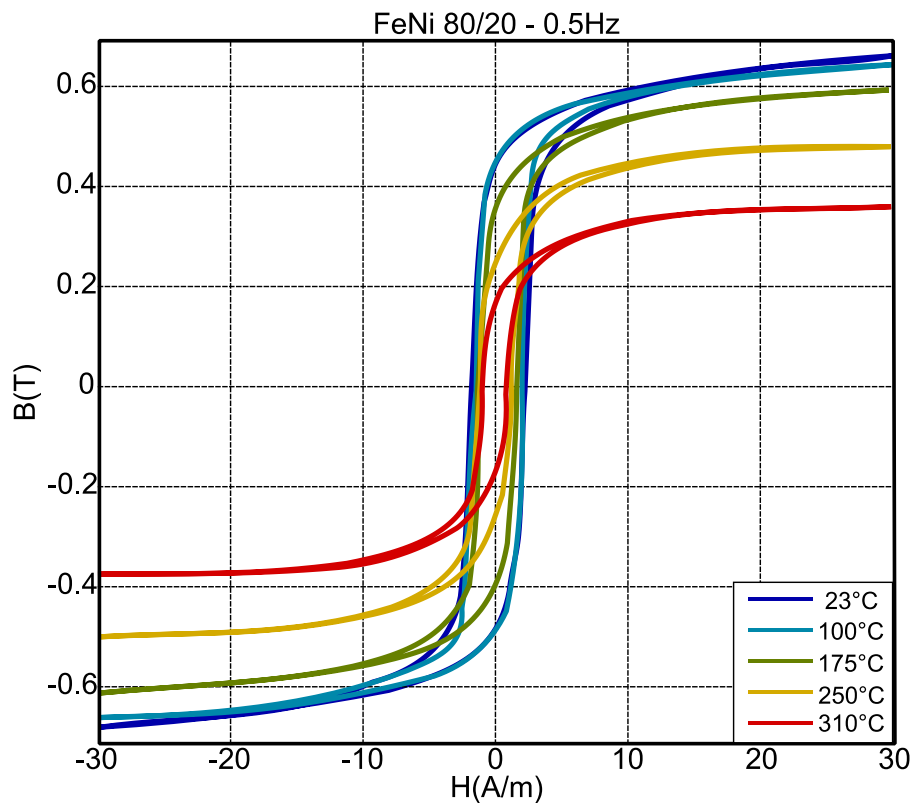

Adapted from : F. Sixdenier et al. (2014). *Caractérisation et modélisation de matériaux et composants magnétiques sous contrainte thermique.*

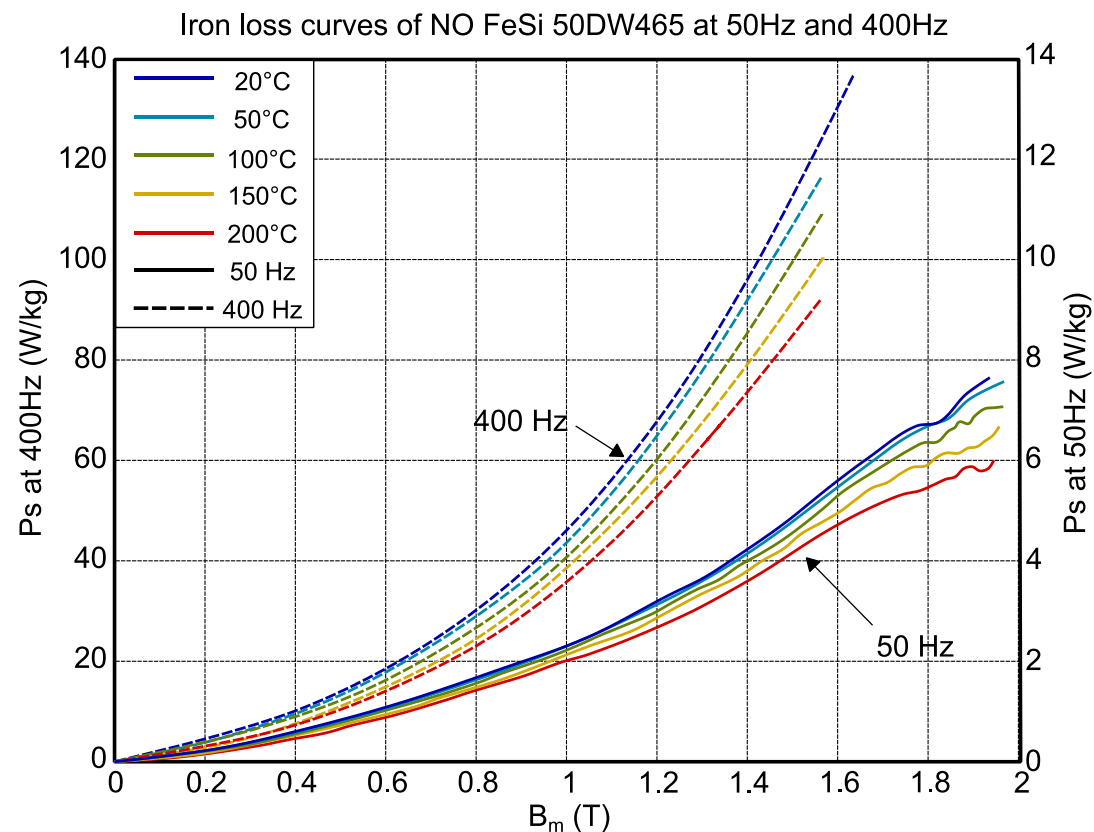

Adapted from : J. Chen et al. (2017), *Influence of temperature on magnetic properties of silicon steel lamination*

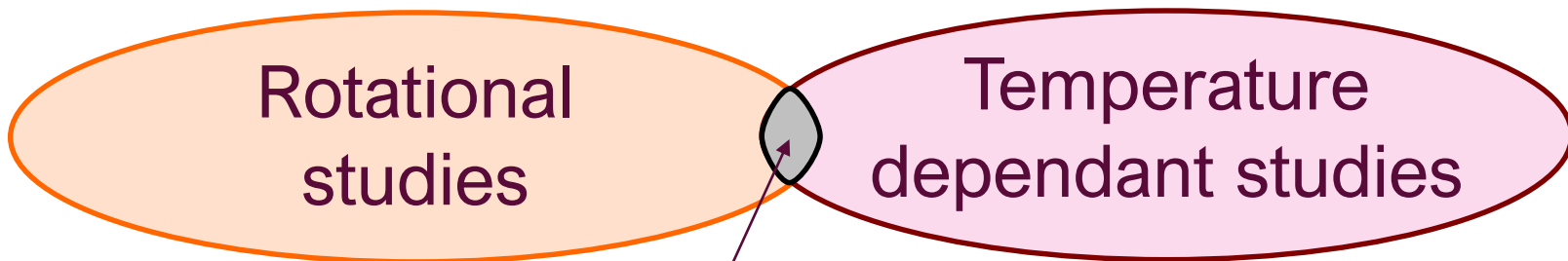

?

Phenomenon

=

Toward material improvement



Data

=

Toward industrial applications & Modelling

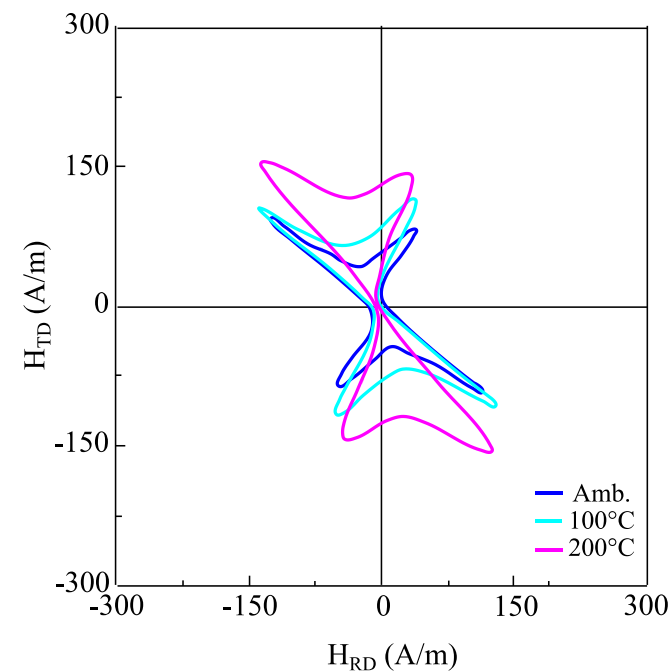
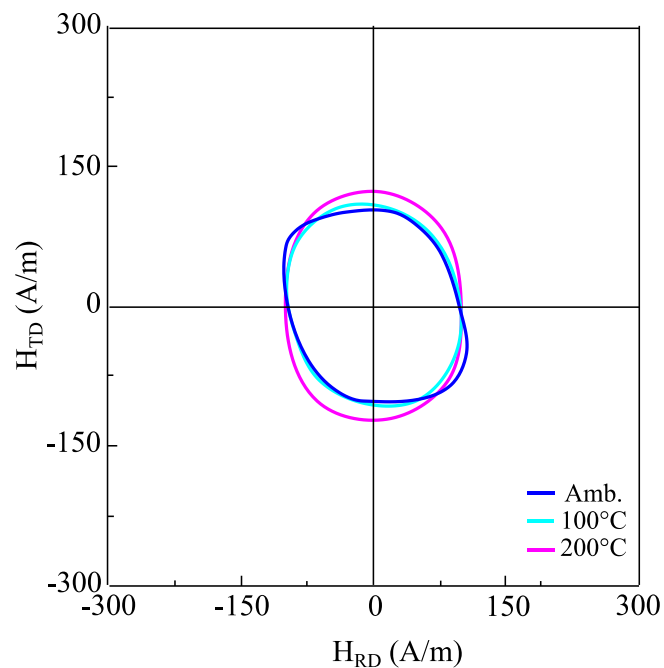

Adapted from : D. Zhang et al. (2022), *Measurement of Stress and Temperature Dependent Vector Magnetic Properties of Electrical Steel Sheet.*

Objective
Temperature dependant 2D characterisations → 20-200°C

1.

Presentation  
of the RSST

2.

Adaptation with  
an heating system

3.

Early results &  
perspectives

# Presentation of the rotational sheet tester

---

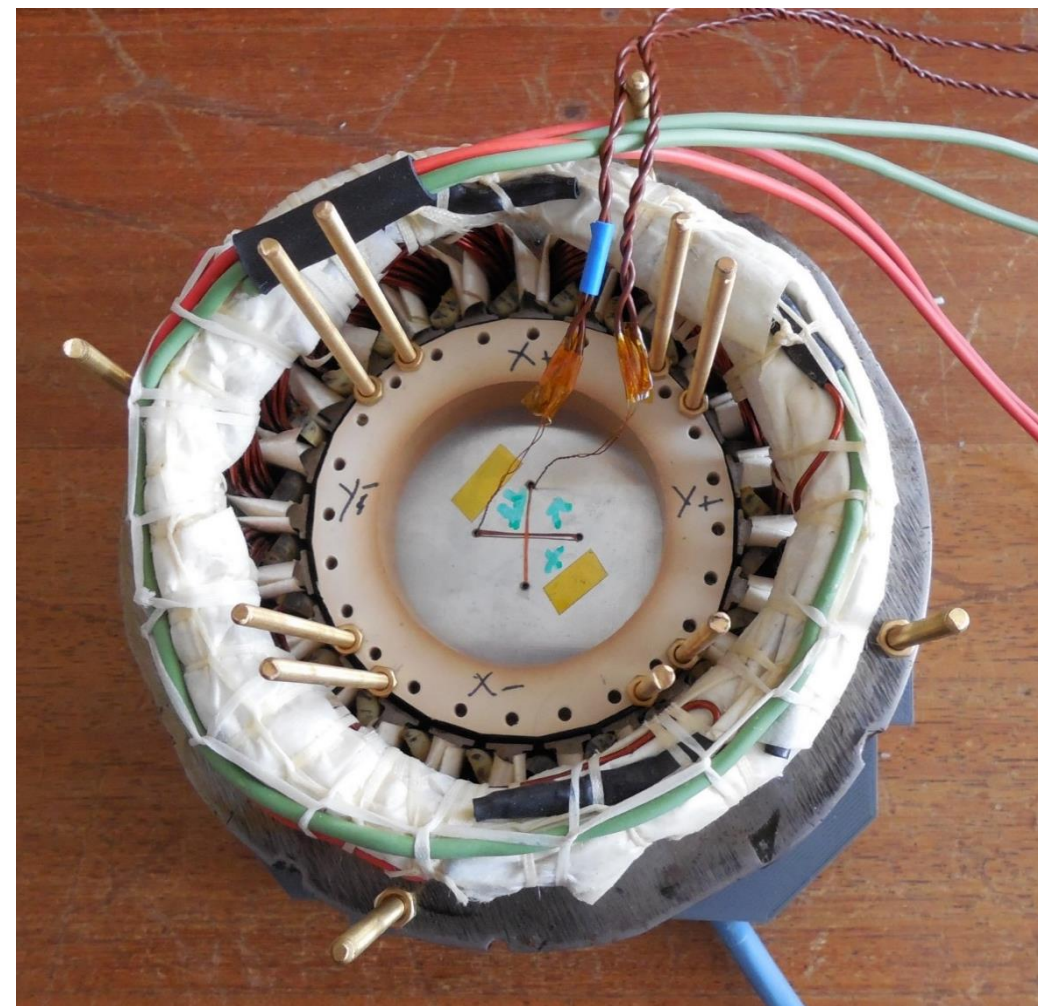
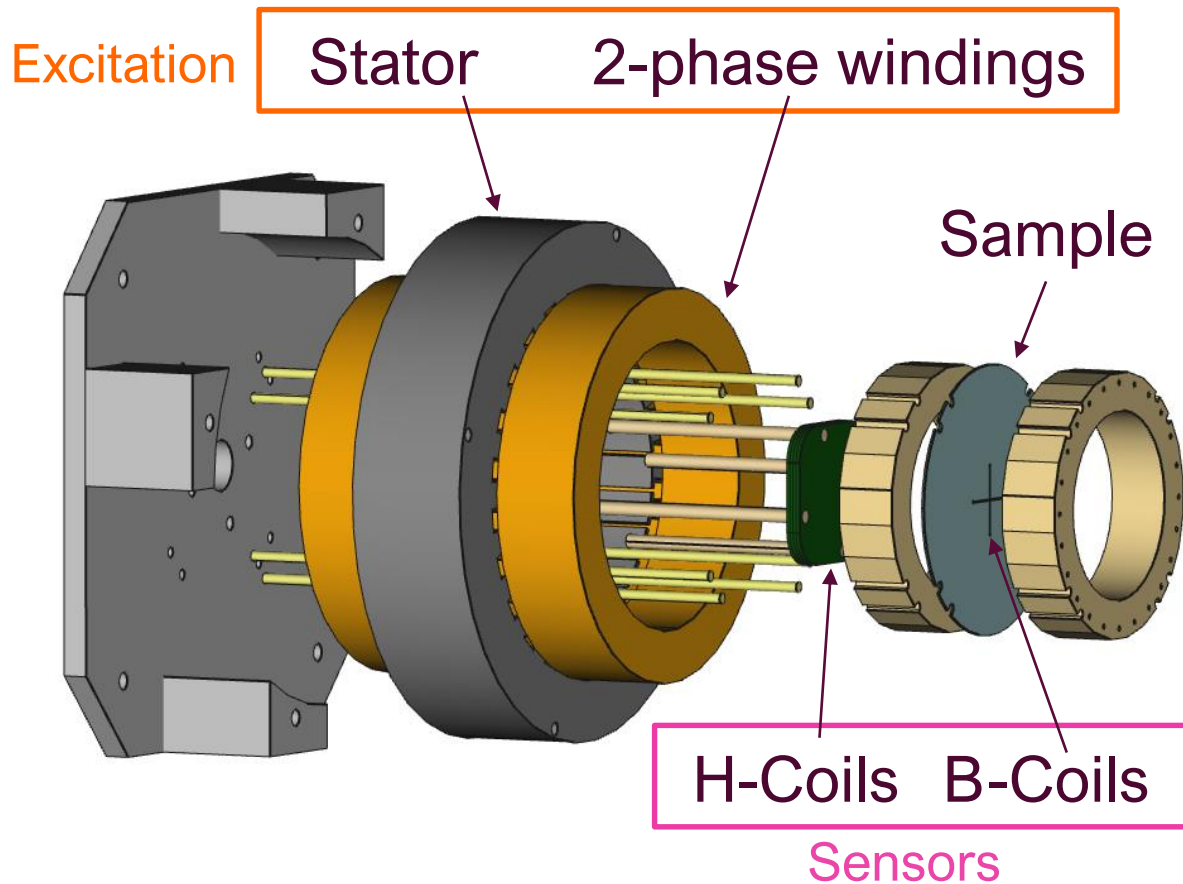



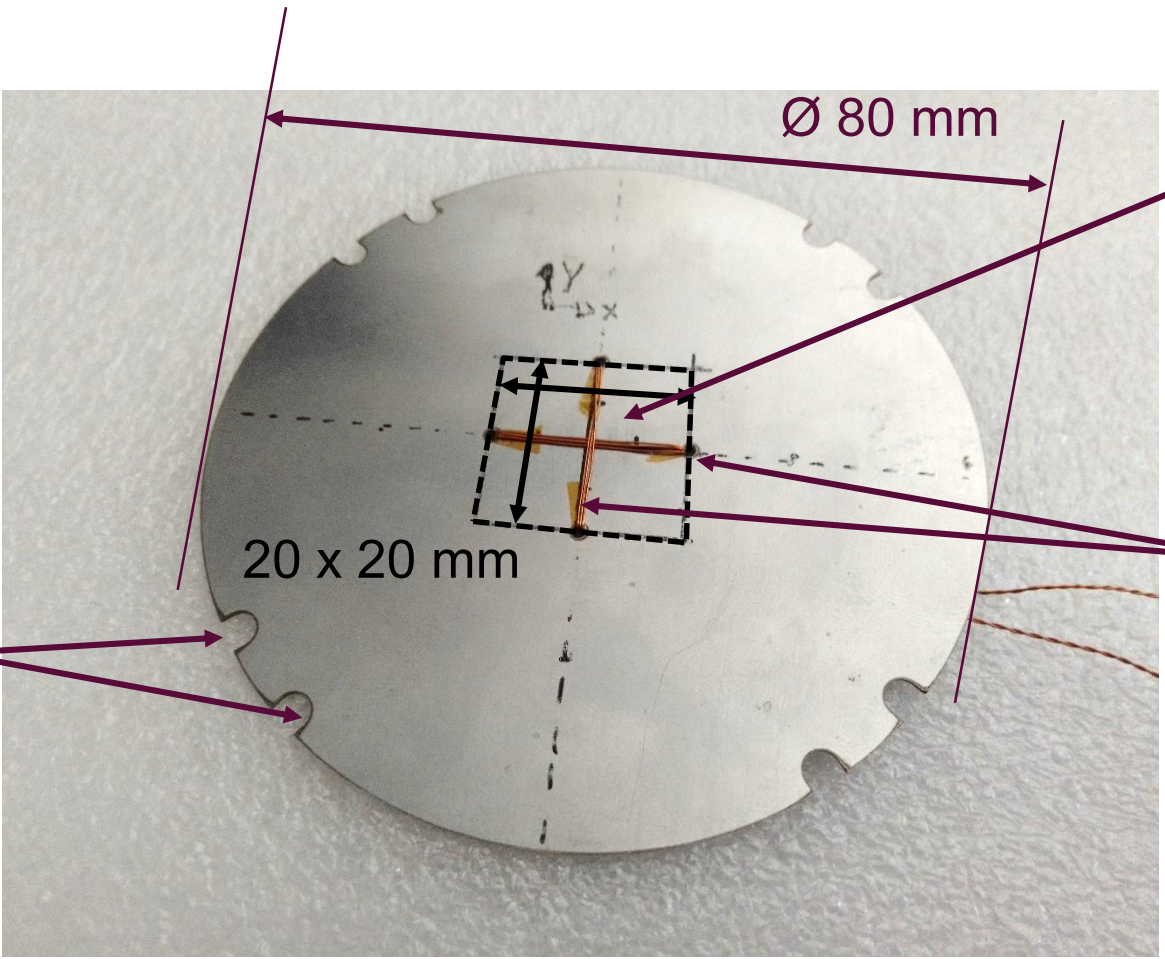

Ø 80 mm

Measurement area

B coils

20 x 20 mm

Positioning notches

Numerical iterative feedback

Noise filtering, averaging, synchronisation to ref.

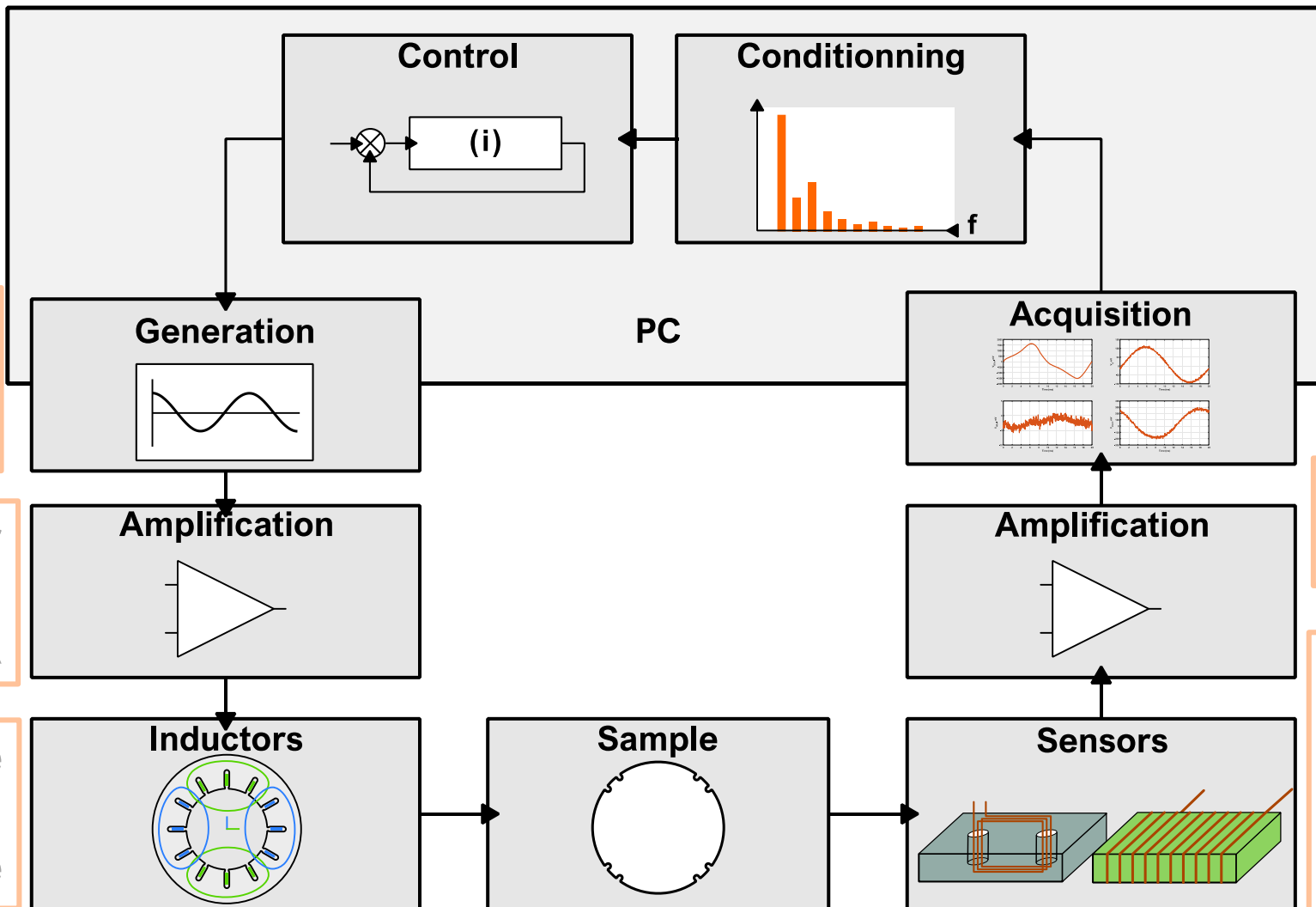

Arbitrary Waveform Generator

Numerical oscilloscope

Power Amplifiers 72V 6A

High bandwidth In-Amp based card

2-phase induction motor core

B : Through-hole coil (1 coil/axe)  
H : PCB Coil, with linear gradient compensation (2 coils/axe)

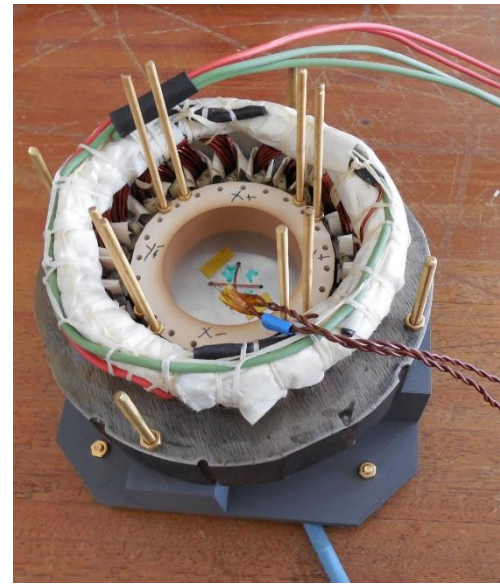
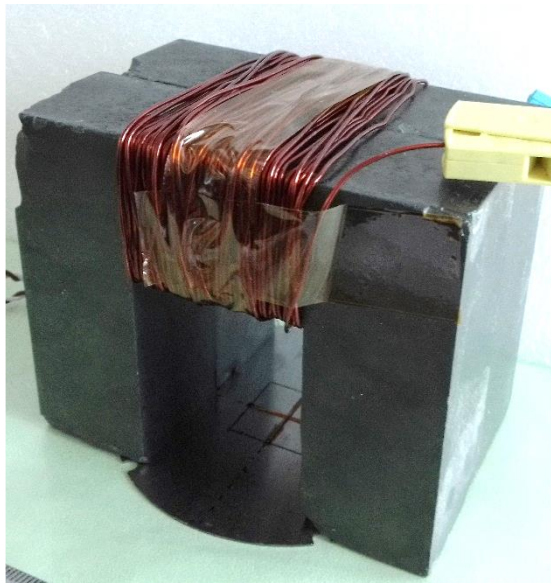
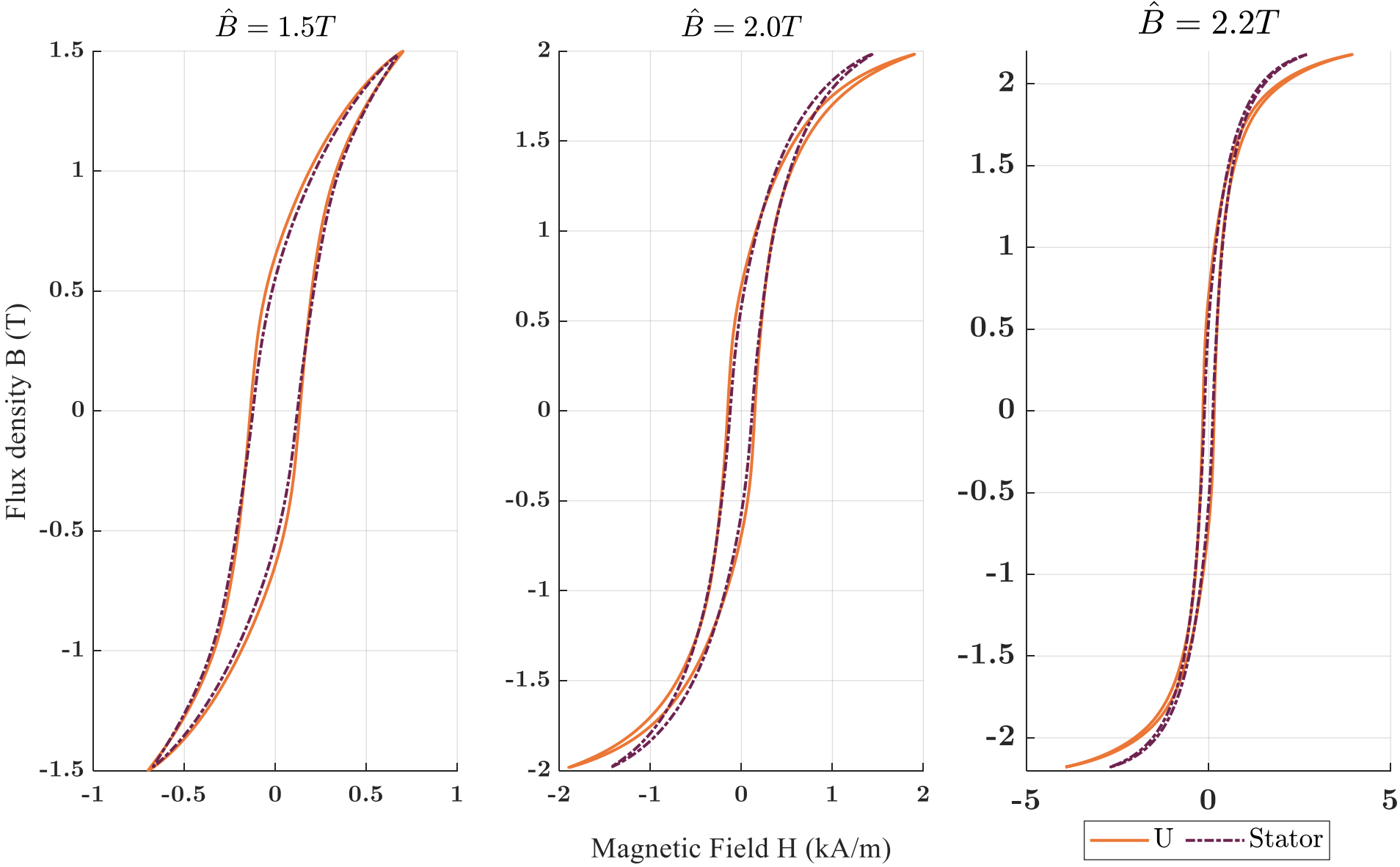

# Temperature control

---

## Adaptation of RSST

No EM interference



No solid metallic part



Caution :  
temperature stability



## Expected capabilities





Target =  
homogeneity



The quicker the  
better

# Choice of an heating system



Method \ Constraints	 Resistive	 Oven	 Blown hot-air
No solid metallic part	-	++	++
No EM interference	-	++	++
Target = homogeneity	+	++	-
Caution : temperature stability	+	--	+
The quicker the better	+	--	+

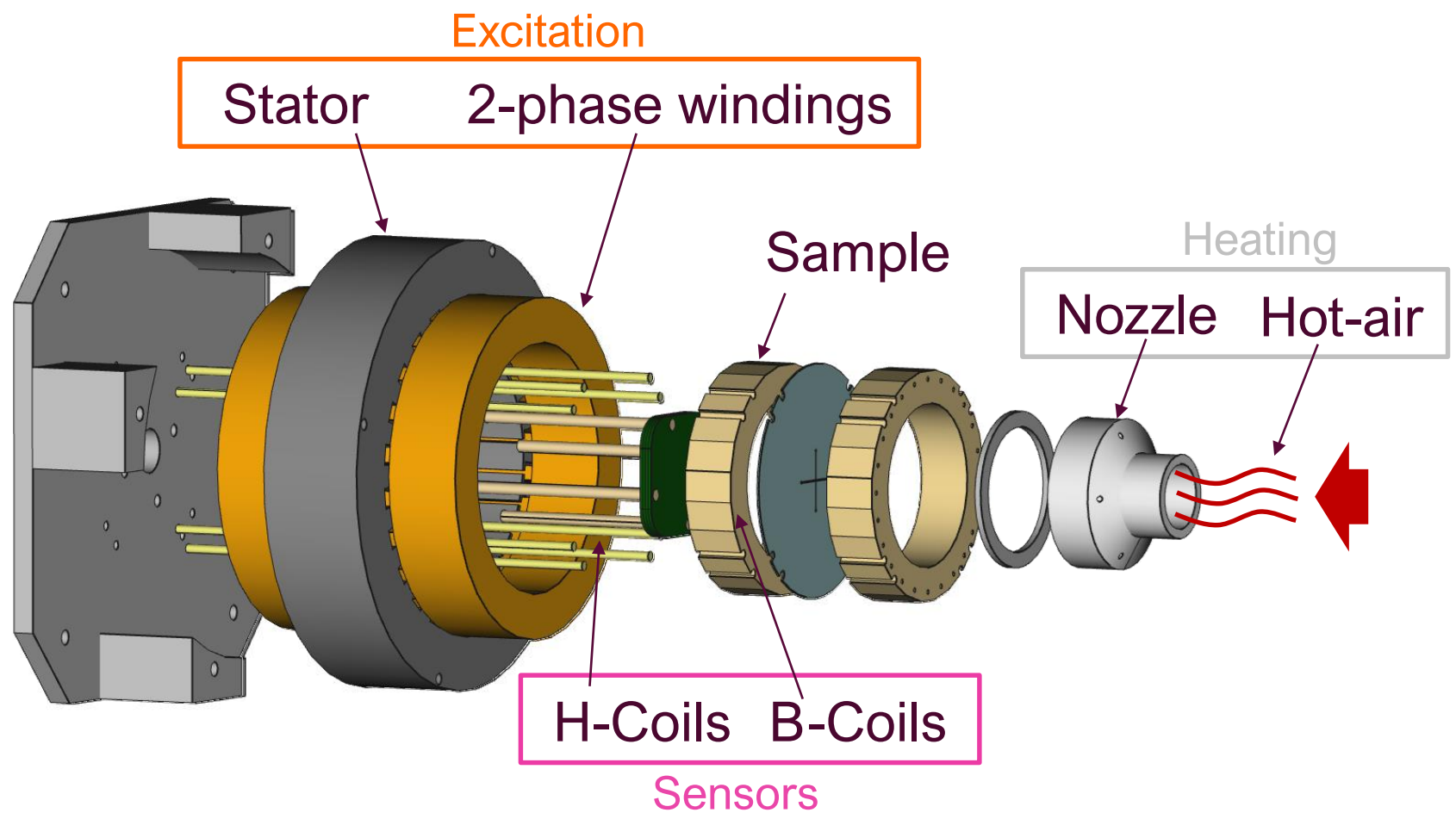

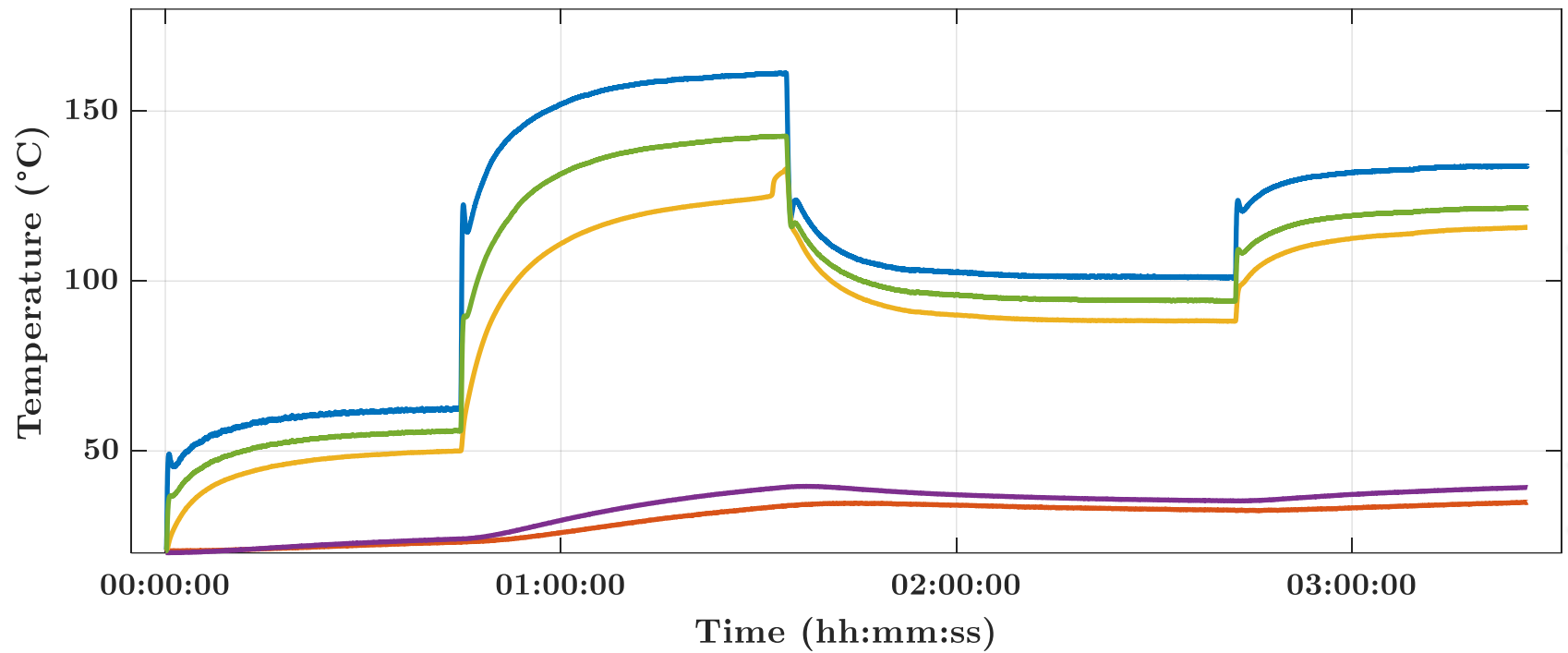

Hot elements :  
Sample, inner part of tooth

« Cool » elements :  
As close as PCB Coil  
Outer part of the stator

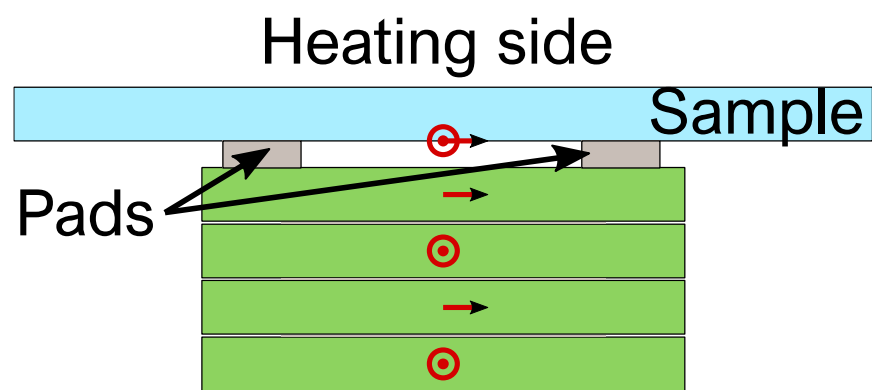



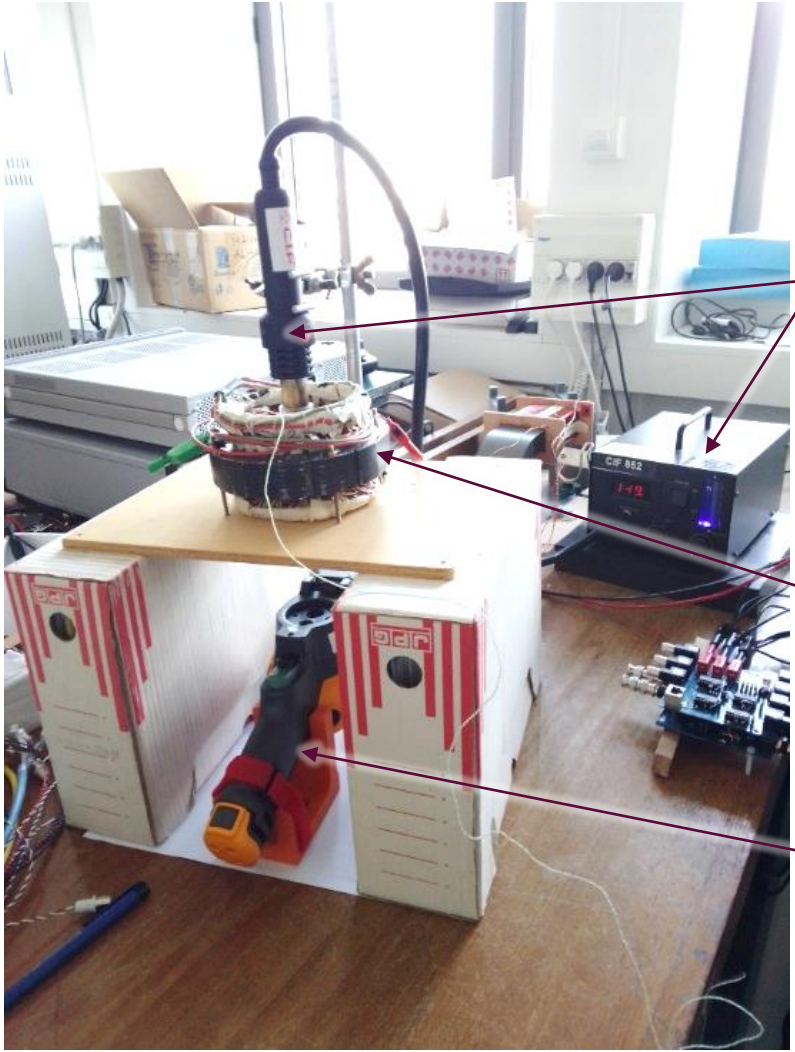

Hot air pump

Systeme (- stand)

IR camera



$\Delta T, STD, \dots$



Hot air -  $T_{air} = 100^\circ C$

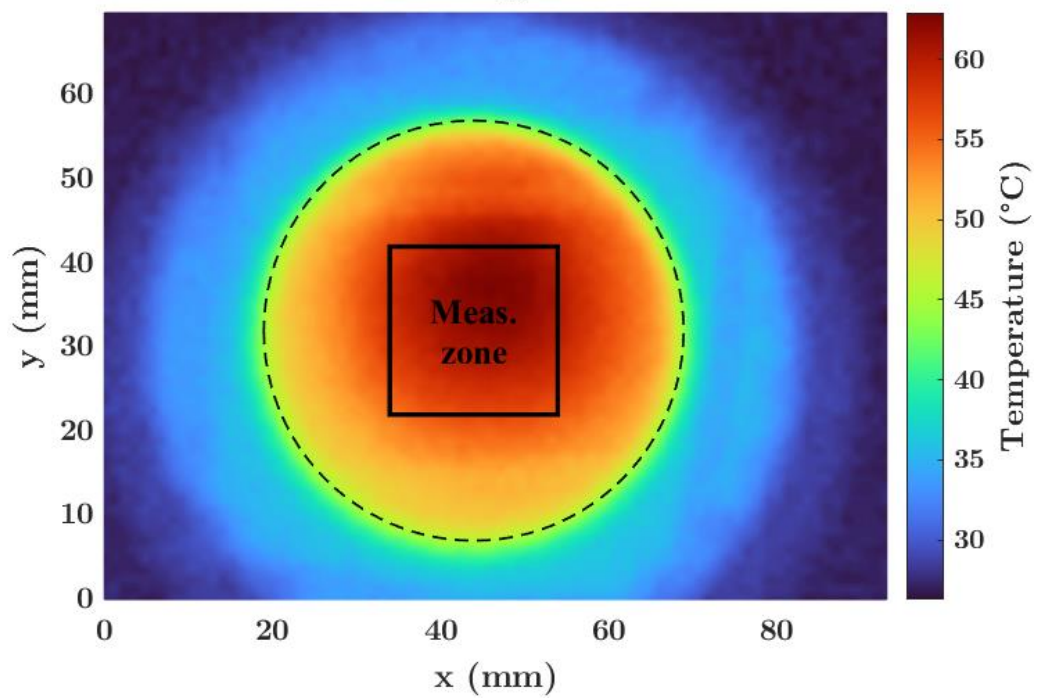

# Assessment of temperature homogeneity

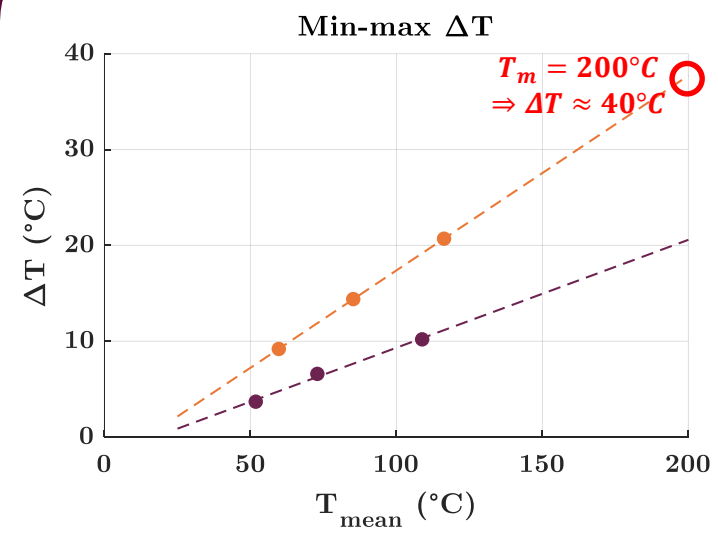
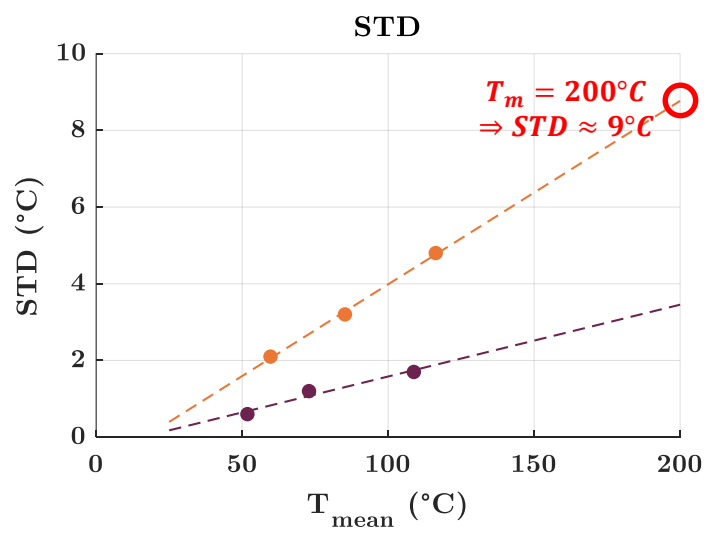
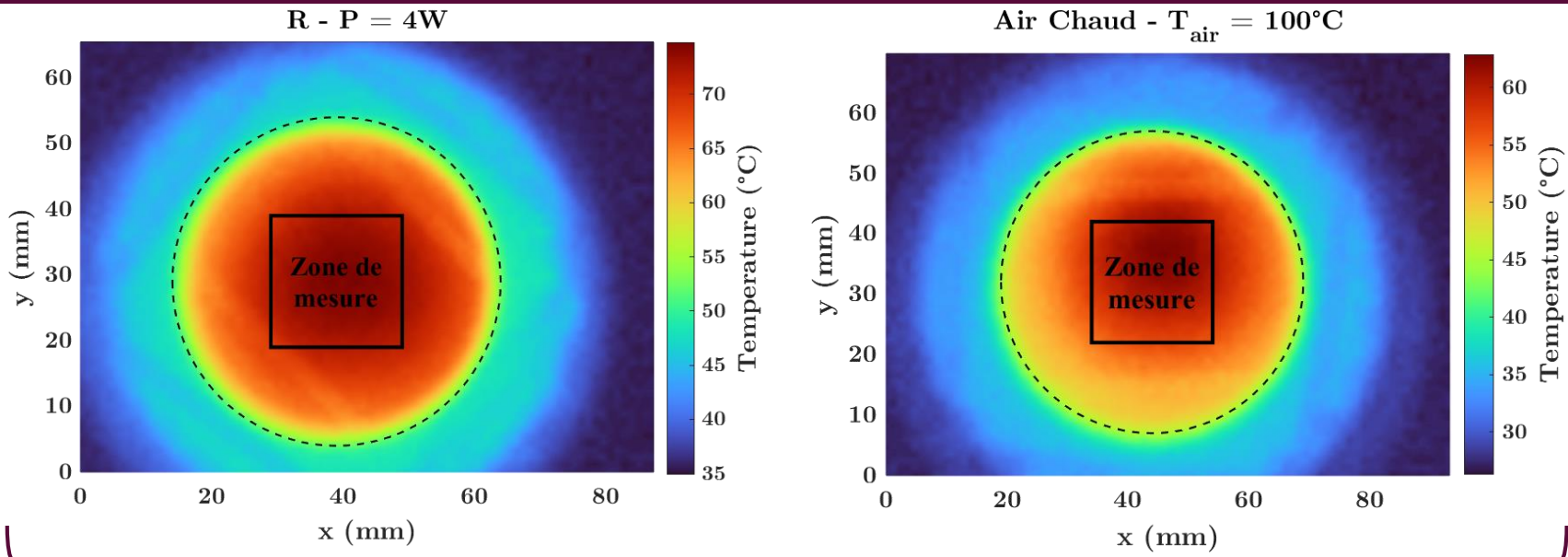

● Air ● R



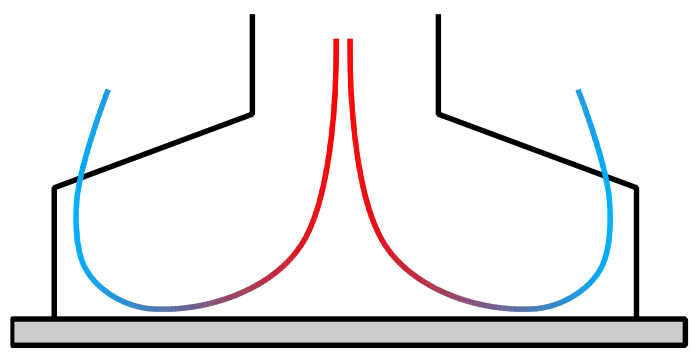

T gradient



Insufficient homogeneity  
( $STD \approx 9^\circ C @ T_{sample} = 200^\circ C$ )



Need for  $T_{air}$ ,  $v_{air}$   
homogeneous across the  
measurement zone

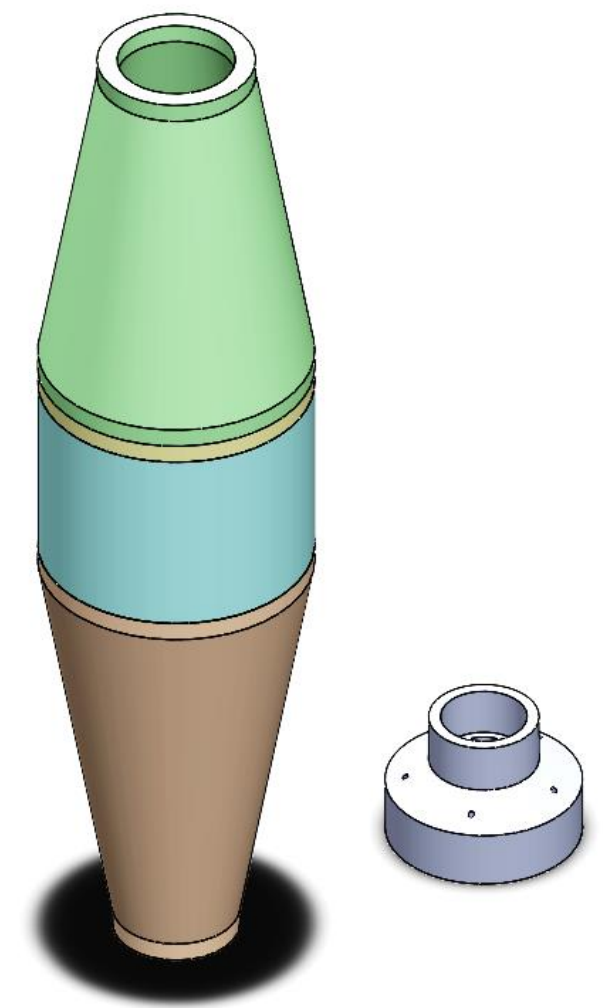
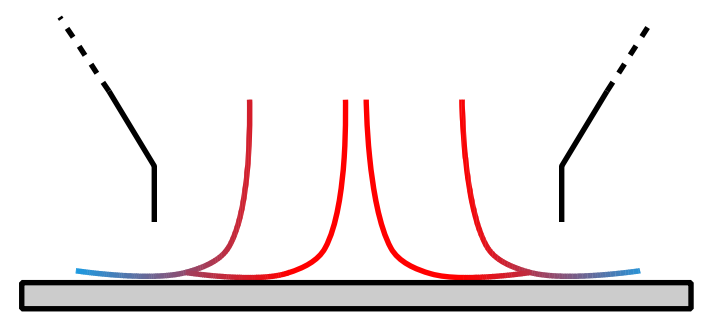

## Example of results

---

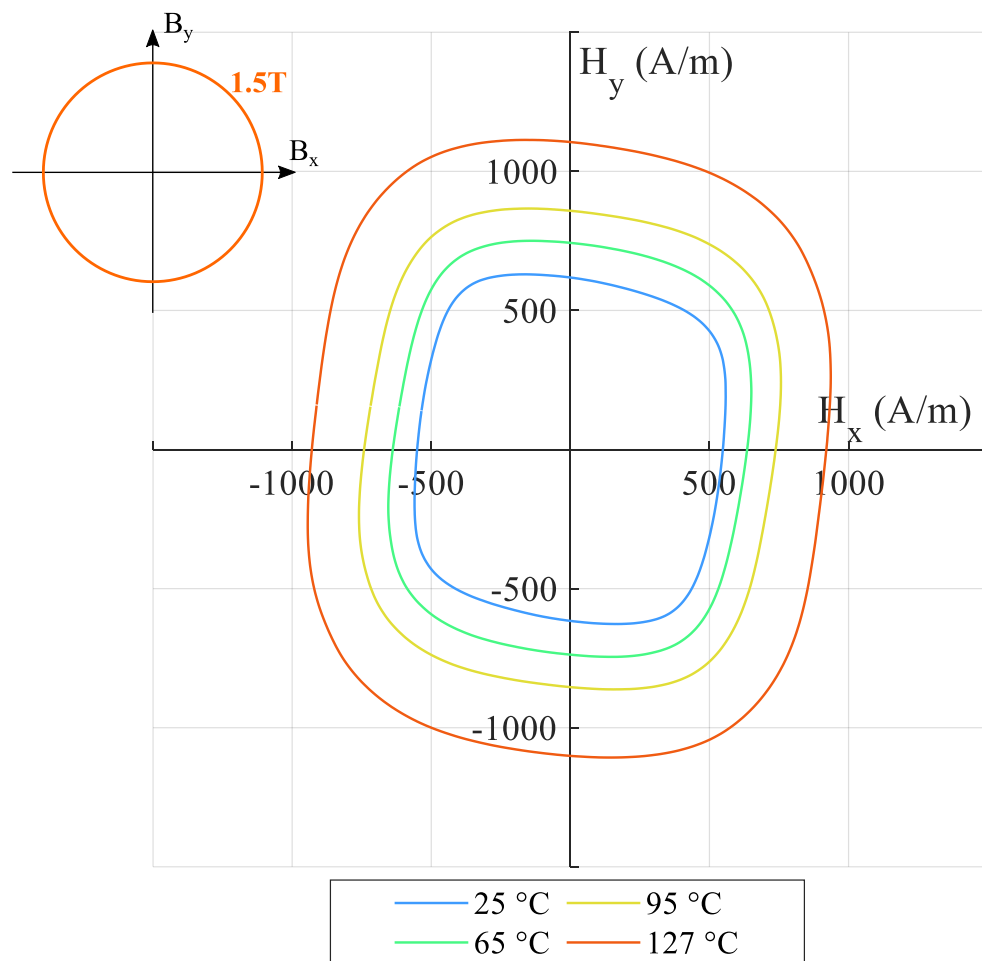

→ « Isotropic » material

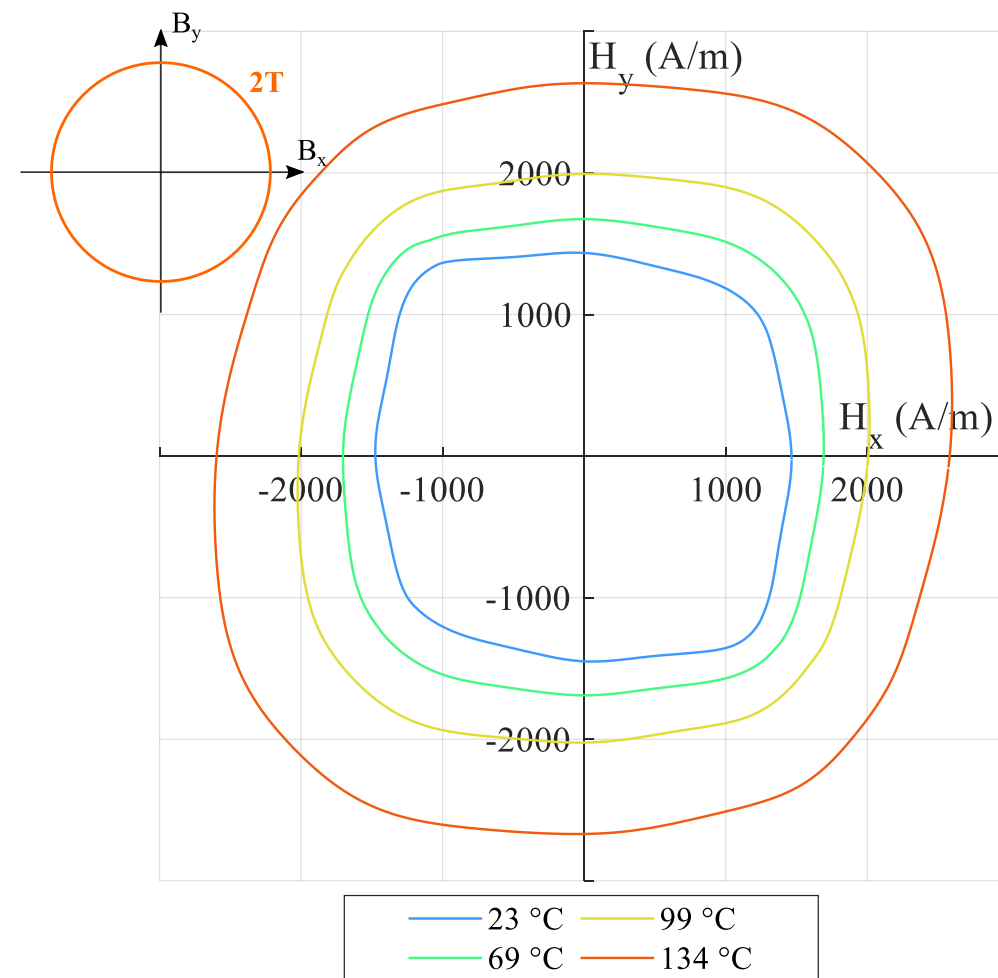

→ Widening of cycles (// 1D skewing)

# Perspectives

---

Bench design & assembly ✓

Control & Software ✓

Heating : Improvement in progress ↻

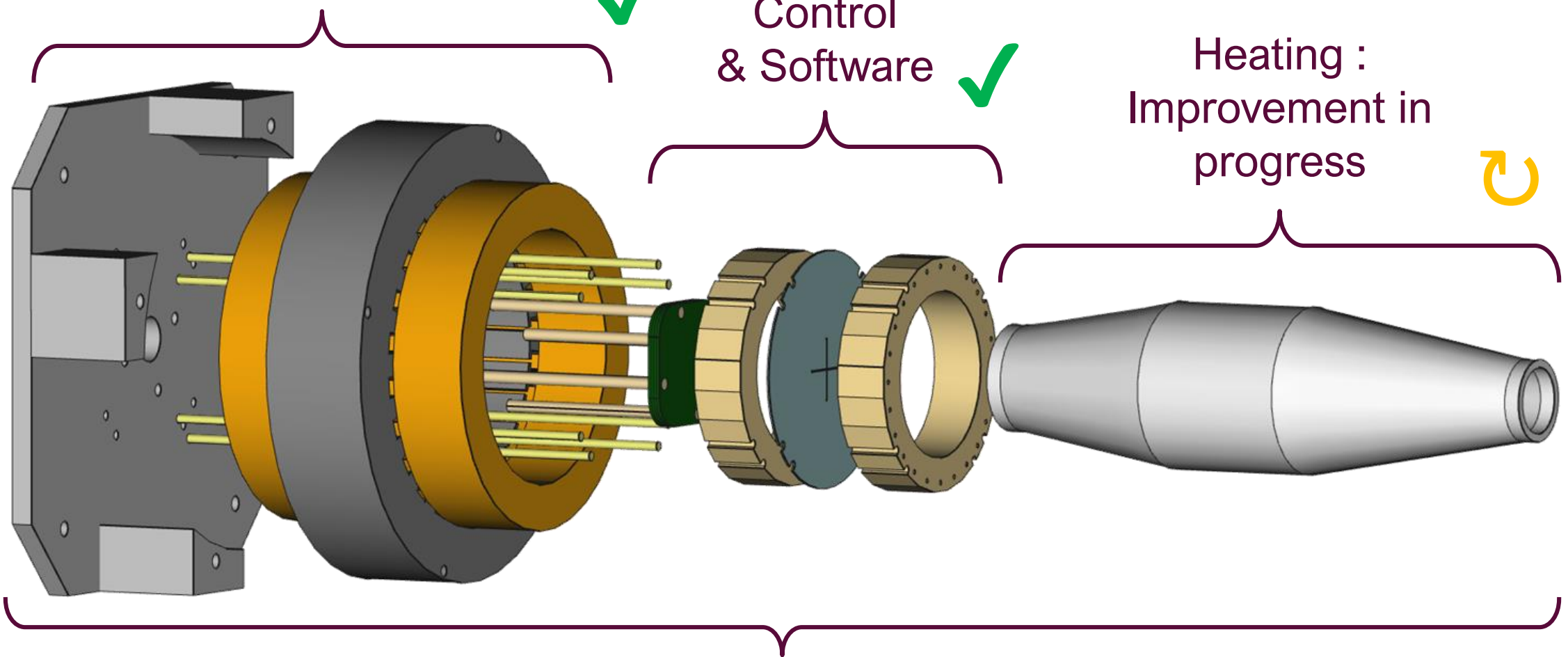

➡ Remaining : Study of temperature dependency of magnetic anisotropy

## Material samples

<b>FeSi</b>	GO and NO
<b>FeCo</b>	Motor core grade
<b>FeNi</b>	High $\mu$
	Low $T_c$

## Test conditions

<b><i>B</i></b>	Material operating point
<b><i>f</i></b>	Around 50 Hz
<b><i>T</i></b>	Across 25 – 200 °C

→ Before September 2023.





**Laboratoire Ampère**  
Unité Mixte de Recherche CNRS  
Génie Électrique, Automatique et Bio-Ingénierie

**Thank you for your kind attention !**  
Questions ?

Clémentine Delaunay



**UNIVERSITÉ  
DE LYON**

Université Claude Bernard  Lyon 1

 ÉCOLE  
**CENTRALE LYON**

**INSA** | INSTITUT NATIONAL  
DES SCIENCES  
APPLIQUÉES  
LYON

