



HAL
open science

The Making of Bikini Glass in Bida, Nigeria: Ethnography, Chemical Composition, and Archaeology

Lesley Lababidi, Abidemi Babatunde Babalola, Bernard Gratuze, Joëlle Rolland, Emmanuel Véron, Aurélien Canizares

► To cite this version:

Lesley Lababidi, Abidemi Babatunde Babalola, Bernard Gratuze, Joëlle Rolland, Emmanuel Véron, et al.. The Making of Bikini Glass in Bida, Nigeria: Ethnography, Chemical Composition, and Archaeology. African Archaeological Review, inPress, 10.1007/s10437-022-09494-6 . hal-03823588

HAL Id: hal-03823588

<https://hal.science/hal-03823588>

Submitted on 28 Oct 2022

HAL is a multi-disciplinary open access archive for the deposit and dissemination of scientific research documents, whether they are published or not. The documents may come from teaching and research institutions in France or abroad, or from public or private research centers.

L'archive ouverte pluridisciplinaire **HAL**, est destinée au dépôt et à la diffusion de documents scientifiques de niveau recherche, publiés ou non, émanant des établissements d'enseignement et de recherche français ou étrangers, des laboratoires publics ou privés.



Distributed under a Creative Commons Attribution 4.0 International License



The Making of *Bikini* Glass in Bida, Nigeria: Ethnography, Chemical Composition, and Archaeology

Lesley Lababidi · Abidemi Babatunde Babalola ·
Bernard Gratuze · Joëlle Rolland ·
Emmanuel Véron · Aurélien Canizares

Accepted: 18 April 2022
© Crown 2022

Abstract This paper discusses the process, prospects, and challenges of making *bikini* glass in Bida (Nupeland), central Nigeria. The Masagá glassmakers of Bida provide the ideal case study for investigating the production of *bikini*. Nineteenth-century Arab and European writings have described glassmaking in Nupeland; however, with the exception of the study carried out by Peter Robertshaw and his colleagues in 2009, there is no work that identifies the raw materials and formula used to produce *bikini* glass. Our recent ethnographic work at Bida provided the opportunities to collect raw glass, beads, and unfused raw material for *bikini* glass as well as vitrified furnace wall fragments for analysis. We present results of binocular observation and chemical compositional analysis conducted on the raw materials, glass products,

and furnace remains to understand the mineralogical and chemical characteristics of various materials connected with the production of *bikini*. From the manufacture of glass to that of glass ornaments, bracelets, and beads, the documentation of the work of Masagá glassmakers provides new data for the history of glass and its techniques. This information is relevant for understanding glassworking in the past. The paper also addresses issues relating to migration, technology transfer, and culture contact between Nupeland and its neighbors in the Lower Niger region. It argues that the investigation of the production of *bikini* glass in Bida is essential for expanding our knowledge of the archaeology of glassmaking and glassworking in Sub-Saharan Africa and beyond.

Archaeological time period: 11th–15th CE and 18th CE to present

Country and region discussed: Central Nigeria, West Africa

L. Lababidi
Lagos, Nigeria

A. B. Babalola
University of Cambridge, Cambridge, UK

A. B. Babalola (✉)
The British Museum, London, UK
e-mail: Ab2577@cam.ac.uk

B. Gratuze
Institut de Recherche sur les ArchéoMATériaux Centre
Ernest-Babelon, UMR 7065 CNRS/Université d'Orléans,
Orléans, France

J. Rolland
UMR 8215, Trajectoires, CNRS, Paris, France

E. Véron · A. Canizares
UPR 3079, Conditions Extrêmes et Matériaux: Haute
Température et Irradiation (CEMHTI), CNRS, Université
d'Orléans, 45071 Orléans, France

Résumé Cet article traite de la fabrication du verre bikini, par les verriers Masagá de Bida (au royaume Nupe dans le centre du Nigeria), dans toutes ses dimensions: historiques, techniques et symbolique. Si la fabrication du verre au Royaume Nupe est décrite par des récits arabes et européens du XIXe siècle, à l'exception de l'étude menée par Peter Robertshaw et ses collègues en 2009, aucune étude ne s'est intéressée aux recettes (matières premières et procédés) utilisées pour produire le verre bikini. Lors de notre récent travail ethnographique à Bida nous avons eu l'opportunité de collecter et d'analyser du verre brut, des perles, de la matière première non fondue utilisée pour fabriquer le verre bikini ainsi que des parois de four vitrifiées. Cet article présente les résultats des différentes analyses effectuées sur ces matériaux, afin d'identifier leur nature (compositions chimiques et minéralogiques) et leur rôle dans la fabrication du verre bikini. La confrontation de ces résultats analytiques aux observations effectuées sur place lors de fabrication du verre brut, des ornements (bracelets et perles), et de la documentation du travail des verriers de Masagá fournit de nouvelles données, aux études portant sur l'histoire du verre et de ses techniques, qui s'avèrent pertinentes pour comprendre le travail du verre dans l'Antiquité. L'article aborde également les questions relatives à la migration, au transfert de technologie et au contact culturel entre le Royaume Nupe et ses voisins de la région du Niger inférieur. Il montre

que l'enquête réalisée sur la production de verre bikini à Bida est fondamentale pour élargir nos connaissances sur l'archéologie du verre (fabrication et mise en œuvre) en Afrique sub-saharienne et au-delà.

Keywords Glass making · Glass working · Indigenous technology · Bida · Nigeria · Ethnography

Introduction

At the crossroads of west-central Nigeria, the Nupe city of Bida is situated on the Lanza River, a tributary of the Niger River, and is located near the Benue and Kaduna rivers, which form interconnecting arteries of communication (Fig. 1). The city is located at the juncture of the savanna and Sahel regions, an area where movement and circulation of technology, commerce, and religion have occurred for centuries. The indigenous inhabitants of Bida are Nupe. Oral traditions link the origins of the Nupe polity to a legendary hero, Tsoede, whose memory is still preserved in the kingmaking ritual in Nupeland (Weise, 2003). There is a cross-fertilization of cultural influences between the Nupe and their neighbors—the Yoruba in the south and Hausa and Fulani in the north. These influences can be seen in religion (Islam), language, and traditional industries. Glassmaking is one

Fig. 1 Bida and other places mentioned in the text

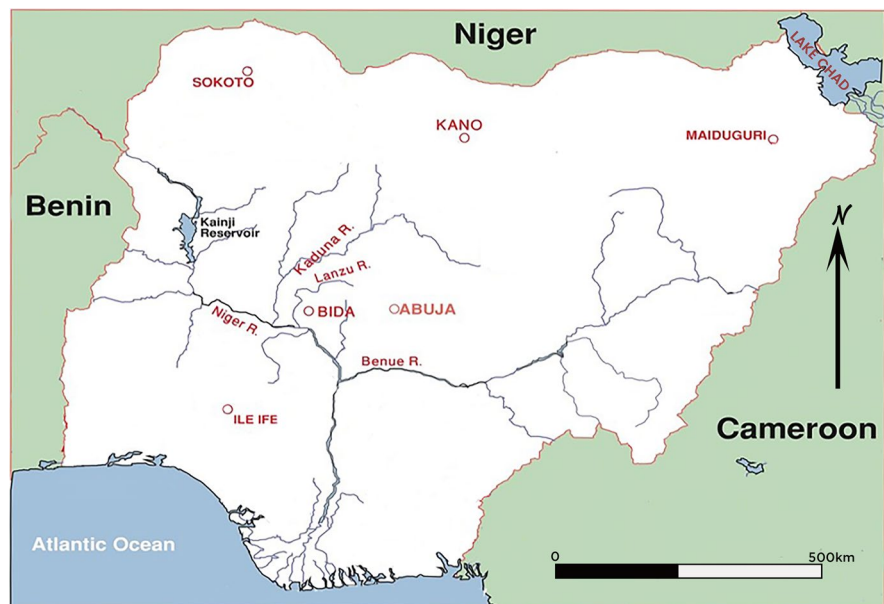

of many crafts known in Nupeland, but it is found mostly among the Masagá (a Nupe subgroup).

The Masagá glassmakers are custodians of a glass production method that remained a secret for two centuries. The cooperative guild in charge of the glassmaking is composed of a closed membership within the greater Nupe ethnic group. The Masagá distinguished themselves from the other Nupe subgroups by claiming their ancestors immigrated from Egypt. According to their oral tradition, the Masagá glassmakers of today are the direct descendants of a band of eighteen glass artisans who emigrated from Egypt to northern Nigeria and settled in Bida during the reign of Tsoede (Bowen, 1857, p. 199; Nadel, 1942, p. 275; Thomas-Emeagwali & Idrees, 1992, p. 138).

The Masagá produced raw glass before the appearance of European glass bottles in the Nupe region during the late nineteenth century. According to oral traditions, the glassmakers who arrived in Bida from Egypt brought their glassmaking knowledge and came with cullet, slag, and molten glass to be used as a starter. This story is echoed by the Masagá glassmakers interviewed between 2015 and 2019 for this study. These accounts claim that their ancestors brought with them *tswanbi*, one of the ingredients necessary to make *bikini* glass. In the Nupe language, *tswanbi* means “fire gang,” remnants of melted glass/raw materials that fall inside the furnace.

The Masagá call a locally made raw glass *bikini*, while the glass made from recycled bottles is called *kwálaba*, meaning bottle (Nadel, 1940, p. 85–86). Although the word, *kwálaba*, is related to the Arabic word *qalab*, “mold,” it is not enough evidence to legitimize the Egypt migration story. *Bikini* and *kwálaba* correspond to important differences in production methods observed at Bida, affirming primary and secondary glassmaking, respectively. Before recycled glass objects were readily available, the *bikini* was produced in a workshop and then delivered to a secondary workshop, where it was re-melted to make glass objects such as beads and bracelets (Nadel, 1940). However, in the last few decades, primary production and secondary production have been carried out within the same workshop structure called *estwa*.

This article discusses *bikini* glassmaking in the past five decades, based on a reenactment study and

laboratory analysis. Results of the chemical analysis of the products from the reenactment of glass production and raw materials are presented. Although archaeological evidence of early glassmaking is absent in Nupeland, we discuss the implications of the reenactment of *bikini* glassmaking in Bida for the archaeology of glass in Sub-Saharan Africa and draw out the uniqueness of the techniques of glass jewelry making in Bida from a global perspective.

Investigating Glass Production in Sub-Saharan Africa and Bida

Glass production could take two forms: primary production (glassmaking) and secondary production (glassworking). The former involves gathering raw materials, including silicate material—sand or stone, alkali—sodium or potassium (as flux), and alumina or lime (as stabilizers), to make glass. The latter comprises the fabrication of diverse objects from an existing glass material in either a re-melting process or a process involving the cool working of glass (Henderson, 2013; Shortland & Rehren, 2020). Among ancient societies, primary and secondary production could co-occur in the same workshop or be carried out in different workshops, either in the same vicinity or far apart (Henderson, 2000). Most glass studies in Africa focus on glass beads to understand the nexus of distribution and consumption. Fewer efforts have investigated glass/glass bead production in Sub-Saharan Africa. Discussions of primary glass production have centered on North Africa, particularly Egypt, where evidence of glassmaking is dated to the second millennium BC (e.g., Lilyquist & Brill, 1993; Nicholson, 2007; Rehren, 2014; Rehren & Pusch, 2005). Evidence of primary glassmaking emerged only recently in Sub-Saharan Africa from eleventh- to fourteenth-century AD contexts at Ile-Ife, southwest Nigeria (Lankton et al., 2006; Babalola, 2017; Babalola et al., 2018a, b, 2020).

Unlike glassmaking, secondary glassworking seemed to have occurred earlier in Sub-Saharan Africa, from the mid-first millennium AD. The occurrence of abundant glass waste and shards at Chibuené—a port in southern Mozambique actively involved in the Indian Ocean trade—suggests possible glassworking in the form of recycling of imported glass between the sixth and tenth centuries AD

(Wood et al., 2012, p. 69). Between the ninth and twelfth centuries, glassworking was practiced within the great house at Gao, Mali, where glass beads of the Islamic world were modified (Cisse et al., 2013). Susan McIntosh and her colleagues have suggested the possibility of glassworking at Igbo-Ukwu in the form of local modification of imported glass beads (McIntosh et al., 2020). New studies are now unveiling glassworking among the Swahili communities of Eastern Africa (Rodland, 2022; Wood et al., 2022). The discovery of a workshop feature with copious glass beads and the new bead series at Mkokotoni raises the possibility of secondary glassworking and beadmaking during the early second millennium AD in the Swahili Archipelago (Rødland, 2022). The Garden roller glass beads are also believed to have been locally made in southern Africa from imported glass or beads from the tenth to the fifteenth century (Davison, 1972; Wood, 2016) and probably continued until the nineteenth century (Prinsloo et al., 2011).

Archaeological evidence has shown that secondary glassworking, although more widespread than primary production in Sub-Saharan Africa, occurred from the mid-first millennium through the mid-second millennium AD. By the end of the second millennium, there was an increase in secondary glassworking activities partly due to the influx of European goods. Locally made glass beads became widespread and were traded within the sub-continent (Babalola, 2019; Decorse, 1989; Decorse et al., 2003). Historical records and ethnographic accounts documented more cases of glassworking in Sub-Saharan Africa from the nineteenth through the early twentieth century (e.g., Nadel, 1940, 1942). What do we know about the archaeology of glass in Nupeland? Unfortunately, only a few archaeological investigations have been conducted in the Nupe region of Nigeria (Abubakar, 2021; Aiyedun & Shaw, 1989), and none of them has revealed evidence for the antiquity of glassmaking or glassworking in the region despite the rich historical account of glassmaking/working in Bida (Nadel, 1940).

Since the mid-nineteenth century, reference had been made to glassmaking in Nupeland, particularly at Bida. This locally-made *bikini* is characteristically black and shiny. The earliest mention of a glassmaking community in Nupeland in historical sources came from Thomas Jefferson Bowen, an American Christian missionary, who wrote in 1856 that “the Nufes [Nupe] are allied by their language to

the Yórubas...they are said to be the only people in Sudan who still retain the art of manufacturing glass.” He continues, “So far as I could ascertain, the peculiar glass manufacture of Central Africa is confined to three towns in Nufe, one of which is situated on the west of the Niger” (Bowen, 1857, p. 309). Leo Frobenius, a German explorer, and ethnologist, also mentioned Nupe glassmaking. In 1912, he wrote: “we have now reached the brook which divides our quarter of the town from the Massaga’s, the workers in glass” (Frobenius, 1913, p. 433). Similarly, anthropologist S. F. Nadel notes in the 1940s that “the Masagá nevertheless still produce their own glass as well. A certain type of glass, black in color and of rather crude texture, which is bought widely in Nigeria, is made exclusively by the traditional method” (Nadel, 1942, p. 274–5). René Gardi, the Swiss traveler and author, wrote in 1969 about the secrecy around making *bikini* glass: “Our friends in Bida willingly showed us their work techniques. We went in and out whenever we pleased. We photographed and filmed, but there was one thing they did not show us: the making of glass for their own use” (Gardi, 1969, p. 102). The Masagá use the word *bikini* interchangeably to refer to raw glass (cullet) and manufactured glass products.

These historical accounts have established evidence of continuous glassmaking in Nupeland, at least from the nineteenth century. The Masagá craftspersons made *bikini* before the importation of glass bottles into Nupeland. The *bikini* was the main raw material for glassworking, but due to the expense and difficulty of sourcing the raw material, primary glass production declined and was replaced by recycled imported glass and bottles. The re-melting of recycled glass was a time-saving innovation, and the European bottles introduced a variety of colors, resulting in highly marketable products (Nadel, 1940, p. 86). Eventually, the popularity of recycled glass eliminated the necessity to produce molten glass. The techniques, technology, and craftsmanship to make *bikini* gradually receded from the collective memory of Masagá glassmakers. Thus, the main objective in researching *bikini* glass was to recreate its production, and study the technological process, and the social and religious activities connected with the process. As such, a comprehensive investigation was mapped out to recognize and interview all stakeholders—traditional leaders, Masagá cooperative society members, craftsmen, religious leaders, apprentices,

youth, academics, and government representatives. Each stage of glass production—gathering raw materials, construction of furnaces, materials, production, annealing, and distribution—was monitored and recorded. Samples of the *bikini* produced, cullet, dry mixed raw materials (sandy earth, flux, and *tswanbi*), and fragments of the furnace wall were collected for compositional analysis. Except for the limited note on spectrographic and experimental work conducted by C. G. Seligman and P. D. Ritchie in the 1940s (Nadel, 1940, p. 86) and Robertshaw's 2009 chemical analysis of Bida glass from the collection of the Linden-Museum in Stuttgart, Germany, no analysis of *bikini* glass had been conducted before now. Hence, the results of the elemental analyses discussed here are the first for *bikini* glass from a primary workshop. Similarly, we provide the first ethnographic account of *bikini*-making in several decades.

Re-enactment of Bikini Making and Glass Jewelry Production

Methodology

The fieldwork for the ethnographic study was conducted over several visits to Bida between 2015 and 2019 by one of us (Lababidi). The reproduction of the *bikini* was conducted from November 7 through 27, 2019. Prior to the reproduction, all the necessary people relevant to the process were mobilized, and raw materials were acquired. The stimulus for researching the Masagá glassmakers came from the information that primary glass had not been produced for over 50 years in Bida. Alhaji Abdulazeez Yanko, a Masagá elder, narrated that the last production of *bikini* glass was during the reign of Etsu Muhammadu Bakudu Ndayako, 1935–1962 (oral interview, 2019). Alhaji Yanko was the only surviving person who had worked in primary glass workshops and still retained the knowledge of the production at the time of the research in November 2019. Every step in the production was digitally documented, from making the *bikini* furnace and fetching glass from the bottom of the furnace to making glass objects. Besides the *bikini* reproduction, many people were interviewed, including the Etsu, His Royal Highness Alhaji (Dr.) Yahaya Abubakar, CFR, who permitted us to carry out the study. Other people or groups of people

interviewed were Bida Palace traditional dignitaries, traditional rulers of the Masagá glassmakers' community, executives of the Masagá Glassmakers Cooperative Society, the craftsmen, the bellow operator (who are mostly youth), a blacksmith, and religious leaders. As with the *bikini* reproduction, all the interviews were video-recorded with the permission of all parties involved. The questions asked were targeted at eliciting information on the history, development, and production of *bikini* and glass objects in Bida and the use, function, and meaning of the glass objects. Emphasis was placed on the types and sources of raw materials for *bikini*. However, all the interviewees avoided answering this question as the acquisition and processing of the ingredients are considered secretive. Parts of the data collected from the ethnographic exercise have been put together in a documentary "The Lost Legacy of Bida Bikini" (https://drs.britishmuseum.org/articles/media/Lost_legacy_of_Bida_Bikini/14535420). The raw footage will be deposited in an online open-access platform of the British Museum's Endangered Material Knowledge Program.

The discontinuity of *bikini*-making in Bida for almost six decades hampered scientific research on the understanding of the technology. Thus, Robertshaw et al. (2009, p. 94) have noted that "If we are to learn more about Nupe glass manufacture, particularly the chemistry of *bikini* glass, an experimental approach involving the collaboration of masagá craftsmen is needed." This statement, in part, has driven this latest research at Bida. A detailed description of the ethnographic work is in preparation for publication elsewhere. Here we provide a summary for contextualizing archaeological glass technology. Readers are also referred to the work of Nadel (1940, 1942), who visited and documented the process of glassmaking and glassworking in Nupeland in the mid-twentieth century.

Primary Production (Bikini Making): Technology, Workshop, and Raw Materials

The site or place of production of both *bikini* and *kwálaba* is called *estwa* in Nupe, literally "workshop." *Bikini* production was a collective effort and involved the participation of every household. In the Masagá community, every family usually had an *estwa* at the entrance of the family compound. During

the early twentieth century, an interviewee mentioned that there were no fewer than ninety-nine functioning workshops spread across the entire area (Yahaya Alfa, oral interview, 2019). Although ninety-nine sounds like a number of rituals or symbolic significance, the interviewee did not provide further information. At the time of this study, only about seven are physically standing, while just two are functional. The *estwa* is a round-shaped mud structure measuring about 3.5–5 m

in diameter and about 6 m in height. There are three doors and several triangular-shaped openings for cross-ventilation. An *estwa* usually houses furnaces for primary and secondary production, although only one is operated at a time. However, some workshops might have made raw glass exclusively while others only made glass objects.

The production of *bikini* involves the combination of several raw materials. This endeavor requires

Fig. 2 Schematic drawing of the complete cycle of *bikini* glassmaking

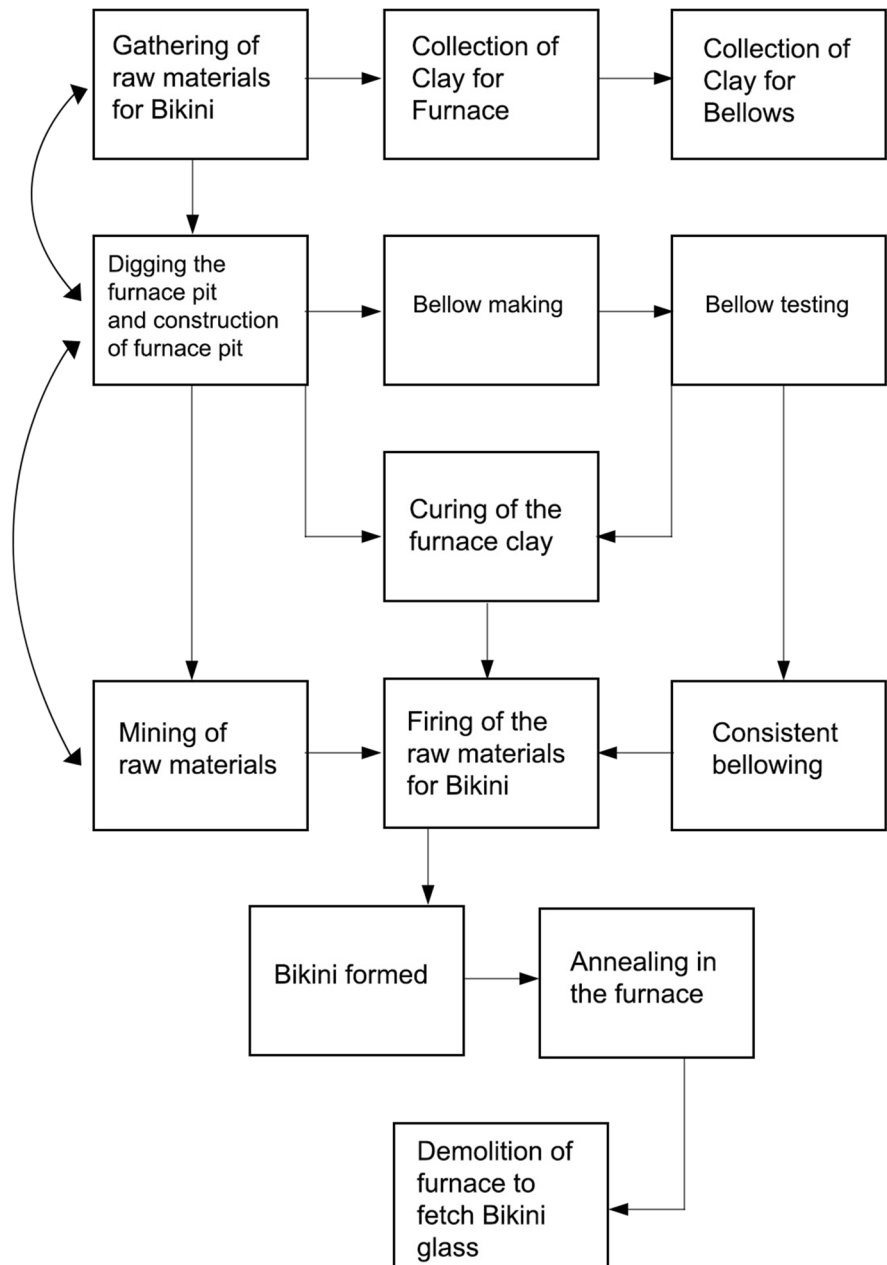

specialized skills to maintain appropriate proportions of the raw materials, in addition to procuring firewood, building furnaces, and bellows, and ensuring the availability of the 24-h labor required to operate the bellows. Production involves complex processes from the beginning to the end. The schematic image in Fig. 2 summarizes the complete process of *bikini*-making in Bida, showing that the processes are not linear.

The furnace, known as *ena*, is constructed inside of the *estwa*. To make *bikini*, the furnace construction begins by digging a pit. The sand dug out from the pit is used as the bulk siliceous material for the glass. The furnace is built with sticky red clay (*agun zuru*) fetched from the Chanchanga River because of its resistance to high temperatures. The river flows into tributaries of Rivers Kaduna and Niger, which would have made the transportation of the heavy clay possible and easier for the traders who brought the clay to Bida.

Only one glass-making furnace was constructed for the re-enactment. The *ena* comprises two components: the pit with a depth of 40–100 cm, depending on the quantity of glass to be made, and the outer hemispherical dome-shaped measuring approximately 74 cm in height from the ground surface (Fig. 3). The diameter of the outer dome corresponds to that of the pit. There are two openings. The first is an opening at the top, which serves as a vent for smoke and as a means to introduce firewood, raw materials, and the iron rod used to test the readiness of the glass. The second opening is located at the base of the *ena*, where two bellows are inserted to pump air into the furnace. The furnace is left to dry

for a day. Then, firewood is inserted into the furnace, ignited, and the bellows operator pumps air into the furnace to maintain the heat and gradually “cure the clay” (the process of preheating the wet furnace clay for the moisture to evaporate and clay to dry). Noticeable cracks on the furnace were patched and filled in with clay. Alemaka and his colleagues have suggested that Bida glassmakers should use modern furnaces constructed with bricks made of kaolinite clay for structural stability, optimal productivity, and sustainability (Alemaka, 2021; Alemaka et al., 2015). While Alemaka et al.’s idea is reasonable, it is counterproductive and detrimental to the traditional techniques and retention of indigenous knowledge.

A pair of bellows, *gurru*, is shaped by freehand from a specially blended mixture of white clay obtained from Maiduguri, located at about 838 km northeast of Bida (see Fig. 1). The pair is inserted into the opening at the base of the furnace. A pair of bellows is commonly known in West Africa as “bowl bellows” (Chirikure et al., 2009, p. 200). Soft-tanned goatskin leather, usually obtained from Sokoto, northwest Nigeria (see Fig. 1), covers the circumference of each of the bellows. A stick is attached to the center of the leather and secured with heavy twine. The bellows operator takes his position on a low wooden bench. In completing the *bikini*-making process, at least eight bellow operators were involved, each working a 3-h shift daily to ensure that the fire is constant and continuous for 24 h each day. From our observation, the heating process takes about five days for the raw materials to completely vitrify and become glass.

Charcoal is never used to fuel the furnace. Rather, a redwood called *sanchie* in Nupe is gathered from the marshes of the Niger and Kaduna rivers near Bida. The firewood is collected by women and sold to the Masagá glassmakers. *Sanchie* is preferable, perhaps the only fuel source, because it retains marsh gases that produce a steady, intense, long-lasting fire. The red sand of Bida is rich in silicates, serving as the main raw material for *bikini* glass. This red soil was used in the reenactment, and perhaps it had served as the main raw material for several centuries (Nadel, 1940). The sand has a high content of alumina and iron oxide. The concentration of these elements shows that the silicate source is high in impurities, which may account for the black color of *bikini* glass (Nadel, 1940). This local silica sand is mixed

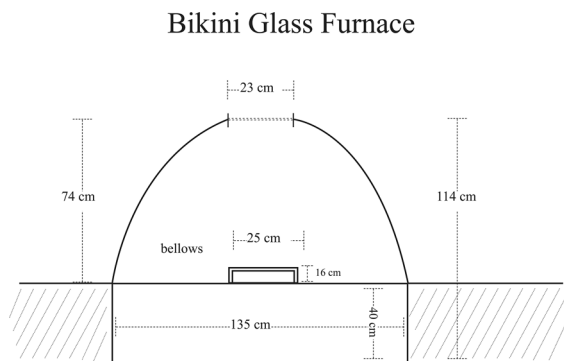

Fig. 3 Schematic diagram of the profile (a) and aerial view (b) of the *bikini* furnace

with soda, ash, and water to form the recipes needed to make a *bikini*. The soda/potash is sourced from the Lake Chad region, Sokoto, and Kano but the glassmakers would not provide further information on the specific source.

The glassmakers use the words potassium, natron (called *kanwa* in Nupe), soda, potash, ash, clay, sand, and *tswanbi* interchangeably, in no particular order and without clarification, to describe the recipes for glass production. They might have done this to keep the sources of these raw materials secret from outsiders. It is also possible that they could not differentiate between potash and soda, or they all have similar meanings in Nupe lexicons. Nadel (1940, p. 86) also observed these words interchangeably and suggested that sodium carbonate rather than potash was used. Analyzing the raw materials collected during the

reenactment allows us to have a clearer picture of the ingredients for *bikini* production.

Local sand and clay, soda, and *tswanbi* (literal Nupe translation, “fire gang”, recycled raw materials retrieved from inside the furnace on previous firings) are pulverized to a powder consistency in a large, traditional wooden mortar and pestle. After this, the dry ingredients are sieved to remove larger particles. Water is added to the powder. The mixture is compacted to resemble loaves of bread, which are later thrown into the furnace through the top opening. The furnace was fired consistently for 5 days with intense non-stop bellowing (Fig. 4). To check the ingredients, an iron rod with an L-shaped blade was used to scoop the molten glass. A *bikini* is completely formed when a reddish glaze that covers the rod hardens as the rod cools. Once it is confirmed that the raw materials have fully vitrified, the furnace is left to cool for 3–5 days to allow for the annealing process. Cooling slowly allows the molted glass to harden uniformly. The furnaces were demolished to fetch the raw glass (Fig. 5).

Secondary Glassworking: Jewelry Production, Technology, and Raw Materials

The secondary glassworking includes re-melting of *bikini* with a mixture of recycled glass (*kwálaba*) to make objects such as beads and bangles. Although this exercise can be carried out in the *estwa* (*bikini*-making furnace), the *ena* is preferred for this secondary production (glassmaking) phase. The glassworking furnace is cylindrical and built flat on the surface of the workshop floor without a pit (Figs. 6 and 7). It is built with local red clay as the intensity



Fig. 4 *Bikini* furnace for production of raw glass, with bellows, bellows operator, and the worker who inserts firewood

Fig. 5 Raw *bikini* glass (a) and *tswanbi* (b)

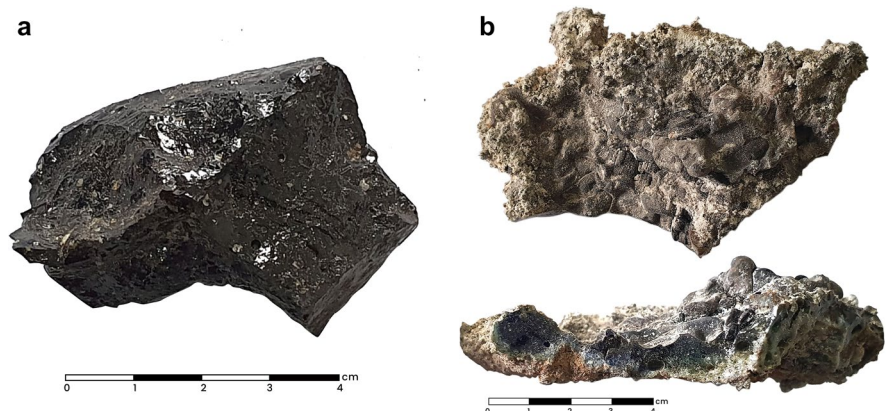

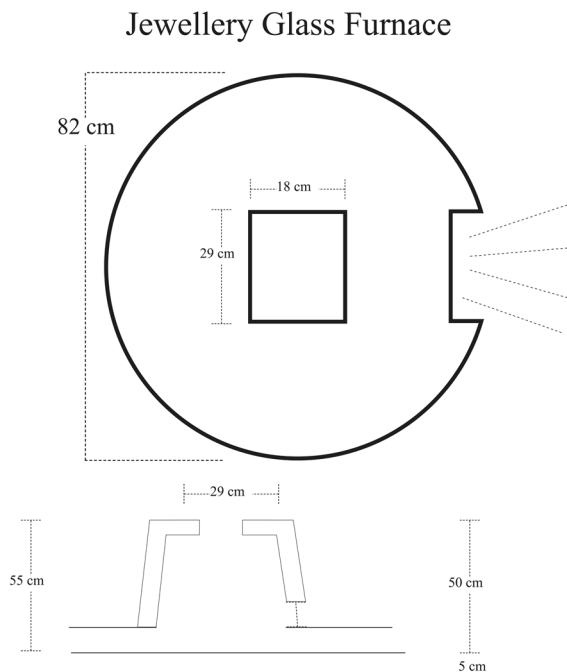

Fig. 6 Profile (a) and aerial view (b) of the Masaga glass working furnace

of heat and the time required are less than those for making glass. The glassworking furnace is between 50 and 55 cm high. It has two openings: a top opening to introduce firewood and a space on the side for the bellows. There are indentations in each corner of the top of the furnace for placing iron rods. The indentations in the clay provide the glassmakers with a steady hold on the rod.

The bellows for the jewelry furnace are of the same construction as that used for the *bikini* furnace. However, it is shorter and narrower in form. The bellows are positioned on a platform above ground level. Firewood, in the form of small branches rather than logs, is used in glassworking. As in glassmaking, firewood is thrown into the furnace through the top opening. We observed three to four men working simultaneously around the furnace to make their own products. Each glassmaker has his specialty, whether it is to make beads or bangles. Each object is produced in various sizes and colors according to the needs of the family and artisan. In the past, the choice of sizes and colors would have been driven by the market, demand, taste, and fashion. However, of all the glass objects



Fig. 7 The Masagá secondary glass working furnace from Bida, Nigeria

made in Bida, the bracelet appears to be the most common (Fig. 8). The uniqueness of the bracelet is its seamless nature made with a technique that is considered rare in the study of ancient glass jewelry (Rolland & Clesse, 2014). The Bida bracelets share striking characteristics, such as flat inner surface, ellipses-shaped air bubbles, and seamlessness, that are similar to the Celtic bracelets of the Middle La Tène period as found in the collection at the Historical Museum in Bern, Switzerland (Gardi, 1969, p. 68; Lababidi, 2019, p. 24). Below, in the discussion section, we discuss the uniqueness of the seamless Bida glass bracelet production and its implication for understanding ancient glassworking.

The ethnographic observation has proved productive in documenting and understanding the processes involved in *bikini* glass manufacture and glassworking in Bida. Knowledge of the raw materials exploited is still meager as the process of mixing the ingredients, and the exact proportions of recipes are shrouded in secrecy. No member of the Masagá glassmaker responded to direct questions

Fig. 8 Fragments of *bikini* bracelets made during the reenactment



about ingredients, quantities, and exact sources. What alkali was added? Was any form of stabilizer intentionally added to the raw materials? Why is a *bikini* usually black? However, these questions can be answered through compositional analysis of samples related to the production. Thus, results of the chemical analysis of samples collected before, during, and after the production, coupled with laboratory experimentation, provide partial answers to these questions.

Chemical Characterization of Bikini Glass and Raw Material

Corpus and Methodology

This analytical study was conducted in the IRAMAT-CEB laboratory (UMR7065 CNRS/University of Orleans) on different samples related to

bikini making. Some samples came from an old *bikini* collection of a Masagá glassmaker. The samples are believed to originate from the last batch of *bikini* made in the 1960s. The collection consists of five black beads and a chunk of raw *bikini*. The remaining samples came from the 2019 *bikini* production. They included a few pieces of raw black *bikini* (molten glass) which came directly from the furnace, a vitrified piece of the furnace wall, and a parcel of the dry ingredients used to make *bikini* (mixed raw materials: an unmelted mixture of sandy earth and flux and possibly *tswanbi*).

Most samples consisted of fairly homogenous solid glassy phases (beads, raw *bikini*, and furnace wall). Only the dry ingredients were in a powdered form. The main technique adopted for the analysis is laser ablation–inductively coupled plasma–mass spectrometry (LA-ICP-MS), mainly devoted to the characterization of solid phases. Hence, it was necessary to transform the dry

Table 1 Determination of soluble part in *bikini* dry ingredients

	Experiment 1	Experiment 2
Initial weight of dry ingredients	16.32 g	15.73 g
Weight of mixture after washing and drying (washed ingredients, part of them was melted, Table 2)	10.76 g	10.04 g
Weight loss	5.56 g	5.69 g
Percent loss	34.1%	36.2%
Weight of crystallized salt (part was melted, Table 2)	5.41 g	5.56 g
Percent of recovered salt	33.1%	35.3%

Fig. 9 Washed dry ingredients (left), crystallized salt [flux] (middle), and insoluble residue [sandy earth + groisil (or recycled glass) + tswanbi ?] (right)



ingredients (multi-phases powder) into a homogenous solid sample. To this end, we developed a dedicated experimental approach. The dry ingredients were homogenized by grinding them in a mortar. The powder was then separated into several parts. To check the presence of a soluble phase in these dry ingredients, two parts were washed several times with cold and hot water (Table 1). The solution was then filtered to collect the insoluble residue, which was then dried. The filtered washing water was evaporated, and the soluble salts were crystallized (Fig. 9). A slight effervescence is observed when hydrochloric acid is added to the washed ingredients (insoluble residue) and to the flux (crystallized salt), highlighting some carbonates within these materials. Part of the insoluble residue was studied with a multi-magnification (from $\times 6$ to $\times 50$) binocular loupe after the elimination of the smallest clay particles by further washing. The observation revealed the presence of some glassy particles of different colors. Some of them were isolated for further analysis (Fig. 10).

Two other parts of the original dry ingredients—the washed ingredients and the crystallized salt—were then melted separately at 1200 °C (Table 2).

The first part of the dry ingredients and the insoluble residue was melted in a graphitized crucible (reducing conditions) with a 3-h step at 800°C for the dry ingredients. The second part of the dry ingredients and the crystallized salt were melted in an alumina/silica ceramic cup (oxidizing conditions) with a 2-h step at 250°C and a 5-h step at 920°C. We thus ended up with five new types of glassy material:

- 1) Melted dry ingredients in reducing conditions (*red-lab-bikini*, Table 2, Part 1 dry ingredients);
- 2) Melted dry ingredients in oxidizing conditions (*ox-lab-bikini*, Table 2, Part 2 dry ingredients);
- 3) Melted crystallized salt (obtained by evaporating the washing water) in oxidizing conditions (*melt-flux*, Table 2, crystallized salt);
- 4) Melted insoluble residue in reducing conditions (*red-melt-sand*, Table 2 insoluble residue); and
- 5) 30 glassy particles retrieved in the soluble residue (*groisil 1 to 30*, isolated *kwálaba* or *tswanbi* fragments, Fig. 10).

The analyses of the glass objects and glassy phases were conducted at the Centre Ernest-Babelon of the IRAMAT (CNRS/Université d'Orléans,

Fig. 10 Insoluble residue under a binocular loupe (left), some isolated glassy fragments (middle), and analyzed glassy fragments (right)

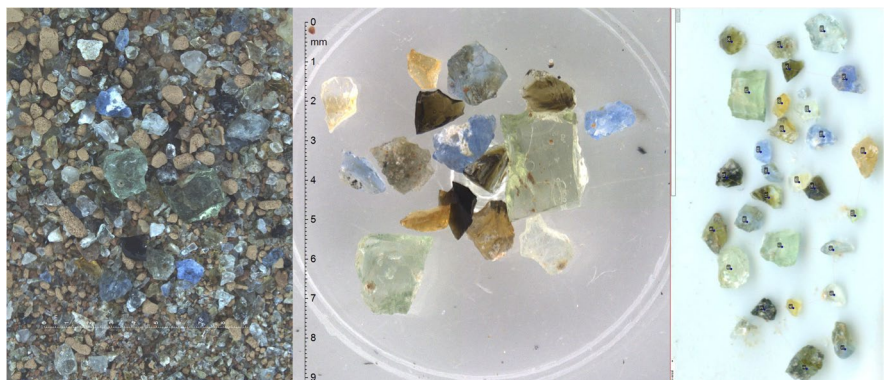















Table 2 Experimental fusion conditions carried out on the different materials; first two columns: original ingredients collected in Bida; columns 3 and 4: crystallized salt and the insoluble residue obtained after washing the dry ingredients

	Part 1 dry ingredients	Part 2 dry ingredients	Crystallized salt	Washed ingredients
Initial weight of mixture	5.69 g	13.56 g	5.39 g	7.19 g
Conditions	reducing	oxidizing	oxidizing	reducing
Weight after 250°C		13.34 g	5.34 g	
Percent loss at 250°C		1.6 %	0.9 %	
Weight after 800°C	5.08 g			
Percent loss at 800°C	10.7 %			
Weight after 920°C		12.50 g*	4.85 g	
Percent loss at 920°C		7.8 %	9.2 %	
Weight after 1200°C*	*	**	4.21 g *	**
Percent loss at 1200°C			21.9 %	
	  After 1200°  	 After 920°  After 1200°  	 After 920°  After 1200°  	After 1200°  
Colour of the melted product	Black	Greenish	Colourless	Black

* Some reactions with the crucible were observed.

** Part of the material migrated through or off the crucible and was lost

France), using laser ablation–inductively coupled plasma–mass spectrometry (LA-ICP-MS). The instrumentation consisted of a Resolution M50E UV laser probe from Resonetics/ASI (Eximer ArF laser working at 193 nm) coupled with a Thermo Fisher Scientific ELEMENT XR Mass Spectrometer (Gratuze, 2016). LA-ICP-MS allows a nearly non-destructive analysis of the glass objects. The excimer laser was operated at 5.5 mJ with a repetition rate of 10 Hz, and ablation time was set to 50 s (20 s pre-ablation so that contamination could be removed, and 30 s collection time corresponding to 9 mass scans from lithium to uranium). The signal was measured in counts/second in the low-resolution mode for 58 different isotopes. The fifty-eight elements include all major, minor (except sulfur), and trace elements usually present in glass samples (Gratuze, 2016). Fresh fractures were analyzed when possible to reduce

potential contamination. Blanks were run periodically between each series of 20 pieces. Spot sizes were set to 100 µm (although reduced to 70 µm when saturation occurred). During analysis, live counts were continuously observed. If incoherent signal variations occur, signifying the presence of inclusions, results are discarded, and a new location on the sample is selected for analysis. One to three areas were analyzed per sample, except for sample no. 3 (Fig. 11). For that bead, nine areas showing different compositions were sampled with the laser. Some variations of concentrations were also observed during single acquisitions (Fig. 11).

Calibration was performed using five reference standards: NIST610, Corning B, C, and D, and APL1 (an in-house reference glass used for chlorine determination). The reference standards were run periodically (every 15–20 samples) to correct any possible

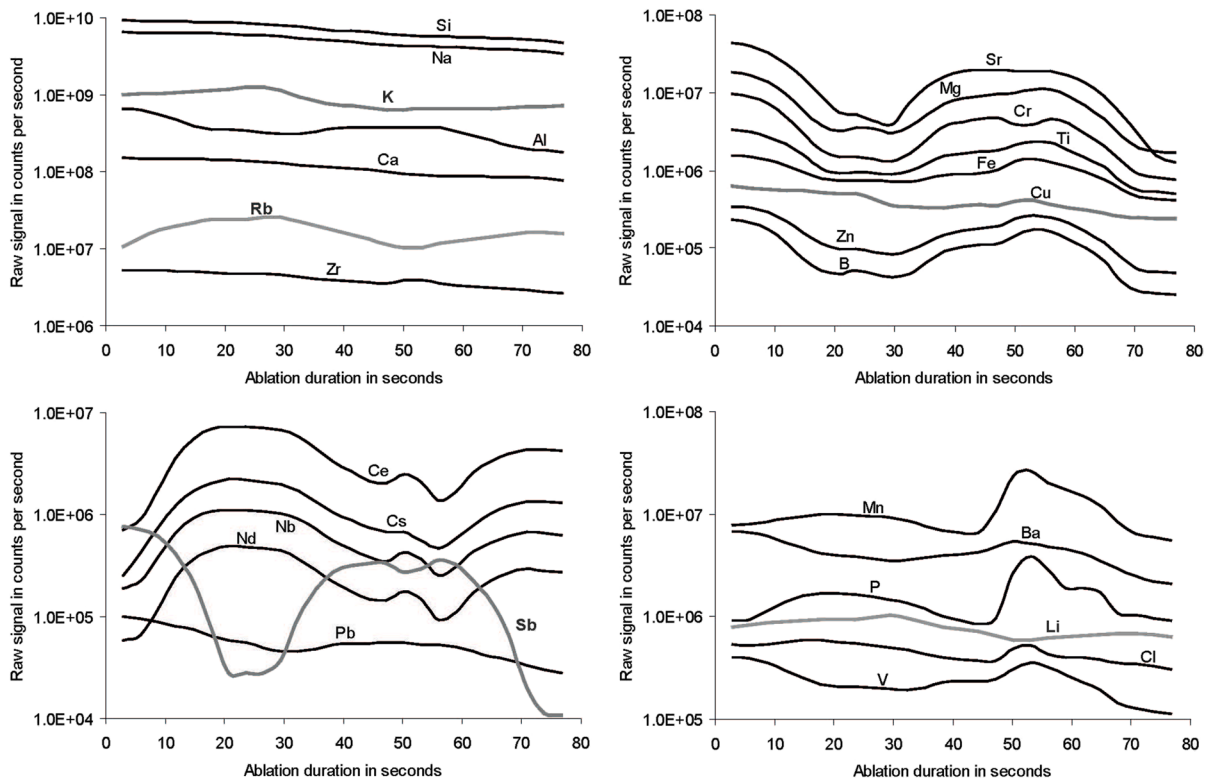

Fig. 11 Elemental signals acquired by LA-ICP-MS on bead no. 3

drifts. The standards were used to calculate the element's response coefficient (k). The measured values were normalized against ^{28}Si , the internal standard. Concentrations were calculated assuming that the sum of the concentrations of the measured elements is equal to 100 weight percent. In total, 58 elements were recorded. For the major and minor elements, accuracy and precision were within 5% relative and 10% for most trace elements.

Some powder materials (dry ingredients, washed ingredients, and recrystallized flux) were also analyzed, using Raman spectroscopy and X-ray diffraction, to identify their main mineral components. Laboratory X-ray diffraction measurements were performed on a D8 Advance Bruker ($\text{CuK}\alpha_{1,2}$ radiation) equipped with a LynxEye detector. Diagrams data were collected on all powder samples for 1 h between 15° and 80° (2θ) with a step size of 0.02° . Mineral identification was carried out using the ICDD PDF-4 release 2021 Database. Raman measurements were performed on a Renishaw Qontor

imaging spectrometer. Excitation wavelengths of 633, 514, and 355 nm were used to choose the optical configuration limiting the photoluminescence, and the 355 nm wavelength gave the best results. A $15\times\text{UV}$ microscope objective and a 3600 gr/mm grating were used. A 20-s integration time was chosen for individual spectra. For Raman mapping on the recrystallized flux, a 1-s acquisition time was chosen, and a $432\times 285\ \mu\text{m}$ area was analyzed with a $3\times 3\ \mu\text{m}$ resolution. For Raman mapping on the washed ingredients, a 1-s acquisition time was chosen, and a $447\times 282\ \mu\text{m}$ area was scanned with a $1.5\times 1.5\ \mu\text{m}$ resolution.

Experimental Results: Washed Dry Ingredients

Two parts of the raw materials mixture were washed, and their soluble contents crystallized. The results (Table 1) showed that the raw materials contain between 33 and 36% weight of soluble material. The two parts of the crystallized salt were then brought

together, and a fraction of it was melted (Table 2). The same was done with the insoluble residue.

Raw Material Melting (Dry Ingredients, Insoluble Residue, and Crystallized Flux)

As stated above, the melting operations were conducted with different steps at 250°C, 800°C, and 920°C. The raw materials were melted in the crucibles. After these steps, the crucibles were allowed to cool down, and when possible, the crucibles were weighed to estimate the weight loss of the raw materials in the fire. Table 2 shows that 8–11% weight loss was observed for the dry ingredients (sand and flux) and 22% for the crystallized salt (flux alone). This loss may have originated from the decomposition of some carbonate or sulfate compounds, but it may also have resulted from the evaporation of some oxides, such as soda or crystallized water. It was not possible to measure the weight loss on the washed ingredients (insoluble residue).

Results

In this section, we will first present the results obtained on the *bikini* glasses originating from Bida (beads and raw glass), and their comparison with the analytical data published by Robertshaw et al. (2009) on Nupe glass. Then, after summarizing the data obtained on the furnace wall, we will compare the results obtained on the different glass phases produced in the lab with *bikini* glass produced in Bida during the 2019 reenactment.

Analyses of Beads and Raw Bikini

The results obtained on the ancient raw *bikini* (before 2019) and the recent raw *bikini* (2019 making) are fairly consistent (Table 3). From a chemical point of view, both belong to the same type of recipe and glassmaking tradition. They are soda lime glass (Na₂O: 11.9–16.3%; CaO: 5.23–7.34%) containing small amounts of magnesia, potash, and phosphorus which are within the range of what one can expect from a mineral soda glass and a plant ash soda glass (MgO: 1.03–1.48%; K₂O: 1.79–2.77%; and P₂O₅: 0.71–1.64%). However, despite high concentrations of phosphorus and potash, its magnesia contents are

more similar to those of soda-lime-silica glasses with soda derived from mineral sources than plant ash. This glass is characterized by fairly high amounts of alumina, iron, and titanium oxides (Al₂O₃: 3.07–4.96%; Fe₂O₃: 1.31–1.92%; TiO₂: 0.27–0.48%) originating from the use of impure siliceous sand. These results are similar to those published by Robertshaw and colleagues (Robertshaw et al., 2009) for the bikini black cullet PR593 (Na₂O: 11.89%; CaO: 7.16%; MgO: 1.49%; K₂O: 2.21%; P₂O₅: 0.93%; Al₂O₃: 3.30%; Fe₂O₃: 1.34%; and TiO₂: 0.29%).

Results obtained on beads are more varied (Table 3). A total of 34 analytical points have been carried out on five beads. They reflect a great variety of compositions for all the measured elements (MgO: 0.10–1.24%; Al₂O₃: 1.21–3.37%; P₂O₅: 0.029–1.09%; K₂O: 0.80–2.54%; CaO: 6.04–11.1%; and TiO₂: 0.029–0.31%) and show a strong heterogeneity of the glass matrices. This heterogeneity probably originated from an incomplete mix of different ingredients, raw *bikini*, and recycled glass objects (*kwálaba*), as shown by the elemental signals acquired from one of the beads (bead no. 3, Fig. 11). In a homogeneous glass, all the measured signals should be parallel lines as ratios between elements are constant. In bead no. 3, while some elements show this linear signal (Si, Na, Ca, Zr, and, to a less extent, Cu and Pb), other elements show more irregular signals, which indicate correlated tendencies between some of them: the first group includes Sr, Mg, Ti, Cr, Zn, B and, to a lesser extent, Sb and Fe; in the second group we find Nb, Cs, Ce, Nd (and all the rare earth elements). We can also observe correlations between K, Rb, and Li on the one hand and Mn and P on the other. Sr and Ca seem to vary independently in the glass, and their ratio varies between 184 and 3605.

This confirms that during production in the secondary workshop, the glasses are not melted but simply softened. The presence of several compositions on the same object reflects the combined use of *bikini* glass and recycled glass (*kwálaba*) in this process. According to their magnesia, alumina, potash, lime, and titanium oxide contents, the results obtained on the beads can be divided into two compositional groups (Figs. 12 and 13). In the first one, we find three analytical points (carried out on bead nos. 1, 2, and 4), reflecting a glass composition fairly similar to the one determined on the raw *bikini* and PR 953 (Robertshaw et al., 2009). In the second group, the

Table 3 Chemical composition (average, standard deviation, minimum and maximum values) determined by LA-ICP-MS on the raw *bikini* glass samples and beads from Bida, comparison with the composition determined on the raw *bikini* black cullet PR 953 (Robertshaw et al., 2009). Concentrations in weight percent for major and minor oxides (Na₂O to Fe₂O₃) and ppm for the main trace oxides (Li₂O to PbO)

Oxide	<i>Bikini</i> 2019					Ancient <i>bikini</i>					Beads (34 pts)					Beads <i>bikini</i>			Beads kwálaba			PR953	PR1015
	Av	Std	Min	Max		Av	Std	Min	Max	Av	Std	Min	Max	Av	Std	Max	Av. (3pts)	Std	Av. (31 pts)	Std			
Na ₂ O	12.7	0.2	12.3	13.0	14.5	1.9	11.9	16.3	13.7	0.5	12.7	14.7	13.2	0.4	13.8	0.4	11.9	14.1	13.8	0.4	11.9	14.1	
MgO	1.21	0.14	1.03	1.39	1.33	0.17	1.17	1.48	0.59	0.30	0.10	1.24	1.19	0.05	0.54	0.25	1.49	0.81	0.54	0.05	1.49	0.81	
Al ₂ O ₃	3.45	0.52	3.07	4.96	3.48	0.28	3.12	3.76	2.01	0.52	1.21	3.37	3.21	0.22	1.89	0.36	3.30	2.78	1.89	0.22	3.30	2.78	
SiO ₂	70.3	1.1	68.0	72.1	67.5	2.3	65.7	70.9	71.1	0.6	69.1	72.0	70.0	0.8	71.2	0.5	70.6	69.3	71.2	0.8	70.6	69.3	
P ₂ O ₅	0.94	0.19	0.71	1.24	1.21	0.29	1.01	1.64	0.24	0.26	0.029	1.09	0.91	0.20	0.17	0.16	0.93	0.32	0.17	0.20	0.93	0.32	
Cl	0.57	0.12	0.44	0.72	0.65	0.23	0.41	0.90	0.16	0.13	0.050	0.65	0.52	0.13	0.13	0.05	0.93	0.32	0.13	0.13	0.05	0.93	0.32
K ₂ O	2.11	0.21	1.79	2.32	2.62	0.10	2.52	2.77	1.43	0.41	0.80	2.54	2.04	0.05	1.37	0.38	2.21	1.32	1.37	0.05	2.21	1.32	
CaO	6.19	0.33	5.72	6.71	6.08	0.91	5.23	7.34	9.89	1.20	6.04	11.1	6.63	0.88	10.2	0.6	7.16	9.01	10.2	0.88	7.16	9.01	
TiO ₂	0.34	0.05	0.27	0.44	0.44	0.05	0.38	0.48	0.11	0.07	0.029	0.31	0.29	0.02	0.094	0.039	0.29	0.18	0.094	0.02	0.29	0.18	
MnO	0.33	0.01	0.30	0.35	0.28	0.07	0.21	0.37	0.08	0.08	0.011	0.34	0.31	0.032	0.055	0.042	0.42	0.95	0.055	0.032	0.42	0.95	
Fe ₂ O ₃	1.60	0.18	1.31	1.92	1.68	0.19	1.43	1.87	0.49	0.36	0.14	1.62	1.47	0.18	0.39	0.18	1.34	1.47	0.39	0.18	1.34	1.47	
ppm																							
Li ₂ O	18.6	1.7	15.7	20.8	10.3	2.1	7.7	12.9	47.5	18.0	15.3	85.5	27.6	10.3	49.4	17.5	14.8	17.4	49.4	10.3	14.8	17.4	
B ₂ O ₃	218	29	190	298	168	7	158	175	76.1	55.1	9.8	242	219	22	62.2	32.7	14.8	17.4	62.2	22	14.8	17.4	
V ₂ O ₅	45.4	4.6	41.1	57.0	48.5	5.8	41.2	54.3	15.0	9.8	5.2	45.1	41.5	5.0	12.4	5.2	41.6	38.3	12.4	5.0	41.6	38.3	
Cr ₂ O ₃	56.1	8.5	42.9	69.9	37.7	5.7	30.3	42.9	71.2	40.4	10.6	169	57.2	8.1	72.6	42.1	58.2	41.3	72.6	8.1	58.2	41.3	
ZnO	69.8	8.5	58.2	87.5	32.6	5.8	24.9	38.3	25.5	19.7	4.5	109	77.0	28.5	20.5	9.1	70.0	198	20.5	28.5	70.0	198	
Rb ₂ O	54.9	5.4	47.2	61.7	77.7	15.9	66.7	101	215	113	56.0	454	89.2	55	227	110	82.4	39.7	227	55	82.4	39.7	
SrO	326	40	275	386	338	30	317	382	293	145	17.8	613	324	27	290	152	457	236	290	27	457	236	
ZrO ₂	425	122	249	612	578	93	496	707	239	56	185	416	382	58	225	31	814	190	225	58	814	190	
BaO	795	68	700	927	600	38	570	652	285	173	102	799	748	65	240	95	1300	752	240	65	1300	752	
CeO ₂	50.1	8.0	40.8	65.8	54.0	6.9	43.8	59.0	61.5	31.3	11.5	122	50.5	8.7	62.6	32.5	38.0	20.9	62.6	8.7	38.0	20.9	
PbO	23.4	8.9	14.6	39.9	110	36	69.7	157	19.3	14.1	<1.0	62.6	24.7	5.5	18.8	14.6	29.5	29.5	18.8	5.5	29.5	29.5	
CaO/SrO	192		169	218	179		165	192	688		181	5975	205		734		156	381	688		156	381	

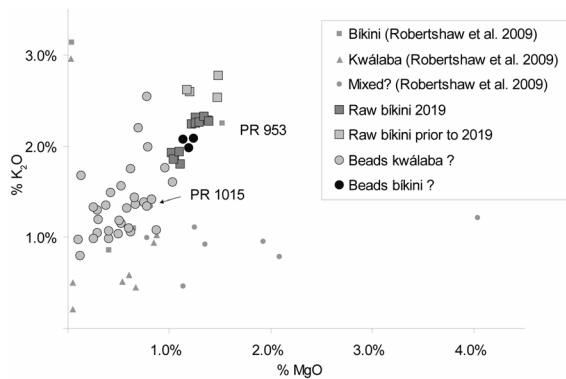

Fig. 12 Distribution of Bida glass samples (raw *bikini* and beads) according to their magnesia and potash contents, comparison with glass samples from Nupe (Robertshaw et al., 2009)

remaining 31 analytical points (carried out on bead nos. 1–5) show a large variety of glass compositions characterized by low iron and titanium oxide contents (Fig. 13).

In their study, comparing the Nupe glass data with those obtained on medieval glass from Essouk (Mali) and modern bottle glass from Thailand, Robertshaw et al. (2009) characterized Nupe *bikini* based on CaO/SrO ratios, SrO contents, and their reduced compositions. As a result, they were able to differentiate *bikini* (CaO/SrO < 206 and SrO > 450 ppm) from recycled European glass (*kwálaba*) and glasses obtained by mixing European glass and *bikini* (mixed) in

varied proportions. According to these criteria, the raw *bikini* and the three analytical points with high Fe and Ti contents in the present study stand outside the domain of *bikini* defined by Robertshaw et al. (Fig. 13). Only five analytical points carried out on the beads contain more than 450 ppm of SrO and have CaO/SrO ratios below 232, slightly higher than Robertshaw et al.'s value of 206. But these five points do not fit the reduced composition expected for a *bikini* as their iron and titanium oxides are below 0.35% and 0.11%, respectively.

Based on the results of the chemical analysis conducted on the raw *bikini* produced in 2019 and those from the old collection, we should extend the domain of *bikini* to a glass containing more than 270 ppm of strontium with a CaO/SrO ratio below 220 (Figs. 14 and 15). However, it seems that a better definition of *bikini* glass can be achieved by its contents in some minor oxides, such as those of iron and titanium (Fig. 13), than by its CaO/SrO ratios and strontium oxide contents. Although iron has been used as a colorant in ancient glass, it seems that a substantial amount of iron was naturally present in the sand used to make *bikini* glass. The iron content in *bikini* glass is above what is expected in most natural raw materials for glass. This proposition of Fe and Ti as major identifiers of *bikini* is supported by the variation in CaO/SrO contents. Measurements carried out on bead no. 3 show that Ca and Sr contents vary independently (Fig. 14), implying that CaO/SrO ratios can strongly

Fig. 13 Distribution of Bida glass samples (raw *bikini* and beads) according to their iron and titanium oxides contents, comparison with glass samples from Nupe (Robertshaw et al., 2009)

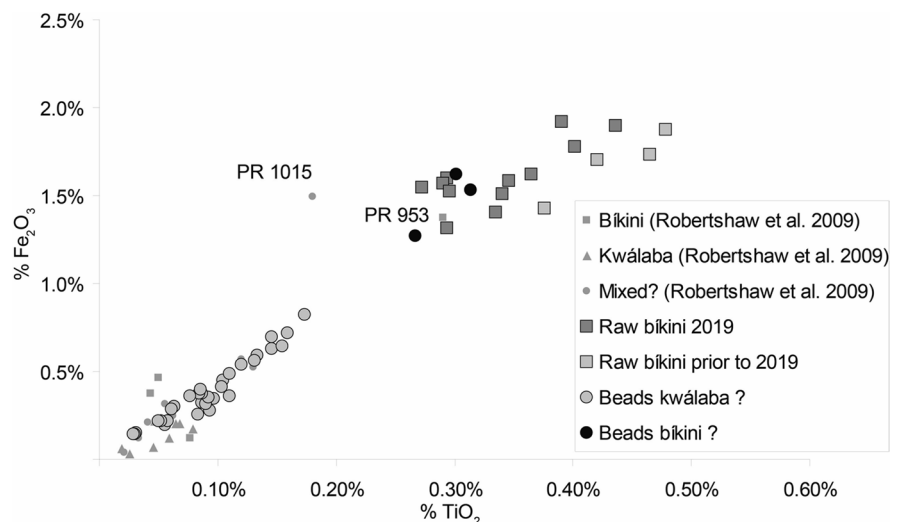

Table 4 Chemical composition determined by LA-ICP-MS for different parts of the glassy phase formed on the inner part of the furnace wall. The weight percent of major and minor oxides (Na₂O to Fe₂O₃) and ppm for the main trace oxides (Li₂O to PbO)

Oxide %	Fwall surf1	Fwall surf2	Fwall surf3	Fwall secsurf	Fwall secmid1	Fwall secmid2	Fwall secint
Na ₂ O	1.28%	1.26%	1.27%	1.29%	0.76%	0.72%	0.51%
MgO	0.14%	0.15%	0.16%	0.13%	0.15%	0.18%	0.15%
Al ₂ O ₃	8.50%	9.20%	8.80%	8.66%	9.41%	12.5%	9.62%
SiO ₂	65.6%	64.5%	64.5%	65.4%	67.1%	63.8%	69.0%
P ₂ O ₅	0.034%	0.022%	0.022%	0.027%	0.033%	0.039%	0.036%
Cl	0.072%	0.082%	0.078%	0.067%	0.074%	0.089%	0.085%
K ₂ O	19.4%	18.8%	18.9%	19.0%	16.6%	17.3%	14.7%
CaO	1.00%	1.00%	1.28%	0.69%	0.90%	0.60%	1.06%
TiO ₂	0.57%	0.53%	0.53%	0.56%	0.59%	0.51%	0.60%
MnO	0.036%	0.032%	0.033%	0.030%	0.031%	0.023%	0.029%
Fe ₂ O ₃	3.10%	4.13%	4.13%	3.89%	4.06%	3.95%	4.05%
Oxide ppm							
Li ₂ O	349	303	304	302	130	167	59.9
B ₂ O ₃	13.0	9.69	8.93	10.3	12.5	11.2	15.5
V ₂ O ₅	64.2	67.2	67.4	69.5	79.6	104	84.2
Cr ₂ O ₃	9.95	8.95	7.45	13.3	15.0	44.8	16.7
CuO	372	335	381	329	163	175	71.4
ZnO	668	312	291	272	154	138	132
Rb ₂ O	351	346	345	354	320	396	311
SrO	113	110	124	63.1	92.3	45.6	84.7
ZrO ₂	577	629	733	836	961	793	624
BaO	370	323	343	200	197	125	135
CeO ₂	93.6	116	114	105	129	72.2	145
PbO	6.54	6.84	10.2	4.68	11.2	7.56	24.1

vary in the same object. If we use these new criteria (Fe and Ti oxides), only two objects published by Robertshaw et al. (2009) meet this definition of *bikini*: the black cullet PR 953 and the black bead 1015 (which was classified by the authors as mixed glass). However, our results mainly show that the glass used to make beads by Bida glassworkers is a heterogeneous glass that contains statistically more *kwálaba* than *bikini* and that LA-ICP-MS is not the most suitable method to obtain an average composition of this type of recipe.

Analyses of the Furnace Wall

The interior surface of a small part of the furnace wall was used for analysis. The sample is a 1-cm-thick clay plate that presents a greenish vitrified phase on the face in contact with the fire (fumes and ashes). The thickness of the vitreous phase is in the range of

100–300 µm. Seven analyses (Table 4) were carried out on this vitrified surface. Three of them were done directly on the surface (Fwall surf1-3), and the four others on a section, perpendicular to the surface, of the vitreous phase: one on the external surface (Fwall secsurf), two in the middle of the glass phase (Fwall secmid1-2), and the last near the interface between the glass phase and the unreacted clay (Fwall secint).

Unlike the *bikini*, the main flux of the glass phase formed on the furnace wall is potash, not soda. This glass phase originates mainly from the reaction between the clay and the potash contained in the ashes generated by the wood combustion during heating the kiln. A slight decrease in potash concentration is observed through the glass phase between its external and internal surfaces. Different behaviors are observed among the main constituents of this glass phase. Like potash, the concentrations of some elements (Na, Li, Cu, Zn, Ba) decrease from the surface

to the interior. In contrast, the remaining elements have more or less stable, irregular, or increasing (B, Cr, Ce) concentrations throughout the glass phase.

The main mineral constituents of wood ash are potash, lime, and phosphorus pentoxide. They could also contain some oxides of magnesium, zinc, manganese, iron, rubidium, strontium, and barium. Among these oxides, potash is the one that reacts more easily with clay to form glass. The main components of clay are silica, alumina, potash, and iron oxides, but it may also contain lime and several trace elements. In addition to potash, we observe the presence of other constituents of the wood ash in the glass phase. Some of them present the same type of concentration profile as potash: zinc rubidium and barium, while others seem more regularly distributed through the glass phase: phosphorus, lime manganese, and strontium.

Two other constituents of the glass phase deserve our attention—sodium and lithium, which probably originate from the raw glass constituents (flux and recycled glass). These two oxides likely evaporated during the melting of raw materials, as observed during experimental melts (Table 4).

Analyses of Bikini Raw Materials: Sand and Flux

The LA-ICP-MS analyses on the recrystallized flux, either directly on the dried product or on its melt, show that it mainly contains soda (Table 5). They also reveal the presence of some potash, chlorine, and lithium. Raman analysis carried out on the dried salt shows the company of two main types of sodium compounds: a sulfate phase (major) and a carbonate phase (minor). Compared with pure sodium, sulfate,

Table 5 Chemical composition (average, standard deviation, minimum and maximum values) determined by LA-ICP-MS on the different fused materials obtained in the laboratory. The

weight percent of major and minor oxides (Na_2O to Fe_2O_3) and ppm for the main trace oxides (Li_2O to PbO). For the flux, the contents of Al_2O_3 , SiO_2 , Fe_2O_3 , and TiO_2 were not retained

Oxide %	Red-lab-bikini				Ox-lab-bikini				Red-melt-sand				Melt-flux		Dried-flux	
	Av	Std	Min	Max	Av	Std	Min	Max	Av	Std	Min	Max	Av	Std	Av	Std
Na_2O	12.4	0.8	11.7	13.5	12.0	0.3	11.6	12.3	5.2	0.2	4.9	5.4	95.8	2.3	93.6	4.2
MgO	1.34	0.25	1.09	1.69	1.96	0.10	1.85	2.05	2.00	0.15	1.87	2.19	0.22	0.16	0.16	0.17
Al_2O_3	11.2	1.1	10.0	12.2	9.2	0.1	9.1	9.4	11.0	1.0	9.7	12.1				
SiO_2	63.9	1.8	61.4	65.6	62.7	1.2	61.7	64.3	65.9	0.6	65.1	66.4				
P_2O_5	0.77	0.08	0.67	0.84	0.92	0.06	0.81	0.96	0.89	0.14	0.78	1.09	0.20	0.02	0.27	0.30
Cl	0.14	0.04	0.11	0.19	0.09	0.03	0.07	0.13	0.07	0.00	0.06	0.07	0.23	0.12	3.33	3.24
K_2O	1.67	0.10	1.54	1.79	1.34	0.05	1.27	1.39	2.36	0.11	2.20	2.46	2.04	1.32	1.57	1.11
CaO	4.95	1.38	3.70	6.91	7.40	0.72	6.59	7.97	7.93	0.65	7.30	8.61	0.55	0.35	0.70	0.91
TiO_2	0.63	0.04	0.59	0.67	0.53	0.01	0.51	0.54	0.61	0.01	0.60	0.63				
MnO	0.21	0.06	0.15	0.29	0.36	0.02	0.34	0.38	0.36	0.04	0.33	0.42	0.007	0.005	0.001	0.001
Fe_2O_3	2.42	0.36	2.11	2.74	3.12	0.07	3.01	3.20	3.36	0.27	3.12	3.75				
ppm																
Li_2O	202	29	172	238	191	5	186	198	248	22	232	281	6012	4234	44.0	40.6
B_2O_3	210	35	179	256	220	66	159	292	294	16	272	308	284	179	244	142
V_2O_5	163	50	102	224	71.8	1.3	70.1	73.2	118	4	113	121	206	129	36.2	45.6
Cr_2O_3	111	11	100	125	64.6	16.1	48.3	82.9	116	12	105	133	46.8	13.6	25.5	21.6
ZnO	89.2	20.0	61.5	109	185	6	176	192	146	31	112	187	156	91	39.8	18.3
Rb_2O	74.7	7.1	65.2	82.3	51.8	2.0	49.1	54.4	115	4	112	119	365	264	23.2	18.9
SrO	295	35	267	347	295	33	255	319	418	26	391	447	48.0	24.0	25.2	21.5
ZrO_2	372	56	329	452	452	21	424	476	419	16	406	441	449	310	7.66	16.5
BaO	656	101	597	807	603	57	536	650	1172	28	1145	1200	88.6	31.9	12.8	11.0
CeO_2	92.9	8.9	82.4	103	100	6	92.9	107	106	9	98.4	117	122	84	0.64	0.47
PbO	52.1	17.2	33.2	68.9	192	9	181	204	105	20	85.3	133	393	188	107	140
CaO/SrO	165		138	199	251		248	258	190		186	194				

and carbonate, a little shift of the main band values was observed, indicating the presence of more complex salts. X-ray diffraction measurements carried out on the recrystallized flux provide evidence of different sodium and potassium compounds: thenardite (Na_2SO_4), burkeite $\text{Na}_6(\text{CO}_3)(\text{SO}_4)_2$, halite (NaCl), and aliphitalite $\text{K}_3\text{Na}(\text{SO}_4)_2$. Among them, thenardite and burkeite are the two more abundant phases. Taking into account their chemical formulae (corresponding to approximately 47% of Na_2O) and the proportion of flux in the dry ingredients (34%), these compounds represent up to 19% of Na_2O in the final product, without taking into account the presence of groisil, which also contain some soda. We can therefore conclude that an important part of the soda is lost during the melting of the ingredients, as shown by the presence of soda on the furnace wall.

Results of LA-ICP-MS analyses of the glass produced at the IRAMAT-CEB (Orléans) by melting the raw materials (dry and washed raw materials mixture) are different from the ones obtained for the raw *bikini* produced in Bida. The glass made in Orléans contains much more alumina (9–12% compared to 3–5% in *bikini* glass), titanium oxide (0.5–0.67% compared to 0.27–0.48%), and iron oxide (2–3% compared to 1.3–1.9%). These differences can be explained either by a complete melting of the dry ingredients in the experimental fusion conditions used in the laboratory (small crucible, electrical furnace, temperature of 1200°C, and fast heating and cooling) or by enrichment in clay particles (lighter and finer particles) of the small part of sampled dry ingredients compared to the bulk dry ingredients used by the glassmakers (sampling may have been done at the surface and was enriched by lighter particles). We can also notice that the *bikini* obtained in Bida and our laboratory is not a homogeneous product as shown by the maximal and minimal values measured by LA-ICP-MS for the different oxides. Different types of particles (size, composition) and a fusion without mixing the ingredients partially explain this heterogeneity.

Raman analyses of the washed ingredients highlight mainly the presence of quartz and a small mineral grain, anatase, a titanium mineral. They also reveal a high number of amorphous phases, which are probably recycled glass particles. The analyses of the dry ingredients show the presence of the same phases as those identified in the recrystallized flux. X-ray diffraction analysis of the washed ingredient allows us

to identify the presence of quartz (SiO_2), wollastonite, a calcium silicate (CaSiO_3), and some unidentified feldspar minerals corresponding to the general formulae $[(\text{Na},\text{K})(\text{Si}_3\text{Al})\text{O}_8]$. The measurement carried out on the dry ingredients shows the presence of quartz and flux compounds (thenardite, burkeite, and halite).

The evaporation of most volatile oxides, the enrichment (contamination) of the glass with the oxides contained in the combustion ashes, and the oxidation state of certain elements are among the main compositional changes which may be induced by the different melting conditions used at Bida and in the laboratory. The oxides of lithium and sodium, and to a lesser extent, magnesium, are among the most volatile. As we have seen, an enrichment of sodium and lithium oxides was observed at the surface of the furnace walls. The lithium contents in the melts carried out in the laboratory (short heating time) are ten times higher than in Bida (several days of heating). We have also observed in the laboratory an enrichment in lithium oxide on the edges of the crucibles. This enrichment goes up to 900 ppm for the “ox-lab-*bikini*,” while the average content measured in bulk is 191 ppm. The lithium content was up to 1% for the “melt flux,” with an average of 0.5%. The long heating time in Bida (several days) explains the low content of lithium oxide in *bikini* glass (<20 ppm). Similarly, the presence of the fuel and, therefore, of the ashes in contact with the molten glass in the Bida furnace can lead to contamination of the glass by the main constituents of the ash (i.e., potassium, calcium, magnesium, and phosphorus oxides).

The oxidizing or reducing atmosphere of the melting furnace can change the oxidation state of certain elements (e.g., iron and manganese) and modify the color of the glass. For example, with the same raw material, glass created in the laboratory under reducing conditions (graphitized crucible) was black, while glass made under oxidizing conditions (open crucible) was pale green. The black color of raw *bikini* is a consequence of the strong reducing conditions used by Bida glassmakers. Let us now compare the composition of the fused dry ingredients and insoluble residue. We notice the presence of a fairly large amount of fluxing agents (soda, potash) in the molten insoluble residue (5%). They probably originate from the groisil fragments (*kwálaba* and *tsw-anbi*), which are present in the dry ingredients. These fragments may explain more than one-third of the

Table 6 Chemical composition (average, standard deviation, minimum and maximum values) determined by LA-ICP-MS on the isolated *kwálaba* fragments. Concentrations in weight percent for major and minor oxides (Na₂O to Fe₂O₃) and ppm for the main trace oxides (Li₂O to PbO)

Oxide %	Soda-lime glasses				High lime glasses			
	Av	Std	Min	Max	Av	Std	Min	Max
Na ₂ O	12.6%	1.8%	9.13%	17.6%	6.11%	2.12%	4.69%	9.26%
MgO	1.53%	0.95%	0.089%	3.34%	3.57%	2.60%	1.19%	7.16%
Al ₂ O ₃	2.70%	1.49%	0.71%	6.86%	2.11%	1.18%	0.96%	3.60%
SiO ₂	68.0%	4.8%	53.9%	75.4%	60.1%	3.3%	56.9%	64.0%
P ₂ O ₅	0.55%	0.93%	0.010%	4.83%	1.10%	1.05%	0.21%	2.59%
Cl	0.18%	0.19%	0.066%	0.93%	0.087%	0.009%	0.078%	0.099%
K ₂ O	2.62%	1.62%	0.52%	6.64%	2.32%	1.39%	1.40%	4.40%
CaO	9.82%	1.58%	6.40%	13.2%	22.6%	5.8%	17.3%	29.2%
TiO ₂	0.13%	0.12%	0.032%	0.59%	0.13%	0.11%	0.033%	0.29%
MnO	0.49%	0.61%	0.0080%	2.26%	0.81%	0.90%	0.043%	1.87%
Fe ₂ O ₃	0.93%	0.88%	0.068%	3.29%	0.71%	0.68%	0.16%	1.66%
ppm								
Li ₂ O	32.8	24.9	13.2	126.3	42.7	10.4	30.8	52.5
B ₂ O ₃	871	1175	27.5	3719	533	396	124	882
V ₂ O ₅	24.1	17.3	4.91	69.1	25.8	22.6	5.54	51.9
Cr ₂ O ₃	186	773	1.97	4114	21.7	6.2	16.1	30.5
CoO	198	319	1.19	925	286	322	4.16	589
CuO	87.1	165	8.27	876	217	209	24.8	421
ZnO	106	92	15.5	337	97.1	61.4	24.7	175
As ₂ O ₃	187	288	15.1	999	58.1	18.7	30.4	71.0
Rb ₂ O	69.2	42.8	13.8	208	52.7	42.2	27.3	115
SrO	313	190	64.2	730	626	250	336	945
ZrO ₂	239	168	40.0	675	238	74	173	343
Sb ₂ O ₃	178	693	0.29	3680	1.80	0.50	1.38	2.43
BaO	1076	1148	227	5329	1773	458	1446	2439
CeO ₂	23.7	20.0	5.06	100	28.3	24.2	12.5	64.3
PbO	184	426	1.22	1632	35.4	37.0	5.68	83.6
CaO/SrO	438		159	1467	407		183	543

soda content of the final product and a large part of its potash content.

Analyses of Groisil Fragments (Kwálaba and Tswanbi)

Among the 30 crushed large particles retrieved in the washed sand, 29 were found to be glass fragments, and one was probably a mineral that had not been identified. These glass fragments show a great diversity of composition (Table 6). Most are soda-lime glasses (26/29) containing various amounts of magnesia and potash. Even though their color cannot be easily characterized, some contain high contents of coloring agents such as chromium (1 sample, Cr₂O₃: 4114 ppm) or cobalt

(6 samples, CoO 445–925 ppm). In the future, comparing these compositions with modern glass bottles used around Bida may yield interesting results. The three remaining fragments consist of high lime glasses, which probably originate from glass bottle; one of them is colored by cobalt (CoO 589 ppm). Half of the soda lime glass fragments exhibit higher alumina contents, and oxides of iron and titanium than those usually encountered in modern glass (Al₂O₃ > 3%, TiO₂ > 0.15%, and Fe₂O₃ > 1%; Fig. 16). It is, therefore, probable that they originate from recycled ancient production of *bikini* (recycled raw *bikini* or discarded incompletely vitrified and reacted materials during ancient production events). These fragments correspond to the material called *tswanbi* while the others (Al₂O₃ < 3%,

Fig. 16 Distribution of the raw glass obtained by melting the raw material and of the isolated glass fragments according to their iron and titanium oxides contents, comparison with preceding data and glass samples from Nupe (Robertshaw et al., 2009)

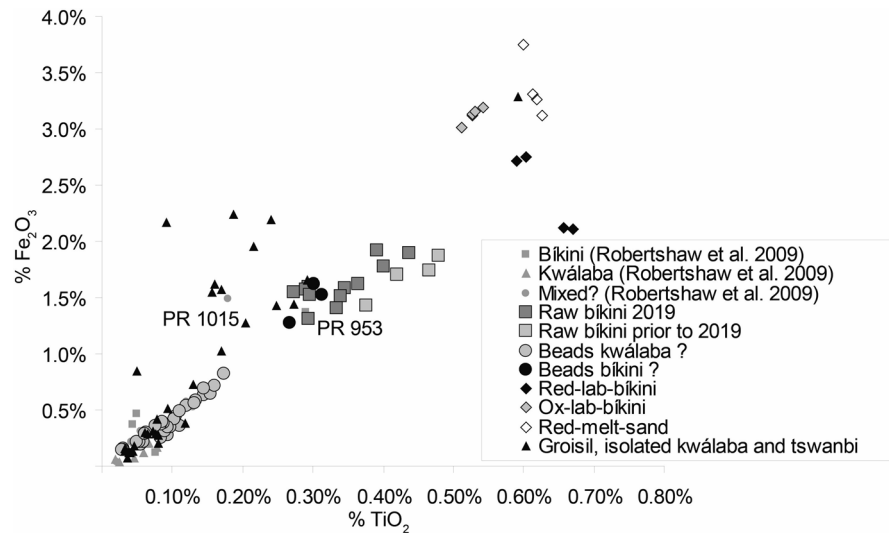

TiO₂ < 0.10%, and Fe₂O₃ < 1%) probably come from crushed modern glass (*kwálaba*). Assuming an average soda content of 12.6% in the groisil, and that all the flux has been removed during the washing of the dry ingredients, the 5.2% of soda content found in the molten washed ingredients (red-melt-sand) implies the presence of a minimum of 27% of groisil (*kwálaba* and *tswanbi*) in the dry ingredients.

The analysis has confirmed *bikini* to be a soda-lime-silica glass made with a combination of silica sand and sodium material (as flux) with little or no potassium intentionally included in the flux. Recycled glass in the form of imported bottles or old *bikini* is also added. From the analyses, it can be concluded that the potassium oxide present in the glass comes mainly from recycled glass [*kwálaba* and *tswanbi*] and/or clay. Therefore, the term “potassium” used by the glassmakers refers more to the flux or alkali in its broad meaning (oxides of alkaline elements) than to real potash or potassium (K₂O).

Understanding the Masagá Skills of Seamless Bracelet Making in the Context of Ancient Glassworking

To understand past societies, archaeologists often resort to analogies distinct from their primary area of research. This approach has opened avenues for

the rediscovery of past technologies and the interpretation of archaeological remains. In ancient craft studies, the review of traditional techniques from various social or cultural contexts, such as Masagá glasswork, often brings unexpected technical solutions, new insights into the social organization of workshops, and sometimes allows us to rediscover new things about a craft that we thought we understood. Therefore, in recent years, the documentation of the Masagá knowledge and the organization of their primary and secondary workshops has added to our understanding of the ancient glass crafts.

Over the past ten years, research into the techniques used to make seamless glass bracelets has enabled us to rediscover one of the first European glass crafts developed between the fifth and first centuries BC. At that time, the techniques of blown glass had not yet been invented. Glass was mainly used in the Near East, Egypt, and Greece for the production of beads. In the fifth century, a new glass object was developed in continental Europe: the glass bracelet (Rolland, 2021). This object was only produced by the populations of the so-called La Tène cultures, which the ancient Greeks called Celts. Until the end of the first century BC, the glassmakers of La Tène developed the production of this unique ornament, multiplying the different decorative techniques with exotic raw materials imported from the primary raw glass workshops of Egypt and Levantine coasts. With the Roman

civilization, blown glass developed, to the detriment of the seamless techniques of bracelet making. Hence, the seamless bracelets were short-lived, and only a few bracelets are still produced in Europe and often with visible solder joints. The seamless glass bracelets are no longer produced in contemporary Europe.

In 2009, a collaboration between glassmakers and archaeologists was set up to rediscover the techniques for making seamless glass bracelets. As the craftspeople in Europe are not familiar with these techniques, written and video documentation from the latest bracelet producers was widely used to understand the processes and techniques used. Only a few groups of bangle makers still produce glass bracelets, or were still producing them in the past 40 years, in Palestine, India, Nepal, and Nigeria (Dang, 2010; Gaborieau, 1989; Kanungo, 2021; Korfmann, 1966; Nenna, 2000; Rolland, 2021, p.113; Trivedi, 2021). The comparison between the production of bracelets by the Masagá glassmakers and Celtic production was made by Théa Elisabeth Haevernick as early as the 1960s (Haevernick, 1960). She used Leo Frobenius's work on Masagá to discuss possible techniques used by Iron Age craftspeople of Europe, and then collaborated with René Gardi, who filmed the Masagá glassworkers in order to compare their techniques with the Iron Age Europe glass production (Gardi & Schweizer, 1963).

From Nepal to Nigeria, the technique for producing a seamless glass bracelet follows the same rule: it requires the enlargement of a bead. Thanks to this documentation, a new understanding of the seamless glass bracelet manufacturing techniques began to emerge. The numerous experimentations in France have shown how difficult it is for a modern European glassmaker with the technical tradition of glassblowing to make a seamless glass bracelet and that the decorative techniques put in place by the La Tène glassmakers represent skills of complex acquisition (Rolland, 2021; Rolland & Clesse, 2014). The production of seamless glass bracelets by the Masagá craftspeople not only constitutes a complex technical tradition, but also places Bida within the global context of the studies of crafting glass jewelry. This is true for understanding extant glassworking as well as glassmaking in archaeological sites in Sub-Saharan Africa.

Comparisons with the Glass Production at Ile-Ife and the Archaeological Significance

The Bida *bikini* making has yielded valuable information about primary glassmaking in Nigeria since the mid-nineteenth century. Although no archaeological precedence is yet known for glassmaking and glassworking in the area, the re-enactment and experimentation have the potential for understanding early glassmaking in Sub-Saharan Africa. The closest place to look in the region is Ile-Ife where unequivocal evidence of early primary glassmaking and secondary glassworking exists. The Ile-Ife and Nupe connection is particularly important because they shared some historical relationships, albeit complex and sometimes controversial. While the evidence from Ile-Ife has immensely contributed to our knowledge of the technology of glass among ancient communities, some questions still remain unanswered. Observations during the *bikini* making and the compositional analysis of the products provide some additional clues to understanding glassmaking in an archaeological context.

The process of *bikini* making, from the construction of the furnace to the fetching of raw glass from the furnace, proved analogous to the artifacts recovered from and features exposed at the Igbo-Olokun glass workshop site in Ile-Ife. To fetch raw glass out of the furnace in Bida, the outer dome shape of the furnace was destroyed. Due to the interaction between the fuel ash and the furnace clay, a glaze-like layer had formed on the inner part of the furnace. Morphologically, the furnace remains from Bida are similar to what has been categorized as vitrified production debris (VPD) at Igbo Olokun (Fig. 17). They both share characteristics such as the sometimes amorphous shape, the bubble voids, the vitrified area, and the flattened glazed surface. VPD was encountered in greater quantity at Igbo-Olokun than Ayelabowo, another glass workshop in classical Ife, and has not been reported elsewhere in Ile-Ife. When we first discovered VPD at Igbo Olokun, we had no idea what they were and how they connected with glass production. Therefore, we categorized them as amorphous geological materials. Following the results of an initial compositional analysis of a few samples of VPD, we have suggested that they may represent furnace ruins (Babalola, 2016).

Fig. 17 Glass-making furnace remains. **a** Fragments from Igbo-Olokun, Ile-Ife. **b** Fragments from the reproduction at Bida

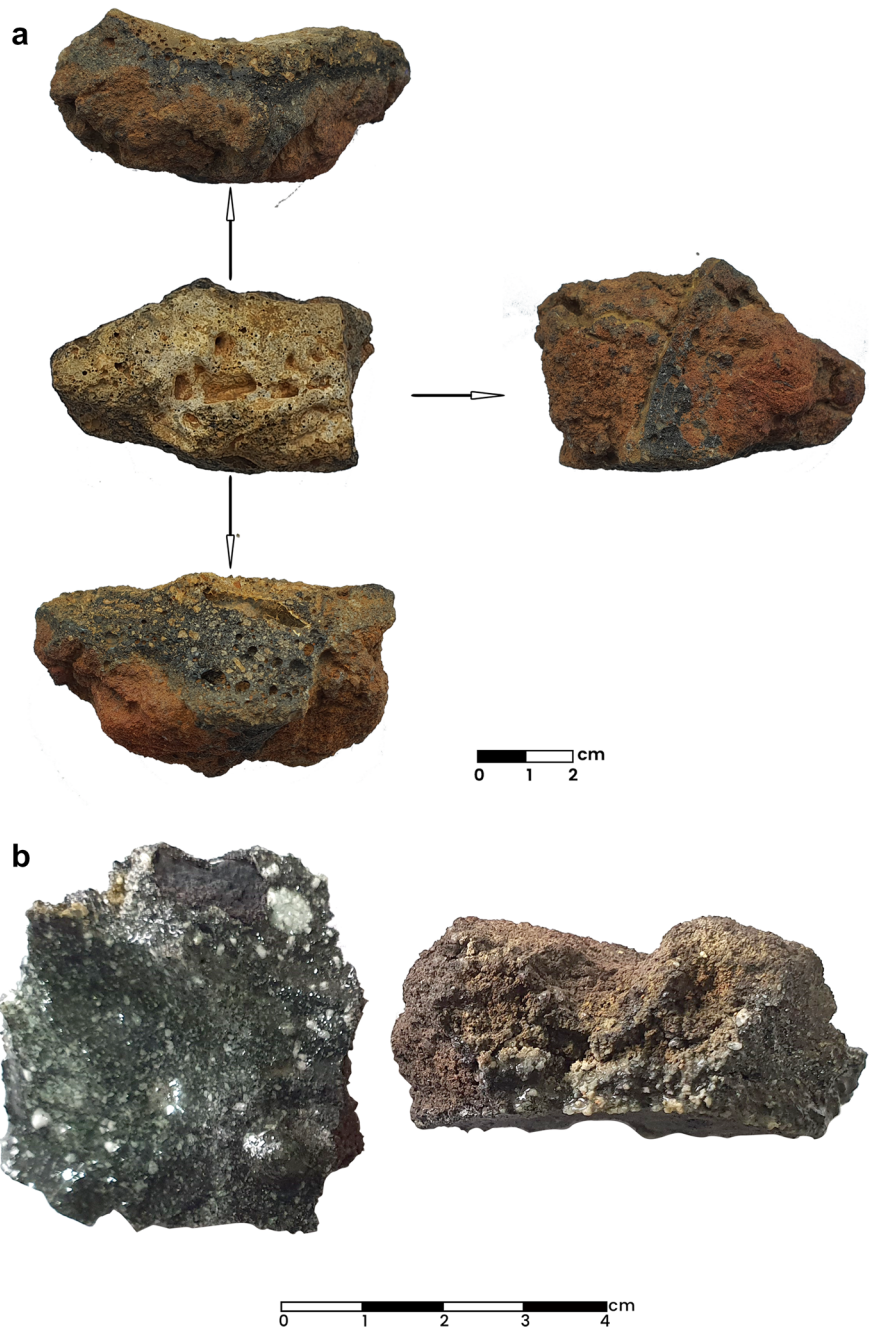

Results of the compositional analysis of the furnace fragment from Bida share similar results indicating fuel ash contamination and interaction with the evaporated sodium oxide from the raw materials. Chemical constituents of wood ash such as potash, lime, and phosphorus are elevated in the glazed area of the material compared to the clay part in both

samples from Igbo-Olokun and Bida. An increase in the concentration of soda in the glazed region, compared to the clay fabric, also suggests probable origin from the raw material. These similarities in the presence and elevation of wood ash elements strongly indicate that they are products of similar technical processes. If the outer part of the furnace

were destroyed at Igbo-Olokun at the completion of the production cycle, as observed at Bida, this would explain the prominent occurrence of VPD. However, it should be noted that perhaps the furnaces at Igbo-Olokun would have been used more than once before demolition. The degree of vitrification of VPD and the evidence of possible repair in the form of sandwiched fuel ash layer between two clay layers may suggest multiple uses of a furnace for making different batches of glass. With the comparable materials from Bida, we now know that VPD stands a chance to help us understand aspects of the production activities in the early glass workshops at Ile-Ife. VPD may be the closest evidence of glassmaking infrastructure in early West Africa. But the furnace pits also deserve attention.

Excavations at Igbo-Olokun have exposed several circular pits. Three conjoined pits were encountered, with the deepest at approximately 1 m and the shallowest being 40 cm. A charcoal sample from the bottom of the shallow pit gave a date of eleventh century AD. Another pit with a shallow channel had been uncovered at Igbo-Olokun, although excavation is yet to reach the bottom of the pit. Based on the arrangement, shape, and sizes of the pits at Igbo-Olokun, one of us (Babalola) has suggested that they may represent part of the furnace infrastructure at the site. Although this assumption is a plausible possibility, the lack of archaeology precedence for glass making furnaces in Sub-Saharan Africa makes this identification difficult to confirm. However, the ethnographic and experimental works at Bida appear to have solved part of this mystery or at least provided insight. There are striking similarities between the depth and wall of the *bikini* furnace pit and those uncovered at Igbo-Olokun. This resemblance is not a mere coincidence. We argue that they are typical and intentional for the Sub-Sahara African glass-making industry. Rather than looking for evidence of large workshops as in South Asia and the Levant tank glass furnace, we should be cognizant of pits, their arrangement, and constituent features to identify glassmaking and glassworking furnaces in Sub-Saharan Africa.

How did Bida connect with early Ile-Ife? Did Ile-Ife influence glassmaking in Bida? These questions hinge on understanding the nexus of “technological transfer” and the mobility of people, objects, and ideas. Historical traditions connect the Masagá to eighteenth-century migration from Egypt. Although

no empirical scholarship has been done to substantiate what appears to be a migration legend, this tradition is a dominant narrative among the Masagá, highlighting the questionable model of north–south migration in African historiography (i.e., Hamitic hypothesis, Sanders, 1969). Perhaps, the history of glass technology in Nupeland did not start with the migration from Egypt. We must also consider the flow of ideas and people from the south to the north. Mobility has never been unidirectional. It was and is still fluid and complex. Besides, the well-established knowledge of primary glass technology and production in the early second millennium AD in Ile-Ife predates what we know about the technology in Nupeland.

Moreover, scholars have demonstrated the existence of long-time interaction between the Yoruba and their Nupe neighbor through shared traits in artworks and religious belief as well as imperialist relationships (Agiri, 1975; Apata, 1998; Dada, 1985; Eluyemi, 1975; Obayemi, 1983; Usman, 2012). Ogundiran’s (2020) notion of the Yoruba community of practice best narrates the complex relationship between Yoruba and non-Yoruba groups such as the Nupe. Between the eleventh and twelfth century AD, Ogundiran (2020) argues that a Yoruba community of practice began to coalesce, and Ile-Ife recruited members from afar. While some of the members of the community of practice returned to their homeland, others stayed and retained their “Yorubanness.” Many Yoruba speakers also became part of the Nupe community of practice (Ogundiran, 2020, p. 11). Following these dynamic long-term nonexploitative relations, workers who gained experience working in Ife glass workshops could have brought the knowledge of glassmaking to Nupeland. This initial idea of glassmaking, possibly, was combined with the knowledge of glass production from elsewhere in the later centuries. It is equally possible that some later migrants into Nupeland popularized the craft. These are speculations and only through archaeology can we understand the antiquity of glass technology in Nupeland. It is now expedient for archaeologists to respond to Thomas-Emeagwali and Idrees’s question of “who were the earliest glass producers in the Nupe-Speaking region” (1992, p. 138). At this time, the ethnographic work at Bida shows a parallel between *bikini* making and early glass production in Ile-Ife.

Conclusions

This study has shed new light on *bikini* glass production in Bida through a re-enactment exercise and ethnographic observation. In the concluding remarks of their article on the chemical analysis of Nupe glass, Robertshaw and his colleagues emphasize the need for the reproduction of *bikini* glass for a better understanding of the technology and techniques of production. They state that “an attempt should be made to manufacture *bikini* glass in a furnace that has either been manufactured for this experiment or in one that has been thoroughly cleaned of all other glass and associated debris. Samples of the raw materials and the *bikini* glass made from them should be collected for chemical and isotopic analyses. Every effort should be made to glean as much information as possible about this unique African glass manufacture” (Robertshaw et al., 2009, p. 94). This study has achieved more than these recommendations. It has not only provided a detailed understanding of the process of *bikini* making but also significantly established a link to archaeology in addressing questions on “technological transfer,” mobility, and *chaîne opératoire*, among others.

The reproduction of *bikini*-making enabled us to have a firsthand dataset for elemental analysis. Hence, samples ranging from the powdered raw material mix, finished *bikini* glass, beads, and older bikini glass, to furnace wall fragments were chemically analyzed. The *bikini* glass is mainly a soda-lime glass characterized by elevated contents of alumina (3.45%), iron (3.4%), and titanium (0.3%). It owes its composition mainly to the use of impure sand rich in iron, a mineral soda flux (34%, composed primarily of sulfates and carbonates), and a large part of a recycled glass of different origins (up to 27% of *kwálaba* and *tswanbi* fragments). *Bikini* is characteristically black and owes its color to the reducing atmosphere of the furnace. The long heating time probably causes a significant loss of volatile oxides such as sodium and lithium found in large amounts on the furnace wall. The presence of the fuel directly in contact with the glass can lead to contamination with potash and other oxides in the ash. *Bikini* objects consist of a highly heterogeneous glass phase. Analyses of different parts of the same object reveal the presence of raw *bikini* and recycled glass grains. The occurrence of *bikini* and recycled glass grains shows that during production in the secondary workshop, the different glasses are not thoroughly melted but simply softened to produce objects. This heterogeneity resulting from the mixing of *bikini* with recycled glass

echoes Robertshaw et al.’s (2009, p. 94) view that “heterogeneity of chemical composition is a defining feature of the products of glass-working in Nupe.”

It is impressive that most of the information we gathered on *bikini* making is not in great divergence from what Nadel recorded over eight decades ago, even though *bikini* production stopped about two decades after Nadel’s visit. Nevertheless, it is evident that certain techniques have been lost, including the knowledge of some of the recipes. However, the documentation of the re-enactment of *bikini*-making opens a new direction for archaeological research on glass production in Africa. Compared to the large glass production furnaces with various chambers in Ancient Egypt (Brill, 1988; Gorin-Rosen, 2000; Nenna, 2007, 2015) and the tank furnace of the Levant for producing glass slabs (Freestone & Gorin-Rosen, 1999), Bida is providing a new possibility of glassmaking workshops characterized by small pits. The large furnaces with chambers may not be the case in Sub-Saharan Africa, as evident from Bida and Ile-Ife. The Masagá glass production techniques allow us to consider the existence of other glass production techniques and infrastructure in antiquity. The production process and the furnace structure might be smaller and less visible in the archaeological context. Hence, the documentation of the Masagá technical traditions and melting furnace could help to better identify the glass production workshops of early periods in Nupeland and elsewhere across Africa. The Masagá workshop allows us to think of other modes of primary glass production in the past. It provides clues as to what else might have existed and what we might now need to look for. These possibilities include small furnaces with bellows, non-slab primary glass production, probably fewer archaeological remains, and a focus on unusual materials such as the furnace ruins. The work of the Masagá glassmakers also provides a unique window to unraveling the technique of making seamless glass bracelets. This technique was explored in Celtic Europe more than 2000 years ago.

Acknowledgements We would like to thank His Royal Highness Alhaji (Dr) Yahaya Abubakar CFR, Etsu Nupe, Chairman of the Niger State Council of Traditional Rulers, without whom the idea of researching, documenting, and filming the Masagá *bikini* making would not have been possible. Much appreciation goes to Alhaji Abubakar Mahmud and Dan Galadima Nupe Hakimi for introducing us to His Royal Highness and for standing by this project for over 6 years. Our thanks go to the Masagá glasswork cooperative and community for welcoming Lesley Lababidi into their homes and workshops. Alhaji

Yahaya Alfa Masagá of the Federal Polytechnic Bida offered his assistance in helping us understand the complicated traditions involved in *bikini* glass technology. Thanks to Mohamed Salah for taking rough furnace drawings to produce sleek computer illustrations. The British Museum's Endangered Material Knowledge Program (EMKP) funded part of the research. We thank Peter Robertshaw, Constanze Weise, and Laura Dussubieux for reading an initial draft of the manuscript.

Declarations

Conflict of Interest The authors declare no competing interests.

Open Access This article is licensed under a Creative Commons Attribution 4.0 International License, which permits use, sharing, adaptation, distribution and reproduction in any medium or format, as long as you give appropriate credit to the original author(s) and the source, provide a link to the Creative Commons licence, and indicate if changes were made. The images or other third party material in this article are included in the article's Creative Commons licence, unless indicated otherwise in a credit line to the material. If material is not included in the article's Creative Commons licence and your intended use is not permitted by statutory regulation or exceeds the permitted use, you will need to obtain permission directly from the copyright holder. To view a copy of this licence, visit <http://creativecommons.org/licenses/by/4.0/>.

References

- Abubakar, A. M. (2021). A study of ecology and cultural adaptation at the Old Tafyan Site, Niger State Nigeria: A preliminary report. *LAPAI Journal of Humanities*, 12(3), 265–281.
- Agiri, B. (1975). Early Oyo history reconsidered. *History in Africa*, 2, 1–16.
- Aiyedun, K. D., & Shaw, T. (1989). *Prehistoric settlements and subsistence in the Kaduna River Valley, Nigeria*. British Archaeological Report, International Series 541. Archaeopress.
- Alemaka, E. M. (2021). Upgrading the glass bead making furnace for ease of operation: A case study of the Masaga glass guild. *UNIOSUN Journal of Engineering and Environmental Science*, 3(2), 19–24.
- Alemaka, E. M., Garkida, A. D., & Ali, E. A. (2015). The potentials of indigenous glass bead making industry as a viable springboard to technological advancements in Nigeria. *ENVIRON Journal of Environmental Studies*, 3(9&10), 151–161.
- Apata, Z. O. (1998). The Nupe imperialism and the Ogidi Grand Alliance 1894–1897: Reflections of Ekitiparapo war. In I. A. Akinjogbin (Ed.), *War and peace in Yorubaland* (pp. 1793–1893). Heinemann Educational Books.
- Babalola, A. B. (2016). *Archaeological investigation of early glass production at Igbo-Olokun, Ile-Ife (Nigeria)*. Ph.D. dissertation, Rice University, USA.
- Babalola, A. B. (2017). Ancient history of technology in West Africa: Indigenous glass/glass beads industry and the society in Early Ile-Ife, southwest Nigeria. *Journal of Black Studies*, 48(5), 501–527.
- Babalola, A. B. (2019). Medieval glass bead production and exchange. In K. Beczock (Ed.), *Caravans of gold, fragments of time* (pp. 223–237). Princeton University Press.
- Babalola, A. B., Dussubieux, L., McIntosh, S. K., & Rehren, Th. (2018a). Chemical analysis of glass beads from Igbo Olokun, Ile-Ife (SW Nigeria): New light on raw materials, production, and interregional interactions. *Journal of Archaeological Science*, 90, 90–105.
- Babalola, A. B., Rehren, Th., Ige, A., & McIntosh, S. K. (2018b). The glass making crucible from Ile-Ife, SW Nigeria. *Journal of African Archaeology*, 16, 31–59.
- Babalola, A. B., Ogunfolakan, A., & Rehren, Th. (2020). Semi-finished glass from Ile-Ife, Nigeria: Implications for the archaeology of glass in Sub-Saharan Africa. *Antiquity*, 94(375), 1–6. <https://doi.org/10.15184/auq.2020.77>
- Bowen, T. J. (1857). *Central Africa: Adventures and missionary labours in several countries in the Interior of Africa, 1849–1856*. Southern Baptist Publication Society.
- Brill, R. H. (1988). Scientific investigations of the Jalame glass and related finds. In G. D. Weinberg (Ed.), *Excavations at Jalame: Site of a glass factory in late Roman Palestine* (pp. 257–294). University of Missouri Press.
- Chirikure, S., Burrett, R., & Heimann, R. B. (2009). Beyond furnaces and slags: A review study of bellows and their role in indigenous African metallurgical process. *Azania: Archaeological Research in Africa*, 44(2), 195–215.
- Cisse, M., McIntosh, S. K., Dussubieux, L., Fenn, T., Galagher, D., & Smith, A. C. (2013). Excavations at Gao Saney: New evidence for settlement growth, trade, and interaction on the Niger Bend in the first millennium CE. *Journal of African Archaeology*, 11(1), 9–37.
- Dada, P. O. A. (1985). *A brief history of Igbomina*. Matanmi Publishing Company.
- Dang, R. (2010). Work of precision: Tradition bangle making in India. <https://www.youtube.com/watch?v=W5fvVUDUtwU>. Accessed 28 July 2021.
- Davison, C. (1972). Glass beads in African Archaeology: Results of neutron activation analysis, supplemented by results of X-ray fluorescence analysis. Ph.D. dissertation, University of California, Berkeley.
- DeCorse, C. R. (1989). Beads as chronological indicators in West African archaeology: A re-examination. *Beads*, 1, 41–53.
- DeCorse, C. R., Richard, F. G., & Thiaw, I. (2003). Toward systematic bead description system: A view from the Lower Falemme, Senegal. *Journal of African Archaeology*, 1(1), 77–109. <https://doi.org/10.3213/1612-1651-10003>
- Eluyemi, O. (1975). New terracotta finds at Oke-Eso, Ife. *African Arts*, 9(1), 32–35.
- Freestone, I., & Gorin-Rosen, Y. (1999). The great glass slab at Bet-She'Arin, Israel: An early Islamic glassmaking experiment? *Journal of Glass Studies*, 41, 105–116.
- Frobenius, L. (1913). *The voice of Africa: Being an account of the travels of the German Inner African Exploration Expedition in the years 1910–1912* (Vol. 2). Hutchinson & Co.
- Gaborieau, M. (1989). Bracelets et grosses perles de verre, fabrication et vente en Inde et au. *Objets et Mondes*, 17(3), 111–130.
- Gardi, R. (1969). *African crafts and craftsmen*. Van Nostrand Reinhold Company.

- Gardi, R., & Schweizer, U. (1963). *Das Glassmacher von Bida*, (A short documentary). Lichtspiel/Kinemathek Bern, Switzerland. www.lichtspiel.ch. Accessed 27 Nov 2021.
- Gorin-Rosen, Y. (2000). The ancient glass industry in Israel: Summary of the finds and new discoveries. *Travaux de la Maison de l'Orient Méditerranéen*, 33(1), 49–63.
- Gratuze, B. (2016). Glass characterization using laser ablation-inductively coupled plasma-mass spectrometry methods. In L. Dussubieux, M. Golitko, & B. Gratuze (Eds.) *Recent advances in Laser Ablation ICP-MS for archaeology*. Springer. https://doi.org/10.1007/978-3-662-49894-1_12
- Haevernick, T. E. (1960). *Die glasarmringe und ringperlen der Mittel- und Spätlatènezeit auf dem Europäischen Festland*. R. Habelt.
- Henderson, J. (2000). *The science and archaeology of materials: An investigation of inorganic materials*. Routledge.
- Henderson, J. (2013). *Ancient glass: An interdisciplinary exploration*. Cambridge University Press.
- Kanungo, A. K. (2021). Glass bangles in India: Antiquity, functional use and traditional production. *South Asian Studies*. <https://doi.org/10.1080/02666030.2021.2001250>
- Korfmann, M. (1966). Zur Herstellung nahtloser Glasringe. *Bonner Jahrbucher* (Band 166).
- Lababidi, L. (2019). *Red walls of Bida glass bangles*. Obelisque Publications.
- Lankton, J. W., Ige, A., & Rehren, Th. (2006). Early primary glass production in Southern Nigeria. *Journal of African Archaeology*, 4(1), 111–138.
- Lilyquist, C., & Brill, R. H. (1993). *Studies in Ancient Egyptian glass*. Metropolitan Museum of Art.
- McIntosh, S. K., Wood, M., Dussubieux, L., Robertshaw, P., Insoll, T., & Cisse, M. (2020). Glass beads from Medieval Gao (Mali): New analytical data on chronology, sources, and trade. *Journal of African Archaeology*, 18, 1–23.
- Nadel, S. F. (1940). Glass-Making in Nupe. *Man*, 40, 85–86.
- Nadel, S. F. A. (1942). *Black Byzantium: The kingdom of Nupe in Nigeria*. Oxford University Press.
- Nenna, M.-D. (2000). *La Route du verre: Ateliers primaires et secondaires du second millénaire av. J.-C. au Moyen Âge*. Maison de l'Orient méditerranéen-Jean Pouilloux De Boccard.
- Nenna, M.-D. (2007). Production et commerce du verre à l'époque impériale: Nouvelles découvertes et problématiques. *Facta. A Journal of Roman Material Culture*, 1, 159–181.
- Nenna, M.-D. (2015). Primary glass workshops in Graeco-Roman Egypt: Preliminary report on the excavations of the site of Beni Salama, Wadi Natrun (2003, 2005–9). In J. Price & J. Bayley (Eds.), *Glass of the Roman world* (pp. 1–22). Oxbow Books.
- Nicholson, P. T. (2007). *Brilliant things for Akhenaten*. Egypt Exploration Society.
- Obayemi, A. (1983). History, culture, Yoruba and northern factors. In G. O. Olusanya (Ed.), *Studies in Yoruba history and culture*. Ibadan University Press.
- Ogundiran, A. (2020). *The Yoruba: A new history*. Indiana University Press.
- Prinsloo, L. C., Tournié, A., & Colombari, P. (2011). A Raman spectroscopic study of glass trade beads excavated at Mapungubwe Hill and K2: Two archaeological sites in southern Africa, raises questions about the last occupation date of the hill. *Journal of Archaeological Science*, 30, 3264–3277.
- Rehren, Th. (2014). Glass production and consumption between Egypt, Mesopotamia and the Aegean. In P. Pfälzner, H. Niehr, E. Pernicka, S. Lange, & T. Köster (Eds.), *Contextualising grave inventories in the Ancient Near East, Qatna Studien Supplementa 3* (pp. 217–223). Harrassowitz.
- Rehren, Th., & Pusch, E. (2005). Late Bronze Age Egyptian glass production at Qantir-Piramesses. *Science*, 308, 1756–1759.
- Robertshaw, P., Weise, C., Dussubieux, L., Lankton, J., Popelka-Filcoff, R. S., & Glascock, M. D. (2009). Chemical analysis of glass from Nupe, Nigeria. *Tribus*, 58, 83–95.
- Rolland, J. (2021). *Le verre de l'Europe celtique. Approches archéométriques, technologiques et sociales d'un artisanat du prestige au second âge du Fer*. Sidestone Press.
- Rolland, J., & Clesse, J. (2014). Filer le verre, porter le bleu; enjeux techniques et sociaux de la production de parures en verre celtique. *Bulletin de l'Association Française pour l'Archéologie du Verre*, (AFAV), 9–12. <https://hal.archives-ouvertes.fr/hal-02870325>
- Rødland, H. (2022). Crafting Swahili beads: Exploring a new glass bead assemblage from northern Zanzibar, Tanzania. *African Archaeological Review*. <https://doi.org/10.1007/s10437-022-09475-9>
- Sanders, E. R. (1969). The Hamitic hypothesis: Its origin and functions in time perspective. *The Journal of African History*, 10(4), 521–532.
- Shortland, A. J., & Rehren, Th. (2020). Glass. In M. P. Richards & K. Britton (Eds.), *Archaeological science - An introduction* (pp. 347–364). Cambridge University Press.
- Thomas-Emeagwali, G., & Idrees A. A. (1992). Glass-making technology in Nupeland, Central Nigeria: Some questions. *Science and technology in African history with case studies from Nigeria, Sierra Leone, Zimbabwe, and Zambia*. Edwin Mellen Press.
- Trivedi, M. (2021). Glass bangles in South Asia: Production, variability and historicity. In L. Dussubieux & A. M. Kanungo (Eds.), *Ancient glass in South Asia: Archaeology, ethnography, and global connections* (pp. 361–381). Springer.
- Usman, A. (2012). *The Yoruba frontier: A regional history of community formation, experience, and changes in West Africa*. Carolina Academic Press.
- Weise, C. (2003). Kingship and the mediators of the past: Oral tradition and ritual performance in Nupeland, Nigeria. In T. Falola & C. Jennings (Eds.), *Sources and methods in African historical research: Spoken, written, unearthed* (pp. 268–294). University of Rochester Press.
- Wood, M. (2016). Glass beads from pre-European contact sub-Saharan Africa: Peter Francis's work revisited and updated. *Archaeological Research in Asia*, 16, 65–80.
- Wood, M., Dussubieux, L., & Robertshaw, P. (2012). Glass finds from Chibuene, a 6th to 17th century AD port in southern Mozambique. *South African Archaeological Bulletin*, 67(195), 59–74.
- Wood, M., Dussubieux, L., Wynne-Jones, S., & Fleisher, J. (2022). Glass beads from Songo Mnara, Tanzania: Chemical composition and evidence for local bead manufacture. *African Archaeological Review*. <https://doi.org/10.1007/s10437-022-09484-8>

Publisher's Note Springer Nature remains neutral with regard to jurisdictional claims in published maps and institutional affiliations.