



**HAL**  
open science

## Magnetics for power electronics integration from powders to passive components

Trong Trung Le, F. Mazaleyrat, Thierry Lebey, Zarel Valdez-Nava

► **To cite this version:**

Trong Trung Le, F. Mazaleyrat, Thierry Lebey, Zarel Valdez-Nava. Magnetics for power electronics integration from powders to passive components. *Ingenierías*, 2016, 19 (70), pp.3. hal-03823275

**HAL Id: hal-03823275**

**<https://hal.science/hal-03823275>**

Submitted on 1 Dec 2022

**HAL** is a multi-disciplinary open access archive for the deposit and dissemination of scientific research documents, whether they are published or not. The documents may come from teaching and research institutions in France or abroad, or from public or private research centers.

L'archive ouverte pluridisciplinaire **HAL**, est destinée au dépôt et à la diffusion de documents scientifiques de niveau recherche, publiés ou non, émanant des établissements d'enseignement et de recherche français ou étrangers, des laboratoires publics ou privés.

# Magnetics for power electronics integration: from powders to passive components

Trong Trung Le<sup>A,B</sup>, Frédéric Mazaleyra<sup>C</sup>,  
Thierry Lebey<sup>A,B</sup>, Zarel Valdez-Nava<sup>A,B</sup>

<sup>A</sup> CNRS; LAPLACE; F-31062 Toulouse, France

<sup>B</sup> Université de Toulouse; UPS, INP; LAPLACE (Laboratoire Plasma et Conversion d'Énergie), Toulouse, France

<sup>C</sup> SATIE, ENS Cachan, CNRS, UniverSud, Cachan, France  
valdez@laplace.univ-tlse.fr

## RESUMEN

*La nueva generación de sistemas eléctricos de potencia para sistemas móviles requerirán reducciones de volumen y peso considerables. Los nuevos dispositivos semiconductores dispondrán de frecuencias y voltajes de funcionamiento más altos, lo que permitirá la reducción del volumen de los componentes pasivos, dieléctricos y magnéticos. Una estrategia posible es mutualizar los componentes magnéticos en convertidores multicelulares entrelazados. Estas arquitecturas requerirán nuevos materiales magnéticos con formas complejas. En este trabajo proponemos una estrategia general para producir las geometrías complejas que se requerirán para validar los nuevos conceptos en arquitecturas de convertidores entrelazados.*

## PALABRAS CLAVE

Sistemas eléctricos de potencia, transformadores de corriente intercelulares ICT, transformadores multicelulares, ferritas de Ni-Zn, prensado isostático en frío.

## ABSTRACT

*The next generation of on-board power electronics will be highly demanding on volume and weight reduction. Higher frequency and higher voltage devices could allow for the reduction of the passive components, dielectric and magnetic. A possible strategy is to mutualize the magnetic components in interleaved multicellular architectures. This will require new ceramic magnetic materials and complex geometries. We propose in this work a general strategy to produce complex geometries required at the development stage of such new architectures.*

## KEYWORDS

Power electronics, Intercellular current transformers ICT, multicellular transformers, Ni-Zn ferrites, cold isostatic pressing.

## INTRODUCTION

Power electronics (PE) is a branch of electrotechnics that concerns the static converters. PE allows for the management and conversion of the electrical

energy from the source to its final use. At the heart of the PE systems we find the semiconductor devices that allow for high energy efficiency in the conversion process. Along these active components, energy must be stored and conditioned by other elements known as passive components. Capacitive and inductive components are coupled to semiconductors to complete the total conversion chain. These PE systems cover from very small power, mW, to large power applications (several MW) (Meynard T. *et al.*<sup>1</sup>). Particularly on-board electronics, for transportation applications, require an increase on the total energy density of the systems. Hence, total volume reduction involves every part of the PE system, including the passive components. There is a great effort on the research of new solutions for the integration of passive components to reduce their footprint on the final system and ultimately to reduce their volume, an example of these investigations is given by Lu D, Wong.<sup>2</sup> This system integration needs the contribution of designers, that propose new topologies; materials scientists, developing materials with improved intrinsic properties; and materials processing researchers, that develop methods to produce real objects that can be used for a proof of concept of the new topologies.

It is possible to find several examples of capacitor integration for medium power applications, Lu D. *et al.*<sup>3</sup> and Doan T. *et al.*<sup>4</sup> are good references, however, for magnetic components, examples are limited and they take into account only the contribution of system designers by using commercially available magnetic materials. Volume reduction of magnetic passive components can be achieved by sharing, in a single magnetic component, several fluxes interleaved in frequency. This requires several semiconductors working in parallel to produce the phase shifted current that feeds the interleaved converter.

Magnetic materials used for medium PE applications already require to work in the frequency range of several hundred kHz, specially if new semiconductors will be driving such systems, such as SiC or GaN, explained by Bowers JS<sup>5</sup> and Shur MS<sup>6</sup>. In the case of interleaved converters, the effective frequency at the magnetic component is multiplied by the total number of magnetic circuits that are shared by the component. Hence, is necessary to use magnetic materials that allow operating frequencies in the MHz range. Recent works on ceramic materials offer the possibility to use Ni-Fe manganites that could respond to this requirement. The works from Lucas A. *et al.*<sup>7</sup> and Lucas.<sup>8</sup> shows the impact of Cu additions on the sintering and performance Ni-Fe manganites. The potential use of such materials on interleaved converters is largely dependant on the capability to make large passive components made of a ceramic material, along with the complex geometries required by such converters. A demonstration of the complex shapes required by interleaved magnetic components is shown in Figure 1, as explained by Costan V.<sup>9</sup> The objective of this work is to propose a method to obtain the large geometries needed by the interleaved converters for medium power applications.

When it comes to making a large ceramic component, two procedures are very important: shaping and sintering. In the case of shaping, it can be done either before sintering, on a green compact, or after sintering on a fully dense material. There are some examples of multicellular converters that are shaped from commercial ceramic components, as explained by Videau N<sup>10</sup> and

Forest F.<sup>11</sup> This method has the disadvantage that materials are hard and brittle, and only diamond-based tools are adapted to this step. We propose to shape the green body of the pressed ceramics prior sintering and explore the impact of pressing technique on the magnetic properties, then we will give a model of realization of a large magnetic component.

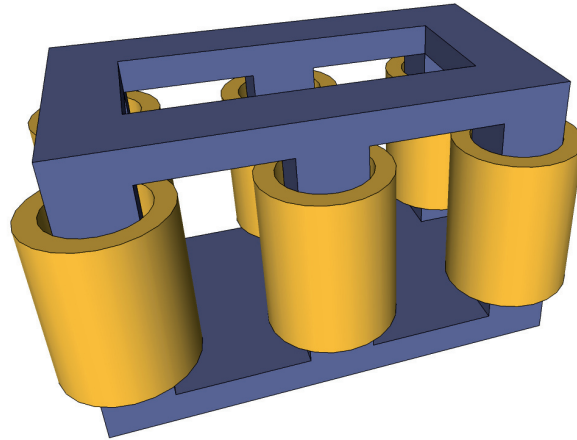

Fig. 1. Scheme of a six-legged Intercellular Current Transformer (ICT).

## EXPERIMENTAL

The used ceramic powders are based on a Ni-Zn-Cu ferrite studied by Lucas A *et al.*<sup>8</sup>, with a permeability ( $\mu'$ ) above 300 and with an operating frequency of at least 1 MHz (resonance frequency). For any given application the final permeability values, losses and operating frequency can be tuned by the control of the doping in the ferrite crystalline structure, studied by Valenzuela R.<sup>12</sup>

Samples were prepared with a powder with a composition of  $\text{Ni}_{0.3}\text{Zn}_{0.55}\text{Cu}_{0.15}\text{Fe}_{1.97}\text{O}_3$ , obtained by a solid-state reaction of an stoichiometric mixture of the elementary oxides (NiO,  $\text{Fe}_2\text{O}_3$ , ZnO and CuO) at 850°C for 2 hours. The powder was wet-milled by attrition to attain an average particle size of  $\sim 1 \mu\text{m}$ , then dried and mixed with an organic binder (1.5% vol.) to promote its cohesion during the pressing. Prior research on this material has been optimized using uniaxial pressing, nevertheless, for large shapes, it would be more appropriate to use isostatic pressing to ensure the green density homogeneity. A comparison between both pressing methods is done to evaluate its impact on the final properties. Powders were pressed using uniaxial pressing at 150 MPa and cold isostatic pressing (CIP) between 150 and 250 MPa (EPSI NV). For the CIP, it is necessary to use a deformable mould, this was developed in-house and described in the following section. After the pressing, samples were machined by a numerical drill to obtain toroidal shapes (18 mm external diameter, 6 mm internal diameter, and 4 mm thickness), needed for the electrical characterization. The tores were then wound with a wire and characterized in ac with an RF impedance meter (Hewlett Packard 4291A). From the series impedance ( $L_s$ ) and the series resistance ( $R_s$ ), it is possible to extract the real ( $\mu'$ ) and imaginary ( $\mu''$ ) components of the magnetic permeability.

$$\mu' = \frac{\pi \cdot L_s \cdot (\phi_{ext} - \phi_{int})}{\mu_0 \cdot N^2 \cdot \ln\left(\frac{\phi_{ext}}{\phi_{int}}\right)}; \mu'' = \frac{\pi \cdot R_s \cdot (\phi_{ext} - \phi_{int})}{\mu_0 \cdot N^2 \cdot \omega \cdot \ln\left(\frac{\phi_{ext}}{\phi_{int}}\right)}; \omega = 2\pi f \quad (1)$$

$\mu_0$  is the vacuum permeability,  $N$  the number of turns in the tore, and  $f$  the frequency.

Microstructure was observed by scanning electron microscopy (Jeol JSM 6390 LV). After process optimization was done, multicellular magnetic component was shaped and sintered.

### CIP mould preparation

The final shape of a multicellular magnetic components for medium PE depends on the material properties at the operating frequency, voltage and currents. From a research perspective, we aimed a process that would be as flexible as possible in order to obtain any given shape that a system designer could imagine, this of course coupled to CIP to produce large volume objects. This required the use of a soft-bag system to press the powders. To realize the soft-bag mould, the steps followed were:

1. Positive model preparation
2. Preparation of master mould (negative)
3. Polyurethane resin preparation
4. Vaccum casting and de-moulding

The positive model was printed with a 3D printer (3D EDEN 250) in an acrylic-based resin; Figure 2 a). Then this model was casted within a silicon resin, that would act as a negative mould; Figure 2 b) through d). After removing the model, polyurethane-based resin was poured in the mould to obtain the final soft-bag at a desired shape.

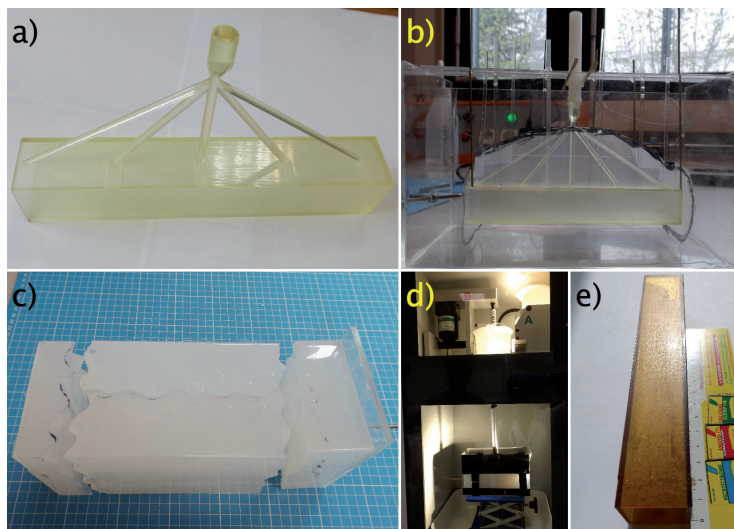

Fig. 2. Steps required to prepare a soft-wall mould for CIP.

The soft-bag thickness and hardness is very important, since a thick wall will transmit a large mechanical constraint to the CIP green body, that would lead to cracks and mechanical failure. An example of such problem is illustrated in Figure 3.



Fig. 3. Green-body moulded with a thick wall soft-bag. The cracks can be observed in the surface. These cracks are formed after the pressing, while reducing the isostatic pressure.

## RESULTS AND DISCUSSION

### Sintering conditions determination

Sintering cycle was optimized taking into account the mass losses during binder burnout and the maximum densification rate. Two analysis were performed to the pressed compacts, thermogravimetric analysis (TGA) and thermomechanical analysis (TMA), shown in Figures 4 and 5 respectively.

The final sintering cycle of the powders is hence performed by an initial de-binding step at 400°C attained at 1°C/min ramp, then sintering is performed at 1080°C (3°C/min ramp) with a dwell time of 2 h.

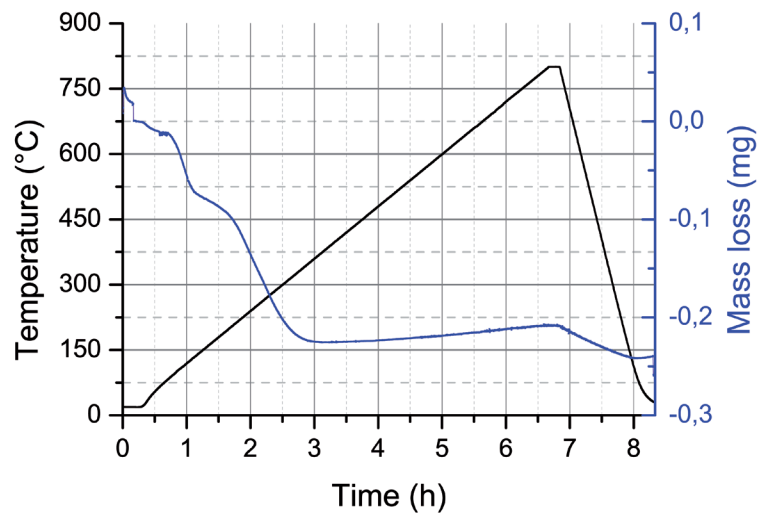

Fig. 4. TGA of the binder burn-out of the formulated Ni-Zn ferrite powders. Binder is completely removed by 400°C.

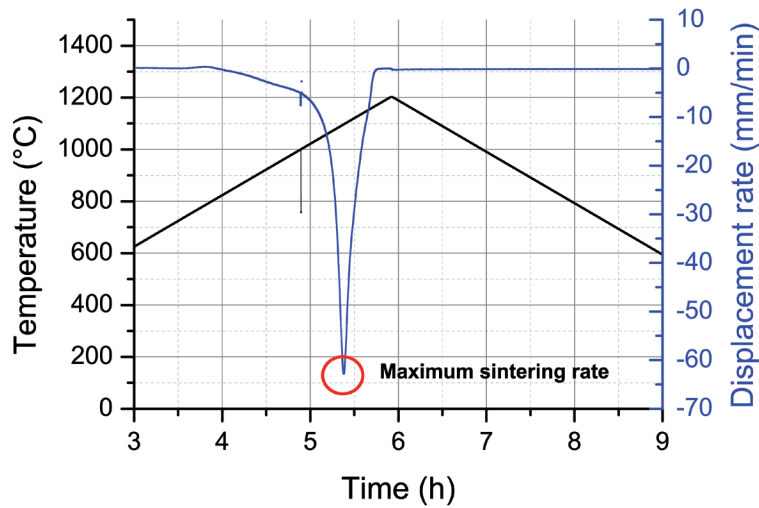

Fig. 5. TMA of a compact of Ni-Zn ferrite powders. Maximum densification rate is obtained in the range of 1050°C to 1000°C.

### Impact of the pressing method on the magnetic properties

Since there is no information on the literature concerning the impact of the CIP on the properties of Ni-Zn ferrites, we first made a comparison between the uni-axially pressed and isostatically pressed compacts, sintered under the conditions determined in the previous section. The characterizations of the Figure 6 show that a slight increase on the magnetic permeability is obtained by CIP-issued tores. The increase in  $\mu'$  could be attributed to a higher density ceramics obtained by CIP. The increase is not significant from an application point of view, considering that measuring errors (from the geometry) could account up to 10% of the reported values.

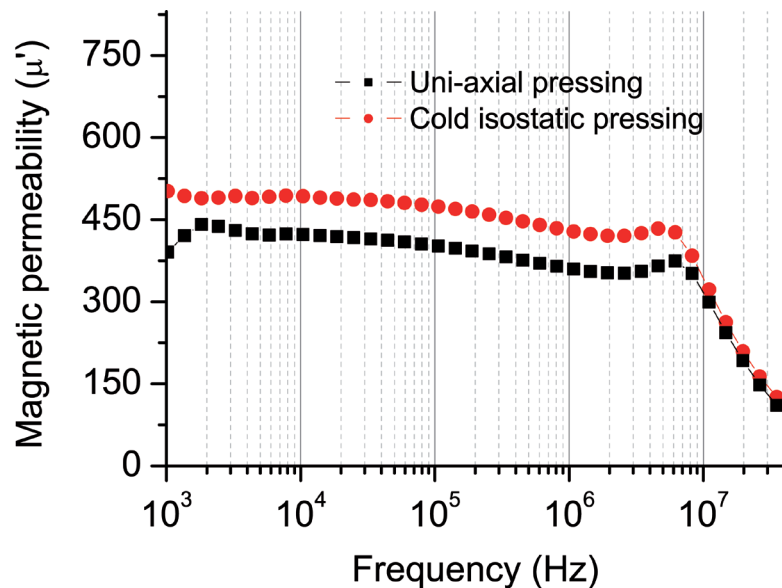
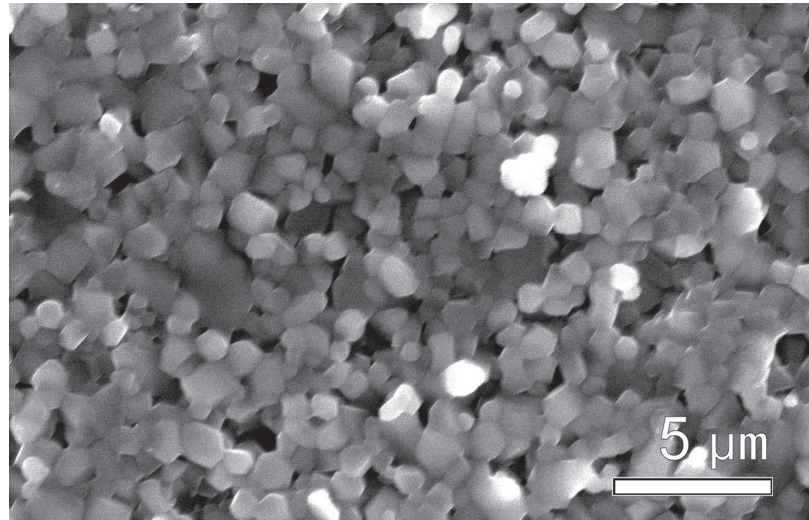

Fig. 6. Magnetic permeability ( $\mu'$ ) of sintered tores issued from uni-axially and CIP. The resonant frequencies correspond to the peaks observed at 4 to 6 MHz.

The final microstructure of the CIP sintered Ni-Zn ferrites is shown in Figure 7. A mono-dispersed grain size of around 1  $\mu\text{m}$  allows for a single resonance frequency (4-6 MHz) in the magnetic properties.



**Fig. 7.** Microstructure of a CIP Ni-Zn ferrite sintered at 1080°C with a dwell time of 2h.

### **Machining of a multicellular magnetic core**

Once the main processing parameters of powder preparation and sintering conditions were determined, a large green-body was pressed with CIP to mill a multicellular magnetic core.

The main steps realized in this part are:

1. Computer-aided design of a particular shape (multicellular magnetic core)
2. Transfer to the milling machine (2D Charlie 4U)
3. Green-body fixing or gluing to an acrylic plate for mechanical stability.
4. Machining

The machining process is presented in Figure 8 . Several test were performed to determine the milling parameters. The first set of parameters were found empirically from the experience on the machining of aluminium. The main problem was the aspiration of the powders, since we opted for a dry-machining process. The powders were collected with an aspirator with an HEPA-E12 filter.

Once the milling parameters were determined a green-body was machined and sintered. A first sample of realization is shown in Figure 9. A 5-legged magnetic core was realized, taking into consideration the recent works in an interleaved multicellular converter for GaN switching devices, researched by Videau N. <sup>10</sup>



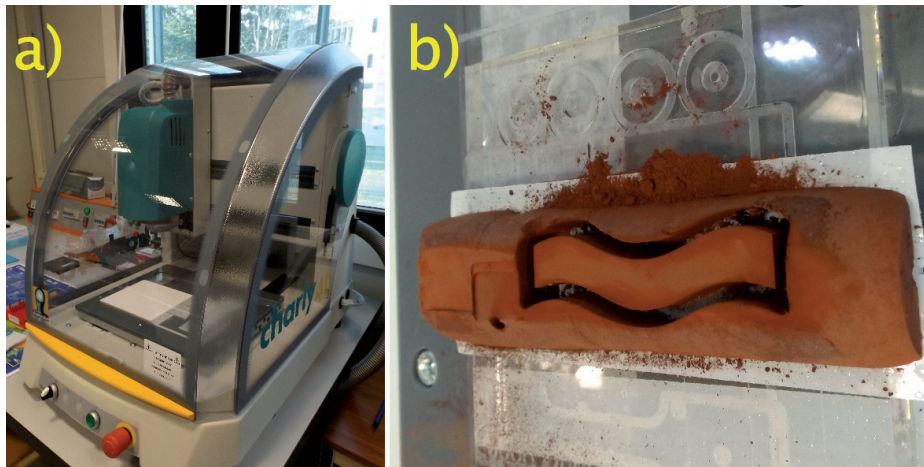

**Fig. 8.** Numerical tooling used in the machining of CIP green compacts of Ni-Zn ferrites.

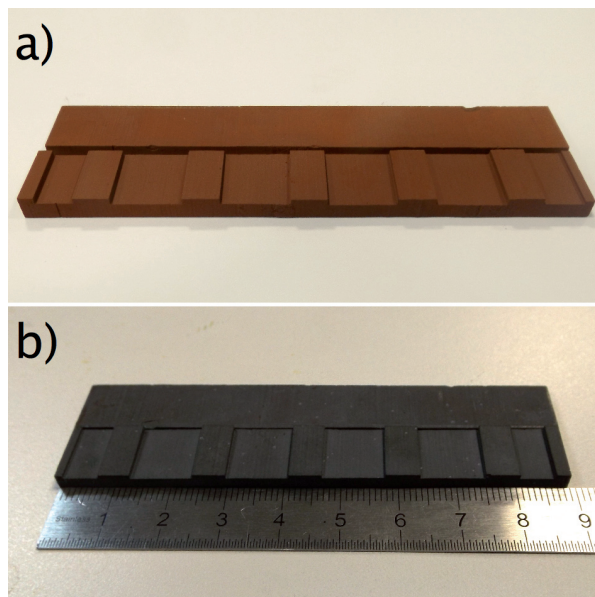

**Fig. 9.** 5-legged multi-cellular magnetic core. a) as-machined green-body, b) after sintering.

## CONCLUSION

Cold isostatically-pressed ferrite powders were formulated to obtain large magnetic cores required by medium power PE applications. Both the material properties (large permeability and high resonant frequency) and the process (CIP plus machining) allows for obtaining the complex shapes needed for a next generation of interleaved multicellular converters. Measurements under high magnetic fields are required to further explore the capabilities of the studied Ni-Zn ferrite formulation. Nevertheless, the present work proposes a general approach to obtain the complex shapes needed to develop new architectures in multicellular magnetic cores.

## REFERENCES

1. Meynard T, Forest F, Labouré E, Costan V, Cuniere A, Sarraute E. *Monolithic Magnetic Couplers for Interleaved Converters with a High Number of Cells. Integrated Power Systems (CIPS)*. Italy: 2006 4th International Conference on. 2006 January 1;1–6.
2. Lu D, Wong CP. *Materials for advanced packaging*. New York, USA: Springer-Verlag, 1<sup>st</sup> ed. 2009.
3. Doan T, Lebey T, Forest F, Meynard T, Valdez-Nava Z. *Cold isostatic pressing of screen-printed dielectric for power electronics passive component integration*. Journal of Materials Science: Materials in Electronics. 2015 January;26(4):2493–500.
4. Doan TB, Lebey T, Meynard T, Forest F. *Planar integrated multilayer capacitive substrate for DC-DC converter applications*. Energy Conversion Congress and Exposition (ECCE), 2013 IEEE . 2013 January;1874–9.
5. Bowers JS, Hopkins DC, Sarjeant WJ. *Packaging issues for next generation high voltage, high temperature power electronic modules*. Applied Power Electronics Conference and Exposition, 1997 APEC '97 Conference Proceedings 1997, Twelfth Annual . 1997 February;1:413–8.
6. Shur MS. *GaN and related materials for high-power applications*. New York, USA: Mater Res Soc Symp Proc. 1998 January;483:15–26.
7. Lucas A, Lebourgeois R, Mazaleyrat F, Labouré E. *Temperature dependence of core loss in cobalt substituted Ni–Zn–Cu ferrites*. Journal of Magnetism and Magnetic Materials . 2011 Mar 1;323(6):735–9.
8. Lucas A. *Etude et mise au point de transformateurs large bande*. Thesis. France: Ecole Nationale Supérieure de Cachan, 2010.
9. Costan V. *Convertisseurs parallèles entrelacés: étude des pertes fer dans les transformateurs inter-cellules*. Thesis. Toulouse, France: Institut National Polytechnique de Toulouse, 2007.
10. Videau N, Meynard T, Bley V, Flumian D, Sarraute E, Fontes G, et al. *5-phase interleaved buck converter with gallium nitride transistors*. Columbus, USA: Wide Bandgap Power Devices and Applications (WiPDA), 2013 IEEE Workshop on:190–3.
11. Forest F, Meynard TA, Huselstein J-J, Flumian D, Rizet C, Lacarnoy A. *Design and Characterization of an Eight-Phase-137-kW Intercell Transformer Dedicated to Multicell DC-DC Stages in a Modular UPS*. IEEE Transactions on Power Electronics . 29(1):45–55. 2013
12. Valenzuela, Raul. *Magnetic Ceramics*. Cambridge: Cambridge University Press, 1<sup>st</sup> ed, 1994.