



**HAL**  
open science

## Foundations of plasma surface functionalization of polymers for industrial and biological applications

Jean-Paul Booth, Miran Mozetič, Anton Nikiforov, Christian Oehr

### ► To cite this version:

Jean-Paul Booth, Miran Mozetič, Anton Nikiforov, Christian Oehr. Foundations of plasma surface functionalization of polymers for industrial and biological applications. *Plasma Sources Science and Technology*, 2022, 31 (10), pp.103001. 10.1088/1361-6595/ac70f9 . hal-03822222

**HAL Id: hal-03822222**

**<https://hal.science/hal-03822222v1>**

Submitted on 20 Oct 2022

**HAL** is a multi-disciplinary open access archive for the deposit and dissemination of scientific research documents, whether they are published or not. The documents may come from teaching and research institutions in France or abroad, or from public or private research centers.

L'archive ouverte pluridisciplinaire **HAL**, est destinée au dépôt et à la diffusion de documents scientifiques de niveau recherche, publiés ou non, émanant des établissements d'enseignement et de recherche français ou étrangers, des laboratoires publics ou privés.

TOPICAL REVIEW • OPEN ACCESS

## Foundations of plasma surface functionalization of polymers for industrial and biological applications

To cite this article: Jean-Paul Booth *et al* 2022 *Plasma Sources Sci. Technol.* **31** 103001

View the [article online](#) for updates and enhancements.

You may also like

- [Application of functionalized carbon dots in detection, diagnostic, disease treatment, and desalination: a review](#)  
Hamide Ehtesabi, Mehdi Amirfazli, Fatemeh Massah *et al.*
- [A new approach for the functionalisation of polysulfone with -cyclodextrin](#)  
Tarek M Abou Elmaaty, Stephen J Russell, Parikshit Goswami *et al.*
- [Recent progress in plasma-assisted synthesis and modification of 2D materials](#)  
Zhao Jun Han, Adrian T Murdock, Dong Han Seo *et al.*



# HIDEN ANALYTICAL

## Analysis Solutions for your Plasma Research

- Knowledge,
- Experience,
- Expertise

[Click to view our product catalogue](#)

Contact Hiden Analytical for further details:  
**W** [www.HidenAnalytical.com](http://www.HidenAnalytical.com)  
**E** [info@hiden.co.uk](mailto:info@hiden.co.uk)



Surface Science

- ▶ Surface Analysis
- ▶ SIMS



3D depth Profiling

- ▶ 3D depth Profiling
- ▶ Nanometre depth resolution



Plasma Diagnostics

- ▶ Plasma characterisation
- ▶ Customised systems to suit plasma Configuration



Mass and energy analysis of plasma ions

- ▶ Mass and energy analysis of plasma ions
- ▶ Characterisation of neutrals and radicals

## Topical Review

# Foundations of plasma surface functionalization of polymers for industrial and biological applications

Jean-Paul Booth<sup>1,\*</sup> , Miran Mozetič<sup>2</sup> , Anton Nikiforov<sup>3</sup>  and Christian Oehr<sup>4</sup> 

<sup>1</sup> Laboratoire de Physique des Plasmas (LPP), CNRS, Sorbonne Université, Ecole Polytechnique, Institut Polytechnique de Paris, 91120 Palaiseau, France

<sup>2</sup> Department of Surface Engineering, Jozef Stefan Institute, Ljubljana, Slovenia

<sup>3</sup> Department of Applied Physics, Ghent University, Jozef Plateaustraat 41, B-9000 Ghent, Belgium

<sup>4</sup> Fraunhofer Institute for Interfacial Engineering and Biotechnology IGB, Nobelstr. 12, 70569 Stuttgart, Germany

E-mail: [jean-paul.booth@lpp.polytechnique.fr](mailto:jean-paul.booth@lpp.polytechnique.fr)

Received 12 January 2022, revised 9 May 2022

Accepted for publication 18 May 2022

Published 18 October 2022



CrossMark

## Abstract

Polymer materials are widely employed in many fields due to the ease with which they can be formed into complex shapes, their versatile mechanical properties, light weight, and low cost. However, many applications are hindered by the chemical compatibility of polymer surfaces, which are generally hydrophobic and bond poorly to other media such as paints, glues, metals and biological media. While polymer surfaces can be treated by wet chemical processes, the aggressive reagents employed are detrimental to the environment, limiting the range of modifications that can be achieved by this route. Plasma functionalization is an attractive alternative, offering great versatility in the processed surface characteristics, and generally using environmentally benign compounds such as rare gases, oxygen and nitrogen, as well as very small quantities of organic precursors. Since the modified surfaces are only a few monolayers thick, these processes are extremely rapid and low in cost. The first industrial process to be developed was plasma oxidation, which increases the surface energy of the polymer, improving the adhesion of paint, glue and metal to the component. Plasma oxidation can be achieved using both low-pressure and atmospheric pressure (APP) discharges. Subsequently, many other processes have emerged, allowing other functional groups to be grafted, including amines, hydroxyl and carboxylic acid groups. Plasma polymerization, starting from gaseous monomers, allows a whole new family of surface chemistries to be created. These processes have many exciting applications in the biomedical field due to the control they give on biocompatibility and selective interaction with living cells. This article will present the fundamentals of plasma interactions with polymers, the plasma devices employed (both at low-pressure and at APP) with their advantages and drawbacks, and a survey of current and future applications.

\* Author to whom any correspondence should be addressed.



Original content from this work may be used under the terms of the [Creative Commons Attribution 4.0 licence](https://creativecommons.org/licenses/by/4.0/). Any further distribution of this work must maintain attribution to the author(s) and the title of the work, journal citation and DOI.

Keywords: polymer, surface functionalisation, plasma surface interaction, atmospheric pressure discharge, radiofrequency discharge

(Some figures may appear in colour only in the online journal)

## 1. Introduction

The science and industrial use of polymers has exploded since the 1950s, to the point where they are present in almost every area of our daily life. By the end of the 1980s the volume of polymers produced globally exceeded that of steel, and is currently around 370 million tons per year. The main applications are packaging (more than 30%), followed by building and construction (more than 20%), and automotive, electrical and electronic products (each 7 to 10%). Less than 2% by weight is used in the medical sector, about one half for packaging (e.g. prefilled syringes, blood pouches etc) and the rest for devices. This widespread use of polymers is due to their unique properties, notably their ease of manufacturing, their low density, mechanical flexibility, chemical stability (at least at low temperature) and low cost. However, a major drawback of almost all cheap polymers is their low surface energy. While the bulk properties of a chosen polymer (density, chemical inertness, mechanical elasticity or stiffness etc) can be adequate for the demands of finished products, very often the surface properties are not, and must be modified. This is especially true for biomedical applications. Since biology always occurs in aqueous media, the materials employed in this field must have adequate wettability (similar to glass), otherwise droplets of biological liquids (blood etc) will roll off. Therefore, polymer devices used for biological liquid handling must be made wettable.

The easiest way to render a polymer wettable is to oxidize the surface. Four approaches have been developed: (a) oxidation by a strong oxidizing agent in a wet chemical process, (b) flame treatment, (c) atmospheric pressure (APP) plasma treatment, typically by corona discharge or dielectric barrier discharge (DBD) and (d) low-pressure plasma treatment. The use of wet chemical treatment is declining due to ecological considerations, but all of the gas phase methods are in use. Flame treatment and low-pressure plasma treatment are better for large and curved areas (three-dimensional areas, e.g., bumpers for cars to guarantee homogeneous varnishing), while DBD and corona discharges are often used for flat surfaces (two-dimensional areas, film coating for e.g. packaging). In these processes the plasma splits the feedstock gas molecules (oxygen, with nitrogen, if air is used) to produce reactive species which can cleave the bonds on the polymer surface to produce radical sites. These can, in turn, react with other species in the gas phase. Depending on the composition of the gases used, the type of discharge and the composition of the polymer, different gaseous reactive species will be produced resulting in different oxygen and/or nitrogen bearing

functionalities on the treated surface. Furthermore, any impurities in the feed gas (notably H<sub>2</sub>O if ambient air is used) will affect the final surface composition. Generally, all of the functional groups produced at the surface tend to enhance the surface energy. Hence the wetting behaviour is improved, almost independent of the amount, kind and distribution of the different functionalities generated at the surface. If only oxygen gas is used, such plasma treatment is generally referred to as 'plasma oxidation'. If other gases or mixtures are used it is generally called 'plasma functionalization'. Unfortunately, the term 'functionalization' is not well defined in the plasma community and can take different meanings in different contexts. Modification of surface properties is achieved by creating so-called 'functional groups' on the surface. Functional groups are chemical units with well-defined reactivity. One way to achieve this is to modify only the outermost surface, for example by oxidation or by plasma activation using noble gases (creating radical sites for post reactions) or water vapour to abstract hydrogen. Another way to change the surface functionality is to deposit a thin film by plasma polymerization of a precursor gas containing carbon or silicon. This produces a cross-linked film with a different surface functionality to the substrate. Plasma enhanced chemical vapour deposition (PECVD), in which the objective is to coat the substrate with a film of sufficient thickness to provide significant mechanical or diffusion barrier properties, is the subject of another foundations article by Snyders *et al.* Nevertheless, we will present here some applications which employ plasma polymerization, but only those where the objective is the modification of the surface chemical functionality. In this case, functional groups buried in the film will have no impact on the final applications, so the film thickness is unimportant. Therefore, we define plasma functionalization as a process which aims to modify the chemical nature of the outermost surface. This is complementary to thin film deposition, where the mechanical and morphological properties of the deposited coatings are of paramount importance, in addition to chemical changes.

When plasma oxidized or functionalized surfaces are exposed to the ambient environment they undergo further changes. The remaining radical sites will either recombine or react with components in the gas phase. Peroxide functional groups will undergo further oxidation. Finally, the surface can reorganize so that the outer functional groups are turned inside, decreasing the total surface energy. This latter effect is prominent if the polymer consists of longer polymer chains, which can rotate easily. Such behaviour is well known for polyethylene (PE), PVC and related polymers. To summarize, polymer surfaces evolve continuously both during and immediately after plasma treatment, before slowly becoming stable.

The complex interaction of plasma-generated species, (including charged particles, vacuum ultraviolet (VUV) and ultraviolet (UV) radiation, neutral radicals, and metastable atoms and molecules) with polymer surfaces provides unique opportunities for surface engineering. Plasma functionalization of polymers has many uses in both scientific research and for industrial applications. It allows the fabrication of novel objects with precise control of both the surface chemistry and morphology combined with almost negligible modification of the polymer bulk characteristics. These surface modifications can be controlled at the micro, nano, molecular, and even atomic scale. This brings many challenges for the understanding and development of the processes, but also provides opportunities for the development of new surfaces with a broad range of potential applications.

This paper focuses on the fundamentals behind plasma functionalization of polymers. It is aimed at readers interested in surface engineering, reactor design and the biomaterials field. Special attention is paid to explaining the basic mechanisms occurring, supported by an overview of recent literature. Several practical applications are presented, and different approaches to the transfer to large scale production are explained. This foundation article aims to be useful to a broad audience. It introduces the fascinating world of plasma technology to researchers, engineers and graduate students who are interesting in the development of novel materials with unique properties.

## 2. Surface science aspects of plasma polymer treatment

Polymer surfaces can be characterized using a range of techniques, which can be applied before and after the treatment. This not only allows a better understanding of the surface modification mechanisms but is also a valuable tool for process development and control.

### 2.1. Surface energy measurement

The most commonly-used polymer surface characterization technique is the evaluation of wetting properties by the sessile drop technique. Contact angle measurements are easy to perform and very sensitive; they give information about the surface properties to a depth of about 1 nm or less. A droplet of a fluid, usually water, is positioned on the surface and its contact angle (both advancing and receding) is measured. The surface free energy can be calculated from these angles, provided that the surface is perfectly flat and chemically homogeneous. Nevertheless, in many practical situations there is significant surface roughness and chemical inhomogeneity, making such an interpretation more questionable. Several algorithms are commonly used to calculate the integral surface tension, which can be decomposed into various components (disperse and polar contributions etc). More detailed information, and ways to avoid pitfalls in such measurements and their interpretation, can be found in articles debating this topic from 2011 [1–3].

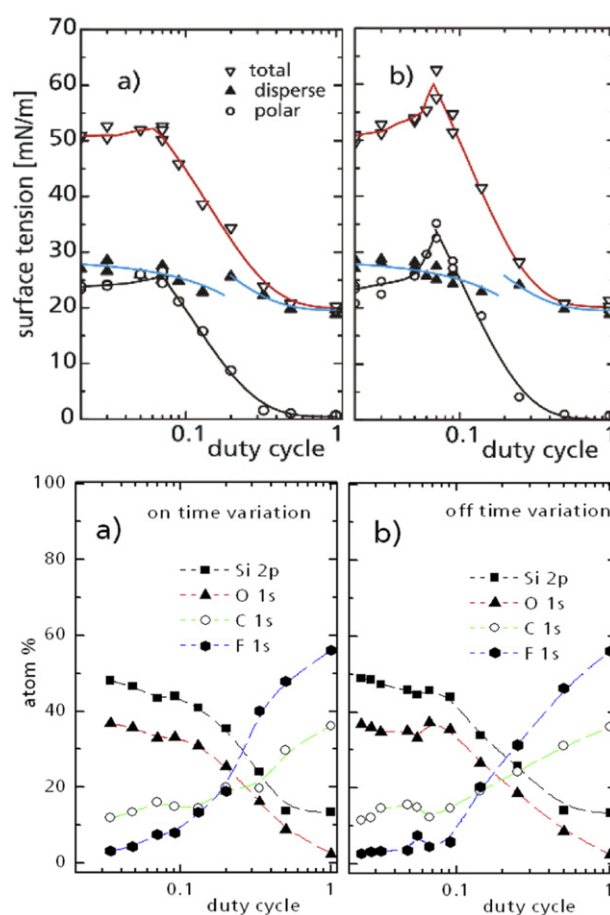

**Figure 1.** Surface tension and surface chemistry variation with applied duty cycle. Conditions: RF 13.56 MHz; process gas 4 sccm  $\text{CHF}_3$  + 25 sccm Ar; pressure 0.8 mbar, treatment duration 60 s, peak power 8 W. (a) Off time 200 ms, on time varied; (b) on time 5 ms, off time varied [5].

As an example, figure 1 shows the effect of treating polycarbonate and silicon surfaces with a low-pressure plasma containing argon and  $\text{CHF}_3$ , operated in a pulsed-power mode. The surface tension, and the chemical composition of the surface, are found to vary strongly with the duty cycle. At very low duty cycles the surface becomes slightly more hydrophilic as the duty cycle is increased. No deposition occurs, and etching dominates. As the duty cycle is increased further, net deposition of fluorocarbon films starts to occur, but initially only in patches. As the duty cycle approaches 100%, the whole surface becomes covered with fluorocarbon film. In intermediate cases, the fractional surface coverage correlates to the surface tension. The increase in surface coverage is also accompanied by an increase in fluorine content. This can affect cell adhesion, which decreases with increased fluorocarbon coverage and decreased surface energy. This example shows the potential for fine-tuning plasma treatment between deposition and etching. Yasuda (a pioneer in plasma polymerization) was the first to propose this mechanism of competitive ablation and polymerization [4] and demonstrated the high sensitivity of both the contact angles and mammalian cells adhesion to tiny incremental changes in surface composition [5].



## 2.2. Film structure and mechanical properties

Surface topology affects wetting properties and has a significant impact on biological applications. Depending on the surface composition, roughness can make the surface either more hydrophilic or more hydrophobicity compared to a flat surface. Surface morphology can be probed by various microscopy techniques, including scanning electron microscopy (SEM), optical microscopy and atomic force microscopy (AFM). AFM provides topographical information (e.g. roughness) as well as mechanical data (e.g. surface stiffness) [6, 7]. SEM is usually equipped with x-ray microanalysis, which probes the elemental composition to a depth of about 1  $\mu\text{m}$ . In the case of film deposition, the thickness can be measured by interferometry or by ellipsometry. The interpretation of ellipsometry results is straightforward when the substrate is sufficiently reflective, the films are sufficiently transparent and their absorption coefficient is known [8, 9]. If this is not the case, more complex optical models are necessary. Finally, for porous materials (such as scaffolds and membranes) the specific surface area ( $\text{m}^2 \text{g}^{-1}$ ) can be determined using the Brunauer, Emmett and Teller algorithm [10]. For example, membranes for blood cleaning surface functional group density can be estimated from the specific surface area and the total number of functional groups.

## 2.3. Surface composition analysis

The atomic composition of surfaces and thin polymer films can be determined by x-ray photon spectroscopy (XPS or ESCA) [11]. This method has a coarser lateral resolution compared to Auger-electron-spectroscopy, but can be applied to electrically-insulating samples (such as polymers) provided that precautions are taken to avoid charging of the surfaces by the electron emission. All elements (with the exception of hydrogen and helium) can be detected by XPS. The probed depth is up to about 10 nm, with a lateral resolution of a few tens of micrometers. High-resolution XPS spectra can allow quantification of the oxidation degree for certain elements, due to the so-called chemical shift (decreased electron density at the measured atoms). In the case of carbon, the peak shape can be fitted as a sum of the peaks corresponding to carbon atoms in  $\text{CH}_x$ ,  $\text{C-OH}$ ,  $\text{C=O}$ ,  $\text{COOH}$  and  $\text{CF}_x$  moieties. In recent decades, sputtering using an Ar cluster ion source combined with XPS has been developed to allow reliable depth profiling of the polymer composition. To summarize, XPS can provide the elemental composition of polymer surfaces and thin polymer films; in the case of carbon and certain other elements the chemical bonding environment can also be probed.

## 2.4. Identification and quantification of functional groups

When XPS is unable to distinguish specific functional groups on the surface, it can be complemented by infrared (IR) and Raman spectroscopy [11]. For example, XPS cannot distinguish epoxide groups from two vicinal carbon atoms with hydroxyl groups. However, with IR spectroscopy the signal for the three-membered-ring is easily identified. Another difficulty is to distinguish amino-, imine- or amide groups after

nitrogen plasma treatment. Amino- and amide groups can be differentiated by modern XPS tools which can resolve the 0.8 eV difference in their binding energies. However, discriminating between amino-groups and imine-groups is not easily done, since the XPS binding energies are almost identical.

Direct optical measurements on uneven surfaces e.g. membranes and fleeces may give false results due to light scattering at the surface, therefore it can be better to first mark the groups with a dye (a technique known as derivatization), followed by extraction into solution. For example, amino-groups can be reacted with a specific dye such as sulfo-SDTB [12]. The samples are then thoroughly rinsed, so that only the chemically bonded dye remains on the surface. The dye is then cleaved off, and its concentration is measured in solution. Several derivatization reagents exist for these functional groups [13]. A further consideration is that the size of the dye molecule determines the maximum number of functionalities per area that can be detected. Alternatively, the groups can be decorated with a dye and then measured directly with XPS, without the need for the washing step.

## 2.5. Measuring radical densities in films

Radicals produced in the plasma can play an important role in functionalization as well as in plasma polymerization. Plasma polymerized films can contain significant densities of free radicals. Polymer surfaces in contact with plasma are subjected to fluxes of UV photons, electrons and ions, all of which can create free radicals at the surface.

Free radicals in materials can be analysed using the electron spin resonance (ESR) technique, which gives quantitative measurements of the total radical density. The high sensitivity of ESR allows samples containing only  $10^{11}$  unpaired electrons (radicals) to be analysed. This corresponds to one radical per thousand atoms in a monolayer of  $1 \text{ cm}^2$  size.

The ESR analysis of free radicals in polymers was developed in the 1980s, focusing on single-wavelength UV treatment of chemically pure PE with well-defined chain length, producing a relatively simple distribution of primary, secondary and or tertiary carbon radicals. However, plasma-treated films are more complex, often containing a wide variety of radicals; the unpaired electrons can be located on primary, secondary or tertiary carbon atoms as well as on oxygen or nitrogen atoms. Interpretation of the ESR spectra is more difficult in this case, which may explain why ESR is less commonly used now. Furthermore, time-resolved measurements allow radicals to be grouped according to their reactivity [14]. To sum up, quantitative data (number of radicals present) are easily collected, but qualitative assignment to specific radicals is difficult if these are present at the same time in the film as it is the case for plasma-polymerized films. Table 1 presents examples of various plasma films containing different quantities of radicals.

As well as direct characterization of surface radicals, the ESR spin-labelling technique has been developed to allow other (non-radical) chemical functional groups to be quantified [15]. The functional groups are labelled with so-called ESR-labels, which are compounds containing both a stable

**Table 1.** Radical density measurement for different plasma polymerized films and PET treatment (unpublished data, Fraunhofer IGB).

Precursor	Power density ( $\text{W cm}^{-2}$ )	Spin density ( $\text{cm}^{-3}$ )	Percentage of C-radicals in total C-content
c-C <sub>4</sub> F <sub>8</sub>	0.17	$1.2 \times 10^{20}$	0.94%
c-C <sub>4</sub> F <sub>8</sub> + H <sub>2</sub>	0.17	$0.6 \times 10^{20}$	0.47%
AAc CH <sub>2</sub> =CH-COOH + H <sub>2</sub>	0.07	$1.5 \times 10^{18}$	0.004%
Ethylene H <sub>2</sub> C=CH <sub>2</sub> (1)	0.63	$6.0 \times 10^{20}$	1.55%
Ethylene H <sub>2</sub> C=CH <sub>2</sub> + H <sub>2</sub> (2)	0.63	$4.9 \times 10^{20}$	1.79%
PET foil treatment (30 min Ar)	0.2	$1.3 \times 10^{13}$ spin $\text{cm}^{-2}$	—

**Table 2.** Grafting of acrylic acid after activation on PP, PTFE and PVDF. Reprinted from [16], Copyright (1999), with permission from Elsevier.

Substrate	Activation	Composition by ESCA in at%							
		CF <sub>2</sub>	COOH	COH	COC	CH <sub>2</sub>	O	N	F
Poly-propylene	Untreated	—	—	—	—	100	—	—	—
	H <sub>2</sub> O grafted	—	4.4	—	7.2	73.4	15	—	—
	N <sub>2</sub> grafted	—	7.3	—	<0.1	70.2	20.8	1.7	—
PTFE	Untreated	31.9	1.2	—	—	—	—	—	66.9
	H <sub>2</sub> grafted	17.4	9.0	6.0	—	19.1	14.0	—	34.5
PVDF	Untreated	23.7	—	—	—	27.5	0.3	—	48.5
	O <sub>2</sub> grafted	19.3	—	5.5	—	28.5	7.0	—	39.7
	Ar grafted	—	17.3	1.7	—	43.8	31.8	—	5.5

radical site and a group designed to react with a specific group on the surface. Such spin labels have been developed for carboxylic, amino and other groups. The density of the bonded labels is then quantified by ESR. If the plasma-treated film already contains radicals, they will also make a contribution to the total ESR signal, which must therefore be subtracted. This method can provide sensitivity in the region of one functional group per 10 square nanometers.

## 2.6. Other surface analysis techniques

The selection of techniques presented here is based on the literature of plasma polymer treatment, but other surface analysis techniques exist. From the perspective of biological or medical applications, other optical (e.g. fluorescence measurement and staining) techniques can be useful. Before any medical product or device can be released, further characterization must be carried out according to European standards, in this case EN ISO 10993. Depending on the environment where a particular device will come into contact with a patient, a specific set of standards (concerning the physical, chemical and biological level) must be satisfied.

## 2.7. The recovery effect of plasma-treated polymers

An important issue in the field of plasma treatment of polymers is that the observed activation and change of the surface chemistry often relaxes over time, a phenomenon known as the recovery process. Rotation of polymer chains near the surface is one of the mechanisms responsible for such hydrophobic recovery. Such recovery can be reduced by grafting the required functionalities onto the surface, rather than surface activation. The surface is first plasma-treated using

non-polymerizing gases (such as water vapour, oxygen, hydrogen or noble gases) to produce reactive sites (radicals). This radical-rich surface is then exposed to monomers that polymerize on contact with the surface radicals, via their double bonds. Such monomers typically possess vinyl or an acrylic groups, which can react directly to attach the molecule to the surface. In this way, the rotation of bulk polymer molecules is hindered.

Table 2 shows the result of grafting on three common polymers were treated by plasma with different gases and then exposed to acrylic acid [16]. To evaluate the stability of the grafted surfaces, the samples were treated with alcohol for 3 h in a Soxhlet extractor, followed by XPS analysis. The acrylic group serves to bind the molecules to the surface, and some carboxylic groups remain available after Soxhlet extraction. It can be seen that oxygen plasma activation is not effective with polyvinylidene fluoride (PVDF), due to the strength of carbon–fluorine bonds which cannot be attacked by oxygen atoms (oxygen plasma treatment was not tested on PTFE). On the other hand, argon plasma treatment (which produces high energy UV photons) is more effective at preparing the surface for grafting.

It should be noted that the XPS spectra are fitted supposing a plausible composition, with a set width of the peaks. This can lead to artifacts. For example, the analysis of untreated PTFE indicates the presence of some carboxyl, but it is clear that this is incorrect since no oxygen is detected. This result is in fact the consequence of choosing a too narrow width for the fluorocarbon peak, which overlaps the carboxyl peak region.

This recovery process, or aging, typically occurs over days or weeks, figure 2, with the initial fast stage taking place during some hours. The recovery, often also referred as aging, is

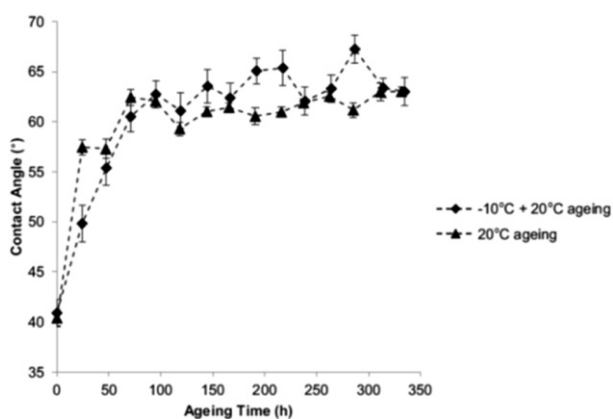

**Figure 2.** Recovery effect detected by the measurement of WCA as a function of storage time in the air at  $T = 20\text{ }^{\circ}\text{C}$  and  $\text{RH} = 50\%$ . Reprinted from [17], Copyright (2014), with permission from Elsevier.

observed in case of both low and APP plasma activation of polymer surfaces.

The mechanism of this aging is believed to be a combination of short-range processes which reorient the plasma-created polar groups into the bulk, and slower diffusion and polymer chain relaxation. Morent *et al* [18] investigated the hydrophobic recovery of poly-lactic acid (PLA) films in both inert (He and Ar plasma) and reactive  $\text{N}_2$  plasma atmospheres. The aging after inert gas activation was less pronounced, due to the high degree of cross-linking induced into the treated films. This effect limits the polymer chain mobility. The influence of the storage conditions on the recovery of the surface energy was investigated for PE films by Van Deynse *et al* [17]. They found that changes in the humidity, and lowering the storage temperature, can slow down the recovery process. Hydrophobic recovery is one of the important shortcomings of APP activation and must be carefully considered in any potential applications of plasma-activated polymers. To a certain extent, aging can be reduced by the appropriate choice of storage conditions.

Grafting procedures are very effective in generating hydrophilic surfaces, but the procedure (the grafting of the acrylic acid) takes time and is difficult to scale up: it is therefore only used for academic purposes. Although only a monolayer is necessary in principle for biomedical applications, thicker films (a few tens of nanometers) are generally used. These are more stable, and if some material is removed (by friction and abrasion) additional functional groups are present. These thin layers can be deposited by wet chemical treatment as well as from the gas phase e.g. by plasma polymerization. We will come back to this, and a discussion of the needs for biomedical applications, (biocompatibility) in section 5.

### 3. Low-pressure processes for surface energy modification

#### 3.1. Specificities of low-pressure plasmas

The generation of non-equilibrium gaseous plasmas in low-pressure reactors has been known for over a century [19].

Early authors predicted that it would be impossible to sustain a uniform, non-equilibrium plasma at elevated pressures [20]. This prediction was based on the knowledge of the loss mechanisms of reactive gaseous species. The neutralization of charged particles, the relaxation of metastables and the recombination of radicals to stable molecules are all exothermic reactions, thus transferring chemical energy into gas heating. These exothermic reactions in the gas phase often require a three-body collision to ensure energy and momentum conservation. The probability for three-body collisions in the gas phase increases as a square of the pressure [21]. The collision frequency depends on the cross-sections and kinetic energy of colliding gaseous particles, and is of the order of 1 MHz at APP, 10 Hz at 1 mbar, and approximately  $10^{-3}$  Hz at 1 Pa [22]. The lifetime of many reactive gaseous particles, therefore, decreases as a square of the pressure. The lifetime of reactive species depends on the time constant for recombination reactions, which can occur either in the gas phase or at the reactor surfaces. At APP, gas phase reactions are fast and dominate the loss (unless the reactor dimensions are very small), leading to lifetimes as short as microseconds. For low pressure plasmas (below about 1 mbar) gas-phase recombination processes are much slower, and can typically be neglected in comparison to surface reactions. Nevertheless, since low-pressure reactors typically have much larger dimensions (of the order 0.1–1 m) the reactive neutral lifetimes are generally in the millisecond range. Exothermic gas-phase reactions are super-elastic, meaning that the kinetic energy of particles after the collision is significantly higher than before the collision. These fast particles will collide with other molecules and atoms and thermalize efficiently since the masses of colliding particles are similar. As a result, almost the entire discharge power absorbed by plasma at high pressures will end up as the heat of the gas. The gas heating will obviously depend on the pressure: very intense at APP but almost negligible at pressures below about 1 mbar. The rapid destruction of reactive plasma species at APP by gas-phase reactions implies that significant concentrations only occur in regions where a large electric field is present. Elsewhere, the concentration will be negligible. On the other hand, in low-pressure plasma reactors the concentration of reactive species can be high across the whole volume, since they can diffuse in the reactor without experiencing three-body collisions. For this reason, low-pressure plasmas are widely used in numerous applications where high, laterally uniform fluxes of reactive plasma particles to a surface are required, combined with low neutral gas kinetic temperature.

At low pressure, the reactive particles generated by the plasma will diffuse across the discharge chamber and reach the chamber walls. In the absence of third body collisions, the chamber walls will play the same role, catalysing exothermic recombination reactions that remove the reactive species. Some of the recombination energy may be released as kinetic and internal energy of the desorbing molecules, but most will be absorbed by the walls facing the plasma. An important difference between atmospheric and low-pressure non-equilibrium gaseous plasma is, therefore, the destination of the energy released by reactive species loss: at APP, the gas is



heated, whereas at low pressure, the walls are heated. Therefore, the materials facing plasma at low pressure are often cooled (forced air or even water cooling), so that they remain close to room temperature.

However, in low-pressure plasmas super-elastic collisions are not completely absent. Examples of gas heating by gas-phase collisions include electron-impact dissociation of molecules, and the radiative dissociation of a resonant excited molecular level. Nevertheless, the neutral gas kinetic temperature in plasmas at pressures below about 1 mbar does not deviate significantly from the ambient temperature, provided that the chamber walls are cooled. For example, Booth *et al* [23] found the kinetic temperature in an oxygen plasma sustained in a glass tube by a simple DC discharge to be approximately 350 K at 70 Pa, 450 K at 300 Pa and 650 K at 1000 Pa.

Since the reactive particles in low-pressure plasmas are predominantly lost at surfaces, the global loss rate depends on the surface-to-volume ratio: large chambers are advantageous from this point of view. The loss rate will dictate the minimum power needed to sustain a plasma in the reactor. Large industrial plasma reactors are capable of operating at much lower specific power (power per plasma volume) than small experimental reactors [24]. In fact, some reactors with a volume of few m<sup>3</sup> can operate at a power density below 1 W l<sup>-1</sup> [25]. The power dissipated on the surfaces of plasma reactors depends on the incident fluxes of plasma particles, the type of exothermic reaction, and the reaction probability. The probability for surface neutralization of charged particles is always close to 1. On the other hand, the probability for heterogeneous surface recombination of atoms to stable molecules can be anywhere between approximately 10<sup>-4</sup> and 1. The relaxation of metastable atoms with high potential energy is very efficient on any surface, but the probabilities for particles less energetic metastable molecules energy is still a subject of research [26]. Although often ignored, the loss of reactive particles to the pumping system may also be significant.

An estimation of the loss rate of reactive plasma particles by pumping and by surface reactions is useful for the appropriate design of the low-pressure plasma reactor. The loss by pumping will depend on the effective pumping speed and the density of reactive particles in the reactor:

$$\left(\frac{dn}{dt}\right)_{\text{pumping}} = \Phi_V \cdot n. \quad (1)$$

Here,  $\Phi_V$  is the effective pumping speed (volume flow at the interface between the reactor and the pump duct) used for continuous pumping of the plasma reactor, and  $n$  is the density of reactive particles. This continual loss of reactive particles by pumping must be balanced by the excitation (creation) of the particles in the discharge, which will require a power of:

$$P_{\text{pumping}} = \left(\frac{dn}{dt}\right)_{\text{pumping}} \cdot E_0, \quad (2)$$

where  $E_0$  is the excitation energy of the particle. If the particles are oxygen atoms, the  $E_0$  in equation (2) is equal to or greater than 1/2 of the oxygen molecule dissociation energy, i.e., 2.6 eV. The loss of atoms, and the corresponding power

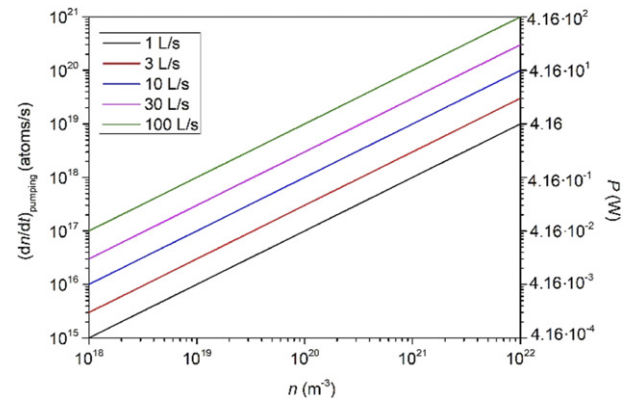

**Figure 3.** The loss of O-atoms by pumping a low-pressure plasma reactor (left y-axis scale) and appropriate power (right y-axis scale).

needed to sustain a certain density of O-atoms in a plasma reactor, is plotted in figure 3 as a function of the O-atom density. The lines show results for different effective pumping speed. The loss by pumping is negligible at low pumping speeds but becomes significant at large  $\Phi_V$  and atom density. A typical O-atom density in a properly designed plasma oxidation reactor is close to  $5 \times 10^{21} \text{ m}^{-3}$ , and the typical effective pumping speed is approximately  $50 \text{ m}^3 \text{ h}^{-1}$  ( $\Phi_V = 14 \text{ L s}^{-1}$ ) [27]. According to figure 3, the power needed to replace the O-atoms lost by pumping is 30 W. In practice, it is even greater, due to the super-elastic character of the electron impact dissociation of O<sub>2</sub> molecules. Therefore, high pumping speeds may not be optimal if the energy efficiency is the parameter of interest.

The rate of loss of neutral reactive particles by heterogeneous surface recombination (association to form stable molecules) can be expressed as

$$\left(\frac{dn}{dt}\right)_{\text{recombination}} = 1/4 \cdot n \cdot \langle v \rangle \cdot A \cdot \gamma. \quad (3)$$

Here,  $\langle v \rangle$  is the mean kinetic velocity of the particles  $\langle v \rangle = \sqrt{(8 \cdot k \cdot T) / (\pi \cdot m)}$  at a given neutral gas kinetic temperature,  $A$  is the total surface of the plasma reactor and  $\gamma$  is the loss coefficient. The surface loss on surfaces must be compensated by production in the gas phase, which will require a power of at least:

$$P_{\text{recombination}} = 1/4 \cdot n \cdot \langle v \rangle \cdot E_0 \cdot A \cdot \gamma. \quad (4)$$

The loss of O-atoms by heterogeneous surface recombination is plotted versus the atom density in figure 4. The mean kinetic velocity corresponding to room temperature is assumed to be  $\langle v \rangle = 630 \text{ m s}^{-1}$ . The loss rate depends directly on the recombination coefficient,  $\gamma$ , which takes various values for the lines in figure 4. Materials such as glasses and ceramics generally exhibit low coefficients, of the order of 10<sup>-3</sup> [23], so the loss of atoms and the power needed to replace them is marginal, i.e., a few W at the atom density of 10<sup>21</sup> m<sup>-3</sup>. This is often lower than the loss by pumping (figure 3). Many metals, however, have high (catalytic) activity for heterogeneous surface recombination, so the coefficient is typically

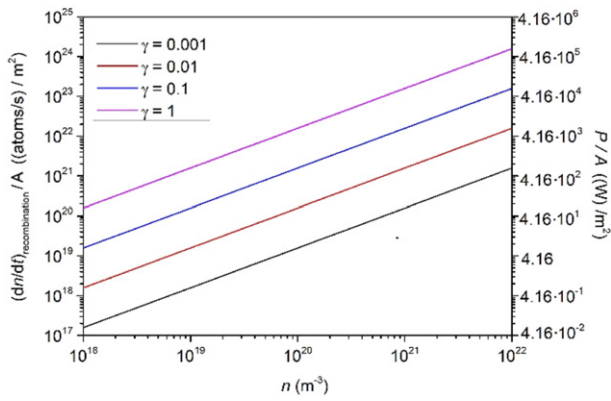
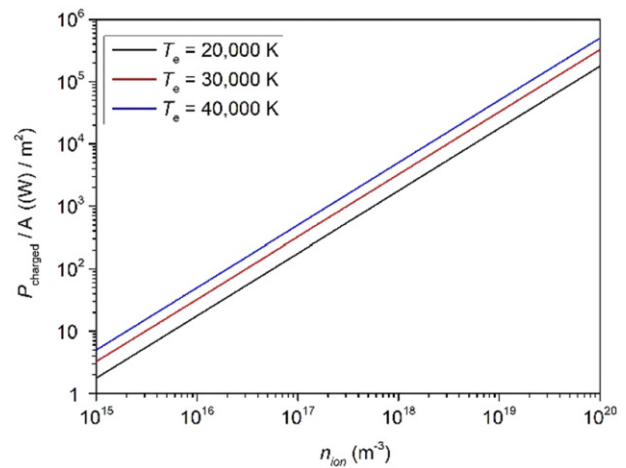

**Figure 4.** The loss of O-atoms by recombination on the walls of the plasma reactor (left y-axis scale) and appropriate power (right y-axis scale).

around 0.1 [28]. Reactors made of such materials are therefore poorly adapted for surface functionalization of heat-sensitive objects, so metallic chambers should be avoided, in particular where energy efficiency is important. The highest recombination coefficients have been measured for materials with complex surface morphology at the sub-micrometre scale [29]. The surface loss coefficient for such materials approaches unity because the atoms become trapped in pores where they experience many collisions with the surface, so they are likely to recombine to parent molecules before they can escape from the surface to the gas phase. The loss coefficient for polymers is typically between  $10^{-3}$  and  $10^{-2}$  at room temperature (see [30] and references thereafter), but little work has been performed on the evaluation of the loss rate at elevated temperatures. The loss coefficients on surfaces facing an active plasma may also increase by the fluxes of positive ions and UV and/or VUV radiation [23].

The calculations of the power dissipated on surfaces facing plasma according to equation (4) and figure 4 are directly applicable to the estimation of the thermal load which sample experiences upon treatment with low-pressure gaseous plasma. The surface area ( $A$ ) in equation (4) is just replaced with the sample dimensions to obtain the power dissipated on the sample surface due to the heterogeneous recombination of atoms.

By definition, plasma consists of free electrons and positively charged ions. In cases of electro-negative gases such as oxygen, a significant concentration of negatively charged ions can also be present [31]. Negatively charged ions may also be present in plasmas of electro-positive gases like hydrogen [32], but their concentration is a few orders of magnitude lower than in gases like oxygen. In any case, the negatively charged electrons have much larger mobility than the ions, so they will quickly flow to the surface of any plasma-facing material, causing the formation of a sheath between the surface and the bulk plasma. If the object is floating (i.e., far from any electrode), the voltage across the sheath will be [33]:



**Figure 5.** Heat dissipated on the surfaces of floating objects by charged particles.

$$\Delta V = \frac{k \cdot T_e}{e_0} \left( 2.8 + 0.5 \cdot \ln \left( \frac{m_i}{m_e} \right) \right). \quad (5)$$

Here,  $T_e$  is the electron temperature, and  $m_i$  and  $m_e$  are the masses of positively charged ions and electrons, respectively. For the case of molecular oxygen ions ( $O_2^+$ ), the  $m_i/m_e = 6 \times 10^4$ . A typical electron temperature in oxygen plasma is  $3 \times 10^4$  K, so the voltage across the sheath is approximately 19 V. In the collisionless sheath approximation, which is often satisfied for low-pressure plasmas, the  $O_2^+$  ions will bombard the surface of a floating object with a kinetic energy of approximately 20 eV. This energy will be dissipated on the surface and will cause heating of the object. The ions will also neutralize with the electrons on the surface.

The ionization energy of oxygen molecules is 12 eV, so the total energy released on the surface of a floating object due to the ion impinging is roughly 30 eV.

The heating power due to the interaction of charged particles with a floating object is:

$$P_{\text{charged}} = n_{\text{ion}} \cdot v_{\text{Bohm}} \cdot E_{\text{ion}} \cdot A. \quad (6)$$

Here,  $n_{\text{ion}}$  is the positive ion density in the bulk plasma,  $v_{\text{Bohm}}$  is the Bohm velocity ( $v_{\text{Bohm}} = \sqrt{k \cdot T_e / m_i}$ ), and  $E_{\text{ion}}$  is the sum of ionization energy and the kinetic energy of an ion gained across the sheath according to equation (5). The power dissipated on a floating object due to the interaction with charged particles is plotted in figure 5 as a function of the plasma density for different electron temperatures. The electron temperature is usually between approximately 20 000 and 40 000 K in oxygen plasmas used for surface activation of polymers, so the heating depends principally on the ion density, not the electron temperature. The typical plasma density in such reactors is in the region of  $10^{16} \text{ m}^{-3}$ , resulting in a power flux from the ions that is marginal as compared to that dissipated by surface recombination of atoms. This may not be the case for more powerful discharges, which are therefore not appropriate when the substrate temperature must be limited.

The results presented in figure 5 are valid for samples floating on the plasma potential, i.e., far from electrodes. Equation (5) only gives the voltage between the sample surface and the bulk plasma for floating objects. The power dissipated on substrates placed on powered electrodes can be much larger. In this case, DC-biasing occurs, leading to a sheath potential 1–2 orders of magnitude higher, causing significant heating.

Other mechanisms can cause heating of polymer substrates but are generally much less important. They include the relaxation of metastables, the accommodation of vibrationally excited molecules and absorption of plasma radiation. Few measurements of the coefficients for these exothermic surface reactions have been reported. The radiation produced by a plasma can appear in the visible, near-IR and UV part of the optical spectra, which is easily probed by classical optical spectrometers. VUV radiation can also be significant, notably the 130 nm O atom resonance line in O<sub>2</sub> plasmas, but can only be probed by calibrated VUV spectrophotometers. Few quantitative studies of plasma VUV radiation have been made, but it is likely that the VUV photon flux exceeds the UV–IR, by several orders of magnitude [34]. A useful code for simulation of the emission spectra from atoms is provided by the NIST database [35]. Radiation from excited-state molecules may also be significant [34]. Another heating channel is the oxidation of the polymer surface, leading to the release of stable molecules. The oxidation of hydrocarbons to CO<sub>2</sub> and H<sub>2</sub>O by plasma radicals is a very exothermic reaction, but the reaction probability is generally low at room temperature. For example, a value of 10<sup>-4</sup> was determined for PE terephthalate exposed to weakly ionized, highly dissociated oxygen plasma [36].

Substrate heating during polymer functionalization is therefore an important effect to consider. Polar surface functional groups are not stable, so hydrophobic recovery is a natural process. Different polymers exhibit different rates of hydrophobic recovery [37], but they all increase with increasing surface temperature [38]. Optimal surface processing results will be therefore obtained by using a flux of reactive species that assures: (i) surface saturation with functional groups and (ii) minimal heating.

Despite the wide use of polymer activation by low-pressure non-equilibrium gaseous plasma treatment [39–41], the optimal fluencies have rarely been reported in the scientific literature. Therefore, the determination of the initial stages in surface functionalization of polymer materials is a challenge. The surface density of atoms in any material, including polymers, is roughly 10<sup>19</sup> m<sup>-2</sup>. Therefore, assuming a sticking coefficient is 1, a smooth surface will be saturated by a fluence of the order of 10<sup>19</sup> radicals per m<sup>2</sup>. However, in practice sticking coefficients are typically much lower than unity. Furthermore, the surfaces are never perfectly smooth, so the fluencies must be larger. The fluencies are rarely reported for industrial-scale processes because the densities of reactive plasma particles are difficult to measure. Instead, only treatment times and discharge conditions (such as power, gas pressure and flow rate, type of discharge, peculiarities of the experimental setup etc) are reported. Typical treatment times are between a second

and several minutes for surface functionalization of polymers on the experimental scale, and less for industrial applications. Industrial low-pressure plasma reactors are often equipped with a roll-to-roll system to enable the modification of polymer surfaces in the continuous mode [42].

### 3.2. Optimal fluxes/fluencies of reactive gaseous species for surface functionalization

Some theoretical studies on the interaction of plasma species at low pressure with polymers on the microscopic (atomic) scale have been published. Longo *et al* [43] used density functional theory to study the etching of pristine and oxygen-functionalized polystyrene surfaces by O atoms. They identified 20 distinct binding sites for oxygen atoms adsorbed on the bare polystyrene surface. The adsorption energy for these sites varied between -2 and +0.1 eV nm<sup>-2</sup>. They simulated the progress of surface reactions versus the surface coverage with O atoms and found the following steps:

- (a) Formation of hydroxyl groups on the benzene ring by incorporation of an oxygen atom into C–H bonds;
- (b) Formation of epoxy bonds on the benzene ring with the release of a water molecule;
- (c) Formation of hydroxyl groups on the polymer backbone;
- (d) Formation of HO<sub>2</sub>\* radicals on the benzene ring;
- (e) Initiation of O-atom recombination on the epoxidized benzene ring and desorption of O<sub>2</sub> molecules;
- (f) Formation of C–O–OH groups on the benzene ring;
- (g) Rupture of the benzene ring;
- (h) Formation of C–O–C bridge bonds;
- (i) Formation of various oxygen-containing functional groups, degradation of the entire polymer structure by formation and release of CO<sub>2</sub> and H<sub>2</sub>O molecules.

These reactions cause modification of the surface structure, so any hypothesis about the exact mechanisms involved in the etching of a polymer at an atomic scale would be speculation. Still, the experimentalists know that the etching always occurs upon the interaction of gaseous plasma with a polymer surface. For example, Vesel *et al* treated PE terephthalate samples in the late flowing afterglow of an oxygen plasma at room temperature. They observed an etch rate of 0.01 nm s<sup>-1</sup> with an O-atom flux of approximately 2 × 10<sup>23</sup> m<sup>-2</sup> s<sup>-1</sup> [44]. The probability of O-atom to abstract a carbon atom from the polymer surface was only of the order of 10<sup>-6</sup>. The same group also studied the etching of the same material by an active plasma of comparable O-atom flux [36] and found a much higher etch rate of 5 nm s<sup>-1</sup>. This observation clearly indicates the importance of the synergistic effects between O-atoms and the flux of positive ions and plasma radiation on the surface chemistry.

The concentration of specific functional groups on the polymer surfaces is usually measured by XPS. The probing depth of XPS is several nm, so a single monolayer of oxygen (one oxygen atom per carbon atom) would result in an observed oxygen concentration of only about 10%. However, many reports give much higher oxygen concentrations,



often around 30 at% [26, 45, 46]. Therefore the oxygen must penetrate at least a few monolayers inside the polymer.

A few groups have studied the initial stages of polymer functionalization. Saturation of the surface functionalization is typically observed for fluences between  $10^{21}$  and  $10^{23}$   $\text{m}^{-2}$  [47]. A detailed study was recently performed by Vesel *et al* [48]. They found a high reaction probability for the formation of the hydroxyl group on the benzene ring of polystyrene. The surface was saturated with hydroxyl groups after being exposed to an O-atoms fluence of approximately  $1 \times 10^{19}$   $\text{m}^{-2}$ . This saturation with C–OH groups occurs before any rupture of the benzene ring has been observed. Other functional groups, and ring rupture, only appear for fluences an order of magnitude larger. These results are consistent with the prediction by Ventzek's group [43].

The etching of polymer materials during low-pressure plasma treatment is rarely laterally homogeneous. Nanostructuring is likely to be observed. Typically, a polymer surface which is initially smooth on a sub-micrometre scale will develop periodic structures of typical lateral dimensions 10–100 nm with a height of 1–10 nm. The mechanisms leading to this nanostructuring have been investigated by the group of Gogolides [49–51]. Such nanostructuring can reduce the surface wettability, even producing a super-hydrophilic surface finish (with a contact angle of water droplets close to zero). This effect, typically occurring for aromatic polymers, is the result of the combination of polar surface functional groups and surface roughness on the sub-micrometre scale. Doliška *et al* [36] recently published a review of the creation of super-hydrophilic surfaces on various polymers by plasma processing. Interestingly, super-hydrophilic surfaces have never been achieved by atmospheric plasma treatment, for reasons that remain unexplained.

Treatment of fluorinated polymers (for example polytetrafluoroethylene) by low-pressure oxygen plasma does not lead to the creation of polar oxygen-containing functional groups, but only results in etching [52]. However, hydrophilization of fluorine-containing polymers can be achieved by a two-step process. First, the surface must be defluorinated by a hydrogen plasma treatment. VUV radiation from the plasma breaks bonds on the polymer surface, and hydrogen atoms capture the fluorine. The surface is then briefly exposed to oxygen atoms in order to functionalize it with polar groups. This technique was first demonstrated by Nguyen and Yajima [53], and further developed by Lojen *et al* [54]. A similar process can be achieved in APP plasmas. VUV radiation is typically generated by an Ar plasma (due to the strong absorption of VUV below 115 nm in ambient air) followed by functionalization to introduce highly-oxidized carbon functional groups [55, 56].

### 3.3. Low-pressure reactors for surface energy modification

A variety of low-pressure reactors have been developed for the modification of polymer surfaces. Such reactors are typically excited by radiofrequency (RF) power. A good review of the principles of such plasma sources can be found in the book by Chabert and Braithwaite [33]. Figure 6 shows an electrodeless

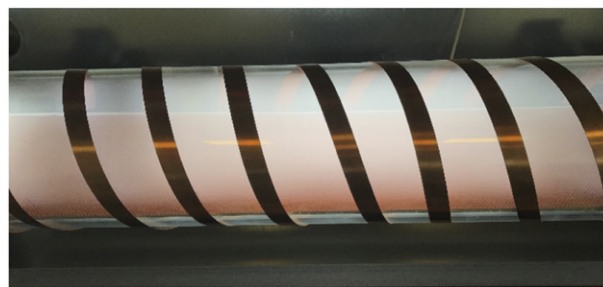

**Figure 6.** A photo of a low-pressure plasma reactor with a glass discharge tube.

inductive RF discharge used for roll-to-roll pressing of a polymer belt travelling along the reactor axis. The discharge tube is made from borosilicate glass (Pyrex or similar) with a diameter of 0.2 m and a length of 2 m. The main advantage of such reactors is the absence of metallic components in the system. As mentioned above, the loss of neutral reactive plasma particles, in particular atoms in the ground state, is minimal in glass reactors due to the low coefficient for the heterogeneous surface association of radicals to stable molecules. The surface loss coefficient for radicals is of the order of  $10^{-3}$  on a smooth glass surface [23, 57], so a large density of such radicals is achievable at a reasonable power. The helical antenna is powered by an RF generator with an adjustable output power of a few kW. The volume of the reactor is  $\sim 100$  l, so the specific power is a few  $10$   $\text{W l}^{-1}$ . Such a power density is enough to sustain plasma with a high dissociation fraction at pressures between 10 and 100 Pa. The plasma is almost perfectly homogeneous throughout the chamber. This reactor is ideal for surface activation of polymer materials, i.e., forming oxygen-rich functional groups on the polymer surface without significant etching of the polymer substrate.

The O-atom density in this reactor was determined using a catalytic probe (which measures the heat generated by surface recombination [58]). Figure 7 shows the O atom density as a function of the RF generator power and the oxygen gas pressure. At low powers the atom density decreases as the pressure is increased. In contrast, at the highest power (4 kW) it increases slightly, from  $2.5$  and  $3 \times 10^{21}$   $\text{m}^{-3}$ , between 20 and 150 Pa. Higher power levels will not much increase the O-atom density, but will cause an increased thermal load to the polymer substrate. Operating in this regime is useful for industrial applications, since it is generally difficult to keep the pressure constant, due to unpredictable effects like desorption of any gases from treated materials, small leakages and any deviation of the surface properties of treated materials from prescribed values.

The calculation presented in figure 4 allows an estimation of the required power to maintain an oxygen atom density of  $2.5 \times 10^{21}$   $\text{m}^{-3}$  of approximately  $500$   $\text{W m}^{-2}$ , assuming a recombination coefficient typical of  $3 \times 10^{-3}$ . The glass surface area is approximately  $1.2$   $\text{m}^2$ , and the surface of the polymer belt exposed to plasma is approximately  $0.6$   $\text{m}^2$ . Therefore, the power lost on these surfaces by heterogeneous recombination of atoms should be approximately 1 kW. This is smaller by a factor of 4 compared to the results observed



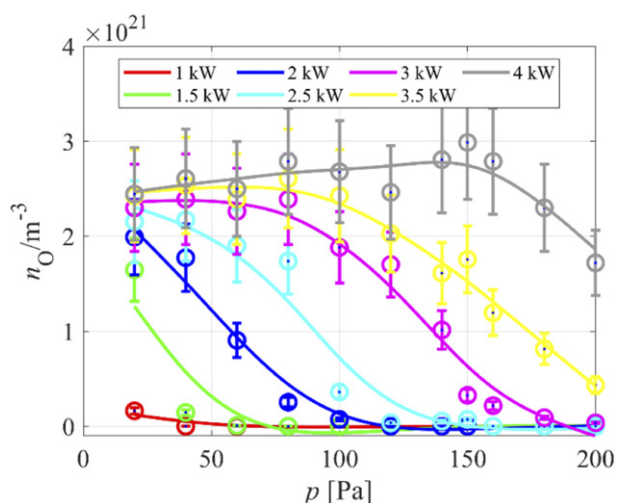

**Figure 7.** The O-atom density in the glass plasma reactor shown in figure 6.

in figure 7. However, this can be attributed to several factors. (1) Possible underestimation of the value of the recombination coefficients, (2) equation (4) assumes power is only used for  $O_2$  dissociation, ignoring other channels such as gas heating, vibrational and electronic excitation, ionization etc, (3) the efficiency of power transfer to the electrons is below 100%, due to power lost heating the coil and imperfect impedance matching, as well as radiation. The power loss by neutralization of positive ion bombardment of the polymer belt is small, but the heating of the glass tube is more significant, especially in form of the coil due to the high energy of incident ions (the RF generator operates at a few kV peak-to-peak voltage). A detailed study of the energy efficiency is beyond the scope of this paper, but the measured values of the O-atoms density shown in figure 7 indicate that the operation of such a reactor requires RF power  $\sim 4$  times greater than that predicted by the calculations of the O-atom loss due to heterogeneous surface recombination.

The energy efficiency can be better at lower gas pressure. Figure 7 indicates that the O atom density at 150 Pa, 4 kW can also be achieved at 10 Pa using 3 kW RF power only. However, at lower powers the O-atom density will show a much stronger decrease with increasing pressure. At 50 Pa, for example, the O-atom density is approximately  $2.2 \times 10^{21} \text{ m}^{-3}$  at 3 kW,  $1.2 \times 10^{21} \text{ m}^{-3}$  at 2 kW,  $0.3 \times 10^{21} \text{ m}^{-3}$  at 1.5 kW and below the detection limit of the probe at 1 kW. As discussed above, a robust industrial system should operate in conditions where both the pressure and power dependence of the crucial parameter (O-atom density in this particular case) is small over the range of feasible parameters.

Figure 8 shows an example of a metallic reactor used for batch mode surface functionalization of polymer products. The substrates are assembled in parallel racks. The vacuum chamber of volume a few  $\text{m}^3$  is evacuated with a combination of rotary and roots pumps. A pressure of approximately 1 Pa is achieved after a few minutes. A plasma is then created by a capacitively coupled RF discharge between two rectangular powered electrodes (yellowish plates in figure 8) in

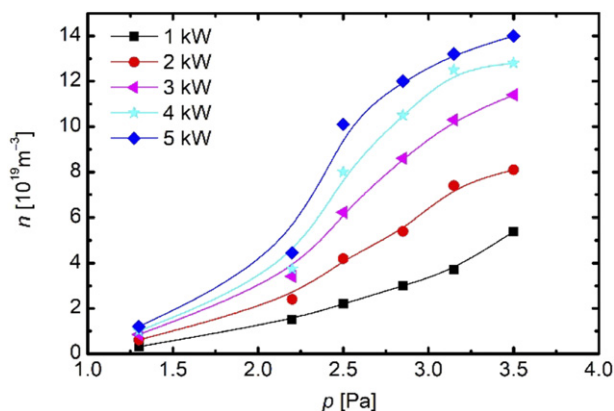

**Figure 8.** A low-pressure plasma reactor in a metallic chamber.

a moderately-asymmetric configuration. The powered electrodes are separated from the grounded chamber wall by approximately 1 cm. This distance is small enough to prevent a direct discharge between the electrodes and the chamber wall, creating a rather homogeneous plasma in the entire volume of the vacuum chamber for pressures of a few Pa. Operating at higher pressure would cause discharge between the electrodes and the nearby ground, therefore this cannot operate at pressures above a few 10 Pa. The power density in this reactor is approximately  $1 \text{ W l}^{-1}$ . This reactor allows polymers to be functionalized with polar functional groups using oxygen plasma.

Measured values of the O-atom density in this reactor are shown in figure 9. They are almost two orders of magnitude smaller than in the glass reactor. This can be easily explained by the much higher catalytic activity of metals (compared to glass) for heterogeneous surface recombination of O-atoms to  $O_2$  molecules. The surface of the metallic components facing plasma in figure 8 is approximately  $20 \text{ m}^2$ . Using the measured O-atom density of  $4 \times 10^{19} \text{ m}^{-3}$  and assuming a recombination coefficient on stainless steel of 0.1 [59–61], the estimated power lost by surface recombination of O-atoms is  $\sim 500 \text{ W}$ . The actual discharge power is several times larger. Possible reasons for the discrepancy were discussed above, but the majority of power in capacitively coupled discharges is used for accelerating ions across the powered electrode sheath, leading to the heating of this electrode [62]. The recommended discharge power in such reactors is therefore several times larger than the estimated power needed for compensation of the loss of atoms by surface recombination.

The surface functionalization of polymer powders is a significant industrial challenge. Powders have a very high surface-to-volume ratio, making it impractical to use the two reactor types presented above. Arpagaus *et al* [63] have recently presented a survey of techniques useful for the plasma treatment of powders. Ideally, the powder would be blown into a plasma reactor, but this has not been used on the industrial scale due to several limitations, including excessive heating of the powder, and loss of electrons to the particle surfaces, discussed in detail by Šourkova and Špatenka [64]. One solution is stirring polymer powders during treatment inside a low-pressure plasma reactor. Figure 10 shows an industrial low-pressure plasma reactor capable of treating several  $10 \text{ kg h}^{-1}$  of polymer powder. The reactor (volume 66 l) operates in a batch mode: 5–10 kg (depending on the type of polymer and



**Figure 9.** The O-atom density in the metallic plasma reactor shown in figure 8.

powder dimensions) of polymer powder is placed into a dish, and the reactor is evacuated and filled with either in air or oxygen at a pressure of  $\sim 100$  Pa. Plasma is sustained by two microwave (MW) sources mounted on top of the reactor. The polymer powder is stirred upon plasma treatment. The scientific aspects of polymer powder functionalization by plasma in a similar reactor are discussed by Šourková and Špatenka [64]. A dense plasma is concentrated in the uppermost part of the reactor, up to about 1 cm from the MW sources, due to the poor penetration of the electromagnetic field into the dense plasma at the MW frequency (skin effect). This dense plasma does not contact the polymer powder, otherwise melting would occur. The powder is only exposed to a much lower density plasma which diffuses from this zone into the entire chamber. The reactive species, in particular neutral oxygen atoms, interact with the powders on the surface. Since the powders are stirred at approximately 1 Hz, the powders are mixed, and finally a quasi-homogeneous functionalization is obtained for the entire powder in the dish. The typical treatment time is approximately 10 min. This device can process approximately  $100 \text{ kg day}^{-1}$ . The functionalized polymer powders produced are destined for the synthesis of composite materials, since the functionalized polymer readily wets the inorganic fillers.

The O-atom density in the reactor in figure 10 is shown in figure 11. Air was flowed into the reactor at the rate of 0.4 SLM, and the pressure was adjusted by adjusting the butterfly valve installed between the reactor and the vacuum pumps. The O-atom density is of the order of  $10^{20} \text{ m}^{-3}$  and does not depend much on the discharge power or the pressure, for pressures between 70 and 120 Pa and discharge power between 400 and 2000 W, corresponding to a power density between 6 and  $30 \text{ W l}^{-1}$ . These O-atom densities lie between the values observed in the large metallic (figure 8) and glass (figure 6) reactors. The O-atom density is clearly suppressed by strong recombination at the stainless steel walls.

### 3.4. Plasma polymerization at low pressure

It had long been observed that plasma environments often accidentally deposit yellowish polymeric layers. These layers



**Figure 10.** A low-pressure plasma reactor for the treatment of polymer powders.

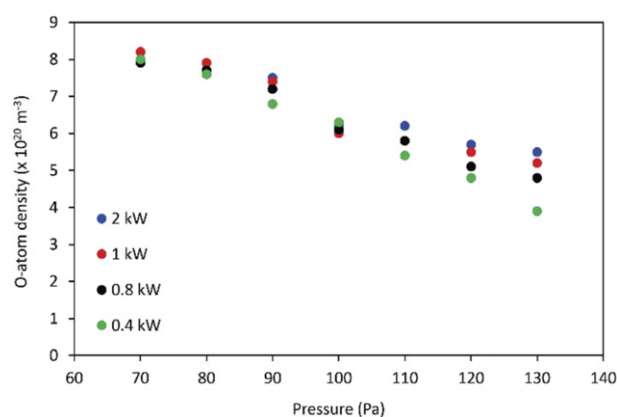

**Figure 11.** The O-atom density in the metallic plasma reactor shown in figure 10.

adhere very well to almost any material and resist most solvents. The first application of plasma polymerization was the polymerization of styrene to create pinhole-free dielectric layers for capacitor applications [65]. The development of plasma polymerization in the 1960s and 1970s was accompanied by a debate about the plasma species responsible for the film deposition. Some argued in favour of ion-driven deposition [66], whereas others proposed radical-dominated deposition [67]; other work highlighted the importance of ion–molecule reactions in the gas phase [68]. Yasuda, a pioneer in plasma polymerization, argued that if the plasma is dense enough, every molecule in the plasma atmosphere will be dissociated to the atomic level, and reorganize in the growing films at the surfaces in contact with the plasma, a so-called atomic polymerization mechanism [69]. However, some plasma-deposited polymer films were found to contain undissociated segments of the precursor. Yasuda, therefore, proposed that plasma polymerization processes should be characterized in terms of the ratio,  $W$ , of the power input to the precursor mass flow. This is the so-called Yasuda factor, expressed in units of  $\text{J kg}^{-1}$ . A

given precursor molecule has a threshold value for the Yasuda factor. When the Yasuda factor exceeds this threshold, the precursor will be almost totally destroyed, so that no segment of its former structure is retained. At lower values of the Yasuda factor, segments of the precursor structure are preserved in the deposited film. Since the objective of polymer functionalization is the well-controlled creation of specific functional groups at the polymer surface, plasma polymerization is typically operated in a low power-density regime, with the Yasuda factor well below this threshold.

This concept of the Yasuda factor was further developed by Hegemann, who correlated the macroscopic deposition rate to the ratio of the activation energy to the power input per unit monomer flow (the Yasuda factor referred to one monomer) giving an Arrhenius-type exponential function [70]. In 2010 the debate on the underlying mechanisms started again, specifically concerning the role of ions and radicals in plasma polymerization [71–73]. Indeed, both ionic and radical species can contribute to the film deposition, depending on the input power level and the pressure. For more details, the reader is referred to a review by Thiry *et al* [74].

One of the biggest challenges of plasma polymerization is the stability of the deposited film for a given application, especially in the biomedical field. Both mechanical and corrosion resistance is required. The film stability will depend on the density of chemical bonds linking it to the polymer substrate, the degree of cross-linking, and the chemical stability of the functional groups it contains (for example, against oxidation). If the films are less cross-linked then water absorption and film swelling can occur, mechanically destabilizing the film. However, increased cross-linking makes more rigid films, which can cause cracking and lead to the film peeling off. The film thickness also affects the mechanical stability; films should be as thin as possible so as not to accumulate intrinsic stress. If a thick film is necessary, and the thermal expansion coefficient of the film differs significantly to that of the substrate, the stress at the interface can be minimized depositing films with a gradient in composition and physical properties [75].

The chemical bonding of the film to the substrate depends on its surface properties at the beginning of the deposition. One strategy, therefore, is to activate the substrate surface by a plasma process (often using inert gas) prior to deposition [76, 77]. Sufficient energy must be supplied to the plasma to break bonds both on the surface and in the precursor. A high ratio of the energy flux to the surface to the precursor mass flux will increase adhesion [78]. If the polymer is heat-sensitive, making high-power operation undesirable, the use of pulsed plasma processing with a low duty cycle but a high peak power can be used to increase the coating stability while keeping the average gas and substrate temperatures low.

In low-pressure processes control of the ion bombardment energy can help adhesion, as shown by a study where additional bias voltage was applied [79]. Such ion bombardment generates radical sites at the polymer surface and in the growing film, favoring cross-linking.

Polymer functionalization by plasma polymerization is particularly useful for biomedical applications, since it allows

many different functional groups to be added to the surface, offering a wide range of biocompatibility attributes. This will be discussed further in section 5.

### 3.5. Advantages and disadvantages of low-pressure reactors; effect of ions

The main advantage of using low-pressure plasma for surface functionalization is the good spatial and temporal homogeneity over large reactor volumes. The plasma can diffuse far from the plasma generation regions where the electric field is high. This enables uniform processing of products of various shapes. These rather uniform plasmas can be readily characterized by various probes inserted into the plasma reactor, including electrostatic (Langmuir) probes for charged particles, catalytic probes for atom densities and thermal probes for energy fluxes [80–82]. The heating of the processed substrates can be minimized with careful choice of the processing parameters.

An important advantage of low-pressure reactors is the efficient evacuation of gaseous reaction products released from the processed substrate. These products can be both toxic and corrosive. The most common toxic gas produced upon interacting polymers with oxygen radicals is carbon monoxide. Hydrogen cyanide can be produced when the process gas contains nitrogen or ammonia. The use of air plasma can create nitric oxides. The etching of fluorinated polymers with oxygen plasma will produce alkoxy radicals and peroxy fluorocarbons. Many plasma radicals will interact with the vacuum pump oil, so at least they will not be released into the atmosphere. Industrial plasma reactors are sometimes equipped with catalytic gas processing units between the chamber and the pump, in order to remove reactive radicals and prevent their interaction with the vacuum pump oil.

The main disadvantage of the low-pressure plasma reactors is the equipment cost when compared to atmospheric-pressure reactors. The typical price of a one m<sup>3</sup> industrial low-pressure plasma reactor is between 0.1 and 1 M€. This does not include processing development costs, which can be significant for atmospheric plasma processing. Once optimized, the costs of using low-pressure plasma reactors for surface functionalization of polymers are low, because low-pressure plasma systems are robust and require little maintenance. When using air or oxygen, the gas costs are small. Only moderate effective pumping speeds are needed, so the gas consumption is typically  $\sim 0.1$  standard l min<sup>-1</sup>. Commercially available gases are pressurized to over 100 bar so that a cylinder will last for a week or so. The energy consumption is of the order of a few kW. The electricity spent on pumps is comparable to the power needed for the plasma generator.

We have not discussed the role of positively charged ions in polymer processing. Most polymers are insulators, so the substrate will remain at floating potential during plasma treatment. Moreover, typical processes operate at intermediate gas pressures, where the plasma sheath is highly collisional. Therefore the energy of ions incident on the substrate is typically rather low. Furthermore, the ion flux is many orders of magnitude lower than the reactive radical (oxygen atom) flux. Indeed,



high fluxes of energetic ions are usually avoided for polymer processing, since they will cause unwanted heating of the substrate. Such heating is generally detrimental for surface functionalization since the highly polar groups are unstable and decay quickly at elevated temperatures. In fact, the best results in terms of the concentration of highly polar functional groups are often achieved by the treatment of polymer products in the plasma afterglow [83]. In practice, afterglow reactors are rarely used in industrial systems since the radicals fluxes are low [84], leading to slow process rates.

### 3.6. Conclusions

Low-pressure plasmas are widely used for surface functionalization of three-dimensional polymer objects. For example, in the automotive industry many components (including bumpers, lamps, mirrors, etc) are now made from plastics, and must be functionalized with polar groups to allow painting or gluing. Low-pressure plasmas are also necessary for fabrication products in electronic and electrical goods industries. In many cases only low-pressure plasma processes can provide the required surface characteristics. In contrast, atmospheric-pressure plasmas are widely used in the textile industry, since the treated materials are usually two-dimensional, and there is no need for three-dimensional plasma.

## 4. Atmospheric pressure plasma surface functionalization

Polymer functionalization by plasmas at APP is a relatively new and fast-developing field of research with high industrial potential. Historically, the use of APP plasma for the processing of polymers started in the 1960s, mainly in the textile industry. The motivation was the activation of polymer surfaces in order to improve the adhesion of glues and dyes. In general, the methods of APP functionalization are still less developed than the low-pressure processes described in section 3, but APP operation has several advantages driving the interests of both the scientific community and industry.

### 4.1. Specificities of atmospheric pressure plasmas

At APP the particle collision frequency is typically several MHz, depending on the gas temperature and cross-section of the collision. This results in fast energy exchange between electrons, ions, and neutrals, having a drastic impact on APP plasma properties. The characteristic lifetime of species can be estimated by:

$$\tau = \frac{1}{\sum k_i [n_i]}, \quad (7)$$

where  $k_i$  is the rate constant of the reactions and  $n_i$  is the density of the species and is in the range of 0.01–1  $\mu\text{s}$  at APP. Electron–ion recombination is very fast at high pressure, occurring on a timescale that is shorter than their characteristic diffusion time. As a result, APP plasmas nearly always operate in the recombination regime, and diffusion of charged species

to reactor walls or to the surface of a treated material can be neglected. Some exceptions to the recombination regime for APPs exist, such as constricted  $\text{N}_2$  direct current discharges [85, 86]. In this case, the charged particle density is determined by the balance of ionization with ambipolar diffusion of ions from the hot center to the cold periphery. Correspondingly, plasmas in  $\text{N}_2$  at APP are similar to low current diffuse glow discharges in a tube at low pressure. However, the role of the plasma absorbing ‘wall’ is played not by the actual wall of the tube but by a thin (about 0.5 mm) cylindrical layer of cold gas surrounding the hot plasma channel. Additionally, gas convection and noble gas dilution are often used in APPs to overcome the drawbacks of the recombination mode of the discharge operation.

Plasma operation in the recombination mode can cause several effects with consequences for polymer processing and surface functionalization. These include:

- (a) Constriction of the plasma sheath region and the discharge;
- (b) Transition from diffuse glow-like plasma to a filamentary mode;
- (c) Transition from a non-equilibrium regime to thermal equilibrium with strong gas heating.

As discussed in section 3, the sheath thickness in low-pressure plasmas is in the range of mm to cm, and the sheath is often used to accelerate ions to enhance etching. In contrast, at APP, it is much smaller, (see equation (5) in section 3 [87]). For example, for APP RF discharges (excited at 13.56 MHz or 27.12 MHz) the sheath thickness (both experimentally [88] and from particle-in-cell (PIC) simulations [106]), is only of the order of 100  $\mu\text{m}$ , shown in figure 12.

Even more importantly, the ions in the sheath in APPs undergo many inelastic collisions before they reach the surface of treated materials, where their average energy is less than 1 eV. This situation is very different to low-pressure plasmas and as a result ion-enhanced functionalization or etching of polymeric materials, is negligible. Conversely, high fluxes of reactive neutral species, including atoms, radicals and metastable species, are can be generated, and these are responsible for the functionalization of the treated surfaces. APPs in Ar can generate significant fluxes of VUV radiation, which can induce oxidation of surface carbon groups [56].

The high collision frequency is also responsible for the rapid transfer of the electron energy to other species, causing gas heating either by elastic or inelastic collisions. This results in discharge constriction as the pressure is increased, and ultimately to thermalization of the discharge, leading to high gas temperatures, up to many 1000s K. This transition from uniform, diffuse discharge to the constricted filamentary regime or even high current spark/arc is strongly undesirable for polymer functionalization because of the possibility polymer thermal damage. Therefore APP sources for polymer treatment are designed to operate far from thermal equilibrium and should generate large dimension plasmas with a uniform distribution of active species in the discharge active area or the effluent.



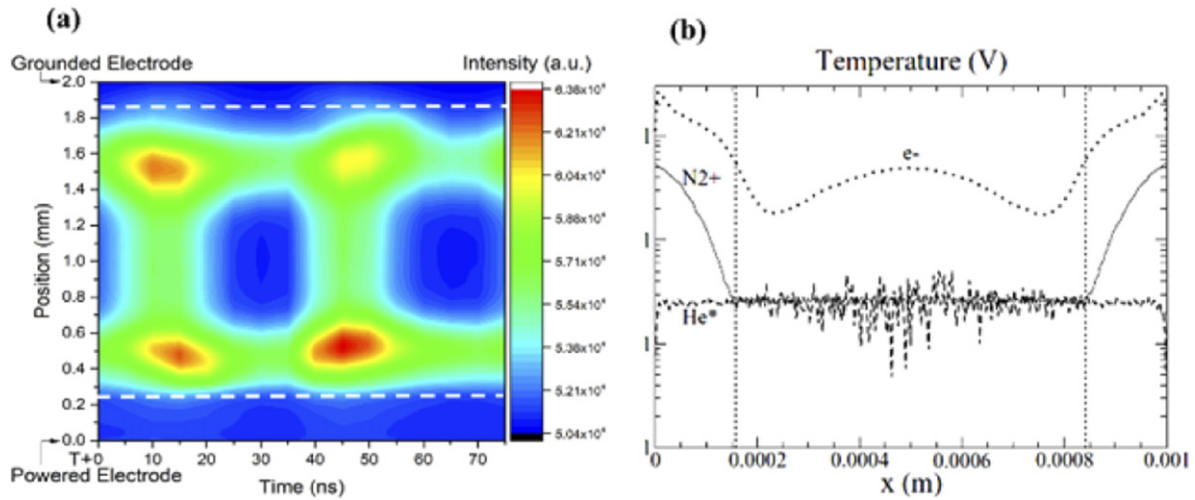

**Figure 12.** (a) Time and axial position resolved optical emission intensity in an APP RF (13.56 MHz, 30 W) planar discharge in helium (2 SLM). The RF sheath edge is indicated by dotted line; (b) PIC simulation of a planar discharge at 27.12 MHz in He/0.1% N<sub>2</sub> at APP (Reproduced from [106]. © IOP Publishing Ltd. All rights reserved.), showing the time-averaged particle distribution profile and temperatures.

#### 4.2. Atmospheric pressure discharges for functionalization

Several plasma sources have been developed over the last 50 years using different physical principles to stabilize the discharge. Here we only will focus on plasma sources that have proved to be effective for polymer functionalization.

A considerable research effort in recent years has been devoted to the generation of APPs suitable for polymer functionalization. Several approaches have been implemented to prevent discharge thermalization, including:

- The use of high gas flow;
- The use of noble gases, especially helium due to its very high thermal conductivity;
- Discharge current limitation through the use of large ballast resistors;
- Use of pulsed voltages, with pulse durations shorter than the time required for the formation of instabilities;
- Use of geometrical constraints in the source design;
- Use of micro-discharges, where the proximity of surfaces favors non-thermal plasma generation;
- Plasma jets, sustained by the propagation of ionization waves.

The transition from a diffuse plasma to a spark is a well-studied process associated with local overheating of the gas and the formation of a hot cathode spot. An illustration of the transition is shown in figure 13 [107].

A low current corona figure 13(a) can be transformed into a glow-like discharge by the use of high gas flow. The gas flow prevents the formation of thermal instabilities in the discharge region, allowing a high current glow-like plasma to be obtained even at high pressure (figure 13(b)) within the current range  $0.3 \leq I$  (mA)  $\leq 3$  mA. The effect of gas flow stabilization is seen in figure 13(c) where the transition to the spark regime occurs at current  $I$  (A)  $\leq 0.3$ –1.3.

The first application of APPs to polymer processing was the use of corona discharges for the treatment of textiles and

the improvement of hydrophilic properties of natural and polymer fabrics. Corona discharges are created by applying a high voltage to an electrode in the form of a pin or wire, placed at a distance from a metal plate. Partial breakdown occurs in the discharge gap, as shown in figure 14(a). It is sustained by a high electric field ( $E/N$ ) generated at the pin tip. The current of the corona plasma is very low and cannot be increased without transition to spark. To increase the current the corona can be stabilized by the use of a gas flow, see figure 13, or by using short voltage pulses with pulse durations below 50 ns [89]. Corona treatment for the purpose of functionalization is usually performed in ambient air, either humid or dry, and typically used to activate polymer surfaces before the application of dye or glue.

Another discharge configuration widely studied and used for industrial applications is the DBD. In this case, the discharge is generated in between two electrodes, one or both of which are covered with a dielectric material, as shown in figure 14(b). The discharge is stabilized by both geometrical constraints (with a typical distance between electrodes of some mm) and by the dielectric barrier, which limits the discharge current. The DBD plasma, which to the naked eye appears uniform, is comprised of a large number of micro-discharges with a typical lifetime below a  $\mu$ s. A comprehensive overview of the physics behind DBD plasma generation and maintenance can be found elsewhere [90]. Several different DBD plasma geometries have been deployed on an industrial scale for polymer functionalization and plasma polymerization. Undoubtedly, DBD plasma reactors are currently the most commonly-used APP plasma configuration for polymer treatment.

Very short voltage pulses, with durations of a few ns up to 50 ns, can generate a uniform discharge between co-planar electrodes even without dielectric material covering the electrodes, figure 14(c). Typically the electrodes are separated by a very short distance (1–2 mm), but this can be increased up to 10 mm with no compromise on the discharge stability if the

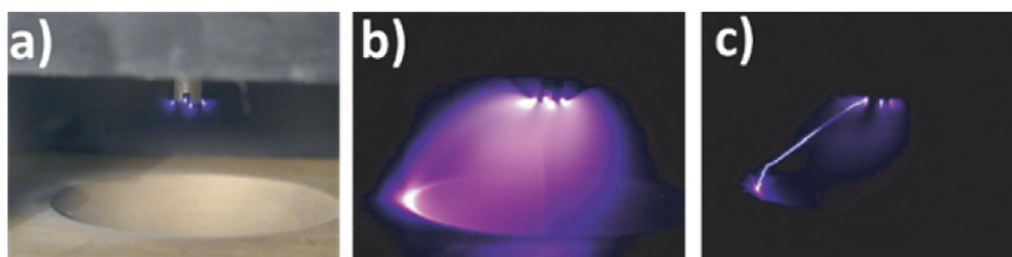

**Figure 13.** Pin-to-plane discharge in ambient air stabilized by airflow. (a) Negative corona in the air with no gas flow stabilization; (b) direct current steady-state diffusive discharge in airflow; (c) transient spark in ambient air at high discharge current. Reproduced from [107]. © IOP Publishing Ltd. All rights reserved.

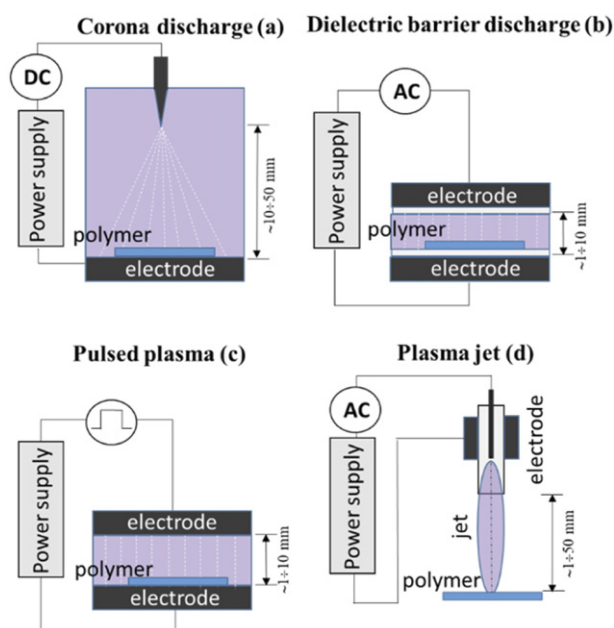

**Figure 14.** Schematics of the APP applied for polymers functionalization (a) DC corona discharge; (b) AC DBD with both electrodes covered with a dielectric; (c) pulsed co-planar discharge; (d) plasma jet sustained by AC or RF voltage, a gas flow directed coaxially through the electrodes system has to be applied to create the afterglow.

voltage rise time is above  $10 \text{ kV ns}^{-1}$  and the pulse duration is shorter than 10 ns. One of the main advantages of this type of discharge is the very high discharge stability, as well as the possibility of reaching a high degree of non-equilibrium with high vibrational excitation of the gas molecules. Recently polymer surface energy tuning has been demonstrated using a coplanar RF discharge (13.56 MHz) operating in noble gases (Ar or He) with small additions of  $\text{O}_2$  and hexamethyldisiloxane (HMDSO)/HMDSN precursors [91, 92].

In the mid 1990s, the concept of plasma jet reactors was proposed to generate an APP with minimal gas heating [93, 94]. Plasma jets are created in a dielectric tube through which there is a high flow of a noble gas (Ar or He). The discharge is excited by two coaxial cylindrical electrodes, separated by a short distance and placed respectively inside and outside of the tube, and to which is applied an AC, RF or pulsed voltage. The applied voltage charges the dielectric materials, generating an electric field of several  $10\text{s kV cm}^{-1}$  which

creates an ionization wave that propagates along the gas column with a speed up to  $1\text{--}5 \text{ km s}^{-1}$  [95], forming a long glow that can extend beyond the end of the tube into the ambient air. This afterglow can be used to treat complex 3D objects, and capillary tubes can even be treated from the inside. However, the need to use significant quantities of expensive gases strongly limits the use of plasma jets for large-scale industrial polymer functionalization.

Despite the challenges of generating stable, uniform, non-equilibrium APPs, APP operation offers some unique opportunities for polymer functionalization. One of these is the combination of the discharge with the injection of precursors in form of aerosols. Aerosol-assisted processes have been used for chemical vapour deposition and PECVD for engineering nanocomposite coatings and nanostructured functional materials, as well as applications in biomaterials, textiles, biological sensing, and energy storage. In addition to the use of traditional volatile precursors, it is also possible to use non-volatile or thermally unstable precursors [96]. Ross and Gleason [108] were one of the first groups to use an aerosol, produced by an ultrasonic atomizer, but this process was carried out at low pressure. However, the coupling of an aerosol to a plasma discharge at low pressure is a rather difficult engineering task, limiting the utility for polymer functionalization. In contrast, with aerosol-assisted atmospheric pressure plasma deposition (AAPPD) the injection of non-volatile liquids, thermally sensitive liquids, solutions, and dispersions is quite simple [96, 109]. An advantage of AAPPD is that the precursor molecules contained in the aerosol droplets are shielded by the surrounding liquid, protecting their functionality and limiting the fragmentation when exposed to plasmas.

#### 4.3. Polymer functionalization processes

This section will illustrate a range of possible applications of APPs to polymer surface engineering and emphasize the specificities of APP processes. Rather than a detailed overview of the literature, some typical applications will be presented with a focus on the fundamental principles behind the polymer functionalization process. APP polymer functionalization can achieve: (i) an increase of surface energy (also called activation); (ii) a decrease of surface energy (also called passivation); and (iii) incorporation of new functional groups (ketones, amines, alcohols, esters, etc) on the polymers top surface.

Plasma activation is a process that leads to an increase of the surface free energy, whereas a decrease of the surface free energy leads to passivation. Both treatment methods have a wide range of applications, primarily in the textile industry where DBD and corona plasma reactors are often used. Plasma activation can be achieved either with inert gases (Ar, He, Xe, Ne) or with reactive gases ( $O_2$ ,  $N_2$ ,  $CO_2$ ,  $H_2O$  and many others). Low-pressure plasma activation was discussed in section 3, with an emphasis on the use of atomic oxygen. In APPs operating in inert gases, the active species created by the discharge (ions, electrons, metastable, UV photons) are not directly incorporated into the polymer surface. Rather, the modification occurs through the creation of radicals on the treated surface, which then react with  $O_2$  or  $H_2O$  during subsequent exposure to the ambient environment [97, 98]. This results in the incorporation of oxygen-containing functional groups at the surface of the polymer. When reactive gases are used, new functional groups on the surface can be created by the direct incorporation of radicals from the plasma. The activation effect achieved is a function of both the plasma operating parameters and the energy density used.

As an example, the activation of polyethylene terephthalate (PET) film by both inert (He, Ar) and reactive (air) gases are compared [110] in figure 15(a). The water contact angle (WCA), an indicator of the surface free energy, was found to depend strongly on the energy density and was reduced from an initial  $73^\circ$  to about  $30^\circ$  by a treatment lasting a few seconds. The contact angle correlated well with the incorporation of O-containing groups (C–O; C=O; O–C=O; etc), shown in figure 15(b). There is little consensus in the literature on the plasma operational parameters required for the functionalization of specific polymers. All plasma sources described in section 4.1 have been used by different researchers for polymers functionalization. Significantly, all studies agree that the typical depth of activation does not exceed 10–50 nm due to the limited depth of radical diffusion [99]. Plasma activation is true ‘surface functionalization’, and does not affect the bulk properties of the polymers. However, during storage, this limited penetration depth leads to the well-known recovery of the free surface energy to its value before the treatment, similar to that observed after low-pressure plasma treatment. The mechanisms of the recovery process were already discussed in detail in section 2.7.

Plasma functionalization using different chemistries can also achieve a reduction of the surface free energy of polymers, the reverse of activation. The most common way to do this is to make Teflon-like surfaces using a plasma containing fluorocarbons (e.g.  $CF_4$ ). However, in these chemistries, the formation of dust particles can strongly affect the morphology of the top layer. Additionally, the low electron temperature in APPs leads to low fragmentation of fluorocarbons precursors, making such a process difficult. Wang *et al* [100] used a plasma jet driven by microsecond pulses to increase the hydrophobicity of the surface of polymethylmethacrylate. The increased hydrophobicity was caused by the incorporation of hydrophobic C–F groups onto the surface, as well as increased surface roughness. Despite some progress in polymer functionalization with C–F groups, surface energy reduction by APPs is less

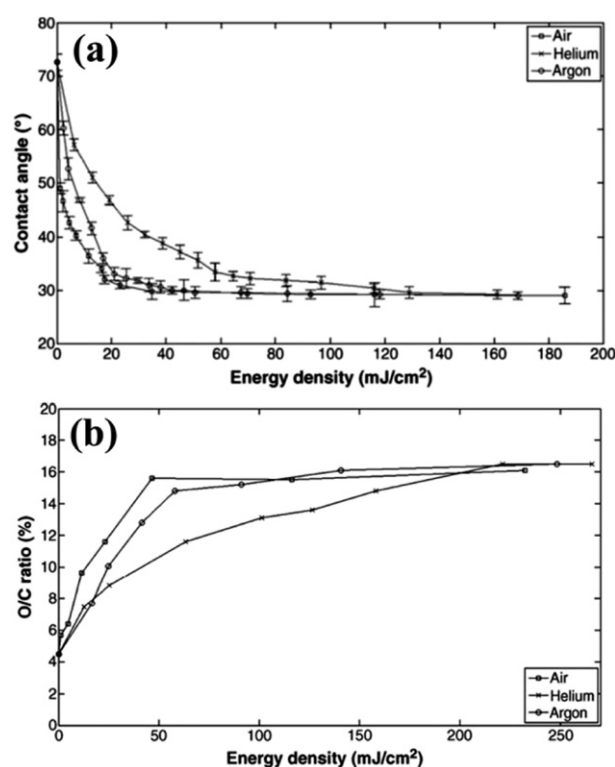

**Figure 15.** Results of plasma activation of PET film for an air, helium and argon DBD: (a) contact angle of the PET film as a function of energy density; (b) O/C ratio as a function of energy density for the PP film treated with air, helium and argon plasma. Reprinted from [110], Copyright (2007), with permission from Elsevier.

developed compared to other functionalization methods, and only limited success has been achieved compared to low-pressure plasmas.

In contrast to low-pressure plasma reactors, most APP applications concern flat substrates such as 2D polymer films, non-woven and textiles. There have been a few promising studies on the treatment of complex 3D objects, especially using plasma jets [101, 102], but they are still at an early stage of development. Plasma functionalization through the incorporation of new functional groups has been investigated for many applications, including modifying the hydrophobic/hydrophilic properties, changing the surface roughness, reducing water and oxygen penetration (for food packaging), grafting in biomedical applications, and many others.

#### 4.4. Plasma polymerization at atmospheric pressure

APP plasma polymerization of monomer precursors is a powerful method to create polymer surfaces with a range of new functional groups [103–105]. We stress again the distinction between plasma functionalization and thin film deposition as emphasized in section 1. In functionalization, only the chemical composition of the top surface of the polymers is important, the bulk properties of the deposited film having a negligible role in targeted applications. Depending on the plasma source design, monomers can be added during the plasma processing, or introduced after plasma activation. Chemical



functionalization through plasma polymerization has various advantages: (i) it can be selective to the substrate composition; (ii) it shows negligible aging. Plasma polymerization with APP has found several application niches, for example in the textile industry to improve the dyeing process, in the packaging industry to reduce biofilm formation, and in biomaterials engineering. The latter is described in detail in section 5.

In section 3.4, the Yasuda factor was introduced to characterize the efficiency of low-pressure plasma polymerization processes [69]. Under those conditions, it is generally a good predictor of the degree of precursor fragmentation, and of the deposited film properties. However, its applicability to APP plasma polymerization has been found to be less reliable. Nisol *et al* [111–113] investigated plasma polymerization at APP for a range of precursors (including esters, acrylates with different numbers of unsaturated bonds, or allyl methacrylate). The precursor fragmentation was found to change with increased input power at the constant Yasuda factor, leading to different surface chemistry on the substrate. In cooperation with the group of Hegemann [114, 115] they showed that, while the gas phase processes occurring in low-pressure and APP processes can be similar, the surface processes are often quite different and strongly pressure dependent. In order to compare plasma polymerization at different pressure regimes, they introduced the concept of energy conversion efficiency (ECE) [115]. This parameter allows low- and atmospheric-pressure plasmas to be compared, and correlates the input power with the efficiency of the functionalization. The ECE parameter at APP is defined as the energy absorbed per input monomer molecule, whereas at low pressure it is defined as the energy absorbed per molecule contributing to film growth, i.e. volatile reaction products (which may have picked up considerable energy without being involved into the film deposition) are not included. The ECE concept is therefore a convenient way to compare the efficacy of the polymerization process and compare the discharge operation at different pressures.

For biomedical applications, the most commonly desired functional groups are carboxyl, carbonyl and amines. These groups improve biocompatibility and protein adhesion.

Organosilicon precursors have been widely employed for the control of polymer wettability. Morent *et al* [116] studied the HMDSO/Ar plasma treatment of PET using a planar DBD. They found that the inorganic nature of the surface, and thus the surface energy, can be varied over a wide range, although complete oxidation of the surface was not possible. Similarly, O'Hare *et al* [117] reported a scalable roll-to-roll configuration for the functionalization of materials in HMDSO/He plasma. The effect of O<sub>2</sub> addition and discharge power on the hydrophobic behaviour of polymers treated with tetramethyl disiloxane precursor was studied by Deng *et al* [118]. This work showed the key role of oxygen, which allows tuning of the functionality through the reduction of the organic content of the top layer of the treated materials.

In APPs at a low monomer injection rate, the precursor fragmentation occurs in the gas phase. However, if the precursor is in excess, nucleation and growth of nano-particles can occur in the gas phase, in addition to fragmentation. This can result

in the formation of powders, which can be incorporated into the coating [119]. Such gas-phase nucleation can considerably affect the functionalization process [120]. The nucleation process can be so intensive that particles of 100–500 nm size with complex 3D morphology are formed, strongly affecting the functionality of the polymers [91].

Specifically for APPs, in plasma jets configuration, admixing of the monomers with the carrier gas can take place in the discharge zone, which favours precursor activation and fragmentation in the plasma. However, the disadvantage is a deposition on the electrodes and jet walls, requiring additional cleaning procedures [121, 122]. If the precursor is supplied to the afterglow through an additional inlet, the jet contamination can be avoided at the price of a reduced degree of precursor activation and fragmentation [123]. Selwyn *et al* designed an APP plasma jet with coaxial metal electrodes for polymer surface functionalization and etching [124]. Tetraethoxysilane precursor, supplied at the outlet of the plasma jet, was used to change the hydrophobic behaviour of a substrate placed at 1.7 cm from the nozzle. Polymer functionalization with a decrease of the surface free energy was also achieved using carbon tetrafluoride (CF<sub>4</sub>) [125]. For large area functionalization an RF showerhead plasma jet was developed by SurfX technologies LLC [126]. With a carrier gas (He or Ar) passing through the upper (powered) electrode Abou Rich *et al* were able to use showerhead plasma to increase the wettability of low-density PE [127].

A significant advantage of APP over low-pressure processes is that it is possible to inject liquid precursors in the form of aerosols, either directly into the discharge or in the afterglow, see section 4.2. This has found a wide range of applications including the engineering of biomaterials, discussed in section 5. Ward *et al* [128] coupled aerosol injection to an AC (15 kHz) APP jet. Using acrylic acid they were able to achieve high retention of carboxylic acid groups on polymer surfaces [129]. Pulsed DBD plasmas in a noble gas coupled with aerosols were used to create super-hydrophobic surfaces with a WCA greater than 160° with low hysteresis [128]. Such aerosol injection techniques allow high retention of precursor structure and activity, a property that is widely required in the biomaterials field. However, the exact mechanisms occurring in plasma-aerosol reactors still remain largely unknown and more research is needed to bring this technology to the industrial scale.

In contrast to low-pressure plasma polymerization processes, APP processes often suffer from low adhesion and poor coating stability. Energetic ion bombardment cannot be used at APP, due to the highly collisional nature of the sheath. However, the substrate surface can be activated prior to deposition by DBD [130] or corona plasma treatment [131]. Other strategies include heating the substrate to temperatures of 50–100 degrees [132]. This results in smoother films with fewer surface features, helping to improve the stability of the top layers. Increasing the discharge power as well as the deposition time can also increase the cross-linking of the deposited layers [133]. For example, a water-stable plasma polymerized acrylic acid coating has been manufactured with the use of APPJs [134].



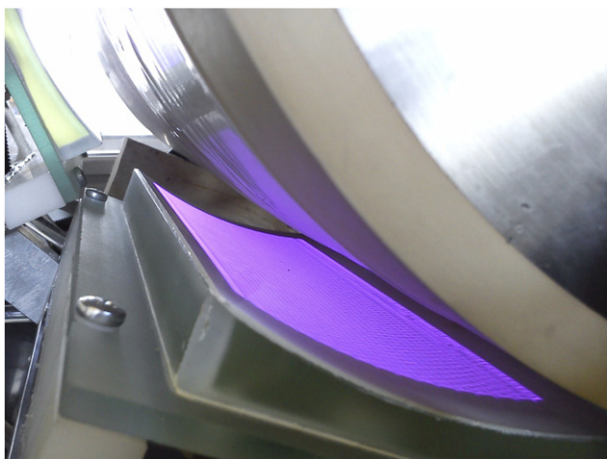

**Figure 16.** APP DSCBD for large scale surface activation. Reproduced from [136]. CC BY 4.0.

#### 4.5. Industrial-scale atmospheric pressure reactors

APP plasmas have the advantage of lower operating costs compared to low-pressure systems, since no vacuum equipment (reactors, pumps, valves, lock systems) is required. Compared to low-pressure systems, APPs are more easily adapted to the roll-to-roll treatment of polymers, considerably reducing the cost of the final product. Nevertheless, efficient industrial processing requires large areas to be treated. As discussed in section 4.1, the generation of uniform APP plasmas is a complex and challenging engineering task. Large-scale industrial treatment requires the development of plasma sources and processes adapted to the needs of mass production. There are two main strategies to enable large scale treatment: (i) increasing the size of the plasma source; (ii) moving the treatment area.

The treatment area can be increased either by (1) enlarging the electrodes or (2) assembling an array of plasma sources. In this regard, DBD sources have the intrinsic advantage that the area of the dielectric-covered electrodes can be increased without compromising the uniformity of the discharge. Balcon *et al* [135] developed an RF plasma source that can treat samples with dimensions up to 80 cm<sup>2</sup>.

Recently, a diffuse coplanar surface barrier discharge (DSCBD) was developed for in-line activation of fabrics (see figure 16) with a discharge area of 0.5 m<sup>2</sup> [136]. When combined with the roll-to-roll system, the plasma processing speed can reach 100 m min<sup>-1</sup>. To avoid localized non-uniformity of the treatment due to plasma filaments, the substrate must be placed as close to the discharge as possible [136]. However, one drawback of the DSCBD is that it can only process flat surfaces.

Roll-to-roll plasma processes are necessary for large-area in-line production. DBD functionalization of PE films to enhance coating adhesion is one of the possible solutions for large scale production, Zhang *et al* [137]. The polymer surface can be modified uniformly and continuously in the plasma zone through which the film passes at a speed of 10 m min<sup>-1</sup>. To achieve large-scale treatment with good uniformity on an industrial scale, Liu *et al* investigated an APP dual-frequency

DBD [138]. Figure 17 presents a schematic of the roll-to-roll dual-frequency plasma reactor. The discharge is generated in the 1 mm gap between a flat grounded electrode and a curved powered electrode. Ar, N<sub>2</sub>, O<sub>2</sub> were injected with a flow rate of 5 SLM, 0.2 SLM, 1 SLM, 0.3 SLM respectively as the feeding gases and mixed with HMDSO. Dual-frequency operation was more efficient at breaking the Si-CH<sub>3</sub> bonds in the precursor, leading to more efficient functionalization. The required increase in surface energy of the treated polymer surface was achieved within 23 s at a power density of 15–30 W cm<sup>-2</sup>, which is short enough for future industrial applications.

Individual jets can be assembled into arrays to increase the treatment area. Kment *et al* [139] used 9 pulsed plasma jets to functionalize films used for photocatalytic applications (see figure 18). Hu *et al* [140] investigated the effects of applied electric field on plasma jets in a 2D assembly. Theoretically, the number of jets can be increased as required to allow large-scale treatment. However, there can be jet-to-jet interactions due to electrostatic, hydrodynamic, photolytic and chemical interactions [122], causing the afterglow to diverge [141], the onset of different discharge modes [142], and non-uniformity of the functionalization [143].

Jet arrays have been shown to be efficient for polymer functionalization, but their industrial application is highly limited by the punitive cost of the used expensive gases. In this regard, DBDs and pulsed plasmas, which can operate in cheaper gases (e.g. N<sub>2</sub>), are more attractive for large scale polymers treatment.

Another approach to enlarge the treatment area is to displace either the plasma source or the substrate by means of an XY-scanning stage, often combined with a roll-to-roll process. Massines *et al* [144] used a scanning stage to move the substrate below an RF jet, and Han *et al* used a scanned 23 kHz plasma jet to treat large areas [145]. The scanning speed and scan interval can affect the treatment uniformity over large areas [146, 147]. Generally, the plasma source is scanned across the substrate in a raster fashion, with overlapping scan tracks. The spacing between each can must be optimized to achieve adequate processing uniformity [148].

#### 4.6. Conclusions

APP discharges have proved to be effective sources for polymers functionalization. Current fields of application range from polymer activation in the textile industry through introduction of O-containing groups, to the incorporation of C-F functional groups, or the incorporation of new moieties on the polymer top surface. APPs have several advantages in comparison to low-pressure plasma sources. These include lower equipment and operational costs (no need for vacuum equipment), easier operation of roll-to-roll units on a large industrial scale, and aerosol injection with control of the precursor fragmentation. In order to exploit all of these advantages, the problems that must be solved include reactor up-scaling, keeping the gas temperature low, and controlling process uniformity. The development of APP technology is driven by high industrial demand. Nevertheless, technical progress must be

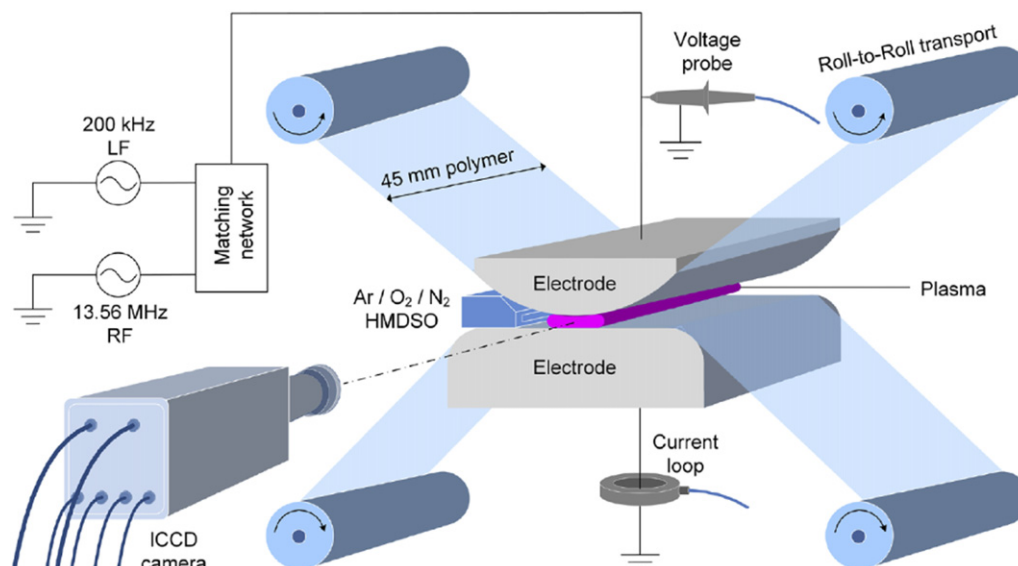

**Figure 17.** Schematic of roll-to-roll APP 200 kHz/13.56 MHz dual-frequency DBD for silica-like coating deposition. Reproduced from [138]. © IOP Publishing Ltd. All rights reserved.

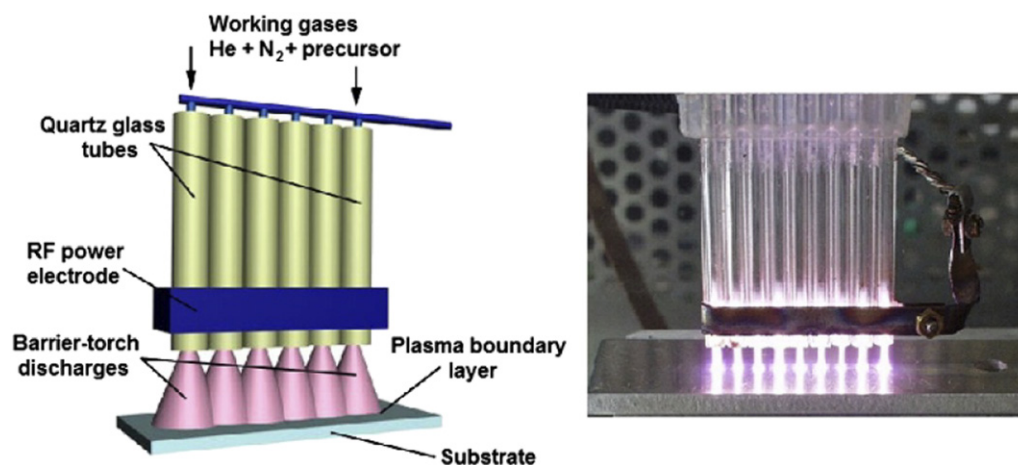

**Figure 18.** Schematic of APP RF plasma jet array for deposition of catalytic coatings. Reprinted from [139], Copyright (2009), with permission from Elsevier.

underpinned by a thorough understanding of the fundamental science behind the operation of plasma sources working in ambient pressure conditions.

### 5. Polymer functionalization for biomedical applications

Plasma functionalization is used industrially for a wide range of biomedical products, for example:

- Contact lenses (to minimize protein adsorption without decreasing oxygen permeation)
- Catheters (to improve adhesion between components),
- Well plates (to improve wetting, and to create anchor sites for bioactive molecules),
- Stents (to minimize unspecific protein adsorption),
- Analytical slides (to create amine or carboxylic groups)
- Implants (to improve biocompatibility)

- Scaffolds for cell growth.

However, the exact process conditions and chemistries are very often kept as industrial secrets, and are not published in the open literature.

The list of requirements that must be fulfilled in order for a material to be defined as biocompatible has been debated for a long time. This is because each biological system has specific requirements, and therefore a given surface could be compatible with one biological system but give awful results with another. For example, a surface equipped with amino groups might be good for cell cultivation, but could also trigger coagulation of blood cells. Therefore, the European Society for Biomaterials has offered the following definition of biocompatibility: ‘the ability of a biomaterial to induce the appropriate answer in a specific application’ [149] meaning biocompatibility must be defined in the context of a given application.

It is often assumed that hydrophobic (low surface energy) surfaces are not appropriate for biological interaction, whereas increased surface tension is better. However, this is not true in every case. On a molecular level, hydrophilic surfaces will interact with water molecules and water molecules will bond to them. Therefore, such a surface will look like water to a biological system, and components from biological liquids will tend to ‘ignore’ this surface and will not adhere to it. However, if the hydrophilicity is caused by functional groups with a strong dipole moment, this can interact with charged groups (such as amino- or carboxylic groups) on a biological entity. On the other hand, if the hydrophilicity is caused by ethylene oxide units which have only a small dipole moment, then the adhesion of components from the liquid phase will be small [150]. In contrast to these two hydrophilic cases, a more hydrophobic surface can also interact with biological systems, but in a different way. This is because surface-active molecules like proteins incorporate structural domains which are more hydrophobic, and these domains can interact with a hydrophobic surface via van-der-Waals-forces. This explains why vascular grafts are often made from PTFE (Teflon), which has very low surface energy. Albumin, the most prominent protein in the blood, will adhere to, and cover a PTFE surface quickly. As a result, the material is not ‘recognized as foreign’ by blood and other cells, and the graft becomes compatible. Other mammalian cells deliver other proteins to their environment which can initiate adhesion to hydrophobic surfaces. To summarize, in tissue engineering cell adhesion to scaffolds is always mediated by protein adsorption. In order to understand protein adsorption, all of the functional groups at the contacting surface must be taken into account, as well as the interaction with water. Furthermore, protein adsorption mechanisms vary with the protein structure, which can depend on time. In other words, protein adsorption is a dynamic process, since proteins can change their structure, create three-dimensional protein phases on the surface and can be displaced by other proteins (the Vroman effect [151]) before the cells adhere and start to proliferate. Considering all of these processes at surfaces in contact with biological fluids, it is clear that there is no single concept that can define how a given surface interacts with biological systems. Furthermore, elastic properties, as well as long-term stability (and other parameters), must be considered in the development of scaffolds and implants. For more detailed information the reader is referred to the literature with leading opinions in this field presented by Buddy Ratner (blood compatibility) [152, 153], David Williams (implant compatibility) [154] and Erwin Vogler [the role of water and (3D) protein adsorption [155, 156]. The shortcomings of simple hydrophilic–hydrophobic concepts are discussed by Alexander [157]. In summary, to create a compatible surface, in addition to the surface chemistry, the surface structure and stiffness must also be taken into account.

Making a surface biocompatible starts by the creation of chemical functionalities which can bind to biologically active components. These components can include proteins, protein segments which enhance cell adhesion (such as RGD-peptides) or proteins which trigger other biological processes via fixed growth factors, antibodies or enzymes.

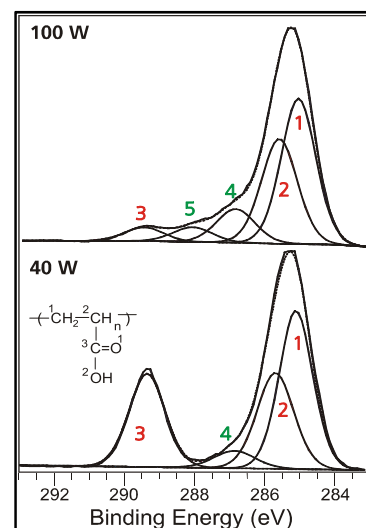

Peak No.	5	4	3	2	1
$E_B$ (eV)	288.1	286.8	289.4	285.5	285.0
Chemical composition in atomic %					
			COOH		
40 W	-	5.5	26.1	27.3	41.1
100 W	5.1	11.6	4.7	33.5	45.0

**Figure 19.** ESCA spectra for plasma polymerization of acrylic acid (0.3 mbar) with different inputs. RF power at 13.56 MHz.

Finally, it is important to note that sterilization procedures are needed for all materials used in the biomedical area.

### 5.1. Plasma polymerization for biomedical applications

Due to the complex situation at surfaces in contact with biological systems, the challenge is to provide a well-defined surface, stable to biological fluids, and which either enhances or inhibits cell attachment. The aim is to create a surface with well-controlled functional groups, with a well-defined surface density, uniformly distributed over the surface. For protein repelling surfaces, the deposition of thin layers containing ethylene oxide segments (PEO-like films) without charged groups is another field of plasma deposition [158, 159]. In addition to plasma grafting, several plasma polymerization approaches are available. These will be discussed after a short description of the development of this field.

### 5.2. Functional groups of interest

The challenge is to deposit thin, stable, and chemically well-defined films from appropriate precursors. Important functional groups include carboxylic groups, amino groups, hydroxyl groups, epoxide-, aldehyde- and thiol groups. The majority of publications discuss carboxyl- and amino groups. For biomedical applications the resulting hydrophilic surfaces are either used directly, or the functionalities serve to bind biological active molecules (sometimes via spacer molecules). These can contain peptide sequences known to support cell adhesion (e.g. RGD), or growth factors, or so-called aptamers which attract progenitor cells onto vascular implant surfaces. Due to their importance, surface functionalization with carboxylic and amino groups will be discussed in more detail.



**Table 3.** IR data on acrylic acid plasma polymerized with power input variation. Reprinted from [16], Copyright (1999), with permission from Elsevier.

Treatment (on/off times)	Power (W)	Pressure (mbar)	Flow (sccm)	Yasuda factor (MJ kg <sup>-1</sup> )	Intensity ratio of IR peaks for C=O/C-H	Deposition rate	
						nm min <sup>-1</sup>	nm J <sup>-1</sup>
Continuous wave plasma	100	0.3	20	92.9	1.25	150	0.03
Continuous wave plasma	40	0.3	20	37.2	7.0	200	0.08
Pulsed (1 ms/1 ms)	20	0.3	20	(18.6)	9.5	250	0.21
Pulsed (1 ms/2 ms)	13.3	0.3	20	(12.4)	12.5	160	0.20
Pulsed (1 ms/4 ms)	8	0.3	20	(7.4)	10.5	180	0.38
Pulsed (1 ms/5 ms)	6.7	0.3	20	(6.1)	9.8	170	0.42
Pulsed (1 ms/10 ms)	3.6	0.3	20	(3.3)	8.2	40	0.19
Acr. acid on KBr					13.5		

**5.2.1. Carboxylic functions.** The variety of precursor compounds used for the deposition of carboxyl-rich surfaces is quite narrow. One approach is to use carbon dioxide-based plasmas. However, in addition to carboxylic groups, these also create other oxygen-based functionalities. A better approach is to use precursors which already contain the required functionality, such as acrylic acid and homologous compounds. Another choice is the use of anhydrides, which can create carboxylic groups after a hydrolysis step follows (in the case that ring-opening does not occur during the deposition process).

Carboxylic-rich films can be created by grafting acrylic acid onto polymers, or by direct plasma polymerization of acrylic acid. Following Yasuda's approach, the ratio of the energy input to mass flow must be below the threshold for full dissociation. This can be either achieved by keeping the input power low in a continuous-wave plasma, or by pulsing the power input. In the latter, the plasma is periodically switched on and off during the process. The duty cycle is defined as the ratio of on-time to the total cycle time (on plus off time). Low duty cycles correspond to lower average power input.

In figure 19 the XPS-spectra and the chemical composition of carboxylic films deposited at high (100 W) and low (40 W) power are shown. It is clear that the carboxylic carbon signal is strongly reduced for high power input. This finding is supported by the IR-spectra data listed in table 3.

Table 3 additionally presents data from pulsed plasma deposition for comparison. A good idea of the degree of functional group retention can be obtained from the ratio (shown in the sixth column) of the IR signal intensity for the functional group of interest to that from another group (the C-H group in this case). The last row of the table shows this ratio for pure acrylic acid. Some of the carboxylic groups are destroyed by the plasma process in order to achieve crosslinking. If crosslinking is dominant, the film will be more stable but fewer functionalities will remain. In contrast, a high IR ratio (comparable to that from the pure precursor) means that little crosslinking has happened, and the compound is only fixed by adsorption. This results in an unstable film, which is easily dissolved in aqueous media. In practice, an intermediate situation should be chosen. Table 3 suggests that films deposited with a duty cycle of ~30% will contain an optimal density of functionalities. In any case, under these deposition conditions, the Yasuda factor must be lower than about 45 MJ kg<sup>-1</sup> to retain enough

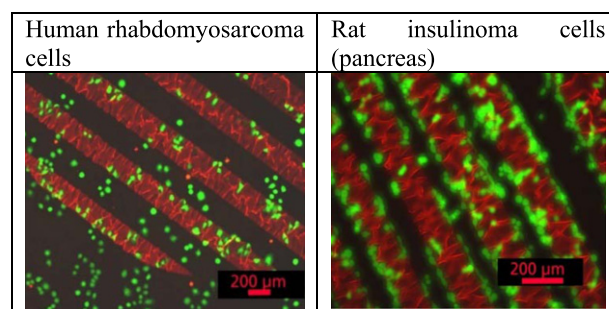
**Figure 20.** Cell growth on plasma patterned surfaces.

carboxyl functionalities. The functional group density should not be too high, since the immobilized active biomolecules have a certain size, and must have enough space to perform their activity. The lateral density of functional groups can be tuned by copolymerization with compounds (such as ethylene or octa-(1,7)diene), which lack these functionalities [160].

In addition, these precursors can enhance the crosslinking and therefore the stability of the resulting films. In the following example (figure 20) surfaces were first coated with a fluorocarbon layer (using discharge with CHF<sub>3</sub> precursor) and then structured by plasma deposition of acrylic acid through a grid [161]. The black areas in the figure are hydrophobic and the red areas are hydrophilic. The green dots represent living cells. The question is: is this surface pattern recognized by mammalian cells? The answer is: that depends on the type of cells. Rhabdomyosarcoma cells were found to ignore the hydrophilic/hydrophobic pattern, whereas rat insulinoma cells settled only on the hydrophilic area. Furthermore, they prefer to adhere to uneven areas rather than flat planes. In addition to surface energy and surface structure, the stiffness of the plasma polymers also plays a role. Plasma deposition using acrylic acid produces layers with a weak hydrogel-like interface. Finally, cell adhesion is mediated by the so-called extracellular matrix, which is the self-made environment produced by the cells. For example, cells produce proteins to mediate contact with each other (intercellular 'communication') as well as to foreign surfaces. In the case of the insulinoma cells, calcium ions are essentially involved, and these are preferably present in the carboxyl groups. In contrast, rhabdomyosarcoma cells achieve adhesion without Ca<sup>2+</sup>. This is therefore another aspect affecting cell adhesion.



**5.2.2. Amino groups.** Amino groups are of equal utility to carboxyl groups for the binding of biologically active molecules or compounds to almost every kind of polymer surface. Many precursor molecules and gas mixtures have been investigated for the generation of amino groups. The simplest are ammonia, or mixtures of nitrogen and hydrogen, to which polymerizable precursors like ethylene can be added. Since many different nitrogen-containing groups can be produced, it is often not clear (especially in older literature) if amino groups are present or if the nitrogen has been incorporated in the form of imines or amides. Therefore, the different groups must be identified by derivatization, or by other appropriate analytical techniques including IR absorption or XPS, as described above. Nitrogen-containing monomer precursors can also be used. These are mainly allylamine and homologues, as well as diaminocyclohexane (DACH). DACH produces films with a high yield of amino groups, whereas allylamine gives a higher deposition rate due to its reactive double bond. Once again, it is necessary to define the optimal surface density of the functional groups. For many applications, a density of one functional group per square nanometer is sufficient, dependent on the size of the biomolecule to be fixed. This can be achieved by using copolymerization to limit the surface density, and thus prevent any unintended adverse effects due to unreacted amino groups remaining after immobilization of the biomolecules. For example, a positively-charged surface will trigger coagulation in blood in contact with it [162]. Therefore, for a material in contact with blood the density of positively-charged groups must be limited, such that all of them will be consumed by reaction with the added biomolecules. For further information about film deposition about these and other functional groups, the reader is referred to an excellent review by Siow *et al* [163].

An advantage of plasma polymerization is that it allows chemically bonding of coatings to any polymer substrate (provided that it is stable to the plasma environment). A film thickness of only a few tens of nanometers is generally required, and the optical properties of the film usually resemble those of transparent bulk polymers (e.g. silicone or acrylate used for contact lenses and intraocular lenses). Liquid reservoirs made from polycarbonate and cyclo-olefin copolymers are used for many applications including optical analysis (such as well plates), medication delivery (prefilled syringes) and tissue engineering. Plasma polymerization coating has been applied to these devices in order to enhance the wetting properties, as well as to reduce unspecific protein (or medicament) adsorption. Some of such devices treated at Fraunhofer IGB are shown in figure 21.

The substrates or devices used for biomedical applications provide a number of challenges for surface treatment. In general, they are not planar, and often have complex three-dimensional shapes. For the applications discussed, these objects must be coated over their whole area. Fortunately, a constant deposition thickness is not needed. Furthermore, the substrates often consist of porous material. There have been some studies of the depth of penetration of plasma polymers into porous materials [164, 165]. Measurements are usually made by stacking textile layers; after plasma treatment the stack is separated and examined to determine how many layers



have been modified. APP processes can enhance the penetration depth, due to the short mean free path of the species, unless the pore diameter is smaller than around 100 nm. For micro-filtration membranes used for blood cleaning, a forced flow of the gas from the discharge into the membrane allowed surface modification up to a depth of several tens of micrometers [164]. In this case, the pore diameter was about one to a few micrometers, and a density of one to two amino groups per square nanometer was achieved.

### 5.3. Scaffolds

Mammalian cells are grown in liquid culture media, but so-called scaffolds must be provided to enable adhesion to a substrate. These scaffolds can be building blocks for implants, or they can simulate an artificial organ for future applications [166]. Furthermore, an important application of cells grown on scaffolds is their use as replacements for animal-based tests. Scaffolds consist of porous structures made from a range of materials. For tissue engineering, the pore diameters are typically up to a few hundreds of micrometers. Since deep penetration of the surface modification is required, APP plasma treatment is preferred [165]. Scaffolds must fulfil several requirements. The modified surface needs to mimic the natural environment where cells grow. For instance, bone implants must be rigid and are thus made from inorganic materials, but are covered with an ECM-like polymer layer to offer the best conditions for cell growth. Scaffolds for soft tissue are preferably made out of polymers and hydrogels with some elasticity; furthermore, diffusion of components from the culture media to the surface must be guaranteed. Electro-spinning can produce materials with a structure close to that of natural samples comprised of collagen fibers. Fine-spun fibers can be made from poly-caprolacton or PLA, which are both biodegradable materials. These electro-spun non-woven materials allow cells to penetrate, adhere and proliferate. The drainage capacity must be sufficient to allow nutrient uptake and the release of metabolic products. Such scaffolds, of a few mm in thickness, are usually hydrophilized to encourage culture medium uptake and cell growth and in some cases equipped with antimicrobial active agents [167]. The inner surfaces are often treated to generate amino groups which provide a starting point for cell adhesion and/or protein adsorption.

### 5.4. PEO-like thin films

Protein adsorption occurs whenever biological fluids are in contact with surfaces. Unintended, unspecific protein adsorption (so-called fouling) is a common problem to be avoided. Protein adsorption can be minimized by creating ethylene oxide-type surfaces, which are hydrophilic but do not have partial charges. Such surfaces can be created by plasma deposition, using either ethylene oxide itself, or derivatives such as 1,2-dimethoxyether (glyme) or diglycoldimethylether (diglyme) [150, 158]. However, this approach creates only short-chain polymers. Longer-chain ethers can be deposited from liquid solutions and then cross-linked and fixed to the support by plasma (by ion bombardment and radiation). As an

For diagnostics and tissue engineering with reduced protein adsorption	For reduced protein adsorption on daily used commodities	For endotoxine scavenging (module) and reduced adhesion and antimicrobial behavior
		
Lab commodities made from polymers as a replacement for glass	Contact lens	Apheresis module and catheter

**Figure 21.** Devices based on polymers used in diagnostic and therapy in high volume production.

example, coatings with decreased protein adsorption and stability in 1 M NaOH solution for an hour at 50 °C have been achieved [40].

**5.5. Film stability**

One of the main challenges is to deposit layers which are stable in a given biomedical application. The stability of a given film depends on the density of chemical bonds to the polymer surface, the degree of cross-linking and the chemical stability of the functional groups (for example, against oxidation). If the films are less cross-linked then water absorption and film swelling can occur, mechanically destabilizing the film. If the degree of cross-linking is high the films will be more rigid and may develop cracks which can cause the film to peel off. Thus, mechanical and corrosion resistance is required. The film thickness has also an effect on the mechanical stability; films should be as thin as possible so as not to accumulate intrinsic stress. The chemical bonding of the film to the substrate depends on the situation at the beginning of the deposition. Sufficient energy must be supplied to the plasma to break bonds on the surface and in the precursor. A high ratio of the energy flux to the surface to the precursor mass flux will increase adhesion [78]. An optimal ion bombardment energy can also help adhesion, as shown by a study where additional bias voltage was applied [79]. Such ion bombardment will generate radical sites at the polymer surface and also in the growing film, favoring cross-linking. If the thermal expansion coefficient of the film differs significantly from that of the substrate, for thicker films a gradient deposition is recommended [75] to minimize the stress at the interface.

**5.6. Pressure regime**

The literature cited in this chapter mainly deals with low-pressure plasma processes. This is due to the longer history of this field; the study of stable film deposition by APP plasma is much less mature. However, APP processes hold the promise of lower-cost surface oxidation and functionalization due to lower capital equipment costs. In addition, substrate handling is much easier without a vacuum conditions, and continuous (roll-to-roll) treatment is a possibility. On the other hand,

the gas composition in the reactor is more controlled at low-pressure plasma, allowing unique functionalities. Additionally, film cross-linking is more easily achieved, due to the ion energy control. Finally, the gas throughput at low pressure is about three orders of magnitude lower. If acceptable product quality can be achieved by both low-pressure and AAP processes, the choice will depend on all of these arguments, together with economic considerations such as the overall process productivity and the market size.

**5.7. Conclusions**

Biological systems are very sensitive to surfaces with which they are in contact. Therefore these interfaces must be carefully prepared with respect to their chemical composition, topography, and stiffness. Plasma functionalization allows many of the requirements for biomaterial surfaces to be met. A range of different functionalities can be generated with appropriate density and on almost any polymeric material. These processed surfaces can come into direct contact with living media, or can be used to anchor biologically-active molecules such as enzymes, cell-adhesion promoting peptides, and others. The whole spectrum from cell- and protein-repelling surfaces to cell- and protein-adhering surfaces can be created by plasma treatment. Such surface treatments are not limited to flat substrates, but can also be applied (in some circumstances) to the interior of pores in scaffolds and membranes. The remaining challenge is to make surfaces which are stable over the lifetime of the product for each specific environment.

**6. Overall conclusions and outlook**

This article presents the foundations of plasma for surface functionalization of polymers for industrial and bio applications. The properties of the finished surface will depend on the incident fluxes of the various reactive plasma species, as well as irradiation with ultra-violet photons generated by the plasma. The fluxes depend on the geometry of the plasma reactor, the discharge configuration, the discharge power, the gas composition and input flow rate, and sometimes even on the properties of the substrate. The correlation between the applied

discharge parameters and the characteristics of the plasma in contact with the substrate is not trivial and represents a scientific challenge. The large literature on plasma functionalization of polymers typically presents the external discharge parameters, but rarely the plasma parameters, so no general picture of the complex mechanisms involved in polymer surface modification by gaseous plasma is currently available. The scientific challenge is the development of a theoretical understanding of the interaction of each incident reactive species with the surface at the atomic scale and experimental confirmation of the theoretical predictions. The next scientific challenge is to understand the synergies between different species, for example, neutral radicals, ions of significant kinetic energy, and UV/VUV radiation. Understanding the surface mechanisms on the atomic scale is needed to allow the scaling up of developed processes from experimental to industrial reactors.

Plasma treatment of polymers always causes at least two effects: (i) surface functionalization, and (ii) etching. The latter often results in the nanostructuring of the polymer surface, which is beneficial for achieving a super-hydrophilic or super-hydrophobic surface finish. However, such a surface finish is often unstable. In particular, the high surface energy needed for a highly hydrophilic surface finish is against the basic law of thermodynamics, so hydrophobic recovery is usually observed. In order to exploit such high energy surfaces, the plasma-activated polymer needs to be coated with desired molecules within a short time.

Industrial plasma processing of polymers can be achieved either at APP or at pressures below a few mbar. In between, there is a zone that has not been tackled frequently. At APP, the primary loss mechanism of reactive species is three-body collisions in the gas phase, while at low pressure it is surface neutralization, relaxation, or recombination. A scientific challenge is understanding the plasma behaviour at sub-APP, i.e. in the range between about 0.01 and 1 bar. Such plasmas may be useful for rapid and uniform modification of polymers without the need for expensive vacuum equipment.

Treatment of polymers of complex geometry in the continuous mode represents a technological challenge. The vast majority of current low-pressure reactors operate in the batch mode, for practical reasons because efficient differential pumping is limited by the capacity of the vacuum pumps and the cost of electricity. Knowledge of the surface modification by using plasma at sub-APP would enhance the chances for treatment in the continuous mode since differential pumping is more practical if the pressure difference is low.

While the driving force of plasma science in the past decades has been the microelectronics industry, the challenge for the future is understanding the interaction of plasmas with organic materials, in particular biological materials. Plasma has been successfully used to achieve the desired surface properties of polymers for biomedical applications, but the direct interaction with biological matter is still in its infancy. Possible applications are in tissue engineering, curing diseases such as cancer, and in agriculture.

## Acknowledgments

M Mozetič gratefully acknowledges J Trtnik, S Ritlop, and G Primc for technical assistance and routine measurements. The companies Elvez, Kolektor, Surface Treat, Induktio and Plasmadis are gratefully acknowledged for sharing photos of industrial reactors and results of plasma characterization. The financial support from the Slovenian Research Agency (research core funding No. P2-0082 and project L2-2616) is gratefully acknowledged. Partial financial support from Agentschap Innoveren en Ondernemen Vlaio project HBC.2019.0157 is acknowledged by A Nikiforov.

## Data availability statement

All data that support the findings of this study are included within the article (and any supplementary files).

## ORCID iDs

Jean-Paul Booth  <https://orcid.org/0000-0002-0980-3278>

Miran Mozetič  <https://orcid.org/0000-0002-3529-3371>

Anton Nikiforov  <https://orcid.org/0000-0002-2255-6419>

Christian Oehr  <https://orcid.org/0000-0002-5551-0820>

## References

- [1] Strobel M and Lyons C S 2011 *Plasma Processes Polym.* **8** 8
- [2] Di Mundo R and Palumbo F 2011 *Plasma Processes Polym.* **8** 14
- [3] Müller M and Oehr C 2011 *Plasma Processes Polym.* **8** 19
- [4] Yasuda H 1978 *J. Polym. Sci. A* **16** 743–59
- [5] Barz J, Haupt M, Pusch K, Weimer M and Oehr C 2006 *Plasma Processes Polym.* **3** 540
- [6] Magonov S N, Elings V and Whangbo M-H 1997 *Surf. Sci.* **375** L385
- [7] Jalili N and Laxminarayana K 2004 *Mechatronics* **14** 907
- [8] Arwin H 2000 *Thin Solid Films* **377–378** 48
- [9] Hinrichs K and Eichhorn K-J 2018 *Ellipsometry of Functional Organic Surfaces and Films (Springer Series in Surface Sciences)* (New York: Springer)
- [10] Brunauer S, Emmett P H and Teller E 1938 *J. Am. Chem. Soc.* **60** 309
- [11] Sabbatini L (Ed) 2022 *Polymer Surface Characterization* (Berlin: de Gruyter & Co)
- [12] Gaur R K and Gupta K C 1989 *Anal. Biochem.* **180** 253
- [13] Moser M, Nirmalanathan N, Behnke T, Geissler D and Resch-Genger U 2018 *Anal. Chem.* **90** 5887
- [14] Haupt M, Barz J and Oehr C 2008 *Plasma Processes Polym.* **5** 33
- [15] Klare J P 2013 Chemistry of spin labeling *Encyclopedia of Biophysics* ed G C K Roberts (Berlin: Springer) p 287
- [16] Oehr C, Müller M, Elkin B, Hegemann D and Vohrer U 1999 *Surf. Coat. Technol.* **116–119** 25
- [17] Van Deynse A, Cools P, Leys C, Morent R and De Geyter N 2014 *Surf. Coat. Technol.* **258** 359
- [18] Morent R, De Geyter N, Trentesaux M, Gengembre L, Dubruel P, Leys C and Payen E 2010 *Plasma Chem. Plasma Process.* **30** 525
- [19] Oehrlein G S 1997 *Surf. Sci.* **386** 222
- [20] Cobine J D 1941 *Gaseous Conductors—Theory and Engineering Applications* vol 27 ed H E Clifford (New York: McGraw-Hill)



- [21] Sayasov Y S 1976 *Bull. Soc. Frib. Sci. Nat.* **65** 76
- [22] Tabarés F L 2020 *Plasma Applications for Material Modification: From Microelectronics to Biological Materials* ed F L Tabarés (Singapore: Jenny Stanford Publishing)
- [23] Booth J P *et al* 2019 *Plasma Sources Sci. Technol.* **28** 055005
- [24] Vesel A, Primc G, Zaplotnik R and Mozetič M 2020 *Plasma Phys. Control. Fusion* **62** 024008
- [25] Gosar Ž, Kovač J, Mozetič M, Primc G, Vesel A and Zaplotnik R 2020 *Plasma Chem. Plasma Process.* **40** 25
- [26] Vesel A and Mozetic M 2017 *J. Phys. D: Appl. Phys.* **50** 293001
- [27] Mozetic M and Cvelbar U 2009 *Plasma Sources Sci. Technol.* **18** 034002
- [28] Mozetic M and Cvelbar U 2007 *Int. J. Nanosci.* **06** 121
- [29] Mozetic M, Vesel A, Stoica S D, Vizireanu S, Dinescu G and Zaplotnik R 2015 *Appl. Surf. Sci.* **333** 207
- [30] Zaplotnik R, Vesel A and Mozetič M 2018 *Plasma Processes Polym.* **15** 1800021
- [31] Gibson A R and Gans T 2017 *Plasma Sources Sci. Technol.* **26** 115007
- [32] Ellis J, Branson J, Niemi K, Wagenaars E and Gans T 2020 *J. Phys. D: Appl. Phys.* **53** 485202
- [33] Chabert P and Braithwaite N S 2011 *Physics of Radio-Frequency Plasmas* (Cambridge: Cambridge University Press)
- [34] Fantz U, Briefi S, Rauner D and Wunderlich D 2016 *Plasma Sources Sci. Technol.* **25** 045006
- [35] NIST 2020 Atomic spectra database-NIST standard reference database 78 available from: <https://nist.gov/pml/atomic-spectra-database> October 30, 2020 (cited 2021 March 30)
- [36] Doliška A, Vesel A, Kolar M, Stana-Kleinschek K and Mozetič M 2012 *Surf. Interface Anal.* **44** 56
- [37] Mozetič M 2020 *Polymers* **12** 2498
- [38] Vesel A and Mozetic M 2012 *Vacuum* **86** 634
- [39] Izdebska-Podsiadły J 2019 Application of plasma in printed surfaces and print quality *Non-Thermal Plasma Technology for Polymeric Materials* ed S Thomas *et al* (Waltham: Elsevier) ch 6 p 159
- [40] Oehr C 2003 *Nucl. Instrum. Methods Phys. Res. B* **208** 40
- [41] Nitschke M 2008 Plasma modification of polymer surfaces and plasma polymerization *Polymer Surfaces and Interfaces: Characterization, Modification and Applications* ed M Stamm (Berlin: Springer) p 203
- [42] Knizek R, Knizkova D and Bajzik V 2020 *Autex Res. J.* **20** 524–29
- [43] Longo R C, Ranjan A and Ventzek P L G 2020 *ACS Appl. Nano Mater.* **3** 5189
- [44] Vesel A, Kolar M, Doliska A, Stana-Kleinschek K and Mozetic M 2012 *Surf. Interface Anal.* **44** 1565
- [45] Borcia G, Anderson C A and Brown N M D 2003 *Plasma Sources Sci. Technol.* **12** 335
- [46] Abou Rich S, Leroy P, Dufour T, Wehbe N, Houssiau L and Reniers F 2014 *Surf. Interface Anal.* **46** 164
- [47] Vukušić T, Vesel A, Holc M, Ščetar M, Jambrak A R and Mozetič M 2018 *Materials* **11** 372
- [48] Vesel A, Zaplotnik R, Mozetič M and Primc G 2021 *Appl. Surf. Sci.* **561** 150058
- [49] Gogolides E, Constantoudis V, Kokkoris G, Kontziampasis D, Tsougeni K, Boulousis G, Vlachopoulou M and Tserepi A 2011 *J. Phys. D: Appl. Phys.* **44** 174021
- [50] Vourdas N, Kontziampasis D, Kokkoris G, Constantoudis V, Goodyear A, Tserepi A, Cooke M and Gogolides E 2010 *Nanotechnology* **21** 085302
- [51] Kontziampasis D, Trantidou T, Regoutz A, Humphrey E J, Carta D, Terracciano C M and Prodromakis T 2016 *Plasma Processes Polym.* **13** 324
- [52] Primc G 2020 *Polymers* **12** 2295
- [53] Nguyen H D and Yajima T 2017 *J. Photopolym. Sci. Technol.* **30** 325
- [54] Lojen D, Zaplotnik R, Primc G, Mozetič M and Vesel A 2020 *Appl. Surf. Sci.* **533** 147356
- [55] Zaplotnik R and Vesel A 2020 *Polymers* **12** 1136
- [56] Knoll A J, Luan P, Bartis E A J, Kondeti V S S K, Bruggeman P J and Oehrlein G S 2016 *Plasma Processes Polym.* **13** 1069
- [57] Macko P, Veis P and Cernogora G 2004 *Plasma Sources Sci. Technol.* **13** 251
- [58] Zaplotnik R, Vesel A and Mozetic M 2012 *Sensors* **12** 3857
- [59] Primc G and Mozetič M 2019 *Surf. Coat. Technol.* **376** 15
- [60] Stafford L, Guha J and Donnelly V M 2008 *J. Vac. Sci. Technol. A* **26** 455
- [61] Gomez S, Steen P G and Graham W G 2002 *Appl. Phys. Lett.* **81** 19
- [62] Raizer Y P, Shneider M N and Yatsenko N A 1995 *Radio-Frequency Capacitive Discharges* (Boca Raton, FL: CRC Press)
- [63] Arpagaus C, Oberbessel G and Rudolf von Rohr P 2018 *Plasma Processes Polym.* **15** 1800133
- [64] Šourková H and Špatenka P 2020 *Polymers* **12** 2099
- [65] Goodman J 1960 *J. Polym. Sci.* **44** 551
- [66] Williams T and Hayes M W 1966 *Nature* **209** 769
- [67] Kobayashi H, Bell A T and Shen M 1974 *Macromolecules* **7** 277
- [68] Drost H 1978 *Plasmachemie* (Berlin: Akademie-Verlag)
- [69] Yasuda H 1985 *Plasma Polymerization* (New York: Academic)
- [70] Hegemann D 2013 *J. Phys. D: Appl. Phys.* **46** 205204
- [71] Hegemann D, Körner E, Albrecht K, Schütz U and Guimond S 2010 *Plasma Processes Polym.* **7** 889
- [72] Short R D and Steele D A 2010 *Plasma Processes Polym.* **7** 366
- [73] d'Agostino R, Favia P, Förch R, Oehr C and Wertheimer M R 2010 *Plasma Processes Polym.* **7** 363
- [74] Thiry D, Konstantinidis S, Cornil J and Snyders R 2016 *Thin Solid Films* **606** 19
- [75] Vandenbossche M and Hegemann D 2018 *Curr. Opin. Solid State Mater. Sci.* **22** 26
- [76] Alonso J G, Dalmolin C, Nahorny J, Recco A A C, Fontana L C and Becker D 2018 *J. Polym. Eng.* **38** 795
- [77] Zanini S, Orlandi M, Colombo C, Grimoldi E and Riccardi C 2009 *Eur. Phys. J. D* **54** 159
- [78] Hegemann D, Hanselmann B, Blanchard N and Amberg M 2014 *Contrib. Plasma Phys.* **54** 162
- [79] Akhavan B *et al* 2019 *Appl. Mater. Today* **16** 456
- [80] Wiese R, Kersten H, Wiese G and Bartsch R 2015 *EPJ Tech. Instrum.* **2** 2
- [81] Bornholdt S, Fröhlich M and Kersten H 2014 *J. Phys. D: Appl. Phys.* **43** 465201
- [82] Bornholdt S, Fröhlich M and Kersten H 2014 Calorimetric probes for energy flux measurements in process plasmas *Complex Plasmas: Scientific Challenges and Technological Opportunities* ed M Bonitz *et al* (Cham: Springer) p 197
- [83] Vesel A and Mozetič M 2016 Low-pressure plasma-assisted polymer surface modifications *Printing on Polymers: Fundamentals and Applications* ed J Izdebska and T Sabu (Waltham: Elsevier) p 101
- [84] Zaplotnik R, Vesel A and Mozetic M 2013 *J. Fusion Energy* **32** 78
- [85] Akishev Y, Grushin M, Karalnik V, Petryakov A and Trushkin N 2010 *J. Phys. D: Appl. Phys.* **43** 215202
- [86] Akishev Y, Grushin M, Karalnik V, Petryakov A and Trushkin N 2010 *J. Phys. D: Appl. Phys.* **43** 075202
- [87] Chen F F 2016 *Introduction to Plasma Physics and Controlled Fusion* (Berlin: Springer)
- [88] Wang L, Dinescu G, Deng X, Ionita E R, Leys C and Nikiforov A Y 2017 *Plasma Sources Sci. Technol.* **26** 075012
- [89] Tarasenko V 2020 *Plasma Sources Sci. Technol.* **29** 034001



- [90] Kogelschatz U, Eliasson B and Egli W 1997 *J. Phys. IV France* **07 C4**
- [91] Deng X, Leys C, Vujosevic D, Vuksanovic V, Cvelbar U, De Geyter N, Morent R and Nikiforov A 2014 *Plasma Processes Polym.* **11** 921
- [92] Barletta F, Leys C, Colombo V, Gherardi M, Britun N, Snyders R and Nikiforov A 2020 *Plasma Processes Polym.* **17** 1900174
- [93] Jeong J Y, Babayan S E, Schütze A, Tu V J, Park J, Henins I, Selwyn G S and Hicks R F 1999 *J. Vac. Sci. Technol. A* **17** 2581
- [94] Babayan S E, Jeong J Y, Tu V J, Park J, Selwyn G S and Hicks R F 1998 *Plasma Sources Sci. Technol.* **7** 286
- [95] Lu X, Laroussi M and Puech V 2012 *Plasma Sources Sci. Technol.* **21** 034005
- [96] Fanelli F and Fracassi F 2014 *Plasma Chem. Plasma Process.* **34** 473
- [97] Egghe T, Van Guyse J F R, Ghobeira R, Morent R, Hoogenboom R and De Geyter N 2021 *Polym. Degrad. Stab.* **187** 109543
- [98] Bartis E A J, Luan P, Knoll A J, Hart C, Seog J and Oehrlin G S 2015 *Biointerphases* **10** 029512
- [99] Williams T S, Yu H and Hicks R F 2013 *Rev. Adhes. Adhes.* **1** 46
- [100] Wang R, Zhang C, Liu X, Xie Q, Yan P and Shao T 2015 *Appl. Surf. Sci.* **328** 509
- [101] Schäfer J, Foest R, Quade A, Ohl A and Weltmann K D 2008 *J. Phys. D: Appl. Phys.* **41** 194010
- [102] Tucker B S, Baker P A, Xu K G, Vohra Y K and Thomas V 2018 *J. Vac. Sci. Technol.* **36** 04F404
- [103] Yim J H, Rodriguez-Santiago V, Williams A A, Gougousi T, Pappas D D and Hirvonen J K 2013 *Surf. Coat. Technol.* **234** 21
- [104] Pulpytel J, Kumar V, Peng P, Micheli V, Laidani N and Arefi-Khonsari F 2011 *Plasma Processes Polym.* **8** 664
- [105] Kim S H, Kim J-H, Kang B-K and Uhm H S 2005 *Langmuir* **21** 12213
- [106] Kawamura E, Lieberman M A, Lichtenberg A J, Chabert P and Lazzaroni C 2014 *Plasma Sources Sci. Technol.* **23** 035014
- [107] Akishev Y, Grushin M, Kochetov I, Karal'nik V, Napartovich A and Trushkin N 2005 *Plasma Sources Sci. Technol.* **14** S18
- [108] Ross A D and Gleeson K K 2006 *Chem. Vapour Depos.* **12** 225
- [109] Da Ponte G *et al* 2011 *Surf. Coat. Technol.* **205** S525
- [110] De Geyter N, Morent R, Leys C, Gengembre L and Payen E 2007 *Surface and coating technology* **201** 7066–75
- [111] Nisol B *et al* 2016 *Plasma Process. Polym.* **13** 366–74
- [112] Kakaroglou A *et al* 2015 *RSC Adv.* **5** 27449–457
- [113] Nisol B *et al* 2016 *Plasma Process. Polym.* **13** 900–7
- [114] Hegemann D, Nisol B, Watson S and Wertheimer M R 2016 Energy Conversion Efficiency in Plasma Polymerization - A Comparison of Low- and Atmospheric-Pressure Processes *Plasma Process. Polym.* **13** 834–842
- [115] Hegemann D, Nisol B, Watson S and Wertheimer M R 2017 Energy Conversion Efficiency in Low- and Atmospheric-Pressure Plasma Polymerization Processes, Part II: HMDSO *Plasma Chem Plasma Process* **37** 257–271
- [116] Morent R, De Geyter N, Van Vlierberghe S, Dubruel P, Leys C and Schacht E 2009 *Surf. Coat. Technol.* **203** 1366
- [117] O'Hare L-A, Hynes A and Alexander M R 2007 *Surf. Interface Anal.* **39** 926
- [118] Deng X, Nikiforov A Y, De Geyter N, Morent R and Leys C 2013 *Plasma Processes Polym.* **10** 641
- [119] Barletta F, Leys C, Colombo V, Gherardi M, Britun N, Snyders R and Nikiforov A 2019 *Plasma Processes Polym.* **17** 1900174
- [120] Barletta F, Britun N, Leys C, Gherardi M, Snyders R and Nikiforov A 2021 *Plasma Processes Polym.* **18** 2000149
- [121] Collette S *et al* 2016 *Surf. Coat. Technol.* **289** 172
- [122] Fanelli F and Fracassi F 2017 *Surf. Coat. Technol.* **322** 174
- [123] Nisol B, Oldenhove G, Preyat N, Monteyne D, Moser M, Perez-Morga D and Reniers F 2014 *Surf. Coat. Technol.* **252** 126
- [124] Babayan S E, Jeong J Y, Tu V J, Park J, Selwyn G S and Hicks R F 1998 *Plasma Sources Sci. Technol.* **7** 286
- [125] Jeong J Y, Babayan S E, Tu V J, Park J, Henins I, Hicks R F and Selwyn G S 1999 *Plasma Sources Sci. Technol.* **7** 282
- [126] Penelon J, Motycka S, Babayan S and Yang X (SurfX Technologies LLC) 2006 *Low temperature, atmospheric pressure plasma generation and applications* USA 20060156983
- [127] Abou Rich S, Dufour T, Leroy P, Reniers F, Nittler L and Pireaux J-J 2015 *Plasma Processes Polym.* **12** 771
- [128] Ward L J, Schofield W C E, Badyal J P S, Goodwin A J and Merlin P J 2003 *Langmuir* **19** 2110
- [129] Ward L J, Schofield W C E, Badyal J P S, Goodwin A J and Merlin P J 2003 *Chem. Mater.* **15** 1466
- [130] Kusano Y 2014 *J. Adhes.* **90** 755
- [131] Temmerman E, Akishev Y, Trushkin N, Leys C and Verschuren J 2005 *J. Phys. D: Appl. Phys.* **38** 505
- [132] Starostin S A, Creatore M, Bouwstra J B, van de Sanden M C M and de Vries H W 2015 *Plasma Processes Polym.* **12** 545
- [133] Borcia C, Punga I L and Borcia G 2014 *Appl. Surf. Sci.* **317** 103
- [134] Carton O, Ben Salem D, Bhatt S, Pulpytel J and Arefi-Khonsari F 2012 *Plasma Processes Polym.* **9** 984
- [135] Balcon N, Aanesland A and Boswell R 2007 *Plasma Sources Sci. Technol.* **16** 217
- [136] Vida J 2019 Large area roll-to-roll atmospheric plasma treatment of nanocellulose transparent paper *Proc Nanocon* **2019** 8946
- [137] Zhang H, Li H, Fang M, Wang Z, Sang L, Yang L and Chen Q 2016 *Appl. Surf. Sci.* **388** 539
- [138] Liu Y, Elam F M, Zoethout E, Starostin S A, van de Sanden M C M and de Vries H W 2019 *J. Phys. D: Appl. Phys.* **52** 35201
- [139] Kment S, Kluson P, Zabova H, Churpita A, Chichina M, Cada M, Gregora I, Krysa J and Hubicka Z 2009 *Surf. Coat. Technol.* **204** 667
- [140] Hu J T, Liu X Y, Liu J H, Xiong Z L, Liu D W, Lu X P, Iza F and Kong M G 2012 *Phys. Plasmas* **19** 063505
- [141] Babaeva N Y and Kushner M J 2014 *Plasma Sources Sci. Technol.* **23** 015007
- [142] Kim J Y and Kim S-O 2011 *IEEE Trans. Plasma Sci.* **39** 2278
- [143] Sun P P, Chen H L, Park S-J, Eden J G, Liu D X and Kong M G 2015 *J. Phys. D: Appl. Phys.* **48** 425203
- [144] Bazinette R, Paillol J, Lelièvre J-F and Massines F 2016 *Plasma Processes Polym.* **13** 1015
- [145] Han M H, Noh J H, Lee T I, Choi J H, Park K W, Hwang H S, Song K M and Baik H K 2008 *Plasma Processes Polym.* **5** 861
- [146] Scopece P, Viaro A, Sulcis R, Kulyk I, Patelli A and Guglielmi M 2009 *Plasma Processes Polym.* **6** S705
- [147] Jofre-Reche J A, Pulpytel J, Fakhouri H, Arefi-Khonsari F and Martín-Martínez J M 2016 *Plasma Processes Polym.* **13** 459
- [148] Merten C, Regula C, Hartwig A, Ihde J and Wilken R 2013 *Plasma Processes Polym.* **10** 60
- [149] Belcourt A 1999 Biomaterials: Authorized repairers *Proc. 12th Int. Coll. on Plasma Processes* vol 28 (Antibes)
- [150] Siow K S, Kumar S and Griesser H J 2015 *Plasma Processes Polym.* **12** 8

- [151] Jung S-Y, Lim S-M, Albertorio F, Kim G, Gurau M C, Yang R D, Holden M A and Cremer P S 2003 *J. Am. Chem. Soc.* **125** 12782
- [152] Ratner B D 2007 *Biomaterials* **28** 5144
- [153] Szott L M, Irvin C A, Trollsas M, Hossainy S and Ratner B D 2016 *Biointerphases* **11** 029806
- [154] Williams D F 2008 *Biomaterials* **29** 2941
- [155] Barnthip N, Noh H, Leibner E and Vogler E A 2008 *Biomaterials* **29** 3062
- [156] Vogler E A 1998 *Adv. Colloid Interface Sci.* **74** 69
- [157] Alexander M R and Williams P 2017 *Biointerphases* **12** 02C201
- [158] Sardella E, Gristina R, Senesi G S, d'Agostino R and Favia P 2004 *Plasma Processes Polym.* **1** 63
- [159] Castner D G and Ratner B D 2002 *Surf. Sci.* **500** 28
- [160] France R M, Short R D, Dawson R A and MacNeil S 1998 *J. Mater. Chem.* **8** 37
- [161] Sciaratta V, Sohn K, Burger-Kentischer A, Brunner H and Oehr C 2006 *Plasma Processes Polym.* **3** 532
- [162] Sperling C, Maitz M F, Grasso S, Werner C and Kanse S M 2017 *ACS Appl. Mater. Interfaces* **9** 40107
- [163] Siow K S, Britcher L, Kumar S and Griesser H J 2006 *Plasma Processes Polym.* **3** 392
- [164] Oehr C, Hegemann D, Müller M, Vohrer U and Storr M 2005 (p309-17): RF-plasma treatment on the inside of small *Functional Devices for Biomedical Application by in Plasma Processes and Polymers* (Weinheim: Wiley) ch 23
- [165] Jacobs T, Morent R, De Geyter N, Desmet T, Dubruel P and Leys C 2011 *IEEE Trans. Plasma Sci.* **39** 2792
- [166] Kim W, Gwon Y, Kim Y-K, Park S, Kang S-J, Park H-K, Kim M-S and Kim J 2021 *npj Regen. Med.* **6** 52
- [167] Popelka A *et al* 2020 *Surf. Coat. Technol.* **400** 126216