



HAL
open science

How does a clear layer modify the appearance of a halftone print?

Fanny Dailliez, Anne Blayo, Lionel Chagas, Thierry Fournel, Mathieu Hébert

► **To cite this version:**

Fanny Dailliez, Anne Blayo, Lionel Chagas, Thierry Fournel, Mathieu Hébert. How does a clear layer modify the appearance of a halftone print?. Computational Color Imaging Workshop, Jun 2022, Online, France. hal-03818505

HAL Id: hal-03818505

<https://hal.science/hal-03818505>

Submitted on 18 Oct 2022

HAL is a multi-disciplinary open access archive for the deposit and dissemination of scientific research documents, whether they are published or not. The documents may come from teaching and research institutions in France or abroad, or from public or private research centers.

L'archive ouverte pluridisciplinaire **HAL**, est destinée au dépôt et à la diffusion de documents scientifiques de niveau recherche, publiés ou non, émanant des établissements d'enseignement et de recherche français ou étrangers, des laboratoires publics ou privés.

HOW DOES A CLEAR LAYER MODIFY THE APPEARANCE OF A HALFTONE PRINT?

Fanny Dailliez

fanny.dailliez@lgp2.grenoble-inp.fr

10/06/22

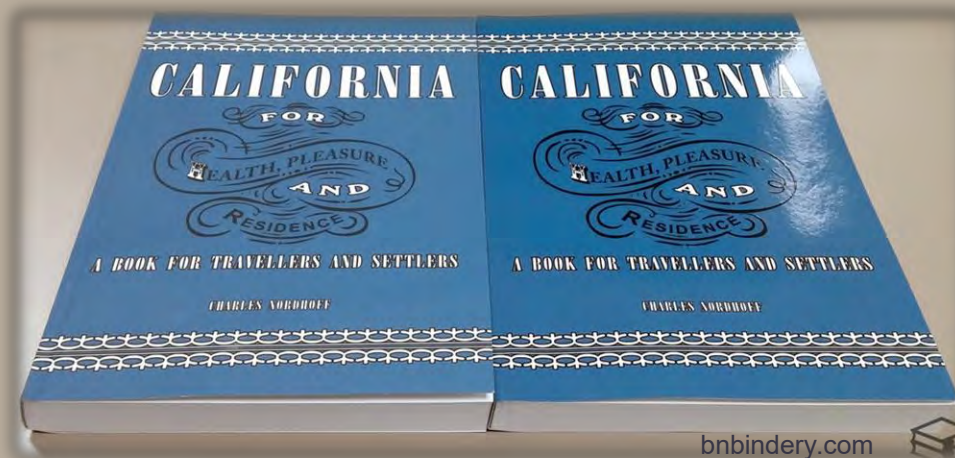

Supervised by:

Anne Blayo, Lionel Chagas,
Thierry Fournel, Mathieu Hébert



Halftoning

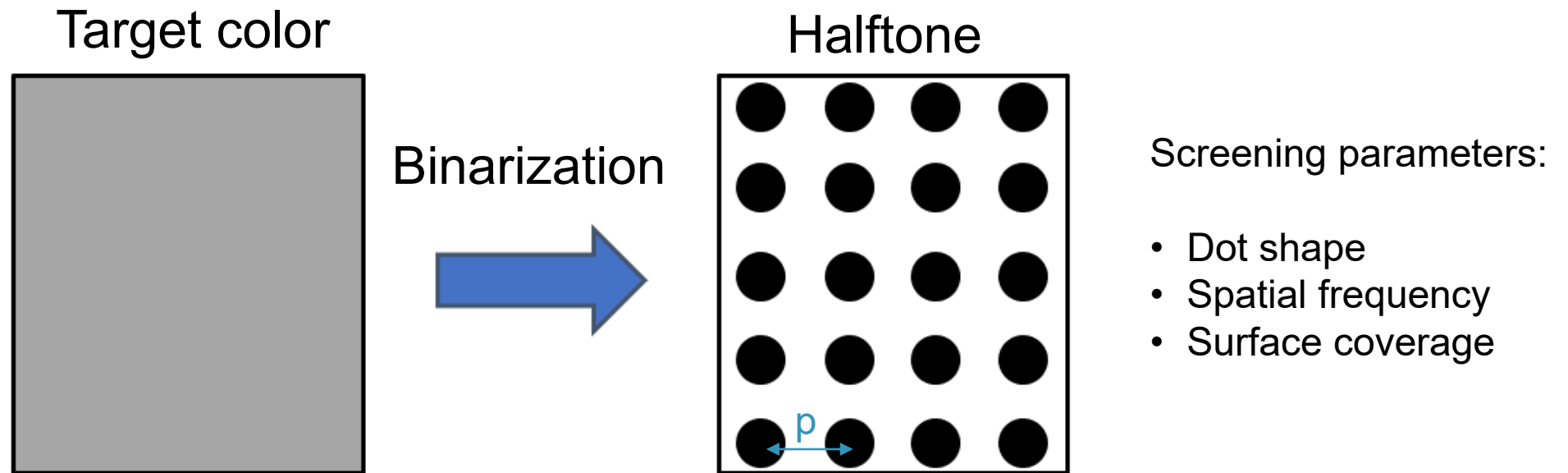



Dot halftone

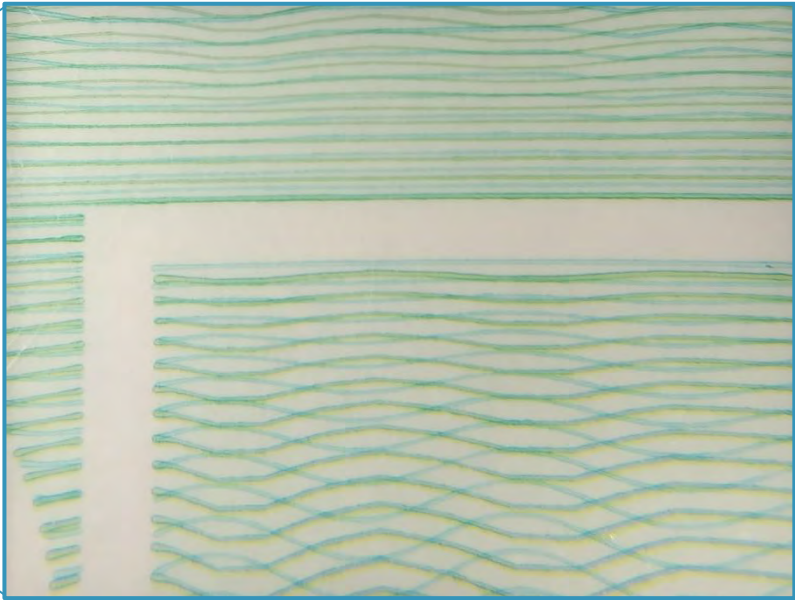

Line halftone

Printing

Halftone

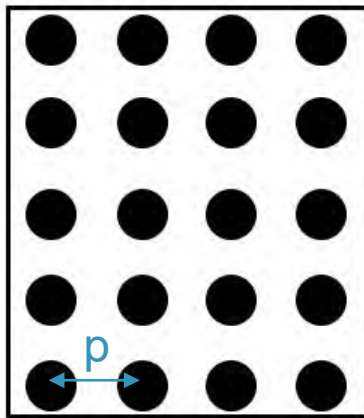

Printing

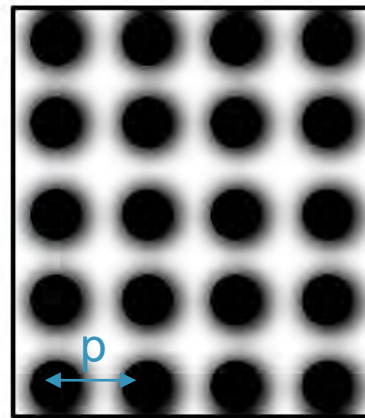

- Dot gain
- Mechanical
 - Optical

Diffusion of light
inside the substrate

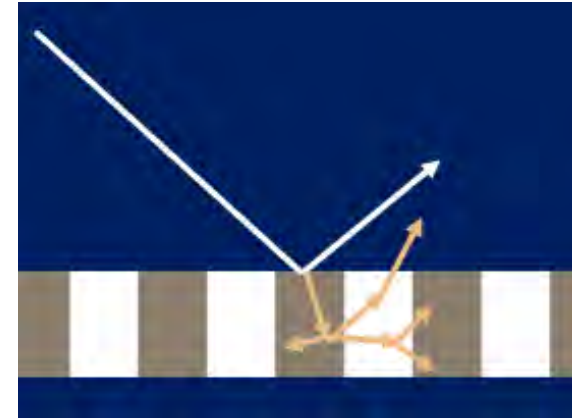

Convolution with the paper
Point Spread Function (PSF)

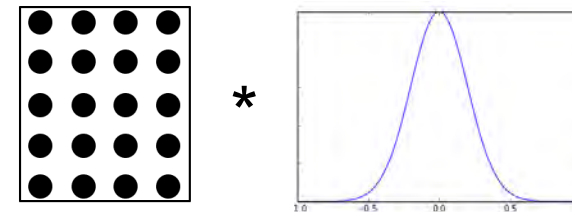

Dot gain

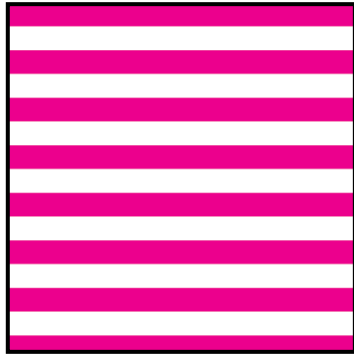

Halftone

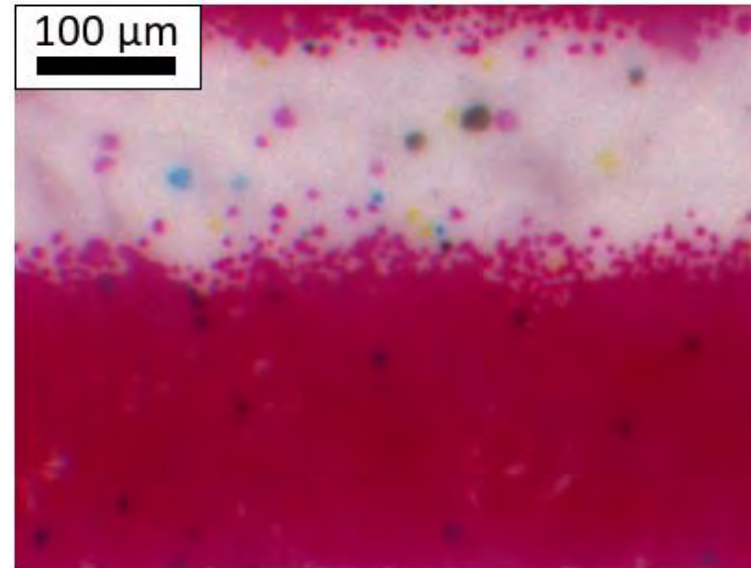

Microscope image of a halftone period

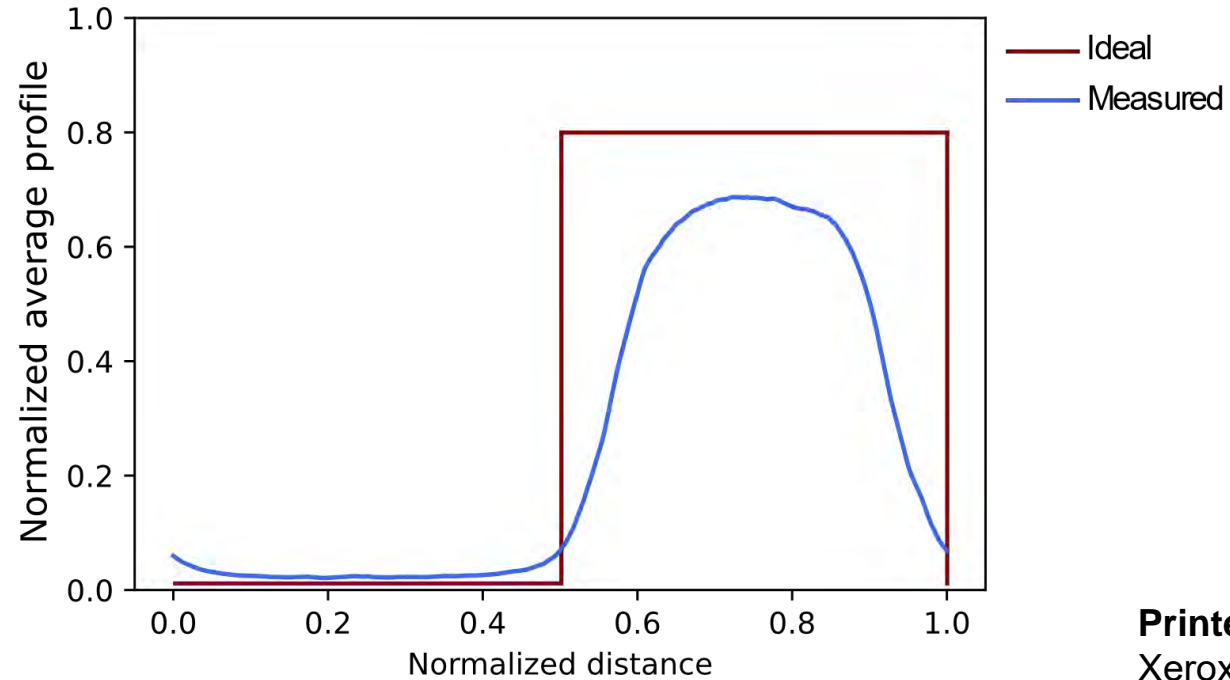

Printer
Xerox Versant 180 (Electrophotography)

Coating

Varnish



i.pinimg.com

Lamination

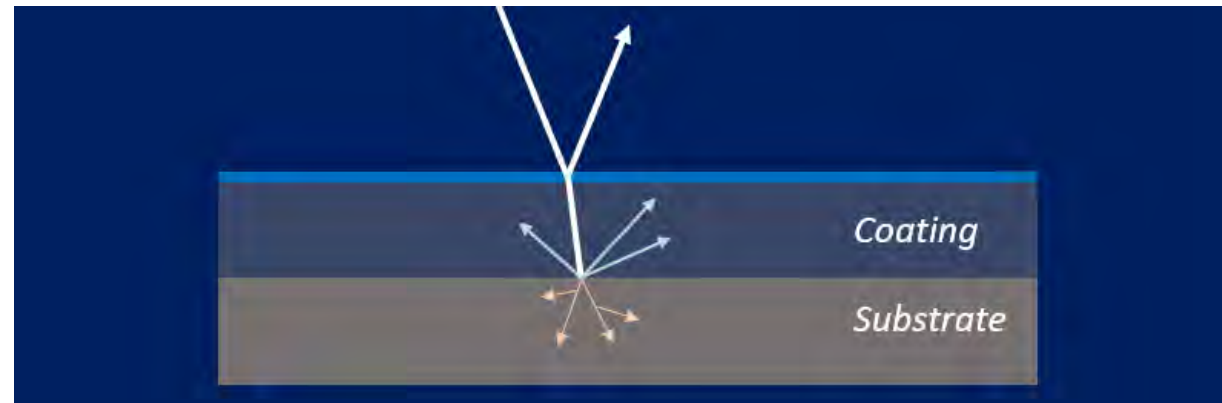

Optical effects of coating

Surface topology



Octane Seating

Bronzing effect

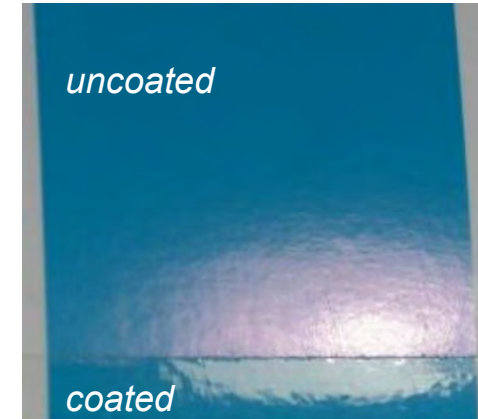

M. Hébert

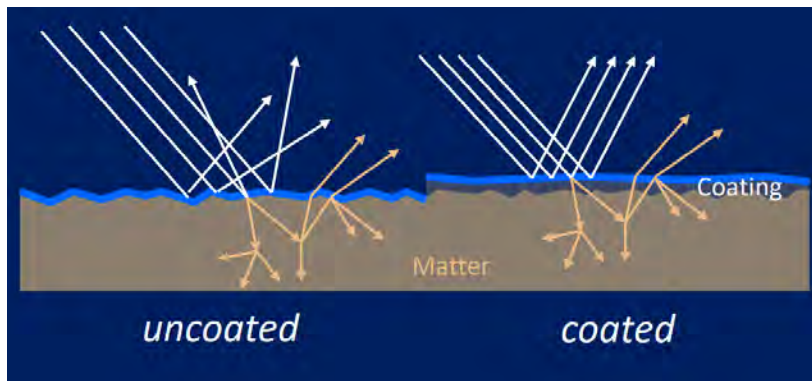

M. Hébert

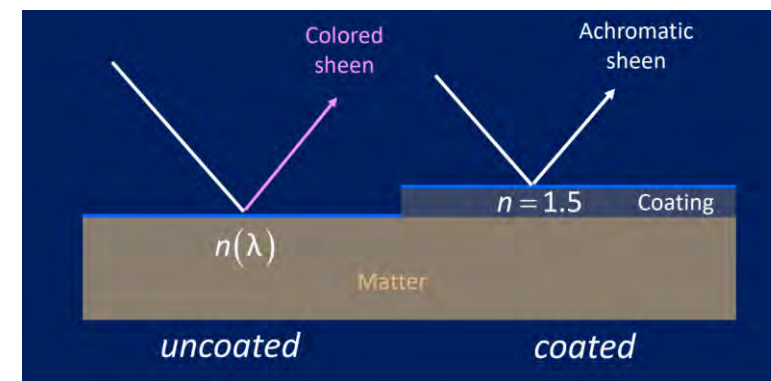

M. Hébert

Lionel Simonot *et al.*, 'Halo and subsurface scattering in the transparent coating on top of a diffusing material', *Journal of the Optical Society of America A*, vol. 35, no. 7, pp. 1192–12, Jun. 2018

Mathieu Hébert *et al.*, 'Exploring the bronzing effect at the surface of ink layers', presented at the Proceedings of SPIE - The International Society for Optical Engineering, 2015.

Optical effects of coating

Halo effect

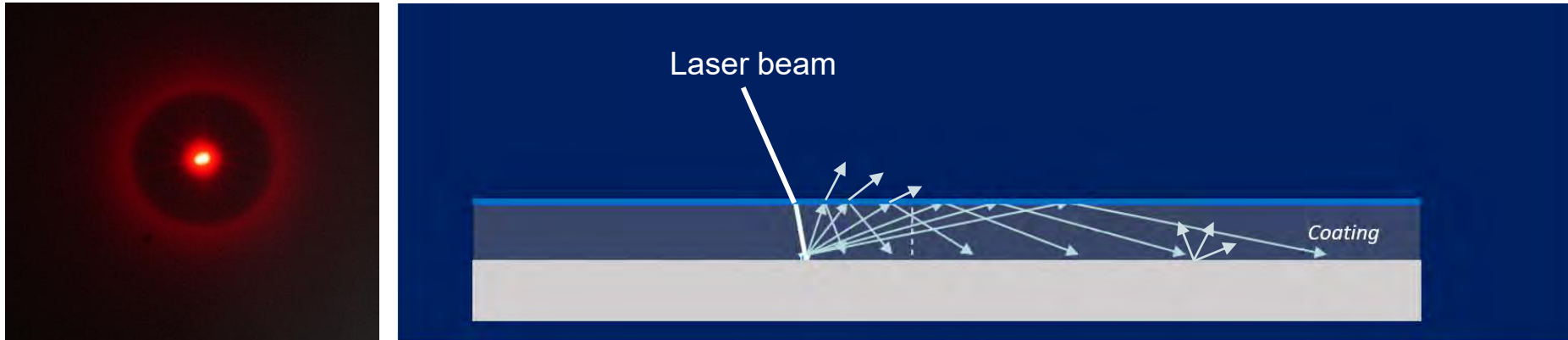

Lionel Simonot *et al.*, 'Halo and subsurface scattering in the transparent coating on top of a diffusing material', *Journal of the Optical Society of America A*, vol. 35, no. 7, pp. 1192–12, Jun. 2018

Mathieu Hébert *et al.*, 'Why a clear coating modifies halftone color prints', presented at the Material Appearance, IS&T Electronic Imaging Symposium, Jan. 2021.

Optical effects of coating

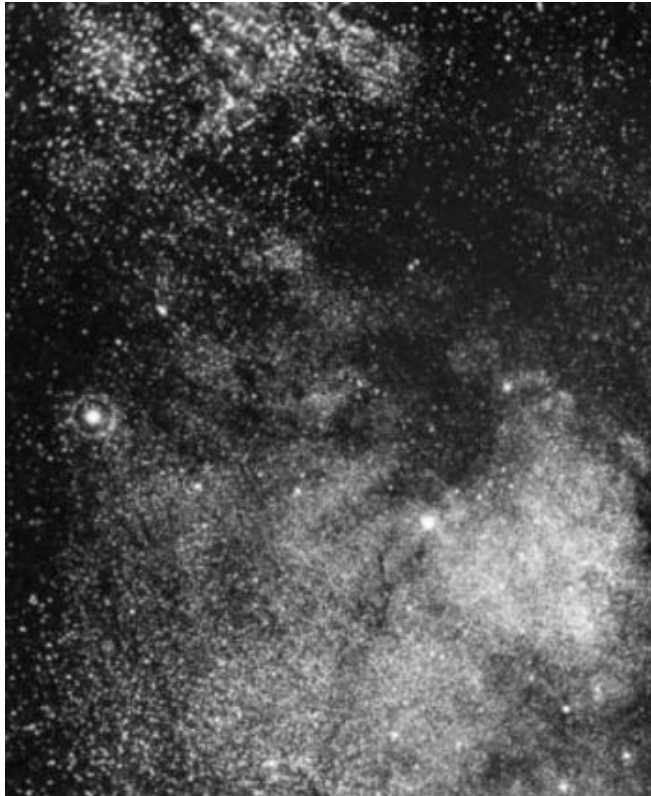

*STAR CLOUD IN THE MILKY WAY.
Near Messier II. 1892, June 29.
Taken By Prof. E.E. Barnard at the Lick Observatory,
Exposure 3 hours 25 minutes
Collotype*

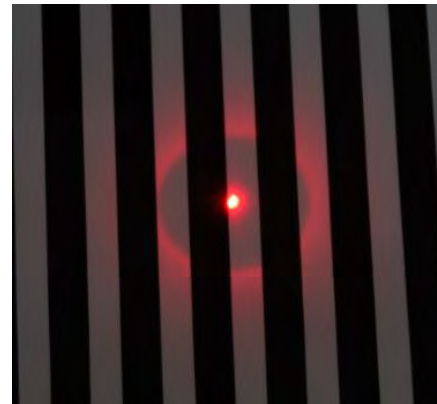

Darkening effect
on halftones

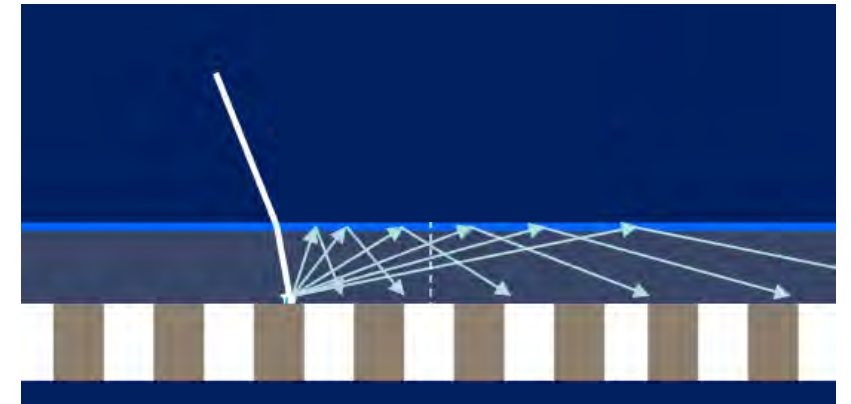

Halo effect inside photographs explained by A. Cornu

Cornu, A. Sur le halo des lames épaisses, ou halo photographique, et les moyens de le faire disparaître. J. Phys. Theor. Appl. 9, 270–277 (1890).

Optical effects of coating



Microscope images of halftones
with a lamination layer

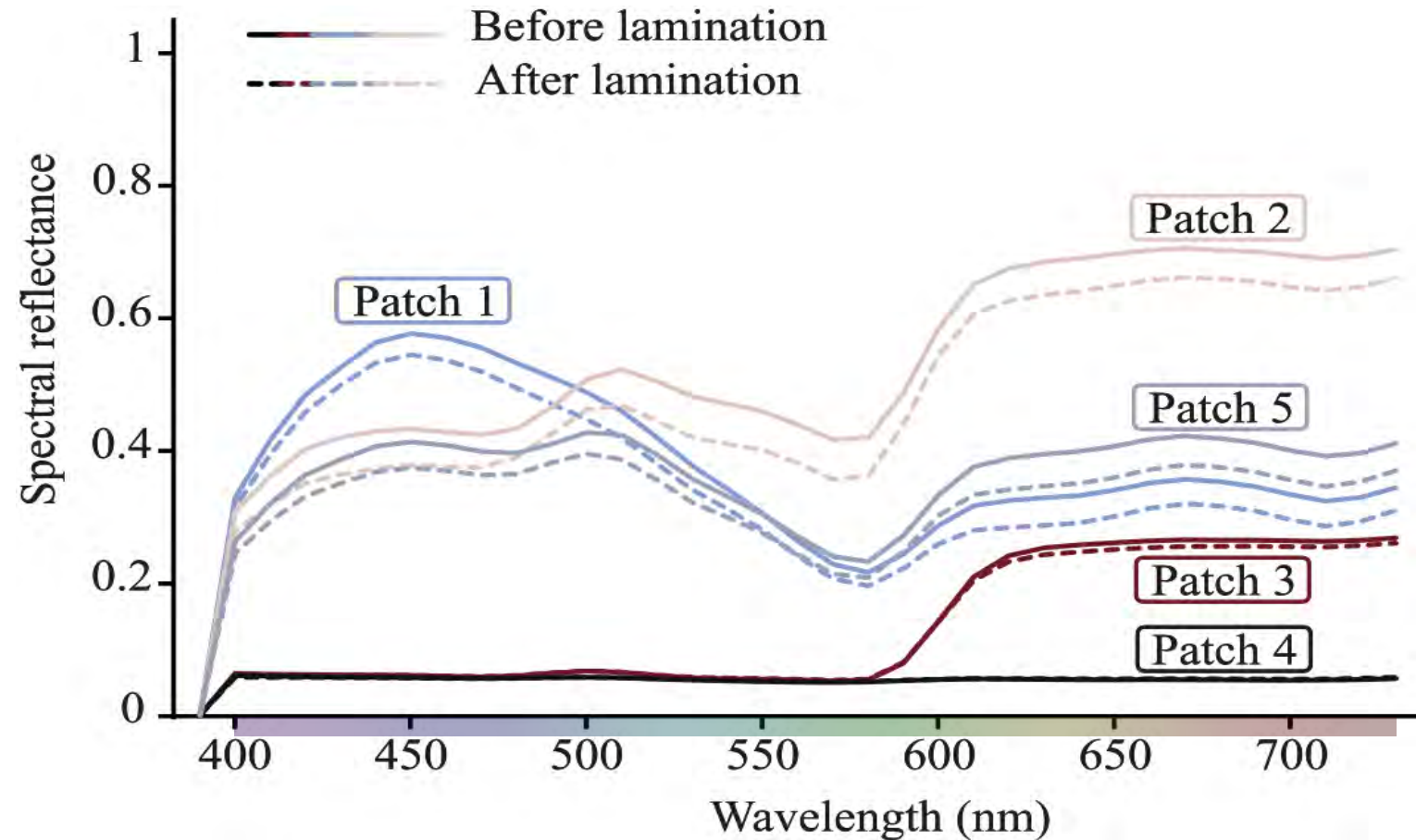

Material

Spectrophotometer: CM 2600d from Konica Minolta, 8 mm aperture, with geometry $di:8^\circ$, with a UV filter avoiding fluorescence

Optical effects of coating

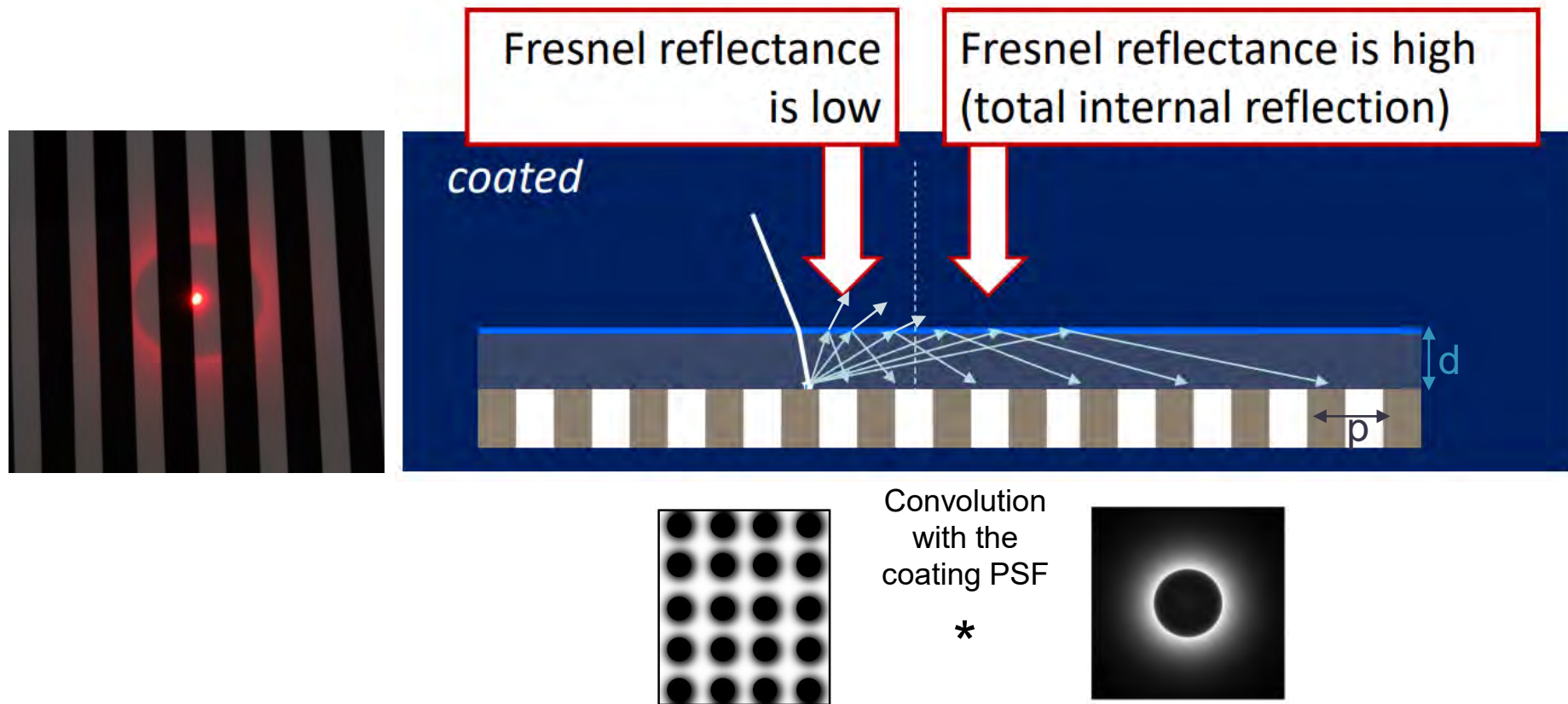

Lionel Simonot *et al.*, 'Halo and subsurface scattering in the transparent coating on top of a diffusing material', *Journal of the Optical Society of America A*, vol. 35, no. 7, pp. 1192–12, Jun. 2018

Mathieu Hébert *et al.*, 'Why a clear coating modifies halftone color prints', presented at the Material Appearance, IS&T Electronic Imaging Symposium, Jan. 2021.

Dailliez, F., Hébert, M., Blayo, A., Chagas, L. & Fournel, T. Impact of a Transparent Coating on the Reflectance of a Line Halftone Pattern. *Coatings* 11, 1465 (2021).

Optical effects of coating

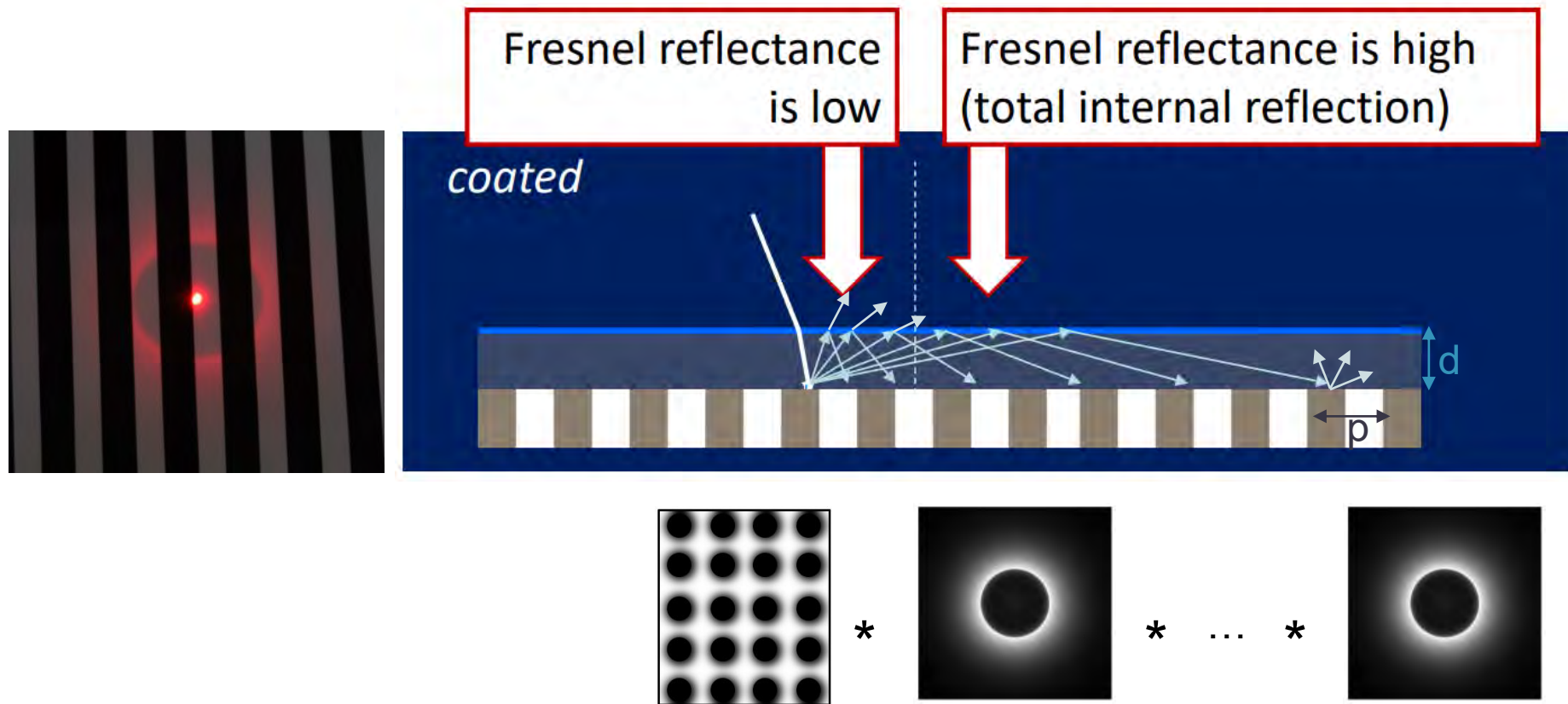

Lionel Simonot *et al.*, 'Halo and subsurface scattering in the transparent coating on top of a diffusing material', *Journal of the Optical Society of America A*, vol. 35, no. 7, pp. 1192–12, Jun. 2018

Mathieu Hébert *et al.*, 'Why a clear coating modifies halftone color prints', presented at the Material Appearance, IS&T Electronic Imaging Symposium, Jan. 2021.

Daillez, F., Hébert, M., Blayo, A., Chagas, L. & Fournel, T. Impact of a Transparent Coating on the Reflectance of a Line Halftone Pattern. *Coatings* 11, 1465 (2021).

Optical model

Reflectance model **input** parameters:

- Material physical characteristics: n , d , γ , $R_0(\lambda)$, $R_{NC}(x, y, \lambda)$
- Measurement geometry: r_s , r_i , T_{in} , T_{out}

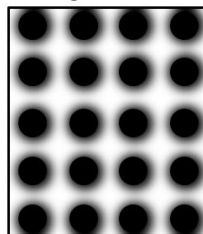
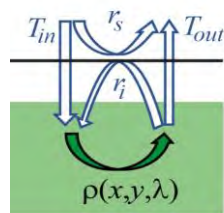

$$\rho(x, y) = \frac{R_{NC}(x, y) - r_s}{T_{in}T_{out} + r_i[R_{NC}(x, y, \lambda) - r_s]}$$

$$t(x, y) = \sqrt{\frac{\rho(x, y)}{\rho_0}}$$

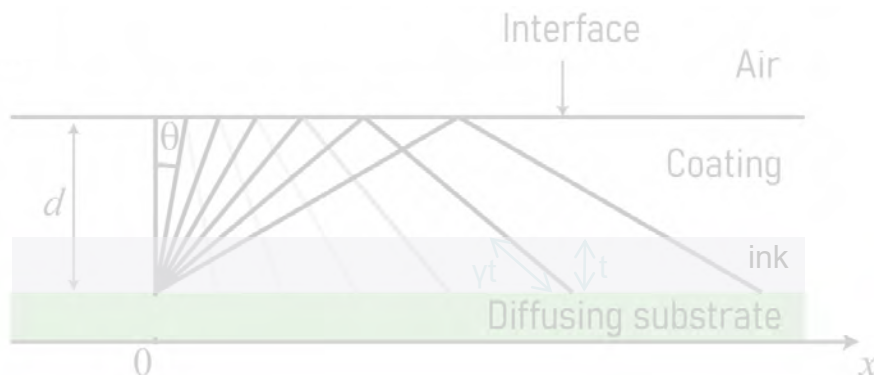

$$M_1(x, y) = T_{in}t^2(x, y)\rho_0$$

$$h(x, y) = \frac{4d^2R_{n_1, n_0} \left(\arctan \left[\frac{\sqrt{x^2 + y^2}}{(2d)} \right] \right)}{\pi(x^2 + y^2 + 4d^2)^2}$$



$$M_k(x, y) = \rho_0 t^{\gamma+1}(x, y) [t^{\gamma-1} M_{k-1} * h](x, y)$$

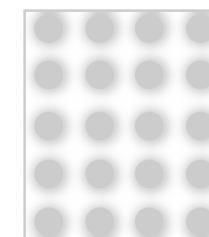

*

Output: reflectance of the coated halftone:

$$R(x, y, \lambda) = r_s + T_{out} \sum_{k=1}^{10} M_k(x, y, \lambda)$$

Experiment

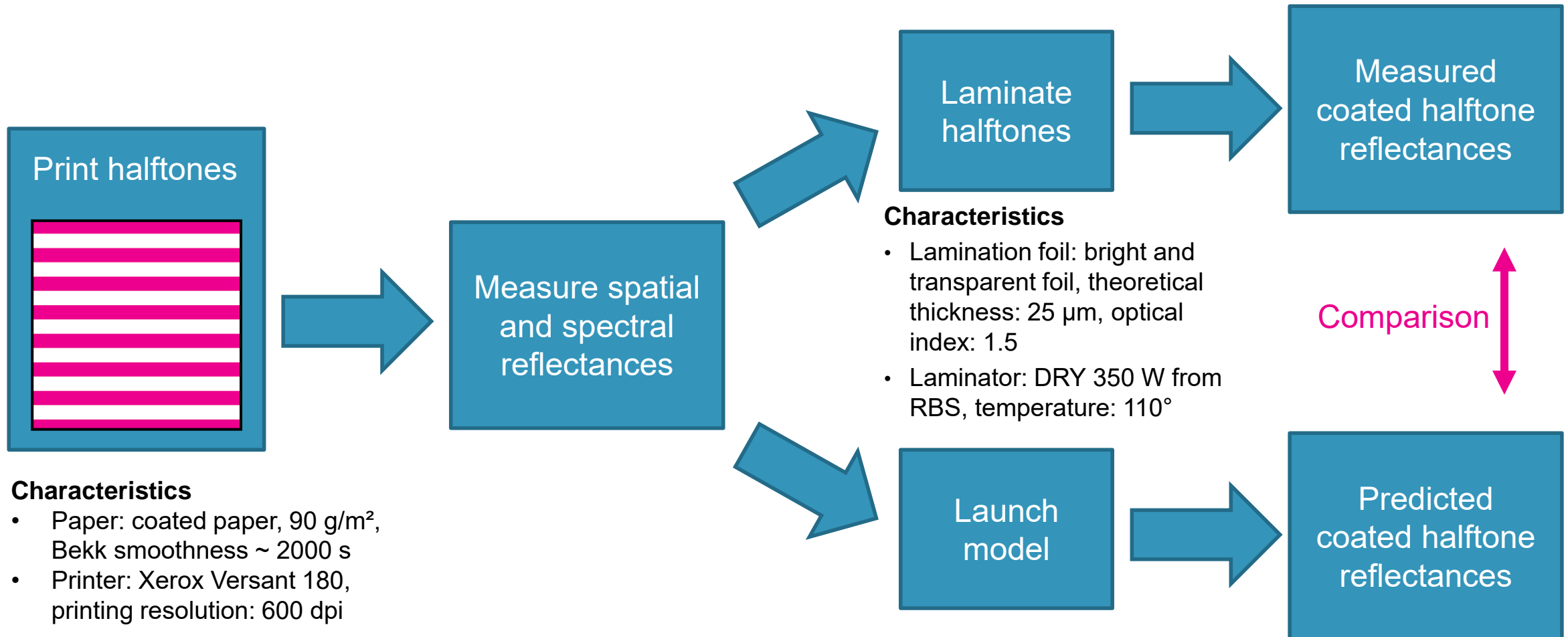

Multispectral microscope

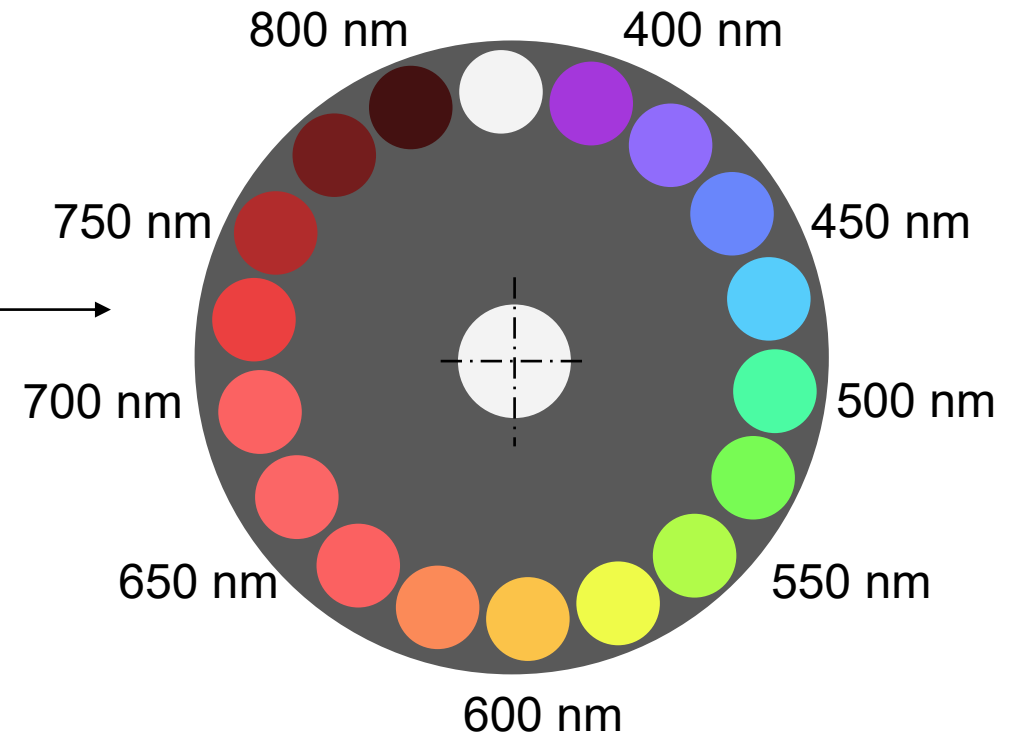
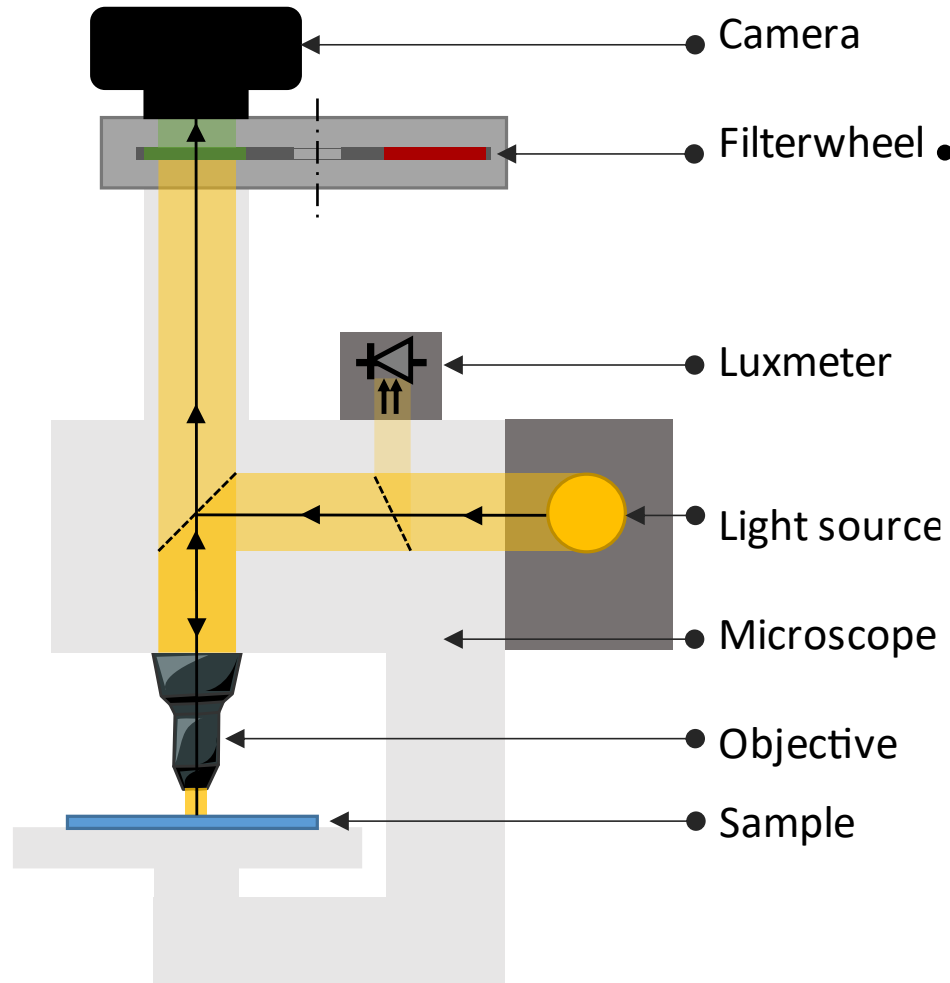

Material

- Microscope: Zeiss Axio Imager M1m, polarizer and analyzer in crossed configuration, objective: EC Epiplan Neofluar 5×/0.13 HD DIC, light source: Zeiss HAL 100 tungsten-halogen lamp set at 3200 K,
- Photodiode: Yocto-Light-V3 LIGHTMK3 from Yoctopuce,
- Camera: Canon 1200D with a RGGB CMOS sensor. ISO at 800. Sensor: 14-bit encoding, resolution of 3516 × 5344 pixels,
- Filterwheel: 17 filters (Hard Coated OD 4.0 25nm Bandpass Filters from Edmund Optics), 13 are used in the range [400, 700 nm].

Multispectral microscope

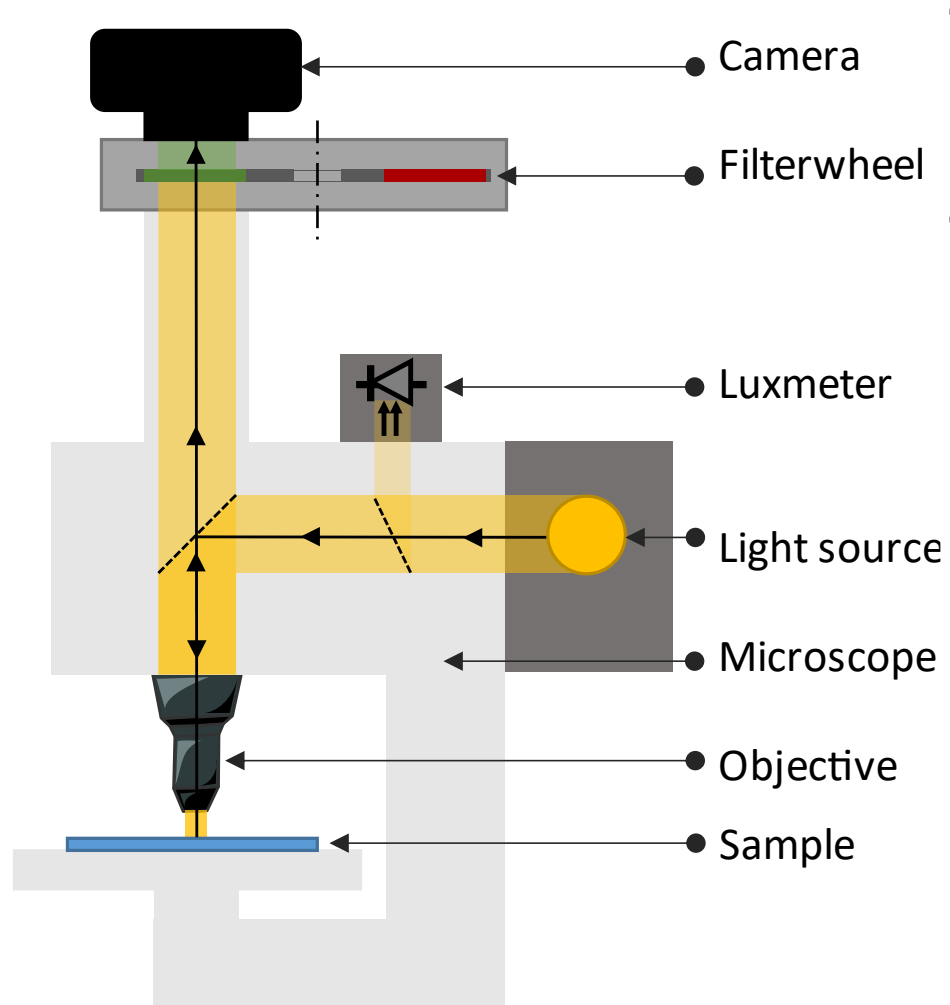

Multispectral microscope

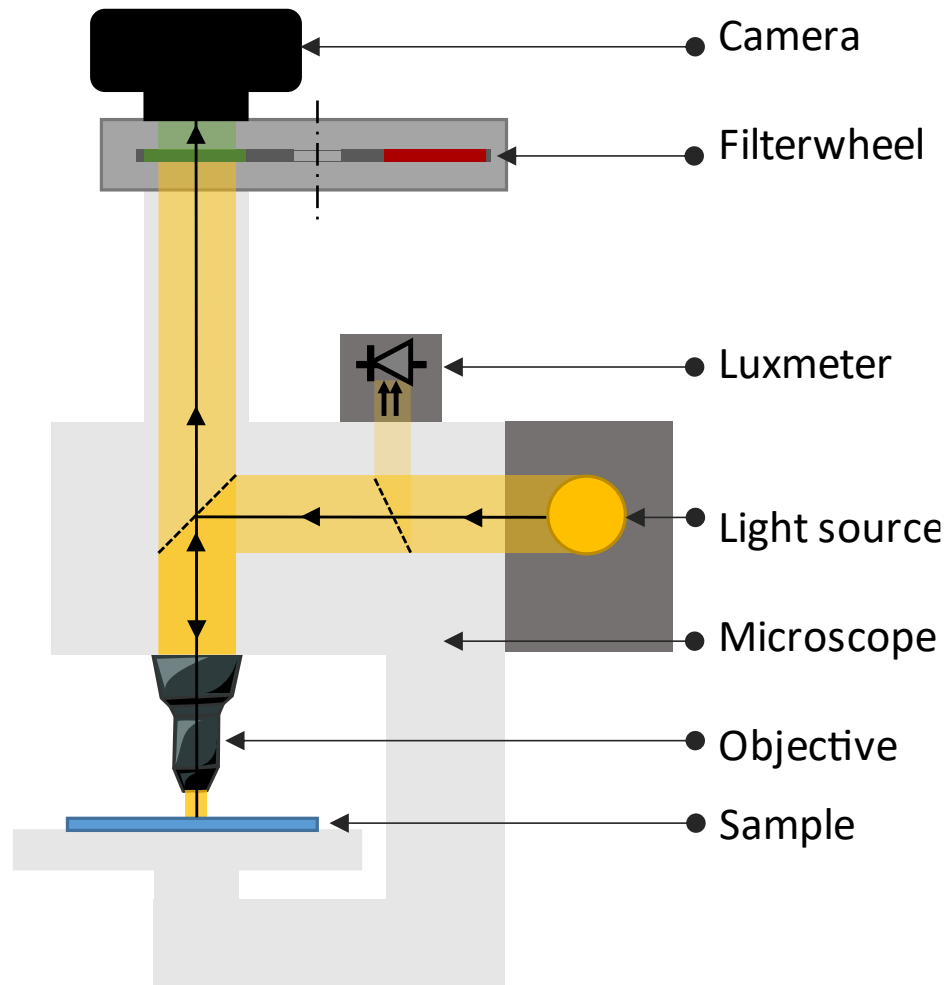

White calibration

$$R(x, y, \lambda) = \frac{V - V_k}{TeQ}$$

where,

- $R(x, y, \lambda)$ is the reflectance of the sample at pixel (x,y) for wavelength λ of the filter,
- V is the pixel value,
- T is the exposure time,
- e is the irradiance of the light source,
- V_k is a constant equal to the pixel value in the dark,
- Q is the calibration value measured on a white calibration patch

Agreement microscale/macroscale

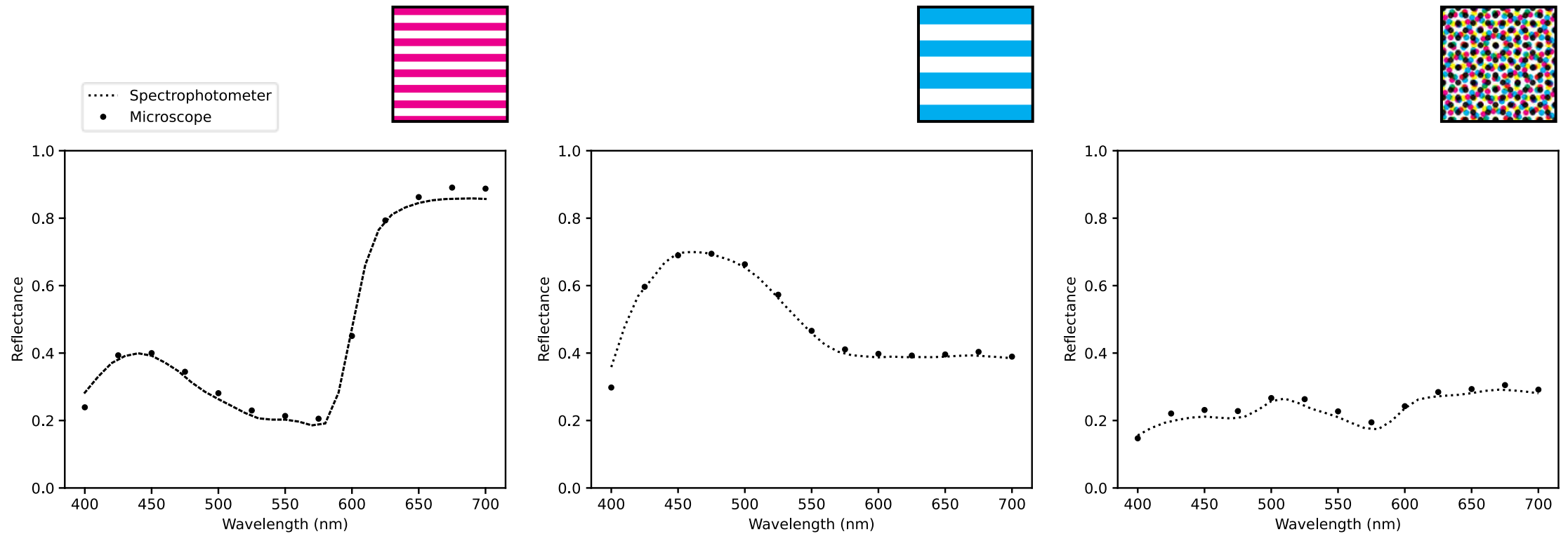

Good agreement over 23 samples

Material

Spectrophotometer: CM 2600d from Konica Minolta, 8 mm aperture, with geometry di:8°, with a UV filter avoiding fluorescence

Results

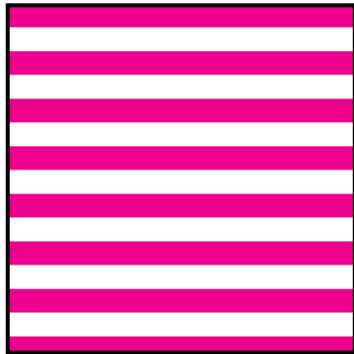

Magenta
halftone

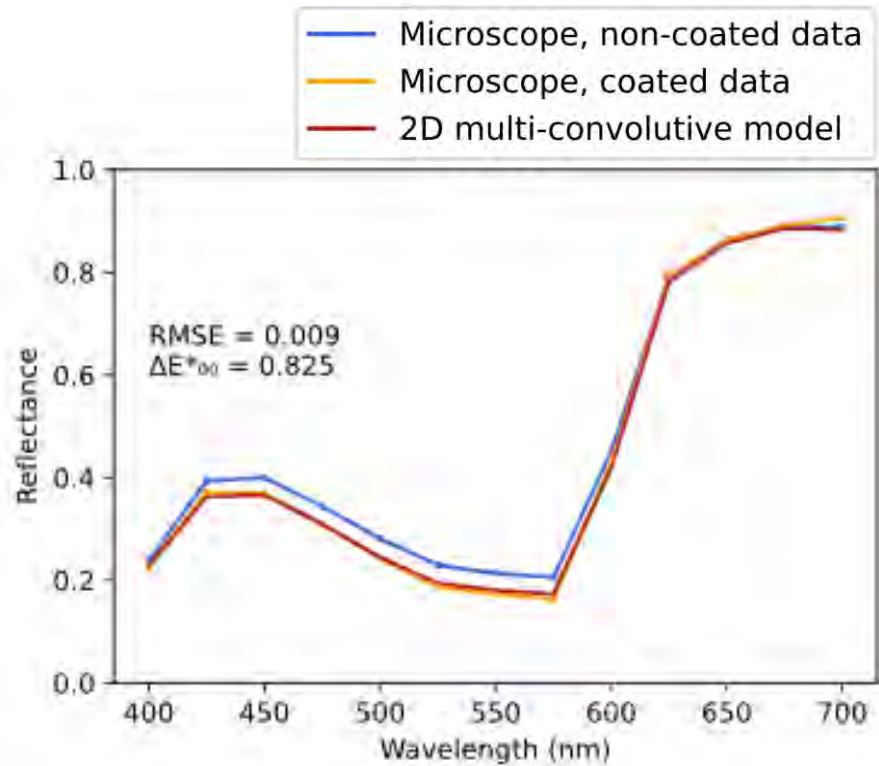

Non-coated halftone
measurement

Coated halftone
prediction

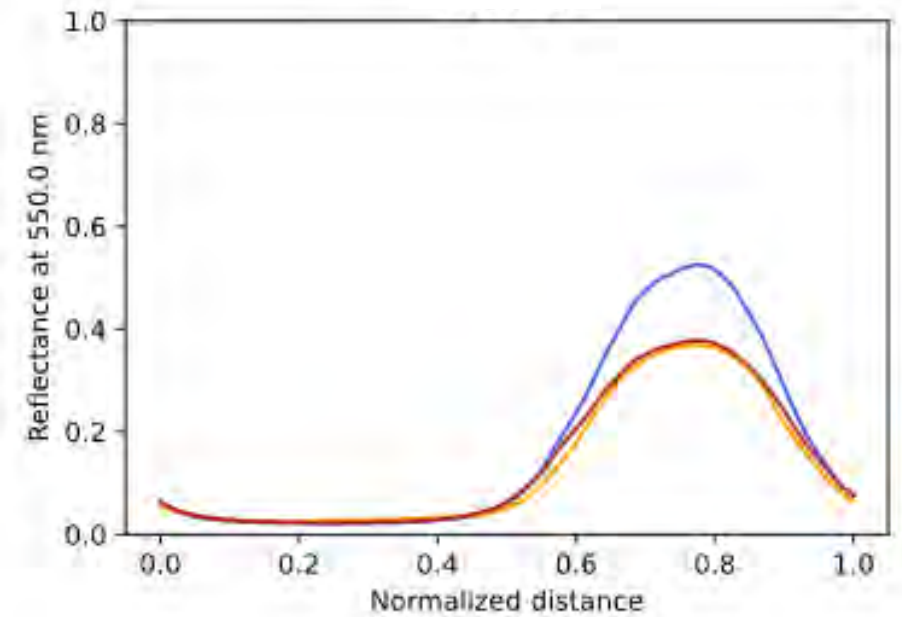

Coated halftone
measurement

sRGB
images

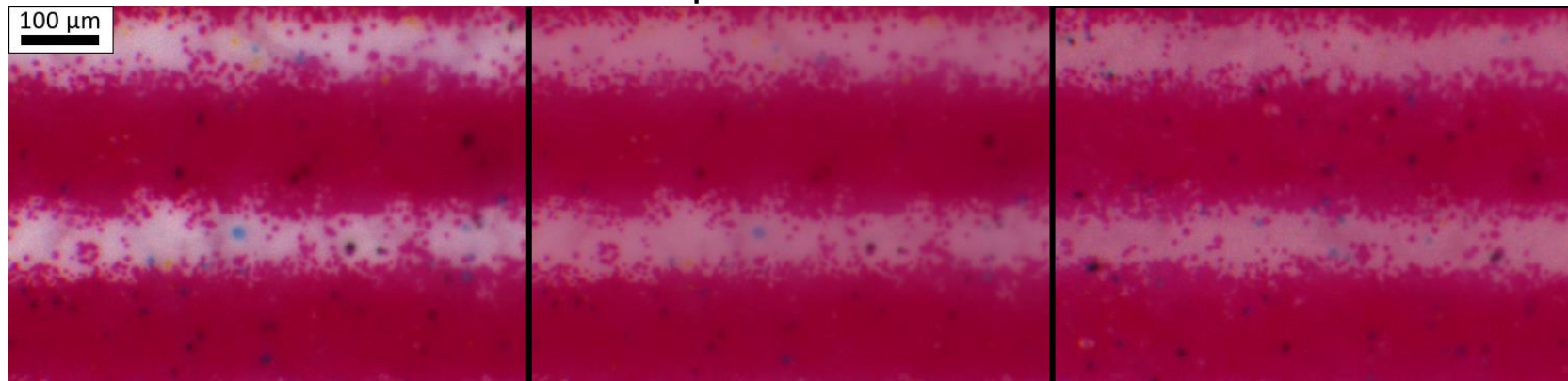

Results

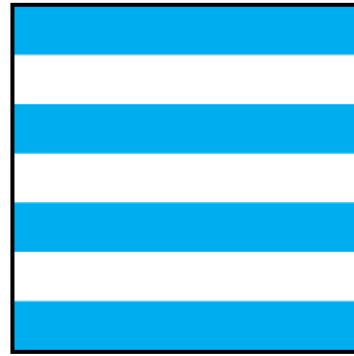

Cyan halftone

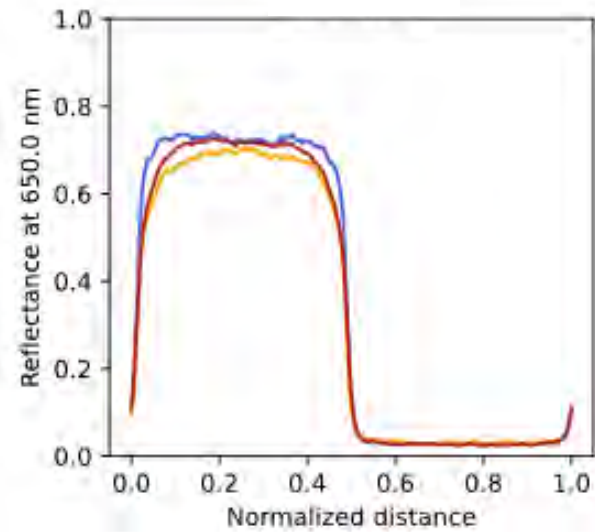
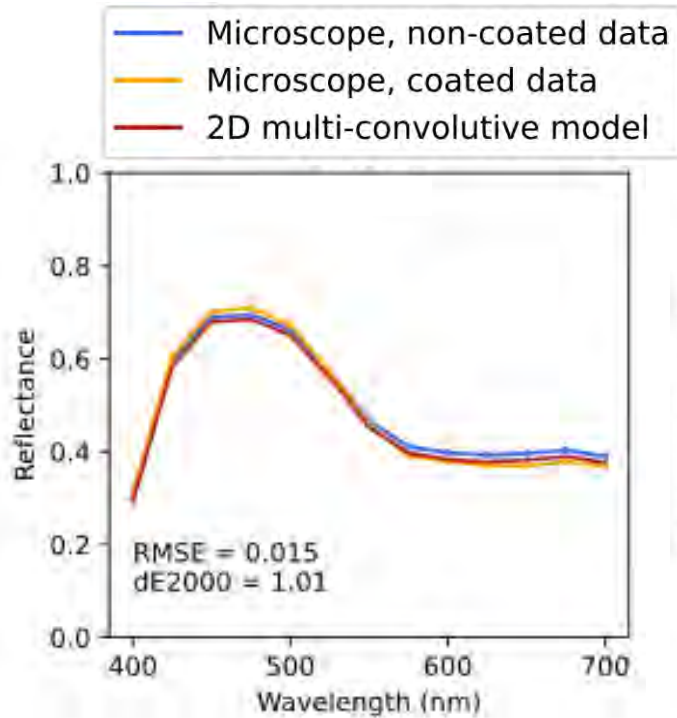

Non-coated
halftone
measurement

Coated
halftone
prediction

Coated
halftone
measurement

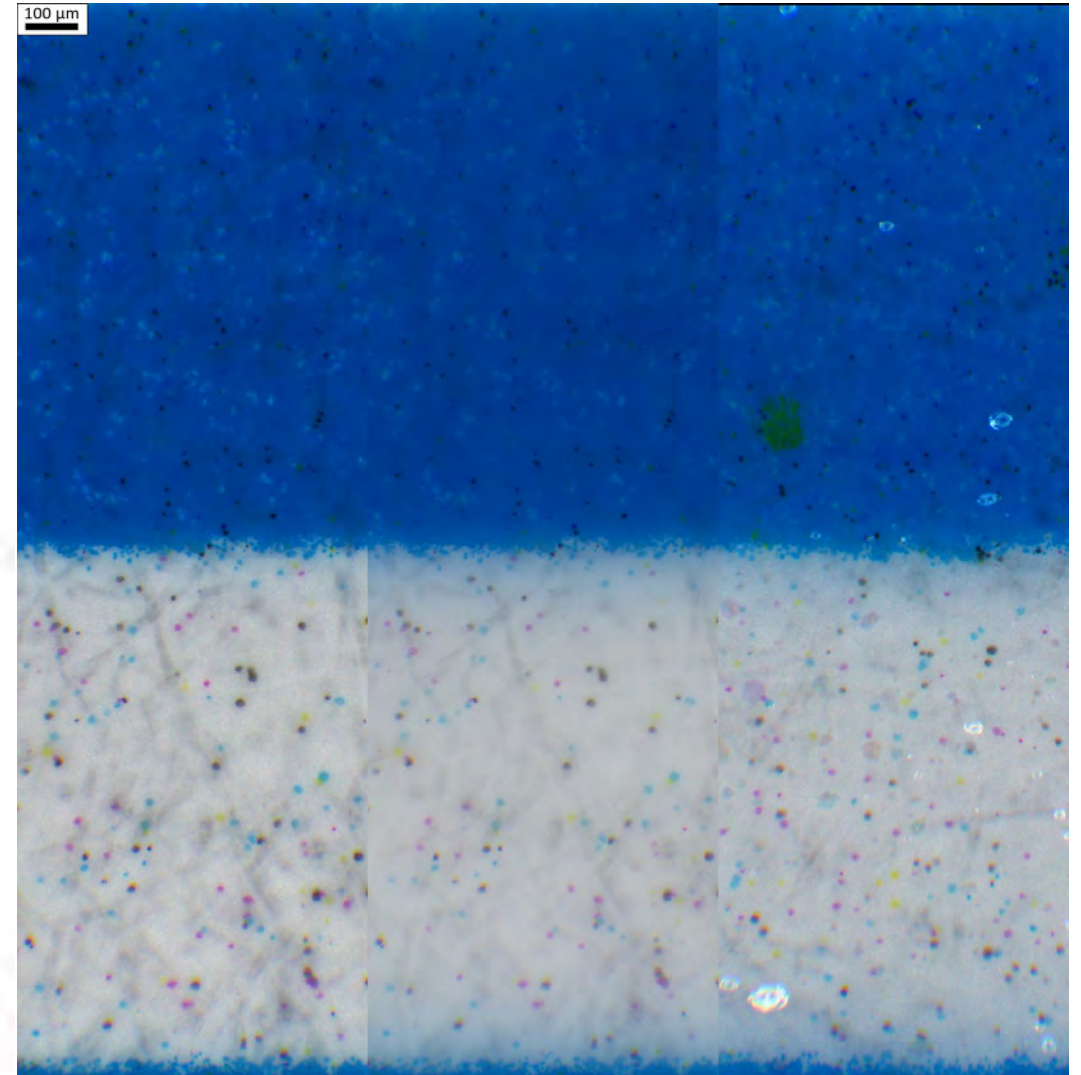

Results

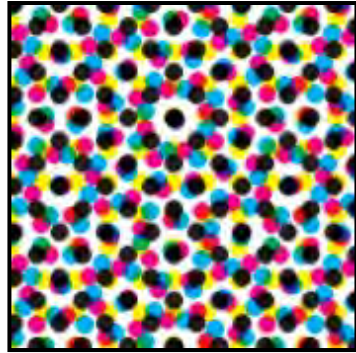

Ordinary multi-colored halftone

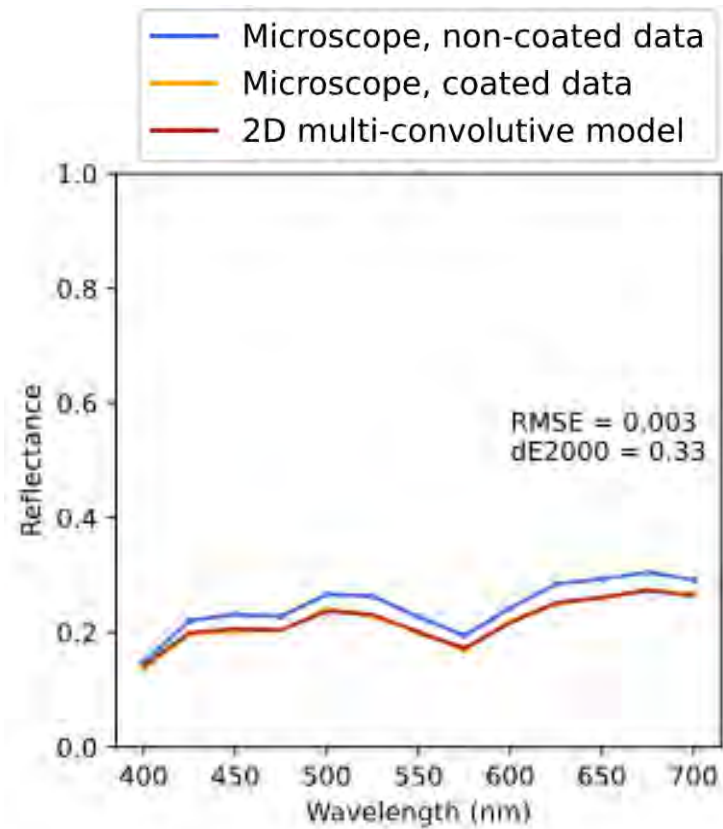

Non-coated
halftone
measurement

Coated halftone
prediction

Coated halftone
measurement

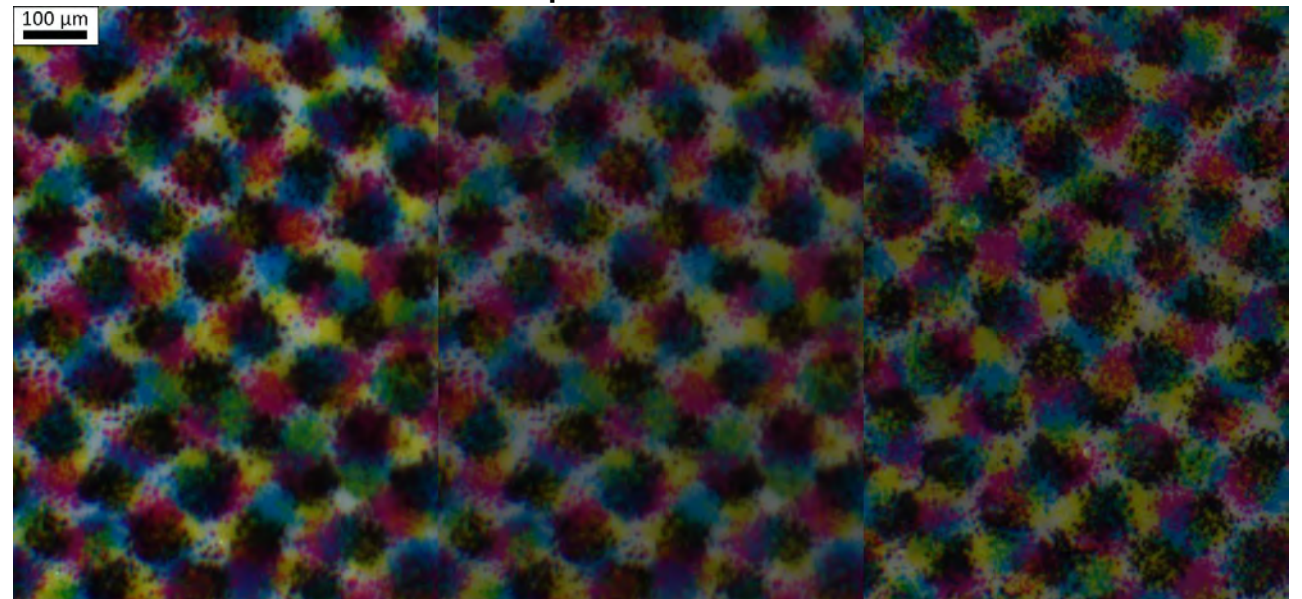

Conclusion

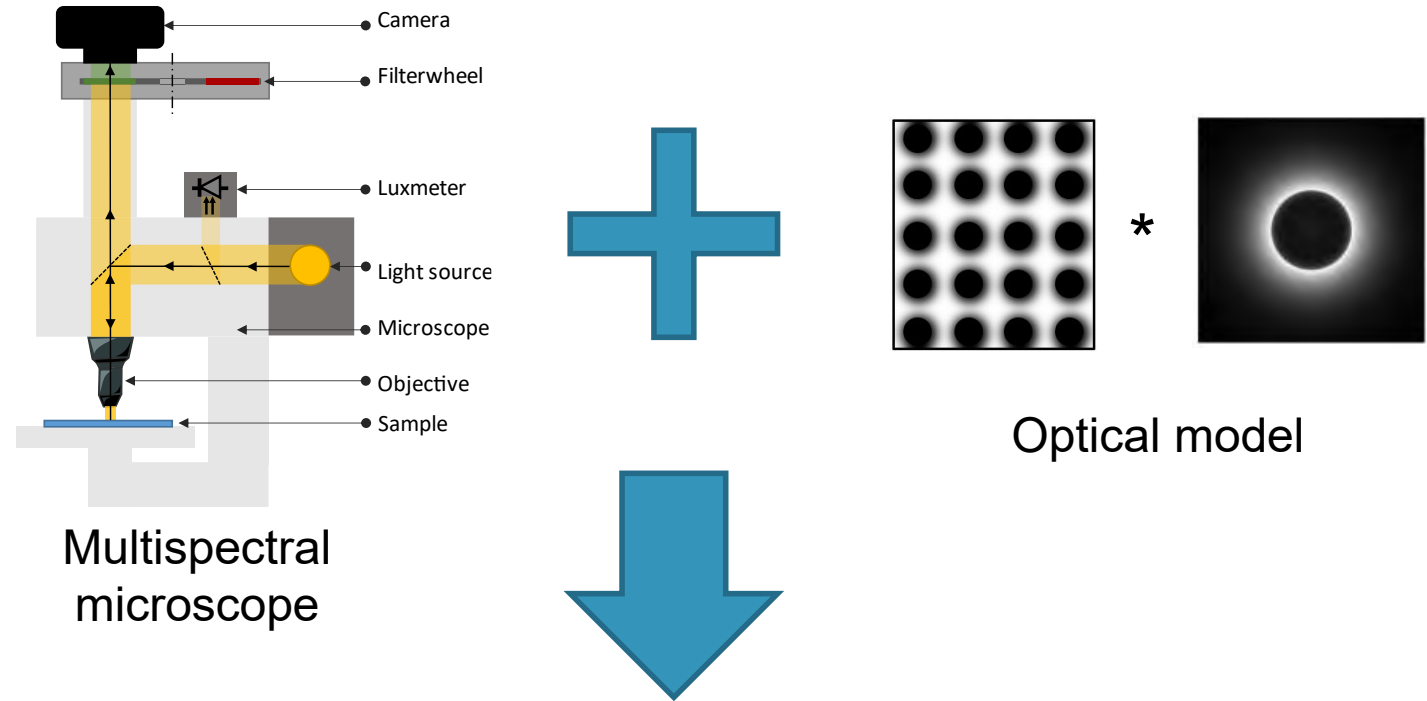

Optical model

Prediction of **any** coated halftone appearance
at the **micro** and **macro** scales

Perspectives

- Color management for printing industry
- Contactless measurements of the thicknesses of thin transparent layers
- Security printing: printed and coated watermarks



Thank you for your attention



fanny.dailliez@lgp2.grenoble-inp.fr