



**HAL**  
open science

## Performances of NF and RO applied in combined system and separately for the treatment and recycling of biologically pretreated real textile wastewater

Ameni Gharsallaha, Nouha Tahria, Joelle Duplay, Raja Ben Amar

### ► To cite this version:

Ameni Gharsallaha, Nouha Tahria, Joelle Duplay, Raja Ben Amar. Performances of NF and RO applied in combined system and separately for the treatment and recycling of biologically pretreated real textile wastewater. *Journal of Phase Change Materials*, 2022, 2 (1), pp.24-47. 10.6084/jpcm.v2i1.19 . hal-03797508

**HAL Id: hal-03797508**

**<https://hal.science/hal-03797508v1>**

Submitted on 4 Oct 2022

**HAL** is a multi-disciplinary open access archive for the deposit and dissemination of scientific research documents, whether they are published or not. The documents may come from teaching and research institutions in France or abroad, or from public or private research centers.

L'archive ouverte pluridisciplinaire **HAL**, est destinée au dépôt et à la diffusion de documents scientifiques de niveau recherche, publiés ou non, émanant des établissements d'enseignement et de recherche français ou étrangers, des laboratoires publics ou privés.

# Performances of NF and RO applied in combined system and separately for the treatment and recycling of biologically pretreated real textile wastewater

Ameni Gharsallaha<sup>1</sup>, Nouha Tahria<sup>1</sup>, Joelle Duplay<sup>2</sup> and Raja Ben Amara<sup>1</sup>

<sup>1</sup> Research unit 'Advanced technologies for Environment and Smart Cities', Faculty of Science of Sfax, University of Sfax, Tunisia.

<sup>2</sup> Laboratoire d'hydrologie et de géochimie de Strasbourg, France.

Corresponding author: [raja.rekik@fss.rnu.tn](mailto:raja.rekik@fss.rnu.tn)

<https://orcid.org/0000-0002-2923-7066>

## Abstract

**In this study, integrated membrane systems represented by Ultrafiltration/Nanofiltration (UF/NF), Ultrafiltration/Reverse Osmosis (UF/RO) and direct Nanofiltration (D/NF) and Reverse Osmosis (D/RO) applied separately at a semi pilot scale were investigated for the treatment and reuse of biologically pretreated real textile wastewater. The separation performances taking into account the operating pressure (TMP) and flux recovery ratio (FRR) was extensively investigated. Long-term performance of the membrane systems separation was analyzed as well.**

**The results showed that the NF and RO applied directly can achieve high separation performances with good permeate quality. The fouling study shows that the FRR at the optimal pressures of 8 bar for NF and 10 bar for RO was higher than 90%.**

**When using UF as pre-treatment under optimal TMP of 3bar, the application of the hybrid UF/NF and UF/RO systems allows a decrease of the TMP from 8 bar to 6 bar for NF and from 14 bar to 12 bar for RO. An enhancement of the permeate flux respectively of 36% and 29% has been also achieved. In addition, both hybrid processes showed good antifouling characteristics with a permeate flux maintained at almost constant value since the first minutes of filtration of 44 L/h.m<sup>2</sup> at 6bar for UF/NF and 42 L/h.m<sup>2</sup> at 10 bar for UF/RO, which is in compliance with an industrial application.**

**Taking into account the water process quality usually used in the company in terms of chemical oxygen demand (COD), chloride and Total Dissolved Solids**

## 1. Introduction

The textile industry is known as one of the most important industrial sectors of the world. Its main drawbacks are related to water consumption and wastewater production. Estimates indicate the consumption of over 100 L of water per kilogram of textile product and, an average of 90% of the water input in textile operations needs at end-of pipe treatment [1,2]. Wastewater generated from textile industries is notorious for its recalcitrant characteristics including complex structures such as wetting agents, dyes, fixing agents, softeners and many other additives [3]. Its quality depends on the processing steps, dye nature, auxiliaries and textile materials. Generally, it is usually rich in color, chemical oxygen demand (COD), complex chemicals, inorganic salts, with a pH value different of neutrality and high temperature [4-6].

Therefore, it is obligatory to find an effective method for textile wastewater treatment before discharge into environment. The treatment of textile wastewater becomes also, a requirement for the promotion of the internationally sector and must therefore be considered at the same level as the production. In addition, the ecological label required today has led companies to make a great effort to find solutions that guarantee autonomy in water and energy. So, water scarcity, ecological label and environmental impact makes industrial wastewater reuse necessary.

The most common treatment methods of the raw textile wastewater are based on biological or physical-chemical processes with previous screening and pH adjusting steps. Biological activated sludge [7], anaerobic treatment [8], membrane bioreactor [9] offer high efficiency in chemical oxygen demand (COD) reduction, but do not completely

eliminate the color and the salinity of the wastewater due to the biodegradable difficulty of the dyes presented in the effluents. Physicochemical and chemical processes such as coagulation- flocculation [10], adsorption [11], membrane filtration [12], advanced oxidation [13], etc. which reduce dissolved, suspended, colloidal, and non-settleable materials from wastewater but can not eliminate the color. The major drawbacks including In addition, these systems present difficulties in management of the produced sludge as well as low COD and salinity removal efficiency [14,15] and need in general the addition of chemicals. Due to highly polluted nature of textile wastewaters, water reuse may only be possible after the use of several treatment steps which depend on the concentration of pollutants and the reuse criteria. These last techniques are not able to remove the high level of salts present in wastewater, hindering the water reuse in the production process [16].

With more and more restrictive effluent quality required by water authorities as well as the increasing water shortage, membrane separation is the most promising technology that offer a realistic solution to meet the increasingly strict discharge limits and to reuse the textile wastewater by providing treated water with good quality. Membrane systems are found to be advantageous over traditional separation methods due to their lower energy consumption and environmental impact.

Nanofiltration (NF) and Reverse Osmosis (RO) are able to retain not only relatively small organic molecules but also ions from a dye wastewater [12-17]. Lot of studies have been carried out on the NF treatment of textile wastewater and some of them have already dealt with the recycling of the treated water and the recovery of some salts and chemicals [15,18-22].

Tak-Hyun et al.[23] studied the combined process of NF and RO membranes not only to improve the rejection efficiencies and flux recovery, but also to recycle the permeate back into the dyeing process. Van der Bruggen et al. [24,25] studied the performances of NF treatment of textile wastewater, they concluded that the ideal membrane process for the treatment of dye wastewater was a compromise between dye retention and salt retention. Qin et al. [26] treated dyeing wastewater for reuse by using three types of NF membranes designed as NE-70, Desal-5 and TS-40. It was found that all the three studied NF membranes performed with high efficiency of 99% for dye removal. Zhonglong Yin et al. [27] were also tested three commercial polyamide thin-film composite RO membranes (BW30-4040, CPA2-4040, and RE-4040-FEN) for treating textile secondary effluent. For all membranes, the extent of irreversible fouling was higher than reversible fouling for three membranes, and was mainly responsible for the flux drop.

It is well known that one main obstacle to wide applications of NF/RO processes is the fouling on the membrane surface after a continuous long-term operation. This problem can be solved by a proper pretreatment technique which plays a key factor in the efficiency of NF/RO process [28,29]. MF and UF processes appear to be more attractive as a pretreatment prior to NF/RO in place of conventional clarification or filtration [30-36]. This pretreatment process allow controlling the flux drop and hence maintain an efficient membrane separation process. Gozalez-Zafrilla et al. [37] assessed the application of three different NF membranes (NF90, NF 200, and NF270) to treat raw or ultrafiltration (UF)-pretreated textile effluent. It was concluded that NF90 is the most suitable membrane, since it could meet the specifications for water reuse in the textile

effluent. Also, the application of UF as a pre-treatment is important for eliminating colloids and macromolecules responsible for most membrane fouling.

Many researchers have studied the recovery and reuse of textile wastewaters extensively. Membrane techniques hold great promise, as they have the potential to remove dyes or to concentrate the dyestuffs and auxiliaries and produce purified water. N. Ben Amar and al. [38] studied the possibility of reusing the textile wastewater using NF and RO membrane. They concluded that if the aim is to reuse the treated wastewater in compliance with both factory requirements on water quality and Tunisian water reuse standards, NF using 11 bar as operating pressure is the suitable method of treatment. M.Liu et al. [3] compared the performances of the treatment textile effluent by NF and RO for water reuse. They found that the application of NF and RO processes could effectively remove the COD, BOD, salinity and color of the biologically treated textile effluent. The treated water of good quality could be recycled back to the processes such as washing and dyeing, offering then economic benefits by reducing the water consumption and wastewater treatment cost. G.Masmoudi et al. [39] used the combined MF/NF system for the treatment and reuse of dyeing effluents. They concluded that the use of MF as pretreatment played an important role in removing suspended solids and turbidity. On the other hand, its effectiveness in the removal of COD was about 30%. The MF/NF combination produced about 54 % of the feed effluent as permeate.

In this study, a wastewater management strategy was adopted to investigate the different wastewater reuse opportunities for the dyeing process or for other applications within the textile industry. In line with this strategy, NF and RO were used as a post-treatment of biologically treated wastewater not only for the reuse, but also to reduce the amount of water consumed and wastewater generated. For this, alternative treatment processes, in semi-pilot scale, has been studied.

## **2. Materials and Methods**

### **2.1. Wastewater origin**

The effluent of the current study was supplied from full-scale wastewater treatment plant of a Tunisian textile company (SITEX) located in Ksar Hellal, (Tunisia) which specialized in the dyeing and washing processes.

The produced wastewater was collected in a homogenization tank to be treated firstly through a grit chamber to remove all the large solids and then neutralized by liquid CO<sub>2</sub> to reach a pH value between 7.5 and 8.5, which is convenient for biological treatment. Two oxidation ditches with aeration (2–3mg O<sub>2</sub>/L) were used for aerobic biodegradation of pollutants. The plant was designed to deal with a daily flow rate of wastewater of 1800 m<sup>3</sup>. The quality of this biologically treated water is not quietly in compliance with the Tunisian standard of wastewater discharge to public sewers (Table.1).

**Table.1.** Characteristics of the raw and biologically treated wastewater of the local textile Industry

<b>Parameter</b>	<b>Raw effluent</b>	<b>Biologically treated effluent</b>	<b>Rejection limits</b>
<b>pH</b>	11±1	8.5±0.5	7<pH<8
<b>Conductivity (ms/cm)</b>	26±5	7 ±1	-
<b>Color (mg/L(pt-cd)</b>	350±100	150±50	100
<b>SS (mg/L)</b>	509±60	40 ±8	400
<b>COD (mg/L)</b>	3020±400	170 ±50	1000
<b>TDS (mg/L)</b>	14030±2000	4000 ±800	-
<b>Cl<sup>-</sup> (mg/L)</b>	960±100	1000±200	700
<b>Na<sup>+</sup> (mg/L)</b>	1980±120	2000±200	100
<b>SO<sub>4</sub><sup>2-</sup>(mg/L)</b>	960±100	1150±100	500
<b>NO<sub>3</sub><sup>-</sup>(mg/L)</b>	-	12±4	90

## 2.2 Experimental strategy

Different treatment strategies were adopted to investigate the diverse wastewater reuse opportunities in the dyeing process or for other applications within the textile industry. Fig.1 presents the different treatment systems studied in a semi-pilot scale. To manage wastewaters as well as to minimize water consumption including reuse, different configurations were identified.

At first, NF and RO were used directly, as post-treatment of the biologically treated wastewater. Then, UF has been used prior to NF or RO to remove most of the suspended and undissolved substances to limit the effect on membrane fouling and to protect the membrane from damage (Fig. 2).

Table 2 shows the membrane characteristics used in this study. The textile effluent was pumped directly from the storage bath to the feed tank using a volumetric pump and it was maintained at a fixed temperature (25-30°C) by a circulating thermal bath. The feed effluent can undergo either an ultrafiltration pretreatment on the 150 KDa membranes in order to eliminate the causes of fouling NF and RO membranes.

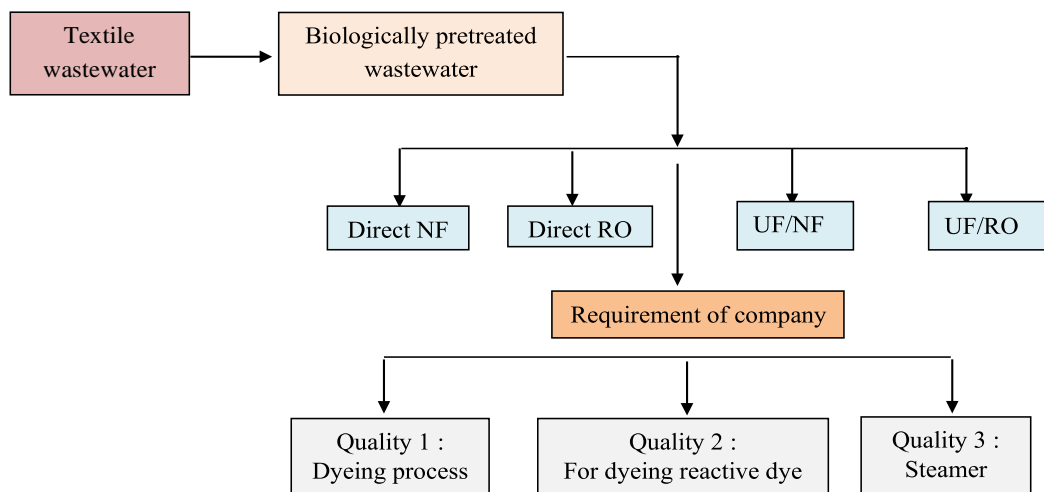

**Fig.1.** Different alternatives for textile waste water treatment in semi-pilotscale

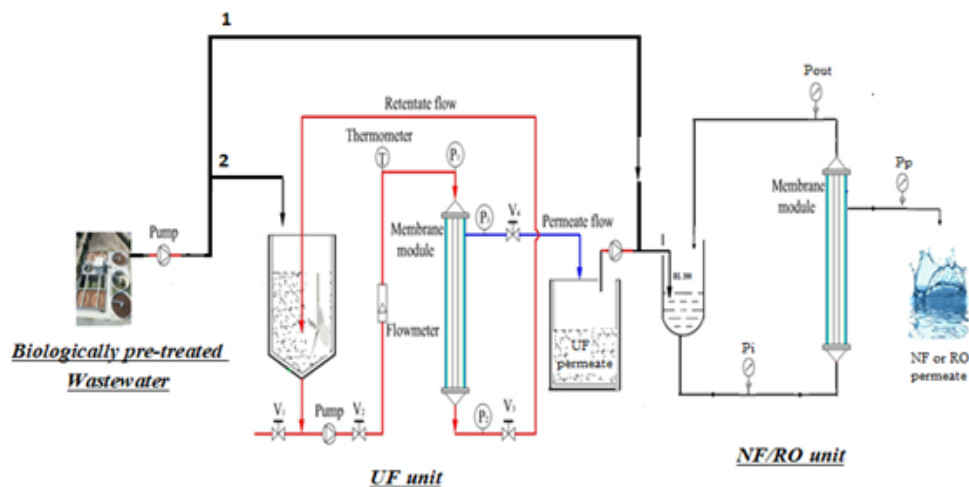

**Fig.2.** Schematic illustration of the membrane post-treatment unit

**Table.2.** Mains characteristics of the used membranes

Parameters	UF membrane	NF membrane NF 270	RO membrane BW30
Material	TiO <sub>2</sub>	Polyamide	Polyamide
Membrane area	0.155m <sup>2</sup>	2.5m <sup>2</sup>	2.5m <sup>2</sup>
MWCO	150 kDa	200-400 Da	>100 Da
Manufacturer		Dow Filmtec USA	Dow Filmtec, USA
Salt rejection NaCl rejection MgSO <sub>4</sub> rejection	-	50% 98%	99.4% - -
Pure water permeability (L/hm. bar)	220±15	7.6±0.2	3.2±0.2

### 2.3 *Experimental procedure*

Firstly, experiments were carried out under total recirculation mode in order to optimize the operating parameters (TMP and velocity), both the concentrate and the permeate were recycled into the feed tank to keep the feed concentration approximately constant. The treated volume in each test was of 50 L. Then, filtration tests were conducted at constant TMP under concentrating mode, through which the permeate stream was withdrawn from the system. The Volume Concentrating Factor (VCF) was then determined by:

$$\text{VCF} = V_i/V_r$$

$$V_r = V_i - V_f$$

Where  $V_i$ ,  $V_f$  and  $V_r$  are respectively the initial, final and the retentate volumes.

After each run, the membrane was cleaned according to the recommendations of the manufacturer. To ensure the efficiency of membrane regeneration, the initial permeability of the membrane should be found by determining the evolution of the water flux with the transmembrane pressure (TMP). The average values of membrane permeability as measured were 7.6 L/h.m<sup>2</sup>.bar, 3.2 L/h.m<sup>2</sup>.bar and 220 L/h.m<sup>2</sup>.bar respectively for NF, RO and UF which remained almost constant throughout the conduction of all experiments. In the case when the membranes are much clogged, one cleaning operation is usually not sufficient to regenerate the membrane, a second one is then required. The variation of the membrane permeability should not exceed 2% for NF and RO and 15% for UF.

During each experiment, permeate volumes were collected and analyzed. The retention of different parameters (R) was then determined as follows:

$$R (\%) = 100 * (1 - C_p / C_f)$$

where  $C_p$  and  $C_f$  are respectively the solute concentration in the permeate and in the feed solution. Each experiment was repeated twice.

## 2.4 Analysis

Physico-chemical parameters of real effluent and of permeate were determined according to the standard methods suggested by American Public Health Association [40]. Conductivity and pH determinations were done respectively by means of a conductimeter, Tacussel model 123 and pH-meter, Metrohm 744 respectively.

COD was estimated by open reflux method. The protocol presents a method derived from the standard AFNOR T90-101. The sample was refluxed in an acidic medium with a known excess of potassium dichromate and the remaining dichromate was titrated with ferrous ammonium sulfate. The COD values were obtained using a Fisher Bio block Scientific reactor COD 10119 type COD-meter.

Anions were determined by ion chromatography using a Metrohm 761 Compact IC with conductivity detection. The anion chromatography measurements with chemical suppression were made with Metrosep Anion Dual 2 columns (4.6 mm x 75 mm) with a particle diameter of 6  $\mu$ m. Cations amounts were determined by atomic spectroscopy using an analytical Genway PFP 7 spectrometer. The TDS and SS determination were done by a Spectrophotometer DR3900.

## 2.5 Color intensity measurement

The different qualities of the treated water were reused in the dyeing process. The dyeing performances of the reused water compared to the fresh water was then determined using samples represented by textile items dyed in presence of NF permeates and fresh water as standard reference with a similar dyeing protocol. For that, a spectrophotometer (Data color Spectrum 2520) was used. The intensity of the dyeing color can be represented by a point in a space formed by three orthogonal axes: the first describes color evolution from green ( $-a^*$ ) to red ( $+a^*$ ), the second identifies color evolution from blue ( $-b^*$ ) to yellow ( $+b^*$ ) and the third one represents lightness  $L^*$  ranging from 0 for black to 100 for perfect white. In this measurement method, a comparison against a standard color is required. So, total color differences  $\Delta E$  can be calculated from analysis of samples and standard, following:

$$\Delta E = \sqrt{(\Delta a^*)^2 + (\Delta b^*)^2 + (\Delta L^*)^2}$$

$$\Delta a^* = a_{\text{sample}}^* - a_{\text{standard}}^*, \quad \Delta b^* = b_{\text{sample}}^* - b_{\text{standard}}^*,$$

$$\Delta L^* = L_{\text{sample}}^* - L_{\text{standard}}^*$$

The samples giving the best results should have a total color difference  $\Delta E$  close to zero. Then, the similarity between standard and samples was calculated following:

$$\text{Similarity (\%)} = (1 - \Delta E) \times 100$$



## 2.6 *Fouling characteristics*

Fouling is one of the main problems in membrane separation processes, which is caused by dissolved organic or inorganic compounds, colloids, suspended solids, bacteria. Nevertheless, for NF and reverse osmosis, it might be even somewhat more complex because of the interactions. The membrane surface interactions leading to fouling that can take place at nanoscale, and which are by the way difficult to understand [44,45].

In order to evaluate the fouling behavior of the membranes, the flux recovery ratio (FRR) has been determined. The FRR can be estimated using the following expression:

$$\text{FRR (\%)} = J_{wr} / J_{wi}$$

Where  $J_{wi}$  is the pure water flux of the fresh membrane and  $J_{wr}$  is the pure water flux of the membrane after rinsing.

FRR is a criterion indicating the fouling behavior of the membrane and is preferable to be closer to 100%. In order to explain the fouling and the permeate decline, the resistance series model was used to describe the fouling-resistant ability of NF and RO membranes.

Fouling resistances take place because of accumulation of solutes on the membrane surface and formation of cake layer and/or penetration of solutes inside the pores and deposition on their surface. The total fouling ( $R_t$ ), reversible fouling ( $R_r$ ) and irreversible fouling ( $R_{ir}$ ) were calculated using Eq Y1.

$$R_t = R_m + R_r + R_{ir}$$

where,  $R_t$  is the degree of total flux decline due to total fouling,  $R_r$  and  $R_{ir}$  represent reversible fouling caused respectively by concentration polarization and irreversible fouling resulted by adsorption or deposition of solutes on the membrane surface [27].

## 3. Results and discussion

The quality of the biologically pretreated water is not quietly into compliance with the Tunisian standard of wastewater discharge to public sewers, due to the high remaining salinity. In order to ensure good management of water resources through the reuse of wastewaters, RO and NF processes will be applied respectively for total and partial desalination of the Activated Sludge (AC) biologically pretreated effluent. The application of membrane processes is generally limited by the concentration polarization and fouling resulting in flux decline with time. However, permeate flux and quality can be improved by adjusting the filtration conditions such TMP and concentration as well as by the use of a suitable pretreatment. In this study, the approaches using direct NF, RO and integrated membrane systems UF/NF and UF/RO were investigated and compared.

### 3.1 *Performances of NF and RO*

#### 3.1.1 *Effect of TMP*

**Fig.3** displays the variation of NF and RO permeate flux with time at various TMP from 4 to 16 bar at a temperature of 25°C. Results show in all cases that the flux decreased slightly with time to obtain a steady state value after 30 min of filtration by NF and 20 min of filtration by RO. This decrease of the flux, which does not, exceeds 23% and 17% for NF and RO respectively, is mainly due to the deposition and adsorption of foulants on the membrane surface [41].

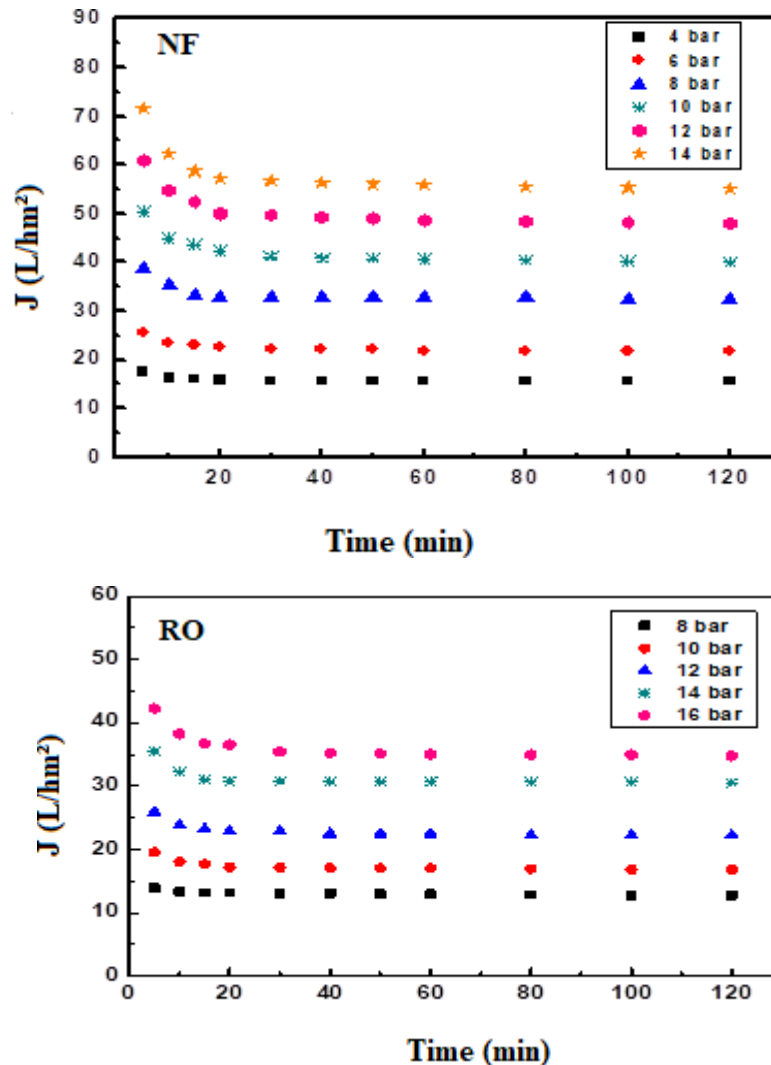

**Fig.3.** Variation of the permeate flux with time at different time TMP using NF and RO under 25°C

The characterization of NF permeate shows a total retention of the suspended matter independently of the pressure value. Generally, the retention of dissolved organic and inorganic substances increases with TMP until 8 bar, above this value, the retention varies slightly (Table.3). Regarding COD and salinity, the retention exceeds 60% (87% for COD and 62% for TDS).

Results presented in Table.3 show that the retention of bivalent ions is much higher than that of monovalent ones and that is minimally affected by the variation of pressure. At a high value above 6 bar a total retention of Ca<sup>2+</sup> and Mg<sup>2+</sup> and of about 88% (SO<sub>4</sub><sup>2-</sup>), 73% (NO<sub>3</sub><sup>-</sup>) and 71% (Na<sup>+</sup>) was observed. The lowest retention is obtained for chloride, of about 40%. NF membranes can reject high amounts of sulfate and allow sodium chloride

ions to pass through the membrane. Negative charge of NF membrane tends to repel polyvalent anions more widely than monovalent anions [42].

On the other hand, the secondary layer formed by dye molecules and the Donnan effect may be responsible for the permeability and dye rejection of the membrane instead of its intrinsic properties [2,3].

**Table.3.** Performances of the NF treatment at different TMP

Parameters	Raw Effluent	Permeate 4bar	Permeate 6bar	Permeate 8 bar	Permeate 10 bar	Permeate 12 bar	Permeate 14bar
		TR(%)	TR(%)	TR(%)	TR(%)	TR (%)	TR(%)
Flux (L/hm <sup>2</sup> )	-	15.5	21.8	32.48	42	48	55.2
pH	8,74	8.35	8.32	8,25	8,22	8,20	8.18
Conductivity (ms/cm)	6,70	58%	54%	62%	62%	62%	62%
TDS (g/L)	3,62	52%	55%	60%	61%	62%	62%
COD (mg/L)	213	86%	80%	87%	87%	87%	88%
Color (Pt-cd)	144	100%	100%	100%	100%	100%	100%
SS (mg/L)	38	100%	100%	100%	100%	100%	100%
Ca 2+(mg/L)	1340	99%	100%	100%	100%	100%	100%
Mg 2+(mg/L)	840	99%	100%	100%	100%	100%	100%
Chloride (mg/L)	817	33%	35%	40%	41%	43%	43%
Sulfate (mg/L)	1234	86%	82%	88%	88%	90%	90%
Sodium (mg/L)	2452	69%	67%	71%	71%	73%	73%
Nitrate (mg/L)	15	51%	60%	73%	73%	73%	73%

For RO membrane, a total retention of different organic and inorganic pollutants

has been detected from a TMP of 10 bar (table 4). The higher salinity retention efficiency is primarily due to the pore size effect and the membrane charge that can influence the selectivity of ions alone or associated, depending on the operating conditions.

In general, RO membrane has a higher NaCl rejection than NF270 membrane [43]. The difference in COD removal efficiency between NF and RO membranes can be explained in terms of the secondary layer formed by the adsorption of dye molecules on the membrane surface during filtration [3].

**Table.4.** Performances of the RO treatment at different TMP

Parameters	Raw Effluent	Permeate 10bar	Permeate 12bar	Permeate 14bar	Permeate 16bar
		TR (%)	TR (%)	TR (%)	TR (%)
Flux (L/hm <sup>2</sup> )	-	16.18	22.22	30.55	34.8
Ph	8,74	-	7,89	7,76	7,70
Conductivity (ms/cm)	6,70	99%	99%	99%	99%
TDS (g/L)	3.62	99.5%	99.5%	99.5%	99.5%
COD (mg/L)	213	96.7%	98%	99.36%	99.5%
Color (Pt-cd)	144	100%	100%	100%	100%
SS (mg/L)	38	100%	100%	100%	100%
Cl <sup>-</sup> (mg/L)	817	99%	99.5%	99.7%	99.8%
Ca <sup>2+</sup> (mg/L)	1340	100%	100%	100%	100%
Mg <sup>2+</sup> (mg/L)	840	100%	100%	100%	100%
Sulfate (mg/L)	1234	99.88%	99.88%	99.88%	99.88%
Sodium (mg/L)	2452	99%	99%	99.5%	99.5%
Nitrate (mg/L)	15	100%	100%	100%	100%

### 3.1.2 Fouling and cleaning study

The membrane fouling was estimated by the determination of the flux recovery rate (FRR) at different TMP. A slight decrease of FRR was observed that does not exceed

4% for NF and RO membranes were observed. The FRR at optimal TMP was respectively of 94% (at 8bar) for NF and 90 % (at 14 bar) for RO (**Fig.4**).

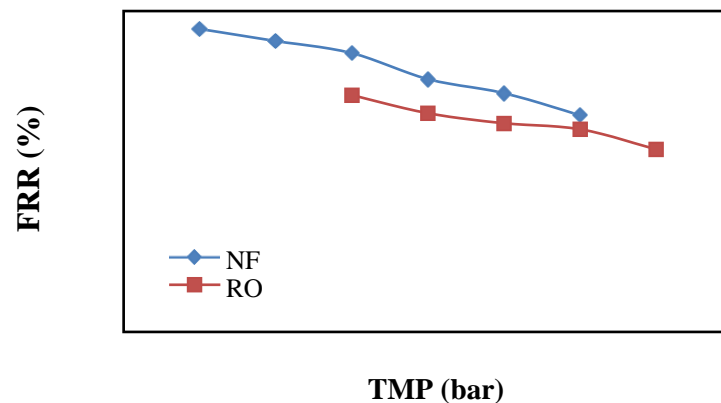

**Fig.4.**Evaluation of FRR with TMP for NF and RO

The resistance-in-series model has been applied to describe the decrease of the permeation flux with time of the membrane processes under the different TMP. The hydraulically reversible resistance, which is mainly due to the loose of foulants deposition on the membrane surface, will disappear easily after filtration stops and water washing which is not the case of the hydraulically irreversible resistance [2]. The fouling reversibility of NF and RO membranes was assessed by measuring the membrane water permeability before a simple rinsing with fresh water and after hydraulic cleaning.

**Fig.5** shows that the membrane irreversibility increases slightly with TMP until 8 bar for NF membrane (from 20% to 23%) and until 14 bar for RO membrane (from 18% to 26%). It can be seen in all the cases that  $R_r$  is much higher than  $R_{ir}$  at optimal pressure, indicating the formation of the cake layer on the membrane surface which provides a higher contribution to the fouling resistance than the adsorbed substances which remain inside the membrane after the washing stage with pure water [46].

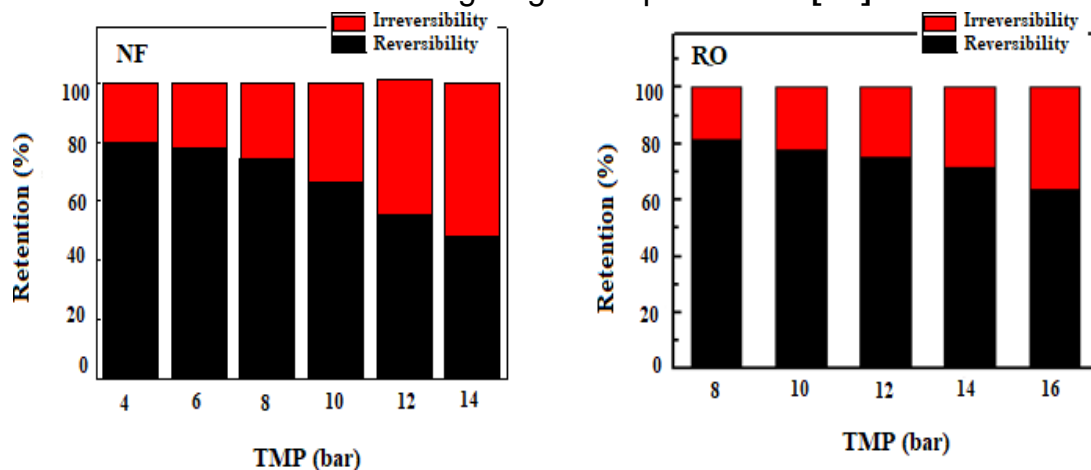
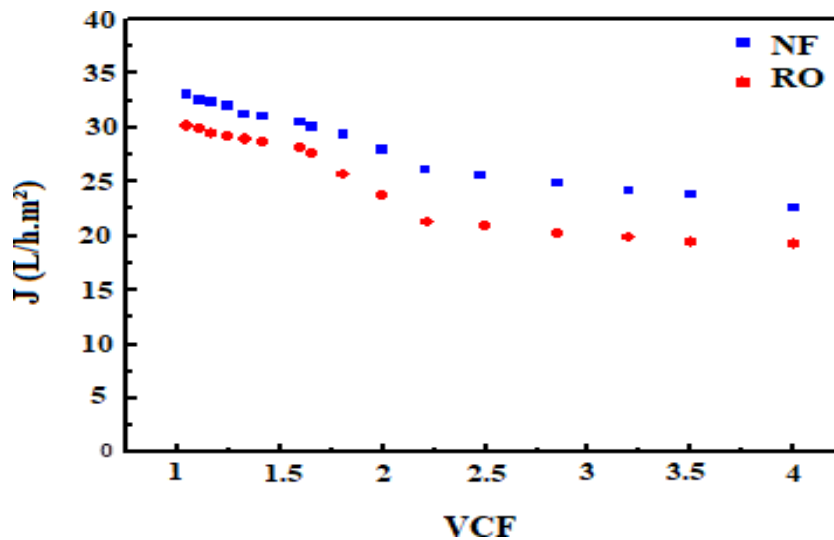

**Fig.5.**Evolution of the fouling reversibility of NF and RO membranes with TMP

### 3.1.3 Effect of the concentration

In this case, the experiments were carried out in the mode of recycling retentate and removing permeate at TMP of 14 bar for RO and 8 bar for NF. Fig.6 represents the variation of the permeate flux as a function of the volume concentration factor (VCF) for

NF and RO. The maximum VCF value obtained in both cases was of 4. The permeate flux decreases progressively from 33 L/m<sup>2</sup> h to 22 L/m<sup>2</sup> h for NF and from 30 L/m<sup>2</sup> h to 19 L/m<sup>2</sup> h. for RO with increasing feed concentration (VCF) then became almost independent beyond a VCF range of 2-2.5. The total flux reduction was around 33% and 63% for RO and NF respectively between VCF 1 and 4. This important decrease of flux is associated to the membrane fouling which could be due mainly to the concentration of pollutants in terms of salts and low molecular weight substances near the membrane surface due to polarization effect [3].



**Fig.6.** Variation of the permeate flux with VCF

According to **Fig 7a**, TDS removal remains almost unchanged with the increase of VCF until 1.8 for NF and 2 for RO and then decreased from 60% to 47% and from 99 to 96% respectively for NF and RO. In the same time, COD removal remains approximately unchanged with increasing feed concentration in the range 84-82% for NF and 97-95% for RO (**Fig 7b**). Thus, it is worthy to notice that the efficiency of the retention of COD seems independent of feed concentration for both processes. Whereas, the retention of TDS depends on the concentration of the feed mostly for NF. These finding show that fouling can diminish the permeate flux and might influence differently the retention of numerous compounds. In our case, removal of COD is not affected by fouling for RO and NF. Furthermore, feed is characterized by high salinity and contains especially high concentrations of sodium and chloride exceeding the limits fixed by Tunisian standards for water discharge into receiving environment NT 106.002.

The decrease of the TDS retention with VCF for NF can be related to the variability of the electrostatic interactions between the membrane charges and the ions in solution [43].

The problem of the NF and RO processes is the decrease of the permeate flux during treatment which is due to the accumulation of organic and inorganic molecules on the membrane surface (Eyupdik and al 2010). To improve the treatment by NF and RO, the UF pretreatment was explored.

### 3.2.1 Determination of the UF treatment performances

The results obtained from the UF applied as post-treatment to the biologically treated effluent using 150 KDa membrane are illustrated in Figs.8a and 8b. It can be observed a slight decrease of the permeate flux with time during the first 20 min and then a stabilization of the flux at 125 L/h.m<sup>2</sup> at 2 bar and 420 L/h.m<sup>2</sup> at 5 bar (Fig.8a).

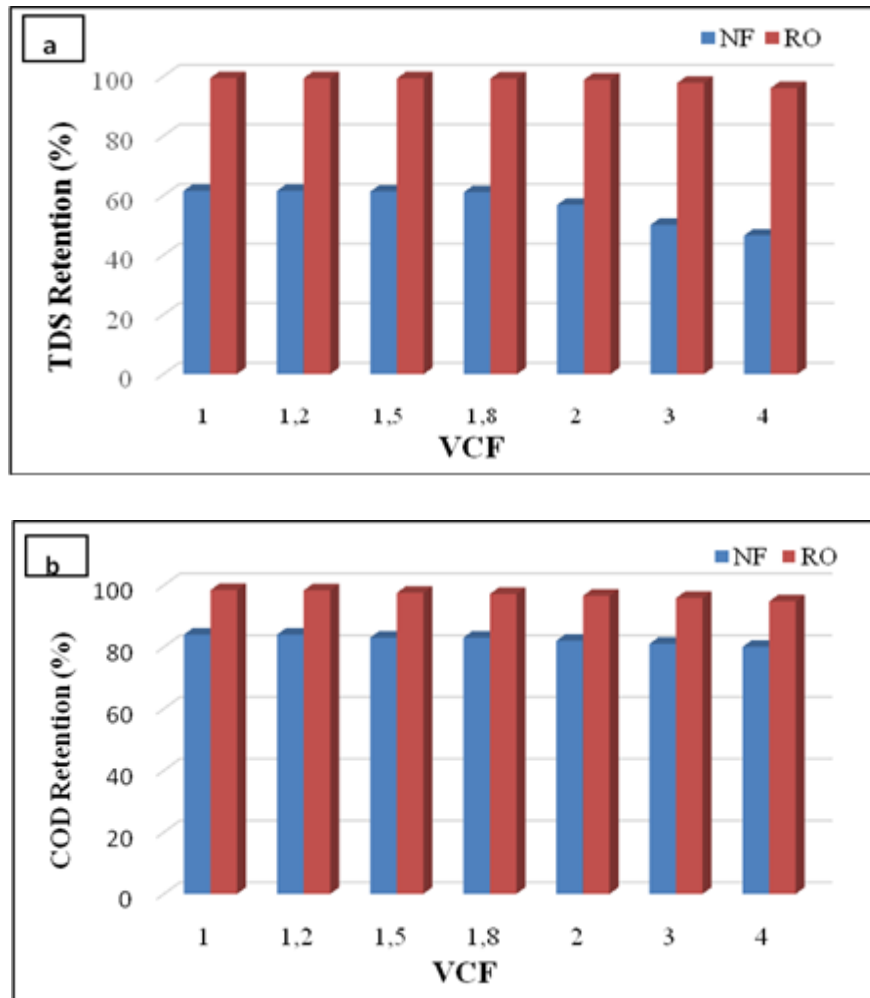

**Fig.7.** Evolution of TDS (a) and COD (b) retention with VCF

### 3.2 Effect of pretreatment by UF on the performances of RO and NF

The decrease of the flux in the early stage of filtration resulting in membrane fouling is attributed to rapid cake formation on the membrane surface due to the deposition of the particles larger than the membrane pore size [46]. On the other hand, the flux increases almost linearly with the pressure indicating that the mass transfer during ultrafiltration is controlled by the convection (no clogging of the pores).

The quality of the permeate at different TMP was controlled by measuring the color intensity, the suspended solids (SS) and the COD (Fig. 8b). It can be observed a total

retention of the SS beyond a pressure of 3 bar.

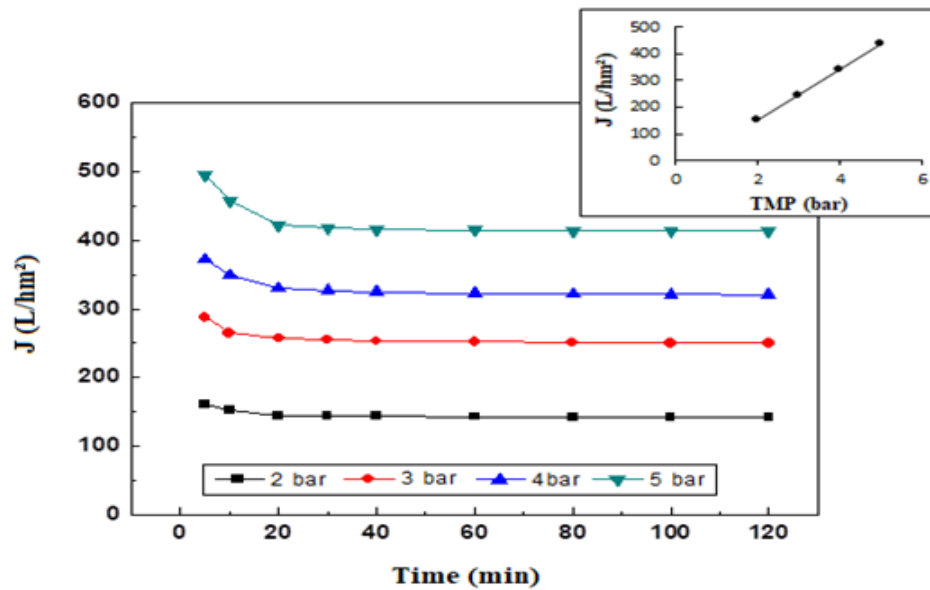

**Fig.8a.** Variation of the UF permeate flux with time at different TMP

In the same time, the retention of COD and color increases with the pressure until 3 bar and then remains almost unchanged for TMP higher than 3 bar. Therefore, 3 bar was retained as the optimal TMP for the subsequent tests.

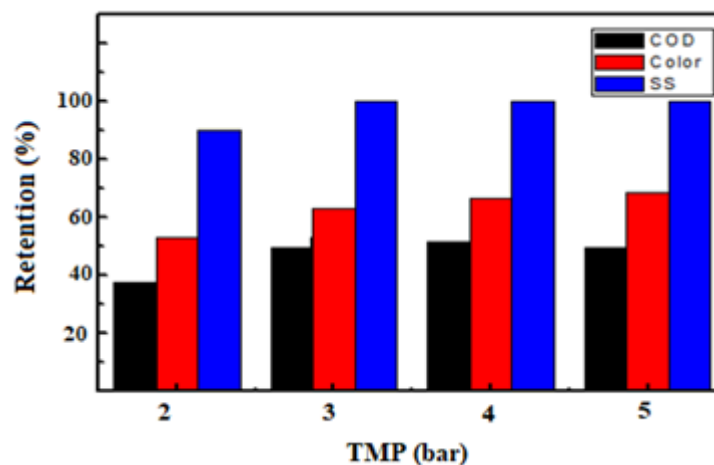

**Fig.8b.** Evolution of the pollutants retention with TMP using UF membrane

### 3.2.2 Determination of the hybrid UF/NF, UF/OI treatment performances

**Fig.9** displays the variation of UF/NF and UF/RO permeate flux and the pollutants retention with TMP at a temperature of 25°C.

The results show that the flux increased with TMP until 6 bar for UF/NF and 10 bar for UF/RO and then the variation became very slightly

The characterization of the UF/NF permeate shows that the pollutants retention increases with TMP until 6 bar, above this value, the retention became almost unchanged



of 93% for COD, 64% for TDS, 70% for Na<sup>+</sup> and 61% for Cl<sup>-</sup>.

For UF/RO treatment, a total retention of different pollutants has been detected from a TMP of 10 bar. Therefore, the UF pretreatment improves the purification performances for all pollutants and allows a decrease of the TMP for both hybrid systems. The permeate flux pattern with the pressure during both UF/NF and UF/RO processes results from fouling and polarization concentration.

As expected from the diffusion/convection transfer mechanism, the passage of pollutants across the membrane decreases with an increase of applied pressure (**Fig. 9**). At low TMP, the permeate flux increases with the transmembrane pressure reducing the diffusion contribution with respect to convection leading to the observed increase of the retention until a high-pressure plateau is reached that can be interpreted by the electro viscous effect related to electrostatic interactions between the membrane charges, the ions in solution and water [ 43,47].

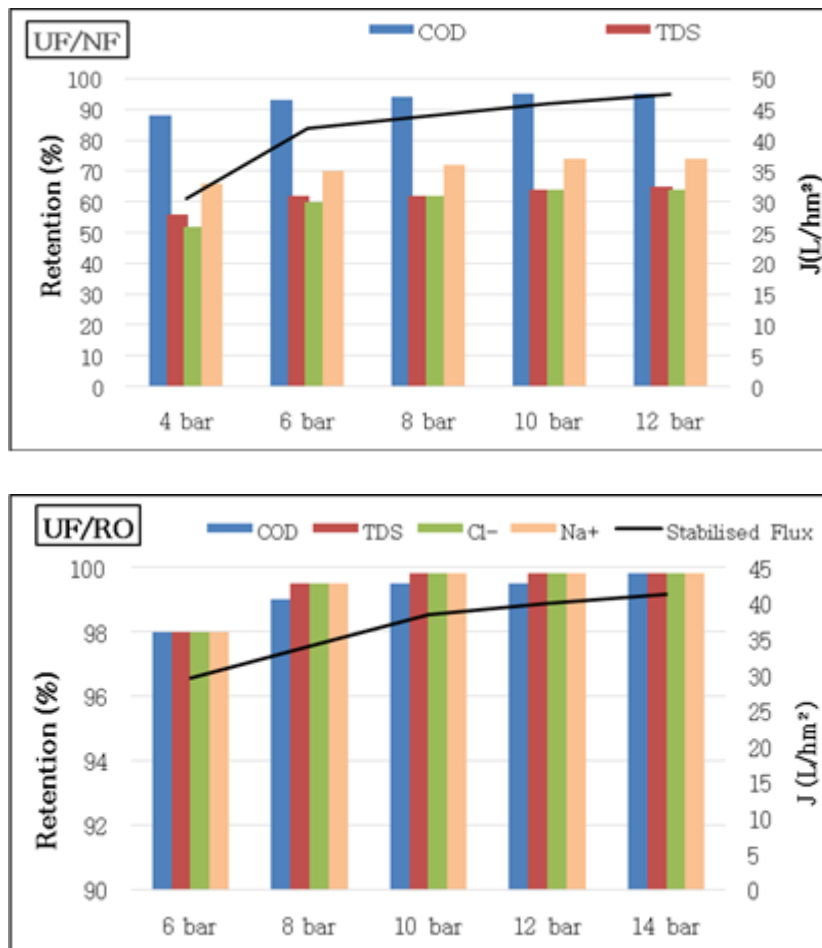

**Fig.9.**Evolution of the pollutants retention and permeate flux with TMP using the hybrid system UF/NF and UF/RO under 25°C

**Fig.10** confirms that the application of the UF as pretreatment highly improves the membrane permeability of NF and RO using in hybrid systems in comparison with direct NF and RO treatments. In the same time, a decrease of the membrane fouling was observed in the early stage of filtration. An enhancement of the permeability of 36% and

29% was observed respectively for NF and RO.

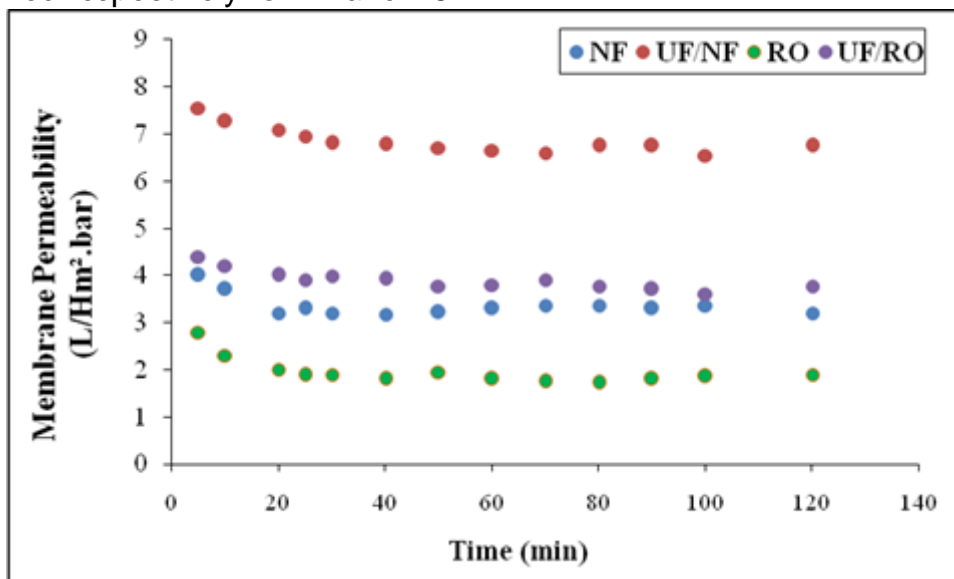

**Fig.10.** Evolution of the membrane permeability during the filtration for NF, UF/NF, RO and UF/RO processes

In terms of performances, Table.5 indicates that the application of UF prior to NF or RO allows to enhance the quality, particularly by 60 % in terms of COD for UF/NF and UF/RO treatment. The final water quality was fit for reuse in the dyeing process.

According to these results, the quality of the produced water by the direct RO and hybrid UF/NF and UF/RO is satisfactory and it is below the values recommended for the rejection limits and the water process, only the values pH exceeded slightly the recommended standard (Table 5).UF/NF permeate can also be used also as a process water. Therefore, UF/NF process is a promising option for textile wastewater recovery that can be used as alternative to UF/RO treatment offering the advantage of lower pressure needed and higher permeate flux. Practically, the treated water by NF membrane can be used in the dyeing process due for its relatively high content of dissolved solutes. While permeate through RO membrane can be used as dyeing or finishing water because of its extremely low salinity.

It is worthy to notice that in the presence of UF pre-treatment, the rinsing of the NF and RO membranes was sufficient to recover the initial membrane permeability.

**Table.5.** Physico-chemical characteristics of permeates from direct NF and RO and hybrid UF/NF and UF/RO systems

Parameter	Direct NF process	Hybrid UF/NF process	Direct RO process	Hybrid UF/RO process	Rejection limits	Water process
Permeate flux (L/h.m <sup>2</sup> )	32.5	39.6	30.55	36	-	-
pH	8.45	8.40	8.30	8.30	7<pH<8	-

Conductivity ( $\mu\text{c}/\text{cm}$ )	2520	2320	50	45	-	-
Color (mg/L)	0	0	0	0	100	0
SS (mg/L)	0	0	0	0	400	0
COD (mg/L)	30	12	5	2	< 30	<30
TDS (mg/L)	1420	1350	25	22	-	1.5
Cl <sup>-</sup> (mg/L)	490	300	4.6	3	700	500
Na <sup>+</sup> (mg/L)	711	510	12	9	1000	100
SO <sub>4</sub> <sup>2-</sup> (mg/L)	140	90	0	0	-	100

### 3.2.3 Treatment over a long period

In order to simulate the real conditions in the industry, the UF/RO and UF/NF treatment were investigated during three days under the optimum value of pressures of 6 bar for NF and 10 bar for RO. After each day, membranes were rinsed with water to determine the extent of irreversible fouling.

As indicated by Fig.11a, two trends were observed depending on the process. Initially, the permeate flux decreased very sharply for UF/NF during the first day from 45 L/h.m<sup>2</sup> to 37L/h.m<sup>2</sup> and from 40L/hm<sup>2</sup> to 34,4 L/hm<sup>2</sup> for UF/RO. After rinsing the membrane by fresh water, the flux increased to 43 L/ hm<sup>2</sup> and 38L/hm<sup>2</sup> respectively for UF/NF and UF/RO and then decreased with time to a value of 37L/h.m<sup>2</sup> (UF/NF) and 34L/hm<sup>2</sup> (UF/RO).

The efficiency of the membrane regeneration decreased after 48 h of filtration and the flux continued to decrease then to 33 L/h.M<sup>2</sup> and 30 L/hm<sup>2</sup> respectively for UF/NF and UF/RO at the end of the third day. The total permeate flux decrease between the first day and the third day corresponds to 10.81 % (UF/NF) and 12.79 % (UF/RO).

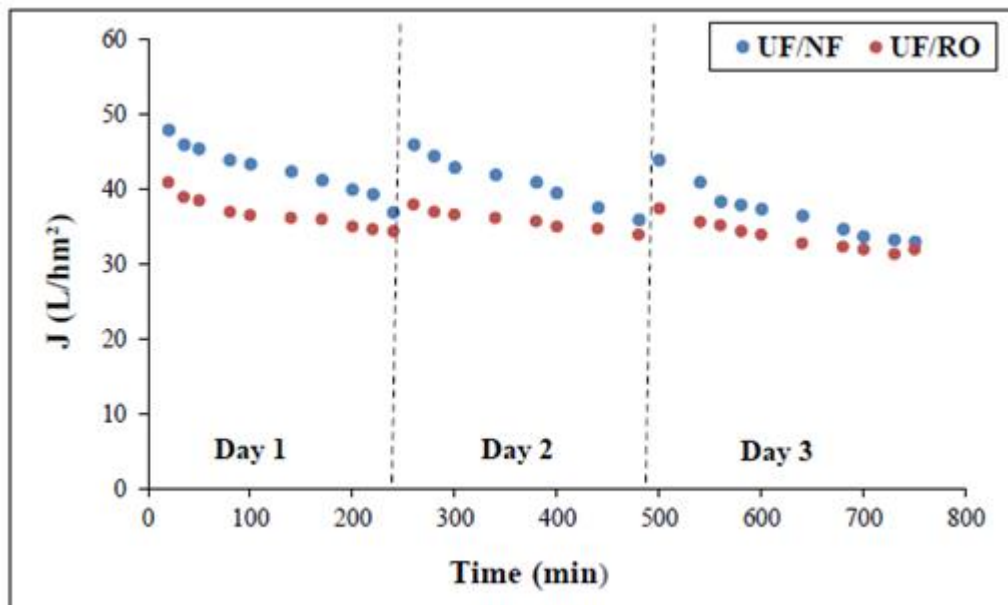

**Fig.11a.** Variation of the permeate flux with time for long period filtration with the hybrid UF/NF (TMP = 6bar) and UF/RO (TMP= 10 bar)

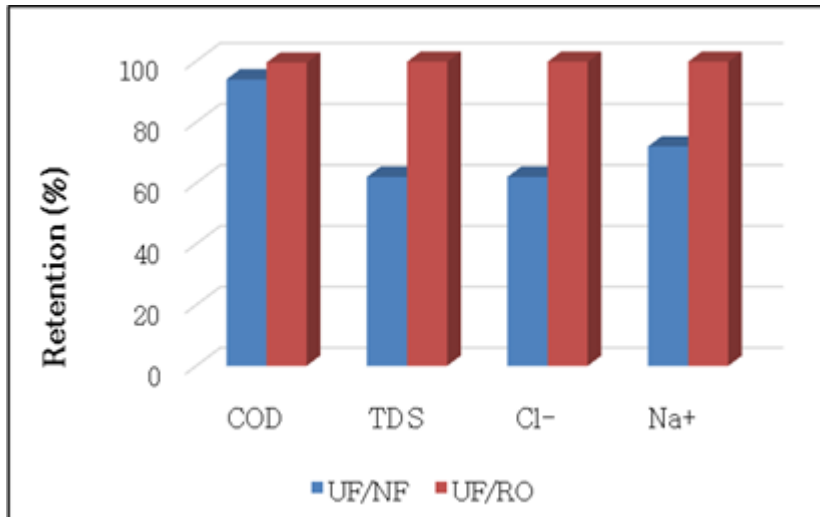

**Fig.11b.** Determination of COD, TDS and Cl<sup>-</sup> retention after 3 days filtration for NF and RO

High efficiency in the removal of pollutants from the hybrid UF/NF and UF/RO systems are obtained (Figure 11b): For UF/RO, the COD removal efficiency exceeds 90% , the TDS and Cl<sup>-</sup> retention are of almost 60% while the Na<sup>+</sup> removal is of 67%.

As expected, the hybrid system applied to the treatment of textile wastewater showed that the permeate quality was improved when compared with individually RO and NF operated separately with a sustainable flux.

Using the hybrid UF/NF process, removal rates of over 90% was achieved for most of the parameters measured in the UF/NF permeate.

### 3.3 Reuse test

The permeate quality after NF treatment generally satisfied the reuse requirements either in the dyeing bath [3] or as washing water [16]. In some cases, the NF permeate can be diluted with fresh water before reuse [48-51].

In the final part of this work, series of reactive and sulfur dyeing experiments were done with 100% of permeate of NF, RO, UF/NF and UF/RO in order to study the reusability of the treated water in laboratory scale. A comparative dyeing test was carried out with process water.

Tests were performed in laboratory dyeing machine using a support of cotton material. For reactive dyeing the different NF permeate quality contains again salt, in order to obtain the needed salt concentration in the dyeing bath, the quantity of NaCl added in the reuse tests corresponds just to the difference between the quantity of NaCl in the dyeing test with process water and in treated water.

It should be noticed that more  $\Delta E$  is close to zero, more similar the sample is to the control.

The best results were achieved by UF/NF permeate with 84% and 89% similarity for dyeing operation using respectively sulfur dye and reactive dye.

**Table.6.**Tests with reactivedye

	$\Delta L^*$	$\Delta a^*$	$\Delta b^*$	$\Delta E$
<b>RO</b>	-0.20	-0,05	0,10	0,21
<b>NF</b>	-0.12	-0,11	0,07	0,16
<b>UF/RO</b>	-0.22	-0.08	0.02	0.23
<b>UF/NF</b>	-0.10	-0.02	0.19	0.13

**Table.7.**Tests with sulfurdye

	$\Delta L^*$	$\Delta a^*$	$\Delta b^*$	$\Delta E$
<b>NF</b>	-0,08	-0.08	-0,10	0.15
<b>OI</b>	-0,11	0,03	-0.04	0.12
<b>UF/NF</b>	-0.06	0.05	-0.09	0.11
<b>UF/RO</b>	-0.10	0.11	-0.07	0.13

#### 4. Conclusion

The experimental results showed that the NF and RO processes could effectively be used for the enhancement of the quality of the biologically treated textile effluent. Both NF and RO membranes could remove color completely and reduce COD and TDS to desirable levels of less than 30 mg/L and 1500 mg/L respectively according the Tunisian standard of wastewater discharge to public sewers.

This study highlights also the efficiency of the hybrid UF/NF and UF/ RO for enhancing the permeate flux by 18% and 15% respectively and reducing membrane fouling as well as the transmembrane pressure from 8bar to 6 bar for NF and from 14 bar to 10 bar for RO compared to the treatment achieved with direct NF and RO. It can be drawn also that the hybrid UF/NF delivered better flux than the UF/RO and that for both UF and hybrid UF/NF and UF/ RO processes, the permeate flux values of 250 L/h/m<sup>2</sup> (3 bar), 40 L/h.m<sup>2</sup> (6bar) and 36 L/h.m<sup>2</sup> (10 bar) respectively, were in agreement with an industrial application.

On the other hand, the highest salt rejection was observed for RO process with a TDS removal exceeding 99% for both treatment systems (direct and hybrid), while NF treatment can provide only an average of 65% TDS removal.

The findings on treated water quality and different treatment performances strongly suggest that the hybrid processes is the promising option to realize water resource recovery suitable for dyeing process or water process which would be used in the company.

## REFERENCES

- [1] Vajnhandl, S., Valh, J.V (2014) The status of water reuse in European textile sector. *J. Environ. Manage* 141: 29-35
- [2] Yinping Zheng , Sanchuan Yu , Shi Shuai , Qing Zhou , Qibo Cheng , Meihong Liu , Congjie Gao (2013) Color removal and COD reduction of biologically treated textile effluent through submerged filtration using hollow fiber nanofiltration membrane. *Desalination* 314:89–95
- [3] Meihong Liu , ZhenhuaLü , Zhihai Chen , Sanchuan Yu , Congjie Gao (2011) Comparison of reverse osmosis and nanofiltration membranes in the treatment of biologically treated textile effluent for water reuse. *Desalination* 281:372–378
- [4] A.K. Verma, R.R. Dash, P. Bhunia, (2012) A review on chemical coagulation/flocculation technologies for removal of colour from textile wastewaters. *J. Environ. Manage* 93:154–168
- [5] A.E. Ghaly, R. Ananthashankar, M. Alhattab, V.V. Ramakrishnan (2014) Production, Characterization and Treatment of Textile Effluents: A Critical Review, *J Chem Eng Process Technol* 5:182
- [6] S.S.Kalra , S.Mohan, A.Sinha, and G.Singh, (2011) Advance Oxidation processes for Treatment of textile and dye Wastewater: A Review in 2nd International Conference on Environmental Science and Development. IACSIT Press: Singapore
- [7] P. Senthil Kumar, R. Sivaranjane, U. Vinothini, M. Raghavi, K.Rajasekar, K. Ramakrishnan, (2014) Adsorption of dye onto raw and surface modified tamarind seeds: isotherms, process design, kinetics and mechanism, *Desal. Water Treat* 52(13–15):2620–2633
- [8] Yurtsever, A., Çınar, O., Sahinkaya, E (2016) Treatment of textile wastewater using sequential sulfate-reducing anaerobic and sulfide-oxidizing aerobic membrane bioreactors. *J. Memb. Sci* 511: 228-237
- [9] Jegatheesan, V., Pramanik, B.K., Chen, J., Navaratna, D., Chang, C.-Y., Shu, L., (2016). Treatment of textile wastewater with membrane bioreactor: a critical review. *Bioresour. Technol* 204: 202-212
- [10] Verma, A.K., Dash, R.R., Bhunia, P (2012) A review on chemical coagulation/flocculation technologies for removal of colour from textile wastewaters. *J. Environ. Manag* 93 : 154-168
- [11] Jorfi, S., Darvishi Cheshmeh Soltani, R., Ahmadi, M., Khataee, A., Safari, M (2017) Sono-assisted adsorption of a textile dye on milk vetch-derived charcoal supported by silica nanopowder. *J. Environ. Manag* 187:111-121
- [12] J. Dasgupta, J Sikder, S. Chakraborty, S Curcio, E Drioli (2015) Remediation of textile effluents by membrane based treatment techniques: a state of the art review. *J. Environ. Manag* 147 :55-72
- [13] Soares, P.A., Souza, R., Soler, J., Silva, T.F.C.V., Souza, S.M.A.G.U., Boaventura, .A.R. Vilar, V.J.P (2017) Remediation of a synthetic textile wastewater from polyester cotton dyeing

combining biological and photochemical oxidation processes. *Sep. Purif. Technol.* 172:450-462.

[14] B. Marrot, N. Roche (2002) Wastewater treatment and reuse in textile industries, a review. *Res. Adv. Water Res* 3:41–53

[15] G. Tchobanoglous, F.L. Burton, H.D. Stensel, (2003) *Wastewater Engineering: Treatment and Reuse*, fourth ed. McGraw Hill New York, New York, USA

[16] E Kurt, D Y Koseoglu-Imer, N Dizge, S Chellam, I Koyuncu, Pilot-scale evaluation of nanofiltration and reverse osmosis for process reuse of segregated textile dyewash wastewater. *Desalination* 302 (2012) 24–32

[17] T Xu, Q Wang, S Wu, B Fu, P Liang, X Huang, X Zhang (2018), A novel filtration composite anode configuration of microbial fuel cell for efficient wastewater treatment and enhanced power generation, *Journal of Cleaner Production*, 178, ,305-313

[18] J.J Qin, M Htun Oo, K A. Kekre (2007) Nanofiltration for recovering wastewater from a specific dyeing facility. *Separation and Purification Technology* 56:199–203

[19] A.E. Simpton, C.A. Buckley (1988) Recovery of caustic soda from caustic wastewaters. *CHEMSA* 14 (3) 80:76-78

[20] C Allègre, P Moulin, M Maisseu, F, oise Charbit (2004) Savings and reuse of salts and water present in dye house effluents. *Desalination* 162:13–22

[21] S.N. Gaeta, U. Fedele (1991) Recovery of water and auxiliary chemicals from wastewaters of textile dye houses. *Desalination* 83 (1–3):183–194

[22] S. Chakraborty, M.K. Purkait, S. DasGupta, S. De, J.K. Basu (2003) Nanofiltration of textile plant effluent for color removal and reduction in COD. *Separation and Purification Technology* 31:141–151

[23] T-H Kim, C Park, S Kim (2005) Water recycling from desalination and purification process of reactive dye manufacturing industry by combined membrane filtration. *Journal of Cleaner Production* 13:779-786

[24] B. Van der Bruggen, L. Braeken, C. Vandecasteele (2002) Flux decline in nanofiltration due to adsorption of organic compounds. *Sep. Purif. Technol* 29: 23–31

[25] B. Van der Bruggen, G. Cornelis, C. Vandecasteele, I. Devreese (2005) Fouling of nanofiltration and ultrafiltration membranes applied for wastewater regeneration in the textile industry. *Desalination* 175:111–119

[26] J.-J. Qin, M.H. Oo, K. Kekre (2007) Nanofiltration for recovering wastewater from a specific dyeing facility. *Sep. Purif. Technol* 56:199–203

[27] Z Yin, C Yang, C Long, A Li (2017) Effect of integrated pretreatment technologies on RO membrane fouling for treating textile secondary effluent: Laboratory and pilot-scale experiments. *Chemical Engineering Journal* S1385-8947:31561-9

[28] N Uzal, L Yilmaz, U Yetis (2009) Microfiltration/ultrafiltration as pretreatment for

reclamation of rinsing waters of indigo dyeing, *Desalination* 240:198-208

[29] L.C. Juanga, D.H. Tseng and H.Y. Lin (2007) Membrane processes for water reuse from the effluent of industrial park wastewater treatment plant: a study on flux and fouling of membrane. *Desalination* 202:302-309

[30] G.J. Heijman, M. Vantieghem, S. Raktoe, J.Q.J.C. Verberk and J.C. van Dijk (2007) Blocking of capillaries as fouling mechanism for dead-end ultrafiltration. *J. Membr. Sci* 287: 119-125

[31] S.K. Kang and K.H. Choo (2003) Use of MF and UF membranes for reclamation of glass industry wastewater containing colloidal clay glass and particles. *J. Membr. Sci* 223. 89-103

[32] Y.S. Li, L. Yan, C.B. Xiang and L.J. Hong (2006) Treatment of oily wastewater by organic-inorganic composite tubular ultrafiltration (UF) membranes. *Desalination* 196:76-83

[33] N. Zaghbani, A. Hafiane, M. Dhahbi (2009) Removal of Eriochrome Blue Black R from wastewater using micellar-enhanced ultrafiltration. *J. Hazard. Mater.* 168:1417-1421

[34] N. Zaghbani, A. Hafiane, M. Dhahbi (2008) Removal of Safranin T from wastewater using micellar enhanced ultrafiltration. *Desalination* 222:348-356

[35] N. Zaghbani, A. Hafiane, M. Dhahbi (2007) Separation of methylene blue from aqueous solution by micellar enhanced ultrafiltration, *Sep. Purif. Technol* 55:117-124

[36] K. Majewska-Nowak, The effect of a polyelectrolyte on the efficiency of yesurfactant solution treatment by ultrafiltration, *Des* 221 (2008) 395-404 A.L. Ahmad, S.W. Puasa, Reactive dyes decolourization from an aqueous solution by combined coagulation/micellar-enhanced ultrafiltration process, *Chem. Eng. J.* 132 (2007) 257-265

[37] Gozálvez-Zafrilla JM, Sanz-Escribano D, Lora-García J, Hidalgo MCL (2008) Nanofiltration of secondary effluent for wastewater reuse in the textile industry. *Desalination* 222:272-279

[38] Nihel Ben Amar, Noura Kechaou, John Palmeri, André Deratani, Ali Sghaier (2009) Comparison of tertiary treatment by nanofiltration and reverse osmosis for water reuse in denim textile industry. *Journal of Hazardous Materials* 170, 115 : 111-117

[39] Ghazza Masmoudi, Raida Trabelsi, Emna Ellouze and Raja Ben Amar (2014) New treatment at source approach using combination of MF and NF for dyeing effluents reuse. *International Journal of Environmental Science and Technology* 11:1007-1016

[40] Standard Methods for the Examination of Water and Wastewater (1998) 18th ed American Public Health Association/American Water Works Association/Water Environment Federation, Washington, DC

[41] Qing Chen, Ying Yang, Mengsi Zhou, Meihong Liu, Sanchuan Yu, Congjie Gao (2015) Comparative study on the treatment of raw and biologically treated textile effluents through submerged nanofiltration. *Journal of Hazardous Materials* 284:121-129

[42] Mnif, A., Ben Sik, A.M & Hamrouni, B (2010) Effect of some physical and chemical



parameters on fluoride removal by nanofiltration. *Ionics* 16: 245-253

[43] M. A.Kammoun, S. Gassara, J. Palmeri, R. Ben Amar, A. Deratani (2020). Nanofiltration performance prediction for brackish water desalination: case study of Tunisian groundwater, *Desalination and Water treatment* 181:27-39

[44] Lee, S., Cho, J.W., Elimelech, M (2005) Combined influence of natural organic matter (NOM) and colloidal particles on nanofiltration membrane fouling. *Journal of Membrane Science* 262:27-41

[45] Jarusutthirak, C., Mattaraj, S., Jiratananon, R., 2007. Factors affecting nanofiltration performances in natural organic matter rejection and flux decline. *Separation and Purification Technology* 58:68-75.

[46] Saida Bousbih, Emna Errais, Fadila Darragi, Joelle Duplay, Malika Trabelsi- Ayadi, Michael Olawale Daramola & Raja Ben Amar (2020) Treatment of Textile Wastewater using monolayered Ultrafiltration Ceramic Membrane Fabricated from Natural Kaolin Clay. *Environmental Technology*. <https://doi.org/10.1080/09593330.2020.1729242>

[47] X. Lefebvre, J. Palmeri, P. David (2004) Nanofiltration theory: an analytic approach for single salts. *J. Phys. Chem. B* 108:16811–16824

[48] Nouha Tahri, Ghazza Masmoudi, Emna Ellouze, Amel Jrad, Patrick Drogui, Raja Ben Amar (2012) Coupling microfiltration and nanofiltration processes for the treatment at source of dyeing-containing effluent. *Journal of Cleaner Production* 33:226-235

[49] De Vreese, Van der Bruggen, B (2007) Cotton and polyester dyeing using nanofiltered wastewater I. *Dyes and Pigments* 74:313-319

[50] E. Sahinkaya, N. Uzal, U. Yetis, F. Dilek (2008) Biological treatment and nanofiltration of denim textile wastewater for reuse. *Journal of Hazardous Materials* 153:1142–1148

[51] C. Suksaroj, M. Héran, C. Allègre, F. Persin (2005) Treatment of textile plant effluent by nanofiltration and/or reverse osmosis for water reuse. *Desalination* 178:333–341

[52] Gairola K. C., Nautiyal A. R. and Dwivedi A. K (2011) Effect of Temperatures and Germination Media on Seed Germination of *Jatropha Curcas* Linn. *Advances in bio research* 2 (2):66–71