



HAL
open science

HARMONI at ELT: adaptive optics calibration unit from design to prototyping

Noah Schwartz, Edgard Renault, William Ceria, Martin Black, Kjetil Dohlen, Kacem El Hadi, Jean François Sauvage, Lisa Bardou, Timothy Morris, Benoit Neichel, et al.

► **To cite this version:**

Noah Schwartz, Edgard Renault, William Ceria, Martin Black, Kjetil Dohlen, et al.. HARMONI at ELT: adaptive optics calibration unit from design to prototyping. Proceedings SPIE Adaptive Optics Systems VIII, Jul 2022, Montréal, Canada. pp.203, 10.1117/12.2627247 . hal-03796039

HAL Id: hal-03796039

<https://hal.science/hal-03796039>

Submitted on 5 Oct 2022

HAL is a multi-disciplinary open access archive for the deposit and dissemination of scientific research documents, whether they are published or not. The documents may come from teaching and research institutions in France or abroad, or from public or private research centers.

L'archive ouverte pluridisciplinaire **HAL**, est destinée au dépôt et à la diffusion de documents scientifiques de niveau recherche, publiés ou non, émanant des établissements d'enseignement et de recherche français ou étrangers, des laboratoires publics ou privés.

HARMONI at ELT: Adaptive Optics Calibration Unit from design to prototyping

Noah Schwartz^{*a,c}, Edgard Renault^c, William Ceria^c, Martin Black^a, Kjetil Dohlen^c, Kacem El Hadi^c, Jean-François Sauvage^{b,c}, Lisa Bardou^d, Tim Morris^d, Benoit Neichel^c, Thierry Fusco^{b,c}, Fraser Clarke^e, David Melotte^a, Niranjana Thatte^e on behalf of the HARMONI consortium.

^aUK Astronomy Technology Centre, Blackford Hill, Edinburgh EH9 3HJ, United Kingdom;

^bONERA, 29 avenue de la Division Leclerc, 92322 Châtillon, France; ^cMarseille Univ, CNRS, LAM, Laboratoire d'Astrophysique de Marseille, Marseille, France; ^dDept. Centre for Advanced Instrumentation, Durham University, South Road, Durham, DH1 3LE, United Kingdom; ^eDept. of Astrophysics, University of Oxford, Keble Road, Oxford, OX1 3RH, United Kingdom.

ABSTRACT

In this paper, we present the design and prototyping of the HARMONI Adaptive Optics Calibration Unit (AOCU). The AOCU consists of a set of on-axis sources (covering 0.5-2.4 μm) with a controllable wavefront shape. It will deploy into the instrument focal plane to inject calibration light into the rest of the system. The AOCU supports all-natural guide-star wavefront sensors for SCAO, HCAO, and LTAO.

The AOCU will be used to calibrate the WFSs, the internal interaction matrices of HARMONI, measure and compensate NCPAs between AO dichroics and the science detectors, and calibrate the pointing model zero position. The illumination assembly of the AOCU will consist of six diffraction-limited sources and a resolved source coupled into fibres. Because of the wide range of wavelengths and the spatial separations requirements, we use two endlessly single-mode fibres and a multimode fibre. In addition, several LED sources need to be coupled efficiently into the single-mode fibres. In this paper, we present the general AOCU design using off-the-shelf with a focus on the illumination and source module.

Keywords: ELT, Adaptive optics, calibration source, natural guide star, aberrations

1 INTRODUCTION

HARMONI is the first-light visible and near-IR integral field spectrograph for the ELT. It covers a large spectral range from 450 nm to 2450 nm with resolving powers from 3500 to 18000 and spatial sampling from 60 mas to 4 mas. It can operate in two Adaptive Optics [AO] modes - SCAO (including a High Contrast capability) and LTAO - or with NOAO. The project is preparing for Final Design Reviews.

The goal of the AO calibrations is to provide the necessary data to close and optimise the various AO loops during scientific observations. AO calibrations are fundamentally different from science calibrations, in that they must be taken *before* the observations, and are used to optimise performance rather than correct effects post-facto. The AO calibration Unit (AOCU) is part of the Calibration Module and feeds both the SCAO and LTAO natural guide-star sensors.

The paper is divided as follows. In section 2 we present the main systems of HARMONI, focusing on the adaptive optics calibrations. This includes a conceptual mechanical design for the optical bench, assembly, and enclosure. In section 3 we provide the optical design and a preliminary tolerance analysis. Finally in section 4, we discuss the source module in detail, where we focus on the illumination architecture combining multiples LEDs in to single-mode fibres.

2 HARMONI AND AO CALIBRATIONS

2.1 HARMONI

HARMONI^{1,2} is a near-IR/optical integral field spectrograph. It will use image slicers to provide spectra over a single contiguous field measuring 204x152 spaxels in size. Light from the telescope is relayed to the instrument by a cooled relay system, to minimise additional thermal background. A dichroic in front of the relay separates LGS light from NGS and science light to enable LTAO observations. Calibration light can be fed into the instrument via a deployable calibration system upstream of the relay (i.e., upstream of the FPRS). **Error! Reference source not found.** shows a schematic of the HARMONI instrument showing the different modules.

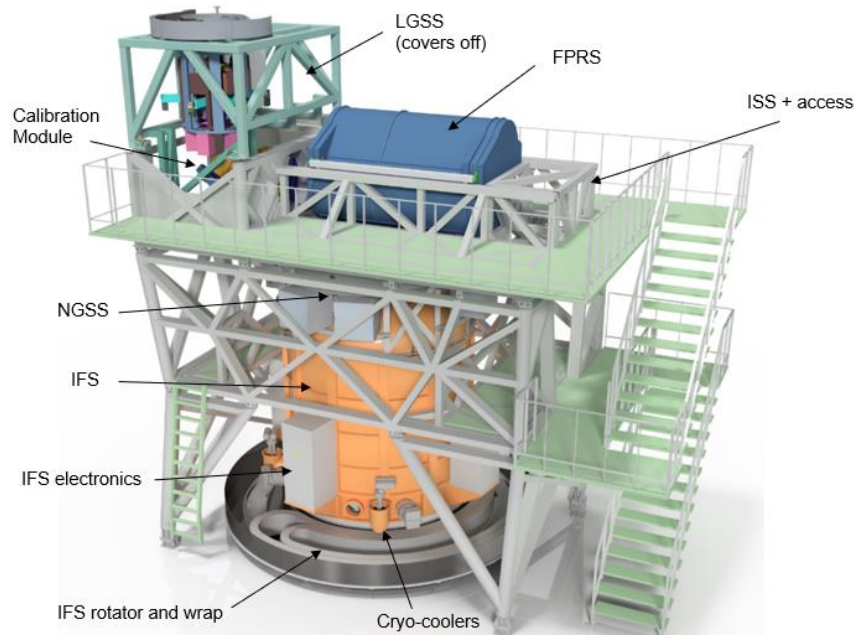

Figure 2-1: Rendering of HARMONI structure highlighting some key elements and modules. The Calibration Module can be deployed into the instrument focal plane to inject calibration light into the rest of the system.

Brief system overview of HARMONI:

- The Laser Guide Star Sensors^{3,4} (LGSS) system is located at the entrance of HARMONI and is used to sense high-order wavefront aberrations via six laser guide stars for LTAO operation.
- The focal plane relay module (FPRS) is a modified Offner relay providing a 2-arcminute field to the cryostat and to the NGS sensing module. It provides the functions to get telescope and calibration light into the instrument.
- The Natural Guide Star System⁵ (NGSS) is composed of three optical sub-systems which are gathered into a single assembly. It provides the SCAO, high-contrast, LTAO-NGS, and seeing-limited guiding capabilities to HARMONI.
- The Integral Field Spectrograph (IFS) is the heart of HARMONI and contains the opto-mechanics of the ‘science instrument’. It is effectively a set of optics (pre-optics, IFU, spectrographs) and detectors in a large cryostat.
- The Calibration Module⁶ (CM) sits just in front of the telescope focal plane and injects calibration light into the system. It can be completely withdrawn to allow normal observations. The calibration module is comprised of three separate units: the IFS calibration unit, the Geometric calibration unit, and the AO calibration unit.

2.2 Calibration Module

The calibration module sub-system includes all the functionalities necessary to remove the instrumental signature from the observed science data (except transmission spectrum, where a spectrophotometric standard star is needed). The calibration module also provides calibration facilities for the NGSS-WFS.

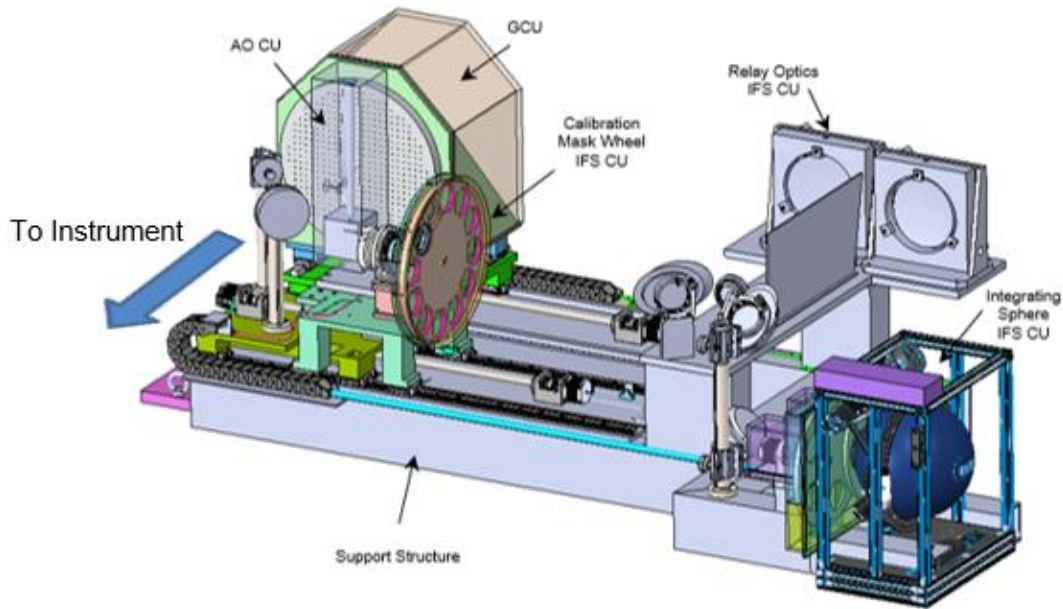

Figure 2-2: CM main structure and components, showing the location of the AO Calibration Unit in transparency.

2.3 AO Calibration Unit

The AO Calibration Unit (AOCU) provides illumination to the NGSS and the IFS. It is comprised of a set of on-axis sources (covering approx. 0.5-2.4 μm) with a controllable wavefront shape (i.e., via a deformable mirror in the pupil plane). The AO Calibration Unit supports natural guide-star wavefront sensors for SCAO, HCAO, and LTAO (see Figure 2-3). Note that the calibration module does not support any calibration for the LGS WFS. This unit consists of a deformable mirror (CalDM) which identical to the DM used for SCAO, a pupil mask representing the outer pupil shape of the ELT, a spherical collimator mirror, a roof-top mirror, and a fibre source assembly. Illumination is provided by a fibre assembly combining 7 light sources into a single fibre bundle fed to the instrument through a single connector.

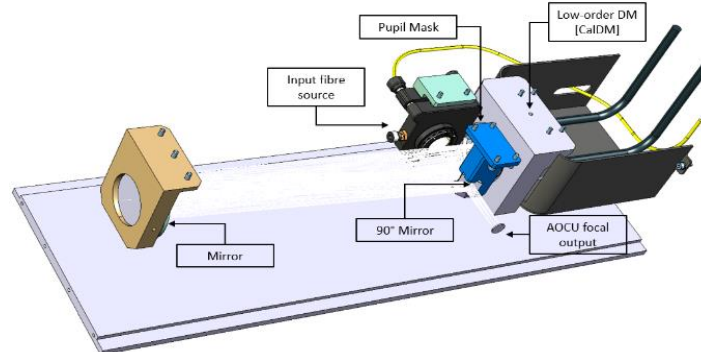

Figure 2-3: AOCU design with main elements highlighted.

Mechanically the AOCU takes the form of an optical bench encapsulated in a protective box. Figure 2-4 shows the AOCU box standalone and in context (i.e., part of the calibration module). This box consists of 6 panels plus a connector panel for the optical fibres and the deformable mirror (CalDM) cables. The optical fibre bundle having a large bend radius requires an additional volume to reach the injection module. For alignment purposes, the fibre mount (black module on right-hand side image) can be adjusted in 2 degrees of freedom. The spherical mirror and the deformable mirror (top of right-hand side image) can be adjusted in translation.

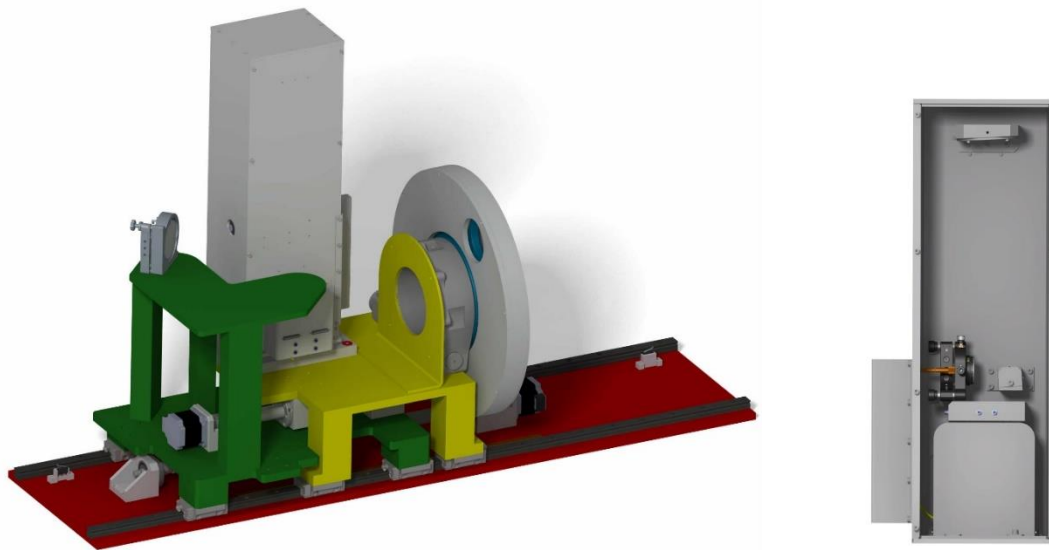
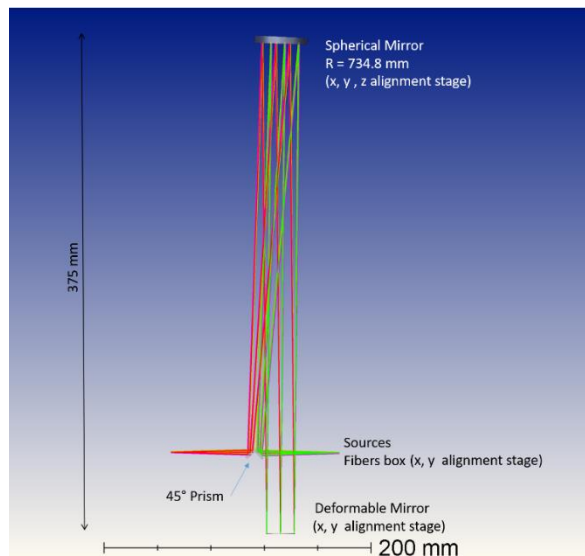

Figure 2-4: Illustration of the AOCU in its context (left), and the AOCU box showing the optical bench.

3 OPTICAL DESIGN

3.1 Optical design

The AOCU optical design is only composed of 3 elements: a 45° mirror prism, a spherical mirror, and a deformable mirror. The sources (3 fibres combined in a single fibre bundle) provide a beam to the prism. The 45° prism folds the beam to the spherical mirror. The source being located at the focus of the spherical mirror, a collimated beam is sent to the CalDM deformable mirror. An Alpao DM97-25 was selected, offering 8x8 actuators within the 20 mm pupil. A pupil mask representing the external shape of the ELT entrance pupil (M1) is mounted just in front of the CalDM active surface. The mask will be mounted in the factory at a distance of 250 μm from the surface. Fresnel propagation due to this mask, which appears in double pass both before and after the pupil plane, produce an edge ripple in the projected pupil of 10% intensity variation extending 0.3% of the pupil diameter into the pupil. This effect is judged acceptable for the purposes of aberration calibration. After hitting the DM, the corrected beam (astigmatism and coma) returns to the spherical mirror at semi-curvature distance. At last, the beam is focused at the exit of the AOCU box via the prism.



FoV position	WFE rms
(0, 0)	0.085 nm
(1mm, 0)	0.748 nm
(-1 mm, 0)	0.752 nm
(0, 1 mm)	1.148 nm
(0, -1 mm)	1.439 nm

Figure 3-1: AOCU optical design (left) and image quality over a field of view of 1 mm².

The AOCU provides a beam with a 17.75 ± 0.2 aperture and a very good image quality (<10 nm rms) over the whole field (2 mm x 1 mm area).

3.2 Tolerance analysis

To align the system, 3 optical elements can be controlled in position: the sources' fibre box (alignment stage in X and Y), the spherical mirror (alignments in X, Y, and Z), and CalDM (in X and Y). A small amount of CalDM stroke can be used to correct low-order aberrations. The system is relatively sensitive to misalignment, but with the chosen movements and the use of the DM, it is possible to make the system sufficiently tolerant (see Table 3-1).

Table 3-1: Tolerancing of AOCU including manufacturing and alignment.

Optical Element	Tolerances	Compensators
Sources	Position: dz ± 50 μ m	Position: dx = ± 1 mm dy = ± 1 mm
Prism	Manufacturing: angle $45^\circ \pm 1'$ Surface quality: plane ± 80 nm Position: dz ± 100 μ m Theta x = $1.8^\circ \pm 1'$ Theta y = $0^\circ \pm 1'$	
Spherical Mirror	Manufacturing: Curvature 734.806 mm ± 0.5 mm Surface quality: spherical ± 80 nm Position: dz ± 100 μ m Theta x = $2.6^\circ \pm 1'$ Theta y = $0^\circ \pm 1'$	Position: dx ± 2 mm dy ± 2 mm
DM mount & shape	Position: dz ± 100 μ m	Position: dx ± 2 mm dy ± 2 mm Mirror shape: Z4 ± 0.1 μ m Z6 ± 0.1 μ m Z7 ± 0.1 μ m Z11 ± 0.1 μ m

4 SOURCE MODULE

4.1 LED sources

The AOCU provides light sources of two types depending on the sensors and calibration requirements: a telescope diffraction-limited source using a single mode fibre (SM), and an extended source using multimode fibre (MM), see Table 4-1. Source dimension expressed in on-sky angular dimensions (mas) can be translated into linear dimensions in the $Ft = 17.75$ telescope focus (in which the CM is located) through the plate scale: ~ 3.3 μ m/mas. The LED sources are off-the-shelf mounted LEDs and are designed to be feed directly into a multimode fibre. This commonality makes electrical and mechanical integration easier and allows the sources to be changed easily.

Table 4-1: List and spectrum of AOCU light-sources needed to calibrate the various HARMONI sensors.

Sensor	λ_c	FWHM	Comment
Truth Sensor	1050	60	Core 40-50 mas
Pyramid	780	28	Diffraction limited
SH-WFS	680	22	Diffraction limited
Zelda	1200	80	Diffraction limited
TTF1	1450	95	Diffraction limited
TTF2	1550	102	Diffraction limited
Science	1650	120	Diffraction limited

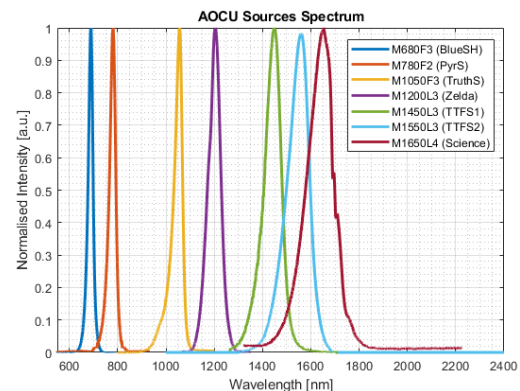

4.2 Illumination system architecture

The source module (located away from the AOCU box itself, in the electronics cabinets) will be remote from the optical output and thus fibres are used to route the sources' output to the AOCU. The multiple sources are fed along individual off-the-shelf fibres to a breakout panel (connector panel, CP) mounted on the main AOCU structure. At this interface the fibres connect to a fibre bundle combining them to single input to the system. The bundle will consist of two individual single mode fibres and one multimode fibre.

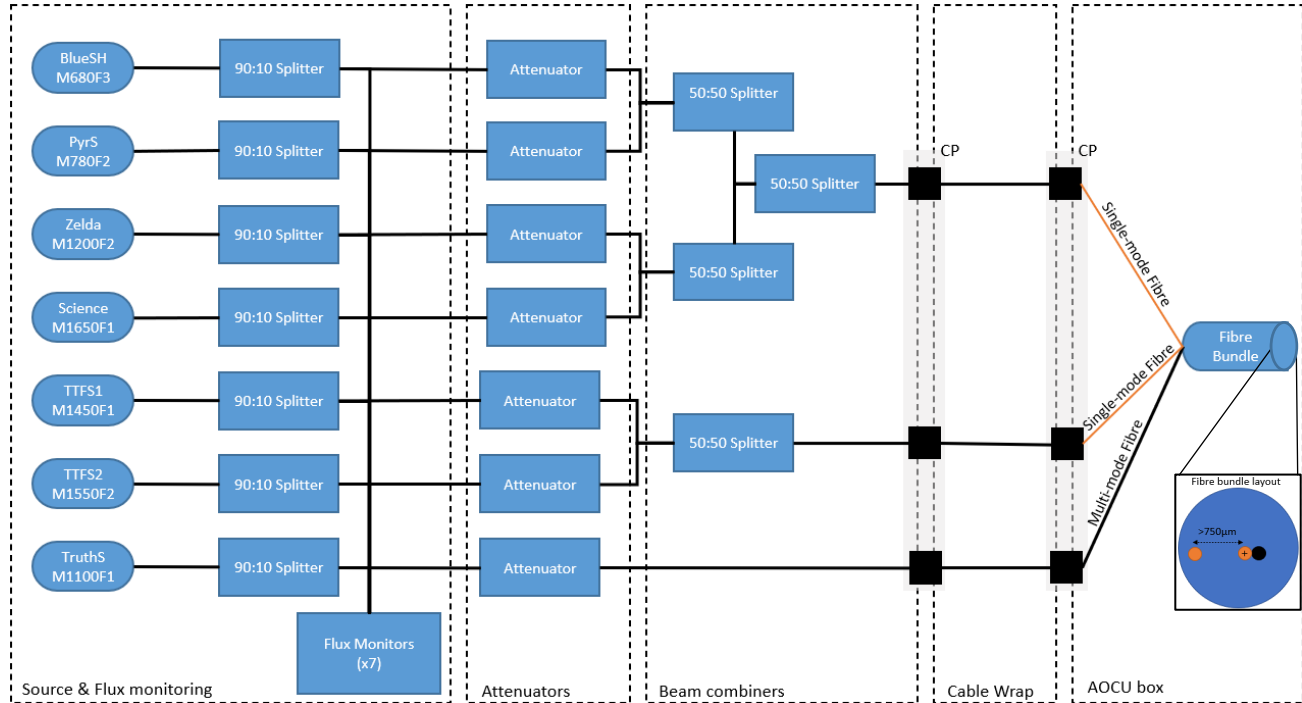

Figure 4-1: General overview of the illumination system architecture. (CP: Connector Panel).

For monitoring the sources' output a fibre coupler will be used to split off a fraction of the sources' output to a photodiode. In some cases, multiple sensors need be illuminated simultaneously (e.g., Pyramid and Blue Shack-Hartmann WFS for SCAO calibrations). As such they need to be brought together into a common fibre. This is done using a 50:50 beam splitter in reverse. Despite the poor throughput of such an architecture, some sources will need to be attenuated. This is achieved by off-the-shelf Thorlabs VOAMMS Multimode fibre attenuators.

4.3 Multi-mode to single mode fibre coupling

The AOCU in HARMONI, we require flux at different wavelengths emitted from a single mode (SM) fibre. We propose to build a system based on multi-mode (MM) fibres to collect light from LEDs, adjust flux levels, and perform flux monitoring, then inject light into a SM fibre by butt-coupling the two fibres. This is costly in terms of throughput (see Table 4-2), but according to radiation budgets, the flux level should be sufficient.

Each fibre has the capacity to transmit a certain étendue ("A-Ω product", noted E here). Assuming the source fully fills the étendue of the multi-mode fibre (E_{MM}) and that the MM fibre fully fills the étendue of the single-mode fibre (E_{SM}), then the ratio between MM and SM output power is:

$$\eta = \frac{E_{MM}}{E_{SM}} \quad (1)$$

For the multi-mode fibre, the geometry is simple: the entire fibre core (diameter D) is carrying light with an angular extent described by the numerical aperture (NA) of the fibre. The étendue of the fully illuminated fibre is then equal to the product of fibre core cross-section area ($A = \pi D^2/4$) and the solid angle of the exit beam ($\Omega = 2\pi(1 - \cos(NA)) \approx \pi NA^2$). The étendue is therefore:

$$E_{MM} = A_{MM} \cdot \Omega_{MM} = \left(\frac{\pi \cdot D \cdot NA}{2}\right)^2 \quad (2)$$

For the single-mode fibre, the geometry is more complex, with Gaussian profiles both near field and far field. The étendue of the single mode fibre is equal to the product of the equivalent mode field diameter (MFD), obtained by integrating the near field profile, and the equivalent solid angle, obtained by integrating the near field profile.

$$E_{SM} = A_{SM} \cdot \Omega_{SM} = \frac{\pi}{8} MDF^2 \cdot \frac{2}{\pi} \left(\frac{\lambda}{MDF}\right)^2 = (\lambda/2)^2 \quad (3)$$

The expected ratio of power between multi and single-mode fibres is therefore:

$$\eta = \left(\frac{\pi \cdot D \cdot NA}{\lambda}\right)^2 \quad (4)$$

Table 4-2 shows the expected power for injecting into a single-mode fibre. The selected LED sources, ranging from the visible to the near infrared, should in theory have a coupling efficiency ranging from 8000 to over 40000, assuming a multimode fibre of diameter D = 200 μm and numerical aperture NA = 0.22.

Table 4-2: Multimode to single mode fibre coupling as a function of wavelength of the source, assuming a multimode fibre of diameter D = 200 and 400 μm and numerical aperture NA = 0.22.

Sensor	Central λ (nm)	Power ratio (D=200 μm)	Power ratio (D=400 μm)
M680F3	680	41323	165290
M780F2	780	31406	125625
M1200F2	1200	13269	53077
M1450F1	1450	9088	36352
M1550F2	1550	7953	31813
M1650F1	1650	7018	28074

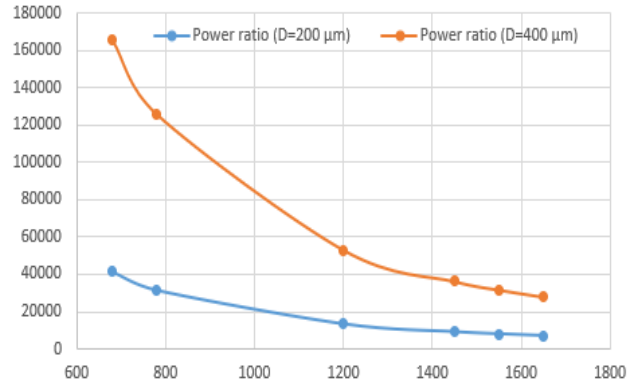

4.4 Photonic crystal fibre and fibre bundle

For optical fibres the normalized frequency V (or single-mode cut-off) is given by $V = 2\pi a/\lambda NA$, where a is the core radius, λ is the wavelength in vacuum, and NA the numerical aperture. For single-mode operation, it is required that $V < 2.4048$, the first root of the Bessel function J_0 , with the number of modes approximately $\propto V^2/2$. To overcome this difficulty, we use an endlessly single-mode photonic crystal fibre (PCF) for multiwavelength guidance. One of the unique properties of photonic crystal fibres is their capability of offering endlessly single-mode guidance – meaning they remain single-mode at any wavelength, which practically permits using them in the < 400 nm to > 2000 nm range (limited mainly by the transmission window of fused silica), see Figure 4-2. The LMA-5 is capable of guiding light in the 640-1850 nm range while emitting a Gaussian mode, providing a mode field diameter on the order of ~4.5-4.7 μm.

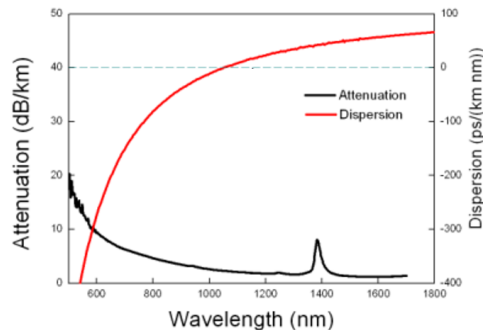

Figure 4-2: Attenuation of LMA-5 as a function of wavelength

However, special care is required when handling PCFs (e.g., cleaving, connectorizing...). For the engineering model currently being developed, we use a 2 m long cable containing Thorlabs LMA-PM-5 photonic crystal fibre, both ends terminated with ceramic optical fibre connectors. The fibre will be protected by a furcation tube, selected to ensure fibre minimum bend radius is not exceeded. The tube will also provide tensile support (Aramid yarn). The tube and connector type are still TBD; however the connector is likely to be ST or FC/PC.

The fibre bundle brings the 3 fibres into a single output. For the engineering model, a multi-fibre ferrule demonstrator sized for 1-off Thorlabs multimode FG200LCC fibre and 2-off single-mode fibres (125 μm cladding) will be manufactured by Northern Light Optical. Distribution and fibre separations as per Figure 4-3. Fibre stubs shall be bonded into the ferrule and the end face polished.

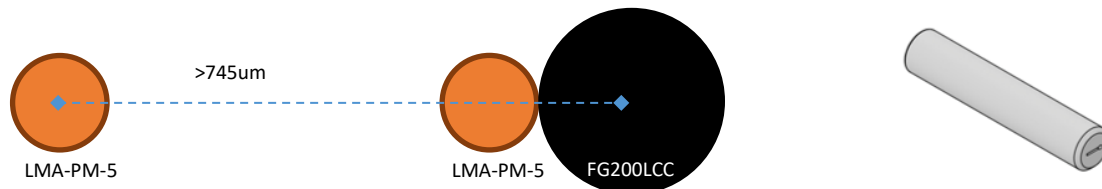

Figure 4-3: (Left) Fibre bundle output geometry showing the MM fibre (black) and SM fibre (orange). (Right) custom ferrule by Northern Light Optical.

5 CONCLUSIONS

An optical design for the HARMONI adaptive optics calibration unit and in particular for the sources is presented in this paper. These artificial sources can be used to calibrate the HARMONI AO system at any time and assure good performance. A preliminary tolerances analysis shows that despite being sensitive, we can use the alignment degrees of freedom of the components and a small amount of CalDM stroke to make the system robust to misalignments. The design of the source module is presented. Testing is on-going and is due to be completed in Q4 of 2022.

ACKNOWLEDGMENTS

HARMONI is an instrument designed and built by a consortium of British, French, and Spanish institutes in collaboration with ESO. This paper describes work that was partially supported by the French national research agency (ANR) under the Future Investment Program (PIA, Programme d'Investissements d'Avenir, PIA) under reference ANR-21-ESRE-008 and the French CSAA program.

REFERENCES

- [1] Thatte, N. A., et al., "HARMONI: first light spectroscopy for the ELT: instrument final design and quantitative performance predictions". In *Ground-based and Airborne Instrumentation for Astronomy VIII*. SPIE, Volume 11447 (2020).
- [2] Thatte, N. A., et al., "HARMONI at ELT: Overview of the capabilities and expected performance of the ELT's first light, adaptive optics assisted integral field spectrograph". In *Ground-based and Airborne Instrumentation for Astronomy IX*, Volume 12184 (2022).
- [3] K. El Hadi, et al., "HARMONI at ELT: designing a laser guide star wavefront sensor for the ELT". In *Adaptive Optics Systems VIII*, Volume 12185 (2022).
- [4] P. Jouve, et al., "HARMONI at ELT: Full scale prototype of the LGS WFS.". In *Adaptive Optics Systems VIII*, Volume 12185 (2022).
- [5] K. Dohlen, et al., "HARMONI at ELT: Towards a final design for the natural guide star sensors (NGSS) system". In *Modeling, Systems Engineering, and Project Management for Astronomy X*, Volume 12187 (2022).
- [6] A. Heribert, et al., "HARMONI at ELT: Calibration Module functional and design description". In *Ground-based and Airborne Instrumentation for Astronomy IX*, Volume 12184 (2022).