



HAL
open science

CaMK1D signaling in AgRP neurons promotes ghrelin-mediated food intake

Kevin Vivot, Gergö Meszaros, Zhirong Zhang, Eric Erbs, Gagik Yeghiazaryan,
Mar Quiñones, Erwan Grandgirard, Anna Schneider, Etienne Clauss–Creusot,
Alexandre Charlet, et al.

► **To cite this version:**

Kevin Vivot, Gergö Meszaros, Zhirong Zhang, Eric Erbs, Gagik Yeghiazaryan, et al.. CaMK1D signaling in AgRP neurons promotes ghrelin-mediated food intake. 2022. hal-03795873

HAL Id: hal-03795873

<https://hal.science/hal-03795873>

Preprint submitted on 4 Oct 2022

HAL is a multi-disciplinary open access archive for the deposit and dissemination of scientific research documents, whether they are published or not. The documents may come from teaching and research institutions in France or abroad, or from public or private research centers.

L'archive ouverte pluridisciplinaire **HAL**, est destinée au dépôt et à la diffusion de documents scientifiques de niveau recherche, publiés ou non, émanant des établissements d'enseignement et de recherche français ou étrangers, des laboratoires publics ou privés.

1 **CaMK1D signaling in AgRP neurons promotes ghrelin-mediated food intake**

2

3 Kevin Vivot^{1,2,3,4}, Gergö Meszaros^{1,2,3,4}, Zhirong Zhang^{1,2,3,4}, Eric Erbs^{1,2,3,4}, Gagik
4 Yeghiazaryan⁵, Mar Quiñones^{6,7}, Erwan Grandgirard^{1,2,3,4}, Anna Schneider^{1,2,3,4}, Etienne
5 Clauss--Creusot^{4,8}, Alexandre Charlet^{4,8}, Maya Faour⁹, Claire Martin⁹, Serge Luquet⁹, Peter
6 Kloppenburg⁵, Ruben Nogueiras^{6,7}, and Romeo Ricci^{1,2,3,4,10}

7

8

9 ¹Institut de Génétique et de Biologie Moléculaire et Cellulaire, Illkirch 67404, France

10 ²Centre National de la Recherche Scientifique, UMR7104, Illkirch 67404, France

11 ³Institut National de la Santé et de la Recherche Médicale, U964, Illkirch 67404, France

12 ⁴Université de Strasbourg, Strasbourg 67081, France

13 ⁵Biocenter, Institute for Zoology, and Cologne Excellence Cluster on Cellular Stress Responses
14 in Aging-Associated Diseases (CECAD), University of Cologne, Cologne 50674, Germany

15 ⁶Department of Physiology, CIMUS, University of Santiago de Compostela-Instituto de
16 Investigación Sanitaria, Santiago de Compostela 15782, Spain

17 ⁷CIBER Fisiopatología de la Obesidad y Nutrición (CIBERObn), Santiago de Compostela
18 15706, Spain

19 ⁸Centre National de la Recherche Scientifique, Institute of Cellular and Integrative
20 Neurosciences, Strasbourg 67084, France

21 ⁹Université de Paris, CNRS, Unité de Biologie Fonctionnelle et Adaptative, F-75013 Paris,
22 France.

23 ¹⁰Laboratoire de Biochimie et de Biologie Moléculaire, Nouvel Hôpital Civil, Strasbourg
24 67091, France

25 Correspondance: romeo.ricci@igbmc.fr

26 **Abstract**

27 Hypothalamic AgRP/NPY neurons are key players in the control of feeding behavior. Ghrelin,
28 a major hormone released under fasting conditions, activates orexigenic AgRP/NPY neurons
29 to stimulate food intake and adiposity. However, cell-autonomous ghrelin-dependent signaling
30 mechanisms in AgRP/NPY neurons remain poorly defined. Here we demonstrate that
31 calcium/calmodulin-dependent protein kinase ID (CaMK1D), a genetic hot spot in type 2
32 diabetes, is activated in hypothalamus upon ghrelin stimulation and acts in AgRP neurons to
33 promote ghrelin-dependent food intake. Global *CaMK1D* knockout mice are resistant to the
34 orexigenic action of ghrelin, gain less body weight and are protected against high-fat diet-
35 induced obesity. Deletion of *CaMK1D* in AgRP but not in POMC neurons is sufficient to
36 recapitulate above phenotypes. Lack of CaMK1D attenuates phosphorylation of CREB and
37 CREB-dependent expression of the orexigenic neuropeptides AgRP/NPY as well as the
38 amount of AgRP fiber projections to the Paraventricular nucleus (PVN), while electrical
39 activity of AgRP neurons and 5' AMP-activated protein kinase (AMPK) signaling are
40 unaffected. Hence, CaMK1D links ghrelin action to transcriptional control of orexigenic
41 neuropeptide availability in AgRP neurons.

42

43 **Main**

44 Tight regulation of energy homeostasis at multiple levels is instrumental for organisms to cope
45 with changes in food availability. The Central Nervous System (CNS) orchestrates a complex
46 array of processes mediating energy intake and expenditure. Hormonal, neuronal and
47 nutritional signals according to changes in food absorption, energy storage and energy
48 consumption in different organs reach the CNS which in turn triggers corresponding changes
49 in feeding behavior and peripheral cellular metabolism ¹.

50 Sensing of the nutrient status of the organism is governed by distinct neuronal cell populations,
51 particularly within the arcuate nucleus (ARC) of the hypothalamus ². Neurons in this region
52 provide specific projections to other hypothalamic nuclei including the paraventricular nucleus
53 of the hypothalamus (PVN) or to different extrahypothalamic brain regions that in turn
54 coordinate corresponding behavioral responses ³. Conversely, hypothalamic nuclei receive
55 inputs from extrahypothalamic brain regions to control food intake and energy expenditure ⁴.
56 Hypothalamic neurons also obtain signals from the mesolimbic reward system governing
57 “hedonic” aspects of food intake ⁵.

58 Orexigenic neuropeptide Y (NPY) and agouti-related peptide (AgRP)-expressing AgRP/NPY
59 neurons and anorexigenic proopiomelanocortin (POMC)-expressing neurons in the arcuate
60 nucleus of the hypothalamus are primarily involved in the regulation of energy homeostasis.
61 To control appetite and peripheral metabolism, these neurons are regulated by several
62 hormones. Among others, leptin, ghrelin and insulin emerged as key players in this context.
63 Both leptin and insulin receptors are expressed in these neurons and both insulin and leptin
64 have been found to activate POMC and to inhibit AgRP/NPY neurons ⁶. Ghrelin enhances the
65 activity of AgRP/NPY neurons via its receptors, while it decreases the action of POMC neurons
66 through a ghrelin receptor-independent mechanism ⁷.

67 Dysfunction of these neuronal circuits is known to contribute to overnutrition and obesity that
68 eventually culminates in metabolic disorders such as type 2 diabetes (T2D) and/or
69 cardiovascular diseases. Obesity and T2D are interlinked and complex metabolic disorders.
70 Recent Genome-wide association studies (GWAS) and GWAS meta-analyses revealed
71 complex polygenic factors influencing the development of both diseases. In fact more than
72 ~250 genetic loci have been identified for monogenic, syndromic, or common forms of T2D
73 and/or obesity-related traits ^{8,9}. Despite these remarkable advancements, the contribution of
74 most obesity- and T2D-associated single nucleotide polymorphism (SNPs) to the pathogenesis
75 of these diseases remains largely elusive.

76 CDC123 (cell division cycle protein 123)/CaMK1D (calcium/calmodulin-dependent protein
77 kinase ID) represents one such locus on chromosome 10, strongly associated with T2D in
78 European and Asian populations ¹⁰⁻¹². Among other variants, fine mapping identified
79 rs11257655 as the predominant SNP within this locus ¹³. The change from C to T in the
80 enhancer region of the rs11257655 allele, promotes DNA hypomethylation and the binding of
81 the transcription factors FOXA1/FOXA2 on the enhancer region resulting in enhanced
82 CaMK1D gene transcription ^{14,15}. Thus, CaMK1D expression might be enhanced and
83 contributes to the development of T2D.

84 CaMK1D (or CaMK1 δ) is the fourth member of the CaMK1 subfamily. CaMK1 has been
85 described to be ubiquitously expressed at low levels in most tissues. Importantly however,
86 CaMKI proteins are highly expressed in several brain regions, including the cortex,
87 hippocampus, thalamus, hypothalamus, midbrain, and olfactory bulb, with each isoform
88 exhibiting distinct spatiotemporal expression during neuronal development ¹⁶.
89 Ca²⁺/Calmodulin (CaM) binding and subsequent phosphorylation at Thr180 by CaMKK are
90 required for CaMKI activation. In the particular case of CaMK1D, the phosphorylation of

91 CaMK1D by CaMKK, induces a resistance to protein phosphatases, which keeps CaMK1D in
92 a ‘primed’ state, to facilitate its activation in response to Ca²⁺ signals ¹⁷.

93 CaMKIs have been mainly shown to be important in neurons. CaMKIs control neuron
94 morphology ¹⁸ including axonal extension, growth cone motility ¹⁹ and dendritogenesis ²⁰. It
95 has been demonstrated that CaMKIs may also regulate neuronal function by controlling the
96 long-term potentiation, a process involving persistent strengthening of synapses that leads to a
97 long-lasting increase in signal transmission between neurons ²¹. However, specific non-
98 redundant neuronal functions of any of the four members of the CaMKI subfamily including
99 CaMK1D have yet to be determined. In fact, CaMK1D has been shown to be implicated in
100 neutrophil function ²². The genetic association of the *CaMK1D* locus with T2D and correlation
101 of clinical data revealed that CaMK1D might promote pancreatic β cell dysfunction ²³.
102 However, direct experimental evidence for the latter conclusion is lacking thus far. Another
103 study proposed that CaMK1D stimulates hepatic glucose output, a mechanism contributing to
104 T2D ²⁴.

105 Using global and conditional CaMK1D knockout mice, we provide evidence for a role of
106 CaMK1D in central regulation of food intake, while its function seems to be redundant in the
107 liver and in the pancreatic β cell. We demonstrate that CaMK1D acts in hypothalamic AgRP
108 neurons to control food intake in response to ghrelin. While CaMK1D in AgRP neurons is
109 redundant for ghrelin-stimulated increase in electrical neuronal activity and AMPK signaling,
110 its absence impairs ghrelin-induced activatory CREB phosphorylation, AgRP transcription and
111 AgRP/NPY fiber abundance within the PVN. Our data thus unveil ghrelin signaling
112 mechanisms in AgRP neurons downstream or independent of neuronal activation to be
113 necessary for efficient appetite stimulation.

114

115 **Results**

116 **Global deletion of CaMK1D in mice protects against obesity**

117 To understand the function of CaMK1D in metabolism, we generated mice carrying a floxed
118 allele of *CaMK1D* (Figure S1A) and crossed them with the global Cre-deleter, Rosa26-Cre²⁵,
119 to obtain whole-body knockout mice. Western blotting confirmed efficient deletion of
120 CaMK1D in different organs including brain, pancreas and intestine (Figure 1A). Whole-body
121 *CaMK1D* knockout mice (*CaMK1D*^{-/-} mice) were born in expected gender distribution (Figure
122 S1B) and Mendelian ratios (Figure S1C) and developed without overt problems. Body and tibia
123 lengths at 7 weeks of age were equal in *CaMK1D*^{-/-} and *CaMK1D* *WT* mice (*CaMK1D*^{+/+} mice)
124 (Figure S1D and S1E), thus excluding any major postnatal growth defect. However, body
125 weight gain in *CaMK1D*^{-/-} mice on a chow diet was significantly reduced from 16 weeks on
126 after starting to measure weight at the age of 5 weeks as compared to *CaMK1D*^{+/+} mice. This
127 significant difference was exacerbated when obesity was induced in mice on a high fat diet
128 (HFD) at the age of 5 weeks (Figure 1B). Quantitative Nuclear Magnetic Resonance (qNMR)
129 revealed that HFD-fed *CaMK1D*^{-/-} mice compared to *CaMK1D*^{+/+} mice had a reduced fat mass,
130 while there was no significant difference in the lean mass and free body fluid (FBF) (Figure
131 1C). In line with reduced obesity, fasted glucose levels at 10 weeks after HFD feeding in
132 *CaMK1D*^{-/-} mice was significantly reduced as compared to *CaMK1D*^{+/+} mice (Figure 1D). In
133 fact, glucose levels in *CaMK1D*^{-/-} mice on a HFD were similar as in corresponding chow diet-
134 fed mice indicating that they were protected from obesity-induced hyperglycemia. There was
135 no apparent difference in fasting glucose levels between *CaMK1D*^{-/-} and *CaMK1D*^{+/+} mice on
136 a chow diet (Figure 1D). The observed reduced fasting glucose levels correlated with reduced
137 fasting insulin levels (Figure 1E). Glucose tolerance was slightly, but not significantly,
138 improved in *CaMK1D*^{-/-} as compared to *CaMK1D*^{+/+} mice on a chow diet (Figure 1F).
139 However, these differences became significant in mice on a HFD (Figure 1G and 1H). While

140 insulin sensitivity was unaltered in *CaMK1D*^{-/-} mice on a chow diet (Figure 1I), it was
141 significantly improved in *CaMK1D*^{-/-} as compared to *CaMK1D*^{+/+} mice on a HFD (Figure 1J
142 and 1K). Glucose-induced secretion of insulin (GSIS) was slightly but not significantly reduced
143 in *CaMK1D*^{-/-} mice as compared to *CaMK1D*^{+/+} mice on a HFD (Figure S2A). GSIS from
144 isolated islets of *CaMK1D*^{-/-} and *CaMK1D*^{+/+} mice was comparable (Figure S2B).

145 To further exclude a primary role of CaMK1D in the pancreas including β cells, we crossed
146 floxed mice with *PDX1*^{Cre/+} mice²⁶. Western blotting confirmed that deletion of *CaMK1D* in
147 the pancreas was efficient, while no apparent deletion was visible in brain (Figure S2C) or
148 other organs (data not shown). Pancreas-specific *CaMK1D* knockout mice
149 (*PDX1*^{Cre/+};*CaMK1D*^{lox/lox} mice) did not show any differences in body weight gain and
150 glucose tolerance as compared to floxed control mice (*CaMK1D*^{lox/lox} mice) on a chow diet as
151 well as HFD (Figure S2D-F), confirming that CaMK1D is redundant in β cell function.

152 Hepatic insulin resistance leading to increased gluconeogenesis is an important mechanism
153 contributing to obesity-related changes in glucose homeostasis. Therefore, we generated liver-
154 specific knockout mice using *Albumin*^{Cre/+} mice²⁷ (*Alb*^{Cre/+};*CaMK1D*^{lox/lox} mice) and
155 corresponding floxed control mice (*CaMK1D*^{lox/lox} mice). Quantitative reverse transcription
156 PCR (qRT-PCR) confirmed efficient deletion of CaMK1D in the liver (Figure S2G) but not in
157 other organs (data not shown). However, hepatic deletion of *CaMK1D* did not affect body
158 weight gain, glucose tolerance and insulin sensitivity in mice on a chow diet as well as on HFD
159 (Figure S2H-L). Thus, our data exclude any major functions of CaMK1D in pancreatic β cells
160 and liver under both normal and obesity conditions.

161

162 **Global deletion of CaMK1D alters ghrelin-mediated food intake**

163 To further understand reduced body weight gain and fat mass in *CaMKID*^{-/-} mice as compared
164 to *CaMKID*^{+/+} mice, we next explored energy metabolism. In line with reduced obesity,
165 cumulative food intake was decreased in *CaMKID*^{-/-} mice as compared to *CaMKID*^{+/+} mice
166 on a chow diet as well as on HFD reaching significance at 16 weeks after starting to measure
167 it (Figure 2A). Likewise, cumulative food intake in response to 24 hours fasting was
168 significantly reduced in *CaMKID*^{-/-} mice throughout the observed period of refeeding as
169 compared to *CaMKID*^{+/+} mice (Figure 2B). Indirect calorimetry revealed that energy
170 expenditure (Figure 2C and 2D), O₂ consumption (Figure 2E) CO₂ production (Figure 2F) and
171 the respiration exchange rate (RER) (Figure 2G) were equal in *CaMKID*^{-/-} mice as compared
172 to *CaMKID*^{+/+} mice on a HFD. Moreover, the locomotor activity under basal conditions was
173 comparable in *CaMKID*^{-/-} mice and *CaMKID*^{+/+} mice (data not shown). However, locomotor
174 activity of *CaMKID*^{-/-} as compared to *CaMKID*^{+/+} mice was significantly reduced in the night
175 period after 24 hours fasting (Figure 2H and 2I) in line with reduced appetite and reduced
176 seeking for food in response to fasting. Thus, reduced obesity primarily correlated with reduced
177 appetite and food intake.

178 Ghrelin is a gut-derived hormone released in response to fasting and promotes feeding behavior
179 and adiposity²⁸. Given that the resistance to diet-induced obesity of *CaMKID*^{-/-} mice could be
180 explained by reduced food intake, we next wondered whether the ghrelin response was affected
181 in mice lacking *CaMKID*. To this end, we determined cumulative food intake upon
182 intraperitoneal injections of ghrelin in mice on a chow diet. While *CaMKID*^{+/+} mice showed a
183 significant increase in cumulative food intake at 4 and 6 hours after ghrelin injections, such a
184 response was almost absent in *CaMKID*^{-/-} mice (Figure 2J). In contrast, the response to leptin
185 was comparable in *CaMKID*^{+/+} mice and *CaMKID*^{-/-} mice (Figure 2K). Blood levels of
186 acylated ghrelin were significantly higher in *CaMKID*^{-/-} as compared to *CaMKID*^{+/+} mice on
187 a HFD (Figure 2L) in line with an adaptive response to a primary defect in ghrelin action.

188 Conversely, blood levels of leptin were significantly lower in *CaMK1D*^{-/-} mice as compared to
189 *CaMK1D*^{+/+} mice (Figure 2M) on a HFD, correlating well with the degree of obesity.

190 To exclude any major anxiety-like behavior or stress-induced anhedonia, we subjected mice to
191 an open field and to a sucrose preference test, respectively. No major differences between
192 genotypes could be observed (Figure S3A-H). Thus, lack of *CaMK1D* results in a compromised
193 ghrelin response, which is in line with reduced obesity.

194

195 **CaMK1D acts in AgRP neurons to regulate food intake in response to ghrelin**

196 Ghrelin stimulates central neurons to promote feeding. We thus next asked whether CaMK1D
197 in the nervous system was mainly responsible for the observed phenotype in *CaMK1D*^{-/-} mice.
198 We therefore crossed *CaMK1D*^{flox/flox} mice with *Nestin*^{Cre/+} mice resulting in efficient deletion
199 of *CaMK1D* in brain including hypothalamus but not in other organs such as intestine and
200 pancreas (Figure S4A). Indeed, the body weight gain was significantly attenuated in nervous
201 system-specific *CaMK1D* knockout mice (*Nestin*^{Cre/+};*CaMK1D*^{flox/flox} mice) as compared to
202 Cre and floxed control mice (*Nestin*^{Cre/+} mice and *CaMK1D*^{flox/flox} mice) on a chow diet as well
203 as on HFD (Figure S4B). Cumulative food intake was decreased in *Nestin*^{Cre/+};*CaMK1D*^{flox/flox}
204 mice as compared to control mice on a chow diet (Figure S4C) as well as on a HFD (Figure
205 S4D). Likewise, cumulative food intake in response to 24 hours fasting was significantly
206 reduced in *Nestin*^{Cre/+};*CaMK1D*^{flox/flox} mice as compared to control mice after 4, 14 and 24
207 hours of refeeding (Figure S4E). Consistently, while control mice showed a significant increase
208 in cumulative food intake at 4 and 6 hours after ghrelin injections, such a response was absent
209 in *Nestin*^{Cre/+};*CaMK1D*^{flox/flox} mice (Figure S4F).

210 Ghrelin primarily acts on hypothalamic neurons in the arcuate nucleus. In particular, it
211 stimulates NPY/AgRP neurons to promote appetite²⁹. Given our results in nervous system-

212 specific knockout mice, we next asked whether CaMK1D acts in AgRP neurons to control food
213 intake. To this end, we crossed *CaMK1D^{lox/lox}* mice with *AgRP^{Cre/+}* mice resulting in efficient
214 recombination of the *CaMK1D* locus in hypothalamus but not in the brain cortex, liver, tail and
215 white blood cells (Figure 3A). Strikingly, AgRP neuron-specific knockout mice (*AgRP^{Cre/+}*;
216 *CaMK1D^{lox/lox}* mice) gained significantly less weight as compared to Cre and floxed control
217 mice (*AgRP^{Cre/+}* mice and *CaMK1D^{lox/lox}* mice) on a chow diet as well as on HFD (Figure 3B).
218 Similar to nervous system-specific knockout mice, *AgRP^{Cre/+}*; *CaMK1D^{lox/lox}* mice showed
219 significantly less cumulative food intake as compared to control mice on a chow diet (Figure
220 3C) as well as HFD (Figure 3D). Similar significant differences were observed in the
221 cumulative food intake in response to 24 hours fasting (Figure 3E) as well as in response to
222 ghrelin injection (Figure 3F). Importantly, no such differences could be detected when deleting
223 *CaMK1D* in anorexigenic POMC neurons (Figure S5A–F), suggesting that the effects of
224 CaMK1D on food intake are specific to AgRP neurons.

225 To further evaluate a role of CaMK1D in AgRP neuron-dependent energy metabolism, we next
226 performed indirect calorimetry with *AgRP^{Cre/+}*; *CaMK1D^{lox/lox}* mice and control mice on a
227 chow diet. Although the cumulative food intake (Figure 4A) was reduced in
228 *AgRP^{Cre/+}*; *CaMK1D^{lox/lox}* mice as compared to control mice, the locomotor activity (Figure 4B
229 and 4C) was unchanged. Interestingly, energy expenditure (Figure 4D and 4E) was decreased
230 in *AgRP^{Cre/+}*; *CaMK1D^{lox/lox}* mice as compared to control mice. The regression-based analysis-
231 of-covariance (ANCOVA) confirmed that there was a body weight-independent metabolic rate
232 (MR) difference with lower MR in the *AgRP^{Cre/+}*; *CaMK1D^{lox/lox}* relative to the control mice
233 (Figure 4F). In line with these findings, O₂ consumption (Figure 4G) and CO₂ production
234 (Figure 4H) were also reduced, while the respiration exchange rate (RER) (Figure 4I) was
235 equal. Given the overall reduction in body weight gain, reduced energy expenditure was most
236 likely compensatory to compromised energy availability caused by reduced food intake.

237 Altogether, our data thus suggest that CaMK1D acts in AgRP neurons to primarily control food
238 intake in response to ghrelin.

239

240 **Deletion of CaMK1D in mice does not affect AgRP/NPY neuronal activity in response to**
241 **ghrelin.**

242 c-fos expression is used as a marker for neuronal activity³⁰. To understand the function of
243 CaMK1D in ghrelin-induced neuronal activity, we next explored c-fos expression in AgRP
244 neurons in the absence and presence of CaMK1D. Immunofluorescence of c-fos revealed no
245 significant differences in basal and ghrelin-induced expression of c-fos in ARC neurons of
246 *CaMK1D*^{-/-} mice as compared to control mice on a chow diet (Figure 5A and 5B). To verify
247 this finding, we compared the effect of ghrelin on AgRP neurons between both mice lines using
248 perforated patch clamp recordings in brain slices. To identify AgRP neurons, we generated
249 *CaMK1D*^{-/-} and *CaMK1D*^{+/+} mice carrying a EGFP reporter under the control of the *AgRP*
250 promoter (*CaMK1D*^{-/-}-AgRP-EGFP and *CaMK1D*^{+/+}-AgRP-EGFP mice) (Figure 5C). The
251 ghrelin-induced increases in action potential frequency were similar in AgRP neurons of
252 *CaMK1D*^{-/-}-AgRP-EGFP as compared to *CaMK1D*^{+/+}-AgRP-EGFP mice (*CaMK1D*^{+/+}, n=12;
253 *CaMK1D*^{-/-}, n=10, p=0.82) (Figure 5D and 5E). Between the two mouse lines, we also found
254 no significant differences in general intrinsic electrophysiological properties of AgRP neurons
255 such as spontaneous actions potential frequency, input resistance, excitability, and whole-cell
256 capacitance (Figure 5F-I). Taken together, these data suggest that CaMK1D is redundant for
257 ghrelin-stimulated activation of AgRP neurons.

258

259 **Ghrelin activates CaMK1D to induce AgRP/NPY expression and projections in the PVN**

260 Lack of CaMK1D did not affect ghrelin-induced increase in electrical activity of AgRP neurons
261 prompting us to hypothesize that CaMK1D acts downstream or independent of neuronal
262 activity. We thus next asked whether CaMK1D is activated upon ghrelin. We first used Phos-
263 tag gels to address CaMK1D phosphorylation in response to ghrelin in cultured primary
264 hypothalamic cells isolated from *CaMK1D*^{-/-} and *CaMK1D*^{+/+} mice. Indeed, phosphorylated
265 CaMK1D as marked by the upshifted detected band increased upon ghrelin stimulation (Figure
266 6A). Calcium/calmodulin directly activates calcium/calmodulin-dependent protein kinase I by
267 binding to the enzyme and indirectly promotes the phosphorylation and synergistic activation
268 of the enzyme by calcium/calmodulin-dependent protein kinase kinase (CaMKK) ³¹. In line
269 with above findings in cultured neurons, activatory phosphorylation of CaMK1D increased in
270 hypothalamus of ghrelin-stimulated *CaMK1D*^{+/+} mice, while no phosphorylation of CaMK1D
271 or total protein was visible in *CaMK1D*^{-/-} samples (Figure 6B).

272 Ghrelin stimulates AMPK activity in the hypothalamus ³². However, ghrelin-induced AMPK
273 activity was equal in primary hypothalamic neurons of *CaMK1D*^{-/-} and *CaMK1D*^{+/+} mice as
274 shown by assessment of activatory phosphorylation of AMPK and phosphorylation of its target
275 acetyl-CoA carboxylase (ACC) (Figure 6C). Ghrelin-induced cAMP response element (CRE)-
276 binding protein (CREB) phosphorylation promotes expression of AgRP and NPY that mediate
277 the orexigenic action of ghrelin ³³. Interestingly, despite higher basal expression of total CREB,
278 levels of phosphorylated CREB were lower in control treated as well as ghrelin-treated
279 *CaMK1D*^{-/-} cells as compared to *CaMK1D*^{+/+} cells (Figure 6C). Even though activatory
280 phosphorylation of CREB was induced upon ghrelin stimulation in *CaMK1D*^{-/-} cells, ghrelin-
281 induced transcription of AgRP and NPY but not POMC was almost abolished in *CaMK1D*^{-/-}
282 cells (Figure 6D), indicating that the overall reduction of activatory CREB phosphorylation
283 constitutes at least one plausible explanation for reduced CREB-dependent expression of AgRP
284 and NPY. In addition, AgRP immunohistochemistry revealed reduced levels of this neuropeptide in

285 synaptic projections of AgRP neurons located in the PVN of *CaMK1D*^{-/-} mice under
286 stimulatory conditions as compared to control animals (Figure 6E and F). Reduced levels and
287 thus decreased inhibitory action of AgRP and NPY on predominantly anorexigenic neurons in
288 the PVN is thus a likely mechanism underlying reduced food intake and body weight gain
289 despite normal AgRP neuronal activity. Hence, CaMK1D in AgRP neurons is required for
290 CREB-dependent expression of the orexigenic neuropeptides AgRP and NPY, thereby
291 regulating food intake and obesity.

292 **Discussion**

293 A possible role of CaMK1D in obesity and T2D has been predicted based on recent GWAS
294 studies. However, the function of CaMK1D in physiology and metabolic disease *in vivo* was
295 unknown thus far. In our study, using a loss-of-function approach in mice, we discovered an
296 unpredicted role of CaMK1D in central control of food intake. We also excluded a cell-
297 autonomous role of CaMK1D in the liver and pancreas to maintain energy homeostasis.

298 We found that CaMK1D is specifically required in AgRP neurons to promote ghrelin- induced
299 hyperphagia and body weight gain. As genetic studies predicted enhanced expression of
300 CaMK1D to contribute to T2D^{14,15}, our data also fit with a model in which enhanced CaMK1D
301 signaling in AgRP neurons promotes obesity. Deletion of *CaMK1D* in AgRP neurons is
302 sufficient to trigger significant effects on body weight and food intake seen in global *CaMK1D*
303 knockout mice highlighting the importance of CaMK1D signaling in this subpopulation of
304 neurons. In line with this, CaMK1D is activated by ghrelin in NPY/AgRP neurons. Yet, we
305 cannot fully exclude other central functions of CaMK1D signaling that may also contribute to
306 altered body weight gain. Given the fact that AgRP neuron activity has been linked to control
307 of liver glucose production and insulin sensitivity³⁴ as well as nutrient partitioning through
308 dynamic change of the autonomic nervous system³⁵, it is still possible that lack of CaMK1D
309 specifically in AgRP neuron alters insulin and glucose metabolism in addition of the feeding

310 phenotype. Moreover, CaMK1D is widely expressed in the CNS and ghrelin has been reported
311 to act in different hypothalamic and extrahypothalamic areas to induce feeding. Having that
312 said, we showed that CaMK1D is redundant in anorexigenic POMC neurons. Even though
313 deletion of *CaMK1D* in AgRP neurons largely recapitulates phenotypes seen in whole-body
314 knockout mice, this does not fully exclude functions in other organs implicated in energy
315 homeostasis that we did not yet explore.

316 Importantly, CaMK1D is dispensable for ghrelin-stimulated electrical activity of AgRP
317 neurons. This finding is in line with a model in which ghrelin-driven neuronal activity induces
318 membrane depolarization and calcium changes which in turn may trigger CaMK1D activation
319 and CaMK1D-dependent responses including CREB-dependent transcription³⁶. Thus, our
320 study has identified a so far unknown signaling pathway in AgRP neurons that links neuronal
321 activity to CREB-dependent transcription (Figure 6G).

322 CREB-dependent transcription has been shown to regulate fundamental processes in neuronal
323 development, activity-dependent dendritic outgrowth, and synaptic plasticity³⁷. In AgRP
324 neurons, CREB controls transcription of AgRP and NPY³³. In accordance with this finding,
325 we found that ghrelin failed to induce AgRP and NPY transcription in *CaMK1D*-deficient
326 hypothalamus and that the number of AgRP projections to the PVN were reduced. In fact, it
327 has been demonstrated that ghrelin failed to stimulate feeding upon chemical and genetic
328 inhibition of AgRP and NPY^{29,38-41}. Even though AgRP is one of the crucial neuropeptides
329 inhibiting anorexigenic neurons in the PVN, other CREB-dependent functions might be
330 affected in *CaMK1D*-deficient AgRP neurons that may also contribute to the observed
331 metabolic phenotypes to be investigated in the future. Moreover, CaMK1D might also regulate
332 CREB-independent functions that need to be identified.

333 Central ghrelin administration induced AMPK phosphorylation and activation^{42,43} and ghrelin
334 responses could be alleviated through AMPK inhibition⁴⁴. AMPK activation was dependent

335 on calcium changes and on CaMKK 2 activation⁴⁴. CaMKK is also known to activate CaMK1
336 including CaMK1D (Figure 6G). Interestingly, AMPK activation was shown to occur in the
337 ventro-medial nucleus of the hypothalamus (VMH), since adenoviral delivery of a dominant
338 negative isoform of AMPK into the VMH was sufficient to block ghrelin-induced food intake
339⁴³⁻⁴⁵. Therefore, it has been suggested that AgRP/NPY levels in neurons in the ARC are
340 regulated at a presynaptic level by AMPK signaling in neurons of the VMH. We found here
341 that lack of CaMK1D almost entirely abolished the increase in AgRP/NPY transcription in
342 response to ghrelin. Yet, absence of CaMK1D does not affect AMPK signaling in response to
343 ghrelin in the hypothalamus. Given that AgRP neuron-specific deletion of CaMK1D is
344 sufficient to reduce food intake in response to ghrelin, we propose that the transcriptional
345 control of AgRP/NPY expression primarily depends on CaMK1D signaling in AgRP neurons.
346 Whether CaMK1D signaling occurs downstream of AMPK-dependent presynaptic
347 mechanisms remains to be explored. Another possibility is that CaMK1D in AgRP neurons is
348 required to integrate the trophic action of ghrelin. Indeed, neural projections arising from AgRP
349 neurons are fully established during a critical window both during development and in the
350 weeks around birth⁴⁶. Trophic action of ghrelin in that window of development has been show
351 to control ARC AgRP neurons PVN fibers growth and connection⁴⁷. Hence, one can
352 hypothesize that impaired transcriptional regulation of NPY and AgRP in AgRP neurons as a
353 consequence of CaMK1D deletion also led to developmental defects affecting post-natal
354 hypothalamic wiring and leading to altered metabolic control.

355 Elevated levels of cAMP led to CREB phosphorylation at serine 133 and mutation of this site
356 abrogated CREB-dependent reporter gene activation⁴⁸. Protein kinase A (PKA) is a main
357 mediator of cAMP-dependent phosphorylation of CREB. Indeed, ghrelin was shown to
358 increase calcium through the cAMP-PKA pathway in NPY-expressing cells in the ARC of rats
359⁴⁹. However, we observe that phosphorylation of CREB depends, at least partially, on CaMK1D

360 activity. In fact, CREB was shown to be phosphorylated *in vitro* by both kinases, PKA and
361 CaMK1³⁶. Given that phosphorylation is reduced but not abolished in the absence of CaMK1D
362 both kinases might be necessary to exert robust CREB phosphorylation in response to ghrelin.
363 mTOR-S6K1 signaling has also been demonstrated to be involved in hypothalamic regulation
364 of food intake in response to ghrelin through regulation of CREB phosphorylation and
365 AgRP/NPY expression^{50,51}. However, it is unclear so far how and in which neurons mTOR-
366 S6K1 regulates ghrelin responses. In fact, mTORC1 signaling in AgRP neurons was shown to
367 control circadian expression of AgRP and NPY but was redundant for regulation of food intake
368⁵².

369 Altogether, we uncovered a signaling mechanism that acts in AgRP neurons to control levels
370 of AgRP and NPY, two main orexigenic neuropeptides centrally involved in promoting food
371 intake. Uncontrolled CaMK1D signaling in AgRP neurons represents thus a valuable
372 mechanism promoting obesity and T2D.

373 **Methods**

374 **Animals Care**

375 Animal care and all experimental procedures done in this study were approved by the local
376 ethical committee (Com'Eth) in compliance with the French and European legislation on care
377 and use of laboratory animals (APAFIS#18638-2019012510177514v4). Mice were
378 individually housed under controlled temperature at 22°C on a 12H light/dark cycle with
379 unrestricted access to water and prescribed diet. Food was only withdrawn if required for an
380 experiment. Body weight and food intake were determined weekly. Animals were fed with
381 regular chow diet (CD) or high fat diet (HFD). CD contains 73.6% calories from carbohydrates,
382 18.1% calories from protein, and 8.4% calories from fat (SAFE® D04 from Safe) and HFD
383 contains 20% calories from carbohydrates, 20% calories from protein, and 60% calories from

384 fat (D12492i from Research diet®). For all experiments only male mice were used. All
385 experiments were performed in adult mice at the age between 5-25 weeks.

386

387 **Generation of Transgenic Mice**

388 *CaMK1D* conditional knockout and global knockout mice were generated according to the
389 “knockout first“ strategy by the Institut Clinique de la Souris (ICS, Illkirch-Graffenstaden,
390 France). 5’ of exon 4 of the *CaMK1D* gene a SA-βGeo-pA trapping cassette was inserted
391 flanked by two FRT sites, which disrupts gene function (“knockout first” allele and L3 mice).
392 Furthermore, two LoxP sites were inserted 5’ and 3’ of exon 4. The FRT-recombinase (Flp)
393 converted the “knockout first” allele to a conditional allele (*CaMK1D^{lox/lox}*), restoring gene
394 activity (Fig S1A). The sequences of the primers used to genotype the mice and to verify Cre-
395 mediated recombination are provided in Table S1. *CaMK1D^{lox/lox}* mice were mated with
396 Rosa26-Cre mice expressing Cre recombinase under control of the Rosa26 promoter (for global
397 knockout) (Soriano, 1999) resulting in the deletion of the floxed exon. The breeding colonies
398 were maintained by mating hemizygote *CaMK1D^{+/-}* females to hemizygote *CaMK1D^{+/-}* males.
399 Mice were on a C57BL/6 N/J mixed background. Tissue-specific deletion of *CaMK1D* was
400 obtained by mating floxed mice with transgenic mice expressing Cre recombinase under the
401 control of a tissue-specific promoter and breeding colonies were maintained by mating tissue-
402 specific promoterCre/+;*CaMK1D^{lox/+}* to *CaMK1D^{lox/+}* mice. All Mice were on a C57BL/6 N/J
403 mixed background. All cre deleter mouse lines are listed in the STAR methods section.

404

405 **Blood collection and biochemical measurements**

406 Blood samples obtained from the tail and collected in heparinized capillaries were used to
407 measure fasted blood glucose and insulin levels. Animals were fasted at 8 am, and the samples
408 were collected 4 hours later. At the end of the experiment, blood was collected from the retro

409 orbital sinus, put into tubes containing 0.2 μ M EDTA and 4 mM Pefabloc® SC, and centrifuged
410 for 15 minutes at 3,000 g to separate the plasma. Plasma was stored at -80°C . Acylated Ghrelin
411 Leptin and Insulin were measured by ELISA.

412

413 **Glucose and Insulin Tolerance Assays**

414 GTT: After a 16H fast, animals were injected i.p. with 2 g/kg (animals on CD) or 1 g/kg
415 (animals on HFD) dextrose in 0.9% NaCl. Blood glucose was measured prior to and 15, 30,
416 45, 60, 90, and 120 minutes after injections. Blood glucose values were determined in a drop
417 of blood sampled from the tail using an automatic glucose monitor (Accu-Check; Roche
418 Applied Science). Plasma samples were collected at 0, 15, 30 minutes for insulin
419 measurements.

420

421 ITT: After a 5-hour fast, animals were injected i.p. with 0.75 IU/kg recombinant human insulin
422 (Umluline; Lilly®). Blood glucose levels were measured before and 15, 30, 40, 60 and 90
423 minutes after injections. The glucose disappearance rate for the ITT (kITT)
424 (percentage/minute) was calculated using the formula as previously described⁵³. $kITT = 0.693$
425 $\times 100 / t_{1/2}$, where $t_{1/2}$ was calculated from the slope of the plasma glucose concentration,
426 considering an exponential decrement of glucose concentration during the 30 minutes after
427 insulin administration.

428

429 **Automated Cages Phenotyping for indirect calorimetric measurements**

430 Twenty-five weeks old mice were acclimated in metabolic chambers (TSE LabMaster System
431 - Metabolic Phenotyping Facility, ICS) for 1 day before the start of the recordings. Mice were
432 continuously recorded for 1 or 2 days with measurements of locomotor activity (in the xy- and
433 z-axes), and gas exchange (O_2 and CO_2) every 30 min. Energy expenditure was calculated

434 according to the manufacturer's guidelines (PhenoMaster Software, TSE System). The
435 respiratory quotient was estimated by calculating the ratio of CO₂ production to O₂
436 consumption. Values were corrected by metabolic mass (lean mass + 0.2 fat mass) as
437 previously described⁵⁴. ANCOVA analysis was done as previously described⁵⁵.

438

439 **Animal length and body composition**

440 Animal length was assessed with X-Ray MX-20 Specimen (Faxitron - Metabolic Phenotyping
441 Facility, ICS). Digital X-ray pictures allowed the measurement of whole body and tibia size of
442 mice. Body composition was evaluated by Quantitative Nuclear Magnetic Resonance (qNMR)
443 using Minispec⁺ analyzer (Bruker BioSpin S.A.S., Metabolic Phenotyping Facility, ICS).

444

445 **Leptin/ghrelin responsiveness**

446 To assess leptin sensitivity, mice received an i.p. injection of either PBS or mouse recombinant
447 leptin (3 mg/kg) 24H after food withdrawal, their food intake were monitored 4 and 6H
448 following the injections. The food intake after PBS injection was compared with the food intake
449 after leptin administration. The orexigenic response to ghrelin was determined in mice that
450 received an i.p injection of either PBS or ghrelin (1 mg/kg). Food intake was assessed 4H and
451 6H after injections.

452

453 **Culture of primary cells of hypothalamus**

454 Hypothalamus were dissected from E15.5 embryos and stored on ice in Neurobasal medium
455 (GIBCO). Tissues were incubated for 20 min in a 37°C water bath in 100U/ml papain
456 (Worthington) and 10mg/ml DNase I (Worthington). Digestion was stopped with
457 Ovomucoïde (Worthington). Tissues were transferred into 1 ml of adult neuronal growth
458 medium consisting of Neurobasal-A medium, 3mM L-glutamine (Gibco) , 1x B-27

459 supplement, 1x N2 supplement and antibiotics. Tissues were gently triturated until uniform
460 cellular dissociation was achieved. Cells were counted and plated into cell culture plates coated
461 with poly-L-lysine (Gibco).

462

463 **Western blotting**

464 Cells were washed with ice-cold PBS on ice and snap-frozen in liquid nitrogen. Cell lysates for
465 WB were prepared using 1x Laemmli buffer (50 mM Tris-HCl pH6.8, 100 mM DTT, 8% SDS,
466 0,01% bromophenol blue, 10% glycerol) supplemented with phosphatase/protease inhibitors
467 (Cell Signaling Technology) and incubated on ice for 10 minutes. After centrifugation at 16
468 000 g for 10 minutes at 4°C cleared supernatant was transferred to the new tubes and was used
469 immediately stored at -80°C until used. Total protein was measured using the BCA method by
470 Pierce™ BCA Protein Assay Kit (ThermoFisher). Samples (20-50 µg of total protein content)
471 were boiled and resolved on 10% acrylamide gels using standard Tris-Glycine SDS-PAGE or
472 Phostag gels. Proteins were transferred to PVDF membranes (Millipore) and blotted with
473 antibodies listed in the Antibodies section. For membrane blocking and primary antibody
474 dilution 5% BSA (w/v) in TBST was used. All incubations with primary antibodies were
475 performed for 16 hours at 4°C. Blots were developed using SuperSignal West Pico (Pierce,
476 Ref. 34580) or Luminata Forte Western HRP substrate (Merck Millipore, Ref. WBLUF0500).

477

478 **Hypothalamic mRNA quantification**

479 Total RNA from hypothalamus was extracted using an RNeasy Lipid Tissue Mini Kit
480 (QIAGEN) and quantified spectrophotometrically. Single-stranded cDNA was synthesized
481 using SuperScript IV RNase Reverse Transcriptase (Invitrogen) according to the
482 manufacturer's directions. Real-time PCR was carried out using an LightCycler® 480 (Roche)

483 with Fast SYBR® Green Master Mix (Roche) and the primers listed in the primers section.
484 Quantifications were done according the Pfaffl method ⁵⁶.

485

486 **Immunohistochemistry**

487 Mediobasal hypothalamic sections from brains were prefixed with paraformaldehyde during
488 24h and incubated in 30% sucrose (Fisher Scientific) 24H at 4°C. Brains were embedded in
489 OCT, frozen at -80°C and stored at -80°C. 30 µm-thick sections were cut with a cryostat (Leica
490 CM3050 S, France), stored at 4°C in sodium phosphate buffer. Sections were processed as
491 follows: Day 1: free-floating sections were rinsed in PBS, incubated for 20 min in PBS
492 containing 0.3% Tween-20, and then rinsed three times for 10 min each in PBS. Slices were
493 incubated 1h with 5% donkey serum in 0.3% PBS-T and then overnight or 72H at 4°C with the
494 primary antibodies described in the antibodies section. Slides were rinsed three times for 10
495 min in 0.3% PBS-T and incubated for 60 min with secondary antibodies. Sections were rinsed
496 three times for 10 min in PBS before mounting. Tissues were observed on a confocal laser
497 scanning microscope , TCS SP8X; with Leica software LAS X navigator, using a HC PL APO
498 CS2 20x /0.75 dry leica objective. The objectives and the pinhole setting (1 airy unit, au)
499 remained unchanged during the acquisition of a series for all images. Quantification of
500 immuno-positive cells was performed using the cell counter plugin of the ImageJ software
501 taking as standard reference a fixed threshold of fluorescence.

502

503 **Electrophysiology**

504 Experiments were performed on brain slices from 9-12 week old male CaMK1D^{+/+} and
505 CaMK1D^{-/-} mice that expressed enhanced green fluorescent protein (EGFP) selectively in
506 AgRP neurons. Animals were kept under standard laboratory conditions, with tap water and
507 chow available ad libitum, on a 12h light/dark cycle. The animals were lightly anesthetized

508 with isoflurane (B506; AbbVie Deutschland GmbH and Co KG, Ludwigshafen, Germany) and
509 decapitated. Coronal slices (280 μ m) containing the arcuate nucleus of the hypothalamus were
510 cut with a vibration microtome (VT1200 S; Leica, Germany) under cold (4°C), carbogenated
511 (95% O₂ and 5% CO₂), glycerol-based modified artificial cerebrospinal fluid (GaCSF) ⁵⁷.
512 Current-clamp recordings of GFP-expressing AgRP neurons were performed at ~32°C.
513 Neurons were visualized with a fixed stage upright microscope (Zeiss AxioExaminer, Zeiss,
514 Germany) using 40x water-immersion objective (W Plan-Apochromat 40x/1.0 DIC M27, 1
515 numerical aperture, 2.5 mm working distance; Zeiss) with infrared differential interference
516 contrast optics ⁵⁸ and fluorescence optics. GFP-expressing AgRP neurons were identified by
517 their anatomical location in the arcuate nucleus and by their fluorescent label.
518 Perforated patch experiments were conducted using protocols modified from ⁵⁹ and ⁶⁰.
519 The spontaneous firing frequency was measured for 5 min after perforation. To measure
520 intrinsic electrophysiological properties series of hyperpolarizing and depolarizing current
521 pulses were applied under current clamp from a membrane potential of ~-70 mV. For input
522 resistance and capacitance measurements, hyperpolarizing current steps with -2 pA increments
523 were applied. For excitability measurements, depolarizing 1 s current steps with +2 pA
524 increments were applied. The specific protocols are given in Results.
525 To investigate the modulatory effect of ghrelin (031-31, Phoenix Pharmaceuticals), 100 nM
526 ghrelin was bath applied for 8-10 min. The ghrelin effect was analyzed by comparing the action
527 potential frequencies that were measured during 2 min intervals that were recorded directly
528 before and at the end of the peptide applications.

529 **Data analysis of electrophysiological data**

530 Data analysis was performed with Spike2 (version 7; Cambridge Electronic Design Ltd.,
531 Cambridge, UK), Igor Pro 6 (Wavemetrics, Portland, OR, USA), and Graphpad Prism 8. If not
532 stated otherwise, all calculated values are expressed as means \pm SEM (standard error of the

533 mean). The horizontal lines show the data's median. The whiskers were calculated according
534 to the 'Tukey' method. For comparisons of independent nonparametric distributions, the
535 Mann-Whitney-U-test was used. Linear regressions were compared using the F-test. A
536 significance level of 0.05 was accepted for all tests. Exact p-values are reported if $p > 0.05$. In
537 the figures, n values are given in brackets.

538

539 **Quantification and statistical analysis**

540 All statistical comparisons were performed with Prism 6 (GraphPad Software, La Jolla, CA,
541 USA) or R software for ANCOVA analysis. The statistical tests used are listed along with the
542 statistical values in the Supplemental Tables. All the data were analyzed using either Student t
543 test (paired or unpaired) with equal variances or One-way ANOVA or Two-way ANOVA. In
544 all cases, significance threshold was automatically set at $p < 0.05$. ANOVA analyses were
545 followed by Bonferroni post hoc test for specific comparisons only when overall ANOVA
546 revealed a significant difference (at least $p < 0.05$).

547

548 **References**

- 549 1. Kim, K.-S., Seeley, R. J. & Sandoval, D. A. Signalling from the periphery to the brain
550 that regulates energy homeostasis. *Nat. Rev. Neurosci.* **19**, 185–196 (2018).
- 551 2. Jais, A. & Brüning, J. C. Arcuate nucleus-dependent regulation of metabolism -
552 pathways to obesity and diabetes mellitus. *Endocr Rev* bna025 (2021)
553 doi:10.1210/endrev/bna025.
- 554 3. Morton, G. J., Cummings, D. E., Baskin, D. G., Barsh, G. S. & Schwartz, M. W.
555 Central nervous system control of food intake and body weight. *Nature* **443**, 289–295 (2006).
- 556 4. Waterson, M. J. & Horvath, T. L. Neuronal Regulation of Energy Homeostasis:
557 Beyond the Hypothalamus and Feeding. *Cell Metab.* **22**, 962–970 (2015).
- 558 5. Stuber, G. D. & Wise, R. A. Lateral hypothalamic circuits for feeding and reward. *Nat*
559 *Neurosci* **19**, 198–205 (2016).
- 560 6. Timper, K. & Brüning, J. C. Hypothalamic circuits regulating appetite and energy
561 homeostasis: pathways to obesity. *Dis Model Mech* **10**, 679–689 (2017).
- 562 7. Chen, S.-R. *et al.* Ghrelin receptors mediate ghrelin-induced excitation of agouti-
563 related protein/neuropeptide Y but not pro-opiomelanocortin neurons. *J. Neurochem.* **142**,
564 512–520 (2017).
- 565 8. Bonnefond, A. & Froguel, P. Rare and common genetic events in type 2 diabetes:
566 what should biologists know? *Cell Metab.* **21**, 357–368 (2015).

- 567 9. Locke, A. E. *et al.* Genetic studies of body mass index yield new insights for obesity
568 biology. *Nature* **518**, 197–206 (2015).
- 569 10. Kooner, J. S. *et al.* Genome-wide association study in individuals of South Asian
570 ancestry identifies six new type 2 diabetes susceptibility loci. *Nat. Genet.* **43**, 984–989
571 (2011).
- 572 11. Shu, X. O. *et al.* Identification of new genetic risk variants for type 2 diabetes. *PLoS*
573 *Genet.* **6**, e1001127 (2010).
- 574 12. Zeggini, E. *et al.* Meta-analysis of genome-wide association data and large-scale
575 replication identifies additional susceptibility loci for type 2 diabetes. *Nature genetics* **40**,
576 638–45 (2008).
- 577 13. Morris, A. P. *et al.* Large-scale association analysis provides insights into the genetic
578 architecture and pathophysiology of type 2 diabetes. *Nat. Genet.* **44**, 981–990 (2012).
- 579 14. Thurner, M. *et al.* Integration of human pancreatic islet genomic data refines
580 regulatory mechanisms at Type 2 Diabetes susceptibility loci. *Elife* **7**, (2018).
- 581 15. Xue, A. *et al.* Genome-wide association analyses identify 143 risk variants and
582 putative regulatory mechanisms for type 2 diabetes. *Nat Commun* **9**, 2941 (2018).
- 583 16. Kamata, A. *et al.* Spatiotemporal expression of four isoforms of Ca²⁺/calmodulin-
584 dependent protein kinase I in brain and its possible roles in hippocampal dendritic growth.
585 *Neurosci. Res.* **57**, 86–97 (2007).
- 586 17. Senga, Y., Ishida, A., Shigeri, Y., Kameshita, I. & Sueyoshi, N. The Phosphatase-
587 Resistant Isoform of CaMKI, Ca²⁺/Calmodulin-Dependent Protein Kinase I δ (CaMKI δ),
588 Remains in Its ‘Primed’ Form without Ca²⁺ Stimulation. *Biochemistry* **54**, 3617–3630 (2015).
- 589 18. Buchser, W. J., Slepak, T. I., Gutierrez-Arenas, O., Bixby, J. L. & Lemmon, V. P.
590 Kinase/phosphatase overexpression reveals pathways regulating hippocampal neuron
591 morphology. *Mol. Syst. Biol.* **6**, 391 (2010).
- 592 19. Wayman, G. A. *et al.* Regulation of axonal extension and growth cone motility by
593 calmodulin-dependent protein kinase I. *J. Neurosci.* **24**, 3786–3794 (2004).
- 594 20. Takemoto-Kimura, S. *et al.* Regulation of dendritogenesis via a lipid-raft-associated
595 Ca²⁺/calmodulin-dependent protein kinase CLICK-III/CaMKI γ . *Neuron* **54**, 755–770
596 (2007).
- 597 21. Schmitt, J. M., Guire, E. S., Saneyoshi, T. & Soderling, T. R. Calmodulin-dependent
598 kinase kinase/calmodulin kinase I activity gates extracellular-regulated kinase-dependent
599 long-term potentiation. *J. Neurosci.* **25**, 1281–1290 (2005).
- 600 22. Verploegen, S. *et al.* Characterization of the role of CaMKI-like kinase (CKLiK) in
601 human granulocyte function. *Blood* **106**, 1076–1083 (2005).
- 602 23. Simonis-Bik, A. M. *et al.* Gene variants in the novel type 2 diabetes loci
603 CDC123/CAMK1D, THADA, ADAMTS9, BCL11A, and MTNR1B affect different aspects
604 of pancreatic beta-cell function. *Diabetes* **59**, 293–301 (2010).
- 605 24. Haney, S. *et al.* RNAi screening in primary human hepatocytes of genes implicated in
606 genome-wide association studies for roles in type 2 diabetes identifies roles for CAMK1D
607 and CDKAL1, among others, in hepatic glucose regulation. *PLoS ONE* **8**, e64946 (2013).
- 608 25. Soriano, P. Generalized lacZ expression with the ROSA26 Cre reporter strain. *Nat*
609 *Genet* **21**, 70–71 (1999).
- 610 26. Gu, G., Dubauskaite, J. & Melton, D. A. Direct evidence for the pancreatic lineage:
611 NGN3⁺ cells are islet progenitors and are distinct from duct progenitors. *Development* **129**,
612 2447–2457 (2002).
- 613 27. Postic, C. *et al.* Dual roles for glucokinase in glucose homeostasis as determined by
614 liver and pancreatic beta cell-specific gene knock-outs using Cre recombinase. *J Biol Chem*
615 **274**, 305–315 (1999).
- 616 28. Müller, T. D. *et al.* Ghrelin. *Mol Metab* **4**, 437–460 (2015).

- 617 29. Andrews, Z. B. *et al.* UCP2 mediates ghrelin's action on NPY/AgRP neurons by
618 lowering free radicals. *Nature* **454**, 846–851 (2008).
- 619 30. Hoffman, G. E., Smith, M. S. & Verbalis, J. G. c-Fos and related immediate early
620 gene products as markers of activity in neuroendocrine systems. *Front Neuroendocrinol* **14**,
621 173–213 (1993).
- 622 31. Haribabu, B. *et al.* Human calcium-calmodulin dependent protein kinase I: cDNA
623 cloning, domain structure and activation by phosphorylation at threonine-177 by calcium-
624 calmodulin dependent protein kinase I kinase. *EMBO J* **14**, 3679–3686 (1995).
- 625 32. Andersson, U. *et al.* AMP-activated protein kinase plays a role in the control of food
626 intake. *J Biol Chem* **279**, 12005–12008 (2004).
- 627 33. Sakkou, M. *et al.* A role for brain-specific homeobox factor Bsx in the control of
628 hyperphagia and locomotory behavior. *Cell Metab* **5**, 450–463 (2007).
- 629 34. Könnner, A. C. *et al.* Insulin action in AgRP-expressing neurons is required for
630 suppression of hepatic glucose production. *Cell Metab* **5**, 438–449 (2007).
- 631 35. Denis, R. G. P. *et al.* Central orchestration of peripheral nutrient partitioning and
632 substrate utilization: implications for the metabolic syndrome. *Diabetes Metab* **40**, 191–197
633 (2014).
- 634 36. Sheng, M., Thompson, M. A. & Greenberg, M. E. CREB: a Ca(2+)-regulated
635 transcription factor phosphorylated by calmodulin-dependent kinases. *Science* **252**, 1427–
636 1430 (1991).
- 637 37. Flavell, S. W. & Greenberg, M. E. Signaling mechanisms linking neuronal activity to
638 gene expression and plasticity of the nervous system. *Annu Rev Neurosci* **31**, 563–590
639 (2008).
- 640 38. Aponte, Y., Atasoy, D. & Sternson, S. M. AGRP neurons are sufficient to orchestrate
641 feeding behavior rapidly and without training. *Nat Neurosci* **14**, 351–355 (2011).
- 642 39. Chen, H. Y. *et al.* Orexigenic action of peripheral ghrelin is mediated by neuropeptide
643 Y and agouti-related protein. *Endocrinology* **145**, 2607–2612 (2004).
- 644 40. Luquet, S., Perez, F. A., Hnasko, T. S. & Palmiter, R. D. NPY/AgRP neurons are
645 essential for feeding in adult mice but can be ablated in neonates. *Science* **310**, 683–685
646 (2005).
- 647 41. Nakazato, M. *et al.* A role for ghrelin in the central regulation of feeding. *Nature* **409**,
648 194–198 (2001).
- 649 42. Kola, B. *et al.* Cannabinoids and ghrelin have both central and peripheral metabolic
650 and cardiac effects via AMP-activated protein kinase. *J Biol Chem* **280**, 25196–25201 (2005).
- 651 43. López, M. *et al.* Hypothalamic fatty acid metabolism mediates the orexigenic action
652 of ghrelin. *Cell Metab* **7**, 389–399 (2008).
- 653 44. Anderson, K. A. *et al.* Hypothalamic CaMKK2 contributes to the regulation of energy
654 balance. *Cell Metab.* **7**, 377–388 (2008).
- 655 45. García, A., Alvarez, C. V., Smith, R. G. & Diéguez, C. Regulation of Pit-1 expression
656 by ghrelin and GHRP-6 through the GH secretagogue receptor. *Mol Endocrinol* **15**, 1484–
657 1495 (2001).
- 658 46. Bouret, S. G., Draper, S. J. & Simerly, R. B. Formation of projection pathways from
659 the arcuate nucleus of the hypothalamus to hypothalamic regions implicated in the neural
660 control of feeding behavior in mice. *J Neurosci* **24**, 2797–2805 (2004).
- 661 47. Stecutorum, S. M. *et al.* Neonatal ghrelin programs development of hypothalamic
662 feeding circuits. *J Clin Invest* **125**, 846–858 (2015).
- 663 48. Gonzalez, G. A. & Montminy, M. R. Cyclic AMP stimulates somatostatin gene
664 transcription by phosphorylation of CREB at serine 133. *Cell* **59**, 675–680 (1989).
- 665 49. Kohno, D., Gao, H.-Z., Muroya, S., Kikuyama, S. & Yada, T. Ghrelin directly
666 interacts with neuropeptide-Y-containing neurons in the rat arcuate nucleus: Ca²⁺ signaling

- 667 via protein kinase A and N-type channel-dependent mechanisms and cross-talk with leptin
668 and orexin. *Diabetes* **52**, 948–956 (2003).
- 669 50. Martins, L. *et al.* Hypothalamic mTOR signaling mediates the orexigenic action of
670 ghrelin. *PLoS One* **7**, e46923 (2012).
- 671 51. Stevanovic, D. *et al.* Ghrelin-induced food intake and adiposity depend on central
672 mTORC1/S6K1 signaling. *Mol Cell Endocrinol* **381**, 280–290 (2013).
- 673 52. Albert, V., Cornu, M. & Hall, M. N. mTORC1 signaling in *Agrp* neurons mediates
674 circadian expression of *Agrp* and NPY but is dispensable for regulation of feeding behavior.
675 *Biochem Biophys Res Commun* **464**, 480–486 (2015).
- 676 53. Lundbaek, K. Intravenous glucose tolerance as a tool in definition and diagnosis of
677 diabetes mellitus. *Br Med J* **1**, 1507–1513 (1962).
- 678 54. Even, P. C. & Nadkarni, N. A. Indirect calorimetry in laboratory mice and rats:
679 principles, practical considerations, interpretation and perspectives. *Am J Physiol Regul*
680 *Integr Comp Physiol* **303**, R459–476 (2012).
- 681 55. Müller, T. D., Klingenspor, M. & Tschöp, M. H. Revisiting energy expenditure: how
682 to correct mouse metabolic rate for body mass. *Nat Metab* **3**, 1134–1136 (2021).
- 683 56. Pfaffl, M. W. A new mathematical model for relative quantification in real-time RT-
684 PCR. *Nucleic Acids Res* **29**, e45 (2001).
- 685 57. Ye, J. H., Zhang, J., Xiao, C. & Kong, J.-Q. Patch-clamp studies in the CNS illustrate
686 a simple new method for obtaining viable neurons in rat brain slices: glycerol replacement of
687 NaCl protects CNS neurons. *J Neurosci Methods* **158**, 251–259 (2006).
- 688 58. Dodt, H. U. & Zieglgänsberger, W. Visualizing unstained neurons in living brain
689 slices by infrared DIC-videomicroscopy. *Brain Res* **537**, 333–336 (1990).
- 690 59. Horn, R. & Marty, A. Muscarinic activation of ionic currents measured by a new whole-
691 cell recording method. *J Gen Physiol* **92**, 145–159 (1988).
- 692 60. Akaike, N. & Harata, N. Nystatin perforated patch recording and its applications to
693 analyses of intracellular mechanisms. *Jpn J Physiol* **44**, 433–473 (1994).

694

695 **Acknowledgments**

696 We thank T. Alquier at University of Montreal, E. Pangou and D. Dembele at the IGBMC for
697 helpful discussions. We thank the Imaging Center of the IGBMC (ICI) and the IGBMC core
698 facilities for their support on this research. We are grateful to F. Berditchevski at Nottingham
699 University for the pS179/Thr180 CaMK1D antibody. This work was supported by the Agence
700 Nationale de la Recherche (ANR) (AAPG 2017 LYSODIABETES and AAPG 2021
701 HypoCaMK)), by the Fondation de Recherche Médicale (FRM) – Program: Equipe FRM
702 (EQU201903007859, Prix Roger PROPICE pour la recherche sur le cancer du pancréas), by
703 the FHU-OMAGE of region Grand-Est, from the European Foundation for the Study of
704 Diabetes (EFSD)/Novo Nordisk Diabetes Research Programme and by the ANR-10-LABX-
705 0030-INRT grant as well as the ANR-11-INBS-0009-INGESTEM grant, both French State

706 funds managed by the ANR under the frame program Investissements d’Avenir. K. Vivot was
707 supported by an Individual Fellowship (798961 INSULYSOSOME) in the framework of the
708 Marie-Sklodovska Curie actions of the European Commission. G. Yeghiazaryan received
709 financial doctoral support from DFG-233886668/RTG1960.

710 **Author contributions**

711 Conceptualization: R.R., R.P.N, P.K and S.L., Software: E.G., Methodology: K.V., Z.Z, G.Y.,
712 E.E., E.C.C. and M.Q, Validation: K.V., Formal Analysis: K.V., C.M., Investigation: K.V.,
713 G.M., Z.Z., E.E., G.Y., M.Q., A.S., M.F and C.M., Resources: E.E., Writing-Original Draft:
714 R.R. and K.V., Supervision: S.L., P.K., R.P.R., A.C., and R.R, Funding Acquisition: R.R. and
715 S.L.

716

717 **Figure legends**

718 **Figure 1. Global Deletion of *CaMK1D* gene reduces obesity in mice.** (A) Expression of
719 CaMK1D protein in different tissues as indicated. Tissues from the wild type (*CaMK1D*^{+/+}) and
720 whole-body *CaMK1D* knockout (*CaMK1D*^{-/-}) mice were analyzed for CaMK1D expression by
721 western blot. (B) Body weight gain of mice with indicated genotypes fed with a Chow diet (CD)
722 or a High Fat Diet (HFD). (n=9 to 11/ group). (C) Body composition of mice with indicated
723 genotypes fed with a HFD measured by qNMR. (n=9/ group) (*p ≤ 0.05) (FBF = free body fluid).
724 (D) 4 hours fasted blood glucose levels at indicated time points. (n=8 to 10 / group). (E) 4 hours
725 fasted plasma insulin levels at indicated time points. (n=9 to 11 / group). (F-H) Blood glucose levels
726 during an IPGTT in mice with the indicated genotypes and diets. IPGTT was performed after an
727 overnight food withdrawal. Corresponding areas Under the Curve (AUC) are depicted. (n=9 to 12
728 / group). (I-K) Blood glucose levels during ITT in mice with the indicated genotypes and diets.

729 IPGTTs were performed after a 4H food withdrawal. kITTs obtained from ITT are depicted. (n=6
730 to 10 / group).

731 *p < 0.05 and **p < 0.01. Statistical tests included two-way ANOVA (B, H and J) and unpaired
732 Student's t test (C, D, E, H and K).

733

734 **Figure 2. Deletion of *CaMK1D* attenuates ghrelin-induced food intake.** (A) Cumulative food
735 intake from mice with indicated genotypes and diets. (n=9 to 11 / group). (B) Cumulative food
736 intake from mice with indicated genotypes on a HFD. Food intake was determined 24H after food
737 withdrawal. (n=12 to 17 / group). (C) Energy expenditure, (D) Regression-based analysis of
738 absolute MR against body mass. The ANCOVA analysis was done with MR as a dependent
739 variable, the genotype as a fixed variable and body mass as a covariate. (E) consumed O₂, (F)
740 produced CO₂ and (G) the respiratory exchange ratio (RER) in HFD fed control (*CaMK1D*^{+/+}) and
741 whole body *CaMK1D* knockout (*CaMK1D*^{-/-}) mice (n=9 / group). (H-I) Ambulatory activity over
742 24H. Ambulatory activity was measured with mice deprived from food for 24H. AUC from 5PM
743 to 11PM was calculated (n=6 / group). (J) Cumulative food intake after ghrelin injections (30 µg /
744 day) of mice with indicated genotypes on a chow diet. (n=6 to 7 / group). (K) Cumulative food
745 intake after leptin injections (3mg / kg) of mice with indicated genotypes on a chow diet. Food
746 intake was determined 24H after food withdrawal. (n=6 to 7 / group).

747 (L) Blood acylated Ghrelin and (M) Blood Leptin levels in mice with indicated genotypes on a
748 HFD. Blood sampling was performed 4H after food withdrawal. (N=5 to 8 / group).

749 *p < 0.05 and **p < 0.01. Statistical tests included two-way ANOVA (A, B), ANCOVA (D) and
750 unpaired Student's t test (I,J,K,L,M).

751 **Figure 3. Conditional deletion of *CaMK1D* in AgRP neurons leads to reduced body weight
752 gain and food intake.** (A) Verification of recombination in the *CaMK1D* locus in hypothalamus
753 (Hyp), cortex (Ctx), liver, tail and white blood cells (WBC) from mice with indicated genotypes.

754 DNA from tissues were analyzed by PCR with primers amplifying either recombined or floxed
755 alleles, respectively. (B) Body weight gain of mice with indicated genotypes on a Chow diet (CD)
756 or on a High Fat Diet (HFD). (n=10 to 15/ group).
757 (C-D) Cumulative food intake of mice with indicated genotypes fed on Chow diet or on high fat
758 diet. (n=10 to 15 / group). (E) Cumulative food intake of mice with indicated genotypes and diets.
759 Food intake was determined 24H after fasting. (n=12 to 17 / group). (F) Cumulative food intake
760 after ghrelin injections of mice with indicated genotypes and diets. (n=6 to 7 / group).
761 *p < 0.05, **p< 0.01 and ***p < 0.001. Statistical tests included two-way ANOVA (B,C,D) and
762 unpaired Student's t test (E, F).

763 **Figure 4. Conditional deletion of *CaMK1D* in AgRP neurons decreases energy expenditure.**

764 (A) Cumulative food intake from mice with indicated genotypes on a CD. Food intake was
765 determined 48H during indirect calorimetric measurements. (N=10 to 11 / group). (B-C)
766 Locomotor activity over 48H in mice with indicated genotypes on a Chow diet. (D-E) Energy
767 expenditure, (F) Regression-based analysis of absolute MR against body mass. The ANCOVA
768 analysis was done with MR as a dependent variable, the genotype as a fixed variable and body
769 mass as a covariate. (G) consumed O₂, (H) produced CO₂ and (I) the respiratory exchange ratio
770 (RER) in of mice with indicated genotypes on a Chow diet. All indirect calorimetric measurements
771 were done in automated cages. (N=10-11/ group).
772 *p < 0.05, **p< 0.01 and ***p < 0.001. Statistical tests included two-way ANOVA (A), ANCOVA
773 (F) and unpaired Student's t test (E,G,H).

774

775 **Figure 5. *CaMK1D* is dispensable for ghrelin-induced *CaMK1D* is dispensable for**
776 **ghrelin-induced electrophysiological activation of AgRP/NPY neurons**

777 (A-B) Representative immunofluorescence and quantification of c-fos⁺ cells in the ARC of mice
778 with indicated genotypes. Animals were injected with 30 µg ghrelin or vehicle and 2H after

779 injections whole hypothalamus was removed. (C) Recording situation shown in a brightfield
780 (top) and fluorescent image (bottom). The AgRP neuron expressed EGFP (green) and the
781 recording pipette contained tetramethyl rhodamine dextrane (red) to monitor membrane
782 integrity during the perforated patch clamp recording. (D) Recording of an AgRP neuron from
783 a *CaMK1D*^{+/+} mouse during ghrelin (100 nM) bath application. Top: Rate histogram, bin width:
784 10 s. Middle: Original recording. Bottom: Segments of the original recording in higher time
785 resolution. The numbers indicate the time points from which the segments originate. (E)
786 Ghrelin responses of AgRP neurons from *CaMK1D*^{+/+} and in *CaMK1D*^{-/-} mice, expressed as
787 change in action potential frequency. Top: Mean (\pm SEM) responses during the first 5 min of
788 ghrelin application. Bottom: Box plots showing the change in action potential frequency
789 measured between 6 and 8 min of ghrelin application. (F-I) Basic electrophysiological
790 properties of AgRP neurons in *CaMK1D*^{+/+} and in *CaMK1D*^{-/-} mice. (F) Spontaneous action
791 potential frequency. (G) Excitability assessed by the number of action potentials (APs) as a
792 function of current pulse (1s) amplitude. (H) Input resistance. (I) Whole-cell capacitance. The
793 horizontal lines in the box plots show the median. The whiskers were calculated according to
794 the 'Tukey' method. ****p* < 0.001. Statistical tests included unpaired Student's t test (A). Data in
795 (E, F, H, and I) were compared using the Mann-Whitney-U-test, and linear regressions in (G)
796 were compared using the F-test. n values are given in brackets.

797

798 **Figure 6. Lack of CaMK1D reduces ghrelin-induced AgRP/NPY expression and abundance**
799 **in AgRP neuron projections to the PVN.** (A) Representative Phos-tag immunoblot of CaMK1D
800 using lysates of hypothalamic cells from mice with indicated genotypes treated with 1 μ M Ghrelin
801 or vehicle for 5 min. Vinculin was used as a loading control. (B) Representative immunoblot of
802 pS179/T180 CaMK1D using lysates of whole hypothalamus from mice with indicated genotypes.
803 Animals were injected with 30 μ g ghrelin or vehicle and 2H after injections whole hypothalamus

804 was removed and used for protein extraction. GAPDH was used as a loading control. (C)
805 Representative immunoblots of pS79-ACC, pT172-AMPK and pS133-CREB using lysates of
806 hypothalamic primary neurons from mice with indicated genotypes treated with 1 μ M Ghrelin or
807 vehicle for 5 min. GAPDH was used as a loading control. (D) Expression of AgRP, NPY and
808 POMC mRNA in whole hypothalamus. Animals were injected with 30 μ g ghrelin or vehicle and
809 whole hypothalamus was removed 2H after injections. Tissues from mice with indicated genotypes
810 were analyzed by qPCR (n=5 to 6 / group). (E-F) Representative immunofluorescence and
811 quantification of AgRP projections to the PVN of mice with indicated genotypes. Animals were
812 injected with 30 μ g ghrelin and 2H after injections, whole hypothalamus was removed or brain was
813 extracted and sliced. (G) Schematic model depicting mechanisms as to how CaMK1D promotes
814 food intake.

815 *p < 0.05 and ***p < 0.001. Statistical tests included unpaired Student's t test (D,E).

816

817 **Supp Figure 1. Global deletion of *CaMK1D* in mice does not affect body size and *CaMK1D***

818 **knockout mice are born without any gross abnormalities.** (A) Knockout-first targeting strategy

819 within the *CaMK1D* locus and generation of floxed and total knockout mice. For further details

820 see material and methods. (B) Gender distribution of mice and (C) Mendelian ratios of born mice

821 with indicated genotypes. (D) Body length and (E) Tibia Length measurements of 7-week-old

822 mice with indicated genotypes (n=6 to 7 / group).

823

824 **Supp Figure 2. CaMK1D signaling is redundant in pancreatic beta cell and liver function.**

825 (A) Blood insulin levels during IPGTTs in mice with indicated genotypes on a HFD. IPGTT was

826 performed after an overnight food withdrawal. (n=11 to 11 / group). (B) Glucose-stimulated insulin

827 secretion (GSIS) in pancreatic islets isolated from mice with indicated genotypes. (n=6 to 7 /

828 group). (C) Expression of CaMK1D protein in pancreas and brain from mice with indicated

829 genotypes. Tissues were analyzed for CaMK1D expression by western blot. (D) Body weight gain
830 of mice with indicated genotypes on a Chow diet (CD) or on a High Fat Diet (HFD). (n=9 to 11/
831 group). (E-F) Blood glucose levels during IPGTTs in mice with indicated genotypes on a CD (E)
832 or on a HFD (F). IPGTT was performed after overnight food withdrawal. (n=9 to 11 / group).
833 (G) Expression of CaMK1D mRNA in liver from mice with indicated genotypes by qPCR. (H)
834 Body weight gain of mice with indicated genotypes on a CD or on a HFD. (n=9 to 11/ group).
835 Blood glucose levels during an IPGTT in mice with indicated genotypes on a CD (I) or on a HFD
836 (J). IPGTT was performed after overnight food withdrawal. (n=9 to 11 / group). Blood glucose
837 levels during an ITT in mice with indicated genotypes on a CD (K) or on a HFD (L). IPGTT was
838 performed 4H after food withdrawal. (n=6 to 10 / group).

839

840 **Supp Figure 3. Deletion of *CaMK1D* does not result in anxiety-like behavior and stress-**
841 **induced anhedonia.** (A) Distance traveled each 5 min, and (B) in total. (C) Rear number each 5
842 min, and (D) in total. (E) Number of entries in the center or periphery of the arena. (F) Time spent
843 in the center or periphery of the arena. (G) Average speed during an open field test. (n=9 / group).
844 (H) Amount of sucrose and water consumed over 3 day in while sucrose and water were both
845 available in the same time.

846

847 **Supp Figure 4. Deletion of *CaMK1D* in the Nervous Tissue reproduces phenotypes in whole-**
848 **body knockout mice.** (A) Expression of CaMK1D protein in different tissues in mice. Tissues
849 from mice with indicated genotypes were analyzed for CaMK1D expression by western blot. (B)
850 Body weight gain of mice with indicated genotypes on a Chow diet (CD) or on a High Fat Diet
851 (HFD). (n=10 to 15/ group). Cumulative food intake of mice with indicated genotypes on (C) CD
852 or on (D) HFD. (n=10 to 15 / group) (*p ≤ 0.05). (E) Cumulative food intake of mice with indicated
853 genotypes and diets. Food intake was determined 24H after fasting. (n=12 to 17 / group). (F)

854 Cumulative food intake after ghrelin injection (30 μ g / day) in mice with indicated genotypes on a
855 CD. (n=6 to 7 / group). *p < 0.05, **p < 0.01 and ***p < 0.001. Statistical tests included two-way
856 ANOVA (B,C,D), and unpaired Student's t test (E,F).

857

858

859 **Supp Figure 5. Deletion of *CaMK1D* in POMC neurons does not affect energy metabolism in**
860 **mice.** (A) Verification of recombination in the *CaMK1D* locus in hypothalamus (Hyp), cortex
861 (Ctx), liver, tail and white blood cells (WBC) from mice with indicated genotypes. DNA from
862 tissues were analyzed by PCR with primers amplifying either recombined or floxed alleles,
863 respectively. (B) Body weight gain of mice with indicated genotypes on a Chow diet (CD) or on a
864 High Fat Diet (HFD). (n=10 to 15/ group).(C) Cumulative food intake of mice with indicated
865 genotypes on a CD. (n=10 to 15 / group). (D) Cumulative food intake of mice with indicated
866 genotypes on a HFD. (n=10 to 15 / group). (E) Cumulative food intake of mice with indicated
867 genotypes and diets. Food intake was determined 24H after fasting. (n=12 to 17 / group). (F)
868 Cumulative food intake after ghrelin injection in mice with indicated genotypes and diets. (n=6 to
869 7 / group). *p < 0.05. Statistical tests included unpaired Student's t test (F).

870

Figure 1

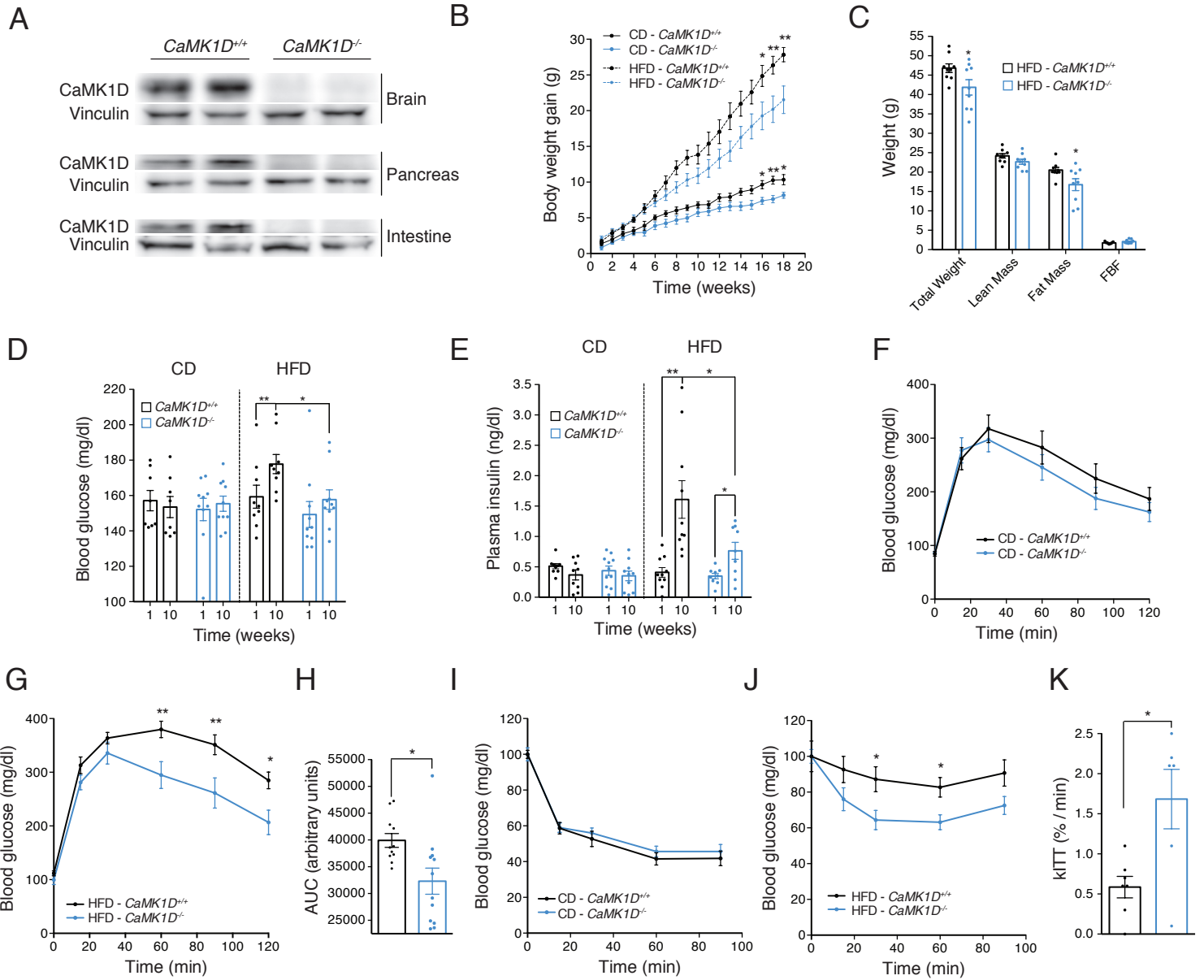

Figure 2

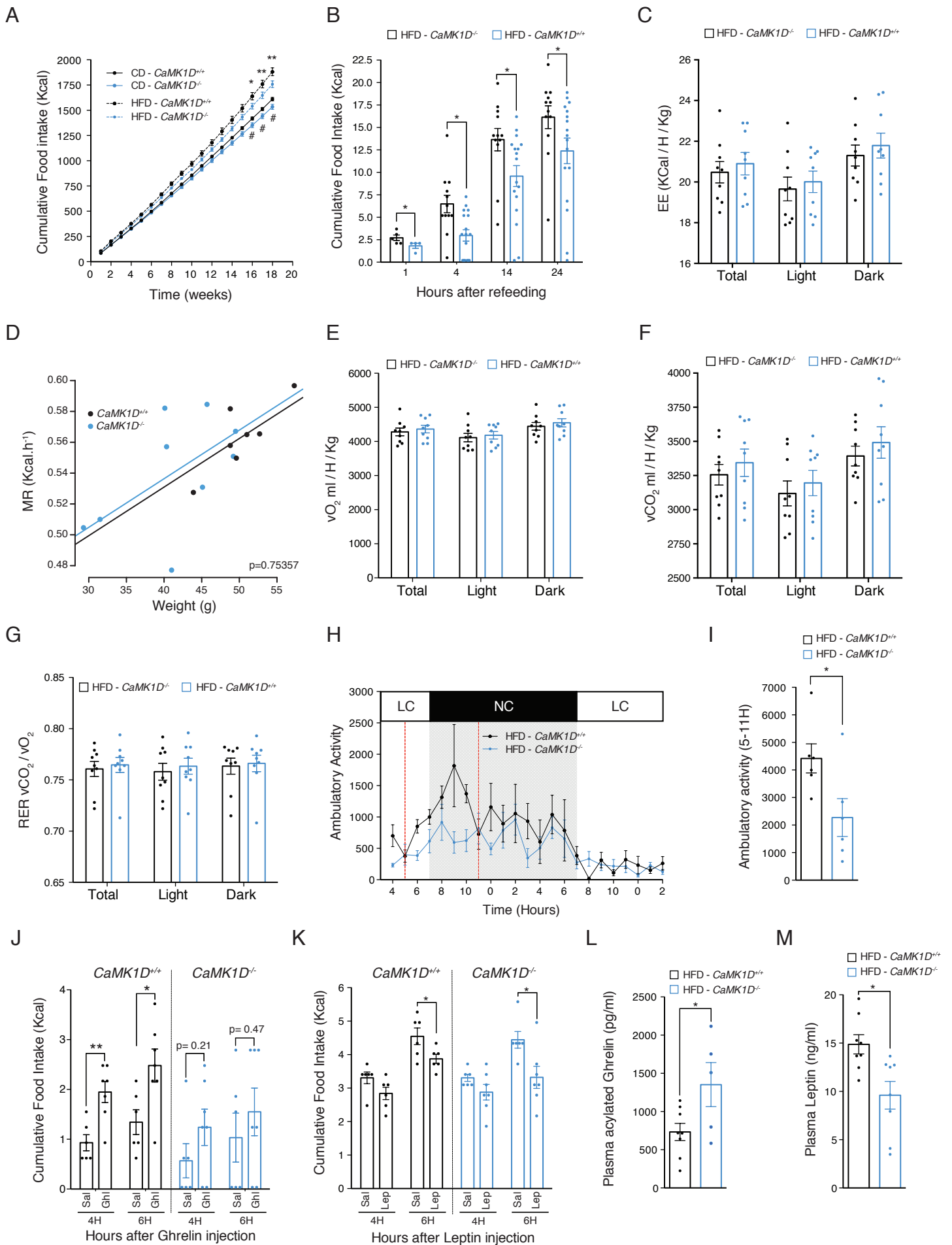

Figure 3

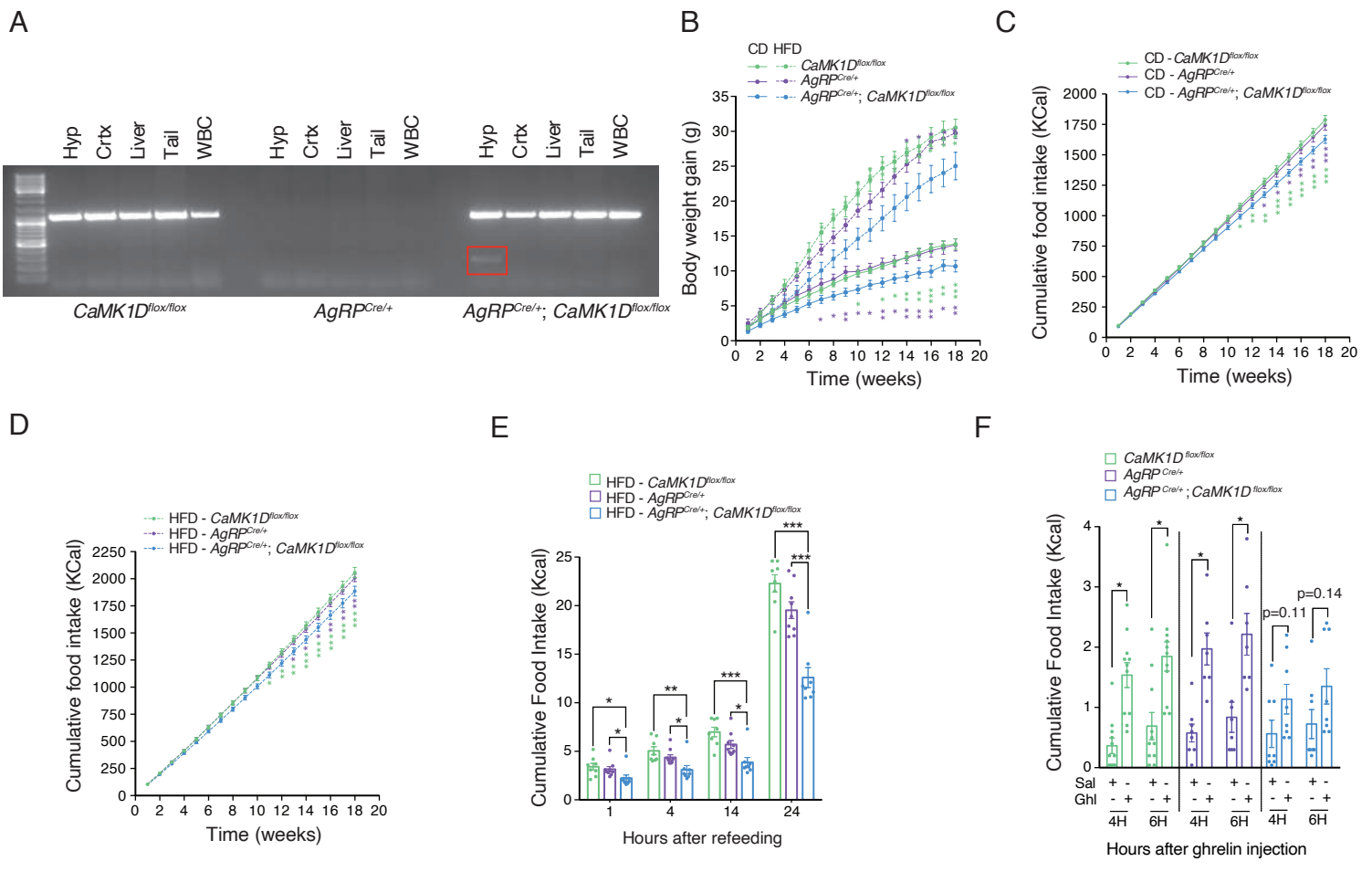

Figure 4

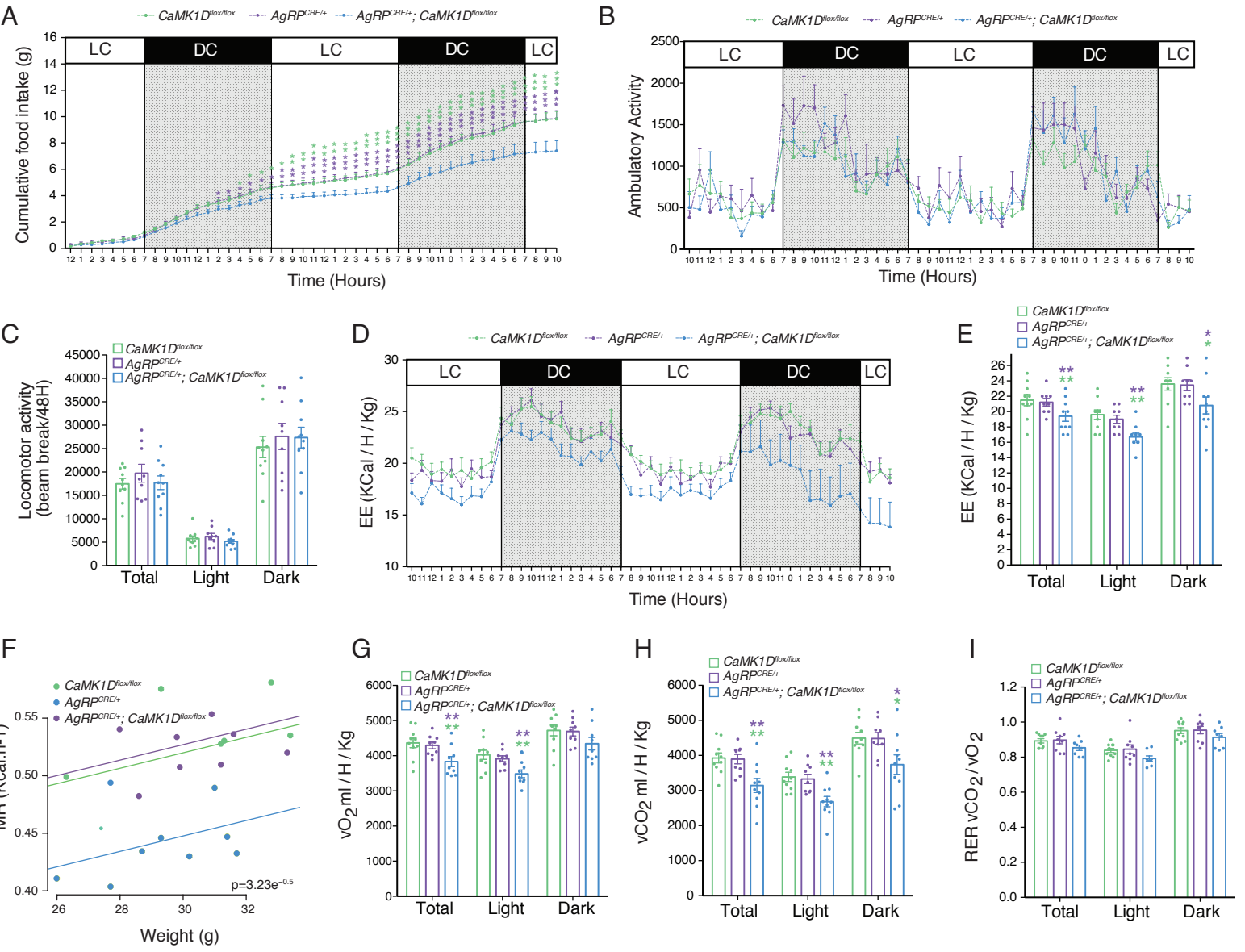

Figure 5

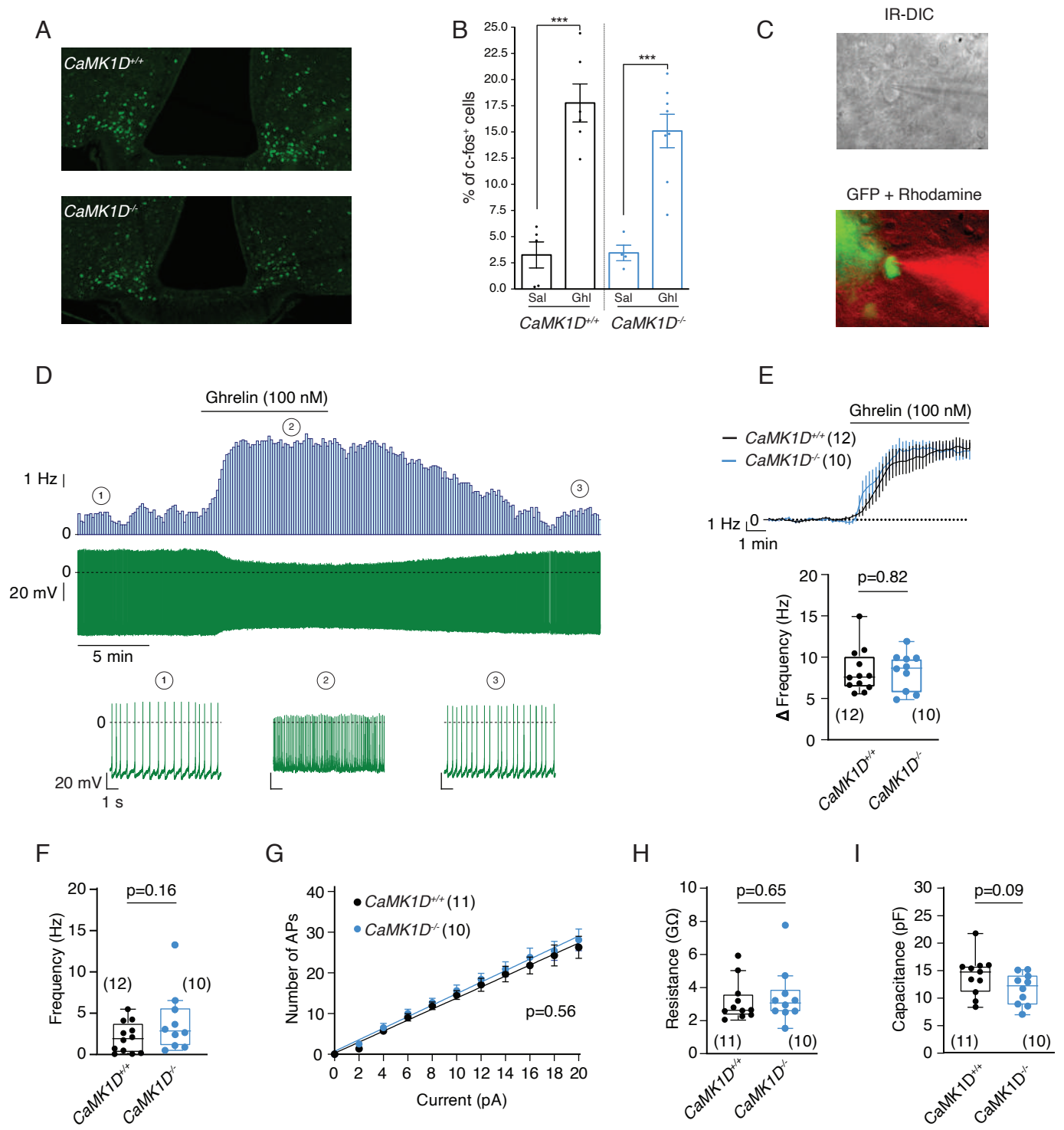

Figure 6

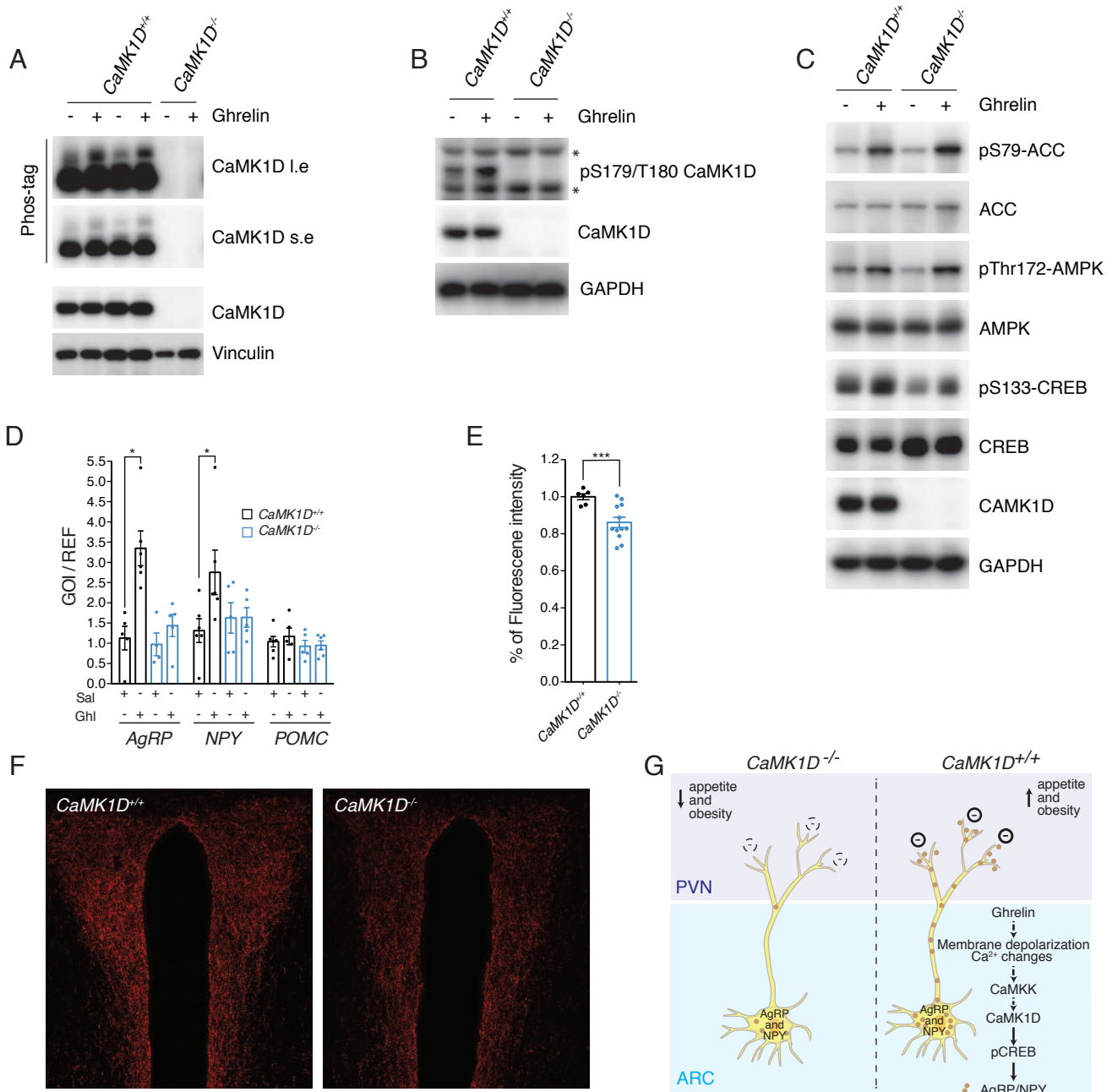
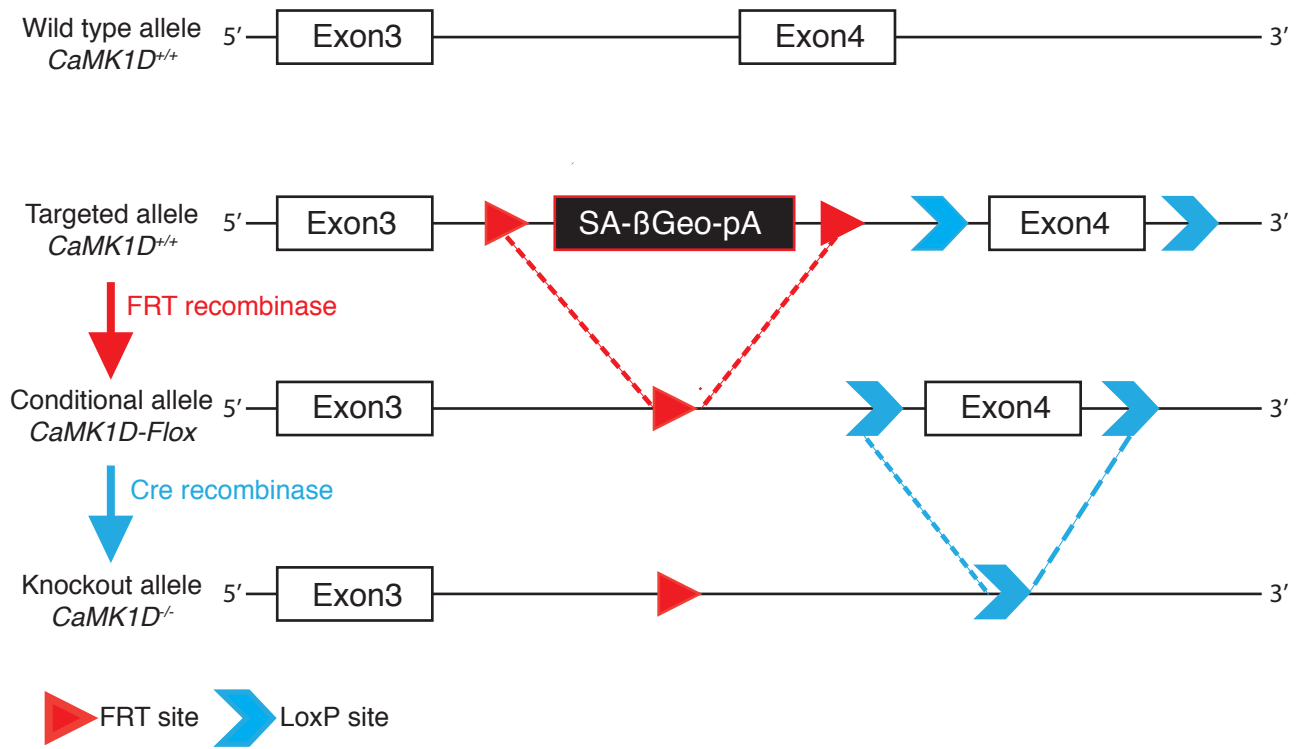

Figure S1

A



B

Females / Males Ratio

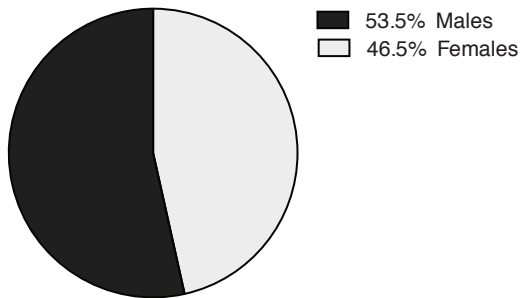

C

Mendelian Ratio

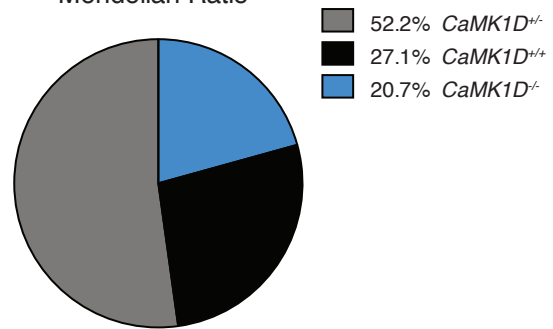

D

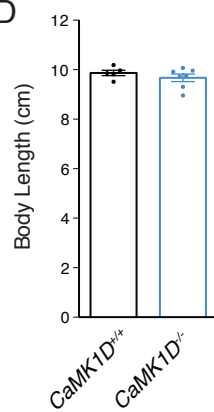

E

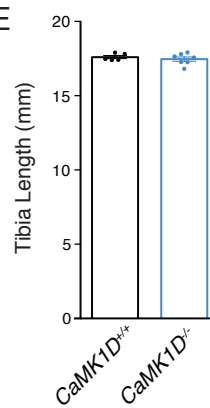

Figure S2

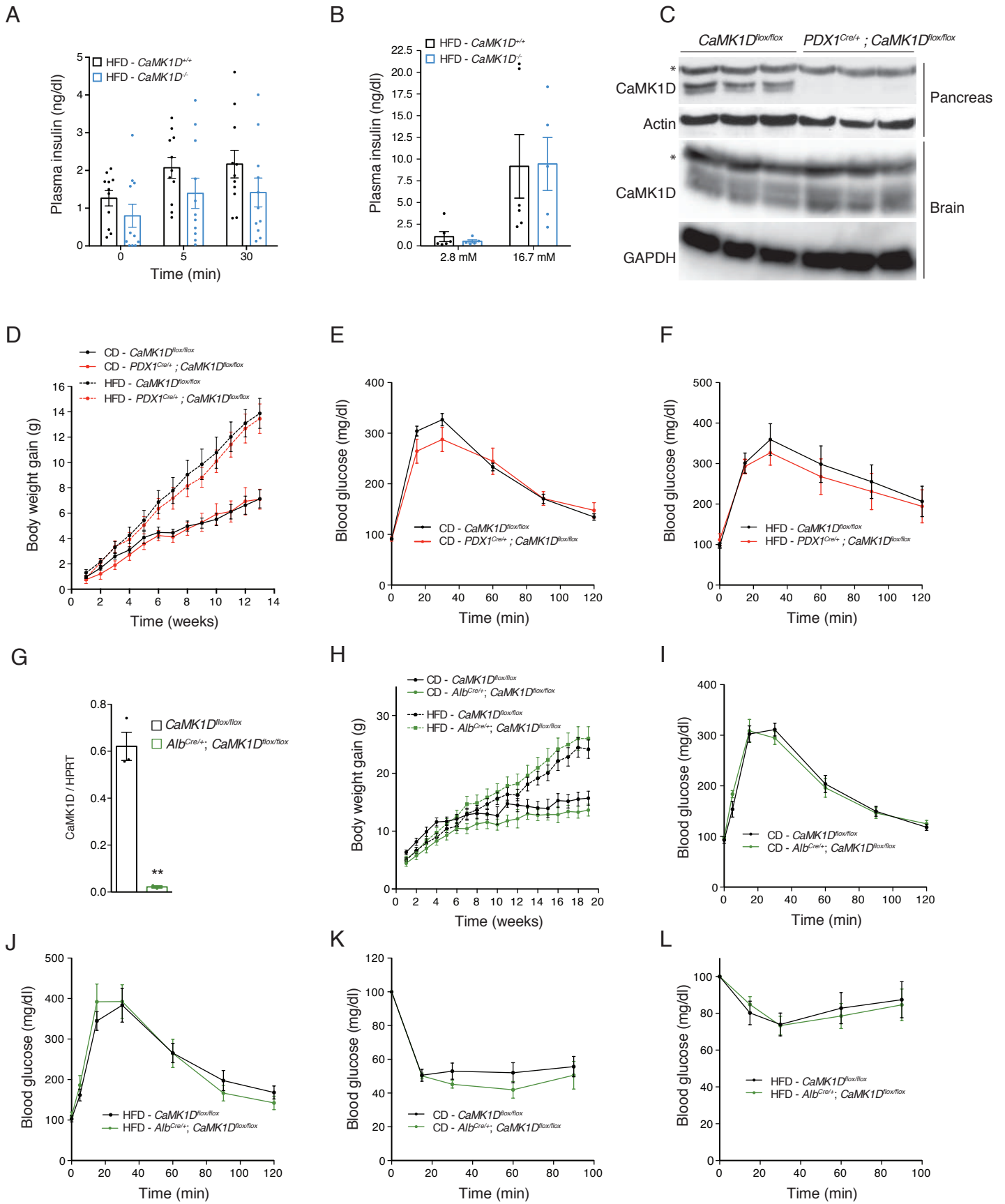

Figure S3

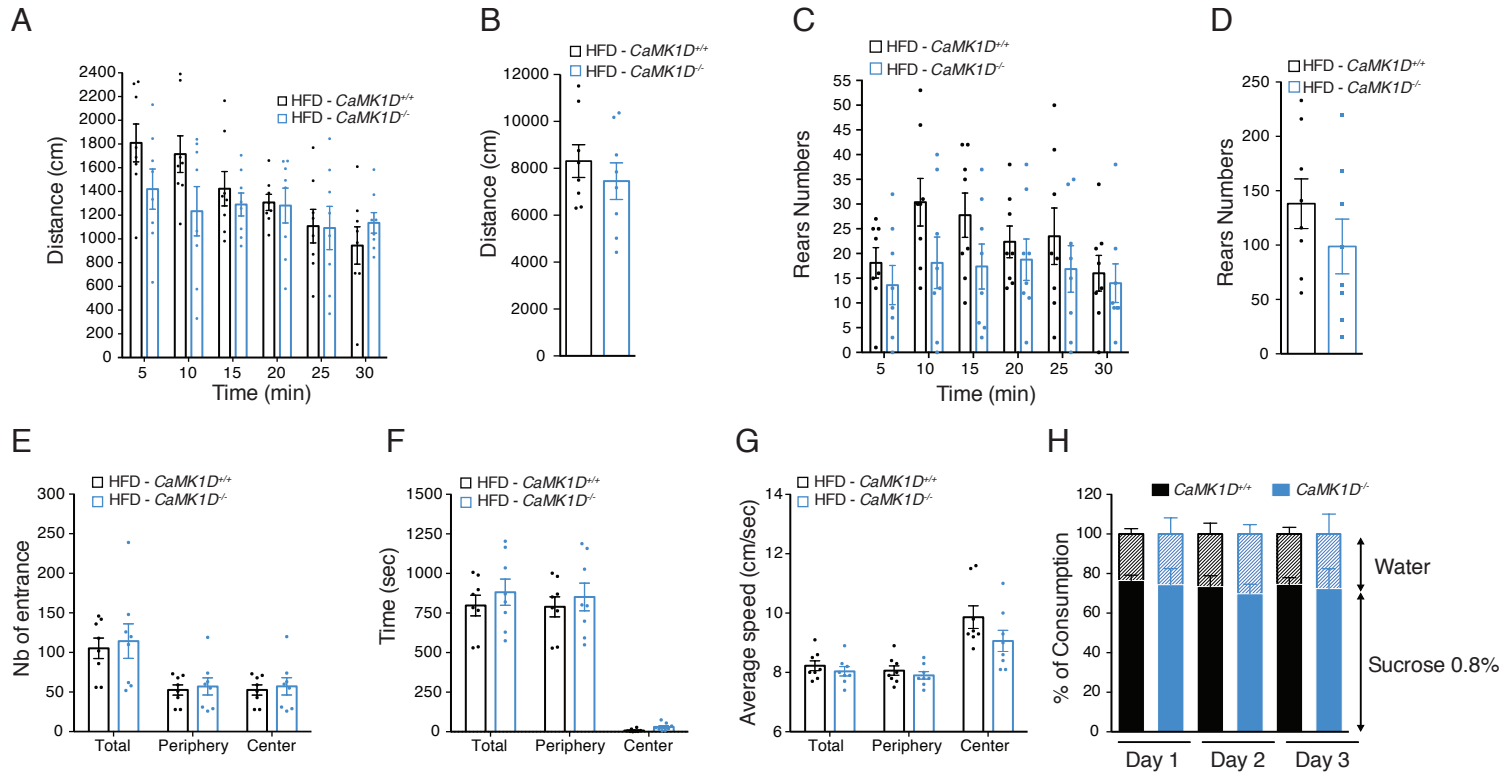

Figure S4

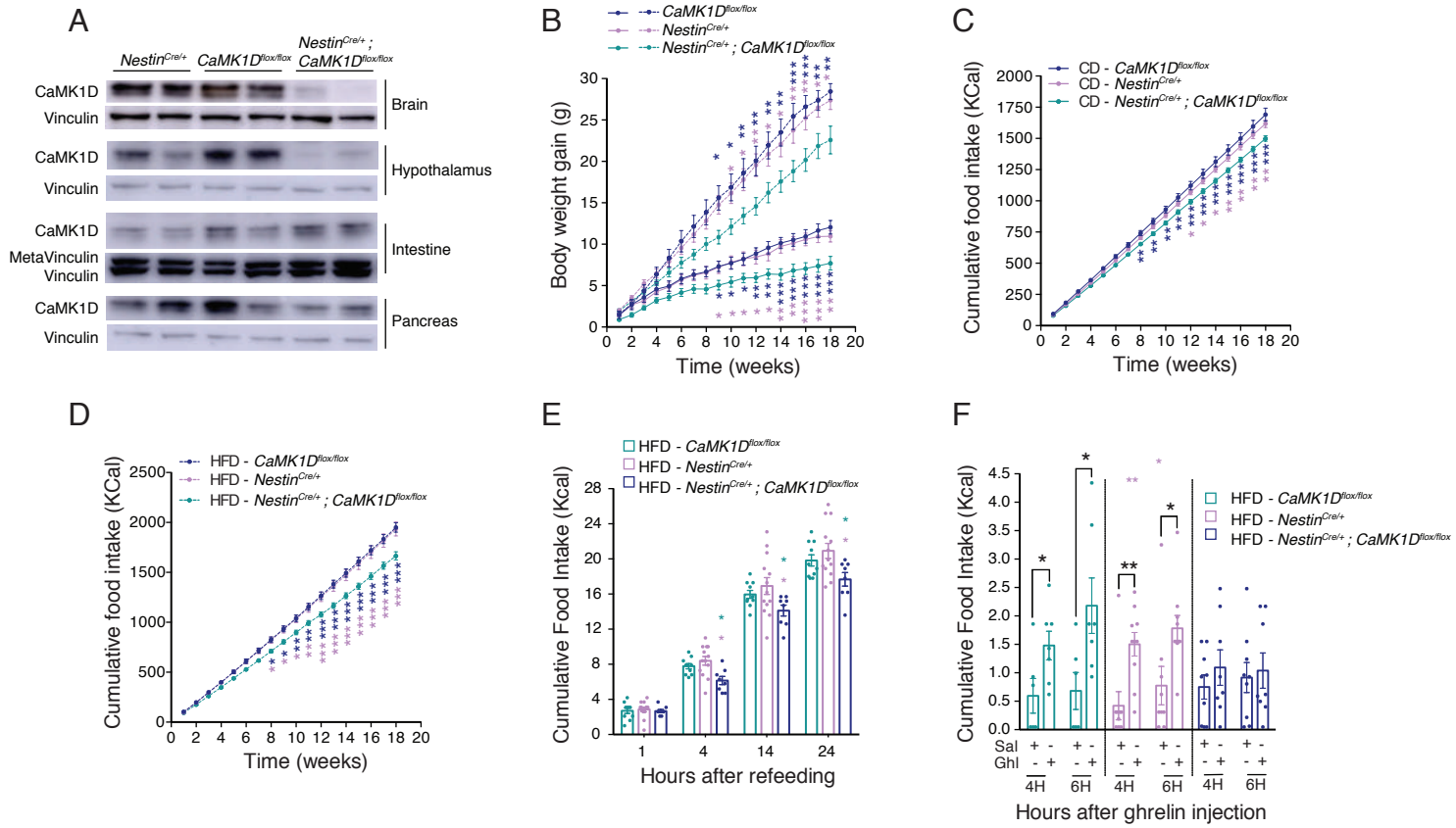

Figure S5

