



**HAL**  
open science

# ON BRAIDS AND LINKS UP TO LINK-HOMOTOPY

Emmanuel Graff

► **To cite this version:**

| Emmanuel Graff. ON BRAIDS AND LINKS UP TO LINK-HOMOTOPY. 2022. hal-03792805

**HAL Id: hal-03792805**

**<https://hal.science/hal-03792805v1>**

Preprint submitted on 30 Sep 2022

**HAL** is a multi-disciplinary open access archive for the deposit and dissemination of scientific research documents, whether they are published or not. The documents may come from teaching and research institutions in France or abroad, or from public or private research centers.

L'archive ouverte pluridisciplinaire **HAL**, est destinée au dépôt et à la diffusion de documents scientifiques de niveau recherche, publiés ou non, émanant des établissements d'enseignement et de recherche français ou étrangers, des laboratoires publics ou privés.

# ON BRAIDS AND LINKS UP TO LINK-HOMOTOPY

EMMANUEL GRAFF

ABSTRACT. This paper deals with links and braids up to link-homotopy, studied from the viewpoint of Habiro's clasper calculus. More precisely, we use clasper homotopy calculus in two main directions. First, we define and compute a faithful linear representation of the homotopy braid group, by using clasplers as geometric commutators. Second, we give a geometric proof of Levine's classification of 4-component links up to link-homotopy, and go further with the classification of 5-component links in the algebraically split case.

## 1. INTRODUCTION

The notion of *link-homotopy* was introduced in 1954 by J.W. Milnor in [Mil54], in the context of knot theory. It is an equivalence relation on links that allows continuous deformations during which two distinct components remain disjoint at all times, but each component can self-intersect. Any knot is link-homotopic to the trivial one, but for links with more than one component this equivalence relation turns out to be quite rich and intricate. Since Milnor's seminal work, link-homotopy has been the subject of numerous works in knot theory see e.g. [Gol74; Lev88; Orr89; HL90], but also more generally in the study of embedding and *link-maps* (self-immersed spheres) [FR86; Kir88; Kos90; ST19] in codimension 2 - in particular *knotted surfaces* in dimension 4 [MR85; BT99; AMW17]. In this paper we are interested in the study of link-homotopy for braids and links.

The *homotopy braid group* has been studied by many authors. In [Gol74] Goldsmith gives an example of a non trivial braid up to isotopy that is trivial up to link-homotopy; she also gives a presentation of the homotopy braid group. A representation of the homotopy braid group is given by Humphries in [Hum01]. He uses it to show that the homotopy braid group is torsion-free for less than 6 strands. Finally the pure homotopy braid group has been studied by Habegger and Lin in [HL90] as an intermediate object for the classification of links up to link-homotopy. As further developed below, our first main result is another linear representation of the homotopy braid group (Theorem 3.25), which we prove to be faithful (Theorem 3.33) and which is computed explicitly in Theorem 3.28.

We also address the problem initially posed by Milnor in [Mil54], of classifying links in the 3-sphere up to link-homotopy. Milnor himself answered the question for the 2 and 3-component case. Furthermore, Habegger and Lin [HL90] proposed a complete classification; they solved the problem for any number of components, in terms of partial conjugations. This is a subtle algebraic equivalence relation on pure braids, where two equivalent braids correspond to link-homotopic links. A more direct algebraic approach had been proposed by Levine [Lev88] just before the work of Habegger–Lin in the 4-component case. Our second main result, is a new geometric proof of Levine's classification of 4-component links up to link-homotopy (Theorem 4.10), which we further generalize in Theorem 4.12

---

*Date:* September 30, 2022.

*1991 Mathematics Subject Classification.* 20F36, 57M27,

*Key words and phrases.* Links, Braid groups, Link-homotopy, Clasplers.

to *algebraically split* 5-component links (that is, 5-component links with vanishing linking numbers).

The notion of *clasper* was developed by Habiro in [Hab00]. These are surfaces in 3-manifolds with some additional structures, on which surgery operations can be performed. In [Hab00], Habiro describes the clasper calculus up to isotopy, which is a set of geometric operations on claspers that yield equivalent surgery results. It is well known to experts how clasper calculus can be refined for the study of knotted objects up to link-homotopy (see for example [FY09; KM20]). This *homotopy clasper calculus*, which we review in Section 2, will be the key tool for proving all the main results outlined above.

The rest of this paper consists of three sections.

In Section 2, we review the homotopy clasper calculus: after briefly recalling from [Hab00] Habiro's clasper theory, we recall how a fundamental lemma from [FY09], combined with Habiro's work, produces a set of geometric operations on claspers having link-homotopic surgery results.

Section 3 is dedicated to the study of braids up to link-homotopy. We start by reinterpreting braids in terms of claspers. In Section 3.1 we define *comb-claspers*, a family of claspers corresponding to braid commutators. They are next used to define a *normal form* on homotopy braids, thus allowing us to rewrite any braid as an ordered product of comb-claspers. In Section 3.2 after a short algebraic interlude, we give a presentation of the *pure homotopy braid group* (Corollary 3.22), using the work of [Gol74] and [MK99] as well as the technology of claspers. Finally, we define and study in Section 3.3 a representation of the homotopy braid group which is in a sense the linearization of the homotopic Artin representation. We give its explicit computation in Theorem 3.28 (see also Example 3.30 for the 3-strand case) and show its injectivity in Theorem 3.33. Moreover, from the injectivity of the representation follows the uniqueness of the normal form and thus the definition of the *clasp-numbers*, a collection of braid invariant up to link-homotopy. Note that our representation has lower dimension than Humphries one. The correspondence between the two representations has not been established yet, but we wonder if our representation could open new leads on the torsion problem for more than six strands.

The final Section 4 focuses on the study of links up to link-homotopy. The method used is based on the precise description of partial conjugations, which is the central algebraic tool in the above-mentioned classification result of Habegger and Lin [HL90]; we provide them with a topological description in terms of claspers. This new point of view allows us, for a small number of components, to describe when two braids in normal form have link-homotopic closures. We translate in terms of *clasp-number variations* the action of partial conjugations on the normal form. In this way we recover the classification results of Milnor [Mil54] and Levine [Lev88] for 4 or less components (Theorem 4.10). Moreover, we also classify 5-component algebraically split links up to link-homotopy (Theorem 4.12).

*Acknowledgement:* This work is partially supported by the project AlMaRe (ANR- 19-CE40-0001-01) of the ANR. The author thanks P. Bellingeri and J.B. Meilhan for their great advises and helpful discussions.

## 2. CLASPER CALCULUS UP TO LINK-HOMOTOPY

Clasper calculus has been developed by Habiro in [Hab00] in the context of *tangles* up to isotopy. Claspers turn out to be in fact a powerful tool to deal with link-homotopy. In this section we first define claspers and their associated vocabulary. Then we describe how to handle claspers up to link-homotopy.

**2.1. General definitions.** Let  $X$  denote an  $n$ -component ordered and oriented 1-manifold (a disjoint union of circles and intervals), and let  $M$  denote a smooth compact and oriented 3-manifold.

**Definition 2.1.** An  $n$ -component tangle in  $M$  is a smooth embedding of  $X$  into  $M$ . We also denote by  $\theta$  the image of the embedding with the induced orientation.

- We say that two tangles are *isotopic* if they are related by an ambient isotopy of  $M$  that fixes the boundary.
- We say that two tangles are *link-homotopic* if there is a homotopy between them fixing the boundary, and such that the distinct components remain disjoint during the deformation.

**Definition 2.2.** A disk  $T$  smoothly embedded in  $M$  is called a *clasper for a tangle  $\theta$*  if it satisfies the following three conditions:

- $T$  is the embedding of a connected thickened uni-trivalent graph with a cyclic order at each trivalent vertex. Thickened univalent vertices are called *leaves*, and thickened trivalent vertices, *nodes*.
- $\theta$  intersects  $T$  transversely, and the intersection points are in the interior of the leaves of  $T$ .
- Each leaf intersects  $\theta$  at at least one point.

Diagrammatically a clasper is represented by a uni-trivalent graph corresponding to the one to be thickened. The trivalent vertices are thickened according to Figure 1. On the univalent vertices we specify how the corresponding leaves intersect  $\theta$ , and we also indicate how the edges are twisted using markers called *twists* (see Figure 1).

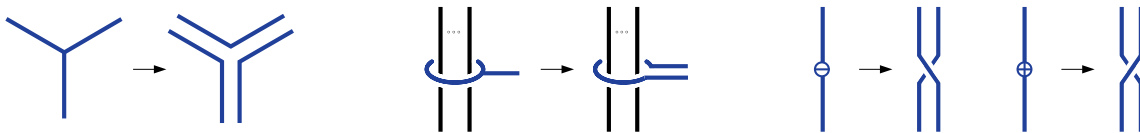

FIGURE 1. Local diagrammatic representation of claspers.

**Definition 2.3.** Let  $T$  be a clasper for a tangle  $\theta$ . We define the *degree* of  $T$  denoted  $\deg(T)$  as its number of nodes plus one, or equivalently its number of leaves minus one. The *support* of  $T$  denoted  $\text{supp}(T)$  is defined to be the set of the components of  $\theta$  that intersect  $T$ . We often consider the number of the components rather than the components themselves.

**Definition 2.4.** A clasper  $T$  for a tangle  $\theta$  is said to be *simple* if all leaves of  $T$  intersect  $\theta$  exactly once. A leaf of a simple clasper intersecting the  $l$ -th component is called an  *$l$ -leaf*.

**Definition 2.5.** We say that a clasper  $T$  for a tangle  $\theta$  *has repeats* if it intersects a component of  $\theta$  in at least two points.

Given a clasper  $T$  for a tangle  $\theta$ , there is a procedure called *surgery* detailed in [Hab00] to construct a new tangle denoted  $\theta^T$ . We illustrate on the left hand side of Figure 2 the effect of a surgery on a clasper of degree one. Now if  $T$  has degree higher than one, we first apply the rule shown on the right hand side of Figure 2, at each trivalent vertex: this breaks up  $T$  into a union of degree one claspers, on which we can perform surgery.

Note that clasper surgery commutes with ambient isotopy. More precisely for  $i$  an ambient isotopy and  $T$  a clasper for a tangle  $\theta$  we have that  $i(\theta^T) = (i(\theta))^{i(T)}$ . This is an elementary example of *clasper calculus*, which refers to the set of operations on unions of a tangles with some claspers, that allow to deform one into an other with isotopic surgery result. These operations are developed in [Hab00], and we give in the next section the analogous calculus up to link-homotopy.



FIGURE 2. Rules of clasper surgery.

**2.2. Clasper calculus up to link-homotopy.** In the whole section,  $T$  and  $S$  denote simple claspers for a given tangle  $\theta$ . We use the notation  $T \sim S$ , and say that  $T$  and  $S$  are *link-homotopic* when the surgery results  $\theta^T$  and  $\theta^S$  are so. For example if  $i$  is an ambient isotopy that fixes  $\theta$ , then  $T \sim i(T)$ . Moreover, if  $\theta^T$  is link-homotopic to  $\theta$ , we say that  $T$  *vanishes up to link-homotopy* and we denote  $T \sim \emptyset$ .

We begin by recalling a fundamental lemma from [FY09]; more precisely, the next result is the case  $k = 1$  of [FY09, Lemma 1.2], where self  $C_1$ -equivalence corresponds to link-homotopy.

**Lemma 2.6.** [FY09, Lemma 1.2] *If  $T$  has repeats then  $T$  vanishes up to link-homotopy.*

It is well known to the experts that combining Lemma 2.6 with the proofs of Habiro's technical results on clasper calculus [Hab00], yields the following *link-homotopy clasper calculus*.<sup>1</sup>

**Corollary 2.7.** [Hab00, Proposition 3.23, 4.4, 4.5, 4.6] *We have the following link-homotopy equivalences (illustrated in Figure 3).*

- (1) *If  $S$  is a parallel copy of  $T$  which differs from  $T$  only by one twist (positive or negative), then  $S \cup T \sim \emptyset$ .*
- (2) *If  $T$  and  $S$  have two adjacent leaves and if  $T' \cup S'$  is obtained from  $T \cup S$  by exchanging these leaves as depicted in (2) from Figure 3, then  $T \cup S \sim T' \cup S' \cup \tilde{T}$ , where  $\tilde{T}$  is as shown in the figure.*
- (3) *If  $T'$  is obtained from  $T$  by a crossing change with a strand of the tangle  $\theta$  as depicted in (3) from Figure 3, then  $T \sim T' \cup \tilde{T}$ , where  $\tilde{T}$  is as shown in the figure.*
- (4) *If  $T' \cup S'$  is obtained from  $T \cup S$  by a crossing change between one edge of  $T$  and one of  $S$  as depicted in (4) from Figure 3, then  $T \cup S \sim T' \cup S' \cup \tilde{T}$ , where  $\tilde{T}$  is as shown in the figure.*
- (5) *If  $T'$  is obtained from  $T$  by a crossing change between two edges of  $T$  then  $T \sim T'$ .*

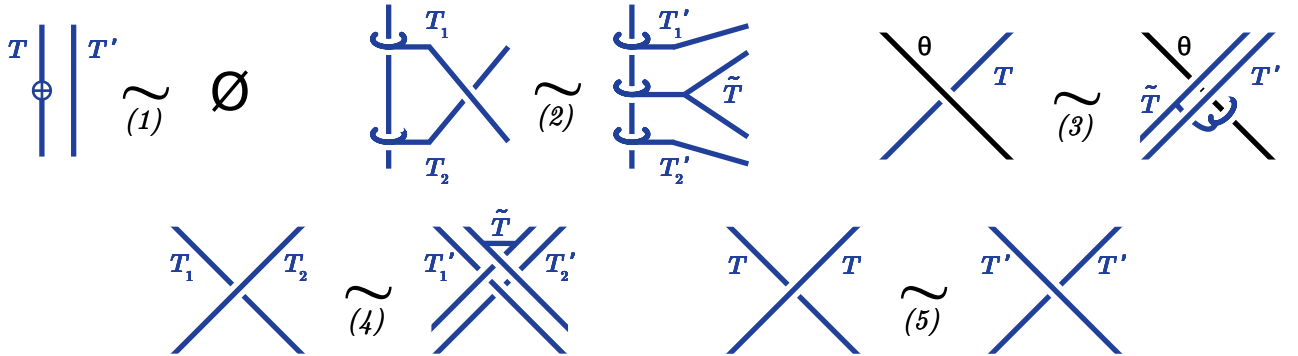

FIGURE 3. Basics clasper moves up to link-homotopy.

<sup>1</sup>See for example [KM20].

*Idea of proof.* The result of [Hab00] used here are up to  $C_k$ -equivalence, that is, up to claspers of degree up to  $k$ . The key observation is that, by construction, all such higher degree claspers have same support as the initial ones, hence they are claspers with repeats. Lemma 2.6 then allows to delete them up to link-homotopy.  $\square$

**Remark 2.8.** Lemma 2.6 combined with Corollary 2.7 give us some further results:

- First, statement (4) implies that if  $|\text{supp}(T) \cap \text{supp}(S)| \geq 1$  then we can realize crossing changes between the edges of  $T$  and  $S$ .
- Moreover, if  $|\text{supp}(T) \cap \text{supp}(S)| \geq 2$  thanks to statement (2) we can also exchange the leaves of  $T$  and  $S$ .
- Furthermore, statement (3) allows crossing changes between  $T$  and a component of  $\theta$  in the support of  $T$

Indeed, in each case the clasper  $\tilde{T}$  involved in the corresponding statement has repeats and can thus be deleted up to link-homotopy.

**Proposition 2.9.** [Hab00] *Let  $T_I, T_H, T_X$  be three parallel copies of a given simple clasper that coincide everywhere outside a three ball where they are as shown in Figure 4. Then  $T_I \cup T_H \cup T_X \sim \emptyset$ . We say that  $T_I, T_H$  and  $T_X$  verify the IHX relation.*

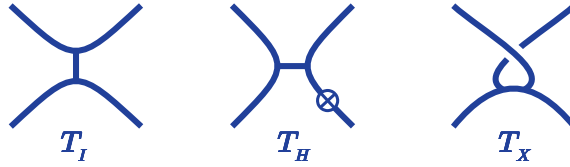

FIGURE 4. The IHX relation for claspers.

Corollary 2.7 together with the IHX relation give us most of the necessary tools to understand clasper calculus up to link-homotopy. The next lemma describes how to handle twists up to link-homotopy.

**Lemma 2.10.** *We have the following link-homotopy equivalences (illustrated in Figure 5).*

- (6) *If  $T'$  is obtained from  $T$  by turning a positive twist into a negative one then  $T \sim T'$ .*
- (7) *If  $T'$  is obtained from  $T$  by moving a twist across a node then  $T \sim T'$ .*
- (8) *If  $T$  and  $T'$  are identical outside a neighborhood of a node, and if in this neighborhood  $T$  and  $T'$  are as depicted in (8) from Figure 5, then  $T \sim T'$ .*

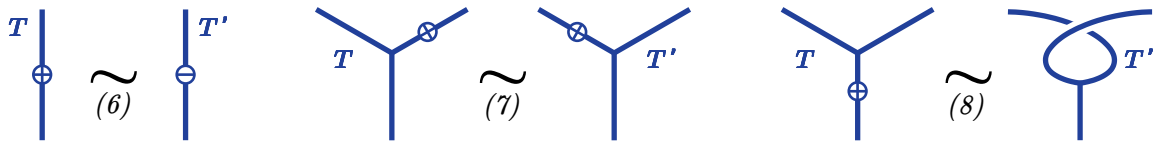

FIGURE 5. How to deal with twist up to link-homotopy.

*Proof.* For statement (6), we consider the union  $T \cup \tilde{T} \cup T'$  where  $\tilde{T}$  is another parallel copy between  $T$  and  $T'$  without twist. Then thanks to (1) from Corollary 2.7 this union is either link-homotopic to  $T$  or  $T'$ . The proof of statement (7) is similar and, statement (8) comes from the other two.  $\square$

**Remark 2.11.** Lemma 2.10 allows us to bring all the twists on a same edge and then cancel them pairwise. Therefore we can consider only claspers with one or no twists.

### 3. BRAIDS UP TO LINK-HOMOTOPY.

This section is dedicated to braids up to link-homotopy. Our main result is a representation of the homotopy braid group, defined and studied using clasper calculus. In the next two subsections we introduce the main tools for this result: first the notion of comb-claspers for braids, that yields a normal form result up to link-homotopy, and next their algebraic counterpart called *reduced basic commutators*.

**3.1. Braids and comb-claspers.** Let  $D$  be the unit disk with  $n$  fixed points  $\{p_i\}_{i \leq n}$  on a diameter  $\delta$ , and  $I$  the unit interval  $[0,1]$ . Set also  $I_1, \dots, I_n$ ,  $n$  copies of  $I$ , and  $\bigsqcup_{i \leq n} I_i$  their disjoint union. For now on the manifold  $M$  studied is the cylinder  $D \times I$ .

**Definition 3.1.** An  $n$ -component braid  $\beta = (\beta_1, \dots, \beta_n)$  is a smooth proper embedding

$$(\beta_1, \dots, \beta_n) : \bigsqcup_{i \leq n} I_i \rightarrow D \times I$$

such that  $\beta_i(0) = (p_i, 1)$  and  $\beta_i(1) = (p_{\pi(\beta)(i)}, 0)$  with  $\pi(\beta)$  some permutation of  $\{1, \dots, n\}$  associated to  $\beta$ . We also require the embedding to be monotonic, which means that  $\beta_i(1-t) \in D \times \{t\}$  for any  $t \in [0,1]$ . We call (the image of)  $\beta_i$  the  $i$ -th component of  $\beta$ . We say that a braid is *pure* if its associated permutation is the identity.

We emphasize that the braids are here oriented from top to bottom.

The set of braids up to ambient isotopy, resp. link-homotopy, equipped with the stacking operation forms a group: the *braid group* denoted  $B_n$ , resp. the *homotopy braid group*, denoted by  $\tilde{B}_n$ . Elements of  $\tilde{B}_n$  are called *homotopy braids*. The set of pure braids up to isotopy, resp. link-homotopy, forms a subgroup of  $B_n$ , resp.  $\tilde{B}_n$ , denoted by  $P_n$ , resp.  $\tilde{P}_n$ .

**Remark 3.2.** Braids are tangles without closed components, and with boundary and monotonic conditions. But any tangle with the same boundary condition and without closed components is link-homotopic to a braid (such tangles are called *string links* in the literature). Moreover if two braids are link-homotopic as string links then they are also as braids (see [HL90]). Thus, when regarding braids up to link-homotopy we can freely consider them as string links (*i.e.* we can forget the monotonic condition). This is useful from the clasper point of view since clasper surgery does not respect this condition in general.

We introduce next *comb-claspers* and their associated notation. Consider the usual representative  $\mathbf{1}$  of the trivial  $n$ -component braid given by  $\mathbf{1}_i = \{p_i\} \times I$  for  $i \in \{1, \dots, n\}$ . Denote by  $(D \times I)^+$  and  $(D \times I)^-$  the two half-cylinders determined by the plane  $\delta \times I$ , where  $\delta$  is the fixed diameter on  $D$ . In figures, we choose  $(D \times I)^+$  to be above the plane of the projection.

**Definition 3.3.** We call *comb-clasper* a simple clasper without repeats for the trivial braid such that:

- Every edge is in  $(D \times I)^+$ .
- The minimal path running from the smallest to the largest component of the support meets all nodes.
- At each node, the edge that does not belong to the minimal path leaves "to the left" as locally depicted in Figure 6.

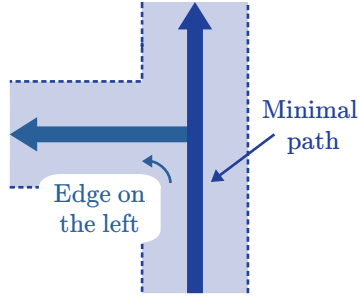

FIGURE 6. Local orientation at each node of a comb-clasper.

An example is given in Figure 7.

The second condition of Definition 3.3 implies that every node is related (by an edge and a leaf) to a component of  $\mathbf{1}$  that is not the smallest or the largest of the support. Using that, we can order the support of a comb-clasper: we start with the smallest component, then we order the components according to the order in which we meet them along the minimal path, and finally, we end with the largest one. For example in Figure 7 the ordered support is  $\{1,2,6,4,5,8\}$ .

Once the ordered support  $\{i_1, i_2, \dots, i_l\}$  fixed, the only remaining indeterminacy in a comb-clasper is the embedding of the edges in  $(D \times I)^+$ . This depends on the relative position of the edges, and on the number of twists on each of them. However, up to link-homotopy the relative position of the edges is irrelevant (by move (5) from Corollary 2.7). Besides, by Remark 2.11, we can always suppose that a comb-clasper contains either one or no twist; moreover by Lemma 2.10 we can freely assume that the potential twist is located on the edge connected to the  $i_l$ -th component. We can thus unambiguously (up to link-homotopy) denote by  $(i_1, i_2, \dots, i_l)$  the comb-clasper with such a twist and by  $(i_1, i_2, \dots, i_l)^{-1}$  the untwisted one; we call them respectively *twisted* and *untwisted* comb-claspers. For example the twisted comb-clasper (126458) is illustrated in Figure 7.

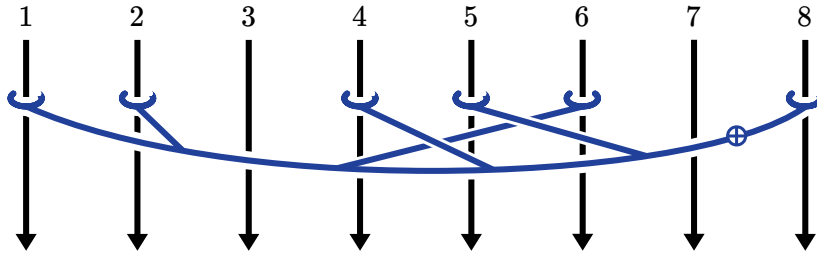

FIGURE 7. The comb-clasper (126458).

In what follow we blur the distinction between comb-claspers and the result of their surgery up to link-homotopy. From this point of view a comb-clasper is a pure homotopy braid and the product  $(\alpha)(\alpha')$  of two comb-claspers is the product  $\mathbf{1}^{(\alpha)}\mathbf{1}^{(\alpha')}$ . In particular according to move (1) from Corollary 2.7 the inverse of a comb-clasper  $(\alpha)$  is given by  $(\alpha)^{-1}$ .



**Lemma 3.4.** *Let  $T$  be a simple clasper of degree  $k$  for the trivial braid  $\mathbf{1}$ , then  $\mathbf{1}^T$  is link-homotopic a product of comb-claspers with degree greater or equal to  $k$ .*

*Proof.* First we use isotopies and move (3) from Corollary 2.7 to turn  $T$  into a product of clasper with edges in  $(D \times I)^+$ . This step may creates claspers of higher degree (corresponding to clasper  $\tilde{T}$  in move (3)), in that case we also apply isotopies and move (3) on them until we get the desired product. Moreover by the IHX relation of Lemma 2.9 we can further assume that for each factors, the minimal path running from the smallest to the largest component meets all its nodes. Finally we apply move (8) from Lemma 2.10 to satisfy the third condition of Definition 3.3 and recover a product of comb-claspers.  $\square$

**Definition 3.5.** We say that a pure homotopy braid  $\beta \in \tilde{P}_n$  given by a product of comb-claspers  $\beta = (\alpha_1)^{\pm 1}(\alpha_2)^{\pm 1} \dots (\alpha_m)^{\pm 1}$  is :

- *stacked* if  $(\alpha_i) = (\alpha_j)$  for some  $i \leq j$  implies that  $\text{HF}(\alpha_i) = (\alpha_k)$  for any  $i \leq k \leq j$ ,
- *reduced* if it contains no redundant pairs i.e. two consecutive factors are not the inverse of each other.

If  $\beta$  is reduced and stacked we can then rewrite  $\beta = \prod (\alpha_i)^{\nu_i}$  for some integers  $\nu_i$  and with  $(\alpha_i) \neq (\alpha_j)$  for any  $i \neq j$ . Moreover, given an order on the set of twisted comb-claspers, we say that a reduced and stacked writing is a *normal form of  $\beta$  for this order* if  $(\alpha_i) \leq (\alpha_j)$  for all  $i \leq j$ .

We stress that the notion of normal form is relative to a given order on the set of twisted comb-claspers. The following example will be relevant for Section 4.

**Example 3.6.** Given two twisted comb-claspers  $(\alpha) = (i_1 \dots i_l)$  and  $(\alpha') = (i'_1 \dots i'_l)$  we can choose the order  $(\alpha) \leq (\alpha')$  defined by:

- $\max(\text{supp}(\alpha)) < \max(\text{supp}(\alpha'))$ , or
- $\max(\text{supp}(\alpha)) = \max(\text{supp}(\alpha'))$  and  $\deg(\alpha) < \deg(\alpha')$ , or
- $\max(\text{supp}(\alpha)) = \max(\text{supp}(\alpha'))$  and  $\deg(\alpha) = \deg(\alpha')$  and  $i_1 \dots i_l <_{\text{lex}} i'_1 \dots i'_l$ ,

where  $<_{\text{lex}}$  denotes the lexicographic order. With respect to this order the normal form of an element  $\beta \in \tilde{P}_4$  is given by 12 integers  $\{\nu_{12}, \dots, \nu_{1324}\}$  as follows:

$$\beta = (12)^{\nu_{12}}(13)^{\nu_{13}}(23)^{\nu_{13}}(123)^{\nu_{123}}(14)^{\nu_{14}}(24)^{\nu_{24}}(34)^{\nu_{34}}(124)^{\nu_{124}}(134)^{\nu_{134}}(234)^{\nu_{234}}(1234)^{\nu_{1234}}(1324)^{\nu_{1324}}.$$

**Theorem 3.7.** *Any pure homotopy braid  $\beta \in \tilde{P}_n$  can be expressed in a normal form for any order on the set of twisted comb-claspers.*

*Proof.* Note that the comb-clasper  $(ij)$  corresponds to the usual pure braid group generator  $A_{ij} \in \tilde{P}_n$  (see Figure 9). Thus it is clear that  $\beta = \prod (\alpha)^{\pm 1}$  for some degree one comb-claspers  $(\alpha)^{\pm 1}$ .

Now we rearrange this degree one factors according to the order by moves (2) and (4) from Corollary 2.7. This introduces new claspers of degree strictly higher than one, and by Lemma 3.4 we can freely assume that these are all comb-claspers. Next we consider, among these new comb-claspers, those of degree two and we rearrange them according to the order. Again this introduces higher degree factors, which can all be assumed to be comb-clasper according to Lemma 3.4. By iterating this procedure degree by degree we eventually obtain the desired normal form. Indeed the procedure terminates because claspers of degree higher than  $n$  are trivial in  $\tilde{P}_n$  by Lemma 2.6.  $\square$

**Remark 3.8.** This result is to be compared with Theorem 4.3 of [Yas09], which uses a different notion of comb-clasper, ordered according to the clasper degree.

### 3.2. Algebraic counterpart.

3.2.1. *Reduced group and commutators.* For any  $a, b$  in a group we denote  $[a, b] := aba^{-1}b^{-1}$ .

**Definition 3.9.** Let  $G$  be a group normally generated by  $\{x_1, \dots, x_n\}$ . We define  $J_G \triangleleft G$  to be the normal subgroup generated by elements of the form  $[x_i, \lambda x_i \lambda^{-1}]$ , for all  $i \in \{1, \dots, n\}$ , and for all  $\lambda \in G$ . We call *reduced quotient*, the quotient  $G/J_G$  and we denote it by  $\mathcal{R}G$ .

In what follows we work essentially with the free group  $F_n$  on  $n$  generators  $x_1, \dots, x_n$ . The reduced quotient  $\mathcal{R}F_n = F_n/J$  of the free group is called *reduced free group*, where  $J := J_{F_n}$ .

**Definition 3.10.** A *commutator in  $x_1, \dots, x_n$  of weight  $k$*  ( $k \geq 1$  is an element of  $F_n$  defined recursively, as follows:

- The commutators of weight one are  $x_1, \dots, x_n$ .
- The commutators of weight  $k$  are words  $[C_1, C_2]$  where  $C_1, C_2$  are commutators verifying  $k = \text{wg}(C_1) + \text{wg}(C_2)$  where  $\text{wg}(C)$  denotes the weight of  $C$ .

**Definition 3.11.** We denote  $\text{Occ}_i(C) = r$  and we say that  $x_i$  *occurs  $r$  times* in a commutator  $C$  if one of the following holds:

- If  $C = x_j$ , then  $r = 1$  if  $i = j$  and  $r = 0$  if  $i \neq j$ .
- If  $C = [C_1, C_2]$ , then  $r = \text{Occ}_i(C_1) + \text{Occ}_i(C_2)$ .

We say that a commutator  $C$  *has repeats* if  $\text{Occ}_i(C) > 1$  for some  $i$ . We call *support* of the commutator  $C$ , the set of indices  $i$  such that  $\text{Occ}_i(C) > 0$  and we denote it  $\text{supp}(C)$ .

The following is a reformulation of Definition 3.9 that is used throughout the paper.

**Proposition 3.12.** [Lev88, Proposition 3] *The subgroup  $J$  is generated by commutators in  $x_1, \dots, x_n$  with repeats. Hence they are trivial in the reduced free group.*

The notion of *basic commutators* was first introduced in [Hal33] and was further studied in [LS01; Hal59; MKS04] to describe the lower central series of the free group. It was then naturally adapted in [Lev88] to the framework of the reduced free group. In the next definition we set a well chosen *set of reduced basic commutators* that differs from [Lev88], and that will follow us throughout the whole paper.

**Definition 3.13.** We call *set of reduced basic commutators* the family denoted  $\mathcal{F}$  of commutators without repeats in  $\mathcal{R}F_n$  defined as follows:

$$\mathcal{F} = \{[i_1, \dots, i_l] \mid i_1 < i_k, 2 \leq k \leq l\}_{l \leq n}.$$

Here, we use the notation  $[i_1, i_2, \dots, i_l] := [[\dots [[x_{i_1}, x_{i_2}], x_{i_3}], \dots, x_{i_{l-1}}], x_{i_l}]$ . This is a finite set and we can thus choose an arbitrary order on it,  $\mathcal{F} = \{[\alpha_1], [\alpha_2], \dots, [\alpha_m]\}$ .

**Example 3.14.** For two commutators  $[\alpha] = [i_1 \dots i_l]$  and  $[\alpha'] = [i'_1 \dots i'_l]$  we can choose the order given by  $[\alpha] \leq [\alpha']$  if:

- $\text{wg}(\alpha) < \text{wg}(\alpha')$ , or
- $\text{wg}(\alpha) = \text{wg}(\alpha')$  and  $i_1 \dots i_l <_{\text{lex}} i'_1 \dots i'_l$ ,

where  $<_{\text{lex}}$  denotes the lexicographic order. With respect to this order the normal form of an element  $\omega \in \mathcal{R}F_3 = \langle x_1, x_2, x_3 \rangle$  is given by 8 integers  $\{e_1, \dots, e_8\}$  as follows:

$$\omega = [1]^{e_1} [2]^{e_2} [3]^{e_3} [12]^{e_4} [13]^{e_5} [23]^{e_6} [123]^{e_7} [132]^{e_8}.$$

The following theorem is a reduced version of Hall's basis theorem [Hal59, Theorem 11.2.4]. It is to be compared with [Lev88, Proposition 6], where a different family of reduced basic commutators is used, see Remark 3.17.

**Theorem 3.15.** *For any word  $\omega \in \mathcal{RF}_n$  there exists a unique set of integers  $\{e_1, \dots, e_m\}$  associated to the ordered set of reduced basic commutators  $\mathcal{F} = \{[\alpha_1], [\alpha_2], \dots, [\alpha_m]\}$  such that*

$$\omega = [\alpha_1]^{e_1} [\alpha_2]^{e_2} \cdots [\alpha_m]^{e_m}.$$

*Proof.* We first show for  $\omega \in \mathcal{RF}_n$  the existence of a decomposition  $\omega = \prod_{\alpha \in \mathcal{F}} [\alpha]^{e_\alpha}$ . We recall that two commutators commute up to commutators of strictly higher weight, and any commutator of weight bigger than  $n$  has repeats and is then trivial. Thus it is sufficient to express any commutator  $C$  as a product of commutators in  $\mathcal{F}$ . To do so we use the three following relations in  $\mathcal{RF}_n$ .

- (i)  $[X, Y]^{-1} = [Y, X] = [X^{-1}, Y] = [X, Y^{-1}]$  with  $X, Y$  commutators.
- (ii)  $[X, [Y, Z]] = [[X, Y], Z] \cdot [[X, Z], Y]^{-1}$  with  $X, Y, Z$  commutators.
- (iii)  $[UV, X] = [U, X][V, X]$  with  $U, V$  commutators such that  $\text{supp}(U) \cap \text{supp}(V) \neq \emptyset$ .

Relation (i) allows us to move the generator  $x_{i_1}$  with  $i_1 = \min(\text{supp}(C))$  at the desired position; we obtain  $C = [\cdots [x_{i_1}, C_1], \cdots, C_k]^{\pm 1}$ . Relations (i) and (ii) are used to decrease the weight of the commutator  $C_i$  in this expression. We start with  $C_1 = [C'_1, C'_2]$  supposing its weight is bigger than one, and we get:

$$\begin{aligned} C &= [\cdots [x_{i_1}, [C'_1, C'_2]], \cdots, C_k]^{\pm 1} \\ &= [\cdots [[x_{i_1}, C'_1], C'_2] \cdot [[x_{i_1}, C'_2], C'_1]^{-1}, \cdots, C_k]^{\pm 1} \\ &= [\cdots [x_{i_1}, C'_1], C'_2, \cdots, C_k]^{\pm 1} [\cdots [x_{i_1}, C'_2]^{-1}, C'_1, \cdots, C_k]^{\pm 1} \\ &= [\cdots [x_{i_1}, C'_1], C'_2, \cdots, C_k]^{\pm 1} [\cdots [x_{i_1}, C'_2], C'_1, \cdots, C_k]^{\mp 1} \end{aligned}$$

Since  $\text{wg}(C'_1) < \text{wg}(C)$  and  $\text{wg}(C'_2) < \text{wg}(C)$  we know that by iterating this operation on the new terms we can rewrite  $C$  as a product of commutators of the form  $[\cdots [x_{i_1}, x_{i_2}], C_2], \cdots, C_k]$ . We finish by repeating the process on  $C_2, \dots, C_k$ .

To prove the unicity of the decomposition we work with the unit group  $U_n$  of the ring of power series in noncommuting variables  $X_1, \dots, X_n$ . More precisely we consider its quotient  $\tilde{U}_n$  in which the monomials  $X^\alpha = X_{\alpha_1} X_{\alpha_2} \cdots X_{\alpha_n}$  vanish when they have repetition (i.e.  $\alpha_i = \alpha_j$  for some  $i \neq j$ ). The elements in  $\tilde{U}_n$  are of the form  $1 + Q$  with  $Q$  a sum of monomials of degree higher than one, and  $(1 + Q)^{-1} = 1 + \bar{Q}$  with  $\bar{Q} = -Q + Q^2 - Q^3 + \cdots (-1)^n Q^n$ . Now we can define the *reduced Magnus expansion*  $\tilde{M}$ . This is a homomorphism from the reduced free group  $\mathcal{RF}_n$  to  $\tilde{U}_n$ , defined by  $\tilde{M}(x_i) = 1 + X_i$ . The following computation shows that  $\tilde{M}$  respects the relations of the reduced free group, meaning that  $\tilde{M}([x_i, \lambda x_i \lambda^{-1}]) = 1$  for any generator  $x_i$  and any  $\lambda$  in  $\mathcal{RF}_n$ . Indeed:

$$\begin{aligned} \tilde{M}(\lambda x_i \lambda^{-1}) \tilde{M}(x_i) &= (1 + Q)(1 + X_i)(1 + \bar{Q})(1 + X_i) \\ &= 1 + 2X_i + Q + \bar{Q} + Q\bar{Q} + QX_i + QX_i + \bar{Q}X_i + Q\bar{Q}X_i + QX_i\bar{Q} \\ &= 1 + 2X_i + Q + \bar{Q} + Q\bar{Q} + QX_i + X_iQ + X_i\bar{Q} + X_iQ\bar{Q} + QX_i\bar{Q} \\ &= (1 + X_i)(1 + Q)(1 + X_i)(1 + \bar{Q}) \\ &= \tilde{M}(x_i) \tilde{M}(\lambda x_i \lambda^{-1}). \end{aligned}$$

We next have the following:

**Fact 3.16.** For every  $[\alpha] = [\alpha_1, \dots, \alpha_l] \in \mathcal{F}$ ,  $\tilde{M}([\alpha]) = 1 + X^\alpha + Q_l(X_{\alpha_1}, \dots, X_{\alpha_l})$  where  $Q_l$  is a sum of monomials of degree  $l = \text{wg}([\alpha])$  not starting by  $X_{\alpha_1}$ , and where each variable  $X_{\alpha_i}$  for  $i \in \{1, \dots, l\}$  appears exactly once.

This comes by induction on the weight  $l$  of  $[\alpha]$ . The case  $l = 1$  is clear since  $\tilde{M}(x_i) = 1 + X_i$ . Suppose the result true at rank  $l$ , then

$$\begin{aligned}\tilde{M}([\alpha, \alpha_{l+1}]) &= \tilde{M}([\alpha], x_{\alpha_{l+1}}) \\ &= [\tilde{M}([\alpha]), \tilde{M}(x_{\alpha_{l+1}})] \\ &= [1 + X^\alpha + Q_l(X_{\alpha_1}, \dots, X_{\alpha_l}), 1 + X_{\alpha_{l+1}}]\end{aligned}$$

with  $Q_l(X_{\alpha_1}, \dots, X_{\alpha_l})$  as desired by the induction hypothesis. Then we develop the commutator and we get

$$\tilde{M}([\alpha, \alpha_{l+1}]) = 1 + X^\alpha X_{\alpha_{l+1}} + Q_l(X_{\alpha_1}, \dots, X_{\alpha_l}) X_{\alpha_{l+1}} - X_{\alpha_{l+1}} Q_l(X_{\alpha_1}, \dots, X_{\alpha_l}) - X_{\alpha_{l+1}} X^\alpha$$

which, by identifying  $Q_{l+1}(X_{\alpha_1}, \dots, X_{\alpha_{l+1}})$ , proves Fact 3.16.

Returning to the proof of unicity, we take  $\omega = \prod_{\alpha \in \mathcal{F}} [\alpha]^{e_\alpha} = \prod_{\alpha \in \mathcal{F}} [\alpha]^{e'_\alpha}$  two decompositions of an element  $\omega \in \mathcal{R}F_n$ . We prove by induction on the weight of  $[\alpha]$  that  $e_\alpha = e'_\alpha$  for any commutator  $[\alpha] \in \mathcal{F}$ . Applying  $\tilde{M}$ , we get

$$1 + \sum_{\text{wg}([\alpha])=1} e_\alpha X^\alpha + (\text{terms of degree } \geq 2) = 1 + \sum_{\text{wg}([\alpha])=1} e'_\alpha X^\alpha + (\text{terms of degree } \geq 2)$$

hence  $e_\alpha = e'_\alpha$  for any  $[\alpha]$  of weight one. Suppose that  $e_\alpha = e'_\alpha$  for any  $[\alpha]$  of weight  $< k$  and compare the coefficient of monomial  $X^\alpha$  in both  $\tilde{M}(\prod_{\alpha \in \mathcal{F}} [\alpha]^{e_\alpha})$  and  $\tilde{M}(\prod_{\alpha \in \mathcal{F}} [\alpha]^{e'_\alpha})$  for  $[\alpha]$  a fixed commutator of degree  $k$ . According to Fact 3.16, commutators of weight  $> k$  do not contribute to this coefficient and the only contributing weight  $k$  commutator is  $[\alpha]$  itself with coefficient  $e_\alpha$ , resp.  $e'_\alpha$ . Commutators of weight  $< k$  may also contribute to this coefficient but the induction hypothesis ensures that the contribution is the same in both expressions. This proves that  $e_\alpha = e'_\alpha$  for any  $[\alpha]$  of weight  $k$  and concludes the proof.  $\square$

**Remark 3.17.** By focusing on the monomial  $X^\alpha$ , this proof does not require the injectivity of the reduced Magnus expansion [Yur08].

**Definition 3.18.** To the ordered set of basic commutators  $\mathcal{F} = \{[\alpha_1], \dots, [\alpha_m]\}$  in  $\mathcal{R}F_n$  we associate a  $\mathbf{Z}$ -module  $\mathcal{V}$  formally generated by  $\{\alpha_1, \dots, \alpha_m\}$ . We also define the linearization map  $\phi : \mathcal{R}F_n \rightarrow \mathcal{V}$  by:

$$\phi(\omega) = e_1 \alpha_1 + \dots + e_m \alpha_m \quad \text{where } [\alpha_1]^{e_1} \dots [\alpha_m]^{e_m} \text{ is the normal form of } \omega.$$

We keep calling "commutators" the generators of  $\mathcal{V}$  and we define the support and the weight of  $\alpha$  to be those of  $[\alpha]$ .

We stress that the normal form and the linearization map  $\phi$  both depend on the ordering on  $\mathcal{F}$ .

**Lemma 3.19.** *The  $\mathbf{Z}$ -module  $\mathcal{V}$  is of rank,*

$$rk(\mathcal{V}) = \sum_{0 \leq l \leq k < n} \frac{k!}{l!}.$$

Moreover we can decompose  $\mathcal{V}$  into a direct sum of submodules  $\mathcal{V}_i$  generated by the commutators of weight  $i$ . Then we obtain that:

$$rk(\mathcal{V}_i) = \sum_{i-1 \leq k < n} \frac{k!}{(k-i+1)!}.$$

*Proof.* The first equality comes by counting the cardinality of  $\mathcal{F}$ . To do so we first count the elements  $[\alpha]$  with first term  $\alpha_1 = k$ . To choose  $\alpha_2, \alpha_3, \dots, \alpha_l$  with  $0 \leq l < n - k$  we only have to respect the condition that  $\alpha_1 < \alpha_i$ . Thus they can be freely chosen in  $\{k + 1, \dots, n\}$  and therefore:

$$rk(\mathcal{V}) = \sum_{k=1}^n \sum_{l=0}^{n-k} \frac{(n-k)!}{(n-k-l)!} = \sum_{k=0}^{n-1} \sum_{l=0}^k \frac{k!}{(k-l)!} = \sum_{k=0}^{n-1} \sum_{l=0}^k \frac{k!}{l!}.$$

For the second equality, we follow the same kind of reasoning, but this time  $\alpha_1 = k$  must be chosen in  $\{1, \dots, n - i + 1\}$ , then we choose the  $i - 1$  last numbers  $\alpha_2, \dots, \alpha_i$  without restriction in  $\{k + 1, \dots, n\}$ . We obtain:

$$rk(\mathcal{V}_i) = \sum_{k=1}^{n-i+1} \frac{(n-k)!}{(n-k-i+1)!} = \sum_{k=0}^{i-1} \frac{k!}{(k-i+1)!}.$$

□

**3.2.2. Braid groups.** In this section we use the usual Artin braid generators  $\sigma_i$  for  $i \in \{1, \dots, n - 1\}$  illustrated in Figure 8 and the usual pure braid generators  $A_{ij} = \sigma_{j-1}\sigma_{j-2} \cdots \sigma_{i+1}\sigma_i^2\sigma_{i+1}^{-1} \cdots \sigma_{j-2}^{-1}\sigma_{j-1}^{-1}$  for  $1 \leq i < j \leq n$  illustrated in Figure 9.

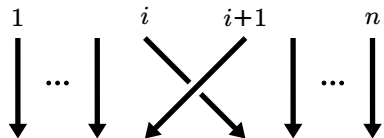

FIGURE 8. The Artin generator  $\sigma_i$ .

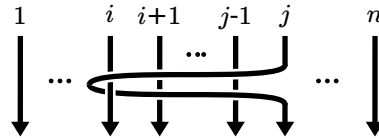

FIGURE 9. The pure braid generator  $A_{ij}$ .

The following theorem is based on the result of [Gol74].

**Theorem 3.20.** *Let  $J \triangleleft B_n$  denote the normal subgroup generated by all elements of the form  $[A_{ij}, \lambda A_{ij} \lambda^{-1}]$  where  $\lambda$  belongs to  $P_n$ . We obtain the homotopy braid group  $\tilde{B}_n$  as the quotient:*

$$\tilde{B}_n = B_n/J.$$

*Proof.* In [Gol74], the homotopy braid group  $\tilde{B}_n$  appears as the quotient  $B_n/J'$ , where  $J' \triangleleft B_n$  is the normal subgroup generated by elements of the form  $[A_{ij}, \lambda A_{ij} \lambda^{-1}]$  where  $\lambda$  belongs to the normal subgroup generated by  $\{A_{1,j}, \dots, A_{j-1,j}\}$ . Our result relies on the observation that  $J = J'$ . Obviously  $J' \subset J$  thus we only need to show that  $J \subset J'$ . This is equivalent to showing that for any  $\Lambda \in P_n$ ,  $A_{ij}$  and  $\Lambda A_{ij} \Lambda^{-1}$  commute up to link-homotopy. Let us remind that  $A_{ij}$  is the surgery result  $\mathbf{1}^{(ij)}$  of the comb-clasper  $(ij)$ . Thus the conjugate  $\Lambda A_{ij} \Lambda^{-1}$  is the surgery result of the clasper  $C = \iota(ij)$ , where  $\iota$  is the ambient isotopy sending  $\Lambda \Lambda^{-1}$  to the trivial braid  $\mathbf{1}$ . Now it is clear that  $\text{supp}(C) = \text{supp}(\alpha)$ , hence according to Remark 2.8,  $(ij)C \sim C(ij)$  and the result is proved. □

In order to obtain a similar result for the pure homotopy braid group we need the following.

**Lemma 3.21.** *The subgroup  $J \triangleleft B_n$  normally generated in  $B_n$  by elements of the form  $[A_{ij}, \lambda A_{ij} \lambda^{-1}]$  for  $\lambda \in P_n$ , seen as a subgroup of  $P_n$ , coincides with the normal subgroup of  $P_n$  generated by elements of the form  $[A_{ij}, \lambda A_{ij} \lambda^{-1}]$  for  $\lambda \in P_n$ .*

*Proof.* For  $k \in \{1, \dots, n-1\}$ ,  $1 \leq i < j \leq n$  and  $\lambda \in P_n$  we compute:

$$\sigma_k[A_{ij}, \lambda A_{ij} \lambda^{-1}] \sigma_k^{-1} = \begin{cases} [A_{i+1j}, \lambda_1 A_{i+1j} \lambda_1^{-1}] & \text{if } i = k \text{ and } j \neq k+1 \\ [A_{i+1j}, \lambda_2 A_{i+1j} \lambda_2^{-1}] & \text{if } j = k \\ A_{kk+1}[A_{i-1j}, \lambda_3 A_{i-1j} \lambda_3^{-1}] A_{kk+1}^{-1} & \text{if } i = k+1 \\ A_{kk+1}[A_{ij-1}, \lambda_4 A_{ij-1} \lambda_4^{-1}] A_{kk+1}^{-1} & \text{if } i \neq k \text{ and } j = k+1 \\ [A_{ij}, \lambda A_{ij} \lambda^{-1}] & \text{otherwise,} \end{cases}$$

with  $\lambda_i \in P_n$  for  $i \in \{1, 2, 3, 4\}$ . Therefore the conjugates  $\sigma_k[A_{ij}, \lambda A_{ij} \lambda^{-1}] \sigma_k^{-1}$  are always conjugates of  $[A_{i'j'}, \lambda' A_{i'j'} (\lambda')^{-1}]$  in  $\tilde{P}_n$  for some  $1 \leq i' < j' \leq n$  and  $\lambda' \in P_n$  and the proof is done.  $\square$

**Corollary 3.22.** *Let  $J \triangleleft P_n$  be the normal subgroup generated by elements of the form  $[A_{ij}, \lambda A_{ij} \lambda^{-1}]$  for any  $\lambda \in P_n$ . We obtain the pure homotopy braid group  $\tilde{P}_n$  as the following quotient:*

$$\tilde{P}_n = P_n / J = \mathcal{R}P_n.$$

This induces the following presentation for  $\tilde{P}_n$ :

$$\tilde{P}_n = \left\langle A_{ij} \left[ \begin{array}{ll} [A_{rs}, A_{ij}] = 1 & r < s < i < j \text{ or } r < i < j < s \\ [A_{rs}, A_{rj}] = [A_{rj}, A_{sj}] = [A_{sj}, A_{rs}] & r < s < j \\ [A_{ri}, A_{sj}] = [[A_{ij}, A_{rj}], A_{sj}] & r < s < i < j \\ [A_{ij}, \lambda A_{ij} \lambda^{-1}] = 1 & i < j \text{ and } \lambda \in \tilde{P}_n \end{array} \right. \right\rangle.$$

*Proof.* The quotient statement is a direct consequence of Proposition 3.20 and Lemma 3.21. The presentation is obtained from that of [MK99, Theorem 3.8] re-expressed in terms of commutator and using the relation  $[A_{rs}, A_{ij}^{-1}] = [A_{rs}, A_{ij}]^{-1}$  which holds in  $\tilde{P}_n$ .  $\square$

We next recall two classical representations of braid groups that are known to be faithful (see [Art47] and [HL90] for more details).

**Definition 3.23.** We call *Artin representation* the homomorphism  $\rho : B_n \rightarrow \text{Aut}(F_n)$  defined as follows:

$$\rho(\sigma_i) : \begin{cases} x_i & \mapsto x_{i+1}, \\ x_{i+1} & \mapsto x_{i+1} x_i x_{i+1}^{-1}, \\ x_k & \mapsto x_k \end{cases} \quad \text{if } k \notin \{i, i+1\}.$$

Similarly the homomorphism  $\tilde{\rho} : \tilde{B}_n \rightarrow \text{Aut}(\mathcal{R}F_n)$  defined by the same expressions is called the *homotopic Artin representation*.

### 3.3. A linear faithful representation of the homotopy braid group $\tilde{B}_n$ .

3.3.1. *Algebraic definition.* In order to define the linear representation  $\gamma : \tilde{B}_n \rightarrow GL(\mathcal{V})$ , we state the following preparatory lemma.

**Lemma 3.24.** *Let  $\beta \in \tilde{B}_n$  be a homotopy braid and  $N_j$  be the abelian group normally generated by  $x_j$  in  $\mathcal{R}F_n$ . For any reduced basic commutator  $[\alpha] \in N_j$ , if we set  $[\alpha_1]^{e_1} \dots [\alpha_m]^{e_m}$  a normal form of  $\tilde{\rho}(\beta)([\alpha])$  then we have that  $e_i = 0$  if  $[\alpha_i] \notin N_{\pi^{-1}(\beta)(j)}$ . Here  $\pi^{-1}(\beta)(j)$  is the image of  $j$  under the permutation induced by  $\beta$ .*

In other words in the image by  $\tilde{\rho}(\beta)$  of  $[\alpha] \in N_j$ ,  $x_{\pi^{-1}(\beta)(j)}$  occurs in each factor of the normal form.

*Proof.* The proof comes from the fact that any element of  $N_j$  is sent by  $\tilde{\rho}(\beta)$  to an element of  $N_{\pi^{-1}(\beta)(j)}$ . This is clear for the Artin generators  $\sigma_i$  and so it is for any braid  $\beta$ . Thus we conclude using the fact that the normal form  $\omega = C_1^{e_1} \dots C_m^{e_m}$  of any element  $\omega \in N_k$ , for any  $k$  contains only commutators

in  $N_k$ . To see this we use the homomorphism of  $\mathcal{RF}_n$  defined by  $x_k \mapsto 1$  which sends the normal form of  $\omega$  to  $\mathbf{1}$ .  $\square$

Recall from Definition 3.18 the linearization map  $\phi : \mathcal{RF}_n \rightarrow \mathcal{V}$ .

**Theorem 3.25.** *The map*

$$\gamma : \tilde{B}_n \rightarrow GL(\mathcal{V})$$

defined for  $\beta \in \tilde{B}$  and  $[\alpha] \in \mathcal{F}$  by  $\gamma(\beta)(\alpha) = \phi \circ \tilde{\rho}(\beta)([\alpha])$  is a well defined homomorphism. Moreover  $\gamma$  does not depend on the chosen order on  $\mathcal{F}$  i.e. if we change the ordering on  $\mathcal{F}$  then we change the map  $\phi$  but not  $\gamma$ .

*Proof.* Since  $\phi$  is not a homomorphism in general, it is not clear that  $\gamma$  is a representation. Yet we do have that  $\gamma(\beta\beta') = \gamma(\beta)\gamma(\beta')$  for any two homotopy braids  $\beta$  and  $\beta'$ . Let  $[\alpha]$  be a reduced basic commutator and  $\alpha$  its corresponding commutator in  $\mathcal{V}$ . We choose some  $j \in \text{supp}([\alpha])$  so that  $[\alpha]$  is in  $N_j$ . Set  $\gamma(\beta')(\alpha) = \sum_i \alpha_i$  for some commutators  $\alpha_i \in \mathcal{V}$  associated to the reduced basic commutators  $[\alpha_i]$ . Then we have that

$$\gamma(\beta\beta')(\alpha) = \phi \circ \tilde{\rho}(\beta)\tilde{\rho}(\beta')([\alpha]) = \phi \circ \tilde{\rho}(\beta) \left( \prod_i [\alpha_i] \right) = \phi \left( \prod_i \tilde{\rho}(\beta)([\alpha_i]) \right).$$

Now, using Lemma 3.24 we know that  $[\alpha_i]$  is in  $N_{\pi^{-1}(\beta')(j)}$  for any  $i$ . Besides, Lemma 3.24 implies that any commutator in the normal form of  $\tilde{\rho}(\beta)([\alpha_i])$  is in the abelian group  $N_{\pi^{-1}(\beta\beta')(j)}$  for any  $i$ . But note that for  $C_1, \dots, C_k$  a collection of basic reduced commutators such that  $[C_i, C_j] = 1$  for any  $i, j$  we have that  $\phi(C_1 \cdots C_k) = \phi(C_1) + \cdots + \phi(C_k)$ . Hence  $\phi$  behaves like a homomorphism on the product  $\prod_i \tilde{\rho}(\beta)([\alpha_i])$ , and finally,

$$\phi \left( \prod_i \tilde{\rho}(\beta)([\alpha_i]) \right) = \sum_i \phi \left( \tilde{\rho}(\beta)([\alpha_i]) \right) = \sum_i \gamma(\beta)(\alpha_i) = \gamma(\beta) \left( \sum_i (\alpha_i) \right) = \gamma(\beta)\gamma(\beta')(\alpha)$$

and  $\gamma$  is a well defined homomorphism.

To prove the independence on the chosen order on  $\mathcal{F}$  we use Lemma 3.24 again. For any  $\beta \in \tilde{B}_n$  and any  $[\alpha] \in \mathcal{F}$ , all the commutators in the normal form of  $\tilde{\rho}(\beta)([\alpha])$  commute with each other. In particular if we set two orderings  $\{[\alpha_1], \dots, [\alpha_m]\}$  and  $\{[\alpha_{\sigma(1)}], \dots, [\alpha_{\sigma(m)}]\}$  on  $\mathcal{F}$  then the two associated normal forms:

$$\tilde{\rho}(\beta)([\alpha]) = [\alpha_1]^{e_1} \cdots [\alpha_m]^{e_m} = [\alpha_{\sigma(1)}]^{e'_{\sigma(1)}} \cdots [\alpha_{\sigma(m)}]^{e'_{\sigma(m)}}$$

satisfy  $e_i = e'_i$  for any  $i$  and therefore  $\phi \circ \tilde{\rho} = \phi' \circ \tilde{\rho}$  for the two linearization maps  $\phi$  and  $\phi'$  associated to the orderings.  $\square$

**Remark 3.26.** The homomorphism  $\gamma$  is in fact injective. Since  $\phi$  is clearly injective, this can be shown using the injectivity of  $\tilde{\rho}$ , proved in [HL90]. However we will give below another proof of this result in Theorem 3.33 using clasper calculus, which in turn reproves the injectivity of  $\tilde{\rho}$ . Furthermore our approach by clasper calculus allows for explicit computations of the representation, as shown in the next section.

**3.3.2. Clasper interpretation.** We first give a topological interpretation of the Artin, resp. homotopic Artin, representation. We can see the free group  $F_n$ , resp. reduced free group  $\mathcal{RF}_n$ , on which  $B_n$ , resp.  $\tilde{B}_n$ , acts as the fundamental group, resp. the reduced fundamental group, of the complement of the  $n$ -component trivial braid. Therefore an element of  $F_n$ , resp.  $\mathcal{RF}_n$ , can also be seen as the homotopy, resp. the *reduced homotopy*<sup>2</sup>, class of an  $(n+1)$ -th component in this complement. On

<sup>2</sup>Here by *reduced homotopy class*, we mean the image in the reduced quotient of the homotopy class of an element.

the diagram, we place this new strand to the right of the braid and we label it by " $\infty$ ". Thus, the generators  $x_i$  of  $F_n$  (resp  $\mathcal{R}F_n$ ) are given by the pure braids  $A_{i\infty}$  shown in Figure 10, which can be reinterpreted with the comb-claspers  $(i,\infty)$  depicted in the same figure. There and in subsequent figures, we simply represent with a circled " $\infty$ " the leaf intersecting the  $\infty$ -th component.

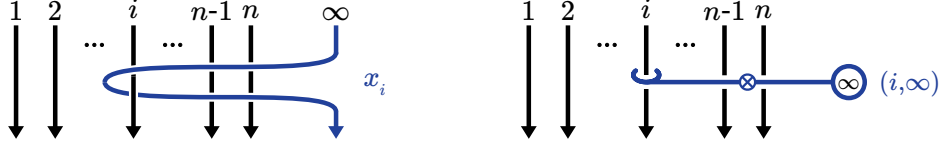

FIGURE 10. Pure braid and clasper interpretations of the generator  $x_i$ .

In this context the image  $\rho(\beta)$  of an element  $\beta \in B_n$ , resp.  $\tilde{B}_n$ , is given on a generator  $x_i \in F_n$ , resp.  $\mathcal{R}F_n$ , by considering the conjugation  $\beta \mathbf{1}^{(i,\infty)} \beta^{-1}$  illustrated in Figure 11. Then we apply an isotopy,

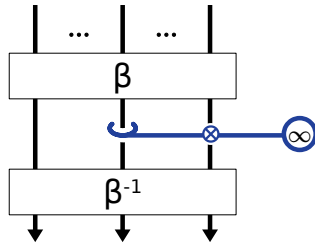

FIGURE 11. Clasper interpretation of the Artin representation.

transforming  $\beta \mathbf{1} \beta^{-1}$  into  $\mathbf{1}$ . By doing so the clasper  $(i,\infty)$  is deformed into a new clasper which we are able to reinterpret as an element of  $F_n$  or  $\mathcal{R}F_n$ . More precisely in the link-homotopic case we have a nice correspondence between the family  $\mathcal{F}$  and the comb-claspers with  $\infty$  in their support, by the following proposition.

**Proposition 3.27.** *Let  $(\alpha) = (i_1 \cdots i_{n-1} \infty)$  and  $(\alpha') = (i_1 \cdots i_{n-1} i_n \infty)$  be two comb-claspers. Then we have the relation:*

$$(\alpha') \sim [(\alpha), (i_n \infty)] = (\alpha) \cdot (i_n \infty) \cdot (\alpha)^{-1} \cdot (i_n \infty)^{-1}.$$

For example in Figure 12 we illustrate the equivalence  $(1254\infty) \sim [(125\infty), (4\infty)]$ .

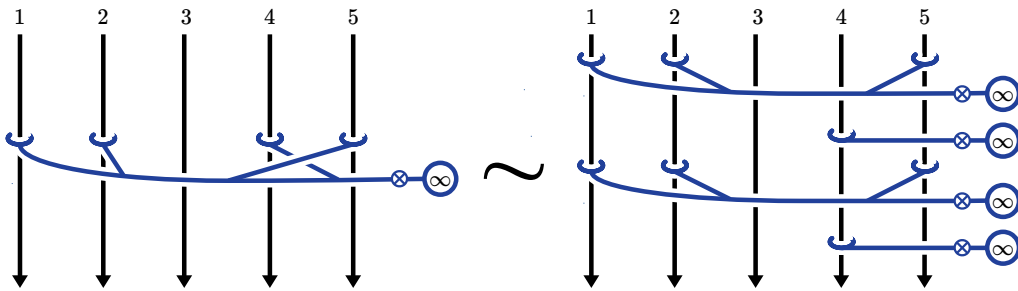

FIGURE 12. The comb-clasper  $(1254\infty)$  is link-homotopic to the comutator  $[(125\infty)(4\infty)]$ .



*Proof.* Consider the product of comb-claspers  $\alpha \cdot (i_n \infty) \cdot \alpha^{-1} \cdot (i_n \infty)^{-1}$  (as for example on the right hand side of Figure 12). First we use move (2) from Corollary 2.7 to exchange the  $\infty$ -th leaves of  $(i_n \infty)$  and  $(\alpha)^{-1}$ ; this move creates an extra comb-clasper, which is exactly  $(\alpha')$ . Now by Remark 2.8 we can freely move  $(\alpha')$  and finish exchanging the edges of  $(\alpha_n \infty)$  and  $(\alpha)^{-1}$ , thus obtaining the product  $(\alpha) \cdot (\alpha)^{-1} \cdot (\alpha') \cdot (i_n \infty) \cdot (i_n \infty)^{-1} \sim (\alpha')$ .  $\square$

By iterating this proposition we obtain a correspondence between the commutators  $[\alpha] \in \mathcal{F}$  (or  $\alpha \in \mathcal{V}$ ) and the comb-claspers  $(\alpha, \infty)$ . For example the equivalence  $(1254 \infty) \sim [(((1 \infty), (2 \infty)), (5 \infty)), (4 \infty)]$  corresponds to  $[1254] = [([x_1, x_2], x_5), x_4]$  in  $\mathcal{RF}_n$ .

In this way, we obtain an explicit procedure to compute our representation  $\gamma$  using clasper calculus, as follows. As illustrated in the proof of Theorem 3.28 below, the computation of  $\gamma(\beta)(\alpha)$  with  $\gamma$  the representation,  $\beta \in \tilde{B}_n$  and  $\alpha \in \mathcal{V}$ , goes in 3 steps:

**Step 1:** Consider the conjugate of the comb-clasper  $(\alpha, \infty)$  by the braid  $\beta$ .

**Step 2:** Use clasper calculus to re-express this conjugate as an ordered union of comb-claspers with  $\infty$  in their support (the order comes from the order on  $\mathcal{F}$ ).

**Step 3:** The number of parallel copies of a given comb-clasper in this product is the coefficient of the associated commutator in  $\gamma(\beta)(\alpha)$ .

We apply in Theorem 3.28 this procedure<sup>3</sup> for each generator  $\sigma_i \in \tilde{B}_n$  and each commutator in  $\mathcal{V}$ . The image of commutator  $(i_1, i_2, \dots, i_l) := \phi([i_1, i_2, \dots, i_l]) \in \mathcal{V}$  by the map  $\gamma(\sigma_i)$  depends of the position of the indices  $i$  and  $i + 1$  in the sequence  $i_1, i_2, \dots, i_l$ .

**Theorem 3.28.** *For suitable sequences  $I, J, K$  in  $\{1, \dots, n\} \setminus \{i, i + 1\}$ ,  $I \neq \emptyset$ , we have:*

$$\gamma(\sigma_i) : \begin{cases} (I) & \mapsto (I) & (a) \\ (J, i, K) & \mapsto (J, i + 1, K) & (b) \\ (i + 1, K) & \mapsto (i, K) + (i, i + 1, K) & (c) \\ (I, i + 1, K) & \mapsto (I, i, K) + (I, i, i + 1, K) - (I, i + 1, i, K) & (d) \\ (I, i, J, i + 1, K) & \mapsto (I, i + 1, J, i, K) & (e) \\ (I, i + 1, J, i, K) & \mapsto (I, i, J, i + 1, K) & (f) \\ (i, J, i + 1, K) & \mapsto \sum_{J' \subseteq J} (-1)^{|J'|+1} (i, \overline{J'}, i + 1, J \setminus J', K) & (g) \end{cases}$$

where in (g), the sum is over all (possibly empty) subsequences  $J'$  of  $J$ , and  $\overline{J'}$  denotes the sequence obtained from  $J'$  by reversing the order of its elements, see Example 3.29.

**Example 3.29.** If  $J = (J_1, J_2, J_3)$  and  $K = \emptyset$  in (g), then  $\gamma(\sigma_i)$  maps  $(i, J, i + 1)$  to :

$$\begin{aligned} & -(i, i + 1, J_1, J_2, J_3) + (i, J_1, i + 1, J_2, J_3) + (i, J_2, i + 1, J_1, J_3) + (i, J_3, i + 1, J_1, J_2) \\ & -(i, J_2, J_1, i + 1, J_3) - (i, J_3, J_1, i + 1, J_2) - (i, J_3, J_2, i + 1, J_1) + (i, J_3, J_2, J_1, i + 1). \end{aligned}$$

The proof below explains how this follows from the IHX relations of Figure 17.

*Proof of Theorem 3.28.* Following the procedure given above, we consider the conjugate  $\sigma_i^{-1}(\alpha, \infty)\sigma_i$  and apply clasper calculus to turn it into a union of comb-claspers.

For (a) it is clear that  $(I, \infty)$  commutes with  $\sigma_i$ , passing over or next to it. The computation of (b) is given by a simple isotopy of the braid shown in Figure 13.

The proofs of (c) and (d) are similar and are given in Figures 14 and 15 respectively. There, the first equivalence is an isotopy, and the second one is given by move (2) from Corollary 2.7. For (d) there is a further step given by an *IHX* relation.

<sup>3</sup>A program that computes explicitly the representation  $\gamma$  is available on

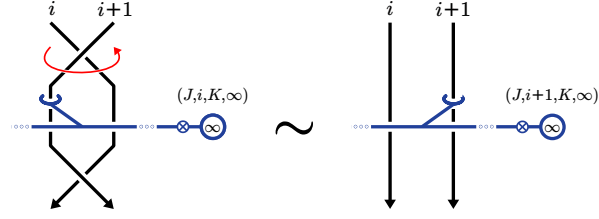

FIGURE 13. Computation of (b).

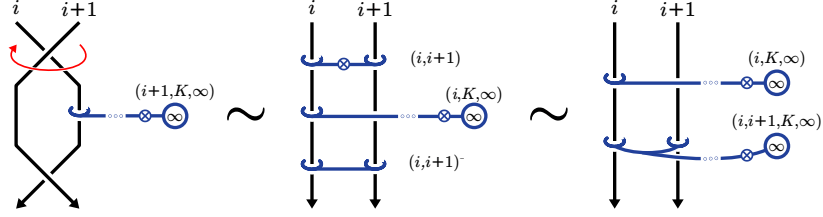

FIGURE 14. Computation of (c).

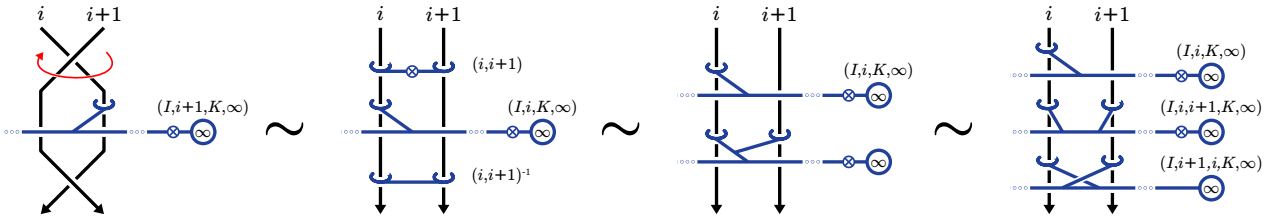
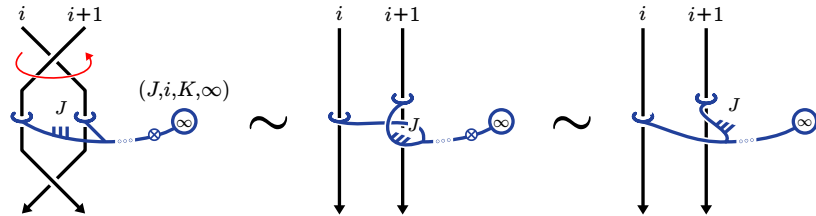

FIGURE 15. Computation of (d).

For (e) and (f) we apply the same isotopy as Figure 13 on component  $i$  and  $i+1$  thus interchanging  $(I,i,J,i+1,K)$  and  $(I,i+1,J,i,K)$ . Note that we also need a crossing change between the  $(i+1)$ -th component and a clasper edge, which is possible according to Remark 2.8.

Proving (g) is the last and hardest part and goes in two steps. The first step is illustrated in Figure 16: we proceed as before with an isotopy and a crossing change, then we use move (8) of Lemma 2.10. This turn  $\sigma_i(i,J,i+1,K,\infty)\sigma_i^{-1}$  into a new clasper which is not a comb-clasper.

 FIGURE 16. Turning  $\sigma_i(i,J,i+1,K,\infty)\sigma_i^{-1}$  into a new clasper.

In the second step, we use the IHX relations repeatedly to turn this new clasper into a product of comb-claspers. This is illustrated in Figure 17 where  $J = (J_1, J_2, J_3)$ . We conclude by simplifying the twists with Remark 2.11.  $\square$

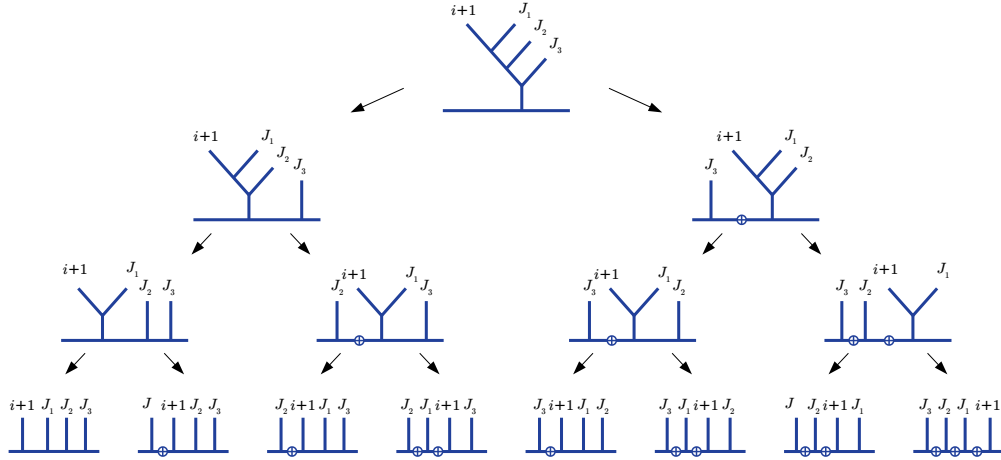

FIGURE 17. Iterated IHX relations.

**Example 3.30.** We illustrate Theorem 3.28 on the 3-component homotopy braid group  $\tilde{B}_3$ . To do so, we set  $(1), (2), (3), (12), (13), (23), (123), (132)$  to be the generators of  $\mathcal{V}$ , with the order of Example 3.14, and we compute  $\gamma$  on the Artin generators  $\sigma_1, \sigma_2$ :

$$\begin{array}{ll}
 \gamma(\sigma_1)(1) = (2) & \gamma(\sigma_2)(1) = (1) \\
 \gamma(\sigma_1)(2) = (1) + (12) & \gamma(\sigma_2)(2) = (3) \\
 \gamma(\sigma_1)(3) = (3) & \gamma(\sigma_2)(3) = (2) + (23) \\
 \gamma(\sigma_1)(12) = -(12) & \gamma(\sigma_2)(12) = (13) \\
 \gamma(\sigma_1)(13) = (23) & \gamma(\sigma_2)(13) = (12) + (123) - (132) \\
 \gamma(\sigma_1)(23) = (13) + (123) & \gamma(\sigma_2)(23) = -(23) \\
 \gamma(\sigma_1)(123) = -(123) & \gamma(\sigma_2)(123) = (132) \\
 \gamma(\sigma_1)(132) = -(123) + (132) & \gamma(\sigma_2)(132) = (123)
 \end{array}$$

That gives us the following matrices:

$$\gamma(\sigma_1) = \begin{pmatrix} 0 & 1 & 0 & 0 & 0 & 0 & 0 & 0 \\ 1 & 0 & 0 & 0 & 0 & 0 & 0 & 0 \\ 0 & 0 & 1 & 0 & 0 & 0 & 0 & 0 \\ 0 & 1 & 0 & -1 & 0 & 0 & 0 & 0 \\ 0 & 0 & 0 & 0 & 0 & 1 & 0 & 0 \\ 0 & 0 & 0 & 0 & 1 & 0 & 0 & 0 \\ 0 & 0 & 0 & 0 & 0 & 1 & -1 & -1 \\ 0 & 0 & 0 & 0 & 0 & 0 & 0 & 1 \end{pmatrix} \quad \gamma(\sigma_2) = \begin{pmatrix} 1 & 0 & 0 & 0 & 0 & 0 & 0 & 0 \\ 0 & 0 & 1 & 0 & 0 & 0 & 0 & 0 \\ 0 & 1 & 0 & 0 & 0 & 0 & 0 & 0 \\ 0 & 0 & 0 & 0 & 1 & 0 & 0 & 0 \\ 0 & 0 & 0 & 1 & 0 & 0 & 0 & 0 \\ 0 & 0 & 1 & 0 & 0 & -1 & 0 & 0 \\ 0 & 0 & 0 & 0 & 1 & 0 & 0 & 1 \\ 0 & 0 & 0 & 0 & -1 & 0 & 1 & 0 \end{pmatrix}.$$

The global shape of these matrices was predicted by Theorem 3.28. Indeed in general we have the following.

**Proposition 3.31.** For  $\beta \in \tilde{B}_n$  a homotopy braid, the matrix associated to  $\gamma(\beta)$  in the basis  $\mathcal{F}$ , endowed with the order of Example 3.14, is given by a lower triangular block matrix of the following form:

$$\begin{pmatrix} B_{1,1} & 0 & \cdots & 0 \\ B_{2,1} & B_{2,2} & \cdots & 0 \\ \vdots & \vdots & \ddots & \vdots \\ B_{n,1} & B_{n,2} & \cdots & B_{n,n} \end{pmatrix}$$

where  $B_{i,i}$  is a finite order matrix of size  $rk(\mathcal{V}_i) = \sum_{i-1}^n \frac{k!}{(k-i+1)!}$  which is the identity when  $\beta$  is pure. Moreover  $B_{1,1}$  corresponds to the left action by permutation  $k \mapsto \pi^{-1}(\beta)(k)$ , and  $B_{2,2}$  corresponds to the left action on the set  $\{(k,j)\}_{k < j}$  given by:

$$(k,j) \mapsto \begin{cases} (\pi^{-1}(\beta)(k), \pi^{-1}(\beta)(j)) & \text{if } \pi^{-1}(\beta)(k) < \pi^{-1}(\beta)(j) \\ -(\pi^{-1}(\beta)(j), \pi^{-1}(\beta)(k)) & \text{if } \pi^{-1}(\beta)(j) < \pi^{-1}(\beta)(k) \end{cases} .$$

*Proof.* The triangular shape is a direct consequence of Theorem 3.28. Indeed, the chosen order respects the weight, and Theorem 3.28 shows that  $\gamma$  maps a commutator of weight  $k$  to a sum of commutators of weight at least  $k$ . Proposition 3.19 gives the size of the square diagonal blocks  $B_{i,i}$ . The fact that these diagonal blocks are the identity when  $\beta$  is a pure braid may need some more explanations. We only need to show this result on the generators  $\beta = A_{i,j} = \mathbf{1}^{(i,j)}$ . By Corollary 2.7, conjugating  $(\alpha, \infty)$  by  $(i,j)$  may only creates a clasper  $(\alpha', \infty)$  of strictly higher degree. This shows that  $\gamma(\beta)(\alpha) = (\alpha) +$  (strictly higher weight commutators) so that  $B_{i,i}$  is the identity. The block matrix  $B_{1,1}$  describes the action on degree one comb-claspers modulo claspers of higher degree: the claim follows on an easy verification on the generators  $\sigma_i$ . Similarly the claim on the block matrix  $B_{2,2}$  amounts to focusing on degree two comb-claspers.  $\square$

In order to prove the injectivity of  $\gamma$  we need the following preparatory lemma.

**Lemma 3.32.** Let  $(i_1, \dots, i_l)$  be a comb-clasper. We have

$$\gamma(\mathbf{1}^{(i_1, \dots, i_l)})(i_l) = (i_l) - (i_1, \dots, i_l),$$

where, on the right hand side,  $(i_1, \dots, i_l)$  now designates the corresponding commutator in  $\mathcal{V}$ .

*Proof.* Consider the product  $(i_1, \dots, i_l)(i_d, \infty)(i_1, \dots, i_l)^{-1}$  and re-express it with only comb-claspers with  $\infty$  in their support. To do so, as illustrated in Figure 18, we apply move (2) from Corollary 2.7 on the leaves on the  $i_d$ -th component, which introduces the comb-clasper  $(i_1, \dots, i_l, \infty)^{-1}$ , and we simplify  $(i_1, \dots, i_l)$  and  $(i_1, \dots, i_l)^{-1}$ .  $\square$

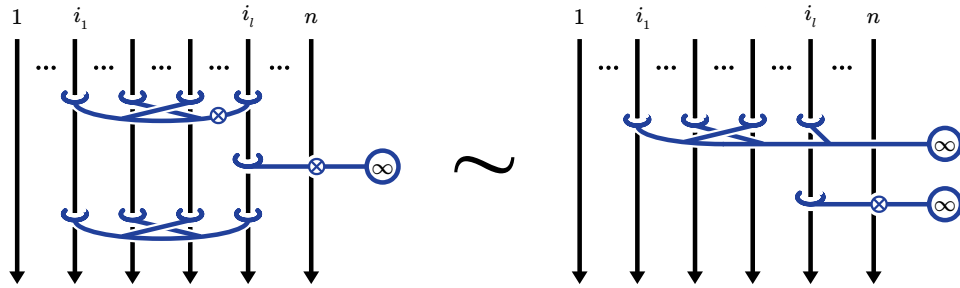

FIGURE 18. Proof of Lemma 3.32.

We can now state the injectivity of the representation  $\gamma$ .

**Theorem 3.33.** *The representation  $\gamma : \tilde{B}_n \mapsto GL(\mathcal{V})$  is injective.*

*Proof.* Let  $\beta \in \tilde{B}_n$  be such that  $\gamma(\beta) = Id$ . First, Proposition 3.31 imposes that  $\beta$  is a pure braid; indeed the bloc  $B_{1,1}$  must be the identity, which means that the permutation  $\pi(\beta)$  is trivial.

According to Theorem 3.7 we can consider a normal form for  $\beta$ :

$$\beta = \prod (\alpha)^{\nu_\alpha}.$$

Let  $I \subset \{1, \dots, n\}$  be a sequence of indices with largest index  $m$ . Let also  $\mathcal{V}_I$  be the subspace of  $\mathcal{V}$  spanned by commutators with support included in  $I$ . We can then define the associated projection  $p_I : \mathcal{V} \rightarrow \mathcal{V}_I$ , and its composition with the restriction of  $\gamma$  on  $\mathcal{V}_I$ , denoted by  $\gamma_I := p_I \circ \gamma|_{\mathcal{V}_I}$ . Note that it corresponds to keeping only the components with index in  $I$ . It is clear using Corollary 2.7 that  $\gamma(\tilde{P}_n)(\mathcal{V} \setminus \mathcal{V}_I) \subset \mathcal{V} \setminus \mathcal{V}_I$ , thus for  $\beta_1, \beta_2 \in \tilde{P}_n$  we have that  $\gamma_I(\beta_1 \beta_2) = \gamma_I(\beta_1) \gamma_I(\beta_2)$ . Moreover  $\gamma_I(\mathbf{1}^{(\alpha)}) = Id$  for any comb-clasper  $(\alpha)$  with  $\text{supp}(\alpha) \not\subset I$ . Hence  $\gamma_I(\beta) = \gamma_I(\beta')$  for  $\beta'$  defined by:

$$\beta' = \prod_{\text{supp}(\alpha) \subset I} (\alpha)^{\nu_\alpha}.$$

Now we show by strong induction on the degree of  $(\alpha)$  that  $\nu_\alpha = 0$ . For the base case we consider  $I$  of the form  $I = \{i, m\}$ . Using Lemma 3.32 we obtain:

$$\begin{aligned} \gamma_I(\beta')(m) &= \gamma_I(\mathbf{1}^{(im)^{\nu_{im}}})(m), \\ &= (m) - \nu_{im} \cdot (im). \end{aligned}$$

Because  $\beta \in \text{Ker}(\gamma)$ , we have that  $\gamma_I(\beta)(m) = (m)$ , and this implies that  $\nu_\alpha = 0$  for any  $(\alpha)$  of degree one. To prove that  $\nu_\alpha = 0$  for any  $(\alpha)$  of degree  $k$  we take  $I$  of length  $k+1$  and using the induction hypothesis, we get then:

$$\beta' = \prod_{\text{supp}(\alpha)=I} (\alpha)^{\nu_\alpha}.$$

Thus thanks to Lemma 3.32 we obtain finally:

$$\gamma_I(\beta')(m) = (m) - \sum_{\text{supp}(\alpha)=I} \nu_\alpha \cdot (\alpha).$$

Because  $\beta \in \text{Ker}(\gamma)$  we have that  $\gamma_I(\beta)(m) = (m)$ , and this implies  $\nu_\alpha = 0$  for any  $(\alpha)$  of support  $I$ . Repeating the argument for any  $I \subset \{1, \dots, n\}$  of length  $k+1$ , we get that  $\nu_\alpha = 0$  for any  $(\alpha)$  of degree  $k$ , which concludes the proof.  $\square$

**Corollary 3.34.** *The normal form is unique in  $\tilde{B}_n$ , i.e. if  $\beta = \prod (\alpha)^{\nu_\alpha} = \prod (\alpha)^{\nu'_\alpha}$  are two normal forms of  $\beta$  for a given order on the set of twisted comb-claspers, then  $\nu_\alpha = \nu'_\alpha$  for any  $(\alpha)$ .*

*Proof.* The proof follows closely the previous one. As before for a given  $I \subset \{1, \dots, n\}$  we have  $\gamma_I(\beta) = \gamma_I(\beta')$  for  $\beta'$  defined by :

$$\beta' = \prod_{\text{supp}(\alpha) \subset I} (\alpha)^{\nu_\alpha} = \prod_{\text{supp}(\alpha) \subset I} (\alpha)^{\nu'_\alpha}.$$

We show again by strong induction on the degree that  $\nu_\alpha = \nu'_\alpha$ . The base case is strictly similar, but for the inductive step one cannot in general write  $\beta'$  with only comb-claspers with support  $I$ . However by Corollary 2.7 a comb-clasper  $(\alpha)$  with  $\text{supp}(\alpha) = I$  commutes with any comb-clasper  $(\alpha')$

up to comb-clasper with support not included in  $I$ . Hence  $\gamma_I(\mathbf{1}^{(\alpha)})$  commutes with  $\gamma_I(\mathbf{1}^{(\alpha')})$  for any two comb-claspers  $(\alpha')$  and  $(\alpha)$  such that  $\text{supp}(\alpha) = I$ . In particular we get:

$$\begin{aligned} \gamma_I(\beta')(m) &= \gamma_I \left( \prod_{\text{supp}(\alpha) \subsetneq I} (\alpha)^{\nu_\alpha} \right) \circ \gamma_I \left( \prod_{\text{supp}(\alpha) = I} (\alpha)^{\nu_\alpha} \right) (m) \\ &= \gamma_I \left( \prod_{\text{supp}(\alpha) \subsetneq I} (\alpha)^{\nu'_\alpha} \right) \circ \gamma_I \left( \prod_{\text{supp}(\alpha) = I} (\alpha)^{\nu'_\alpha} \right) (m). \end{aligned}$$

Since comb-claspers  $(\alpha)$  with  $\text{supp}(\alpha) \subsetneq I$  have degree  $< (k - 1)$  where  $k$  is the length of  $I$ , by induction hypothesis we can simplify the first factor in each expression. By Lemma 3.32 we compute the second term thus obtaining:

$$(m) - \sum_{\text{supp}(\alpha) = I} \nu_\alpha \cdot (\alpha) = (m) - \sum_{\text{supp}(\alpha) = I} \nu'_\alpha \cdot (\alpha),$$

and the proof is complete.  $\square$

**Remark 3.35.** Corollary 3.34 shows that the numbers  $\nu_\alpha$  of parallel copies of each comb-clasper in a normal form are a complete invariant of pure braids up to link-homotopy. We call those numbers the *clasp-numbers*. Others well known complete homotopy braid invariants are the Milnor numbers [HL90]. A natural question to determine the explicit relationship between these two families of invariants. This depends on the chosen order on  $\mathcal{F}$  since our clasp-numbers do. For an order given degree by degree, an answer to this question appears in [Yas09, Theorem 4.3], where another clasper family, equivalent to comb-claspers, is used.

In the following of the paper we will focus on the study of *links* up to link-homotopy. More precisely we will describe in terms of *clasp-numbers variation* when two normal forms have link-homotopic *closures*.

#### 4. LINKS UP TO LINK-HOMOTOPY

The main purpose of this section is to use clasp-numbers to provide an explicit classification of link up to link-homotopy. In this way we recover results of Milnor [Mil54] and Levine [Lev88] for 4 or less components, and extend them partially for 5 components. To do so we first revisit in terms of claspers the work of Habegger and Lin [HL90] and more precisely the notion of partial conjugation.

**4.1. Partial conjugation and the Habegger–Lin Theorem revisited.** There is a procedure on braids called *closure*, that turns a braid into a link in  $S^3$ . The question is to determine when two braids have link-homotopic closures. The answer appears in [HL90] using *partial conjugations*. To define this notion we first recall from [HL90, Theorem 1.7 & Corollary 1.11] that for any integer  $n$  we have the decomposition:

$$\tilde{P}_n = \tilde{P}_{n-1} \times \mathcal{R}F(n-1)$$

where the first term corresponds to the braid obtained by omitting a given component, and the second term is the class of this component as an element of the reduced fundamental group of the disk with  $n - 1$  punctures.

In particular if we iterate this decomposition by omitting the last component recursively, we obtain the decomposition illustrated in Figure 19 (see Convention 4.1) :

$$\tilde{P}_n = \mathcal{R}F(1) \times \cdots \times \mathcal{R}F(n-1).$$

Moreover the normal form in  $\tilde{P}_n$  with respect to the order of Example 3.6 corresponds to this decomposition, where each individual factor is in normal form with respect to the order of Example 3.14.

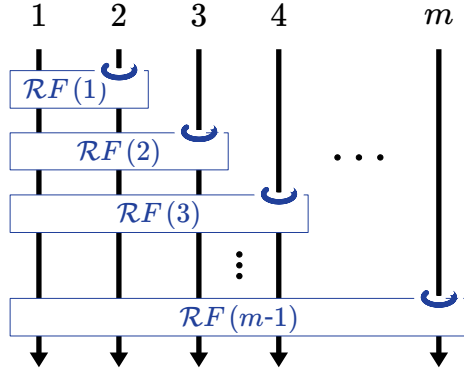
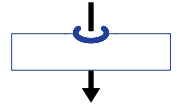

FIGURE 19. The Habegger–Lin decomposition in terms of clasper.

*Convention 4.1.* In figures, a box intersecting several strands of  $\mathbf{1}$  represents a product of claspers whose leaves may or may not intersect those strands, and are disjoint from all others strands. When each claspers in such a box intersects a given strand, this is shown by the graphical convention shown on the right (see Figures 19, 20, 21).



**Definition 4.2.** Let  $\beta \in \tilde{P}_n$ , we set  $\beta = \theta\omega$  a decomposition in  $\tilde{P}_n = \tilde{P}_{n-1} \times \mathcal{RF}(n-1)$ . A *partial conjugate* of  $\beta$  is an element of  $\tilde{P}_n$  of the form  $\theta\lambda\omega\lambda^{-1}$  for some  $\lambda \in \mathcal{RF}(n-1)$ . We speak of an *i-th partial conjugation*, or *partial conjugation with respect to the i-th component*, when the decomposition  $\tilde{P}_n = \tilde{P}_{n-1} \times \mathcal{RF}(n-1)$  is obtained by omitting the i-th component.

In the following proposition we reinterpret the partial conjugation in terms of clasper.

**Proposition 4.3.** Let  $\beta$  be a pure homotopy braid. The i-th partial conjugation of  $\beta$  by  $x_j$  is the surgery result  $\beta^\Delta \cdot \mathbf{1}^{(ij)^{-1}}$ , where  $\Delta$  and  $(ij)^{-1}$  are degree one claspers as shown in the right-hand side of Figure 20.

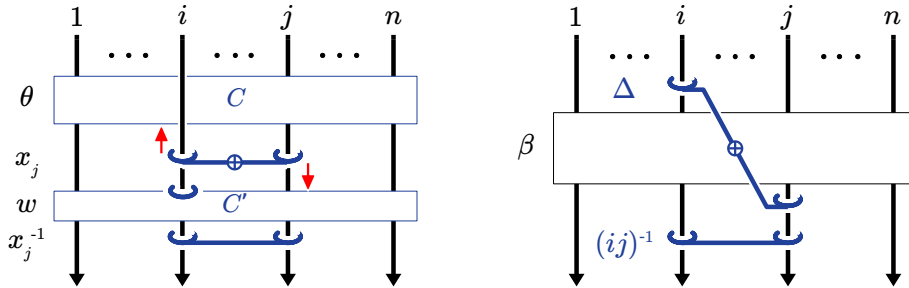

FIGURE 20. The i-th partial conjugation by  $x_j^{-1}$ .

*Proof.* We set first  $\beta = \theta\omega$  the decomposition of  $\beta$  in  $\tilde{P}_n = \tilde{P}_{n-1} \times \mathcal{RF}(n-1)$  obtained by omitting the  $i$ -th component. Through surgery, we see the factor  $\theta \in \tilde{P}_{n-1}$  as a union  $C$  of simple claspers for the trivial braid  $\mathbf{1}$ , where the  $i$ -th component is disjoint from and passes over all claspers in  $C$ . The factor  $\omega \in \mathcal{RF}(n-1)$  is given by a union  $C'$  of simple claspers for the trivial braid, all containing  $i$  in their support. In this setting the  $i$ -th partial conjugation by  $x_j$  (i.e.  $\beta \mapsto \theta x_j \omega x_j^{-1}$ ) corresponds to the product  $C(ij)C'(ij)^{-1}$  as shown in the left hand side of Figure 20. To prove the proposition it suffices to slide the leaf  $i$  of  $(ij)$  upwards by an isotopy (this is possible since  $C$  is disjoint from the  $i$ -th component), and slide the leaf  $j$  downwards: by moves (2) and (4) from Corollary 2.7 this create claspers with repeats which by Lemma 2.6 are trivial up to link-homotopy.  $\square$

We state now the main classification theorem of links up to link-homotopy from [HL90].

**Theorem 4.4.** [HL90, Theorem 2.13.] *Let  $\beta, \beta' \in \tilde{P}(n)$  be two homotopic pure braids. The closures of  $\beta$  and  $\beta'$  are link-homotopic, if and only if there exists a sequence  $\beta = \beta_0, \beta_1, \dots, \beta_n = \beta'$  of elements of  $\tilde{P}_n$  such that  $\beta_{i+1}$  is a conjugate, or a partial conjugate of  $\beta_i$ .*

Hughes in [Hug05] showed that in fact partial conjugations generate conjugations, so they are sufficient to describe link-homotopy. We reprove this result below using clasper calculus.

**Proposition 4.5.** *Partial conjugations generate conjugations.*

*Proof.* It suffices to show that partial conjugations generate all conjugations by any comb-clasper  $(ij)$ . Let  $\beta \in \tilde{P}_n$ , seen as the surgery on  $\mathbf{1}$  along a union of simple claspers denoted  $C$ . By the procedure given below, we decompose  $C$  into a product  $C \sim \tilde{C}C_jC_iC_{i,j}$  such that:

- $C_{i,j}$  is a union of claspers each having  $i$  and  $j$  in their support,
- $C_i$ , resp  $C_j$ , is a union of claspers, each having  $i$ , resp  $j$ , in their support, and such that the  $j$ -th, resp  $i$ -th, component of  $\mathbf{1}$  is disjoint from and passes over all clasper in  $C_i$ , resp  $C_j$ ,
- $\tilde{C}$  is a product of claspers that are are disjoint from and pass under the  $i$ -th and  $j$ -th components.

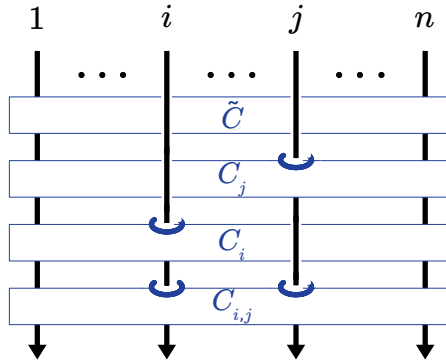

FIGURE 21. Decomposition  $C \sim \tilde{C}C_jC_iC_{i,j}$ .

This decomposition is illustrated in Figure 21. To obtain such a decomposition we first consider those claspers in  $C$  that are disjoint from the  $i$ -th and  $j$ -th components, and we apply move (3) from Corollary 2.7 to ensure that they all are behind those components. We use moves (2) and (4) from Corollary 2.7 to obtain a decomposition  $C \sim \tilde{C}C_0$  where all claspers in  $C_0$  have either  $i$  or  $j$  in their support. Next we consider those claspers in  $C_0$  that are disjoint from the  $i$ -th component: we apply



move (3) from Corollary 2.7 to ensure that they all are behind this component, and then use again Corollary 2.7 to obtain a decomposition  $C \sim \tilde{C}C_jC_1$  where all claspers in  $C_1$  have  $i$  in their support. Finally by the exact same way we have a decomposition  $C_1 \sim C_iC_{ij}$  with  $C_j$  and  $C_{ij}$  as desired.

Note that the product  $(\tilde{C}C_j)(C_iC_{ij})$  corresponds to the decomposition  $\tilde{P}_n = \tilde{P}_{n-1} \times \mathcal{RF}(n-1)$  given by omitting the  $i$ -th component. We can then apply an  $i$ -th partial conjugation by  $x_j$  to obtain  $\tilde{C}C_j(ij)C_iC_{ij}(ij)^{-1}$ . We then exchange the relative position of  $(ij)$  with  $C_i$  using moves (2) and (4) from Corollary 2.7, this creates a union  $K_{ij}$  of claspers with  $i$  and  $j$  in their support, such that:

$$(ij)C_i = C_iK_{ij}(ij). \quad (1)$$

We can then freely (up to link-homotopy) exchange  $(ij)$  and  $C_{ij}$  by Remark 2.8, thus obtaining the decomposition  $\tilde{C}C_jC_iK_{ij}C_{ij}$ . Now we similarly use move (2) and (4) from Corollary 2.7 to exchange  $C_i$  and  $C_j$ , which creates a union  $R_{ij}$  of claspers with  $i$  and  $j$  in their support, such that:

$$C_jC_i = C_iR_{ij}C_j. \quad (2)$$

We obtain in this way the product  $(\tilde{C}C_i)(R_{ij}C_jK_{ij}C_{ij})$  corresponding to the decomposition  $\tilde{P}_n = \tilde{P}_{n-1} \times \mathcal{RF}(n-1)$  given by omitting the  $j$ -th component. We can then perform a  $j$ -th partial conjugations by  $x_i$  to obtain  $\tilde{C}C_i(ij)R_{ij}C_jC_{ij}K_{ij}(ij)^{-1}$  that is link-homotopic to  $\tilde{C}C_i(ij)R_{ij}C_jC_{ij}(ij)^{-1}K_{ij}$  according to Remark 2.8. Then with further partial conjugations, we relocate  $K_{ij}$  and we obtain  $\tilde{C}C_i(ij)K_{ij}R_{ij}C_jC_{ij}(ij)^{-1}$ . Finally using equality (1) and (2) from above we simplify the expression as follows:

$$\tilde{C}C_iK_{ij}(ij)R_{ij}C_jC_{ij}(ij)^{-1} \sim \tilde{C}(ij)C_iR_{ij}C_jC_{ij}(ij)^{-1} \sim \tilde{C}(ij)C_jC_iC_{ij}(ij)^{-1},$$

and we conclude by exchanging  $\tilde{C}$  and  $(ij)$  via an isotopy, thus obtaining the conjugate  $(ij)C(ij)^{-1}$ .  $\square$

Theorem 4.4 and Proposition 4.5 give us the following corollary.

**Corollary 4.6.** *Two homotopic pure braids have link-homotopic closures if and only if they are related by a sequence of partial conjugations.*

By this corollary we have reinterpreted the link-homotopy classification of links as the problem of understanding when braids are partial conjugate. To make this theorem fully efficient we need the missing ingredient that any link can be seen as a pure braid. This is the statement of the following lemma coming from [HL90].

**Lemma 4.7.** *Any  $n$ -component link is link-homotopic to the closure of an  $n$ -component pure braid.*

**4.2. Link-homotopy classification of links with a small number of components.** This section is dedicated to the explicit classification of links up to link-homotopy. The starting point of the strategy is the work of Habegger and Lin, which allows us through Corollary 4.6 and Lemma 4.7 to see links up to link-homotopy as pure homotopy braids up to partial conjugations. Moreover with Corollary 3.34 we show that a braid is uniquely determined by its normal form, encoded by a sequence of integers: the clasp-numbers. The goal is then to determine how the normal form, or equivalently the clasp-numbers, vary under partial conjugations. By using clasper calculus, we recover in this way the link-homotopy classification results from Milnor [Mil54] and Levine [Lev88] in the case of links with at most 4 components. We then apply these techniques to the 5-component *algebraically split* case.

In order to use Corollary 3.34, we need to fix an order on the set of twisted comb-claspers. In the rest of the paper we fix the following order, which is inspired from Example 3.14. For two twisted comb-claspers  $(\alpha) = (i_1 \cdots i_l)$  and  $(\alpha') = (i'_1 \cdots i'_l)$  we set  $(\alpha) \leq (\alpha')$  if:

- $\deg(\alpha) < \deg(\alpha')$ , or
- $\deg(\alpha) = \deg(\alpha')$  and  $i_1 \cdots i_l <_{\text{lex}} i'_1 \cdots i'_l$ ,

where  $<_{\text{lex}}$  denotes the lexicographic order. This order is used implicitly throughout the rest of the paper.

4.2.1. *The 2-component case.* As a warm up, we consider the 2-component case in order to illustrate the techniques of this section.

Let  $L$  be a 2-component link. By Lemma 4.7,  $L$  is link-homotopic to the closure of a 2-component pure braid  $\beta$ . By Corollary 3.34 there is a unique integer  $\nu_{12}$  such that:

$$\beta \sim (12)^{\nu_{12}}.$$

So by Corollary 4.6 the link-homotopy class of  $L$  is uniquely characterized by the integer  $\nu_{12}$  modulo the indeterminacy introduced by partial conjugations.

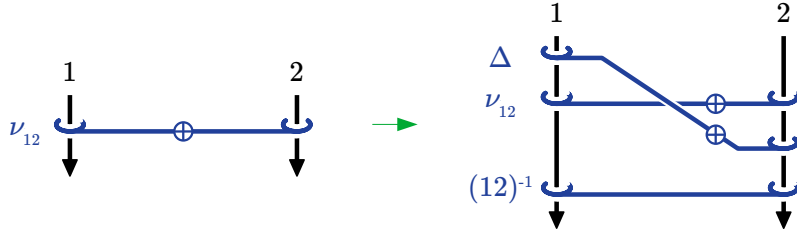

FIGURE 22. The 1-th partial conjugation by  $x_2$  on the normal form.

Now in the two component case, move (2) from Corollary 2.7 shows that partial conjugations with respect to the first and the second component, leave the normal form unchanged. This is illustrated in Figure 22 for the 1-th partial conjugation by  $x_2$ . The clasp-number  $\nu_{12}$  is therefore a complete link-homotopy invariant for 2-component links. Note that this number is in fact the linking number between the two components, which is well known to classify 2-component links up to link-homotopy.

4.2.2. *The 3-component case.* Let  $L$  be a 3-component link. By Lemma 4.7 and Corollary 3.34,  $L$  is link-homotopic to the closure of the normal form:

$$(12)^{\nu_{12}}(13)^{\nu_{13}}(23)^{\nu_{23}}(123)^{\nu_{123}},$$

for some integers  $\nu_{12}$ ,  $\nu_{13}$ ,  $\nu_{23}$  and  $\nu_{123}$ . See the left-hand side of Figure 23.

We now investigate how these numbers vary under partial conjugations. Apply for example the 1-th partial conjugation by  $x_2$ . By Proposition 4.3 this corresponds to introducing the claspers  $\Delta$  and  $(12)^{-1}$  as shown in the right-hand side of Figure 23, which we then put in normal form. This is done by sliding the 1-leaf of  $\Delta$  along the first component to obtain  $(12)$  and simplify it with  $(12)^{-1}$ . By move (2) from Corollary 2.7, this sliding creates new claspers, but by Lemma 2.6, the only claspers that do not vanish up to link-homotopy, are those created when  $\Delta$  crosses the leaves of  $(13)^{\nu_{13}}$ : more precisely, in this process,  $\nu_{13}$  copies of  $\{1,2,3\}$ -supported claspers appear. Finally, according to Remark 2.8 we can rearrange these new claspers and the normal form becomes

$$(12)^{\nu_{12}}(13)^{\nu_{13}}(23)^{\nu_{23}}(123)^{\nu_{123}+\nu_{13}}.$$

The other partial conjugations act in a similar way, by changing  $\nu_{123}$  by a multiple of  $\nu_{12}$ ,  $\nu_{13}$  or  $\nu_{23}$ . Summarizing we have shown that

$$\nu_{12}, \nu_{13}, \nu_{23} \text{ and } \nu_{123} \pmod{\text{pgcd}(\nu_{12}, \nu_{13}, \nu_{23})},$$

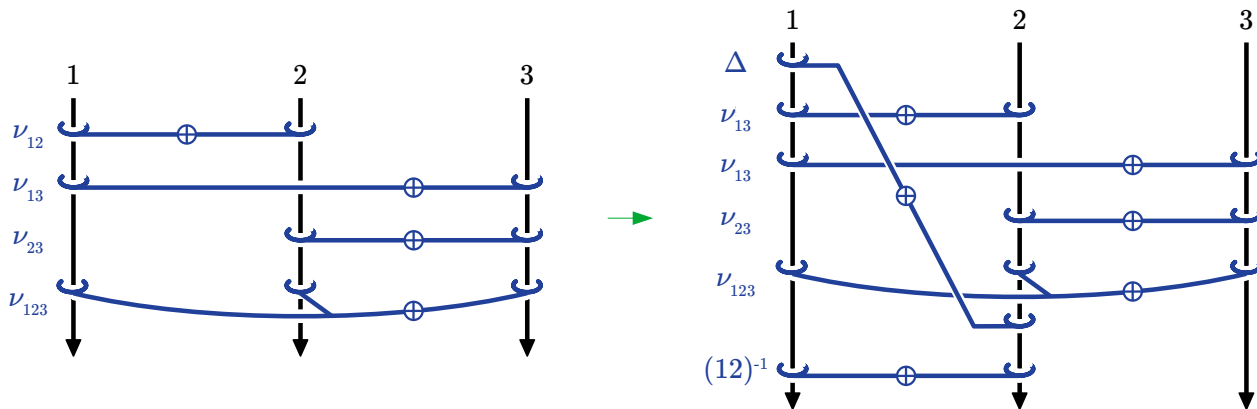

FIGURE 23. The 1-th partial conjugation by  $x_2$  on the normal form.

form a set of complete invariants for 3-component links up to link-homotopy. In fact, we recover here Milnor invariants  $\bar{\mu}_{12}$ ,  $\bar{\mu}_{13}$ ,  $\bar{\mu}_{23}$  and  $\bar{\mu}_{123}$ , that we already knew to be complete link-homotopy invariants for 3-component links (see [Mil54]).

4.2.3. *The 4-component case.* Before proceeding with the link-homotopy classification of 4-component links, we need the following technical result.

**Lemma 4.8.** *Let  $C$  be a union of simple claspers for the trivial  $n$ -component braid denoted  $\mathbf{1}$ , let  $l \in \{1, \dots, n\}$ . Let  $T$  be a clasper in  $C$  with  $l$  in its support and let  $C_T = \bigcup T'$  be the union of all claspers in  $C$  such that  $\text{supp}(T') \cap \text{supp}(T) = \{l\}$ . Suppose that an  $l$ -leaf  $f$  of  $T$  is disjoint from a 3-ball  $B$  containing all  $l$ -leaves of  $C_T$ , then the closure of  $\mathbf{1}^C$  is link-homotopic to the closure of  $\mathbf{1}^{C'}$  where  $C'$  is obtained from  $C$  by passing  $f$  across the ball  $B$  as shown in Figure 24.*

*Proof.* First the result is clear if  $T$  has several  $l$ -leaves, since by Lemma 2.6,  $T$  vanishes up to link-homotopy. By Remark 2.8 the edges of any clasper in  $C_T$  can freely cross those of  $T$  but  $f$  and the  $l$ -leaves of claspers in  $C_T$  cannot be freely exchanged. However according to Remark 2.8 again, the leaf  $f$  can be freely exchanged with any  $l$ -leaf of claspers in  $C \setminus C_T$ , since their supports contain at least  $l$  and another common component with the support of  $T$ . By using the closure we can thus slide  $f$  in the other direction and bypass the  $l$ -leaves of claspers in  $C_T$  all gathered in  $B$ .  $\square$

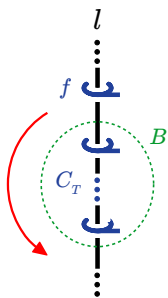

FIGURE 24. Illustration of Lemma 4.8

Although the assumption of Lemma 4.8 may seem restrictive, it turns out to be naturally satisfied for normal forms. For instance, we have the following consequence.

**Proposition 4.9.** *Let  $C = (\alpha_1)^{\nu_1} \dots (\alpha_m)^{\nu_m}$  be the normal form of a pure homotopic  $n$ -component braid and let  $(\alpha)$  be a degree  $n-2$  comb-clasper. Then  $C$  and  $C' = (\alpha_1)^{\nu_1} \dots (\alpha)(\alpha_i)^{\nu_i}(\alpha)^{-1} \dots (\alpha_m)^{\nu_m}$  have link-homotopic closures, for any  $i \in \{1, \dots, m\}$ .*

*Proof.* We first consider the product  $(\alpha_1)^{\nu_1} \dots (\alpha_i)^{\nu_i}(\alpha)(\alpha)^{-1} \dots (\alpha_m)^{\nu_m}$  where we just insert the trivial term  $(\alpha)(\alpha)^{-1}$  to  $C$ . We next want to exchange  $(\alpha)$  and  $(\alpha_i)^{\nu_i}$ . This is allowed if  $|\text{supp}(\alpha) \cap \text{supp}(\alpha_i)| \geq 2$  by Remark 2.8, but if  $\text{supp}(\alpha) \cap \text{supp}(\alpha_i) = \{l\}$  we can only realize crossing changes between the edges of  $(\alpha)$  and  $(\alpha_i)^{\nu_i}$  (see Remark 2.8). However in that case  $(\alpha_i)$  is a comb-clasper of support  $\{k, l\}$  with  $k$  the only component not in the support of  $(\alpha)$ , thus we can apply Lemma 4.8 to the  $l$ -leaf of  $(\alpha)$ , and bypass the block  $(\alpha_i)^{\nu_i}$  (corresponding to  $C_T$  in Lemma 4.8).  $\square$

Let us now return to the classification of links up to link-homotopy and let  $L$  be a 4-component link. By Lemma 4.7 and Corollary 3.34,  $L$  is link-homotopic to the closure of the normal form:

$$(12)^{\nu_{12}}(13)^{\nu_{13}}(14)^{\nu_{14}}(23)^{\nu_{23}}(24)^{\nu_{24}}(34)^{\nu_{34}}(123)^{\nu_{123}}(124)^{\nu_{124}}(134)^{\nu_{134}}(234)^{\nu_{234}}(1234)^{\nu_{1234}}(1324)^{\nu_{1324}},$$

for some integers  $\nu_{12}, \nu_{13}, \nu_{14}, \nu_{23}, \nu_{24}, \nu_{34}, \nu_{123}, \nu_{124}, \nu_{134}, \nu_{234}, \nu_{1234}$ , and  $\nu_{1324}$ . See Figure 25.

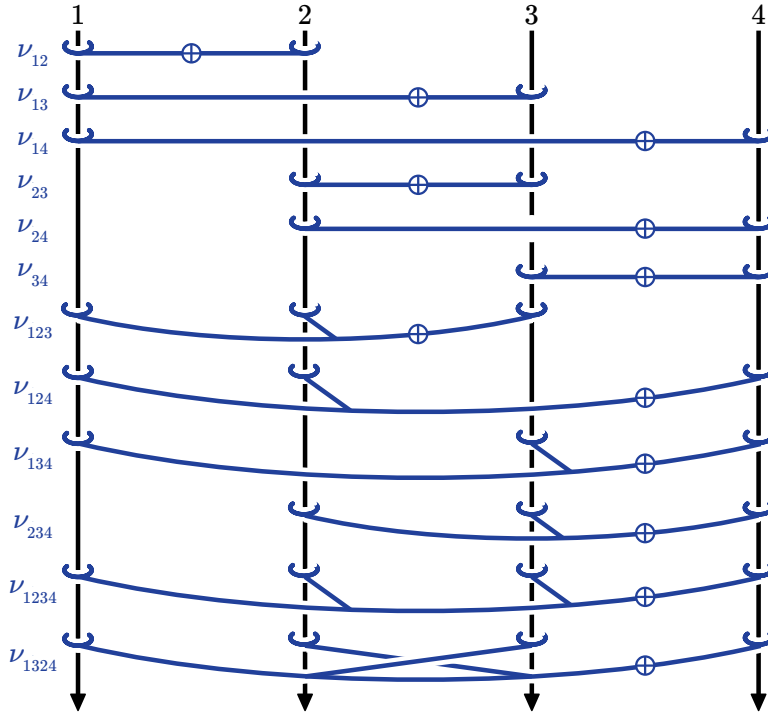

FIGURE 25. Normal form for 4 components.

We can apply Proposition 4.9 to the degree 2 comb-claspers  $(123)$ ,  $(124)$ ,  $(134)$  and  $(234)$ . For example, applying Proposition 4.9 to  $(\alpha) = (234)$  and  $(\alpha_i) = (12)$ , we get that  $L$  is link-homotopic to the closure of:

$$(234)(12)^{\nu_{12}}(234)^{-1}(13)^{\nu_{13}}(14)^{\nu_{14}}(23)^{\nu_{23}}(24)^{\nu_{24}}(34)^{\nu_{34}}(123)^{\nu_{123}} \\ (124)^{\nu_{124}}(134)^{\nu_{134}}(234)^{\nu_{234}}(1234)^{\nu_{1234}}(1324)^{\nu_{1324}}.$$

By clasper calculus (Corollary 2.7 and Remark 2.8), we have  $(234)(12)^{\nu_{12}}(234)^{-1} \sim (12)^{\nu_{12}}(1234)^{\nu_{12}}$ . The product of claspers  $(1234)^{\nu_{12}}$  can be freely homotoped by Remark 2.8, thus producing the normal form

$$(12)^{\nu_{12}}(13)^{\nu_{13}}(14)^{\nu_{14}}(23)^{\nu_{23}}(24)^{\nu_{24}}(34)^{\nu_{34}}(123)^{\nu_{123}}(124)^{\nu_{124}}(134)^{\nu_{134}}(234)^{\nu_{234}}(1234)^{\nu_{1234}+\nu_{12}}(1324)^{\nu_{1324}},$$

whose closure is link-homotopic to  $L$ . This is recorded in first row of Table 1, which records all possible transformations on clasp-numbers obtained with Proposition 4.9. Each row represents a possible transformation where the entry in the column  $\nu_\alpha$  represents the variation of the clasp-number  $\nu_\alpha$ . Note that an empty cell means that the corresponding clasp-number remains unchanged. Note also that, we only need two columns because for the comb-claspers of degree 1 or 2 the associated clasp-numbers remain unchanged.

$\nu_{1234}$	$\nu_{1324}$
$\nu_{12}$	
$\nu_{34}$	
	$\nu_{13}$
	$\nu_{24}$
$\nu_{14}$	$-\nu_{14}$
$\nu_{23}$	$-\nu_{23}$

TABLE 1. Some clasp-numbers variation with same closures.

Let us now describe how partial conjugations affect the clasp-numbers. As for the 3-component case, the  $i$ -th partial conjugation by  $x_j$  corresponds to sliding the  $i$ -leaf of a simple clasper of support  $\{i, j\}$  (denoted  $\Delta$  in Proposition 4.3) along the  $i$ -th component. Along the way  $\Delta$  encounters leaves and edges of other claspers that can be crossed as described by moves (2) and (4) of Corollary 2.7. In doing this, claspers of degree 2 and 3 may appear, that we must reposition in the normal form. Those of degree 3 commute with any clasper by Remark 2.8, but since they may not be comb-claspers we have to use IHX relations (Proposition 2.9) to turn them into comb-claspers. Claspers of degree 2 can be repositioned using Remark 2.8 and Lemma 4.8 (the fact that Lemma 4.8 applies is clear according to the shape of the normal form, where factors are stacked).

We detail as an example the 2-th partial conjugation by  $x_4$  denoted  $\downarrow_4^2$ . In that case  $\Delta$  has support  $\{2, 4\}$  and we slide its 2-leaf along the 2-component. According to Remark 2.8,  $\Delta$  can freely cross the edges of claspers with 4 in their support and the 2-leaves of claspers containing 2 and 4 in their support. Thus we only consider the claspers that appear when  $\Delta$  meets the edges of  $(13)^{\nu_{13}}$  and the 2-leaves of  $(12)^{\nu_{12}}$ ,  $(23)^{\nu_{23}}$  and  $(123)^{\nu_{123}}$ . Once repositioned we obtain in order the factors  $(1324)^{\nu_{13}}$ ,  $(124)^{\nu_{12}}$ ,  $(234)^{-\nu_{23}}$  and  $(1324)^{-\nu_{123}}$ . However according to Table 1,  $(1324)^{\nu_{13}}$  can be removed up to link-homotopy and thus we get the following normal form:

$$\begin{aligned} & (12)^{\nu_{12}}(13)^{\nu_{13}}(14)^{\nu_{14}}(23)^{\nu_{23}}(24)^{\nu_{24}}(34)^{\nu_{34}}(123)^{\nu_{123}}(124)^{\nu_{124}+\nu_{12}} \\ & (134)^{\nu_{134}}(234)^{\nu_{234}-\nu_{23}}(1234)^{\nu_{1234}}(1324)^{\nu_{1324}-\nu_{123}} \end{aligned}$$

In the same way we compute all the partial conjugations and record them in Table 2. The entry in row  $\downarrow_j^i$  represents the  $i$ -th partial conjugation by  $x_j$ . As in Table 1, an empty cell means that the partial conjugation does not change the clasp-number. Moreover the  $\nu_{ij}$  columns are omitted because they remain unchanged by any partial conjugation.

	$\nu_{123}$	$\nu_{124}$	$\nu_{134}$	$\nu_{234}$	$\nu_{1234}$	$\nu_{1324}$
$\begin{matrix} \downarrow 1 \\ \downarrow 2 \end{matrix}$	$\nu_{13}$	$\nu_{14}$			$\nu_{134}$	
$\begin{matrix} \downarrow 1 \\ \downarrow 3 \end{matrix}$	$-\nu_{12}$		$\nu_{14}$			$\nu_{124}$
$\begin{matrix} \downarrow 1 \\ \downarrow 4 \end{matrix}$		$-\nu_{12}$	$-\nu_{13}$		$-\nu_{123}$	$\nu_{123}$
$\begin{matrix} \downarrow 2 \\ \downarrow 1 \end{matrix}$	$-\nu_{23}$	$-\nu_{24}$			$-\nu_{234}$	
$\begin{matrix} \downarrow 2 \\ \downarrow 3 \end{matrix}$	$\nu_{12}$			$\nu_{24}$	$\nu_{124}$	$-\nu_{124}$
$\begin{matrix} \downarrow 2 \\ \downarrow 4 \end{matrix}$		$\nu_{12}$		$-\nu_{23}$		$-\nu_{123}$
$\begin{matrix} \downarrow 3 \\ \downarrow 1 \end{matrix}$	$\nu_{23}$		$-\nu_{34}$			$\nu_{234}$
$\begin{matrix} \downarrow 3 \\ \downarrow 2 \end{matrix}$	$-\nu_{13}$			$-\nu_{34}$	$-\nu_{134}$	$\nu_{134}$
$\begin{matrix} \downarrow 3 \\ \downarrow 4 \end{matrix}$			$\nu_{13}$	$\nu_{23}$	$\nu_{123}$	
$\begin{matrix} \downarrow 4 \\ \downarrow 1 \end{matrix}$		$\nu_{24}$	$\nu_{34}$		$\nu_{234}$	$-\nu_{234}$
$\begin{matrix} \downarrow 4 \\ \downarrow 2 \end{matrix}$		$-\nu_{14}$		$\nu_{34}$		$-\nu_{134}$
$\begin{matrix} \downarrow 4 \\ \downarrow 3 \end{matrix}$			$-\nu_{14}$	$-\nu_{24}$	$-\nu_{124}$	

TABLE 2. Clasp-numbers variations under partial conjugations.

There are algebraic redundancies in Table 2, i.e. some lines are combinations of other lines, which means that some partial conjugations generate the others. So we can keep only these ones (or their opposite), which we call "generating" partial conjugations, and which we record in Table 3.

$\nu_{123}$	$\nu_{124}$	$\nu_{134}$	$\nu_{234}$	$\nu_{1234}$	$\nu_{1324}$
$\nu_{13}$	$\nu_{14}$			$\nu_{134}$	
$-\nu_{12}$		$\nu_{14}$			$\nu_{124}$
$\nu_{23}$	$\nu_{24}$			$\nu_{234}$	
	$-\nu_{12}$		$\nu_{23}$		$\nu_{123}$
$\nu_{23}$		$-\nu_{34}$			$\nu_{234}$
		$\nu_{13}$	$\nu_{23}$	$\nu_{123}$	
	$\nu_{14}$		$-\nu_{34}$		$\nu_{134}$
		$\nu_{14}$	$\nu_{24}$	$\nu_{124}$	

TABLE 3. Clasp-numbers variations under generating partial conjugations.

Finally, with Table 3 we reinterpret the classification of links with 4 component as follows.

**Theorem 4.10.** *Two 4-component links, see as closures of braids in normal forms (see Figure 25), are link-homotopic if and only if their clasp-numbers are related by a sequence of transformations from Table 3.*

Note that Levine in [Lev88] already proved similar results. The purpose of this paragraph is to explain the correspondence between the two approaches. The strategy adopted in [Lev88] consists in fixing the first three components and let the fourth one carry the information of the link-homotopy

indeterminacy. Levine used four integers  $k, l, r, d$  to describe a normal form for the first three components, and integers  $e_i; i \in \{1, \dots, 8\}$  to describe the information of the last component. Finally in [Lev88, Table3] he gives a list of all possible transformations on  $e_i$ -numbers that do not change the link-homotopy class. Fixing the last component corresponds in our setting to fixing the clasp-number  $\nu_{123}$ : this is why [Lev88, Table 3] has one less column than Tables 2 and 3. Moreover the five rows of [Lev88, Table 3] correspond to  $\left(\downarrow_3^1\right)^{-1}, \left(\downarrow_4^2\right)^{-1}, \downarrow_1^4, \downarrow_3^4$  and  $\left(\downarrow_1^2\right)^{-c} \circ \left(\downarrow_3^1\right)^{-a} \circ \left(\downarrow_2^1\right)^{-b}$ , respectively, and Levine's integers correspond to clasp-numbers as follows.

$k$	$r$	$l$	$d$	$e_1$	$e_2$	$e_3$	$e_4$	$e_5$	$e_6$	$e_7$	$e_8$
$\nu_{12}$	$\nu_{13}$	$\nu_{23}$	$\nu_{123}$	$\nu_{14}$	$\nu_{24}$	$\nu_{34}$	$\nu_{124}$	$\nu_{134}$	$\nu_{234}$	$-\nu_{1324}$	$-\nu_{1234}$

4.2.4. *The 5-component algebraically split case.* This section is dedicated to the study of *5-components algebraically split links*. These are links such that the linking numbers are trivial for any couple of components. Equivalently, algebraically split links are given by the closure of a normal form with trivial clasp-numbers for any degree one comb-clasper.

The following proposition is the algebraically split version of Proposition 4.9.

**Proposition 4.11.** *Let  $C = (\alpha_1)^{\nu_1} \dots (\alpha_m)^{\nu_m}$  be a normal form of a pure homotopic  $n$ -component braid with  $\nu_i = 0$  for any  $(\alpha_i)$  of degree one, let  $(\alpha)$  be a degree  $n - 3$  comb-clasper. Then  $C$  and  $C' = (\alpha_1)^{\nu_1} \dots (\alpha)(\alpha_i)^{\nu_i}(\alpha)^{-1} \dots (\alpha_m)^{\nu_m}$  have link-homotopic closures, for any  $i \in \{1, \dots, m\}$ .*

*Proof.* As for Proposition 4.9 we first consider the product  $(\alpha_1)^{\nu_1} \dots (\alpha_i)^{\nu_i}(\alpha)(\alpha)^{-1} \dots (\alpha_m)^{\nu_m}$  where we simply insert the trivial term  $(\alpha)(\alpha)^{-1}$  in  $C$ . We next want to exchange  $(\alpha)$  and  $(\alpha_i)^{\nu_i}$ . This is allowed if  $|\text{supp}(\alpha) \cap \text{supp}(\alpha_i)| \geq 2$  by Remark 2.8, but if  $\text{supp}(\alpha) \cap \text{supp}(\alpha_i) = \{l\}$  we can only realize crossing changes between the edges of  $(\alpha)$  and  $(\alpha_i)^{\nu_i}$  (see Remark 2.8). However in that case  $(\alpha_i)$  is a comb-clasper of support  $\{j, k, l\}$  with  $j$  and  $k$  the two components not in the support of  $(\alpha)$ , thus we can apply Lemma 4.8 to the  $l$ -leaf of  $(\alpha)$ , and bypass the block  $(\alpha_i)^{\nu_i}$  (corresponding to  $C_T$  in Lemma 4.8).  $\square$

Returning to the classification of links up to link-homotopy and let  $L$  be a 5-component algebraically split link. By Lemma 4.7 and Corollary 3.34,  $L$  is link-homotopic to the closure of the normal form:

$$C = (123)^{\nu_{123}} (124)^{\nu_{124}} (125)^{\nu_{125}} (134)^{\nu_{134}} (135)^{\nu_{135}} (145)^{\nu_{145}} (234)^{\nu_{234}} (235)^{\nu_{235}} (245)^{\nu_{245}} (345)^{\nu_{345}} (1234)^{\nu_{1234}} \\ (1235)^{\nu_{1235}} (1245)^{\nu_{1245}} (1324)^{\nu_{1324}} (1325)^{\nu_{1325}} (1345)^{\nu_{1345}} (1425)^{\nu_{1425}} (1435)^{\nu_{1435}} (2345)^{\nu_{2345}} (2435)^{\nu_{2435}} \\ (12345)^{\nu_{12345}} (12435)^{\nu_{12435}} (13245)^{\nu_{13245}} (13425)^{\nu_{13425}} (14235)^{\nu_{14235}} (14325)^{\nu_{14325}}$$

The strategy is similar to the 4-component case. Thanks to Lemma 4.7, we see links as braid closures, and with Theorem 3.34 we know that any braid is uniquely determined by a set of numbers: the clasp-numbers  $\{\nu_\alpha\}$ . In this case, the algebraically split condition results in the nullity of clasp-numbers  $\nu_{ij}$  (i.e.  $\nu_\alpha = 0$  for all  $(\alpha)$  of degree 1). Now, as mentioned by Corollary 4.6, the classification of links up to link-homotopy reduces to determining how partial conjugations affect the clasp-numbers.

We first use Proposition 4.11 to simplify the upcoming computations. In that case Proposition 4.11 concerns degree 2 comb-claspers (123), (124), (125), (134), (135), (145), (234), (235), (245), (345). We record in Table 4 all possible transformations on clasp-numbers obtained with Proposition 4.11. As before, each row represents a possible transformation where the entry in the column  $\nu_\alpha$  represents the variation of the clasp-number  $\nu_\alpha$ , and an empty cell means that the corresponding clasp-number remains unchanged. Note also that, we only need columns corresponding to degree 4 comb-claspers because the other clasp-numbers remain unchanged.

$\nu_{12345}$	$\nu_{12435}$	$\nu_{13245}$	$\nu_{13425}$	$\nu_{14235}$	$\nu_{14325}$
$\nu_{123}$					
		$\nu_{123}$			
	$\nu_{124}$				
				$\nu_{124}$	
$\nu_{125}$	$-\nu_{125}$				
			$\nu_{125}$		$-\nu_{125}$
			$\nu_{134}$		
					$\nu_{134}$
	$\nu_{135}$			$-\nu_{135}$	
		$\nu_{135}$	$-\nu_{135}$		
$\nu_{145}$		$-\nu_{145}$			
				$\nu_{145}$	$-\nu_{145}$
$\nu_{234}$	$-\nu_{234}$		$-\nu_{234}$		$\nu_{234}$
	$\nu_{234}$	$-\nu_{234}$	$\nu_{234}$	$-\nu_{234}$	
				$\nu_{235}$	
					$\nu_{235}$
		$\nu_{245}$			
			$\nu_{245}$		
$\nu_{345}$					
	$\nu_{345}$				

TABLE 4. Some clasp-numbers variation with same closure.

Finally, we compute the effect of all partial conjugations using Proposition 4.3, and simplify the results keeping only the "generating" partial conjugations, as in the 4-component case. We record the corresponding clasp-number variations in Table 5. As for the 4-component case, Table 5 contains the data for the classification of 5-component algebraically split. In other words we obtain the following classification result. classification result.

**Theorem 4.12.** *Two 5-component algebraically split links, seen as closures of braids in normal forms, are link-homotopic if and only if their clasp-numbers are related by a sequence of transformations from Table 5.*

$\nu_{1234}$	$\nu_{1235}$	$\nu_{1245}$	$\nu_{1324}$	$\nu_{1325}$	$\nu_{1345}$	$\nu_{1425}$	$\nu_{1435}$	$\nu_{2345}$	$\nu_{2435}$	$\nu_{12345}$	$\nu_{12435}$	$\nu_{13245}$	$\nu_{13425}$	$\nu_{14235}$	$\nu_{14325}$
$\nu_{134}$	$\nu_{135}$	$\nu_{145}$								$\nu_{1345}$	$\nu_{1435}$				
			$\nu_{124}$	$\nu_{125}$	$\nu_{145}$							$\nu_{1245}$	$\nu_{1425}$		
$-\nu_{123}$			$\nu_{123}$			$\nu_{125}$	$\nu_{135}$							$-\nu_{1235}$	$\nu_{1325}$
$\nu_{234}$	$\nu_{235}$	$\nu_{245}$								$\nu_{2345}$	$\nu_{2435}$				
		$\nu_{125}$	$-\nu_{123}$			$-\nu_{125}$			$\nu_{235}$	$\nu_{1235}$		$\nu_{1325}$	$-\nu_{1325}$	$-\nu_{1235}$	
				$\nu_{123}$		$\nu_{124}$		$\nu_{234}$	$-\nu_{234}$				$\nu_{1234} + \nu_{1324}$	$-\nu_{1235}$	$-\nu_{1234}$
			$\nu_{234}$	$\nu_{235}$	$-\nu_{345}$							$\nu_{2345} + \nu_{2435}$	$-\nu_{2435}$		
$-\nu_{134}$	$-\nu_{135}$		$\nu_{134}$	$\nu_{135}$				$-\nu_{345}$		$-\nu_{1345}$		$\nu_{1345}$		$-\nu_{1435}$	$\nu_{1435}$
	$-\nu_{123}$						$\nu_{134}$	$\nu_{234}$		$\nu_{1234} + \nu_{1324}$				$-\nu_{1324}$	
$\nu_{234}$			$-\nu_{234}$			$\nu_{245}$	$\nu_{345}$							$\nu_{2345} + \nu_{2435}$	$-\nu_{2345}$
$-\nu_{124}$					$-\nu_{145}$	$\nu_{145}$	$-\nu_{245}$	$\nu_{245}$	$-\nu_{1245}$	$\nu_{1245}$			$-\nu_{1425}$		$\nu_{1425}$
		$\nu_{124}$			$\nu_{134}$			$\nu_{234}$	$\nu_{1234}$			$\nu_{1324}$			
				$\nu_{135}$		$\nu_{145}$		$-\nu_{345}$	$\nu_{345}$					$\nu_{1345}$	$\nu_{1435}$
	$\nu_{125}$						$\nu_{145}$		$\nu_{245}$		$\nu_{1245}$				$\nu_{1425}$
		$\nu_{125}$			$\nu_{135}$			$\nu_{235}$		$\nu_{1235}$		$\nu_{1325}$			

TABLE 5. Clasp-numbers variation under generating partial conjugations in the 5-component algebraically split case.



## REFERENCES

- [Art47] E. Artin. “Theory of braids”. In: *Ann. Math. (2)* 48 (1947), pp. 101–126.
- [AMW17] Benjamin Audoux, Jean-Baptiste Meilhan, and Emmanuel Wagner. “On codimension two embeddings up to link-homotopy”. In: *J. Topol.* 10.4 (2017), pp. 1107–1123.
- [BT99] Arthur Bartels and Peter Teichner. “All two dimensions links are null homotopic”. In: *Geom. Topol.* 3 (1999), pp. 235–252.
- [FR86] Roger Fenn and Dale Rolfsen. “Spheres may link homotopically in 4-space”. In: *J. Lond. Math. Soc., II. Ser.* 34 (1986), pp. 177–184.
- [FY09] Thomas Fleming and Akira Yasuhara. “Milnor’s invariants and self  $C_k$ -equivalence”. In: *Proc. Am. Math. Soc.* 137.2 (2009), pp. 761–770.
- [Gol74] Deborah Louise Goldsmith. *Homotopy of braids - in answer to a question of E. Artin*. Topology Conf, Virginia polytechnic Inst. and State Univ. 1973, Lect. Notes Math. 375, 91-96. 1974.
- [HL90] Nathan Habegger and Xiao-Song Lin. “The classification of links up to link-homotopy”. In: *J. Am. Math. Soc.* 3.2 (1990), pp. 389–419.
- [Hab00] Kazuo Habiro. “Claspers and finite type invariants of links”. In: *Geom. Topol.* 4 (2000), pp. 1–83.
- [Hal59] M. Hall. *The Theory of Groups*. AMS Chelsea Publishing, 1959.
- [Hal33] P. Hall. “A contribution to the theory of groups of prime-power order”. In: *Proc. Lond. Math. Soc. (2)* 36 (1933), pp. 29–95.
- [Hug05] James R. Hughes. “Partial conjugations suffice”. In: *Topology Appl.* 148.1-3 (2005), pp. 55–62.
- [Hum01] Stephen P. Humphries. “Torsion-free quotients of braid groups”. In: *Int. J. Algebra Comput.* 11.3 (2001), pp. 363–373.
- [Kir88] Paul A. Kirk. *Link maps in the four sphere*. Differential topology, Proc. 2nd Topology Symp., Siegen/FRG 1987, Lect. Notes Math. 1350, 31-43 (1988). 1988.
- [Kos90] Ulrich Koschorke. “On link maps and their homotopy classification”. In: *Math. Ann.* 286.4 (1990), pp. 753–782.
- [KM20] Yuka Kotorii and Atsuhiko Mizusawa. “Link-homotopy classes of 4-component links and claspers”. In: (2020).
- [Lev88] J. P. Levine. “An approach to homotopy classification of links”. In: *Trans. Am. Math. Soc.* 306.1 (1988), pp. 361–387.
- [LS01] Roger C. Lyndon and Paul E. Schupp. *Combinatorial group theory*. Reprint of the 1977 ed. Berlin: Springer, 2001.
- [MKS04] Wilhelm Magnus, Abraham Karrass, and Donald Solitar. *Combinatorial group theory. Presentations of groups in terms of generators and relations*. Reprint of the 1976 second edition. Mineola, NY: Dover Publications, 2004.
- [MR85] W. S. Massey and D. Rolfsen. “Homotopy classification of higher dimensional links”. In: *Indiana Univ. Math. J.* 34 (1985), pp. 375–391.
- [Mil54] John W. Milnor. “Link groups”. In: *Ann. Math. (2)* 59 (1954), pp. 177–195.
- [MK99] Kunio Murasugi and Bohdan I. Kurpita. *A study of braids*. Vol. 484. Dordrecht: Kluwer Academic Publishers, 1999.
- [Orr89] Kent E. Orr. “Homotopy invariants of links”. In: *Invent. Math.* 95.2 (1989), pp. 379–394.
- [ST19] Rob Schneiderman and Peter Teichner. “The group of disjoint 2-spheres in 4-space”. In: *Ann. Math. (2)* 190.3 (2019), pp. 669–750.

- [Yas09] Akira Yasuhara. “Self delta-equivalence for links whose Milnor’s isotopy invariants vanish”. In: *Trans. Am. Math. Soc.* 361.9 (2009), pp. 4721–4749.
- [Yur08] E. Yurasovskaya. *Homotopy String Links Over Surfaces*. PhD Thesis, The University of British Columbia. 2008.

NORMANDIE UNIV, UNICAEN, CNRS, LMNO, 14000 CAEN, FRANCE  
*Email address:* `emmanuel.graff@unicaen.fr`