



HAL
open science

Parametric Study of the Mechanical Properties of Commercial Sikadurs Polymers Mixture

Peng An Lov, Kollika Nguon, Yi Liv, Bertrand Porte, Y. Charles

► **To cite this version:**

Peng An Lov, Kollika Nguon, Yi Liv, Bertrand Porte, Y. Charles. Parametric Study of the Mechanical Properties of Commercial Sikadurs Polymers Mixture. *Techno-Science Research Journal*, 2020, 8, pp.92-97. hal-03792629

HAL Id: hal-03792629

<https://hal.science/hal-03792629v1>

Submitted on 4 Oct 2022

HAL is a multi-disciplinary open access archive for the deposit and dissemination of scientific research documents, whether they are published or not. The documents may come from teaching and research institutions in France or abroad, or from public or private research centers.

L'archive ouverte pluridisciplinaire **HAL**, est destinée au dépôt et à la diffusion de documents scientifiques de niveau recherche, publiés ou non, émanant des établissements d'enseignement et de recherche français ou étrangers, des laboratoires publics ou privés.



Parametric Study of the Mechanical Properties of Commercial Sikadurs Polymers Mixture

Peng An Lov^{1*}, Kollika Nguon¹, Yi Liv¹, Bertrand Porte², Yann Charles³

¹ *Laboratory of Materials Science, Institute of Technology of Cambodia, Russian Federation Blvd., P. O. Box 86, Phnom Penh, Cambodia*

² *Atelier du Musée National de Phnom Penh/ Ecole Francaise d'Extrême Orient*

³ *Université Paris 13, LSPM, CNRS, Paris Sorbonne Cité, 99 Avenue JB Clément, F-93430 Villetaneuse, France*

Received: 30 April; Accepted: 09 October 2020; Available online: xxxx

Abstract: *This paper presents flexural strength, flexural modulus as well as the weight percentage of porosity in specimen by mixing two kind of epoxy resins for Sikadur® 31 CF Normal and Sikadur® 52 TH. The ratio of mixed Sikadur 31-52 following by 100%-0%, 66%-33%, 50%-50%, 33%-66% and 0%-100%, respectively with 3, 6, and 9 days curing time. The aim of this project helps to choose the correct proportions for renovating archeological structures, and especially in the reuniting process of broken statues. Epoxy curing specimen in each rate for short periods as long as 3 days curing, demonstrated a large scatter especially for the mixture. This can be viewed as a sign that the curing procedure is not yet progressing right and a longer time span like 9 days curing must be considered for a practically full curing. Furthermore, the experiment was shown that the specimen which has a higher amount of Sikadur® 31 in mixing exhibited an increased the strength and stiffness. The highest strength can be acquired with the 66% of Sikadur® 31 and 33% of Sikadur® 52. With this mixture, it was shown 27% higher strength than pure 31 and 17% than pure 52 in 9 days curing time. Another thing that could be noticeable from fracture surface is that pure Sikadur® 31 specimen has more porosity if compared to others. This is similar to the experimental investigation.*

Keywords: *Polymer; Parametric study; Mechanical characterization*

1. INTRODUCTION

Studying archaeological structures leads to deal with numerous scientific topics, as geology (Douglas et al., 2010), metallurgy (Hendrickson et al., 2018), civil engineering, chemistry (Pollard et al. 2007), or even fracture mechanism (Wan hill, 2003). In the Cambodian context, archaeological structures fared well and sustained little damage during the two decades of war. Time and weather has done more damage to archaeological structures than weapons or guerrillas. Fig trees, vines and jungle growth have swallowed up several smaller temples and strangled larger building, crushing and grinding the stones (Jessup et al., 2006).

Among the numerous task in the field of heritage preservation and valorisation, restoring and reassembling statues from scattered pieces on site or in several museums is an important challenge; such a task is performed with a wide range of materials which include stone, ceramic, plaster, metal and resin. The repair includes broken, cracked,

chipped items and sculpting/attaching replacement pieces, updating colours (including silver, gold and patina), restoring antiquing or style of statue (Lenzi, 2004). To join the different part of broken statues, metallic pins are used, allowing both the structure stability and a precise location of all of the parts to be reassemble (even in the case where some of them are missing). To connect the metal and the rock, a polymeric resin is used. At the workshop of the Phnom Penh National Museum, a commercial Sikadur® 42 MP polymer is classically used, as well as other kind of Sikadur products such 31 CF and 52 TH, due to some issues for the 42 (potential unavailability in the local market, with costs approximately sixth time as compared to Sikadur® 31 CF and 52 TH). These two polymers have respectively a higher and lower viscosity than the reference 42's one as a consequence Sikadur® 31 is used to fill important spaces, while Sikadur® 52 TH is mainly used for small defects, as cracks. As a consequence, the workshop has developed some empirical Sikadur 31-52 mixture for new applications, as a 42 substitute, but with no precise knowledge of the mixture properties, especially mechanical.

Investigations by Khdir et al. (2018), to improve the tensile characteristics of (Epoxy-Brass debris) composites, it is very important to decrease the amount of weight

* Corresponding author: Peng An Lov
E-mail: lovpeng@yahoo.com; Tel: +855-98 818 199

percentage of brass debris added to epoxy resin but its graded size should be also increased as well. Proving by (Michels et al., 2016) an initial mixing of the resin components under vacuum drastically reduces the porosity ratio in the failure cross-section to approximately 0.5% for curing procedures.

The objective of this paper is to characterize some mechanical properties of Sikadur 31-52 mixture, as a first step, to help the Museum workshop to design the more adapted composition, depending on the application.

The used materials are first presented, as well as the mechanical test used. Results are then presented and discussed.

2. METHODOLOGY

Samples have been made with different rate 31 and 52 Sikadur polymers. Then, several mechanical test have been performed to characterize their properties.

2.1 Materials

In the present study, two commercial epoxy adhesives, namely Sikadur® 31 CF Normal and Sikadur® 52 TH, are investigated.

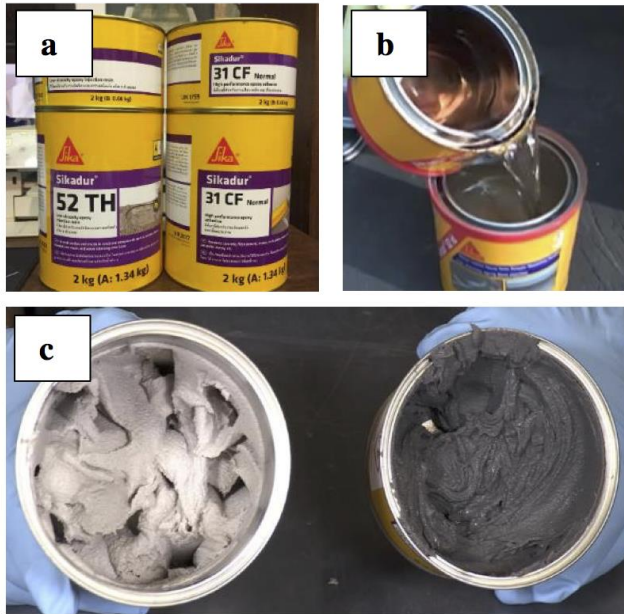

Fig. 1. a) sikadur® 31 and 52; b) liquid component of Sikadur® 52 and c) high viscosity of Sikadur® 31

Sikadur®-31 CF is a high-performance construction adhesive epoxy, with a high viscosity. Sikadur®-52 TH is liquid injection resin epoxy as shown in Fig. 1. Both of these products are two-component thixotropic materials labelled

part A and B. They are converted to solid state when ratio mixing A/B=2 by weight or volume. These materials are generally used for multiple jobs bonding such as steel, motar, glass, wood and more.

2.2 Specimen preparation and curing configuration

Several 31-52 mixture were considered (table 1).

Table 1: Definition of mixture to be studied

Rate 31-52 (respectively)	100%- 0%	66%- 33%	50%- 50%	33%- 66%	100%- 0%
3 days curing	Yes	Yes	Yes	Yes	Yes
6 days curing	Yes	Yes	Yes	Yes	Yes
9 day curing	Yes	Yes	Yes	Yes	Yes

Specimens were prepared in a silicone mold in which the mixed and pure commercial Sikadurs were filled in. Samples had a parallelepipedic shape, with dimensions equal to 230×10×20 mm³ for length, thickness and width (respectively) For each polymeric mixture and curing time, five samples were prepared (See Figure 2.a and 2.b). After drying, to remove roughness, samples were polished using a 10N GAMBIN machine, and their geometry was assessed using a digital caliper (See Figure 2.c and 2.d) to verify their dimension compared to the standard ASTM D790 specimen (for three point bending test). The thickness *t* and width *b* were measured at the top, middle and bottom section, as well as total and span length of each sample were especially focused on.

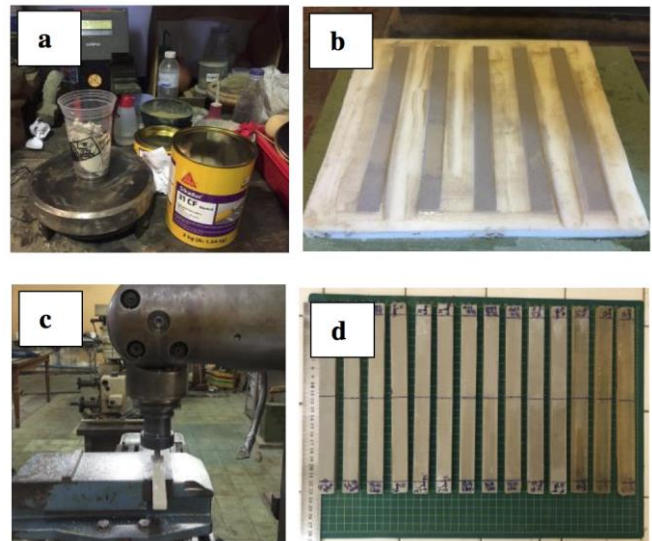

Fig. 2. a) weighing Sika-components, b) curing, c) smoothing the surface, and d) final specimens

2.3 Mechanical characterization

Three point bending test was used to characterize the mixtures properties. A support span-to-depth ratio of 16:1 shall be used unless there is reason to suspect that a larger span-to-depth ratio may be required, as may be the case for certain laminated materials. The specimen was deflected until failure, which is initiated at the outer surface of sample, or until a maximum strain of 5.0 % was reached. Two applied strain rate were used: 0.01 and 0.1 min⁻¹ (ASTM International, 2004).

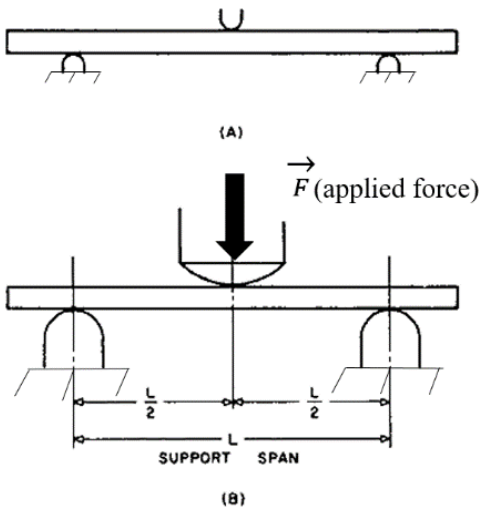

Fig. 3. Allowable range of loading and support radius, (a) Minimum radius=3.2 mm. (b) Maximum radius supports 1.6×(sample depth); maximum radius of the upper tool=4×(sample depth), (ASTM International, 2004)

The ASTM (D790-03) is followed in order to test the flexural properties (Three-point bending). It is performed by AG-Xplus series Autograph universal testing machine (Figure 6) which is essential for wide variety of application ranging from the quality control of everything from materials.

2.4 Determination of mechanical properties

From three point bending test, several mechanical properties might be deduced, following the sample dimensions.

Flexural Stress (σ_f) - If support span-to-depth ratios greater than 16 to 1 are used so that deflections in excess of 10 % of the support span occurs, the stress in the outer surface of the specimen for a simple beam can be reasonably approximated by the following equation.

$$\sigma_f = \frac{(3PL/2bd^2)[1 + 6(D/L)^2 - 4(d/l)(D/L)]}{(Eq. 1)}$$

where D represents the deflection of the centerline of the specimen at the middle of the support span (mm), d represents the depth of beam (mm), L the length between the lower tools and P the applied load.

Flexural Strain (ϵ_f) – represents the nominal fractional change in the length of an element of the outer surface of the test specimen at mid-span, where the maximum strain occurs. It may be calculated for any deflection by:

$$\epsilon_f = 6Dd/L^2 \quad (Eq. 2)$$

The modulus of elasticity (E_B) - often called the “tangent modulus of elasticity”; this is the ratio, within the elastic limit, between the stress and the corresponding strain. It is calculated by drawing a tangent to the steepest initial straight-line portion of the load-deflection curve by using Equation:

$$E_B = L^3m/4bd^3 \quad (Eq. 3)$$

where m is the slope of the tangent to the initial straight-line portion of the load-deflection curve N/mm of deflection.

2.5 Determination of the sample porosities

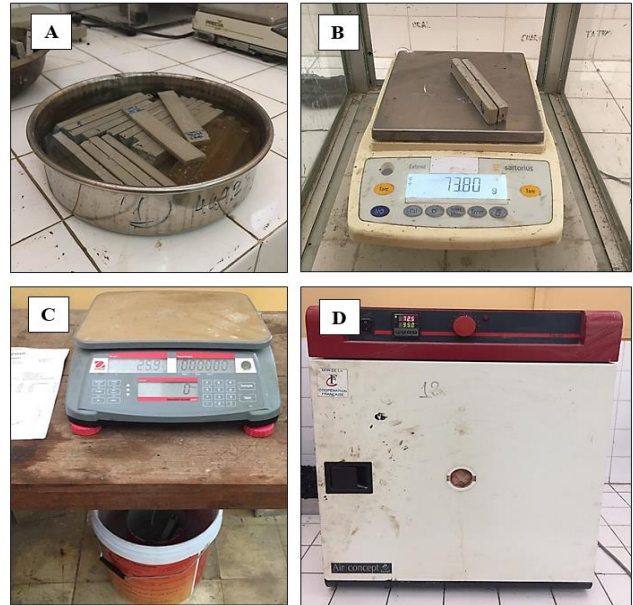

Fig. 4. (a) keep specimens saturated, (b) weighting them on electronic scale, (c) water immersed weighting, and (d) drying the specimens by microwave

Due to the manufacturing process, and the important viscosities, porosity is created in samples. To evaluate that porosity, at different curing days, water immersed (W_w) and the saturated surface dry (W_{ssd}) weight have been measured. Firstly, the specimens were immersed into water for 96 hours, until it reached the plateau in weight. Then, tissue was

used to dry the surface, so the saturated surface dried specimens were able to weigh and then weigh them again under water by RANGER-COUNT 2000 scale for water immersed specimens. Last, samples were heated at $60 \pm 5 \text{ }^\circ\text{C}$ for 24 hours, till it reached the plateau in dry; the weight (W_d) of the dried specimens is then measured (Figure 3). Porosity is estimated by:

$$P = \frac{W_{ssd} - W_d}{W_{ssd} - W_w} \times 100 \quad (\text{Eq. 4})$$

This method has been used to measure the porosity of cement-based materials successfully (Day RL, 1988).

2.6 Test setup

The ASTM (D790-03) is followed in order to test the flexural properties (Three-point bending). It is performed by AG-Xplus series Autograph universal testing machine (Figure 5) which is essential for wide variety of application ranging from the quality control of everything from materials.



Fig. 5. Three-point bending test operated on specimen by AG-Xplus series Autograph universal testing machine

3. RESULTS AND DISCUSSION

Flexural strength and modulus (Fig. 6) show different evolution depending on the drying time and sample composition. For the result of flexural strength of Sikadur® 31 at 9 days curing time, Sika test is 35 MPa while the experiment is approximately 27 MPa which it is considered around 1.3 time lower than Sika test. With results of flexural modulus from experiment, is measured at around 700 and 4000 MPa for the Sikadur® 52 and 31 (respectively), while the Sika company indicates 1100 and 4300 MPa. The comparison shows a bit different for Sikadur® 31 and is around 1.5 time lower than Sika test for Sikadur® 52.

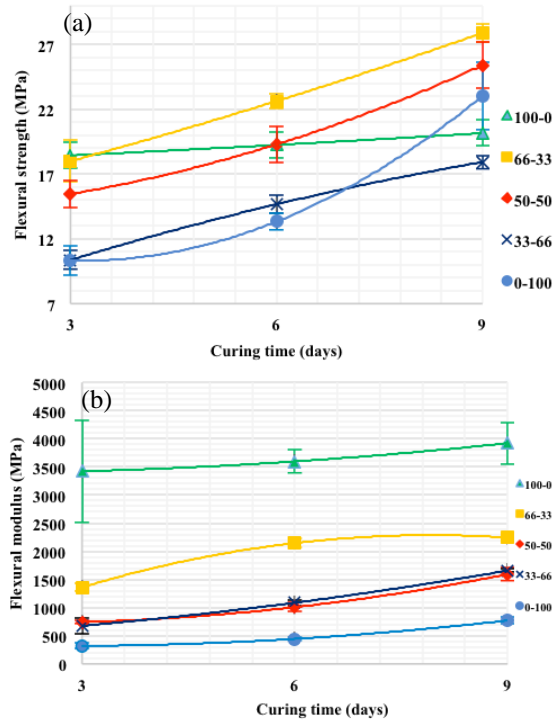

Fig. 6. Combination of (a) flexural strength, (b) flexural modulus with ratio mixed Sikadur® 31-52, respectively and curing days with error bar and standard deviation (0-100 represent a pure Sikadur 52 sample).

An increase of the drying time increase the mechanical properties. Further investigations must be conducted to have a clear view on the variation of mechanical strength with the mixtude composition; however, an important aspect is that no degradation of the properties are triggered by the mixing process; furthermore, several improvement might be observed, e.g., for the flexural strength.

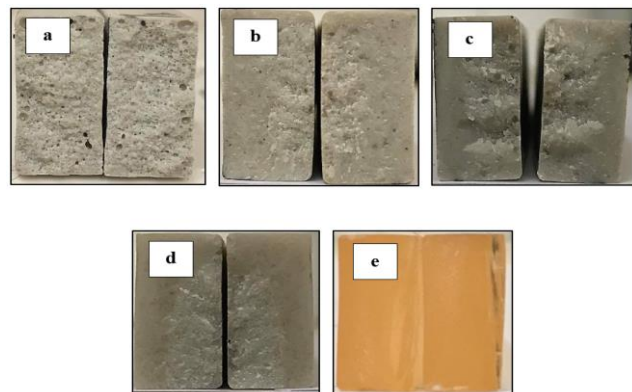

Fig. 7. Fracture surface of ratio mixed Sikadur® 31-52, (a) 100%-0%, (b) 66%-33%, (c) 50%-50%, (d) 33%-66%, and (e) 0%-100% (Respectively) with error bar and standard deviation

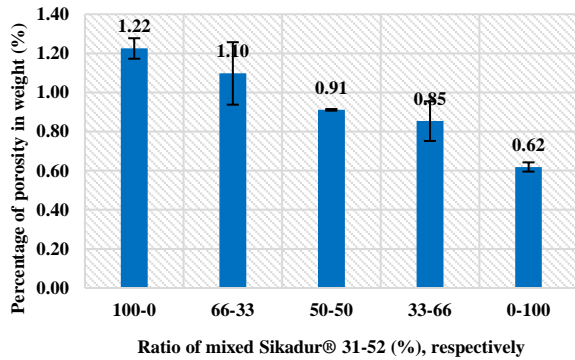

Fig. 8. Percentage of porosity in weight diagram in ratio mixed Sikadur® 31-52 (respectively) with 6 days curing time with error bar and standard deviation

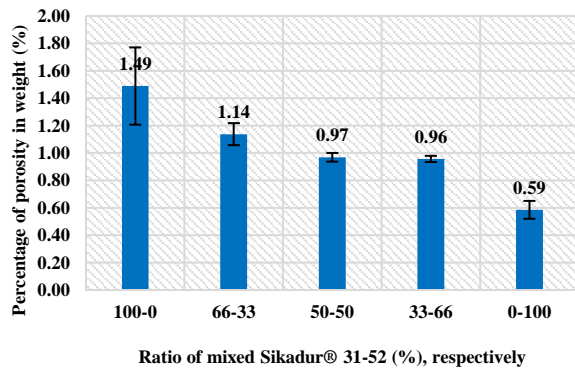

Fig. 9. Percentage of porosity in weight diagram in ratio mixed Sikadur® 31-52 (respectively) with 9 days curing time with error bar and standard deviation

To be clear, the diagram as shown in (Figure 8 and 9), determined by the (Equation 4) illustrated the weight percentage of porosity inside each specimens from both pure epoxy resin and mixture, following by (100-0, 66-33, 50-50, 33-66 and 0-100, in rate percentage of Sikadur® 31-52 respectively) with 6 and 9 days curing time.

The diagram showed that pure Sikadur® 31(100-0) has a higher weight percentage of porosity that is similar to the photo in (Figure 7), 1.22% and 1.49% in 6 and 9 days curing time specimen (respectively), while the pure Sikadur® 52 (0-100) has the lowest porosity in 0.62% and 0.59% compared to the specimen weight. Furthermore, other noticeable thing is that it becomes obvious that porosity has drastically increased when high initially applied the pure Sikadur® 31 to each mixture and lower the porosity by mixing a higher amount pure Sikadur® 52. However, it can be estimated that absence of porosity, all the specimens in each rate could much improve the strength especially for pure Sikadur® 31 with the highest porosity.

4. CONCLUSIONS

Based on the findings of the present investigation, the following conclusions can be drawn:

- In daily use from National Museum of Cambodia, it is possible to fabricate the mix of commercial Sikadur® 31 and 52 with higher flexural strength. From the experiment, the higher Sikadur® 31 is added, the more strength it is so that the best value of strength can be obtained only with the 66% of Sikadur® 31 and 33% of Sikadur® 52. What is more, it costs much lower than other mixture as well as the pure Sikadur because Sikadur® 52 is expensive than Sikadur® 31 in market.
- Curing period of the specimen has great influence on the kind of commercial Sikadur® 31 and 52. With the increase of curing period, the ultimate strength, modulus of elastic increase gradually.
- It is noticeable that Sikadur® 31 with high viscosity, has more porosity than others. In addition, the study showed that increasing amount of Sikadur® 31 adding to others could rise the porosity. Contrastingly, increasing the Sikadur® 52 in mixture could lower the porosity. For further investigations, there are some recommendations:
- Future research should investigate the extraction of porosity in specimen by using vacuum machine and make a comparison to SIKA Company or the study relationship between the strength and porosity.
- Mechanical behavior (Young Modulus, Failure stress under traction and compression), depending on the mixing process (drying time, temperature)
- Forming properties (viscosity, shrinkage during the drying process, adhesion to rocks and metals)
- Behavior under stress (creep, humidity influence, thermal expansion coefficient, water absorption, ageing, etc.).

ACKNOWLEDGMENTS

I would like to express my deepest appreciation towards all my lectures at Institute of Technology of Cambodia (ITC) and whole team at National Museum of Cambodia, guided and helped me to carry out the study.

REFERENCES

Douglas, J. G., Carò, F., & Fischer, C. (2010). Evidence of sandstone usage for sculpture during the Khmer Empire in Cambodia through petrographic analysis. *UDAYA Journal of Khmer Studies*, 9, 1-17.

Hendrickson, M., Pryce, T. O., Sonnemann, T., Phon, K., Hua, Q., & Chan, S. (2018). Industries of Angkor Project: Preliminary investigation of iron production at

- Boeng Kroam, Preah Khan of Kompong Svay. *Journal of Indo-Pacific Archaeology*, 42, 32-42.
- Wright, K. R., & Zegarra, A. V. (2000). Machu Picchu: A Civil Engineering Marvel. American Society of Civil Engineers, ASCE Press.
- Pollard, A. M., Batt, C. M., Stern, B., Young, S. M., & Young, S. M. M. (2007). *Analytical chemistry in archaeology*. Cambridge University Press.
- Wanhill, R. J. H. (2003). Brittle archaeological silver: a fracture mechanisms and mechanics assessment. *Archaeometry*, 45(4), 625-636.
- Jessup, H. I., & Gollings J. (2006). Masterpieces of the National Museum of Cambodia: an introduction to the collection. Norfolk, CT: Friends of Khmer Culture. 112 pages.
- Lenzi, I. (2004). Museums of Southeast Asia. Archipelago Press, Singapore, p. 200.
- Khdir, Y. K., & Gailan I. H. (2018). Use of different graded brass debris in epoxy-resin composites for improving mechanical properties. *4th International Engineering Conference on Developments in Civil & Computer Engineering Applications (IEC2018)*, February 26-27, Erbil, Kurdistan, Iraq.
- Michels, J., Cruz, J. S., Christen, R., Czaderski, C., & Motavalli, M. (2016). Mechanical performance of cold-curing epoxy adhesives after different mixing and curing procedures. *Composites Part B: Engineering*, 98, 434-443.
- ASTM International (2004). *Annual book of ASTM standards*. ASTM International.
- Day, R. L., & Marsh, B. K. (1988). Measurement of porosity in blended cement pastes. *Cement and Concrete Research*, 18(1), 63-73.