



INSTITUTO
DE INGENIERÍA
UNAM®



Groupe de Recherche en
Energie Electrique de Nancy
Green

8th International Workshop on Numerical Modelling of High Temperature Superconductors
14th–16th June 2022. Nancy, France.

Coupled FEM-Circuit analysis for interconnected High Temperature Superconducting machines and components

W. Durante-Gómez¹, **F. Trillaud**², F. González-Montañez³, G. Hajiri⁴, K. Berger⁴, R. Dorget^{4,5}, J. de la Cruz-Soto⁶

¹Posgrado en Ingeniería Eléctrica, UNAM, CDMX 04510, México, wilder.durante@gmail.com

²Instituto de Ingeniería, UNAM, CDMX 04510, México, ftrillaudp@ii.unam.mx

³Departamento de Energía, Universidad Autónoma Metropolitana, CDMX 02200, México, f.g.mx@ieee.org

⁴GREEN, Université de Lorraine, F-54000 Nancy, France, kevin.berger@univ-lorraine.fr,
ghazi.hajiri@univ-lorraine.fr and remi.dorget@univ-lorraine.fr

⁵Electrical and Electronic Systems Research Group, Safran Tech, F-78114 Magny-Les-Hameaux, France

⁶Instituto Nacional de Electricidad y Energías Limpias, Cuernavaca 62490, México, javier.delacruz@ineel.mx

Motivation

□ Development of models:

- Existing advanced formulations of Maxwell equations: **H-A** and **T-A** mixed with homogeneous technique ⇒ *practical for machine models* [1]
- Modeling of SC components interacting with simple external circuit / components
- **Next step: from component to system ⇒ FEM - Circuit coupling** [2]

□ Supporting:

- Development light and compact power components for transportation based on High Temperature Superconductor (HTS) components [3]

□ Responding to:

- Growing interest in the aircraft industries (two axes): 1) liquid hydrogen fuel, 2) more electric aircraft (MEA) ⇒ Hydrogen as coolant for SC components [4]

[1]: Y. Yang, et al, *IEEE Trans on App. Sup.*, 2020, doi: 10.1109/TASC.2020.3005503.

[2]: Z. Wang et al., *IEEE Trans. on App. Sup.*, 2017, doi: 10.1109/TASC.2017.2653807.

[3]: K. S. Haran et al, *Supercond. Sci. Technol.* 30 (2017) 123002 (41pp)

[4]: Airbus website, ACEND project, March 2021:

<https://www.airbus.com/en/newsroom/press-releases/2021-03-airbus-to-boost-cold-technology-testing-as-part-of-its>



Fig. 1: Hybrid hydrogen aircraft from airbus (<https://www.airbus.com/en/innovation/zero-emission/hydrogen/zeroe>)

DC power chain

□ Power chain:

- Generation (HTSG, 10 MW) - cold
- Conversion (power electronics) - warm/cold
- distribution (HTSC) - cold
- Load (HTSM, 2.5 MW) - cold

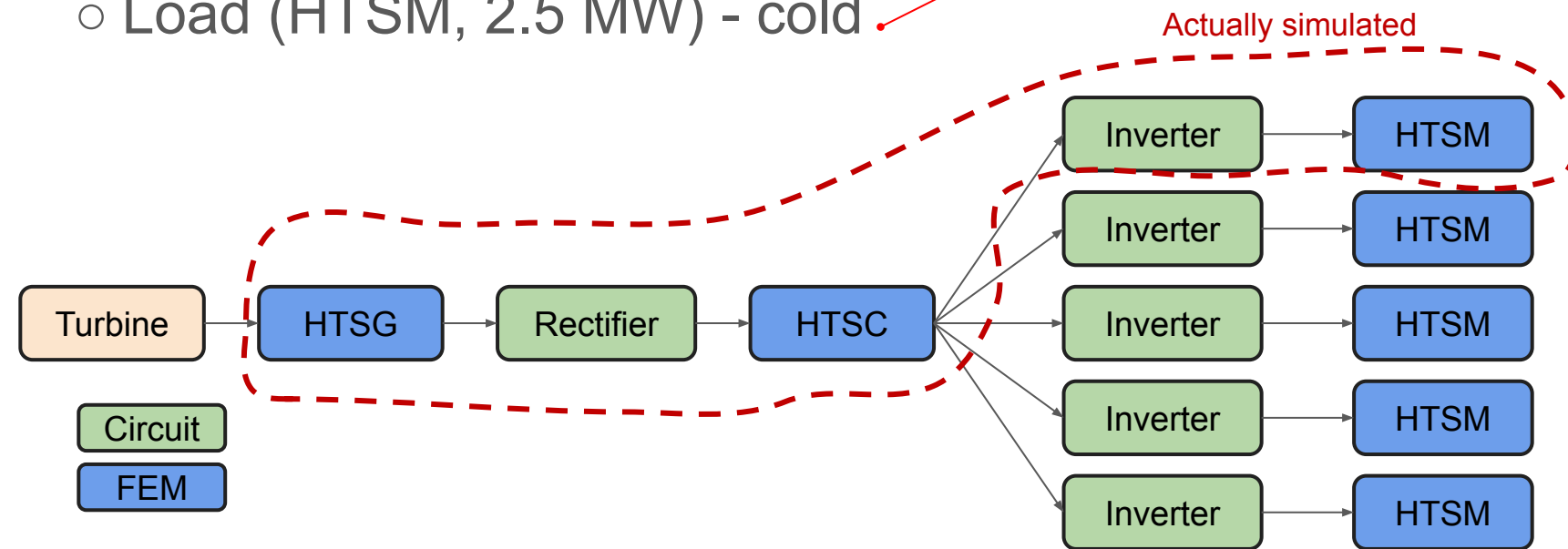

Fig. 2: Power chain from turbine to load: G for generator, C for cable and M for motor.

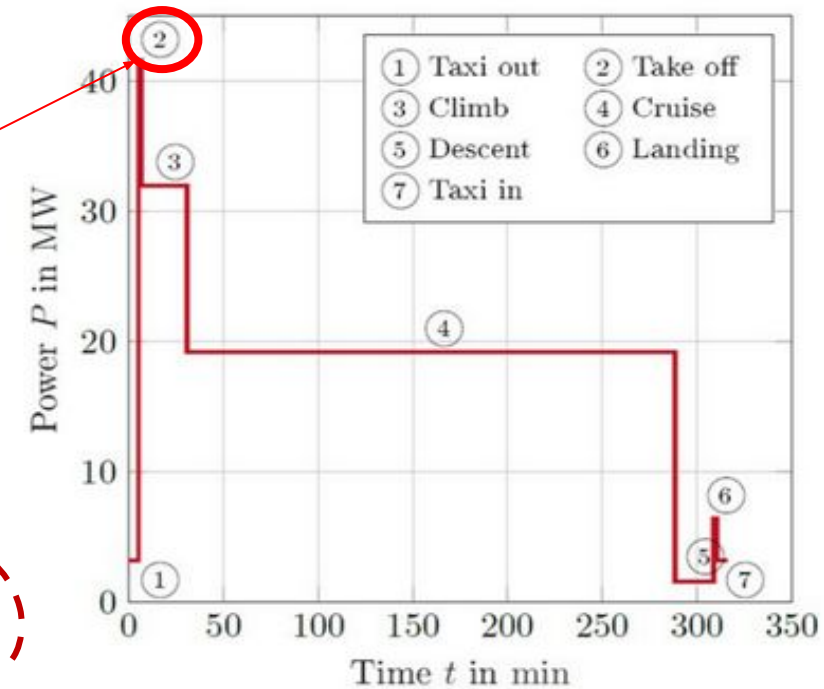

Fig. 3: Power demand. Interest in transient: Take off (2) with maximum peak of demand [5]

[5]: M. Boll et al, Supercond. Sci. Technol. 33 (2020) 044014 (14pp)

FEM-Circuit model

- Cosimulation: transient FEM - electrical circuit model using COMSOL Multiphysics and Simulink
- Case study (Fig. 4): superconducting (SC) generators, rectifier, filter, SC cable, inverter, filter and SC motors (1 out of 4, we used 1 power converter for this case study)
- Machine model for generator and motor: SC ironless rotor - conventional stator [6]
- Machines and cable modeled with homogeneous T-A, with Kim's relation $J_c(\mathbf{B})$

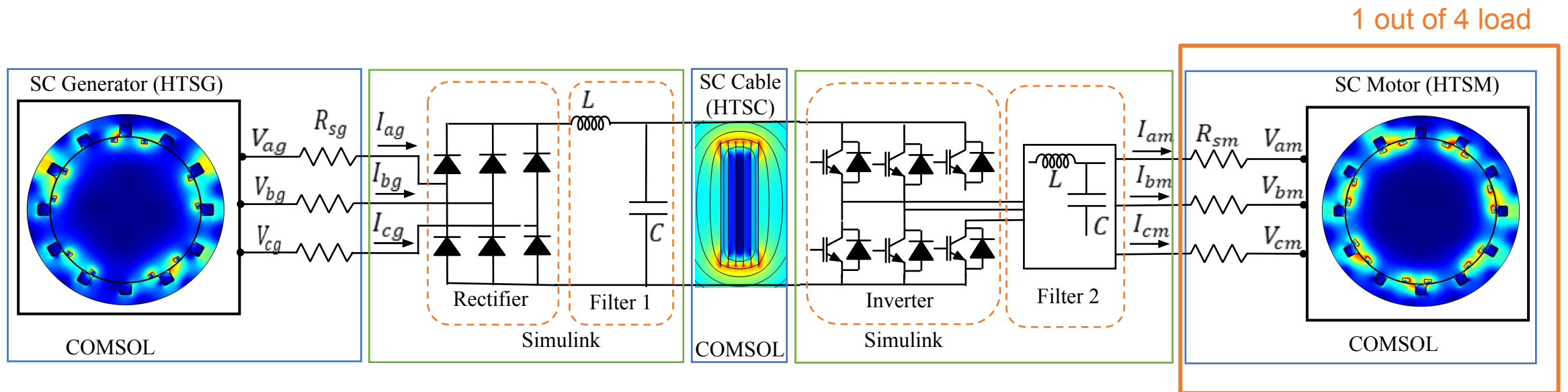

Fig. 4: Diagram of the coupled FEM-Circuit using COMSOL and Simulink.

[6]: M. Corduan et al, *IEEE Trans on App. Sup.*, 2020, doi: 10.1109/TASC.2019.2963396.

HTS rotating machines (HTSG and HTSM)

□ Hybrid machines cooled by liquid hydrogen at 25 K:

- Ironless rotor: REBCO racetrack coils (I_c of tape at peak perpendicular field)
- Stator: basic COMSOL model (magnetic core to lock the flux)

Table I: Characteristics of SC machines

Parameters	Generator	Motor
Maximum power	10 MW	2.5 MW
Rotor mechanical speed	10,000 rpm	4,500 rpm
Torque	10 kNm	5.31 kNm
Electrical frequency, f_e	833.33 Hz	525 Hz
Current density in stator	15 A/m ²	6.7 A/m ²
Number of pairs of pole	5	7
Number of slots		12
Stator winding resistance	1.22 mΩ	1.31 mΩ
Rotor operating temperature (hydrogen coolant)		25 K
Number of HTS tapes per coil on the rotor	160	180
Transport current for each HTS tape / I_c [7]	500 A / 1224 A	530 A / 1224 A

[7]: Robinson Research Institute, "Critical current characterisation of Fujikura FYSC 2G HTS superconducting wire", https://figshare.com/articles/dataset/Critical_current_characterisation_of_Fujikura_2G HTS_superconducting_wire/3759321?backTo=collections/A_high_temperature_superconducting HTS_wire_critical_current_database/2861821

Similar geometry on purpose

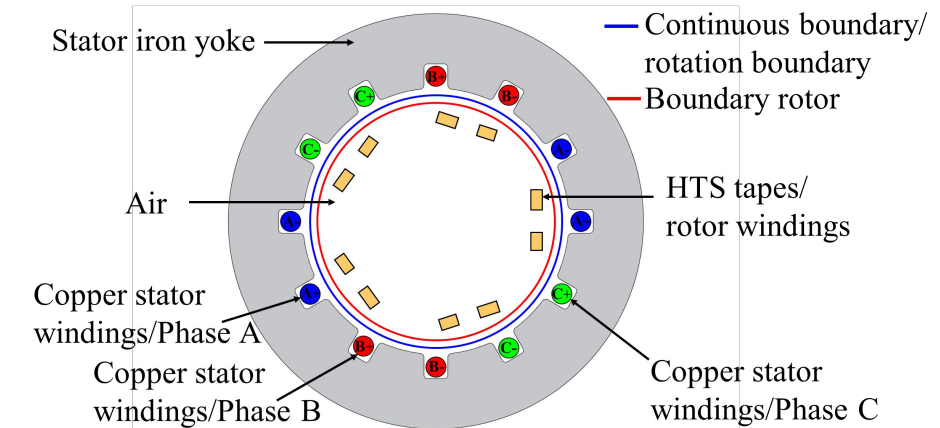

Fig. 5: Geometric model of generator.

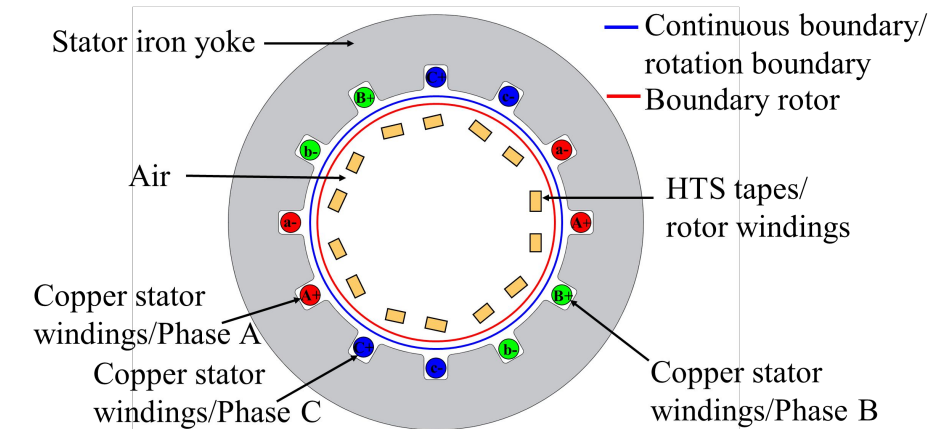

Fig. 6: Geometric model of motor.

Cosimulation: COMSOL - Simulink

❑ Cosimulation tool: Simulink LiveLink™ module, sequentially coupling COMSOL Multiphysics® with Simulink®

❑ Setting up the cosimulation:

COMSOL side

1. Create a COMSOL model
2. Generation of a cosimulation file in FMU format

Simulink side

3. Build a Simulink circuit including a “COMSOL Cosimulation” block
4. Run Simulink

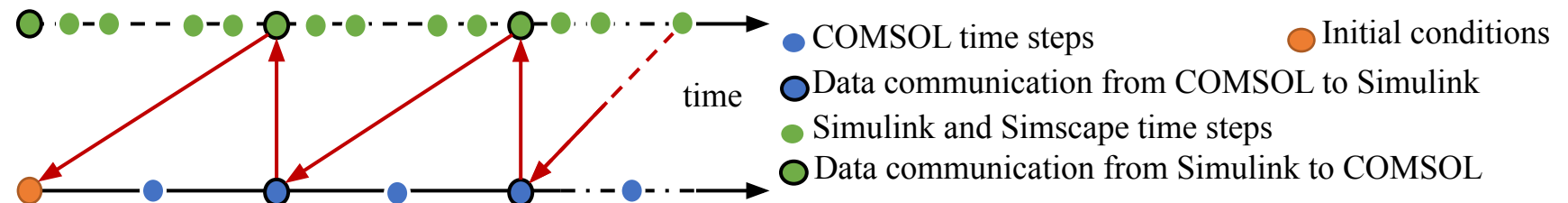

Fig. 7: Exchange process between COMSOL and Simulink.

Case studies: steady state case for now

Step-by-step approach

The original case study was split in 4 sub-cases:

1. SC Generator - DC circuit
2. DC circuit - SC motor
3. SC Generator - DC circuit - SC motor
4. SC Generator - Circuit - SC cable

Rotor current ramped up from 0 to rated current

Characteristics of the circuit components:

- Generator resistances, $R_{sg} = 1.22 \text{ m}\Omega$
- Motor resistances, $R_{sm} = 1.31 \text{ m}\Omega$
- RLC filter (rectifier):
 $r = 0.08 \text{ }\Omega$, $L = 0.05 \text{ mH}$, $C = 100 \text{ }\mu\text{F}$
- 3-phase LC filter (inverter):
 $L = 0.5 \text{ mH}$, $C = 0.132 \text{ }\mu\text{F}$

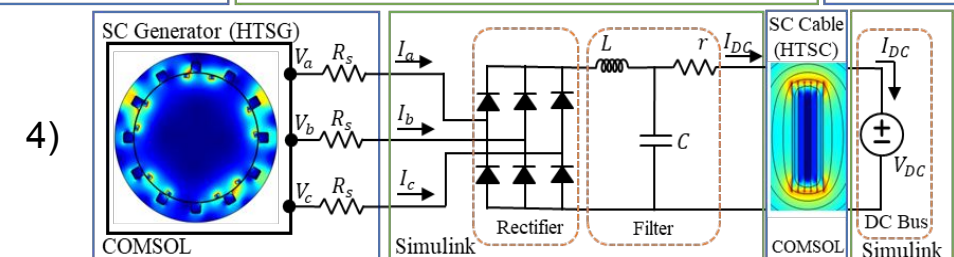
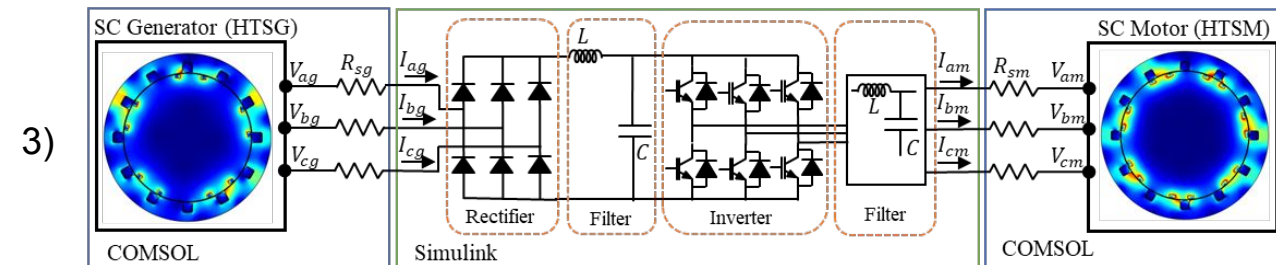
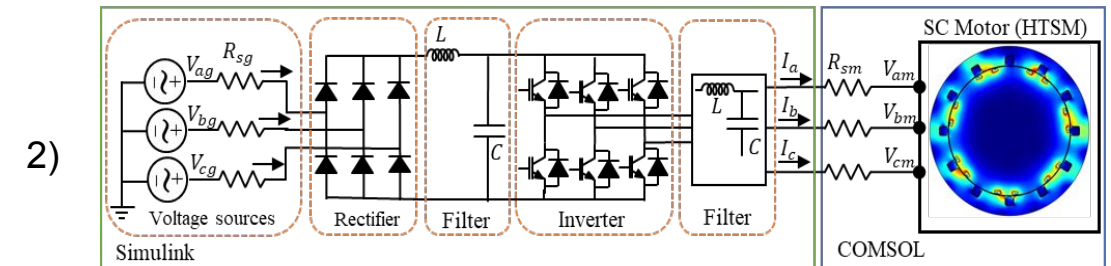
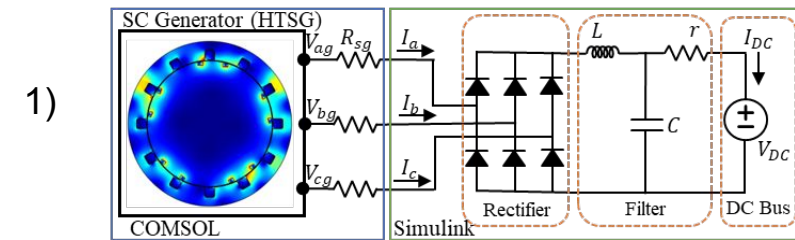

Fig. 8: Four sub-case studies: 1) SC Generator - DC circuit, 2) DC circuit - SC motor, 3) SC Generator - DC circuit - SC motor, and 4) SC Generator- DC circuit- SC cable

Case 1: SC generator - DC circuit

- Infinite DC bus modeled by a constant ideal voltage source at 3 kV
- Rectifier: power diodes; $r_{on} = 0.107 \text{ m}\Omega$, $1/r_{off} = 10 \text{ nS}$ y $V_f = 0.8 \text{ V}$.

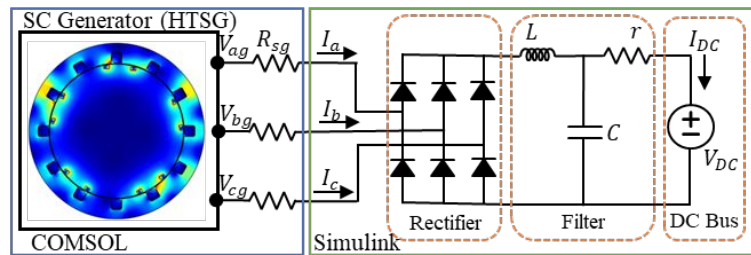

Fig. 9: Circuit: SC Generator - DC Bus.

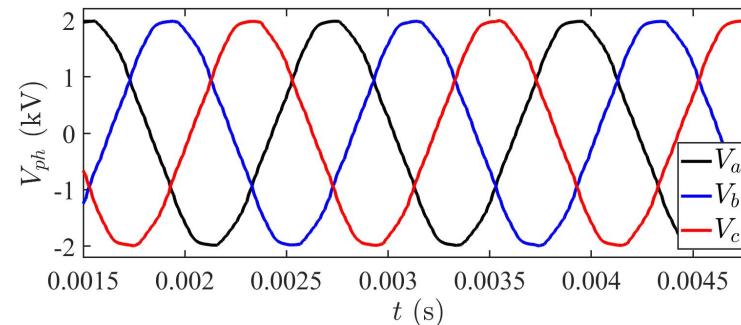

Fig. 10: Generator output voltages

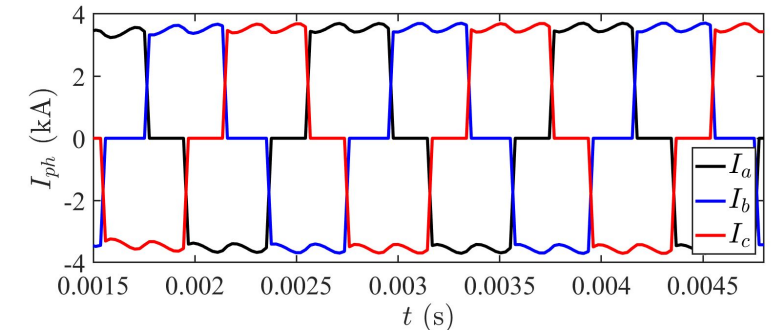

Fig. 11: Generator output currents

Tabla II. Co-simulation time parameters SC generator - DC bus circuit

Cosimulation FEM-Electric Circuit (for 4 electrical cycles)	
Cosimulation time	6 h 30 min 24 s
Time step in FEM	$1/100/f_e = 1.2 \text{ E-5 s}$
Communication step	$2/100/f_e = 2.4 \text{ E-5 s}$
Stop time	4.8 E-3 s

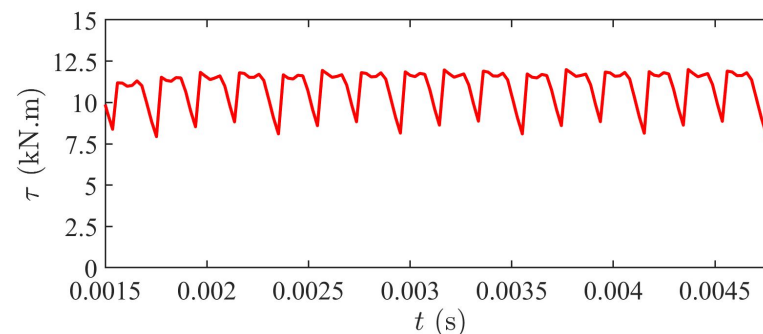

Fig. 12: Generator electromagnetic torque

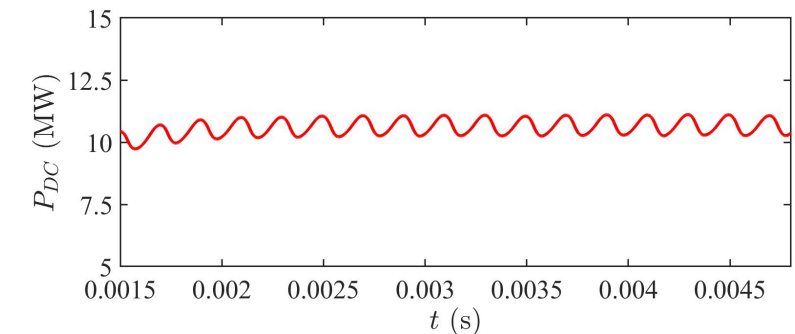

Fig. 13: Power supplied to the DC bus

Case 2: DC circuit - SC motor

□ AC voltage source, maximum voltage 2 kV, $f_e = 833.33$ Hz, phase of 120°

□ Inverter: Pulse Width Modulation (PWM)

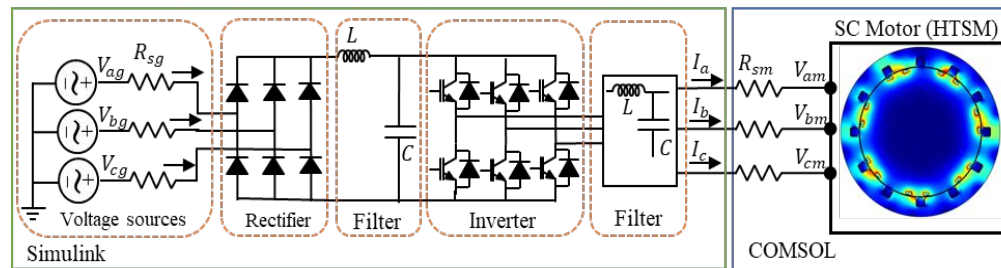

Fig. 14: Circuit: DC Circuit - SC motor.

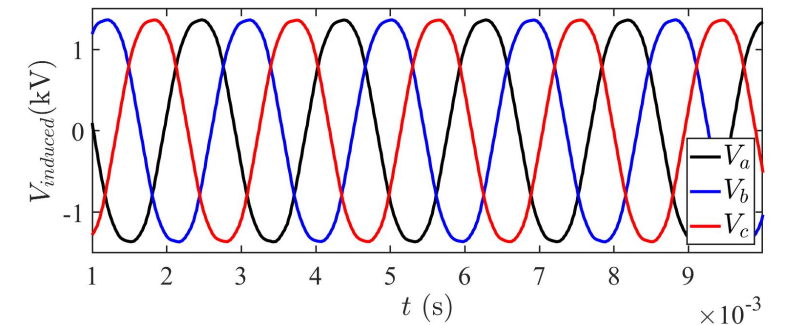

Fig. 15: Motor input voltages

Tabla III. Co-simulation time parameters DC circuit - SC Motor

Co-simulation FEM-Electric Circuit	
Co-simulation time	9 h 45 min 5 s
Time step in FEM	$1/100/f_e = 1.905 \text{ E-}5 \text{ s}$
Communication step	$2/100/f_e = 3.81 \text{ E-}5 \text{ s}$
Stop time	0.01 s

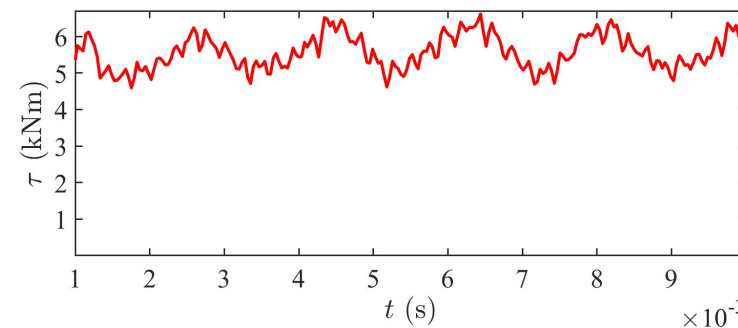

Fig. 17: Motor electromagnetic torque

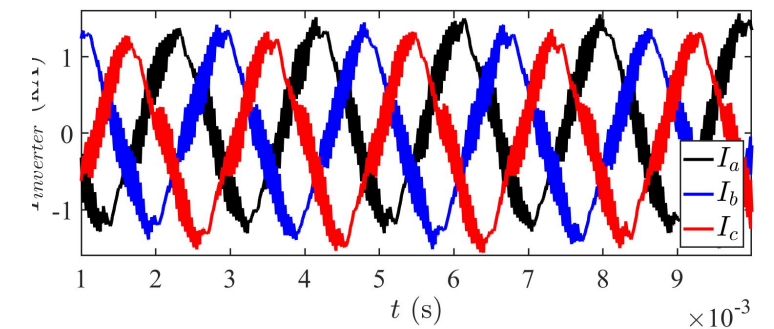

Fig. 16: Inverter input currents

Case 3: SC Generator - Circuit - SC Motor

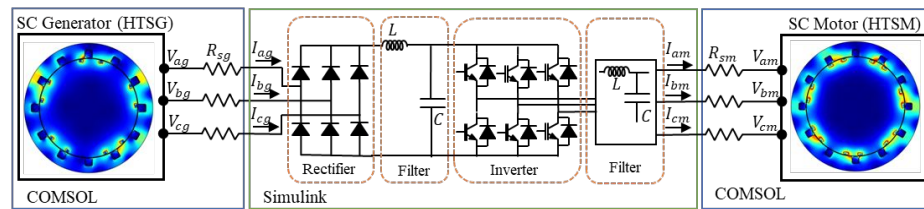

Fig. 18: Circuit: SC Generator - DC Circuit - SC motor.

Table IV. Parameters of the co-simulation: SC Generator-Circuit- SC Motor

	No. internal steps per 1 cycle/electric (FEM)	Time step in FEM (s)	Communication Step(s)	No. Electric cycles	No. of rev	Stop time	Cosimulation time
Generator	80	1.5E-5	3E-5	5.83	1.16	0.007s	14 h 14 min 16s
Motor	100	1.905E-5	3.81E-5	3.67	0.525		

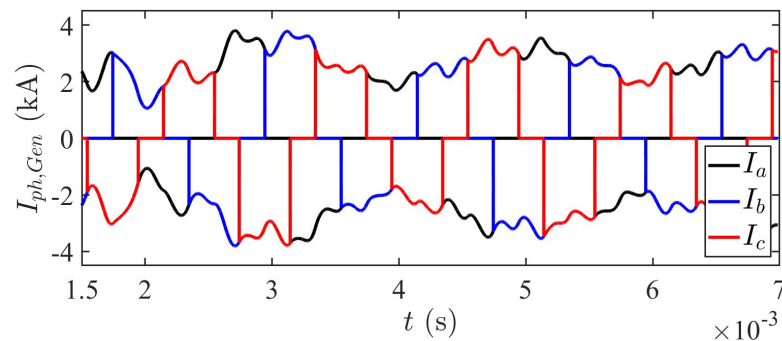

Fig. 19: Generator output currents

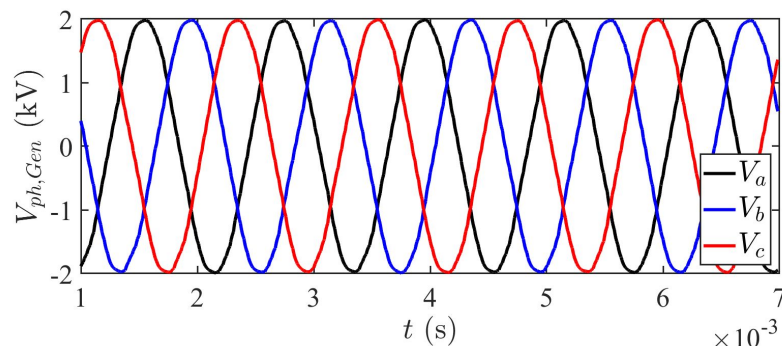

Fig. 21: Generator output voltages

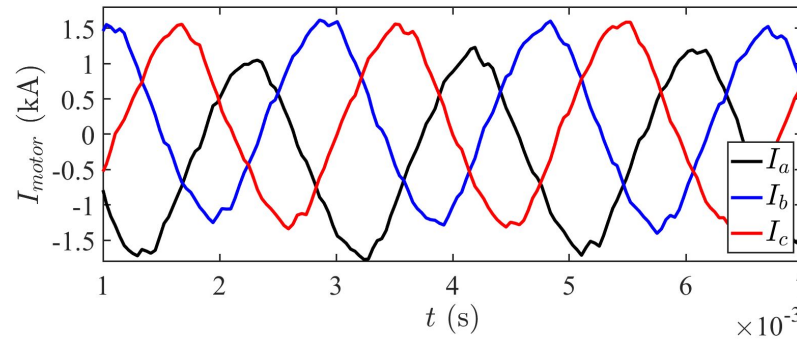

Fig. 20: Motor inputs currents

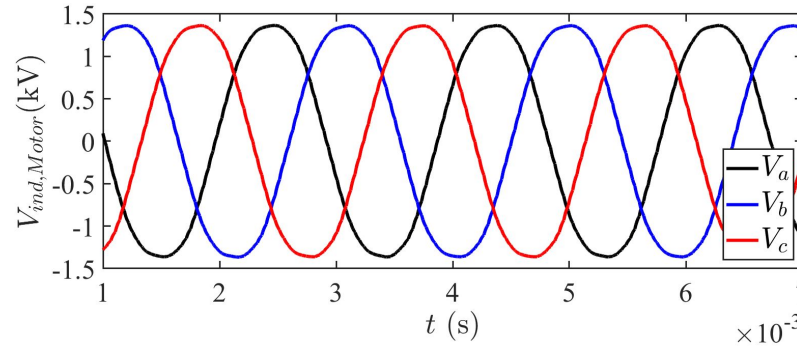

Fig. 22: Motor input voltages

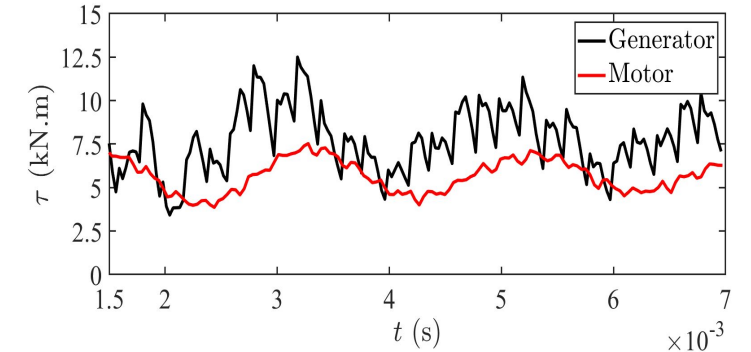

Fig. 23: Electromagnetic torque comparison

Case 4: SC generator - Circuit - SC cable

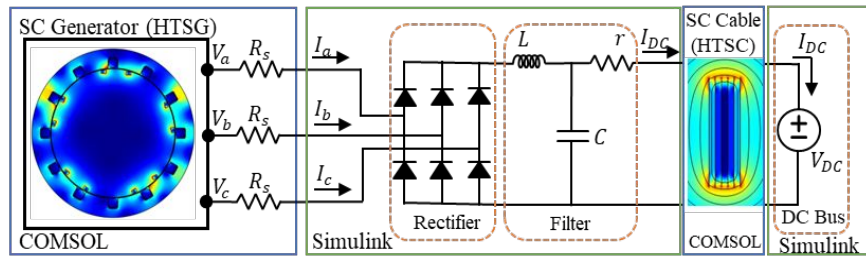

Fig. 24: Circuit: SC Generator- DC circuit- SC cable

Table V. Parameters of the cosimulation: SC Generator-Circuit- SC Cable

	Time step in FEM (s)	Communication Step (s)	Stop time (s)	Co-simulation time
Generator	1.5E-5	3E-5	0.0036 s	5 h 41 min 47s
Cable	1.2E-5	6E-5		

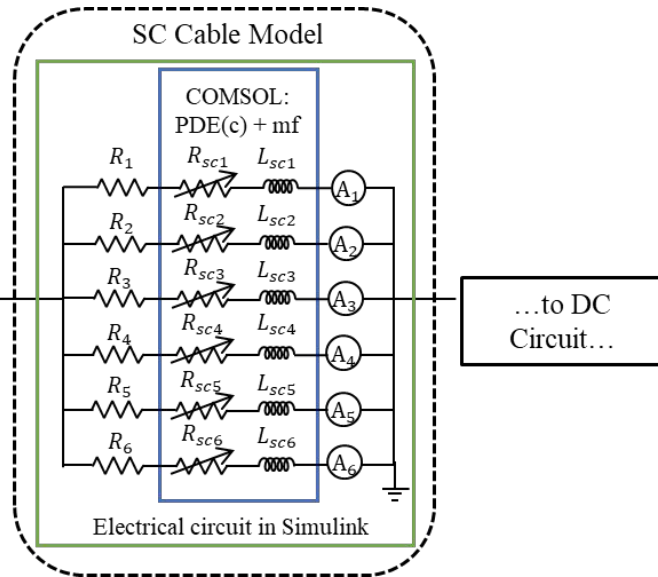

Fig. 25: Conceptual diagram of the electrical circuit (Simulink) coupling SC Generator- DC circuit- SC cable

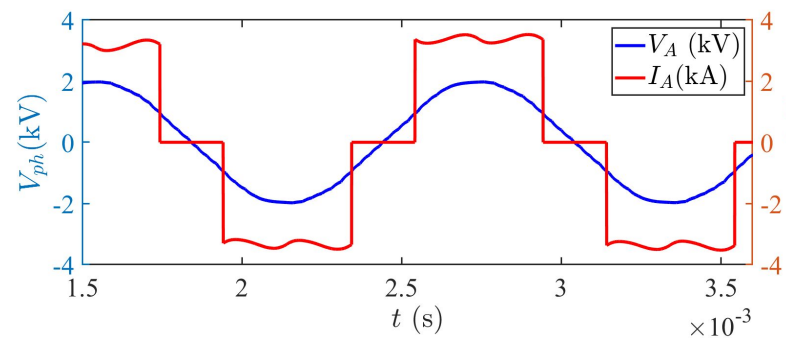

Fig. 26: Generator, voltage vs current (phase a)

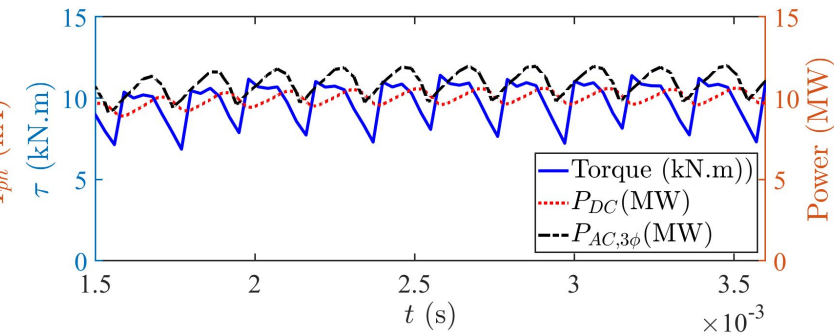

Fig. 27: Comparison of electromagnetic torque, power supplied to the DC bus and three-phase power generator.

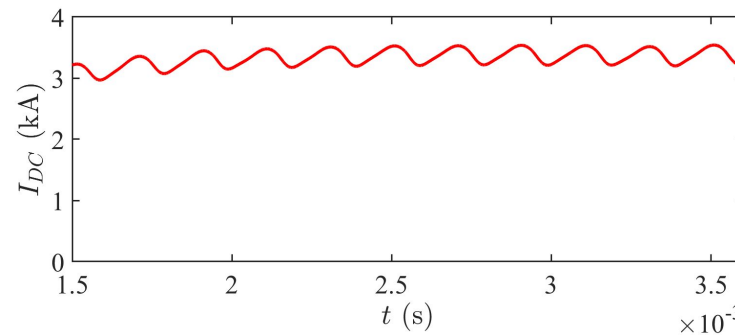

Fig. 28: I_{DC} , DC bus

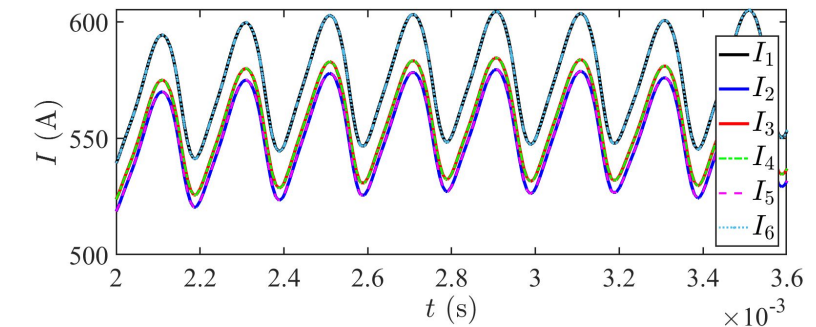

Fig. 29: Current distribution in each tape of the SC cable

Redistribution of current in the cable may be not uniform from layer to layer (I_c dependency on \mathbf{B} and transients)

Conclusions and perspectives

- ❑ A coupled FEM-Circuit is being developed to simulate the transient electromagnetic behavior of SC components for a MEA power chain
- ❑ The final step is the coupling of the SC machines and the SC cable to complete the power chain
- ❑ The goal is to provide a roadmap to study power systems considering HTS devices for performance analysis and design optimization still benefiting from the FEM capabilities

- ❑ Upcoming:
 - Initial conditions for machine models, need for a pre-estimation of machine parameters under load
 - Transient studies
 - Global reduction of computation time

- ❑ Future work:
 - MgB₂ stator for SC machines for full SC machines thinking of power electronics at cryogenics temperature [8]

[8]: H. Gui *et al.*, *IEEE Trans on P. Elect.*, 2020, doi: 10.1109/TPEL.2019.2944781.

Thank you for your attention!

Case 3: Coupling process

- Coupling HTSG 10 MW and HTSM 2.5 MW.
- Division of the electrical circuit into two subcircuits.
- Equivalent resistance (R_{Eq}) calculate:

$$R_{eq} = \frac{V_{dc}}{I_{dc}} \cdot \left(\frac{1}{4}\right)$$

- R_{Eq} represents the load of the 4 motors in parallel.
- I_{dc} and V_{dc} are DC measurements from the inverter side.
- $I_{dc} \Rightarrow$ filtering process

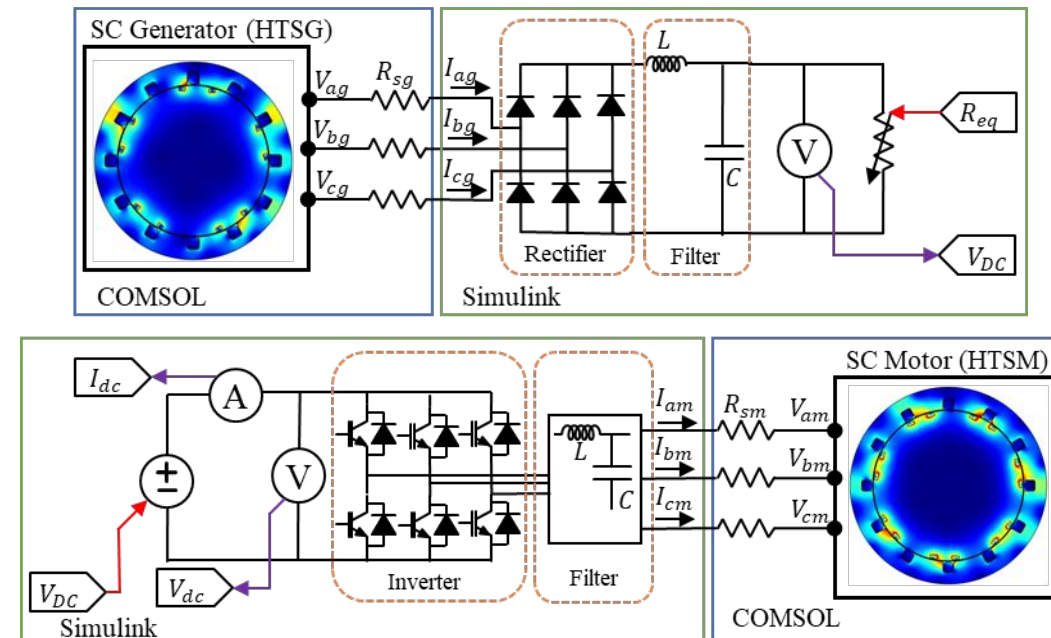
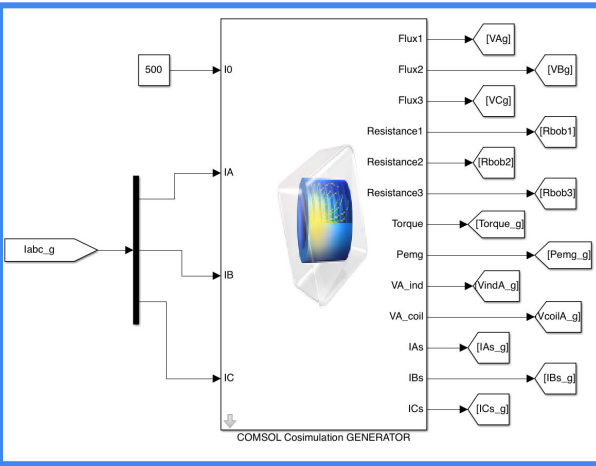

Fig. 30: Conceptual diagram of coupling HTS machines (HTSG and HTSM)- DC circuit in Simulink

Case 3: Simulink model

Generator cosimulation block



From COMSOL

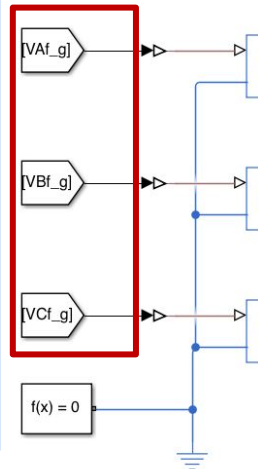

From COMSOL

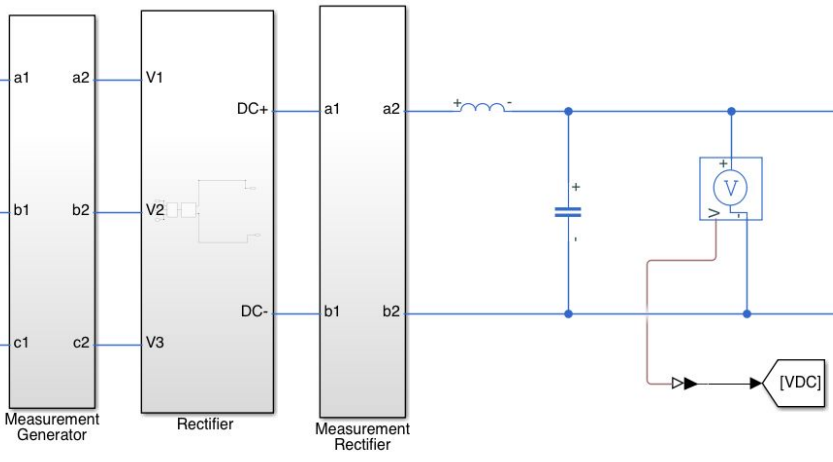
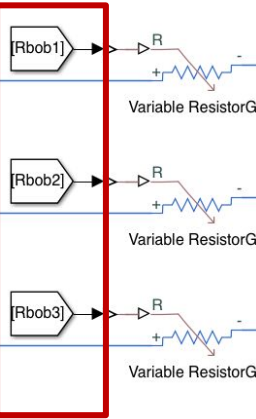

Machine in Simulink

Motor cosimulation block

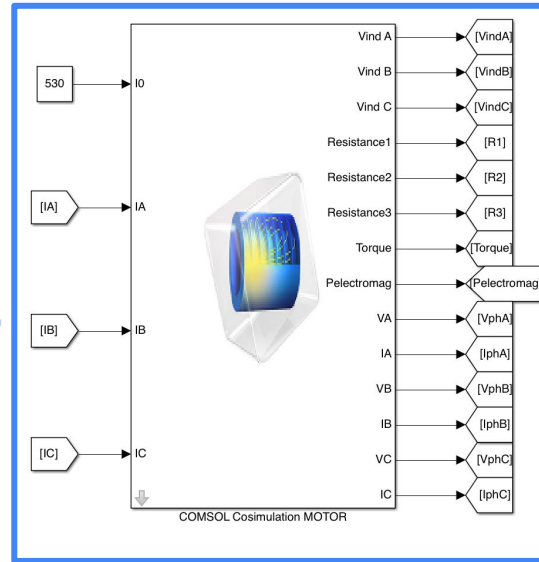

From COMSOL

From COMSOL

From Simulink, R_{eq} calculate

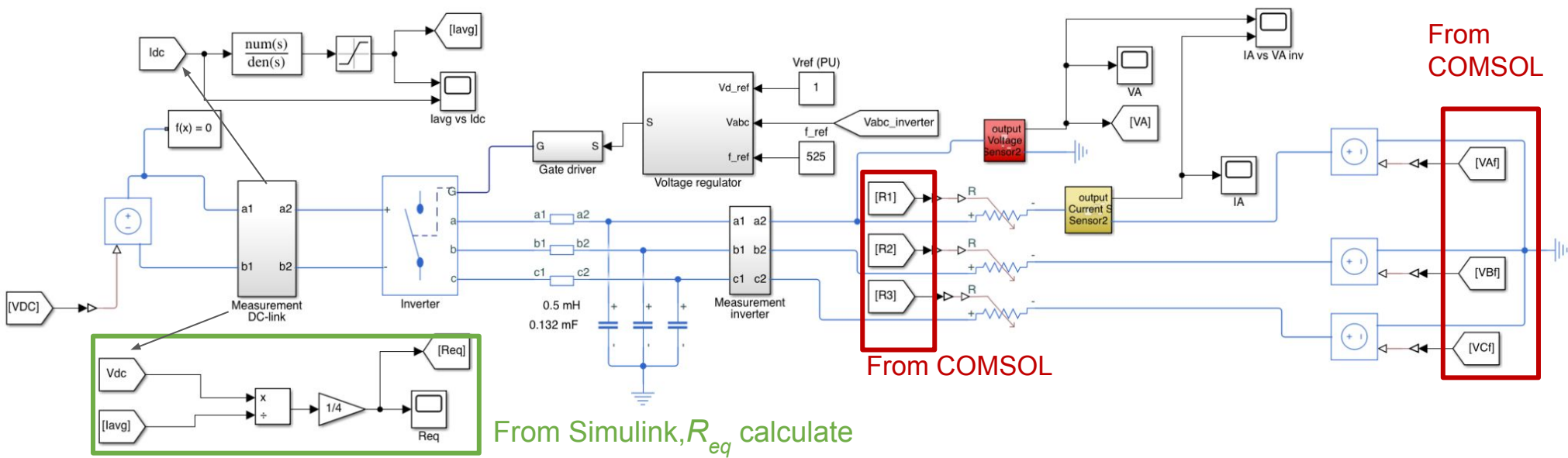

Case 3: SC Generator - Circuit - SC Motor

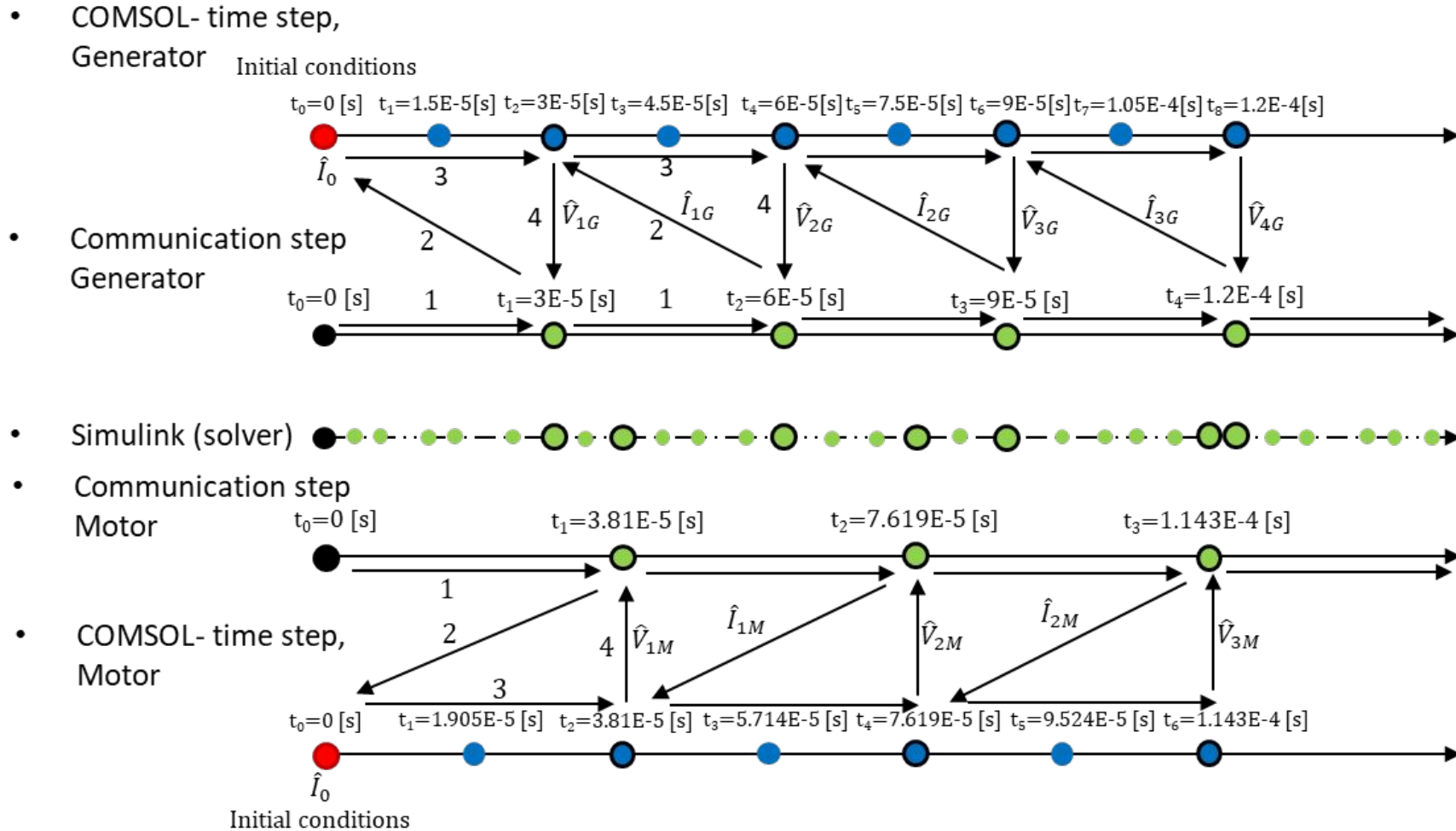

Fig. 31: Process of steps the cosimulation of the FEM models (generator and motor) with electrical circuit.