

Current Distribution Simulation for REBCO Pancake Coils Applying Low-Frequency-AC current method

So Noguchi (Hokkaido Univ.)

Takanobu Mato (Hokkaido Univ.)

and SeokBeom Kim (Okayama Univ.)

Background

- The No-Insulation (NI) winding technique is one option for magnet protection.
- The turn-to-turn contact resistance is a key component to specify the magnet stability.
- Two methods have been proposed to measure the turn-to-turn contact resistance.
 - ✓ Sudden-discharge method
 - ✓ Low-frequency-AC current method

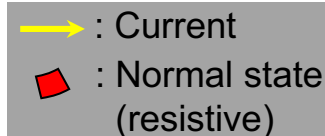
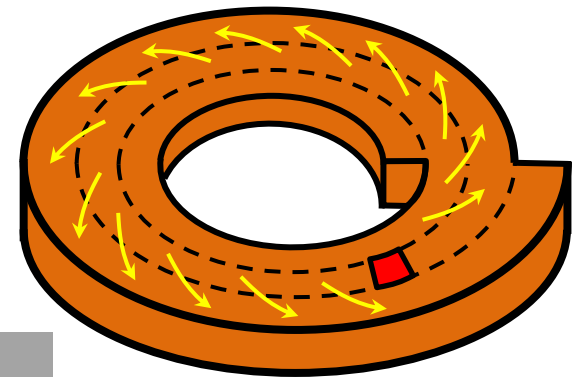

Sudden-Discharging Test

The coil inductance is derived from the time constant of field decay.

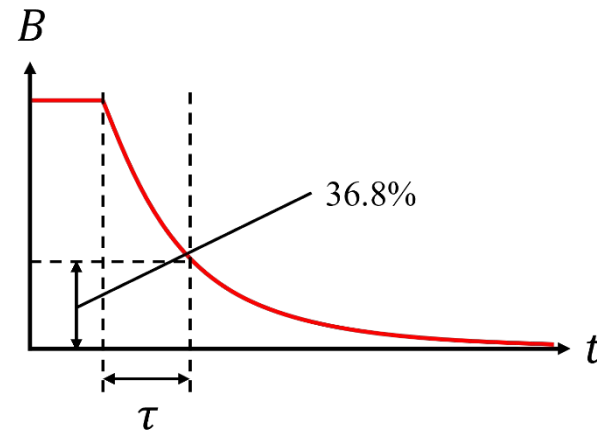
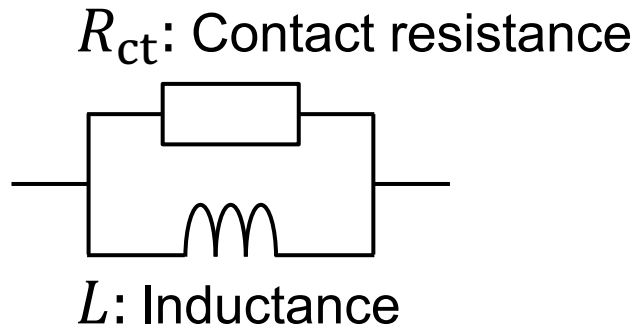

$$R_{ct} = \frac{L}{\tau}$$

R_{ct} : Contact resistance

τ : Time constant

L : Coil inductance

- Widely used
- Many examples

Low-Frequency-AC method [1]

The contact resistance is derived from the ratio of voltage and current by carrying ac current with adequate frequency.

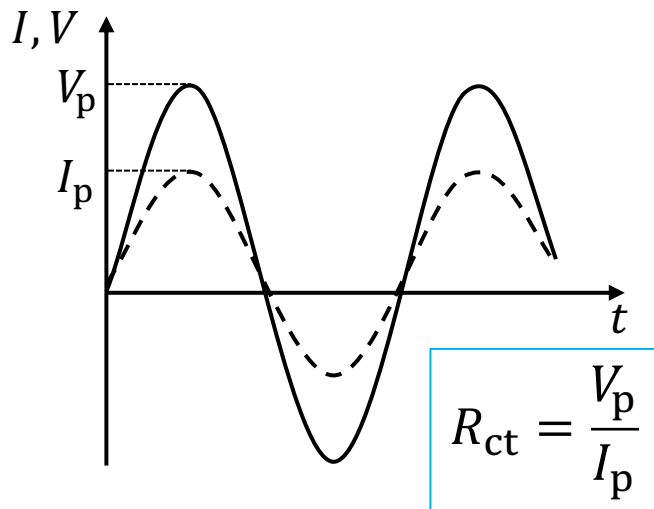

- Easy to measure
- Applicable to variable conditions

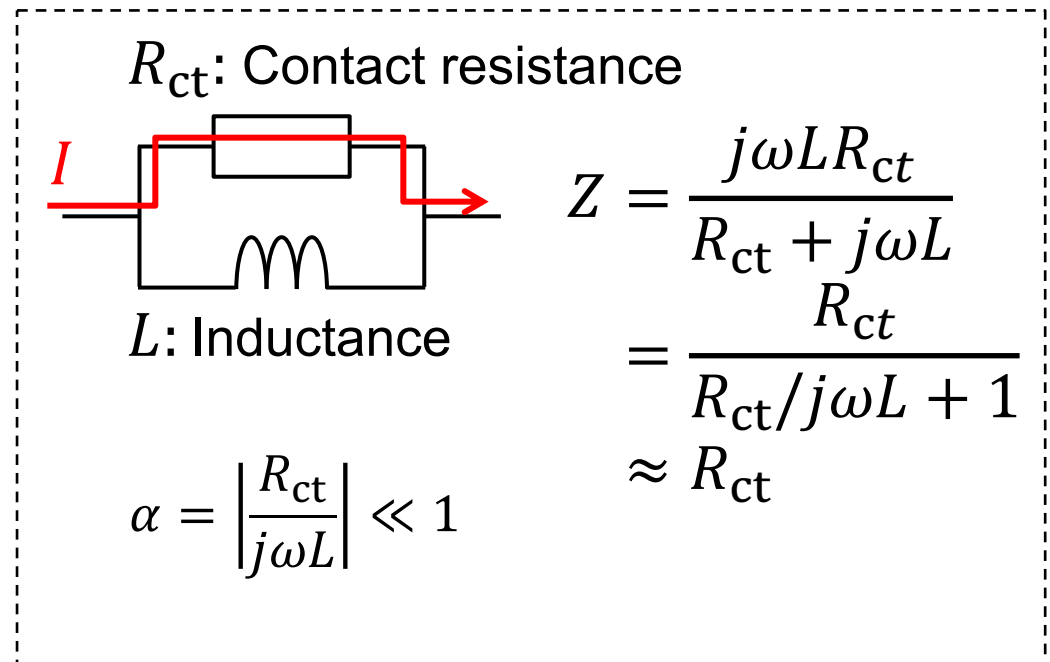

Measurement example of LFAC

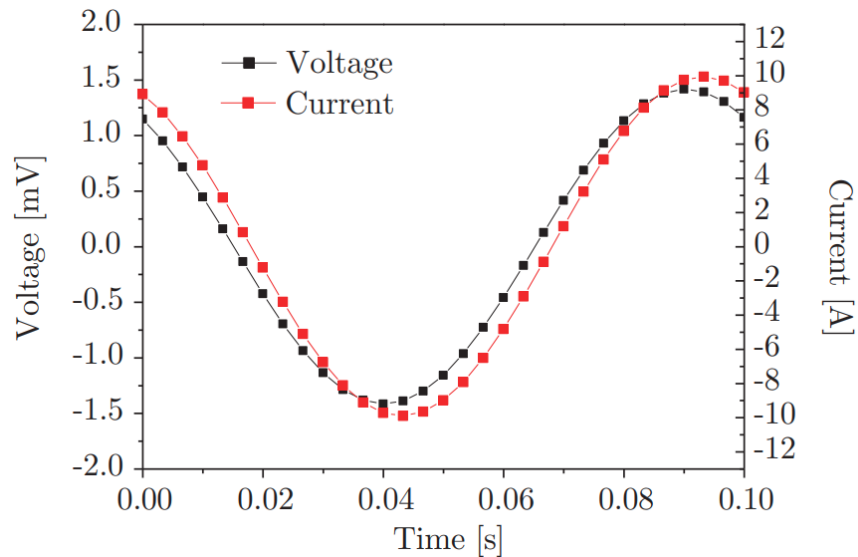

Frequency : 10 Hz

R_{ct} : 0.143 m Ω

ρ_{ct} : 122 $\mu\Omega \cdot \text{cm}^2$



Phase difference



Azimuthal current is non-zero?

Purpose

The current distribution is simulated in detail.

[2] S. Noguchi, *et al.*, "Turn-to-turn Contact Resistance Measurement of No-Insulation REBCO Pancake Coil at DC Current Operation," *IEEE Trans. Appl. Supercond.* 2020.

Current Distribution Simulation (2D-PEEC)

2D Partial Element Equivalent Circuit (PEEC) Model

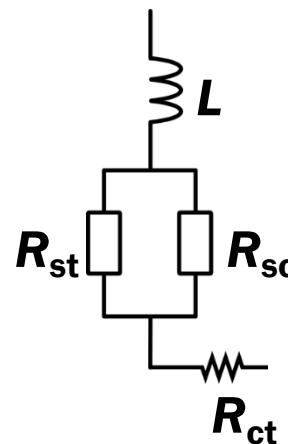
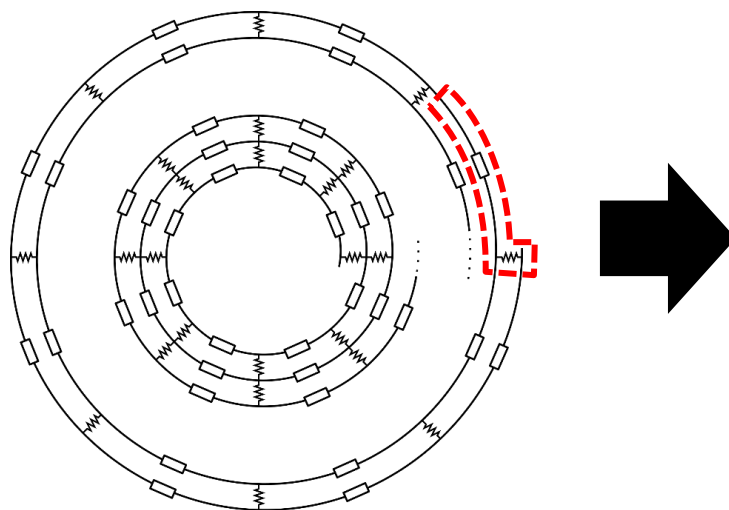

R_{ct} : Contact resistance
 R_{sc} : REBCO resistance
 R_{st} : Cu resistance
 L : Inductance

Parameters	Values
REBCO tape width [mm]	4.0
REBCO tape thickness [mm]	0.144
Critical current @ 77 K [A]	120
Coil i.d.; o.d.	60.0; 62.9
Turn [-]	10
Contact resistivity [$\mu\Omega \cdot \text{cm}^2$]	122 [2]
AC frequency [Hz]	10
AC amplitude [A]	10

$$R_{ct} = \sum_{i=1}^{N-1} \rho_{ct} \frac{1}{S_i}$$

N : # of turns
 ρ_{ct} : Contact resistivity
 S : Contact area

[2] S. Noguchi, *et al.*, "Turn-to-turn Contact Resistance Measurement of No-Insulation REBCO Pancake Coil at DC Current Operation," *IEEE Trans. Appl. Supercond.* 2020.

Simulation Results #1

Time: 0.0 ms

$$\rho_{ct} = 122 \mu\Omega \cdot \text{cm}^2$$

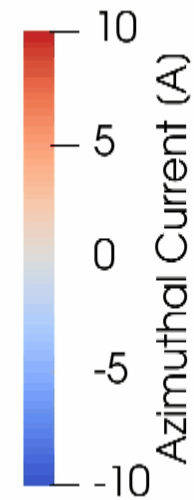
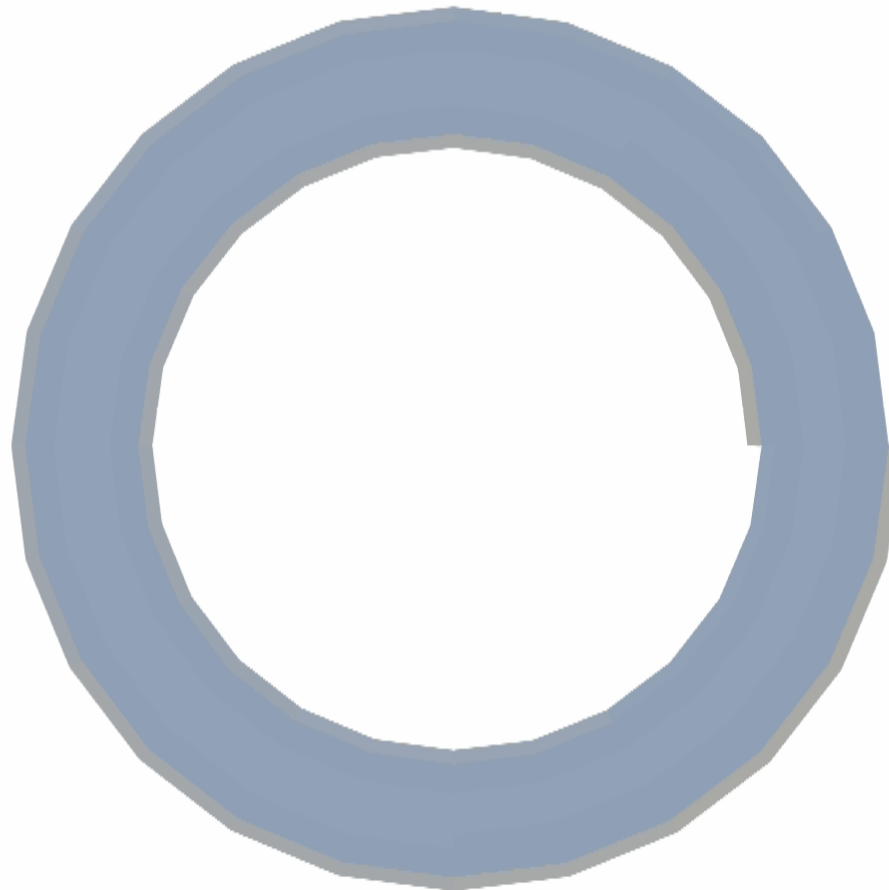

Azimuthal Current (A)

Azimuthal Current (A)

Azimuthal Current

Simulation Results #2

$$\rho_{ct} = 122 \mu\Omega \cdot \text{cm}^2$$

Time: 0.0 ms

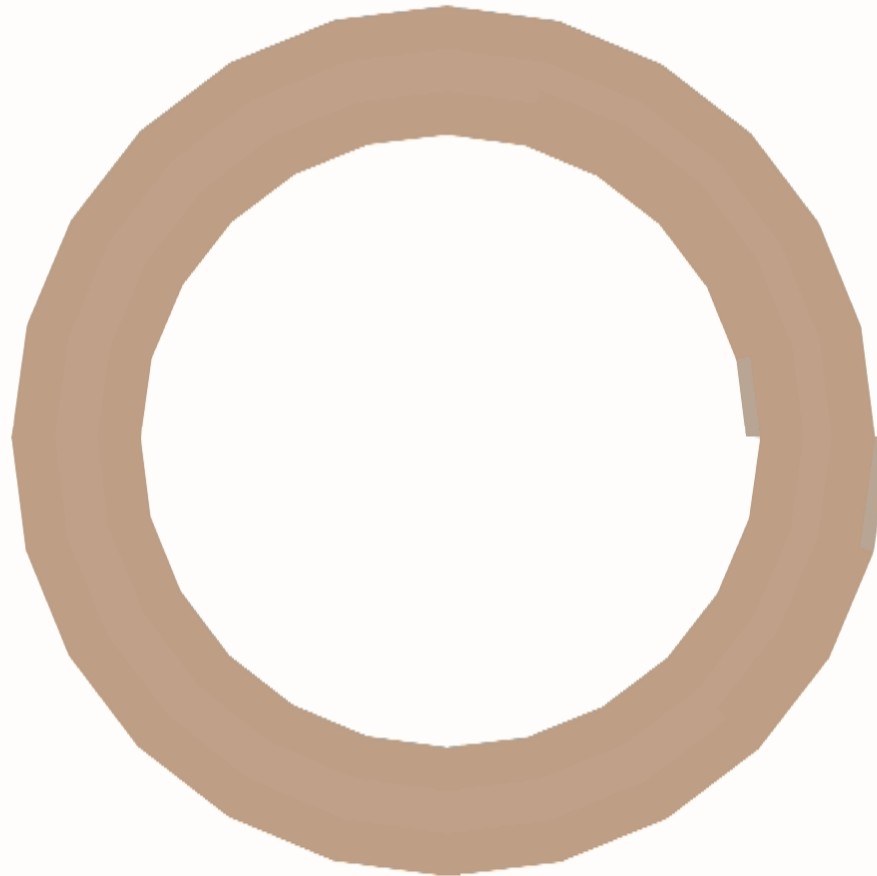

Radial Current

Radial Current (A)

Simulation Results #3

Azimuthal Current

$$\rho_{ct} = 122 \mu\Omega \cdot \text{cm}^2$$

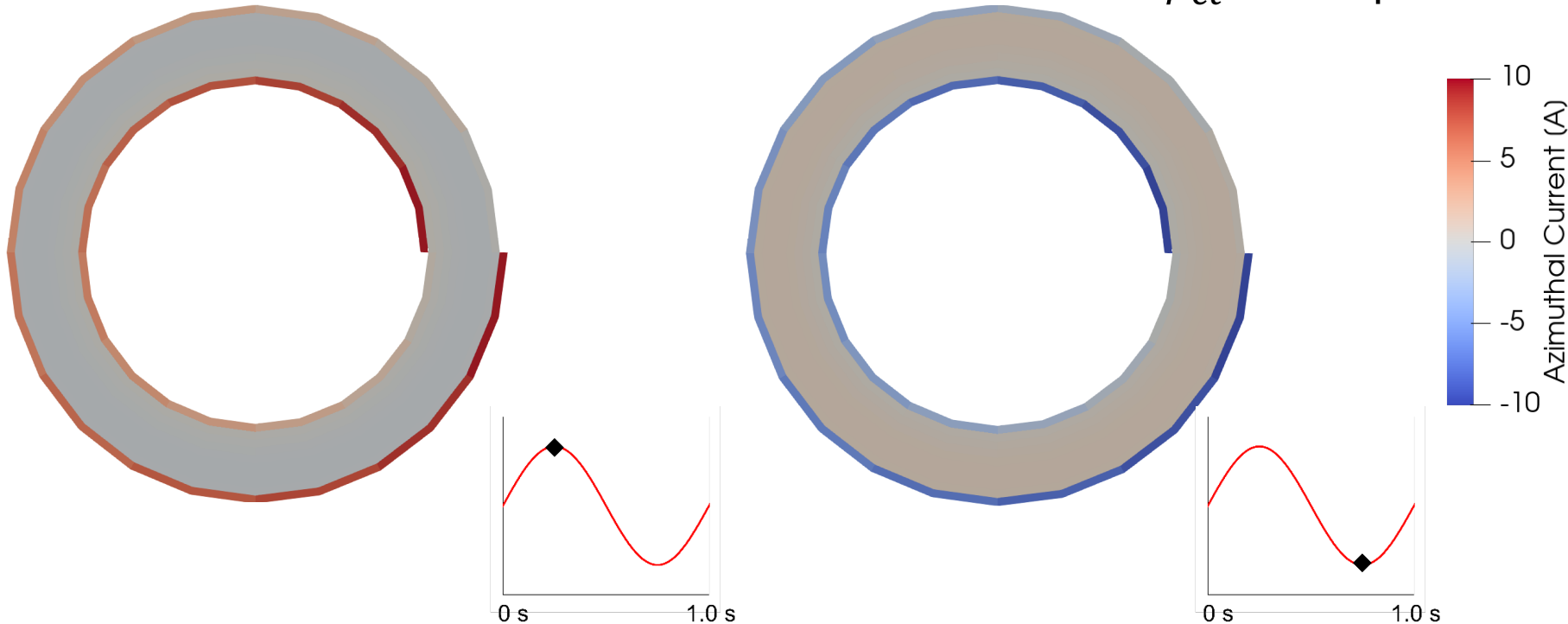

- Azimuthal current remains in innermost and outermost turns.
- Inductance should be considered \Rightarrow Phase difference

Simulation Results #4

Experiment[2]

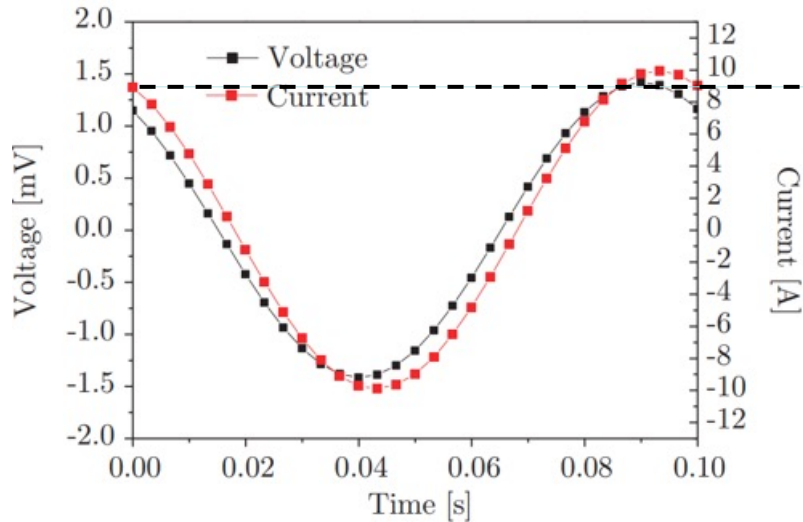

$$V_p = 14.26 \text{ mV}$$

$$\theta_{\text{diff}} = 10.8 \text{ deg}$$

Peak voltages are different.

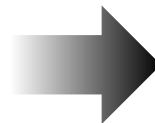

Simulation(122 $\mu\Omega \cdot \text{cm}^2$)

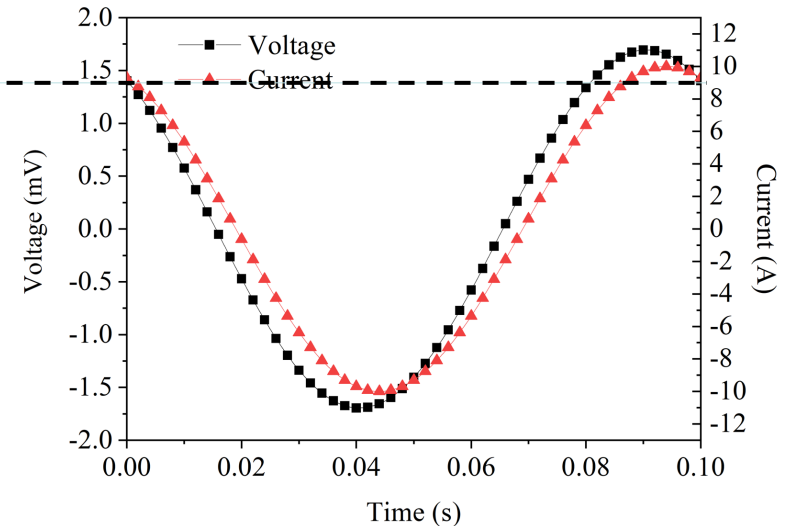

$$V_p = 16.94 \text{ mV}$$

$$\theta_{\text{diff}} = 12.6 \text{ deg}$$

Derived contact resistance is large?

[2] S. Noguchi, *et al.*, "Turn-to-turn Contact Resistance Measurement of No-Insulation REBCO Pancake Coil at DC Current Operation," *IEEE Trans. Appl. Supercond.* 2020.

Simulation Results #5

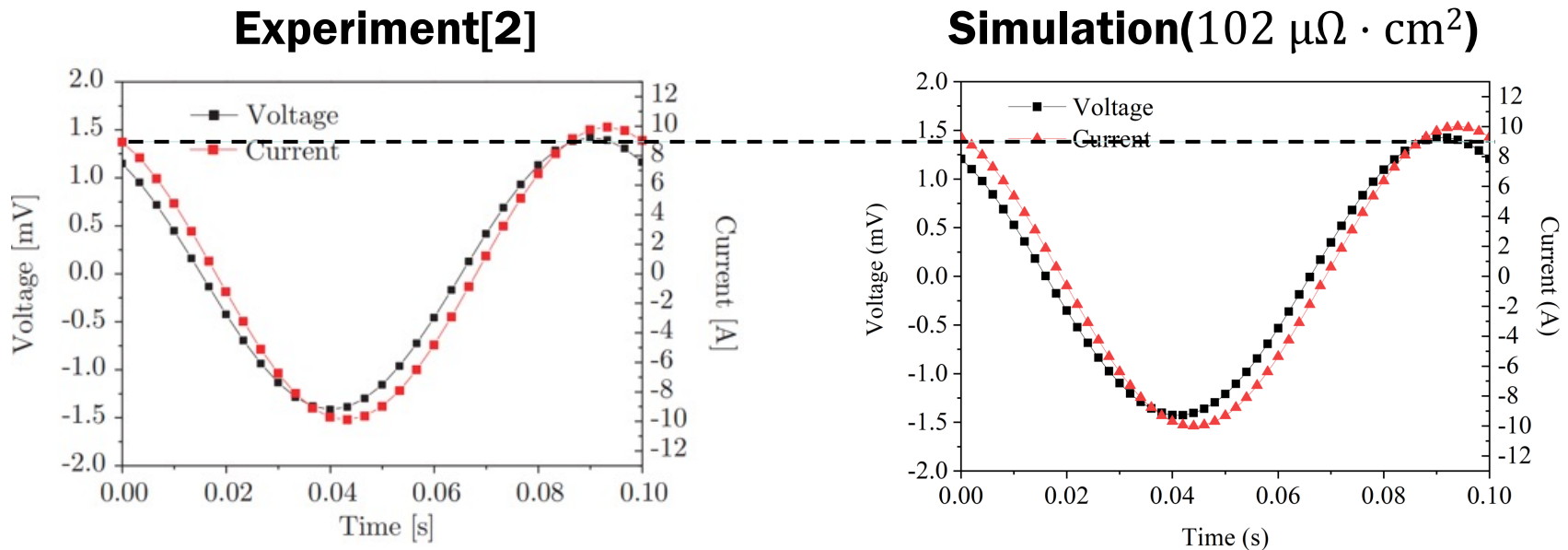

The resistivity of $102.0 \mu\Omega \cdot \text{cm}^2$ agrees well with measurement.

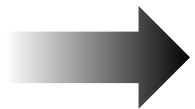

The simulated values is 80% of original LFAC method.

[2] S. Noguchi, *et al.*, "Turn-to-turn Contact Resistance Measurement of No-Insulation REBCO Pancake Coil at DC Current Operation," *IEEE Trans. Appl. Supercond.* 2020.

Simulation Results #6

(1) LFAC

Simulation ($102 \mu\Omega \cdot \text{cm}^2$)

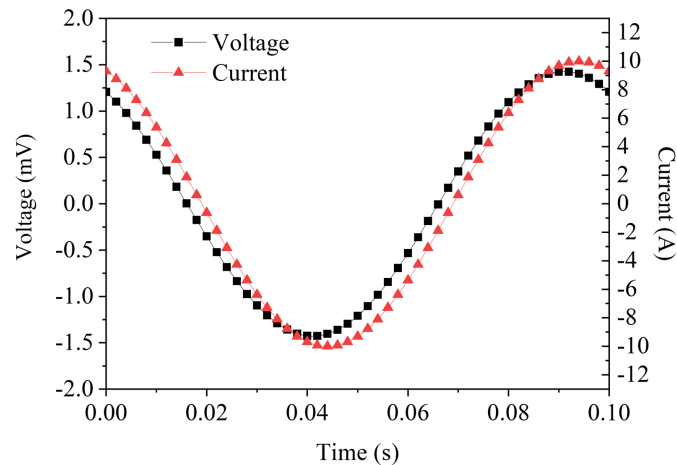

$$V_{\text{peak}} = 14.26 \text{ mV}$$

$$\theta_{\text{diff}} = 10.8 \text{ deg}$$

$$R_{\text{ct,LFAC}} = \text{Re}[Z] = 140.0 \mu\Omega$$

(2) Sudden Discharge

Simulation ($102 \mu\Omega \cdot \text{cm}^2$)

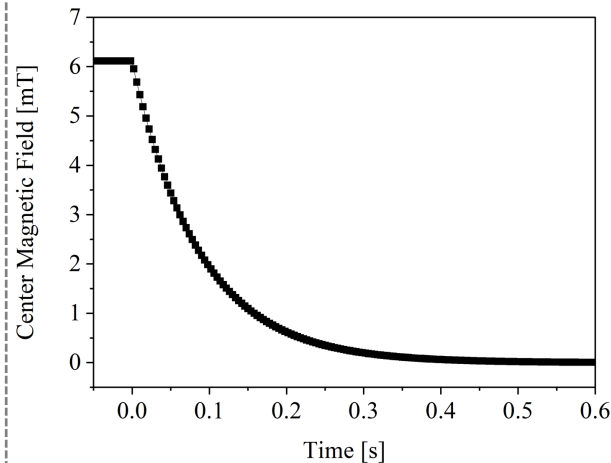

$$\text{Time constant } \tau = 88 \text{ ms}$$

$$R_{\text{ct,sd}} = 143.8 \mu\Omega$$

(3) Theory [3]

Calculation ($102 \mu\Omega \cdot \text{cm}^2$)

$$R_{\text{ct}} = \sum_{i=1}^{N-1} \rho_{\text{ct}} \frac{1}{S_i}$$

N : # of turns

ρ_{ct} : Contact resistivity

S : Contact area

$$R_{\text{ct,theory}} = 119.0 \mu\Omega$$

[3] X. Wang *et al.*, "Turn-to-Turn Contact Characteristics for An Equivalent Circuit Model of No-Insulation ReBCO Pancake Coil," *Supercond. Sci. Technol.*, 2013.

$$R_{\text{ct,LFAC}} \approx R_{\text{ct,sd}} > R_{\text{ct,theory}}$$

Current Distribution Simulation (3D-PEEC)

3D Partial Element Equivalent Circuit (PEEC) Model

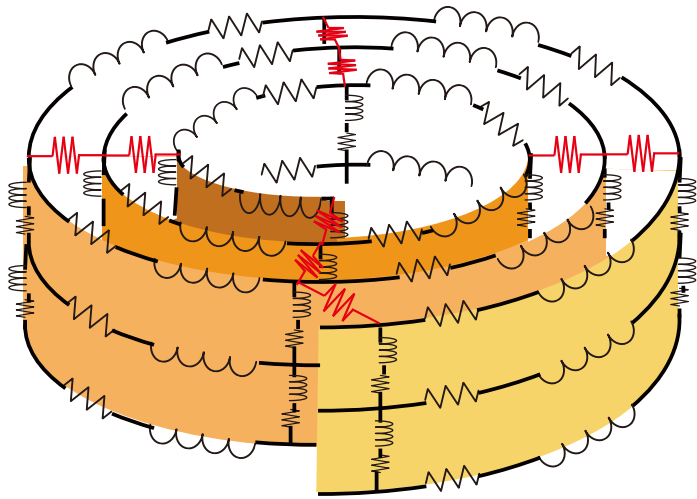

Enlargement view

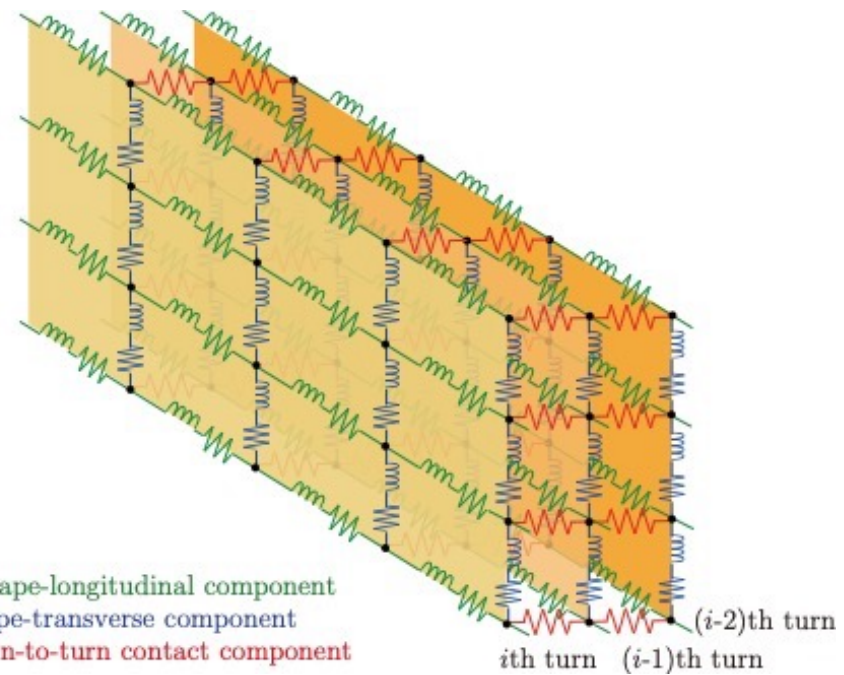

Green: tape-longitudinal component

Blue: tape-transverse component

Red: turn-to-turn contact component

Simulation Results #7

3D Partial Element Equivalent Circuit (PEEC) Model

Time: 0.000 s

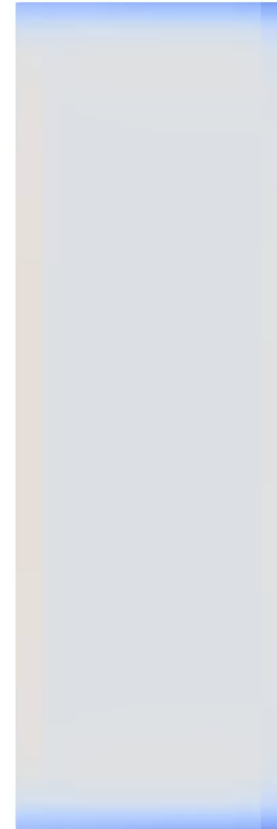
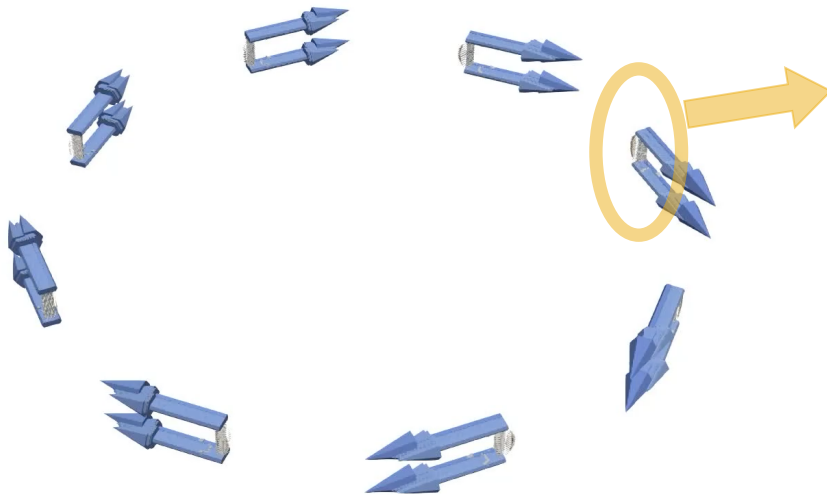

Azimuthal current
on cross section

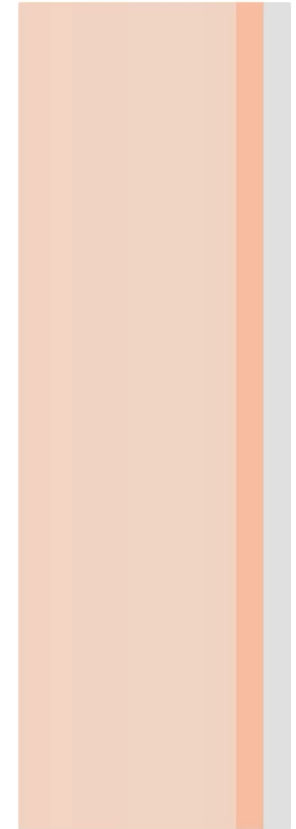

Radial current
on cross section

Simulation Results #8

2D Simulation ($102 \mu\Omega \cdot \text{cm}^2$)

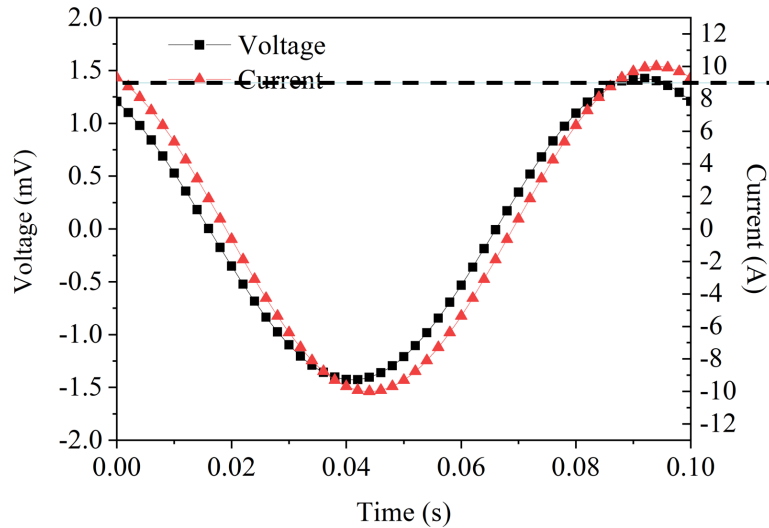

3D Simulation ($102 \mu\Omega \cdot \text{cm}^2$)

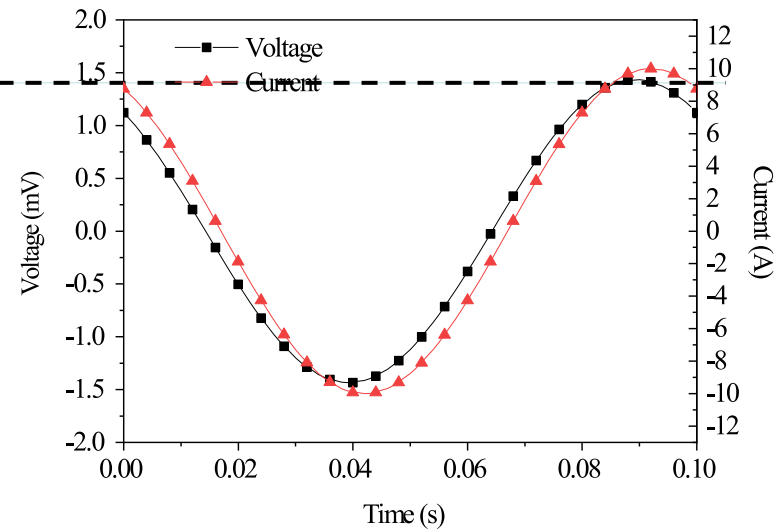

The 3D simulation also agrees well with 2D one and measurement.

Conclusion

- Turn-to-turn contact resistance can be measured:
 - ✓ by sudden-discharging method
 - ✓ by low-frequency-ac current (LFAC) method
- Due to complicated current paths, theoretical relation between contact resistance and resistivity is not hold.

$$R_{ct} = \sum_{i=1}^{N-1} \rho_{ct} \frac{1}{S_i}$$

- Detailed simulation is preferred for estimation of accurate contact resistance.

Thank you for attention!