



8th International Workshop on Numerical Modelling of High Temperature Superconductors
14th – 16th June 2022, Nancy, France

POLYTECHNIQUE
MONTREAL

TECHNOLOGICAL
UNIVERSITY



A physics-guided recurrent data-driven model for long-time prediction of nonlinear partial differential equations

J.-H. Fournier-Lupien, **F. Sirois**, C. Lacroix
(Collaborators from NRC: J. Valdes and A. Chagang)

Polytechnique Montréal, Montréal, Canada

June 14th 2022



National Research
Council Canada

Conseil national de
recherches Canada

Numerical simulation of quench in HTS tapes

Blue = superconducting
Red = quenched ($T > T_c$)

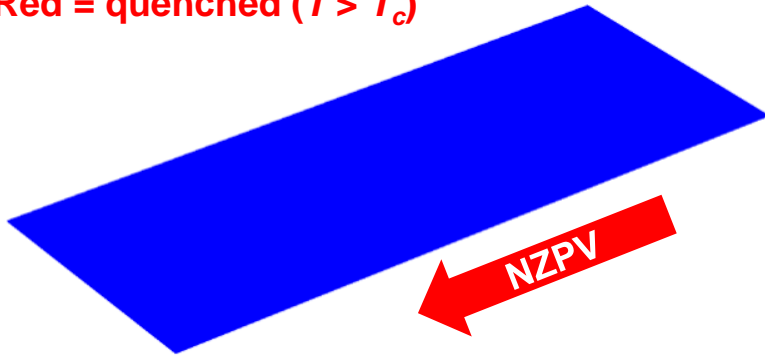

NZPV = Normal zone propagation velocity

- Electro-thermal simulation
- Nonlinear E-J characteristic
- Full 3D mesh

Problem with finite element simulations:

- Computationally expensive
- Impossible to simulate tape $>$ few cm
- Need to variations of I_c along tape length, i.e. $I_c = f(x)$

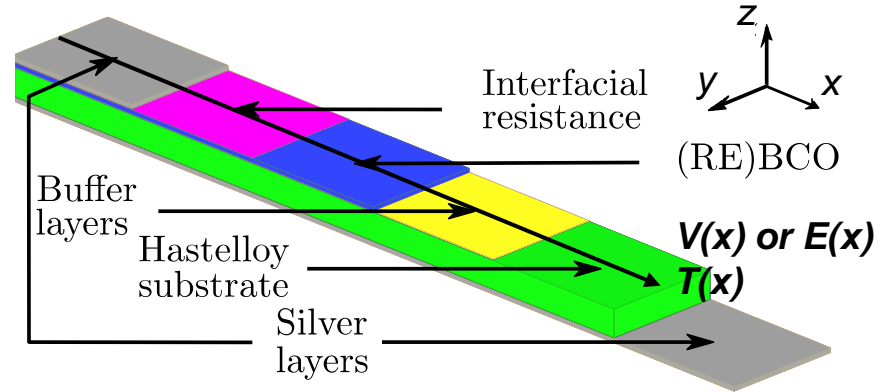

Physics is 3-D, but output is typically 1-D



Surrogate model to substitute an expensive FEM solver

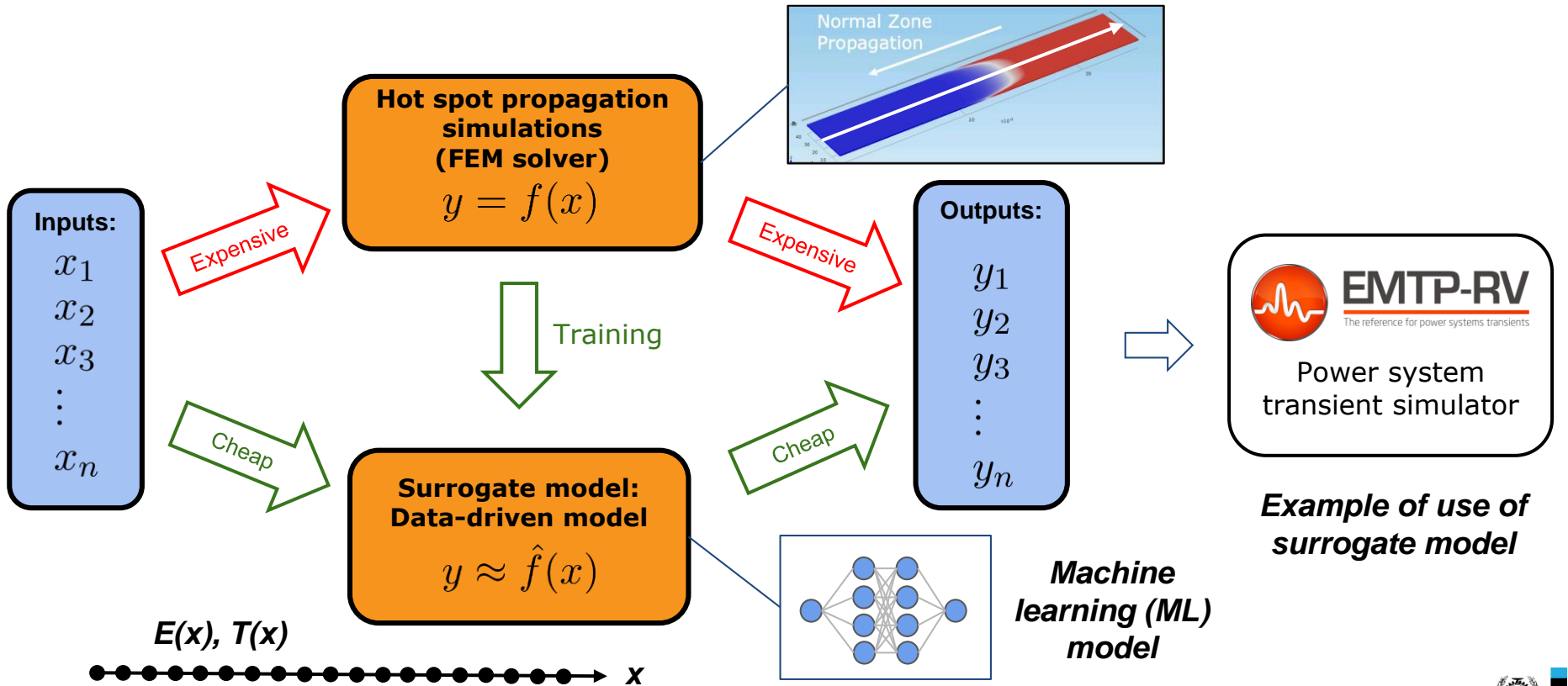

Physics modeling versus Data-Driven modeling

Physics
(Purely theory based)

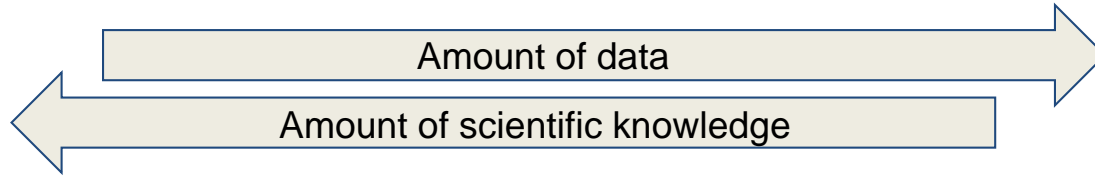

Data
(Purely data based)

No data
regime

Numerical techniques such as Finite Element Method

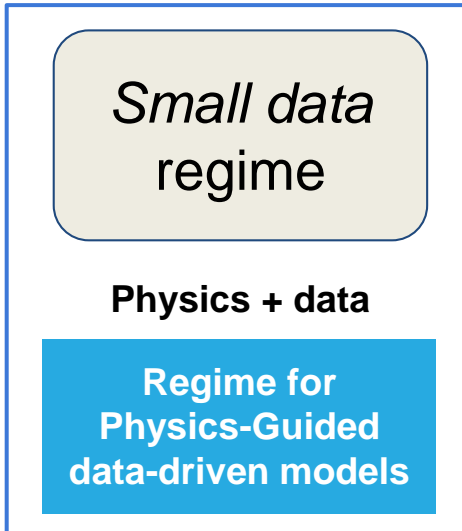

Big data
regime

**Machine learning techniques
Deep learning**



Physics and things to take into account with ML model

Problem to solve:

Very nonlinear

$$\text{Current continuity equation: } \nabla \cdot (-\sigma(T)\nabla V) = 0$$

⇒ Solved for **electric field** $E = \text{grad}(V)$

$$\text{Heat equation: } \rho_m C_p(T) \frac{\partial T}{\partial t} + \nabla \cdot (-k(T)\nabla T) = Q$$

⇒ Solved for **temperature** T

Multi-material Time-dependent Multi-material External time-dependent variable

Challenges:

- 1) Nonlinear electric and heat equations
- 2) Multi-materials geometry
- 3) Time dependence must be solved one step at a time in a recursive manner

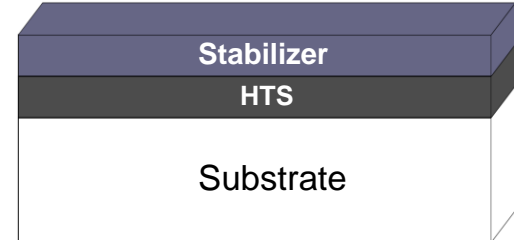

Decoupling of the electric and the thermal problems

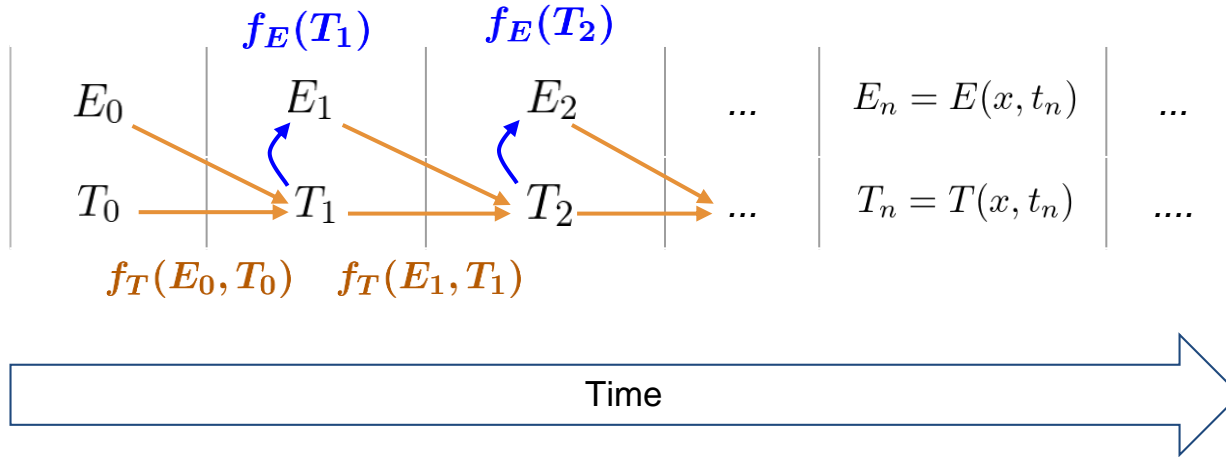

f_E : Electric problem

f_T : Thermal problem

The problem can be reduced to finding a good model for f_T



Training of the electric problem

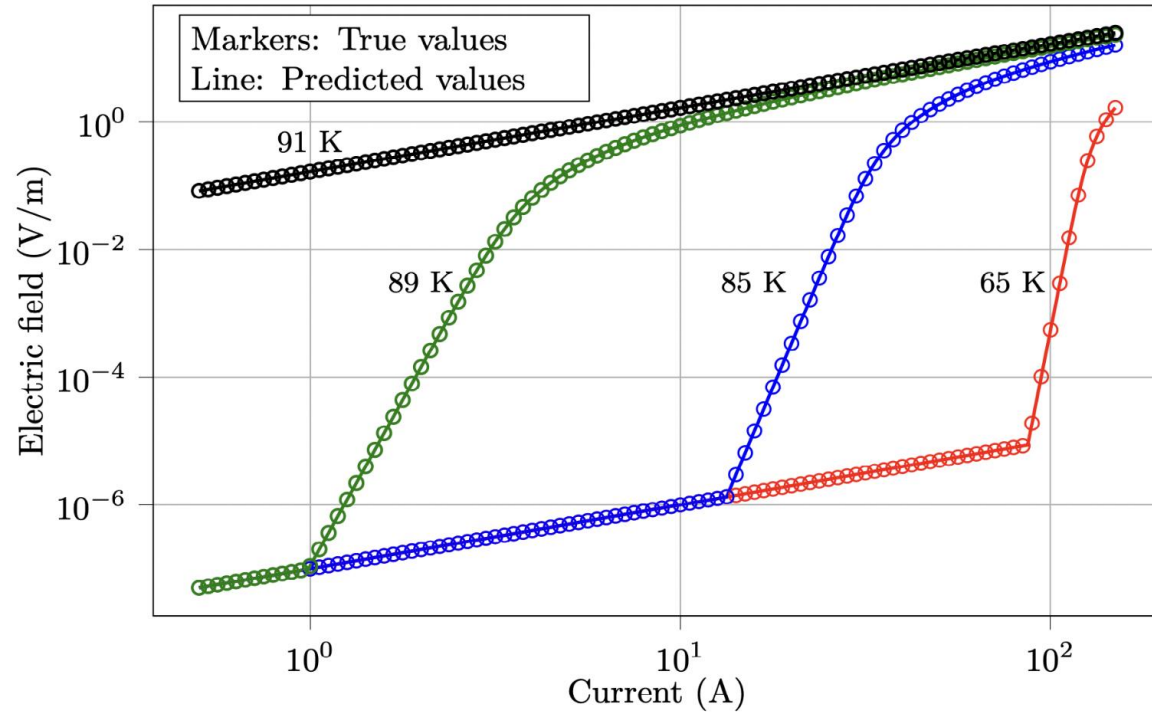

- Fitted on 3D simulations of quench propagation
- NN architecture: [4,10,1]
- 40 simulations
- 360,000 datapoints

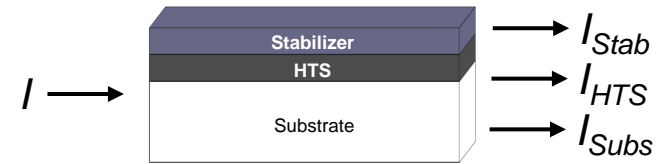

$$\Delta x \rightarrow E = \Delta V / \Delta x$$

$$\hat{E} = \boxed{f_E}(I, I_c, T)$$

Neural network



Training of the thermal problem

Physics-Guided Recurrent Data-Driven model (PGRDD)

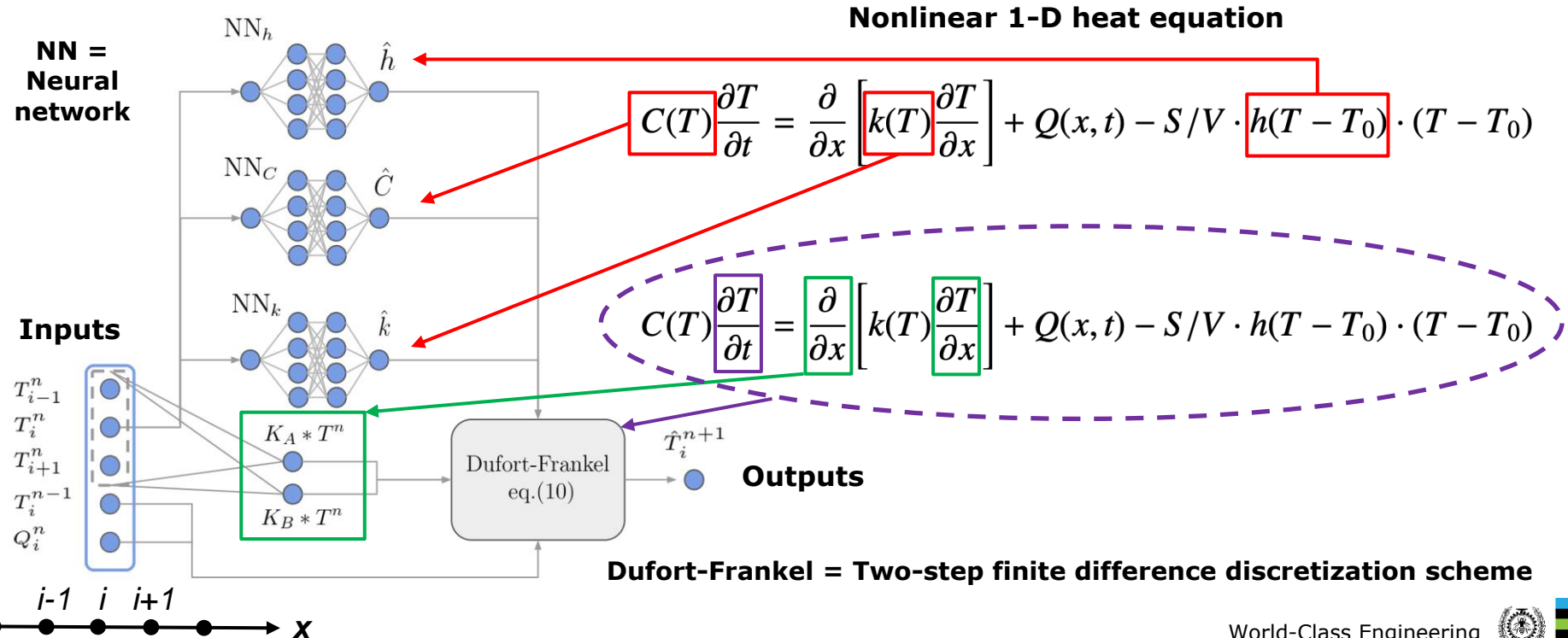

Training for the thermal problem

Physics-Guided Recurrent Data-Driven model (PGRDD)

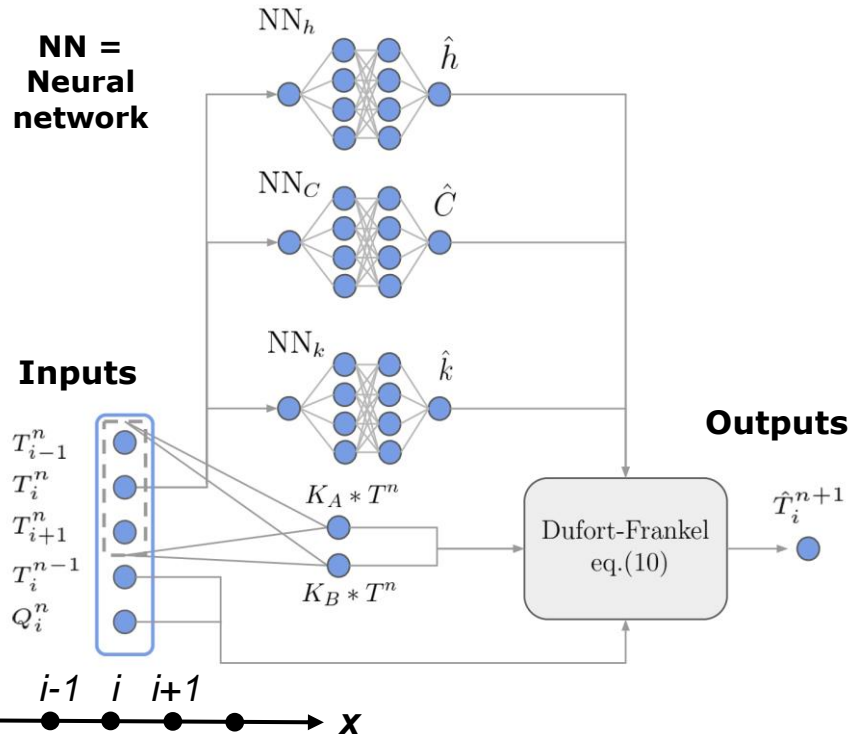

Training on recurrent predictions

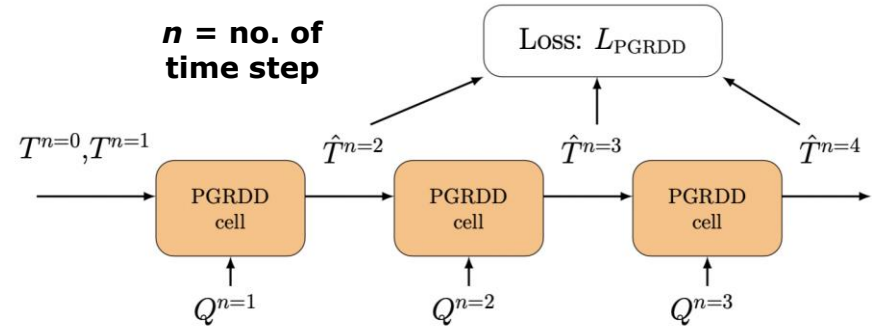

- Material properties = Neural Networks (NN)
 - Data-driven model with physical constraints (finite difference scheme built-in) trained on recursive predictions
- **Physics guided recurrent data-driven model**



Data set used to train the thermal problem

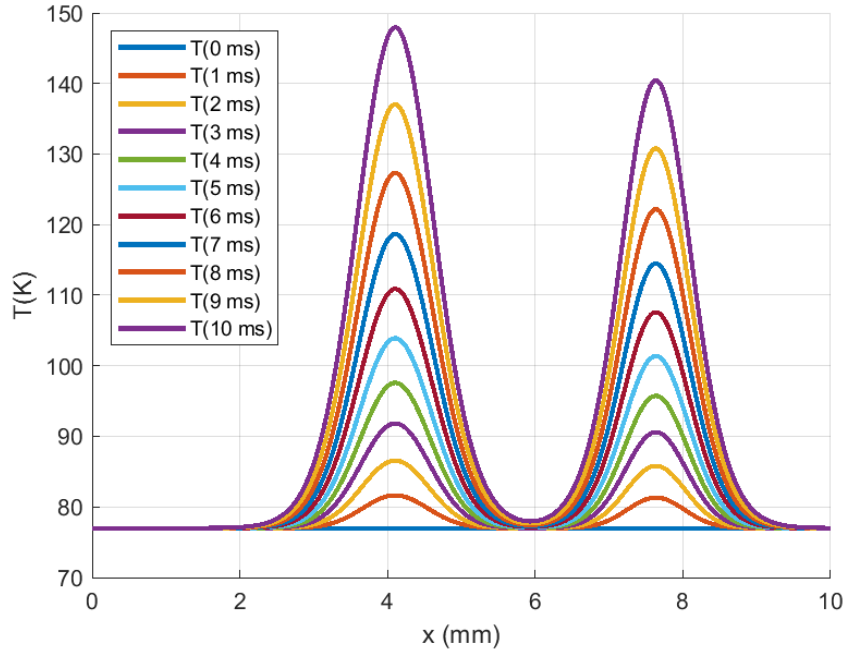

Example of a 1-D FEM solution

Nonlinear 1-D heat equation solved by FEM:

$$C(T) \frac{\partial T}{\partial t} = \frac{\partial}{\partial x} \left[k(T) \frac{\partial T}{\partial x} \right] + \underbrace{Q(x, t)} - S/V \cdot h(T - T_0) \cdot (T - T_0)$$
$$Q(x, t) = e^{t/\tau} \cdot \left[Q_1 e^{-\left(\frac{x-x_1}{2\sigma_1}\right)^2} + Q_2 e^{-\left(\frac{x-x_2}{2\sigma_2}\right)^2} \right]$$

*Randomly generated parameters

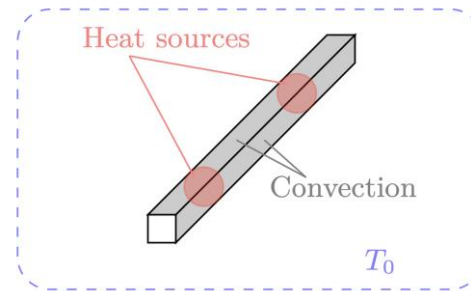

Data set:
- 100 Simulations
- 1,000,000 datapoints
- 5 predictors, 1 target



Accurate predictions for different level of complexity

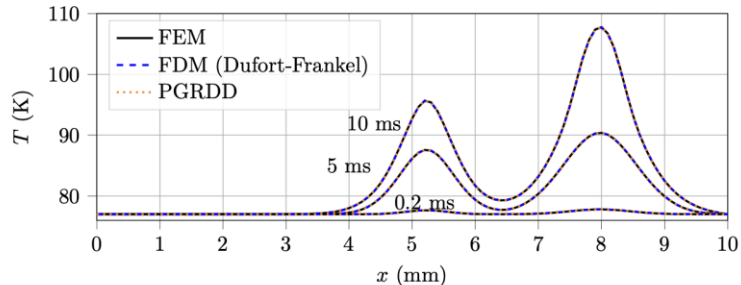
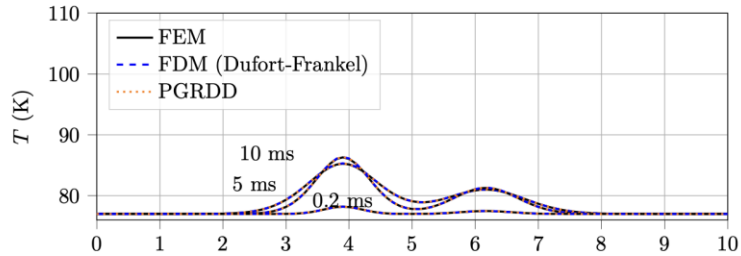
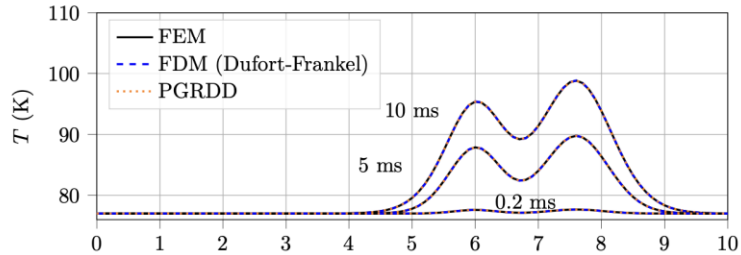

Equation	Heat source
----------	-------------

$$C(T) \frac{\partial T}{\partial t} = \frac{\partial}{\partial x} \left[k(T) \frac{\partial T}{\partial x} \right] + Q(x)$$

$$Q_1 e^{-\left(\frac{x-x_1}{2\sigma_1}\right)^2} + Q_2 e^{-\left(\frac{x-x_2}{2\sigma_2}\right)^2}$$

Complexity 1

$$C(T) \frac{\partial T}{\partial t} = \frac{\partial}{\partial x} \left[k(T) \frac{\partial T}{\partial x} \right] + Q(x, t)$$

$$e^{t/\tau} \cdot \left(Q_1 e^{-\left(\frac{x-x_1}{2\sigma_1}\right)^2} + Q_2 e^{-\left(\frac{x-x_2}{2\sigma_2}\right)^2} \right)$$

Complexity 2

$$C(T) \frac{\partial T}{\partial t} = \frac{\partial}{\partial x} \left[k(T) \frac{\partial T}{\partial x} \right] + Q(x, t)$$

$$e^{t/\tau} \cdot \left(Q_1 e^{-\left(\frac{x-x_1}{2\sigma_1}\right)^2} + Q_2 e^{-\left(\frac{x-x_2}{2\sigma_2}\right)^2} \right)$$

Complexity 3

$$-S/V \cdot h(T - T_0) \cdot (T - T_0)$$



Minimization of the error accumulation

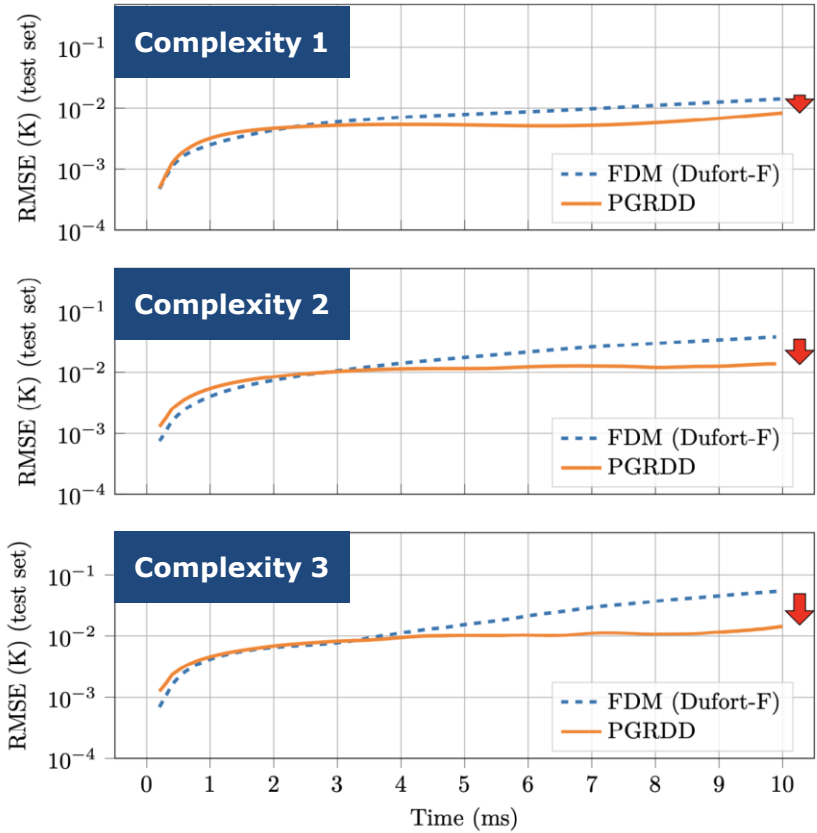

- Minimization of error accumulation
- Accurate long-time predictions
- General for any initial states and heat sources
- Prediction takes ~1.6 seconds (whereas a single 3-D simulations takes 25 minutes!)

***RMSE: error compared to FEM solution**

Generalization of the model to 3D effects

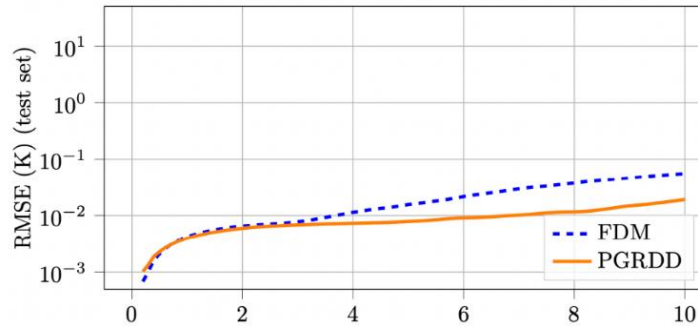
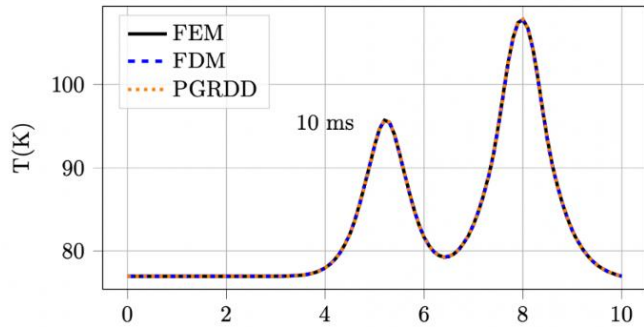

1-D simulations
(Complexity 3)

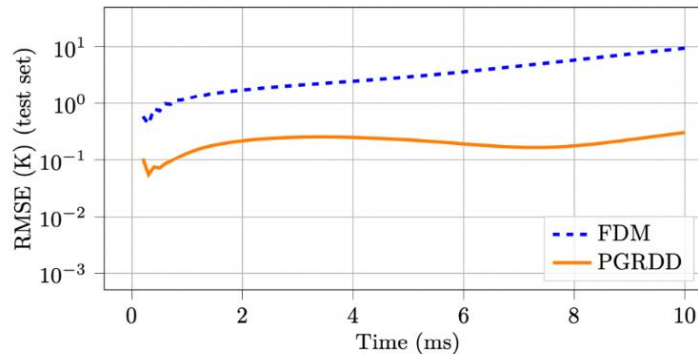
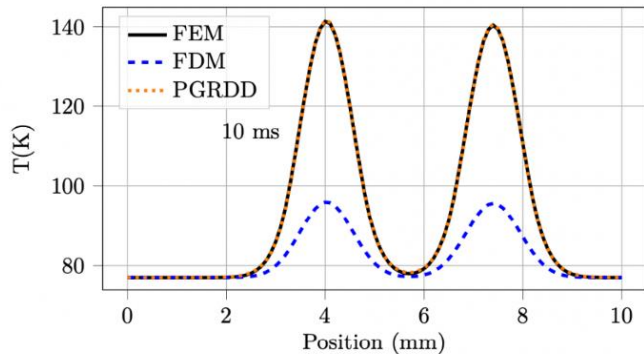
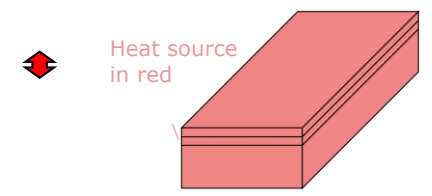

3-D simulations
(Complexity 3)

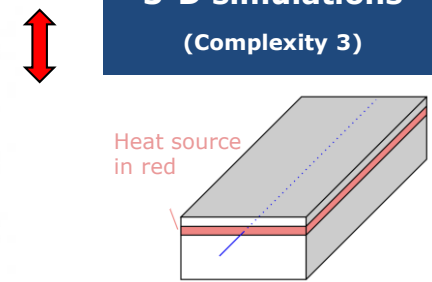

ML model is general enough to include 3D effects in 1-D model!



Material properties can be extracted from data

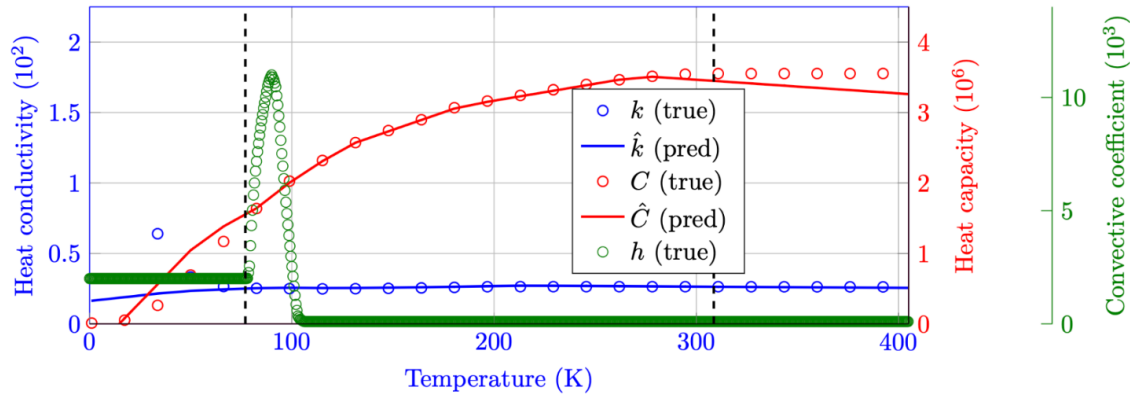

1-D simulations
(Complexity 3)

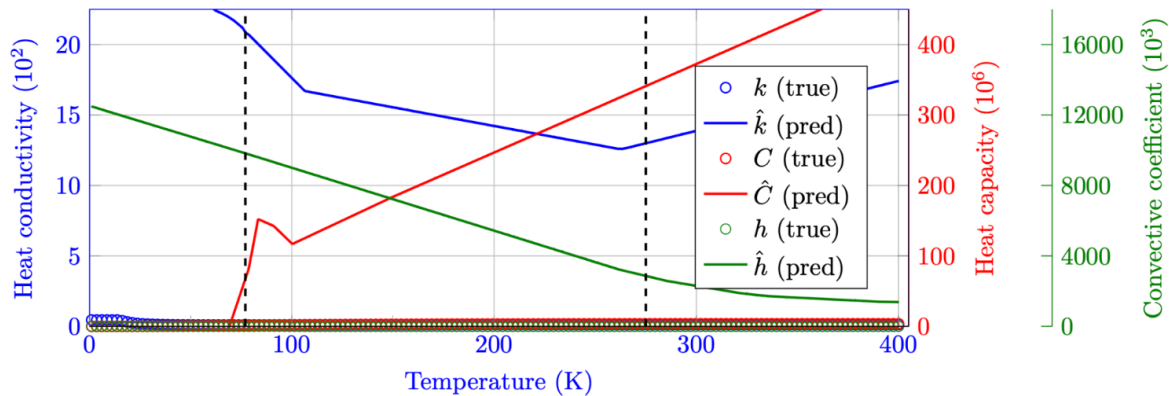

3-D simulations
(Complexity 3)



Conclusion

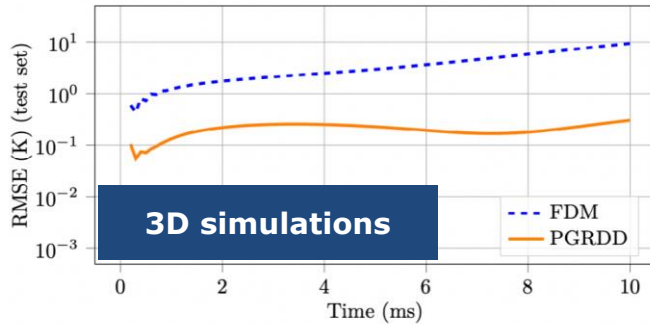
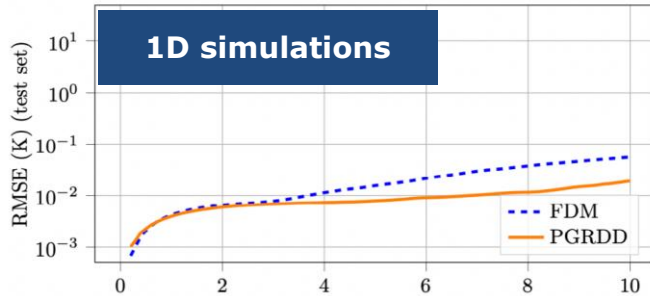

- Data-driven modeling is promising to develop surrogate models for 3-D quench propagation simulations in HTS tapes
- It minimizes error accumulation caused by the recurrence of the scheme
- Surrogate model: general for any initial state and heat source (no need for re-training)
- 3D simulations takes ~25 min
Surrogate model takes **~1.6 second**
(~75 min training)

