



HAL
open science

LPV-Fuzzy control approach for road adaptive semi-active suspension system

Hakan Basargan, Andras Mihaly, Peter Gaspar, Olivier Sename

► To cite this version:

Hakan Basargan, Andras Mihaly, Peter Gaspar, Olivier Sename. LPV-Fuzzy control approach for road adaptive semi-active suspension system. IV 2022 - 33rd IEEE Intelligent Vehicles Symposium (IV 2022), Jun 2022, Aachen, Germany. pp.779-784, 10.1109/IV51971.2022.9827195 . hal-03790380

HAL Id: hal-03790380

<https://hal.science/hal-03790380v1>

Submitted on 28 Sep 2022

HAL is a multi-disciplinary open access archive for the deposit and dissemination of scientific research documents, whether they are published or not. The documents may come from teaching and research institutions in France or abroad, or from public or private research centers.

L'archive ouverte pluridisciplinaire **HAL**, est destinée au dépôt et à la diffusion de documents scientifiques de niveau recherche, publiés ou non, émanant des établissements d'enseignement et de recherche français ou étrangers, des laboratoires publics ou privés.

LPV-Fuzzy control approach for road adaptive semi-active suspension system

Hakan Basargan and András Mihály and Péter Gáspár and Oliver Sename

Abstract—This study introduced a road adaptive semi-active suspension control method, where a trade-off between vehicle stability and driving comfort is accomplishable in order to achieve desirable performance results at different road irregularities and velocities by modifying the scheduling variable that is designed by Fuzzy Logic Control. The introduced semi-active controller is founded on the Linear Parameter-Varying framework. Hungarian highway route data has been implemented to the TruckSim environment based on real geographical data having road irregularities in order to compare the proposed adaptive method with a non-adaptive scenario. Simulation results show that driving comfort, vehicle stability, and road-holding performances have been improved with the proposed method.

I. INTRODUCTION

There are numerous criteria that road vehicles must be met. Vehicle stability and driving comfort are two of the most important criteria for road vehicles. The vehicle suspension system is one of the critical topics on vehicle technology due to its essential role in vehicle safety, stability, ride comfort, and overall vehicle performance, while the trade-off between these performances is possible with an online reconfigurable controller.

There are a large number of publications where the development of the semi-active suspension system based on the control-oriented quarter-car model has been studied with different control approaches and techniques. A Skyhook control is commonly used, the linear-quadratic(LQ) control also has been used in order to improve performances, the model predictive control (MPC) method is also widely used, and H_∞ method also has been preferred in semi-active suspension control problems. All these control methods are

H. Basargan is with the BME Department of Control for Transportation and Vehicle Systems, Stoczek u. 2, H-1111 Budapest, Hungary. E-mail: hakan.basargan@kjk.bme.hu

A. Mihály and P. Gáspár are with Systems and Control Laboratory, Institute for Computer Science and Control, Hungarian Academy of Sciences, Kende utca 13-17, 1111, Budapest, Hungary. E-mail: [mihaly.andras; gaspar.peter]@sztaki.mta.hu

Oliver Sename is with GIPSA-lab, INPG, Université Grenoble Alpes 38402, 11 Rue des Mathématiques, Grenoble, France E-mail: Olivier.Sename@grenoble-inp.fr

The research presented in this paper, carried out by Institute for Computer Science and Control was supported by the Ministry for Innovation and Technology and the National Research, Development and Innovation Office within the framework of the National Lab for Autonomous Systems. This paper was partially supported by the National Research, Development and Innovation Office through the project 'Integration of velocity and suspension control to enhance automated driving comfort in road vehicles' (NKFIH 2018-2.1.13-TÉT-FR). The research was partially supported by the Hungarian Government and cofinanced by the European Social Fund through the project "Talent management in autonomous vehicle control technologies" (EFOP-3.6.3-VEKOP- 16-2017-00001).

useful; while Skyhook disturbs the dynamic tire load, LQ requires the full state measurement or estimation, MPC lacks robustness properties, and reconfiguration is not possible with H_∞ . The online reconfigurable control method is needed to behave differently for each road's irregularities, velocity, and different external factors. Thus, the semi-active suspension control is founded on the Linear Parameter Varying (LPV) framework, as already introduced in [1], [2], where the online reconfiguration is accomplishable.

This paper proposes an adaptive reconfigurable semi-active suspension control method where the trade-off between driving comfort and vehicle stability performances is possible. This trade-off is accomplishable due to flexibility and online reconfigurability of the LPV control method by scheduling variable, where the design is based on the Fuzzy Logic Control (FLC) method.

The paper is organized as follows: Section II presents LPV control synthesis and modeling of the control-oriented quarter-car suspension. Section III introduces scheduling variable design with FLC method and system integration. Section IV demonstrates the operation of the proposed method in TruckSim simulation environment with real road data. Finally, concluding remarks are presented in Section V.

II. MODELING AND CONTROL SYNTHESIS OF THE SYSTEM

This section introduces modeling of the control-oriented quarter-car suspension and reconfigurable semi-active suspension control design through the LPV method. The control-oriented formulation of the quarter-car suspension model along with the design of the reconfigurable semi-active controller using the LPV framework is detailed. The control design procedure has already been presented in [2], which is the basis of the design in the paper.

The well known quarter-car model is depicted in Figure 1. The advantage of this model is its simplicity having two degrees-of-freedom, namely the sprung and unsprung mass displacements. Dynamics of the semi-active suspension and the actuator is described in (1) and (2) as follows:

$$\begin{aligned} m_s \ddot{z}_s + b_s (\dot{z}_s - \dot{z}_{us}) + k_s (z_s - z_{us}) + F_{mr} &= 0 \\ m_u \ddot{z}_{us} + b_s (\dot{z}_{us} - \dot{z}_s) + k_s (z_{us} - z_r) + & \\ k_s (z_{us} - z_s) - F_{mr} &= 0 \end{aligned} \quad (1)$$

$$\dot{F}_{mr} = -\frac{1}{\tau} F_{mr} + \frac{1}{\tau} u. \quad (2)$$

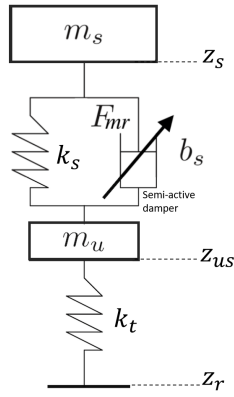

Fig. 1. Control-oriented quarter-car model

where m_s and m_u are the sprung and unsprung masses, k_t and k_s are the tire and spring vertical stiffness, b_s is the shock absorber damping rate, F_{mr} is the generated control force of the actuator, while $u = F$ is the control input with an actuator delay time τ . Vertical displacement of the sprung and unsprung masses are described with z_s and z_{us} , while w stands for the road disturbance derived from road irregularities. Parameters of the quarter-car model with the selected simulation vehicle are depicted in Table I.

TABLE I
PARAMETERS OF THE SUSPENSION

Parameters (symbols)	Front suspension	Rear suspension	Unit
sprung mass (m_s)	214	336	kg
unsprung mass (m_u)	40	40	kg
suspension stiffness (k_s)	30	60	kN/m
tire stiffness (k_t)	220	220	kN/m
damping (b_s)	50	50	N/m/s
time constant (τ)	0.01	0.01	s

During the control design, the state vector of the suspension system is chosen as $x = [x_1 \ x_2 \ x_3 \ x_4 \ x_5]^T$, where $x_1 = z_s$, $x_2 = z_{us}$, $x_3 = \dot{z}_s$, $x_4 = \dot{z}_{us}$, $x_5 = F_{mr}$.

The unmodelled dynamics formulated in Δ ($\|\Delta\|_\infty < 1$) are described with $|\Delta(\omega_1)| = 0.25$ at low frequencies and $|\Delta(\omega_2)| = 1$ at high frequencies.

Next, performance specifications are defined in order to achieve an appropriate trade-off between ride comfort and road holding, while control force must also be minimized. Performance criterion z_1 ($z_1 = \ddot{z}_s \rightarrow 0$) is defined to minimize vertical acceleration of sprung mass in order to enhance passenger comfort. Performance criterion z_2 ($z_2 = (z_s - z_{us}) \rightarrow 0$) ensures the minimization of suspension deflection, which stands for the roll and pitch stability of the vehicle. Performance criterion z_3 ($z_3 = (z_{us} - w) \rightarrow 0$) guarantees the minimization of the tire deformation, which enhances the road holding of the vehicle. With the control force criterion of $z_4 = F \rightarrow 0$, all the performances are put in a performance vector $z = [z_1 \ z_2 \ z_3 \ z_4]^T$.

Next, the suspension system described in (1) is converted into the state-space representation form given in (3), where

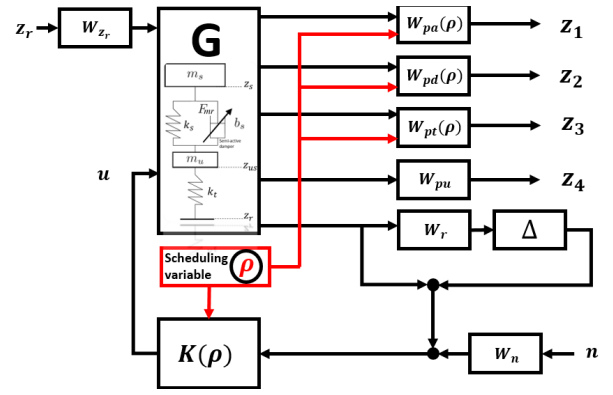

Fig. 2. Closed-loop interconnection structure

$A, B_{1,2}, C_{1,2}$ and $D_{11,12,21,22}$ are the system matrices.

$$\begin{aligned} \dot{x} &= Ax + B_1w + B_2u \\ z &= C_1x + D_{11}w + D_{12}u \\ y &= C_2x + D_{21}w + D_{22}u \end{aligned} \quad (3)$$

The proposed high-level controller is founded on a weighting strategy formulated through a closed-loop architecture shown in Figure 2. Here, G is the quarter-car control oriented model defined in (3), K is the designed Linear Parameter Varying (LPV) controller characterized with the scheduling variable ρ responsible for control reconfiguration, u is the control input of the actuator, y is the measured output, n is the measurement noise, z represents the performance outputs and w stands for the road disturbance. The uncertainties of the quarter-car model is considered with weighting function W_r and Δ . Note, that weighting functions should be considered as penalty functions, hence weights should be large where small signals are desired and vice versa. The aim of weighting function W_n is to represent sensor noises, while weighting function W_w stands for the road disturbances. The goal of weighting functions given in W_p are to keep the sprung mass acceleration (W_{pa}), suspension deflection (W_{pd}), tire deflection (W_{pt}) and control input (W_{pu}) small over the required frequency range. Note, that while W_{pa} represents passenger comfort, W_{pd} and W_{pt} stands for directional stability and dynamic tire load. Since the predefined performance specifications may conflict with each other, weighting functions given in W_p must be designed in a manner that an appropriate trade-off can be guaranteed between them. Moreover, in order to ensure control reconfiguration in case one of the predefined performances becomes more important due to estimated future road conditions, a scheduling variable $\rho \in [0.01, 0.99]$ is introduced to shape weighting function W_{pa} , W_{pd} and W_{pt} . Hence, these performance weighting functions related to passenger comfort and road holding are selected

in a second-order proportional form as follows:

$$W_{p_a} = \rho \frac{\alpha_1 s + 1}{T_1 s + 1} \quad (4a)$$

$$W_{p_d} = (1 - \rho) \frac{\alpha_2 s + 1}{T_2 s + 1} \quad (4b)$$

$$W_{p_t} = (1 - \rho) \frac{\alpha_3 s + 1}{T_3 s + 1}, \quad (4c)$$

where $\alpha_{1,2,3}$ and $T_{1,2,3}$ are designed parameters. Note, that weighting functions W_{p_d} , W_{p_w} , W_r , W_n and W_w are all given in similar linear and proportional form without containing the scheduling variable ρ .

The LPV performance problem is to choose a parameter-varying controller, which guarantees quadratic stability for the closed-loop system while the induced \mathcal{L}_2 norm from the disturbance ω to the performances z is smaller than the value γ , as described in [3]. Hence, the minimization task is given as:

$$\inf_K \sup_{\rho \in \mathcal{F}_P} \sup_{\|w\|_2 \neq 0, w \in \mathcal{L}_2} \frac{\|z\|_2}{\|w\|_2} \leq \gamma. \quad (5)$$

The solution of an LPV problem is governed by the set of infinite dimensional LMIs being satisfied for all $\rho \in \mathcal{F}_P$, thus it is a convex problem. In practice, this problem is set up by gridding the parameter space and solving the set of LMIs that hold on the subset of \mathcal{F}_P , see [4]. The result of the presented design is a reconfigurable LPV controller, where $\rho = 1$ stands for a setup where passenger comfort is preferred, whereas $\rho = 0$ represents a controller focusing on stability and road holding of the vehicle. When ρ is between these edge values, a combination of performances are guaranteed by the controller.

III. SCHEDULING VARIABLE DESIGN WITH FUZZY CONTROL

In this section, the scheduling variable design method has been introduced with the FLC method. In the first step, it's necessary to define the performance index. Then according to the defined performance index, a dedicated scheduling variable has been designed with an FLC controller.

A. Identification of the performance index

The first step for designing the scheduling variable is defining the performance index, where analyzing the importance between two performances is possible. These two performances are driving comfort and vehicle stability. In order to define the performance index, it is necessary to know the normalized value of performances. Calculation of this normalized value for each performances will be introduced in this section.

The database has been created with numerous measurements and historical data with different scheduling variables, road irregularities, and velocity. Our previous journal paper [5] has been introduced the design of the database with different data. The database data has been grouped as root-means-square (RMS) of suspension deflection and vertical body acceleration, velocity, and scheduling variable. RMS

value of vertical acceleration and suspension deflection has been calculated by Eq. 6.

$$R^{va} = \sqrt{\frac{1}{T_a} \int_0^{T_a} a^2(t) dt} \quad (6)$$

$$R^{sd} = \sqrt{\frac{1}{T_s} \int_0^{T_s} t_s^2(t) dt}$$

In order to characterize human comfort, i.e., the effect of exposure to vibration, a filter is applied on the sprung mass acceleration [6]. The transfer function of the filter is depicted in (7).

$$W_{ISO}(s) = \frac{81.89s^3 + 796.6s^2 + 1937s + 0.1446}{s^4 + 80s^3 + 2264s^2 + 7172s + 21196} \quad (7)$$

where, R^{va} and R^{sd} are RMS values of vertical acceleration of body and deflection of the suspension T_a and T_s is the number of acceleration and suspension deflection values, $t_s(t)$ and $a(t)$ are the time-weighted tire deformation and vertical acceleration. Their normalized value is calculated as follow:

$$\zeta_{i,j}^k = \frac{100R_{i,j}^k}{R_{max}^k} \quad (8)$$

Here, ζ is normalized value, $k \in [va, sd]$ is performance, where va is vertical acceleration and sd is suspension deflection performance, i is type of road irregularity and j is velocity of the vehicle. In the case of the velocity of the simulated vehicle, which differs from the database, the interpolation method is used to find dedicated performance values for different velocities and irregularities.

The performance index ϵ defines the importance of one of the performances by comparing their normalized values. The performance index $\epsilon = 2$ stands for the suspension deflection consideration(vehicle stability) and $\epsilon = 1$ stands for the vertical acceleration consideration(driving comfort). The performance index shows that which performance is greater than others and needs to be minimized. Selection of the performance index is depicted by Equation 9.

$$\epsilon = \begin{cases} 1, & \text{if } \zeta^{sd} < \zeta^{va} \\ 2, & \text{if } \zeta^{sd} > \zeta^{va} \end{cases} \quad (9)$$

The selected performances are shown in Table II. The driving comfort has been considered for the sine-sweep irregularity, while vehicle stability performance has been prioritized in other road irregularities.

B. Scheduling variable design with FLC

Fuzzy Logic Designer of MATLAB has been used to design the Fuzzy controller. The general structure of the fuzzy logic control is shown in Figure 3. The fuzzification is composed of the process of transforming crisp values into grades of membership for linguistic terms of fuzzy sets. The membership function is used to associate a rate to each linguistic term. FLC has four variables for fuzzification:

three inputs (road irregularity, velocity, performance) and one output (scheduling variable). Inputs have a beta shape membership function, while output has a triangle membership function. The interval input of the membership function is set at $[-1 \ 1]$.

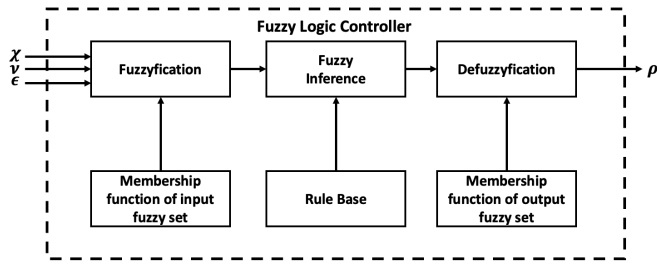

Fig. 3. Block diagram of fuzzy logic controller

The first input for the FLC is the type of road irregularity, where $\chi \in [1, 2, 3, 4, 5]$. Five different road irregularities have been considered in the following order: 10 cm bumps, several bumps, sine-sweep irregularity, 7 cm pothole, and flat road. The second input is the velocity of the vehicle, v with the following boundary: $\chi \in [0 \ 110]$. The third input is the performance index with $\epsilon \in [1, 2]$. The degree of membership of the inputs is shown in Fig. 4. The output of the FLC is scheduling variable ρ , which is used for the LPV controller in order to trade-off between driving comfort and vehicle stability.

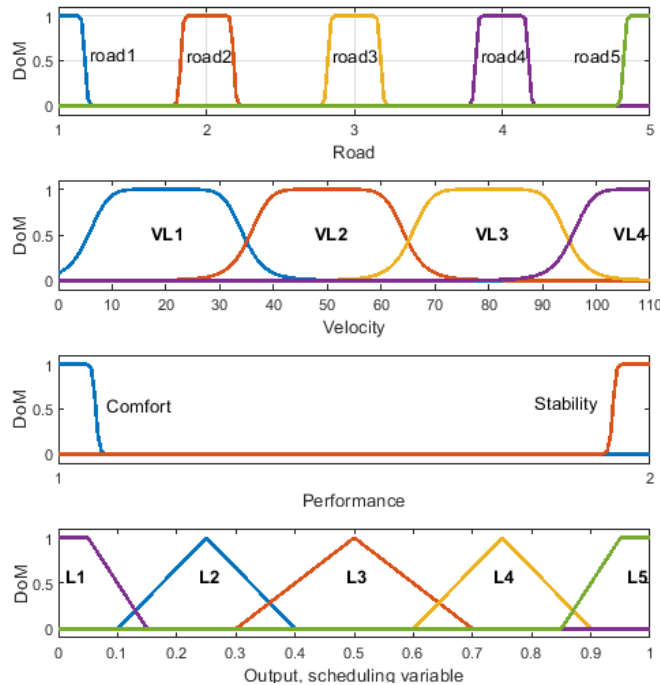

Fig. 4. Degree of membership for inputs and output

The rules are based on the created database, which has been mentioned in the previous section and in [5] (with different data). According to the performance index, the dedicated minimum performance result has been chosen in

the dedicated velocity, and their scheduling variable interval has been selected as output. Surfaces of FLC model with inputs and output are seen in Figure 5.

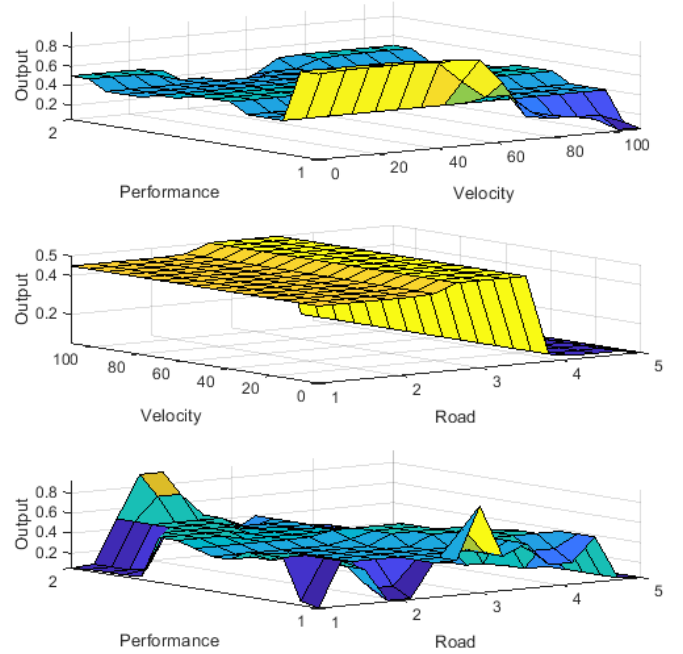

Fig. 5. Surfaces of FLC model

As it can be seen in Figure 6, the vehicle is simulated by using TruckSim software. The simulation environment is integrated with Matlab/Simulink, where the proposed method and controller test. Real time information was gathering from vehicle and used in the identification of performance index algorithm, database, FLC and LPV controller.

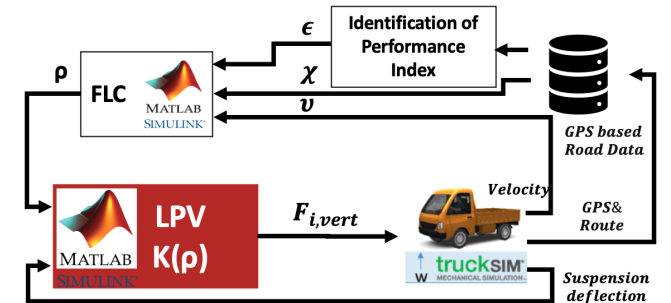

Fig. 6. Architecture of the system

IV. SIMULATION RESULTS AND ANALYSIS

The simulation has been held with the compact utility truck with an independent front and rear semi-active suspension system in the simulation route that is part of a Hungarian highway road (Mátraí út) implemented in the Trucksim simulation environment based on real geographical data, having road distortions.

The length of the simulation route is 1400 m with different road irregularities depicted in II. The real road irregularity model has been used in order to give maximal stress to

the suspension system. The 10 cm heightened right and left bumps to represent common speed bumps in urban areas. This road irregularity is for testing the driving over a speed bump. The sine-sweep road irregularity represents a typical road at the bus stop due to its rolled-up structures with longitudinal sinusoidal road distortion with growing frequency. Different potholes and bumps following each other have been created to represent the bad road quality with discontinuities in the asphalt. The 7 cm pothole represents the road holes because of weather conditions and other external causes.

Two different simulations has been performed and compared in the same route, one with the utility truck that has conventional semi-active suspension and the other where it was equipped with the proposed adaptive semi-active suspension. The velocity profile of simulated vehicles is shown in Fig. 7.

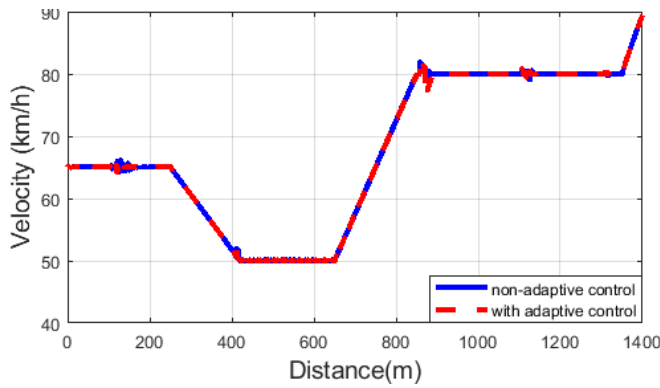

Fig. 7. Velocity profile of vehicle

TABLE II

IRREGULARITIES AND DESIGNED SCHEDULING VARIABLE

Road irregularity	Velocity (km/h)	Location (m)	Performance	Designed ρ
Several bumps	65	100	2	0.667
10cm bumps	51.7	400	2	0.05
Sine-sweep	72.5	800	1	0.273
Several bumps	80	1100	2	0.5
7cm bumps	80	1300	2	0.25

The designed scheduling variable with FLC method be observed in Fig. 8, while these results are also shown in Table II. Note that the selected scheduling variable in this table shows maximum value of scheduling variable for this road irregularity.

In the next step, the conventional and adaptive method performances are compared, where the upper figure shows non-adaptive, below figure shows the adaptive method. The first performance is related to driving comfort. The driving comfort can be represented by the vertical and lateral acceleration of the vehicle. Figure 9 shows that both vertical acceleration and lateral accelerations have been reduced concordantly, the driving comfort has been improved. There is no difference in 10 cm bumps (second irregularity) because its scheduling variable same as the compared simulation. The

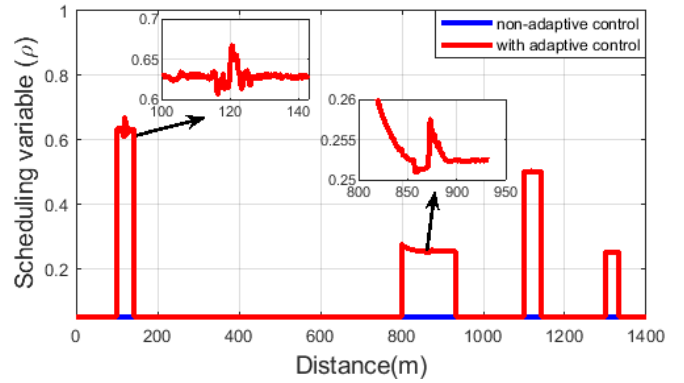

Fig. 8. Designed scheduled variable

biggest change is in the several bumps (first irregularity), while the change in the 7cm bumps is not significant due to its distortion level and selected scheduling variable.

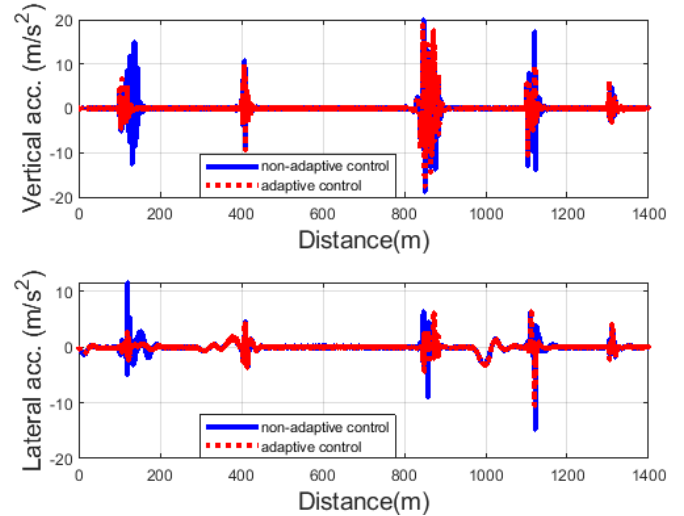

Fig. 9. Accelerations

Another performance is road holding, which is defined as the tire deformation level of the vehicle, while Figure 10 shows the tire deformation results of simulations. The tire deformation has been reduced and the road holding performance has been improved. Again, the second irregularity has not been reduced due to the same scheduling variable as a compared method. The biggest changes are in the first and fourth irregularity, while tire deformation of FL and FR tires in the sine-sweep and 7cm bump irregularities have been increased.

The last performance is vehicle stability, while this performance is symbolized with suspension deflection, which can be seen in Figure 11. The amount of suspension deflection has been reduced except for the RL and RR suspension in 10 cm and 7 cm bumps.

The one of performance for the controller is minimizing the control force, while it is well shown that actuated forces with introduced adaptive method is smaller then the non-adaptive method in Figure 12.

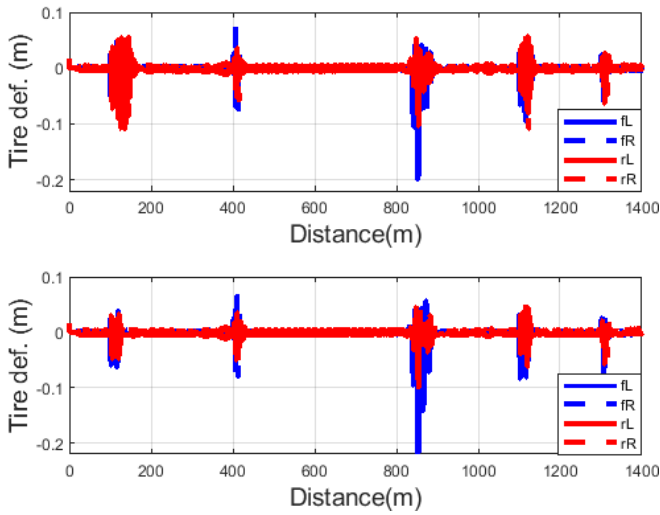

Fig. 10. Tire deformation

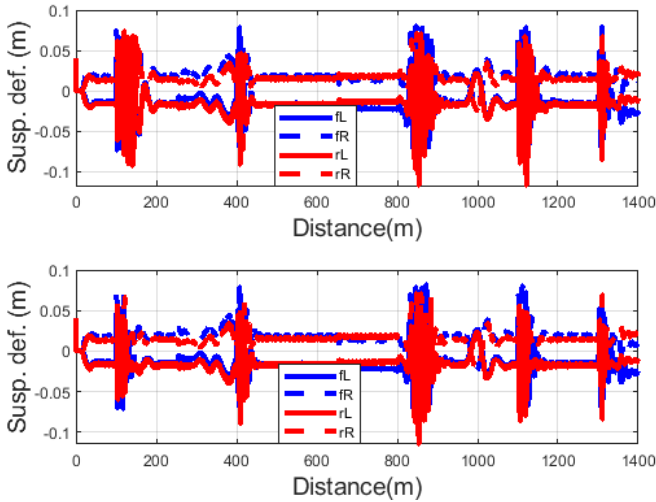

Fig. 11. Suspension deflection

The improvement in performances is shown in Table III. The negative improvement percentage expresses the improvement in the related performances. For the two performances, which are tire deformation of FL and FR tires are deteriorated.

V. CONCLUSION

This paper introduced a road adaptive semi-active suspension control method, where a trade-off between vehicle stability and driving comfort is accomplishable to achieve desirable performance results at different road irregularities and velocities. This trade-off is accomplishable due to flexibility and online reconfigurability of the LPV control method by scheduling variable, where the design is based on the FLC method. By this means, the semi-active suspension system is able to adapt in coherence with oncoming road conditions and current velocity, where this method improves both driving comfort and vehicle stability. The operation of the proposed method has been demonstrated in a real

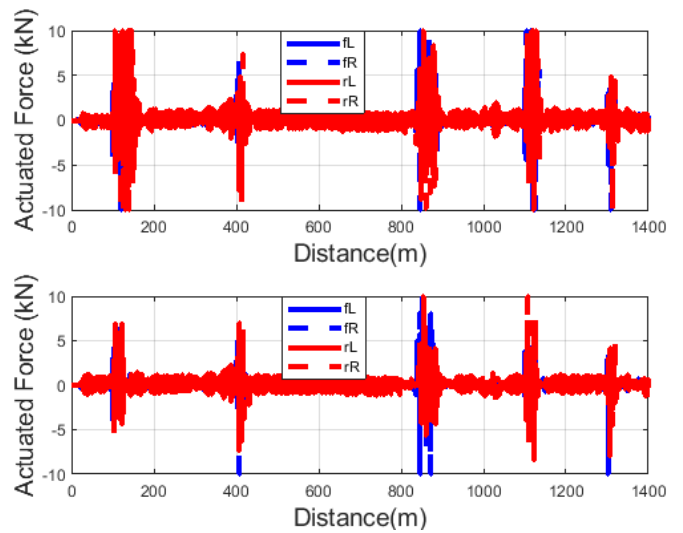

Fig. 12. Control forces

TABLE III
PERFORMANCE IMPROVEMENT

	Non-adaptive RMS	Adaptive RMS	Improvement (%)
Vertical acc.	1.3157	1.208	-8.19
Lateral acc.	0.7259	0.6143	-15.37
Tire def. FL	0.0128	0.0147	14.84
Tire def. FR	0.0128	0.0143	11.72
Tire def. RL	0.0085	0.0073	-14.12
Tire def. RR	0.0117	0.0068	-41.88
Susp. def. FL	0.0216	0.0212	-1.85
Susp. def. FR	0.0228	0.0225	-1.32
Susp. def. RL	0.0207	0.0202	-2.42
Susp. def. RR	0.0203	0.0183	-9.85
Yaw rate	0.0358	0.0285	-20.39

data simulation in the TruckSim environment. The simulation results show that road holding, vehicle stability, and driving comfort have been improved.

REFERENCES

- [1] H. Basargan, A. Mihály, P. Gáspár, and O. Sename, "Road quality information based adaptive semi-active suspension control," *Periodica Polytechnica Transportation Engineering*, vol. 49, no. 3, pp. 210–217, 2021.
- [2] H. Basargan, A. Mihály, P. Gáspár, and O. Sename, "Adaptive semi-active suspension and cruise control through lpv technique," *Applied Sciences*, vol. 11, no. 1, 2021. [Online]. Available: <https://www.mdpi.com/2076-3417/11/1/290>
- [3] J. Bokor and G. Balas, "Linear parameter varying systems: A geometric theory and applications," *16th IFAC World Congress, Prague*, 2005.
- [4] F. Wu, X. H. Yang, A. Packard, and G. Becker, "Induced l2-norm control for lpv systems with bounded parameter variation rates," *International Journal of Robust and Nonlinear Control*, vol. 6, no. 9-10, pp. 983–998, 1996.
- [5] H. Basargan, A. Mihály, Á. Kisari, P. Gáspár, and O. Sename, "Vehicle semi-active suspension control with cloud-based road information," *Periodica Polytechnica Transportation Engineering*, vol. 49, no. 3, pp. 242–249, 2021. [Online]. Available: <https://pp.bme.hu/tr/article/view/18593>
- [6] L. Zuo and S. Nayfeh, "Low order continuous-time filters for approximation of the iso 2631-1 human vibration sensitivity weightings," *Journal of sound and vibration*, vol. 265, no. 2, pp. 459–465, 2003.