



HAL
open science

Calorimetric study of carbon dioxide (CO₂) hydrate formation and dissociation processes in porous media

Fatima Doria Benmesbah, Pascal Clain, Olivia Fandino, Véronique Osswald, Laurence Fournaison, Christophe Dicharry, Livio Ruffine, Anthony Delahaye

► To cite this version:

Fatima Doria Benmesbah, Pascal Clain, Olivia Fandino, Véronique Osswald, Laurence Fournaison, et al.. Calorimetric study of carbon dioxide (CO₂) hydrate formation and dissociation processes in porous media. *Chemical Engineering Science*, 2022, 264, pp.118108. 10.1016/j.ces.2022.118108 . hal-03789729

HAL Id: hal-03789729

<https://hal.science/hal-03789729>

Submitted on 27 Sep 2022

HAL is a multi-disciplinary open access archive for the deposit and dissemination of scientific research documents, whether they are published or not. The documents may come from teaching and research institutions in France or abroad, or from public or private research centers.

L'archive ouverte pluridisciplinaire **HAL**, est destinée au dépôt et à la diffusion de documents scientifiques de niveau recherche, publiés ou non, émanant des établissements d'enseignement et de recherche français ou étrangers, des laboratoires publics ou privés.

1 **Calorimetric study of carbon dioxide (CO₂) hydrate formation and** 2 **dissociation processes in porous media**

3 Fatima Doria Benmesbah^{a,b,*}, Pascal Clain^{c, a*}, Olivia Fandino^b, Veronique Osswald^a,

4 Laurence Fournaison^a, Christophe Dicharry^d, Livio Ruffine^b, Anthony Delahaye^a

5 ^a Université Paris-Saclay, INRAE, FRISE, 92761, Antony, France.

6 ^b IFREMER, Département Ressources physiques et Ecosystèmes de fond de Mer (REM),

7 Unité des Géosciences Marines, 29280 Plouzané, France

8 ^c Leonard de Vinci Pôle Universitaire, Research Center, 12 avenue Léonard de Vinci, 92916,

9 Paris La Défense, France

10 ^d CNRS/TOTALENERGIES/UNIV PAU & PAYS ADOUR, Laboratoire des Fluides Complexes et

11 leurs Réservoirs - IPRA, UMR5150, 64000, Pau, France

12 *Corresponding author(s): Fatima Benmesbah: benmesbah.fatimadoria@gmail.com; Pascal

13 Clain: pascal.clain@devinci.fr

14 **Abstract**

15 Understanding the formation and dissociation mechanisms of gas hydrate in porous media is
16 important for the development of new energy-efficient and environmentally friendly
17 technologies related to cold storage as they provide significant latent heat and energy density
18 at suitable phase change temperature. The challenge is to understand the interactions between
19 gas hydrates and the chosen storage media in order to assess the operating conditions likely to
20 optimize time and energy consumption in cold production and storage systems. In this work,
21 CO₂ hydrates formation and dissociation **are investigated** in two morphologically different
22 porous materials: sand and silica gels. A calorimetric approach is applied to study both the
23 CO₂ hydrate formation kinetics, particularly the induction time, and the amount of hydrate
24 formed for each of the two porous materials. The experiments are performed using a

25 differential thermal analysis device with two identical measuring cells. The present work is
26 focused on assessing the effect of key factors like water saturation, particle size and the
27 morphology of porous media on CO₂ hydrate formation and dissociation processes. Overall,
28 the results do not show a statistically significant correlation between these factors and the
29 induction time. Interestingly, the results obtained with dual porous silica gel showed a higher
30 amount of hydrate formed compared to those with sand for similar initial pressure,
31 temperature and water content conditions. This result may be due to the fact that silica gels
32 provide higher surface area due to their smaller particle size (20-45 μm vs. 80-450 μm for
33 sand), and the presence of internal pore volume in silica gel particles.

34 *Keywords: CO₂ hydrate, Cold storage, Differential thermal analysis, Particle and Pore size,*
35 *Porous media, Water saturation*

36

37 **1. Introduction**

38 Industry requirements for thermal energy production and storage are increasing to meet
39 human needs, for example, for food conservation, refrigeration and air conditioning.
40 However, cold production is responsible for 20 % of the electrical energy consumed in
41 industrial countries and 8 % of greenhouse gas emissions due to traditional refrigeration
42 processes. Indeed, these processes use harmful refrigerants such as Chlorofluorocarbons
43 (CFCs) and Hydrochlorofluorocarbons (HCFCs) that are relevant to radiative forcing and
44 stratospheric ozone depletion, but also, Hydrofluorocarbons (HFCs) which, like CO₂, are
45 linked only to radiative forcing. These coolants have a much higher global warming potential
46 than carbon dioxide (for example, CFC-12, HCFC-22 and HFC-134a are respectively 10 900,
47 1 810 and 1 430 times as warming as carbon dioxide over a 100-year period (Forster and
48 Venkatachalam, 2005). In an attempt to contain and reduce the use of these refrigerants,
49 secondary refrigeration has been proposed as an interesting and promising solution. It
50 introduces the use of environmentally neutral refrigerants that conduct thermal energy in a
51 secondary circuit to the cooling point (Delahaye et al., 2018; Wang et al., 2015).

52 The development of a cost-effective and environmentally friendly secondary refrigeration
53 system requires a good balance between energy demand and supply. In this context, the
54 cooling capacity of the system has to be sufficient during peak hours when energy
55 consumption is high. Cold storage is a suitable method to increase this cooling capacity.
56 Indeed, cold storage devices can be used to store cold thermal energy during off-peak periods,
57 and use it during peak hours, which contributes to peak shaving and refrigerating system
58 downsizing. Hence, cold storage offers flexibility in energy consumption by ensuring spatial
59 and temporal regulation. This is why most of the industrial achievements combine cold
60 production and storage systems. Traditionally, cold storage technologies use ice, chilled water
61 or eutectic salt (Akbari and Mertol, 1989; Cheng et al., 2020). However, some of these

62 storage media have low energy efficiency and can be very costly (Hasnain, 1998). The
63 challenge of this technology is to select a refrigerant with high energy density and high heat
64 transfer capacity in order to reduce the system power consumption. One of the solutions that
65 is currently under consideration is the use of phase change materials for such a technology.

66 Among the phase change materials that have the most suitable criteria for the refrigeration
67 industry, gas hydrates have attracted the attention of several researchers who considered them
68 as a potential candidate, primarily due to their interesting thermodynamic properties (Sloan,
69 1998; Sloan and Fleyfel, 1992). Gas hydrates are non-stoichiometric crystalline structures
70 composed of hydrogen-bonded water molecules forming cavities, generally called cages.
71 These cavities can trap gas molecules like hydrogen, nitrogen, helium, methane, carbon
72 dioxide or hydrocarbons and so on (Loveday and Nelmes, 2008; Sloan and Koh, 2007),
73 which stabilizes the hydrate structure. Gas hydrates are stable under low temperature and
74 high-pressure conditions. The attractive properties of gas hydrates include their high gas
75 storage capacity, their increased gas selectiveness capacity and their high dissociation
76 enthalpy. In addition, they are stable over a wide range of temperatures (in particular for $T >$
77 273 K, for example, CO₂ hydrates can form at a rough range of temperatures between 273 and
78 283 K, and an approximate pressure range of 1.5-4.5 MPa), which is of a particular interest
79 for air conditioning (Englezos, 1993; Fournaison et al., 2004; Li et al., 2012).

80 The development of a CO₂ hydrate-based cold production, transport and storage system
81 requires intensive studies on the kinetic, thermodynamic and rheological characteristics of
82 CO₂ hydrate slurries (gas hydrate crystals suspended in water), which were the focuses of
83 many studies in the past (Boufares et al., 2018; Darbouret et al., 2005; Delahaye et al., 2008;
84 Dufour et al., 2017; Jerbi et al., 2010; Kumar et al., 2016; Prah and Yun, 2018; Shindo et al.,
85 1993). Several of them pointed out a slow gas hydrate formation rate and a low storage
86 density in bulk media (Englezos et al., 1987; Linga et al., 2010). In order to enhance energy

87 efficiency of hydrate-based industrial applications, several solutions that involve specific
88 properties have been proposed such as **acceleration of the formation process by stirring in**
89 **order** to improve **gas mass** transfer **to liquid** by enhancing the **gas-liquid contact** interface
90 (Linga et al., 2012; Wang et al., 2014); the use of acoustic waves (Laugier et al., 2008; Wang
91 and Dennis, 2017) or the use of kinetic or thermodynamic chemical additives (Joshi et al.,
92 2013; Kang et al., 2001; Kumar et al., 2013; Martínez et al., 2008; Torr e et al., 2011).
93 According to a recent review of literature enhancing mass transfer by forming CO₂ hydrates
94 in porous media could improve Cold Thermal Energy Storage (CTES) design (Wang et al.,
95 2020). However, related current research is focused on other applications such as gas
96 separation (Yang et al., 2015), CO₂ sequestration (Oya et al., 2017), and mainly on
97 understanding natural hydrate dynamics (Malagar et al., 2019; Zhang et al., 2017). To our
98 knowledge, very few studies have been published on the use of porous media in CO₂ hydrate-
99 based cold storage technologies. Indeed Clain (2014) mentioned the interest and the kinetic
100 and thermodynamic influence of porous media which can constitute a simple solution to
101 implement for the development of a multi-temperature storage process from hydrates. More
102 recently, Cheng et al. (2020) reported on the use of porous media as a hydrate reinforcement
103 method aiming at reducing the induction time of hydrate formation, increasing nucleation
104 rates, and bettering the cold storage density of the cold storage media. In addition, as
105 mentioned previously Wang et al. (2020) pointed out in a review that one of the important
106 challenges of CTES systems based on CO₂ hydrates is a low mass transfer due to limited gas-
107 liquid interface. The authors suggested the use of porous media in future work to improve
108 mass transfer and thus the gas-liquid interface.

109 In a series of investigation on gas hydrates formation and dissociation kinetics, **it has been**
110 shown an improvement of gas hydrate formation as well as water to hydrate conversion rates
111 in a packed bed of silica sand particles compared to a stirred vessel (bulk media) (Linga and

112 Clarke, 2017; Linga et al., 2009). Indeed, porous media offer a relatively large contact surface
113 compared to bulk media. They allow a better distribution of the liquid and vapor phases by
114 adsorption on the surface of the particles and with the help of capillary forces, thus increasing
115 the gas-water contact. Therefore, the mechanisms of gas hydrate formation and dissociation in
116 porous media must be carefully considered.

117 In order to provide a large surface area and potentially to limit energy consumption related to
118 the stirring required in bulk media, the present paper seeks to address CO₂ hydrates formation
119 and dissociation in porous media using a calorimetric approach. Several studies attempted to
120 investigate the interaction between gas hydrates and the porous media in which they form
121 (Adeyemo et al., 2010; Bagherzadeh et al., 2011; Chong et al., 2016; Fitzgerald et al., 2014;
122 Ge et al., 2019; Heeschen et al., 2016; Kang et al., 2013; Kumar et al., 2015; Mekala et al.,
123 2014; Nguyen et al., 2020; Qin et al., 2022; Smith et al., 2002; Wang et al., 2021; Zhang et
124 al., 2022; Zhang et al., 2016). This literature draws attention to the effect of several factors on
125 gas hydrate formation rate and water to hydrate conversion, such as:

126 (1) The nature of porous media (surface chemistry, morphology: pore and particle size).
127 Indeed, for particle size, a number of studies demonstrated an increase in the amount of
128 hydrates formed, with higher gas consumption by hydrates and/or higher water-to-hydrate
129 conversion rate for smaller particle sizes tested (Bhattacharjee et al., 2015; Ge et al., 2019;
130 Mekala et al., 2014). For example, Ge et al. (2019) performed CH₄ hydrate formation in a
131 high-pressure reactor using two particle size classes of silica sand, 180-250 and 300-900 μm.
132 The porous media was 70 % saturated with pure water. The authors demonstrated higher gas
133 consumption by hydrates and water-to-hydrate conversion for the smallest particle size. This
134 tendency is also observed for smaller pore sizes (Zhang et al., 2015). However, other studies
135 demonstrated an opposite result concerning the influence of particle size (Adeyemo, 2008;
136 Kumar et al., 2015; Lu et al., 2011; Pan et al., 2018). In fact, Pan et al. (2018) performed CH₄

137 hydrate formation in silica sand for various particle sizes, 38, 48, 74, 106 and 165 μm . In their
138 study, they used a 300-ppm (mass fraction) of sodium dodecyl sulfate (SDS) solution for all
139 experiments with a liquid phase saturation of 50 %. The results showed that gas storage
140 capacity and water to hydrate conversion rate increase with the increase of particle size
141 (0.101 mol of gas/mol of liquid and 61.9 % water to hydrate conversion rate for 38 μm
142 particle size, versus 0.151 mol of gas/mol of liquid and 92.2 % water to hydrate conversion
143 rate for 165 μm particle size). The authors suggested that smaller particle sizes lead to narrow
144 pores, which can decrease connectivity of the porous media, and slower CH_4 diffusion in the
145 liquid phase. Globally, it has been suggested that hydrates formed in smaller pores may
146 obstruct gas diffusion in the porous media.

147 (2) The operating conditions (pressure, temperature, water saturation, gas solubility, etc.).
148 Indeed, several studies have shown that water saturation affects not only the final hydrate
149 saturation, but also the gas transport within the porous medium (Babu et al., 2013;
150 Bagherzadeh et al., 2011; Ge et al., 2019; Kumar et al., 2015). Some of these studies have
151 shown that at low water saturation, gas transport in the pore medium is facilitated, and liquid-
152 gas contact is improved. As a consequence, the formation of hydrates is also improved.
153 However, some authors have shown that low water saturation limits the amount of water
154 available for hydrate formation (Babu et al., 2013; Kumar et al., 2015). Based on the above
155 studies, it is noted that water saturation is an important factor that requires further and
156 extensive studies to determine the optimal water saturation conditions for gas hydrate
157 formation in the studied porous media.

158 Obviously, the effects of porous structure on gas hydrates formation kinetics, particularly on
159 induction time, are not fully understood, as well as, the effect of the nature of porous media
160 on gas-liquid contact area and on heat/mass transfer.

161 To better control gas hydrates formation and dissociation in a cold storage system, it is of
162 great interest to study CO₂ hydrate formation kinetics and their thermodynamic stability
163 conditions, as well as the possible energy storage of the porous media containing CO₂
164 hydrates. The present paper aims to provide further insight into CO₂ hydrate formation and
165 dissociation processes in porous media based on heat and mass transfer characterization.
166 Using a differential thermal analysis method, an original approach in literature to study CO₂
167 hydrates in porous media for cold storage purpose, the effect of key factors such as water
168 saturation, particle size and the morphology of the porous media on the solid mass fraction
169 formed was investigated. For the latter, two morphologically different porous media were
170 used: silica sand and **dual porous** silica gel. The experimental data obtained add to a growing
171 body of literature on the influence of porous media on gas hydrate formation and dissociation
172 processes, in an attempt to enhance energy efficiency of industrial applications such as
173 hydrate-based cold storage systems.

174 2. Experimental section

175 CO₂ hydrates formation and dissociation experiments were conducted using differential
176 thermal analysis, which is an accurate and suitable method of characterizing thermal
177 properties such as dissociation enthalpy of gas hydrates. This heat-flux calorimetry method is
178 traditionally used to measure various thermo-physical properties of gas hydrates (Gupta et al.,
179 2008; Kang et al., 2001; Lievois et al., 1990). The principle is based on the use of two
180 identical cells connected to each other by several thermocouples. This connection allows an
181 instantaneous and precise measurement of the temperature change between the two cells when
182 a phase change occurs in one of the cells. A detailed description of the method is given in the
183 following subsections.

184 2.1. Materials

185 Carbon dioxide with a certified purity of more than 99.7 % was supplied by Linde Gas
186 (France). Fontainebleau silica sand purchased from Laboratoires Humeau (La Chapelle-sur-
187 Erdre, France) and spherical silica porous gel particles of nominal pore diameters of 30 and
188 100 nm supplied by Silicycle Co. (Canada) were used as porous media. All materials were
189 used without further purification. The detailed properties of silica sand and silica gel are listed
190 in Table 1.

191 Table 1: Physical properties of Fontainebleau silica sand and silica gel samples.

Parameters	Fontainebleau silica sand	30 nm Silica gel	100 nm Silica gel
Mean particle diameter (μm)	80-450	20-45	20-45
Mean pore diameter (nm)	-	30	100
Pore volume ($\text{cm}^3 \cdot \text{g}^{-1}$)	-	0.86	0.7
Dry density ($\text{g} \cdot \text{cm}^{-3}$)	2.65	2.2	2.2

192 To study the influence of particle size on CO₂ hydrate formation and dissociation,
193 Fontainebleau silica sand was sieved to 3 classes of particles: 80 to 160 μm ; 160 to 315 μm
194 and 315 to 450 μm noted respectively PS01, PS02 and PS03.

2.2. Differential thermal analysis (DTA) apparatus description

A differential thermal analysis (DTA) apparatus was used for the experiments, whose principle was described in a previous work (Fournaison et al., 2004). It was designed to measure the difference in thermal behavior between two identical cells submitted to the same heat flux. A schematic diagram of the experimental apparatus is shown in Figure 1. It consists of two identical and symmetric transparent glass cells with a functional volume of 40 ml. The transparent walls enable visualization of the studied samples inside the cells.

The two cells are immersed in a temperature-controlled bath (blue area in Figure 1). One of them is filled with the porous media at a certain water saturation and used as the reactor for hydrate formation (called measurement cell). The second cell (called reference cell) is filled with the same porous media and water saturation as the measurement cell with an inert solution of water-ethanol 50 % vol/vol, in order to avoid crystallization during the thermal cycle while having thermal properties close to those of the liquid in the measurement cell. The measurement cell is connected to a CO₂ supply line, which contains a cylinder with a volume of 10 cm³ (± 10 % tolerance on the volume) and three manual valves to allow gas supply. The cylinder is also immersed in the temperature-controlled bath. It allows (1) to determine the amount of gas injected in the measurement cell and (2) to limit the risk of overpressure in the glass cell. Indeed, CO₂ is injected in the measurement cell using a successive gas expansion method. This method consists of injecting the gas into the sample cylinder while keeping valve 1 closed. Valve 3 is then closed to disconnect the gas supply. Once the pressure in this circuit is stable, valve 1 is open to allow gas expansion in the cell. This operation is repeated several times until the targeted experimental pressure around 2.5 MPa is reached. The amount of CO₂ injected (mole) in each operation is calculated by the difference between the amount of CO₂ (mole) present in the circuit (between valve 1 and valve 3) before and after expansion to the cell.

220 The pressure is measured at two points: the first pressure sensor (0-10 MPa. 0.011 % full
221 scale. Keller) is located at the inlet of the measuring cell, and a second one (0-10 MPa.
222 0.006 % full scale. Keller) at the inlet of the gas supply line.

223 Each cell is equipped with one thermocouple that gives a direct temperature measurement
224 (± 0.5 K). The DTA measurement is based on the use of six thermocouples, three of which are
225 inserted in one cell and three in the other. All thermocouples are located at the lowest part of
226 the cell. These six thermocouples are connected together in series, by a back and forth
227 connection between the two cells, as shown in Figure 2. This connection makes it possible to
228 obtain an electrical signal directly linked to the difference in temperature between the two
229 cells, and consequently to the difference in heat flow, knowing that the two cells are
230 immersed in the same temperature-controlled bath.

231 The first advantage of this direct connection between the two cells is to allow an
232 "instantaneous" measurement of the temperature difference, and not a difference between two
233 temperature values measured by two individual thermocouples (which would each imply a
234 measurement error). Another interest of the back and forth connection is to amplify the
235 differential signal between the two cells, while limiting the error to one measurement, i.e. the
236 signal recovered by the acquisition unit. This avoids the cumulative errors that could be
237 obtained if six thermocouples were used individually.

238 **2.3.Experimental procedure**

239 **2.3.1. Sample preparation and characterization**

240 Silica sand samples at various water saturation were prepared using the following procedure:
241 first, silica sand was dried at 388.15 K for 24 h. Then an amount of water corresponding to the
242 desired water saturation was added to the sand at ambient temperature. The porosity of the
243 unpacked sand was estimated by the supplier (Humeau Laboratories) to be approximately
244 0.44. Finally, the mixture was introduced into the measurement cell and packed evenly to fill

245 the entire volume. In order to evaluate the water distribution in the sand samples, an X-ray
 246 micro-tomography experiment (DeskTom 130®, RX Solution, Chavanod, France) was
 247 performed on a sand sample with 66 % water saturation. The sample was prepared under the
 248 same conditions as the hydrate formation experiments, but in a transparent resin cell
 249 (Formlabs, Clear PhotoPolymer) which has the same internal volume as the DTA cells (inner
 250 diameter = 3 cm, height = 6.4 cm). This sample was then placed in the micro-tomography
 251 device.

252 The analysis was performed with a voltage of 124 μ V and a voxel size of 27.33 μ m. XAct 2®
 253 software (RX Solution, Chavanod, France) was then used for 3D-reconstruction from raw
 254 images. A 3D-visualization and volume fractions of the phases within the sample (sand, water
 255 and air) were obtained using Avizo 2019.1® software (Thermo Fisher Scientific, Waltham,
 256 USA). Figure 3 shows the images obtained after the 3D-reconstruction. Due to the size of the
 257 sample, which produces a very large data file, the image processing was performed on two
 258 volumes (clipped) located in the upper and lower part of the sample. The idea was to have a
 259 clearer view on the water distribution over the sample. The latter contains three phases; sand
 260 (represented in yellow), water (blue) and air (dark grey). **Table 2** shows information about the
 261 volume fractions of the different **compounds** contained in the selected parts.

262 Table 2: Volume fractions of air, water and **packed** silica sand within the analyzed volumes
 263 **by micro-tomography**

Analyzed Volume	Material	Volume fraction (%)	Total volume (cm³)
Upper part	Air	0.10	0.529
	Water	0.19	
	Silica Sand	0.71	
Lower part	Air	0.10	0.190
	Water	0.19	
	Silica Sand	0.71	

264 Overall, based on Figure 3 and Table 2 analysis, it can thus be reasonably assumed that the
265 filling method used for silica sand samples leads to a homogeneous water dispersion in the
266 porous media since the same distribution of the various compounds was observed by micro-
267 tomography at different spatial positions of the sample.

268 In order to address the limitations related to the mass transfer of gas, and water-gas contact in
269 the porous media, and in light with previous studies (Adeyemo, 2008; Adeyemo et al., 2010;
270 Dicharry et al., 2013; Kang et al., 2008; Kumar et al., 2013; Park et al., 2006), it seems to be
271 important to study media with different morphologies (presence or not of dual porosity), in
272 order to enhance the amount of energy stored per volume. In fact, dual porosity media may
273 present two advantages for cold storage system:

274 1) Provide an additional internal surface area,

275 2) Provide a better diffusion of gas through the porous media, since water can occupy the
276 internal pore volume thanks to capillary forces, thus leaving the interstitial space potentially
277 free for gas diffusion (as represented by the schematic illustration in Figure 4).

278 Silica gel samples were prepared using a procedure from Dicharry et al. (2013). The
279 procedure consists of layering uniformly the dried silica gel and water at 393.15 K for 24 h in
280 various stages alternatively. The amount of water introduced at each layer is identical to the
281 desired saturation of the pore volume of silica gel. The same procedures (for sand or silica
282 gel) were used to fill the reference cell. Finally, the measurement cell was closed and residual
283 air was removed with a vacuum pump.

284 **2.3.2. DTA analysis of CO₂ hydrate formation and dissociation in** 285 **silica sand**

286 After pressurizing the measurement cell with CO₂ using an expansion method to the desired
287 experimental pressure set around 2.5 MPa, the bath temperature was then set to 285.15 K to

288 stabilize the temperature inside both cells at an initial equilibrium state. Figure 5 shows the
289 evolution of pressure, temperature and DTA signal during an experiment in sand initially
290 saturated with water at 33 %. After the initial equilibrium state, the system was gradually
291 cooled down until 271.15 K.

292 The temperature peak (red line) indicates CO₂ hydrate formation due to the exothermic
293 property of crystallization. Meanwhile, the DTA signal peak (blue line) illustrates the
294 difference in heat transfer between the two cells. Thus, when the temperature conditions are
295 close in both cells, the DTA signal is close to zero. However, when the exothermic reaction
296 occurs in the measurement cell, the DTA signal increases rapidly with a similar pattern
297 compared to the direct measurement of the temperature. CO₂ hydrate formation is also
298 accompanied with a temperature peak and a strong decrease in the system pressure due to the
299 consumption of CO₂ during the hydrate growth. **Figure 5b shows the presence of two**
300 **consecutive DTA peaks (2 red arrows on Figure 5b). These two peaks are accompanied with 2**
301 **consecutive pressure drops corresponding to gas consumption by hydrates. This result**
302 **suggests the occurrence of multiple nucleation followed by growth of CO₂ hydrates in silica**
303 **sand. This behavior occurred for all experiments within silica sand.** When pressure,
304 temperature and DTA signal stabilized the thermodynamic equilibrium was considered to be
305 reached, and CO₂ hydrate formation finished. Hydrate dissociation was triggered by
306 increasing the bath temperature gradually with a rate of 0.1 K.min⁻¹ until the initial
307 temperature was reached (285.15 K). As shown in Figure 5a and c, hydrate dissociation is
308 expressed by a large and opposite variation in the DTA signal compared to hydrate formation.
309 This is due to the endothermic nature of hydrate dissociation. The temperature condition was
310 then maintained at 285.15 K to ensure a complete hydrate dissociation. Due to **supercooling**
311 phenomena related to the crystallization of gas hydrates, the exploitation of the DTA signal
312 peak related to hydrate formation remains difficult. **Indeed, the formation being done by**

313 breakage of supercooling, in bulk, and with high driving force, in porous media, the formation
314 peaks quality strongly depends on the operating conditions. For this reason, dissociation peaks
315 are generally used in calorimetry work (Chami et al., 2021; Lin et al., 2014). Thus, the
316 discretization of the DTA signal obtained during hydrate dissociation was performed to
317 determine the experimental dissociation enthalpy and calculate the mass of hydrates formed in
318 the reactor.

319 **2.3.3. Effect of the pore size of silica gel on equilibrium conditions of** 320 **CO₂ hydrates**

321 The effect of dual porous silica gel on the thermodynamic conditions of hydrate stability was
322 examined. Figure 6a presents the results related to dissociation temperature of CO₂ hydrates in
323 silica gel with a pore volume of 100 nm and 30 nm. These results are plotted in a P-T diagram
324 and compared to the bulk-CO₂ equilibrium curve. A shift can be seen between the bulk-CO₂
325 hydrate equilibrium curve and that obtained in silica gel with a nominal pore size of 100 nm
326 and 30 nm. For instance, with a pressure of 1.46 MPa, the two equilibrium temperatures
327 present a shift of 0.7 K towards lower temperature conditions in comparison with the bulk
328 equilibrium curve. Figure 6b shows that these results are consistent with those reported in the
329 literature using several pore sizes of silica gel. All three-phase equilibrium points of CO₂
330 hydrates in silica gel with varying nominal pore sizes show a deviation from the bulk
331 equilibrium curve of CO₂ hydrates. In addition, a decrease in pore size (going from 100 to 30
332 and then to 15 nm) resulted in a higher shift from the CO₂ hydrate equilibrium curve. In
333 general, the presence of mesoporous volume from the ten to fifty nanometer scale generates
334 an inhibiting effect for the formation of hydrates in silica gel. This can be explained by an
335 important capillary effect generated by small pore size. Indeed, water being confined in very
336 small pore size leads to a high capillary pressure. Consequently, the system needs more
337 energy in order to overcome these forces and form hydrates in the mesoporous volume. This
338 result is also demonstrated in several previous studies for CO₂, CH₄ and C₃H₈ (Adeyemo et

339 al., 2010; Babu et al., 2013; Dicharry et al., 2013; Handa and Stupin, 1992; Smith et al., 2002;
340 Turner et al., 2005; Uchida et al., 2002; Yang et al., 2012).

341 **2.3.4. Calibration and quantification of the amount of CO₂ hydrates** 342 **formed**

343 It is important to mention that the DTA technique is based on the determination of relative
344 properties that depend on the heat transfer between the bath and the measurement/reference
345 cell, which is related to the system configuration and geometry. Therefore, a calibration
346 experiment consisting of formation and dissociation procedure applied to a calibration
347 material with known properties is required for each new configuration (the geometric
348 characteristics, nature of the porous media, water saturation, etc.). In **this** case, the calibration
349 material is ice since its thermal properties are well known. This calibration experiment is
350 based on the same procedure as for hydrate formation but without the gas injection step. The
351 integration of the DTA peak during ice melting is used to determine a calibration coefficient
352 C_{ice} . This coefficient is used to calculate the amount of energy consumed by hydrate
353 dissociation as follows:

$$E_{exp}(kJ) = |C_{ice} * A_{hyd}| \quad (1)$$

354 A_{hyd} represents the result of the integration of the DTA signal peak related to hydrate
355 dissociation. The mass of hydrates formed is computed using the experimental enthalpy
356 obtained by equation (1) and the theoretical enthalpy of gas hydrates ΔH_{hyd} known to be
357 equal to 500 kJ/kg_{water} (374 kJ/kg_{hydrates}) (Anderson, 2003; Fournaison et al., 2004):

$$m_{hyd}(kg) = \frac{E_{exp}}{\Delta H_{hyd}} \quad (2)$$

358 This equation does not take into account the variation over time of the difference in sensible
359 heat between the two cells. This variation only implies an error of approximately 2% on the
360 total amount of heat exchanged.

361 Water to hydrate conversion rate is computed from the following equation:

$$C_{wh} (\%) = \frac{m_{hyd} * n_h * M_{H_2O}}{\rho_{hyd} * m_{H_2O}} * 100 \quad (3)$$

362 Hydration number n_h used for the present study is 7.23 (Kang et al., 2001), ρ_{hyd} is the
363 density of CO₂ hydrate computed using the previous hydration number and m_{H_2O} is the mass
364 of water introduced initially in the porous media.

365 **3. Results and discussion**

366 The efficiency of cold storage system using gas hydrates is related not only to thermodynamic
367 equilibrium conditions, but also to gas hydrates formation and dissociation kinetics, and
368 ultimately to the amount of cold thermal energy that can be stored and released per volume
369 unit. In this study, the DTA apparatus described in the previous section was used to
370 investigate particularly the effect of key factors related to the geometric characteristics of
371 porous media and the operating conditions (water saturation, particle size and the morphology
372 of the porous media) on the following storage properties:

- 373 1) The mass of CO₂ hydrates formed in the porous media determined by measuring the
374 heat consumed during gas hydrate dissociation. It is of importance to identify the
375 factors that influence the amount of hydrate formed, and thus, the amount of energy
376 available in a cold storage system.
- 377 2) The induction **time** where no significant macroscopic changes are observed. It
378 corresponds to the period between the moment when the system reaches the CO₂
379 hydrates bulk Hydrate-Liquid-Vapor equilibrium conditions (Sloan and Koh, 2007)
380 (which are considered as reference equilibrium conditions) and the moment when a
381 rapid hydrate crystal growth is detected. The induction time is a significant index
382 when studying hydrate growth kinetics. It is well known in the literature that induction
383 time measurements can be relatively difficult due to the stochastic nature of hydrate

384 nucleation (Bishnoi and Natarajan, 1996; Dai et al., 2014; Lee et al., 2013). In
 385 addition, several studies showed the link between induction time and the driving force
 386 applied to the system (temperature driving force or supercooling, pressure driving
 387 force and mass-transfer driving force) (Davies et al., 2009; Kashchiev and
 388 Firoozabadi, 2002; Liu et al., 2015; Natarajan et al., 1994; Skovborg et al., 1993).
 389 However, the effect of other factors related to the characteristics of the porous media,
 390 like water saturation, particle size, or the presence of a mesoporous space are still
 391 poorly understood.

392 **3.1. Impact on amount of hydrates formed**

393 **3.1.1. Effect of water saturation**

394 The influence of water saturation on the mass of gas hydrates formed was first investigated
 395 based on a set of experiments on silica sand with various water saturation conditions and
 396 particle size. Table 3 summarizes the experimental conditions applied to this set of
 397 experiments and the final water to hydrate conversion (based on the fixed hydration number
 398 of CO₂ hydrate). Water content is defined as the mass of water by the mass of solid particles
 399 (sand grains or Silica gel particles) initially introduced in the cell.

400 Table 3: CO₂ hydrate formation and dissociation results in a sandy matrix for several water
 401 saturations and particle size

Run	Sample state*	Particle size (µm)	Water mass (g)	Water saturation (%)	Mass of Solid particles (g)	Water content	Mass of hydrates formed (g)	Water conversion to hydrate (%)
1	F	Non-sieved sand	5.78	33.4	59.58	0.10	3.17	41.2
2	F		9.00	52.0	59.57	0.15	3.39	28.1
3	F		11.05	59.9	56.60	0.19	3.20	21.8
4	F		11.32	63.7	58.37	0.19	1.87	12.5
5	M		11.32	63.7	58.37	0.19	2.27	14.9
6	F		13.10	75.2	59.31	0.22	2.16	12.3
7	F		17.45	100	59.36	0.29	No hydrate formation succeeded	
8	F	PS01	10.34	53.4	54.16	0.19	4.47	32.3
9	F	PS02	9.37	51.5	57.15	0.16	3.60	28.7
10	F	PS03	9.20	51.8	58.36	0.16	3.16	25.7

402 *F: fresh sample. M: memory sample. In the latter state. Run 5 represents a repeatability test for Run 4
403 (without changing the sample).

404 The influence of water saturation on the amount of hydrates formed is also represented in
405 Figure 7, with the mass of the hydrate formed and the rate of water to hydrate conversion as a
406 function of water saturation of non-sieved silica sand. It is interesting to note that the amount
407 of hydrates formed is not significantly different for water saturations ranging from 33 to
408 60 %. However, for higher water saturation (63 % and higher), the results show lower values
409 of the mass of hydrates formed. It is also interesting to note that the rates of water conversion
410 to hydrates are between 12 and 41 % and follow a decreasing tendency with the increase of
411 water saturation. This is due to the fact that in the measurement cell the formation of hydrates
412 takes place in a closed system after CO₂ injection. In fact, the gas first dissolves in water
413 under temperature conditions outside the hydrate stability zone. After reaching a stable
414 saturation, which corresponds to the same (P , T) conditions for all experiments, the system is
415 closed. Thus, knowing that the density of CO₂ in vapor phase is higher than the density of
416 CO₂ dissolved in liquid phase, the total amount of CO₂ in the system also decreases when
417 increasing water saturation (and so decreasing the volume of the vapor phase). After closing
418 the system, the temperature is decreased to form hydrates. With less CO₂ available in the
419 system, and more water, then less hydrate is formed, as confirmed by the results from a
420 previous solid fraction model based on an equilibrium balance on CO₂ in its different vapor,
421 dissolved in liquid and hydrate phases (Marinhas et al., 2007). It is interesting to note that
422 these mass balance results are in the same range of values as the present results from the
423 calorimetric approach as seen in Figure 7 with the open and full green diamonds.

424 Another aspect that must be taken into consideration when investigating the effect of water
425 saturation on gas hydrate formation is the spatial distribution of water in the porous volume.
426 Under high water saturation conditions, the distribution of liquid and vapor phases limits the
427 interfacial contact, and sometimes leads to the formation of hydrate plugs. This can prevent

428 the gas from accessing certain water zones in the pores. On the other hand, at low water
429 saturation, gas diffusion through the porous medium is facilitated due to a relatively larger
430 void volume.

431 For experiment 7 where silica sand is completely saturated with water ($S_w = 100\%$), the DTA
432 peak of hydrate formation was not detected and no pressure drop was observed despite a
433 relatively long experiment time (52 h). Indeed, the desired experimental pressure (2.5 MPa)
434 could not be reached within a reasonable time. This result suggests that with completely
435 saturated porous media, liquid-gas contact area through which CO_2 diffuses in water is
436 reduced. In addition, given that water occupies the total pore volume, the amount of CO_2
437 initially injected to reach the same experimental pressure conditions is reduced. Consequently,
438 hydrate formation is hindered.

439 Overall, **these** findings confirm the existence of a strong correlation between water saturation
440 and the amount of CO_2 hydrate formed, as it is reported in previous studies for CH_4 hydrates
441 in several porous media (Babu et al., 2013; Bagherzadeh et al., 2011; Ge et al., 2019; Kumar
442 et al., 2015; Pan et al., 2018). As the focus of this study is to appreciate optimal water
443 saturation conditions for an efficient cold storage system, the results demonstrate that a 50-
444 60 % water saturated system could be a suitable level to maximize the amount of energy
445 stored. **This optimal saturation value is slightly lower than the value usually used in the**
446 **literature to improve hydrate formation kinetics around 70 % (Ge et al., 2019; Mekala et al.,**
447 **2014).** However, further investigations should be carried out to study additional water
448 saturations. Moreover, a semi-batch configuration where CO_2 is continuously injected during
449 hydrate formation should be tested. Indeed, this gas-excess configuration could increase the
450 amount of hydrate formed and potentially the water to hydrate conversion rate. **These** results
451 also suggested that hydrate conversion rate could be influenced by the spatial distribution of

452 water in the pore volume. The latter is strongly related to the geometric characteristic of the
453 porous media, which will be discussed in the following section.

454 **3.1.2. Effect of particle size**

455 For the study of the effect of particle size on CO₂ hydrate formation and dissociation in
456 porous media, Fontainebleau Silica sand was sieved into 3 particle size classes: PS01, PS02
457 and PS03. Figure 8 shows the evolution of the formed hydrate mass and water to hydrate
458 conversion rates as a function of the particle size classes for a given water saturation around
459 52.2 % corresponding to runs 8 to 10 in Table 3. The pore volume for the particle size classes
460 being the same, the same quantity of water is used in the various sand samples. A clear
461 decreasing tendency of the amount of hydrate mass and hydrate conversion rate as a function
462 of the four particle size classes is observed. This pattern is due to the decrease of the specific
463 area resulting from the increase of particle size. Indeed, for a larger specific area (smaller
464 particle size) water is adsorbed on a larger surface area. This could potentially enhance the
465 liquid-gas contact area, which can improve gas hydrate formation. This suggests that CO₂
466 hydrate formation occurs preferentially at the solid-liquid interfaces of sand particles. It is
467 important to note that the mass of hydrates obtained within the non-sieved sand is close to the
468 amount within PS02 because this class represents 80 % of the non-sieved sand **Erreur !**
469 **Source du renvoi introuvable.** Alternatively, it is possible to assume that the fraction
470 leftover representing 10 % has no significant influence on the hydrate conversion rate.

471 These findings are consistent with some previous studies reported in the literature
472 (Bhattacharjee et al., 2015; Ge et al., 2019; Mekala et al., 2014; Qin et al., 2022) and
473 mentioned in the introduction section. However, other studies demonstrated an opposite result
474 (Adeyemo et al., 2010; Kumar et al., 2015; Lu et al., 2011; Pan et al., 2018). In this case, it
475 has been suggested, globally, that hydrates formed in smaller pores may obstruct gas diffusion
476 in the porous media. In their recent review Qin et al. (2021) also reported this inconsistency

477 between previous studies on the influence of particle size on hydrate formation. Indeed, the
478 authors suggested that this discrepancy in the results of the above-mentioned studies might be
479 due to the influence of other factors, such as the initial water saturation used in each study, the
480 composition of the gas phase, the specific surface area, or even the experimental system and
481 hydrate formation procedure used. Overall, further studies are needed, especially for CO₂
482 hydrates, considering the above-mentioned cross-factor effect to better understand the
483 mechanisms involved in order to determine the influence of particle size on gas hydrates
484 formation.

485 **3.1.3. Effect of the morphology**

486 In this section, results from the investigation of CO₂ hydrate formation and dissociation in two
487 morphologically different porous media, silica sand and silica gel, are reported. Fontainebleau
488 silica sand is considered as a uniform grain size structure (with only external porosity) and
489 silica gel as a dual porosity media (with internal and external porosity). The data of mass
490 hydrate formed and water to hydrate conversion rates are illustrated in Table 4. They are
491 presented for dual porous silica gel with two distinct pore size and compared with the results
492 obtained in Fontainebleau silica sand (detailed properties in the experimental section, Table
493 1).

494 For silica gel samples, three configurations of water saturation were tested:

- 495 1) Amount of water injected lower than the internal pore volume $V_w < V_p$ (Run 1 and 2)
- 496 2) Amount of water injected corresponding to the internal pore volume $V_w = V_p$ (Run 3,
497 4 and 6)
- 498 3) Amount of water injected greater than the pore volume $V_w > V_p$ (Run 5, 7 and 8); in
499 this case, it is assumed that the water occupies the entire internal pore volume, but also
500 a fraction of the interstitial space (external pore).

501 The water saturation of the internal pore volume of silica gel and of the interstitial space
502 are respectively denoted S_{w_p} and S_{w_i} .

503

Table 4: CO₂ hydrate formation and dissociation results in silica gel

Run	Pore size (nm)	Mass of water injected (g)	Water saturation of Pore volume Sw_p (%)	Water saturation of Interstitial space Sw_i (%)	Mass of solid particles (g)	Water content	Induction time (min)	Mass of hydrate formed (g)	Water to hydrate conversion rate (%)
1	100	5.93	53	0	15.99	0.37	No hydrate		
2		9.01	78	0	16.46	0.55	165	4.63	38.4
3		11.35	100	0	16.22	0.70	203	4.70	30.9
4		11.01	100	0	15.73	0.70	102	4.83	32.8
5		17.98	100	32	16.00	1.12	82	2.68	11.1
6	30	14.10	100	0	16.42	0.86	100	4.52	24.0
7		19.47	100	30	16.17	1.20	740	5.02	19.3
8		21.83	100	43	16.00	1.36	253	2.45	8.4

505 First, a comparison of hydrate formation and dissociation DTA signals obtained in both silica
506 sand and silica gel with close initial water mass is illustrated in Figure 9 (for clarity, DTA
507 peaks are overlapped). It should be noted that the DTA signal is a differential measurement
508 between the two cells, and as mentioned earlier in this paper, the reference cell contains the
509 same porous media as in the measurement cell for each experiment. Therefore, it can
510 reasonably perform a comparative analysis of the DTA peaks without considering the
511 difference in thermal conductivities of the two porous media (silica sand and silica gel). From
512 Figure 9, it is interesting to notice higher and larger exothermic and endothermic DTA signal
513 peaks for the experiments performed in silica gel compared to silica sand. This measurement
514 indicates a significant difference in thermal behavior between the test cell and the reference
515 cell in the case of silica gel compared to silica sand, thus, a greater amount of thermal energy
516 stored/released in the silica gel media compared to silica sand. These results suggest a strong
517 effect of the structural organization (morphology and water distribution) of the porous media
518 on heat transfer in the system. Moreover, DTA signals for the majority of experiments
519 performed in silica gel did not show a smaller second formation peak, except for one

520 experiment in 100 nm pore size silica gel (Run 3, 4). Whereas, all the experiments carried out
521 in silica sand showed a multiple nucleation phenomenon expressed by the presence of a
522 second DTA signal peak of very small intensity. It could be conceivably hypothesized that
523 this difference may be related to the shape of the particles. Indeed, silica gel particles have a
524 spherical shape compared to sand particles, which have rather irregular shapes. In the latter,
525 the morphology of the void space could be more heterogeneous compared to a silica gel
526 porous media. Thus, mass transfer could be affected by this heterogeneity, which can lead to
527 multiple nucleation loci at delayed times. The amount of hydrate formed under several water
528 saturation conditions of silica gel, and in the two distinct pore sizes, was then examined. The
529 results of hydrate mass formed and water to hydrate conversion rates are shown in Table 4
530 and Figure 10. Globally, it can be seen from Figure 10 that the hydrate mass in silica gel, as
531 well as water to hydrate conversion rates, are higher in comparison with silica sand. However,
532 this difference is not in the same order of magnitude as DTA signal peaks shown in Figure 9.
533 This is due to ice calibration (used to calculate the mass of hydrates formed) which is
534 different, depending on the system configuration. In addition, the results indicate that a
535 configuration of the system where water occupies only the pore volume of silica gel, water
536 content lower than 1, seems to be a good option to enhance the amount of hydrate formed.
537 This can be explained by the presence of a mesoporous volume in silica gel, which seems to
538 enhance gas and water contact. Indeed, water can be adsorbed at the surface of silica gel
539 inside the pores thanks to capillary forces, which leaves the interstitial space free for a better
540 diffusion of gas through the porous media. Regarding water to hydrate conversion rate, the
541 results show a decreasing tendency when the initial amount of water increase in the system.
542 As it is observed in silica sand, when the amount of water in silica gel increases, it results in a
543 decrease in the amount of CO₂ initially injected in the measurement cell of the DTA
544 apparatus. Furthermore, when the water content is higher than 1 in silica gel, that means the

545 water amount is sufficient to saturate not only the pore volume but also the interstitial space,
 546 the system configuration is closed to that obtained in silica sand and the amount of hydrate
 547 formed are comparable in some cases. In this case, the formation of the hydrate could be
 548 affected by the heterogeneous distribution of water and gas in the porous media. This can
 549 explain the decrease in the amount of hydrate formed observed with both pore size of silica
 550 gel (100 nm and 30 nm).

551 3.2. Impact on induction time

552 3.2.1. Effect of water saturation

553 The influence of water saturation on induction time was first investigated based on a set of
 554 experiments on silica sand with various water saturation conditions and particle size. Table 5
 555 summarizes the experimental conditions applied to this set of experiments.

556 Table 5: Induction time of CO₂ hydrate formation and dissociation results in a sandy matrix

Run	Particle size	Water saturation (%)	Induction time (min)	Driving force (% mol CO ₂ /mol H ₂ O)
1	Non-sieved sand	33.4	68	0.59
2		52.0	51	0.67
3		59.9	120	0.84
4		63.7	83	0.73
5		63.7	399	0.72
6		75.2	81	0.71
7		100	No hydrate formation succeeded -	
8	PS01	53.4	87	0.86
9	PS02	51.5	83	0.83
10	PS03	51.8	92	0.85

557 Figure 11a shows the induction time values obtained as a function of water saturation of the
 558 porous sample in the cell. To our knowledge, induction time data for CO₂ hydrates as a
 559 function of water saturation of the porous media are poorly known. **Some authors provided**
 560 **induction time data for CO₂ hydrate formation in different porous media but at a unique water**
 561 **saturation (Rehman et al., 2022; Sahu et al., 2022) and these data are added to figure 11a for**
 562 **comparison.** The induction time values are scattered and vary between 51 and 120 min for the

563 majority of the experiments **except for Sahu et al. (2022)**. They showed an important
564 **induction time of 2083.8 min within a silica sand of 0.15 mm particle diameter at 70 % water**
565 **saturation**. The induction time dispersion may be due to several key factors such as the
566 configuration of the experimental **system (reactor type and design, the internal volume,**
567 **operating conditions, driving force...)**. There are therefore biases of interpretation when
568 different works are compared. A slight increase of induction time can be observed when water
569 saturation of silica sand increases. However, for the repeated experiment at 63.7 % water
570 saturation (Run 5, 5) (For this experiment, the sample was left about **210 min** at 285 K before
571 restarting the cooling process), it can be noted a considerable difference in the induction time
572 compared to the rest of the experiments. This discrepancy in induction time may be related to
573 a heterogeneous redistribution of the water within the porous media after hydrate dissociation.
574 Indeed, the CO₂ hydrate formation experiments in this study are performed for an
575 experimental temperature of 271.15 K and under pressure conditions around 2.5 MPa.
576 Figure 11b shows the results of induction time as a function of the driving force. The latter is
577 calculated using the method reported by Boufares et al. (2018). This method consists of
578 estimating the CO₂ concentration in the liquid phase at Hydrate-Liquid-Vapor Equilibrium
579 pressure corresponding to the experimental temperature (the super-saturation). It is interesting
580 to note from Figure 11b that a slight increase of the driving force does not have a significant
581 influence on induction time. The latter increases slightly but remains in a narrow range.

582 Overall, **these results** show that water saturation has small effect on induction time. The
583 discrepancies observed may also be due to the stochastic nature of hydrate nucleation.
584 However, given that **these** findings are based on a limited number of experiences, this analysis
585 should thus be treated with considerable caution.

3.2.2. Effect of particle size

According to literature, pore size is one of the main parameters determining hydrate formation kinetic in porous media (Borchardt et al., 2016; Nguyen et al., 2020). The results in Table 5 showed that the induction time values at which CO₂ hydrate formation is detected for the 3-particle size classes are relatively homogeneous with an average value of 87±5 min. They present a difference of 35±5 min compared to the induction time obtained for non-sieved silica sand as shown on Figure 11b. Overall, it is difficult to establish from these results an obvious correlation between induction time and particle size of silica sand. The results reported in the literature seem to diverge regarding the effect of particle size on induction time. As observed by Qin et al. (2021), some studies demonstrated a positive effect of small particle size on shortening the induction time (Heeschen et al., 2016; Zhang et al., 2018). This may be due to a larger nucleation area when decreasing particle size. However, other studies found an opposite effect even though a similar particle size and porous media were used (Liu et al., 2015; Qin et al., 2021). Qin et al. (2021) suggested that the reason for this divergence is related to the fact that induction time is strongly affected by many other factors like: (1) the experimental method used to form hydrate, (2) the geometry of the experimental device, (3) the type of hydrate formed, etc. This could also explain the results obtained in this study.

3.2.3. Effect of the morphology

In this section, results related to the investigation of induction time according to different operating conditions: pore size, water saturation of silica gel pore volume and interstitial space and driving force were reported in Table 6.

Table 6: Operating conditions and results obtained from the experiments of CO₂ hydrate formation and dissociation in silica gel

Run	Pore size (nm)	Mass of water injected (g)	Water saturation of Pore volume	Water saturation of Interstitial space S_{wi}	Induction time (min)	Driving force (% mol CO ₂ /mol H ₂ O)
-----	----------------	----------------------------	---------------------------------	---	----------------------	---

			S_{wp} (%)	(%)		
1	100	5.93	53	0	No hydrate	
2		9.01	78	0	165	0.50
3		11.35	100	0	203	0.80
4		11.01	100	0	102	0.89
5		17.98	100	32	82	0.77
6	30	14.10	100	0	100	0.77
7		19.47	100	30	740	0.92
8		21.83	100	43	253	0.78

609 It is well known that the driving force, necessary to initiate the formation of hydrates in silica
610 gels, increases when the pore sizes decrease because the thermodynamic equilibrium
611 conditions are more difficult to reach. Therefore, at constant driving force, when the pore
612 sizes decrease the induction time must increase. This can be seen in Figure 11b where for a
613 driving force around 0.8 %mol CO₂/molH₂O, the induction time increases up to 25 % in
614 30 nm silica gels compared to 100 nm. Figure 12 gathers the result obtained for silica gel and
615 silica sand as a function of the initial water content introduced in the porous media. It can be
616 seen that induction time values for the experiments performed in silica gel are quite scattered
617 between 82 and 235 min. A significant difference in the induction times was noted in the case
618 of silica gel with an internal pore size of 30 nm, and a water saturation of the pore volume and
619 the interstitial space (Run 7, ≈740 min). In addition, it can notice that for a similar initial
620 water content, the induction time values obtained for silica gel are close, and slightly higher in
621 some cases, than those obtained in Fontainebleau silica sand. For high water content,
622 particularly in the case of 30 nm pore (Run 7 and 8) size silica gel, the induction time values
623 are higher than in the case of low water content (Run 6). Knowing that for these two
624 particular experiments, water occupies both the pore volume and the interstitial space, this
625 points to the hypothesis that water-gas contact is hindered by the presence of water in the
626 interstitial space.

627 Consequently, it is difficult to draw conclusions, given that hydrate nucleation is a stochastic
628 process. Furthermore, when water saturates partially the pore volume ($S_{wp} = 53\%$) which
629 corresponds to an initial water content of 0.37 (correspond to an initial water mass of 6 g)
630 (Run 1), gas hydrate formation was not detected (no DTA signal related to hydrate formation,
631 and no pressure and temperature variation). This may be due to the adsorption of water on the
632 internal pore surface of silica gel, which makes the amount of free water not sufficient for
633 hydrate formation.

634 **4. Conclusion**

635 In an effort to provide new insights on the influence of key factors related to the use of porous
636 media on CO₂ hydrates formation and dissociation processes, with a differential thermal
637 analysis (DTA) approach, the effect of water saturation, particle size and the morphology of
638 the porous media on induction time, storage capacity and equilibrium conditions on the solid
639 mass fraction formed and the induction time was investigated:

- 640 • First, water distribution in a silica sand sample was investigated using X-ray micro-
641 tomography. The analysis of two volume portions taken from the total volume of the
642 30 %-water saturated silica sand sample allows us to reasonably state that the sample
643 preparation method used in this study provides a rather homogeneous distribution of
644 water over the total sample volume.
- 645 • For water saturation, the analysis of the results obtained with silica sand did not reveal
646 a noteworthy effect on the induction time. Furthermore, when water saturation
647 increases in a closed system and for the same initial pressure condition, the amount of
648 CO₂ initially injected in the cell decreases, which results in a lower mass of hydrates
649 formed, and thus, a lower water to hydrate conversion rates.
- 650 • For particle size, within silica sand, it has shown that this factor does not influence the
651 induction time, whereas, the results indicated a strong effect on the amount of hydrate

652 formed. Indeed, for a smaller particle size, liquid-gas contact area is enhanced due to
653 water adsorption on a larger surface area. This can potentially enhance the amount of
654 hydrate formed.

655 • Finally, this study investigated the influence of the morphology of the porous medium
656 on hydrate formation and dissociation by using silica sand and spherical **dual porous**
657 silica gel. Overall, the results showed a higher amount of thermal energy stored by
658 hydrates formed in silica gel compared to Fontainebleau silica sand. Moreover, a
659 configuration where water occupies only the pore volume of silica gel was found to be
660 optimal. In addition, an inhibiting effect on the thermodynamic condition of hydrate
661 stability was observed. It is well known in the literature that this effect becomes much
662 more significant as pore size of silica gel particles decreases.

663 **These results showed relatively clear correlations between the factors studied and the fraction**
664 **of hydrates formed. However, the influence of these factors on the induction time is not**
665 **obvious. This may be due to coupling problems between these different factors, but also to the**
666 **lack of information on other factors such as wettability, which would deserve to be studied in**
667 **depth.** Due to the complexity of the characterization of gas hydrates induction time and the
668 stochastic nature of hydrate nucleation, this study **also** requires a detailed statistical analysis
669 with several replicate experiments. Overall, these findings add to a growing body of literature
670 on the link between hydrate formation and dissociation process and the key factors related to
671 the porous media. Despite this, **the** calorimetry work carried out in this study could be the
672 basis for further sets of experiments in order to clearly identify optimal conditions for energy
673 efficient CO₂ hydrate-based technologies such as cold storage systems.

674 **CRedit authorship contribution statement**

675 **Fatima Doria Benmesbah:** Methodology, Software, Investigation, Data curation, Writing –
676 original draft, Visualization. **Pascal Clain:** Supervision, Validation, Visualization, Writing -

677 review & editing. **Olivia Fandino:** Supervision. **Veronique Osswald:** Validation,
678 Visualization. **Laurence Fournaison:** Supervision, **Christophe Dicharry:** Resources,
679 Methodology, Writing - review & editing. **Livio Ruffine:** Project administration, Resources,
680 Supervision, Validation, Writing - review & editing. **Anthony Delahaye:** Project
681 administration, Supervision, Validation, Visualization, Writing - review & editing.

682

683 **Declaration of Competing Interest**

684 The authors declare that they have no known competing financial interests or personal
685 relationships that could have appeared to influence the work reported in this paper.

686 **Acknowledgment**

687 The authors would like to thank Fatou-Toutie Ndoye and Graciela Alvarez Leguizamo,
688 researchers at Université Paris-Saclay, FRISE, INRAE, for their technical support, advice and
689 guidance with the X-ray microtomography device. We are also grateful to Elyamin Dahmana,
690 for his direct technical help on CO₂ hydrates formation and dissociation experiments using the
691 DTA device. The authors also acknowledge anonymous reviewers for their valuable
692 suggestions and remarks.

693 **5. References**

694 Adeyemo, A., 2008. Post combustion capture of carbon dioxide through hydrate formation in silica
695 gel column.
696 Adeyemo, A., Kumar, R., Linga, P., Ripmeester, J., Englezos, P., 2010. Capture of carbon dioxide from
697 flue or fuel gas mixtures by clathrate crystallization in a silica gel column. *International Journal of*
698 *Greenhouse Gas Control* 4, 478-485.
699 Akbari, H., Mertol, A., 1989. Thermal Energy Storage for Cooling of Commercial Buildings, in: Kilkis,
700 B., Kakaç, S. (Eds.), *Energy Storage Systems*. Springer Netherlands, Dordrecht, pp. 315–347.
701 Anderson, G.K., 2003. Enthalpy of dissociation and hydration number of carbon dioxide hydrate from
702 the Clapeyron equation. *The Journal of Chemical Thermodynamics* 35, 1171-1183.
703 Babu, P., Kumar, R., Linga, P., 2013. Medium pressure hydrate based gas separation (HBGS) process
704 for pre-combustion capture of carbon dioxide employing a novel fixed bed reactor. *International*
705 *Journal of Greenhouse Gas Control* 17, 206-214.
706 Bagherzadeh, S.A., Moudrakovski, I.L., Ripmeester, J.A., Englezos, P., 2011. Magnetic Resonance
707 Imaging of Gas Hydrate Formation in a Bed of Silica Sand Particles. *Energy & Fuels* 25, 3083-3092.

708 Bhattacharjee, G., Kumar, A., Sakpal, T., Kumar, R., 2015. Carbon Dioxide Sequestration: Influence of
709 Porous Media on Hydrate Formation Kinetics. *ACS Sustainable Chemistry & Engineering* 3, 1205-
710 1214.

711 Bishnoi, P.R., Natarajan, V., 1996. Formation and decomposition of gas hydrates. *Fluid Phase*
712 *Equilibria* 117, 168-177.

713 Borchardt, L., Nickel, W., Casco, M., Senkovska, I., Bon, V., Wallacher, D., Grimm, N., Krause, S.,
714 Silvestre-Albero, J., 2016. Illuminating solid gas storage in confined spaces – methane hydrate
715 formation in porous model carbons. *Physical Chemistry Chemical Physics* 18, 20607-20614.

716 Boufares, A., Provost, E., Dalmazzone, D., Osswald, V., Clain, P., Delahaye, A., Fournaison, L., 2018.
717 Kinetic study of CO₂ hydrates crystallization: Characterization using FTIR/ATR spectroscopy and
718 contribution modeling of equilibrium/non-equilibrium phase-behavior. *Chemical Engineering Science*
719 192, 371-379.

720 Chami, N., Bendjenni, S., Clain, P., Osswald, V., Delahaye, A., Fournaison, L., Dalmazzone, D., 2021.
721 Thermodynamic characterization of mixed gas hydrates in the presence of cyclopentane as guest
722 molecule for an application in secondary refrigeration. *Chemical Engineering Science* 244, 116790.

723 Cheng, C., Wang, F., Tian, Y., Wu, X., Zheng, J., Zhang, J., Li, L., Yang, P., Zhao, J., 2020. Review and
724 prospects of hydrate cold storage technology. *Renewable and Sustainable Energy Reviews* 117,
725 109492.

726 Chong, Z.R., Yang, M., Khoo, B.C., Linga, P., 2016. Size Effect of Porous Media on Methane Hydrate
727 Formation and Dissociation in an Excess Gas Environment. *Industrial & Engineering Chemistry*
728 *Research* 55, 7981-7991.

729 Clain, P., 2014. Couplage entre le stockage et distribution de froid par coulis d'hydrates. Sorbonne
730 Université, Paris.

731 Dai, S., Lee, J.Y., Santamarina, J.C., 2014. Hydrate nucleation in quiescent and dynamic conditions.
732 *Fluid Phase Equilibria* 378, 107-112.

733 Darbouret, M., Cournil, M., Herri, J.-M., 2005. Rheological study of TBAB hydrate slurries as
734 secondary two-phase refrigerants. *International Journal of Refrigeration* 28, 663-671.

735 Davies, S.R., Hester, K.C., Lachance, J.W., Koh, C.A., Dendy Sloan, E., 2009. Studies of hydrate
736 nucleation with high pressure differential scanning calorimetry. *Chemical Engineering Science* 64,
737 370-375.

738 Delahaye, A., Fournaison, L., Dalmazzone, D., 2018. Use of Hydrates for Cold Storage and Distribution
739 in Refrigeration and Air-Conditioning Applications, *Gas Hydrates 2*. John Wiley & Sons, Ltd, pp. 315-
740 358.

741 Delahaye, A., Fournaison, L., Marinha, S., Martínez, M.C., 2008. Rheological study of CO₂ hydrate
742 slurry in a dynamic loop applied to secondary refrigeration. *Chemical Engineering Science* 63, 3551-
743 3559.

744 Dicharry, C., Duchateau, C., Asbaï, H., Broseta, D., Torrè, J.-P., 2013. Carbon dioxide gas hydrate
745 crystallization in porous silica gel particles partially saturated with a surfactant solution. *Chemical*
746 *Engineering Science* 98, 88-97.

747 Dufour, T., Hoang, H.M., Oignet, J., Osswald, V., Clain, P., Fournaison, L., Delahaye, A., 2017. Impact
748 of pressure on the dynamic behavior of CO₂ hydrate slurry in a stirred tank reactor applied to cold
749 thermal energy storage. *Applied Energy* 204, 641-652.

750 Englezos, P., 1993. Clathrate hydrates. *Industrial & Engineering Chemistry Research* 32, 1251-1274.

751 Englezos, P., Kalogerakis, N., Dholabhai, P.D., Bishnoi, P.R., 1987. Kinetics of formation of methane
752 and ethane gas hydrates. *Chemical Engineering Science* 42, 2647-2658.

753 Fitzgerald, G.C., Castaldi, M.J., Schicks, J.M., 2014. Methane Hydrate Formation and Thermal Based
754 Dissociation Behavior in Silica Glass Bead Porous Media. *Industrial & Engineering Chemistry Research*
755 53, 6840-6854.

756 Fournaison, L., Delahaye, A., Chatti, I., Petitet, J.-P., 2004. CO₂ Hydrates in Refrigeration Processes.
757 *Industrial & Engineering Chemistry Research* 43, 6521-6526.

758 Ge, B.-B., Zhong, D.-L., Lu, Y.-Y., 2019. Influence of water saturation and particle size on methane
759 hydrate formation and dissociation in a fixed bed of silica sand. *Energy Procedia* 158, 5402-5407.

760 Gupta, A., Lachance, J., Sloan, E.D., Koh, C.A., 2008. Measurements of methane hydrate heat of
761 dissociation using high pressure differential scanning calorimetry. *Chemical Engineering Science* 63,
762 5848-5853.

763 Handa, Y.P., Stupin, D.Y., 1992. Thermodynamic properties and dissociation characteristics of
764 methane and propane hydrates in 70-Å-radius silica gel pores. *The Journal of Physical Chemistry*
765 96, 8599-8603.

766 Hasnain, S.M., 1998. Review on sustainable thermal energy storage technologies, Part II: cool
767 thermal storage. *Energy Conversion and Management* 39, 1139-1153.

768 Heeschen, K.U., Schicks, J.M., Oeltzschner, G., 2016. The promoting effect of natural sand on
769 methane hydrate formation: Grain sizes and mineral composition. *Fuel* 181, 139-147.

770 Jerbi, S., Delahaye, A., Fournaison, L., Haberschill, P., 2010. Characterization of CO₂ hydrate
771 formation and dissociation kinetics in a flow loop. *International Journal of Refrigeration* 33, 1625-
772 1631.

773 Joshi, A., Sangwai, J.S., Das, K., Sami, N.A., 2013. Experimental investigations on the phase
774 equilibrium of semiclathrate hydrates of carbon dioxide in TBAB with small amount of surfactant.
775 *International Journal of Energy and Environmental Engineering* 4, 11.

776 Kang, S.-P., Lee, H., Ryu, B.J., 2001. Enthalpies of dissociation of clathrate hydrates of carbon dioxide,
777 nitrogen, (carbon dioxide + nitrogen), and (carbon dioxide + nitrogen + tetrahydrofuran). *The Journal*
778 *of Chemical Thermodynamics* 33, 513-521.

779 Kang, S.-P., Lee, J.-W., Ryu, H.-J., 2008. Phase behavior of methane and carbon dioxide hydrates in
780 meso- and macro-sized porous media. *Fluid Phase Equilibria* 274, 68-72.

781 Kang, S.-P., Lee, J., Seo, Y., 2013. Pre-combustion capture of CO₂ by gas hydrate formation in silica
782 gel pore structure. *Chemical Engineering Journal* 218, 126-132.

783 Kashchiev, D., Firoozabadi, A., 2002. Nucleation of gas hydrates. *Journal of Crystal Growth* 243, 476-
784 489.

785 Kumar, A., Khatri, D., Lee, J.D., Kumar, R., 2016. Crystallization kinetics for carbon dioxide gas hydrate
786 in fixed bed and stirred tank reactor. *Korean Journal of Chemical Engineering* 33, 1922-1930.

787 Kumar, A., Sakpal, T., Linga, P., Kumar, R., 2013. Influence of contact medium and surfactants on
788 carbon dioxide clathrate hydrate kinetics. *Fuel* 105, 664-671.

789 Kumar, A., Sakpal, T., Roy, S., Kumar, R., 2015. Methane hydrate formation in a test sediment of sand
790 and clay at various levels of water saturation. *Canadian Journal of Chemistry* 93, 874-881.

791 Laugier, F., Andriantsiferana, C., Wilhelm, A.M., Delmas, H., 2008. Ultrasound in gas-liquid systems:
792 Effects on solubility and mass transfer. *Ultrasonics Sonochemistry* 15, 965-972.

793 Lee, K., Lee, S.-H., Lee, W., 2013. Stochastic nature of carbon dioxide hydrate induction times in Na-
794 montmorillonite and marine sediment suspensions. *International Journal of Greenhouse Gas Control*
795 14, 15-24.

796 Li, G., Hwang, Y., Radermacher, R., 2012. Review of cold storage materials for air conditioning
797 application. *International Journal of Refrigeration* 35, 2053-2077.

798 Lieveois, J.S., Perkins, R., Martin, R.J., Kobayashi, R., 1990. Development of an automated, high
799 pressure heat flux calorimeter and its application to measure the heat of dissociation and hydrate
800 numbers of methane hydrate. *Fluid Phase Equilibria* 59, 73-97.

801 Lin, W., Dalmazzone, D., Fürst, W., Delahaye, A., Fournaison, L., Clain, P., 2014. Thermodynamic
802 properties of semiclathrate hydrates formed from the TBAB+TBPB+water and
803 CO₂+TBAB+TBPB+water systems. *Fluid Phase Equilibria* 372, 63-68.

804 Linga, P., Clarke, M.A., 2017. A Review of Reactor Designs and Materials Employed for Increasing the
805 Rate of Gas Hydrate Formation. *Energy & Fuels* 31, 1-13.

806 Linga, P., Daraboina, N., Ripmeester, J.A., Englezos, P., 2012. Enhanced rate of gas hydrate formation
807 in a fixed bed column filled with sand compared to a stirred vessel. *Chemical Engineering Science* 68,
808 617-623.

809 Linga, P., Haligva, C., Nam, S.C., Ripmeester, J.A., Englezos, P., 2009. Gas Hydrate Formation in a
810 Variable Volume Bed of Silica Sand Particles. *Energy & Fuels* 23, 5496-5507.

811 Linga, P., Kumar, R., Lee, J.D., Ripmeester, J., Englezos, P., 2010. A new apparatus to enhance the rate
812 of gas hydrate formation: Application to capture of carbon dioxide. *International Journal of*
813 *Greenhouse Gas Control* 4, 630-637.

814 Liu, W., Wang, S., Yang, M., Song, Y., Wang, S., Zhao, J., 2015. Investigation of the induction time for
815 THF hydrate formation in porous media. *Journal of Natural Gas Science and Engineering* 24, 357-364.

816 Loveday, J.S., Nelmes, R.J., 2008. High-pressure gas hydrates. *Phys. Chem. Chem. Phys.* 10, 937-950.

817 Lu, H., Kawasaki, T., Ukita, T., Moudrakovski, I., Fujii, T., Noguchi, S., Shimada, T., Nakamizu, M.,
818 Ripmeester, J., Ratcliffe, C., 2011. Particle size effect on the saturation of methane hydrate in
819 sediments – Constrained from experimental results. *Marine and Petroleum Geology* 28, 1801-1805.

820 Malagar, B.R.C., Lijith, K.P., Singh, D.N., 2019. Formation & dissociation of methane gas hydrates in
821 sediments: A critical review. *Journal of Natural Gas Science and Engineering* 65, 168-184.

822 Marinhas, S., Delahaye, A., Fournaison, L., 2007. Solid fraction modelling for CO₂ and CO₂-THF
823 hydrate slurries used as secondary refrigerants. *International Journal of Refrigeration* 30, 758-766.

824 Martínez, M.C., Dalmazzone, D., Fürst, W., Delahaye, A., Fournaison, L., 2008. Thermodynamic
825 properties of THF + CO₂ hydrates in relation with refrigeration applications. *AIChE Journal* 54, 1088-
826 1095.

827 Mekala, P., Busch, M., Mech, D., Patel, R.S., Sangwai, J.S., 2014. Effect of silica sand size on the
828 formation kinetics of CO₂ hydrate in porous media in the presence of pure water and seawater
829 relevant for CO₂ sequestration. *Journal of Petroleum Science and Engineering* 122, 1-9.

830 Natarajan, V., Bishnoi, P.R., Kalogerakis, N., 1994. Induction phenomena in gas hydrate nucleation.
831 *Chemical Engineering Science* 49, 2075-2087.

832 Nguyen, N.N., Galib, M., Nguyen, A.V., 2020. Critical Review on Gas Hydrate Formation at Solid
833 Surfaces and in Confined Spaces—Why and How Does Interfacial Regime Matter? *Energy & Fuels* 34,
834 6751-6760.

835 Oya, S., Aifaa, M., Ohmura, R., 2017. Formation, growth and sintering of CO₂ hydrate crystals in
836 liquid water with continuous CO₂ supply: Implication for subsurface CO₂ sequestration. *International*
837 *Journal of Greenhouse Gas Control* 63, 386-391.

838 Pan, Z., Liu, Z., Zhang, Z., Shang, L., Ma, S., 2018. Effect of silica sand size and saturation on methane
839 hydrate formation in the presence of SDS. *Journal of Natural Gas Science and Engineering* 56, 266-
840 280.

841 Park, J., Seo, Y.-T., Lee, J.-w., Lee, H., 2006. Spectroscopic analysis of carbon dioxide and nitrogen
842 mixed gas hydrates in silica gel for CO₂ separation. *Catalysis Today* 115, 279-282.

843 Prah, B., Yun, R., 2018. CO₂ hydrate slurry transportation in carbon capture and storage. *Applied*
844 *Thermal Engineering* 128, 653-661.

845 Qin, Y., Bao, R., Shang, L., Zhou, L., Meng, L., Zang, C., Sun, X., 2022. Effects of Particle Size and Types
846 of Porous Media on the Formation and Occurrence of Methane Hydrate in Complex Systems. *Energy*
847 *& Fuels* 36, 655-668.

848 Qin, Y., Pan, Z., Liu, Z., Shang, L., Zhou, L., 2021. Influence of the Particle Size of Porous Media on the
849 Formation of Natural Gas Hydrate: A Review. *Energy & Fuels* 35, 11640-11664.

850 Rehman, A.N., Lal, B., Pendyala, R., Yusoff, M.H.M., 2022. Unusual CO₂ hydrate formation in porous
851 media: Implications on geo-CO₂ storage laboratory testing methods. *Materials Today: Proceedings*
852 57, 1363-1368.

853 Sahu, C., Sircar, A., Sangwai, J.S., Kumar, R., 2022. Effect of sodium tripolyphosphate (STPP) and
854 tetrasodium pyrophosphate (TSPP) on the formation kinetics of CO₂ hydrate in bulk and porous
855 media in the presence of pure water and seawater relevant for CO₂ sequestration. *International*
856 *Journal of Greenhouse Gas Control* 114, 103564.

857 Shindo, Y., Lund, P.C., Fujioka, Y., Komiyama, H., 1993. Kinetics and mechanism of the formation of
858 CO₂ hydrate. *International Journal of Chemical Kinetics* 25, 777-782.

859 Skovborg, P., Ng, H.J., Rasmussen, P., Mohn, U., 1993. Measurement of induction times for the
860 formation of methane and ethane gas hydrates. *Chemical Engineering Science* 48, 445-453.

861 Sloan, E.D., 1998. Physical/chemical properties of gas hydrates and application to world margin
862 stability and climatic change. *Geological Society, London, Special Publications* 137, 31–50.

863 Sloan, E.D., Fleyfel, F., 1992. Hydrate dissociation enthalpy and guest size. *Fluid Phase Equilibria* 76,
864 123-140.

865 Sloan, E.D., Koh, C.A., 2007. *Clathrate Hydrates of Natural Gases*, 3rd edition ed. CRC Press, Boca
866 Raton.

867 Smith, D.H., Wilder, J.W., Seshadri, K., 2002. Thermodynamics of Carbon Dioxide Hydrate Formation
868 in Media with Broad Pore-Size Distributions. *Environmental Science & Technology* 36, 5192-5198.

869 Torr , J.-P., Dicharry, C., Ricaurte, M., Daniel-David, D., Broseta, D., 2011. CO2 capture by hydrate
870 formation in quiescent conditions: In search of efficient kinetic additives. *Energy Procedia* 4, 621-628.

871 Turner, D.J., Cherry, R.S., Sloan, E.D., 2005. Sensitivity of methane hydrate phase equilibria to
872 sediment pore size. *Fluid Phase Equilibria* 228-229, 505-510.

873 Uchida, T., Ebinuma, T., Takeya, S., Nagao, J., Narita, H., 2002. Effects of Pore Sizes on Dissociation
874 Temperatures and Pressures of Methane, Carbon Dioxide, and Propane Hydrates in Porous Media.
875 *The Journal of Physical Chemistry B* 106, 820-826.

876 Wang, J., Zhang, L., Ge, K., Dong, H., 2021. Capillary pressure in the anisotropy of sediments with
877 hydrate formation. *Fuel* 289, 119938.

878 Wang, X., Dennis, M., 2017. Thermal energy harvest in the discharge of CO2 semi-clathrate hydrate in
879 an emulated cold storage system. *Applied Thermal Engineering* 124, 725-733.

880 Wang, X., Dennis, M., Hou, L., 2014. Clathrate hydrate technology for cold storage in air conditioning
881 systems. *Renewable and Sustainable Energy Reviews* 36, 34-51.

882 Wang, X., Zhang, F., Lipiński, W., 2020. Carbon dioxide hydrates for cold thermal energy storage: A
883 review. *Solar Energy* 211, 11-30.

884 Wang, Z., Li, F., Fan, T., Xiong, W., Yang, B., 2015. Research on the Application of Gas Hydrate in Cool
885 Storage Air Conditioning. *Procedia Engineering* 121, 1118-1125.

886 Yang, M., Song, Y., Jiang, L., Liu, Y., Wang, X., 2015. Behaviour of hydrate-based technology for
887 H2/CO2 separation in glass beads. *Separation and Purification Technology* 141, 170-178.

888 Yang, M., Song, Y., Ruan, X., Liu, Y., Zhao, J., Li, Q., 2012. Characteristics of CO2 Hydrate Formation
889 and Dissociation in Glass Beads and Silica Gel. *Energies* 5, 925-937.

890 Zhang, B., Zhou, L., Liu, C., Zhang, Q., Wu, Q., Wu, Q., Liu, C., 2018. Influence of sediment media with
891 different particle sizes on the nucleation of gas hydrate. *Natural Gas Industry B* 5, 652-659.

892 Zhang, F., Wang, X., Wang, B., Lou, X., Lipiński, W., 2022. Effects of silica gel nanopores and
893 surfactants on CO2 hydrate formation kinetics—An experimental and modeling study. *Chemical
894 Engineering Science* 262, 118002.

895 Zhang, X., Li, J., Wu, Q., Wang, C., Nan, J., 2015. Experimental study on the effect of pore size on
896 carbon dioxide hydrate formation and storage in porous media. *Journal of Natural Gas Science and
897 Engineering* 25, 297-302.

898 Zhang, Y., Li, X.-S., Chen, Z.-Y., Li, G., Wang, Y., 2016. Effects of particle and pore sizes on the
899 formation behaviors of methane hydrate in porous silica gels. *Journal of Natural Gas Science and
900 Engineering* 35, 1463-1471.

901 Zhang, Y., Li, X., Chen, Z., Xia, Z., Wang, Y., Li, G., 2017. Formation Behavior and Controlling Factor of
902 Methane Hydrate in Porous Media. *Energy Procedia* 142, 4044-4049.

903

904

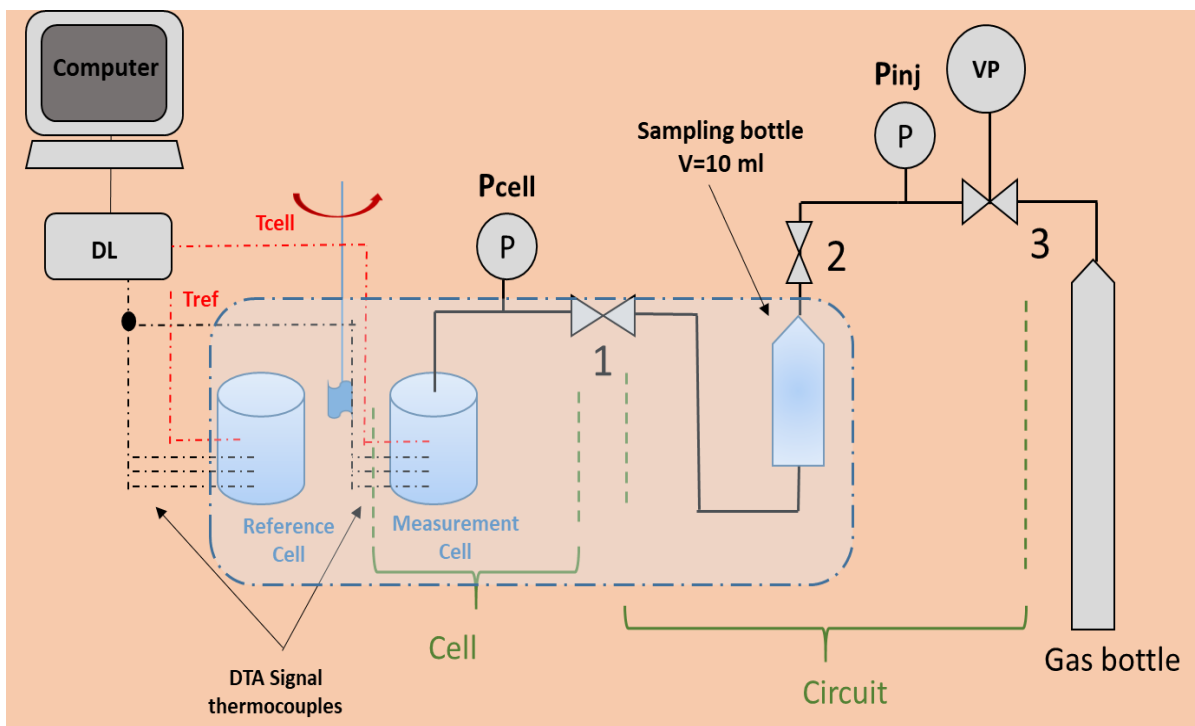
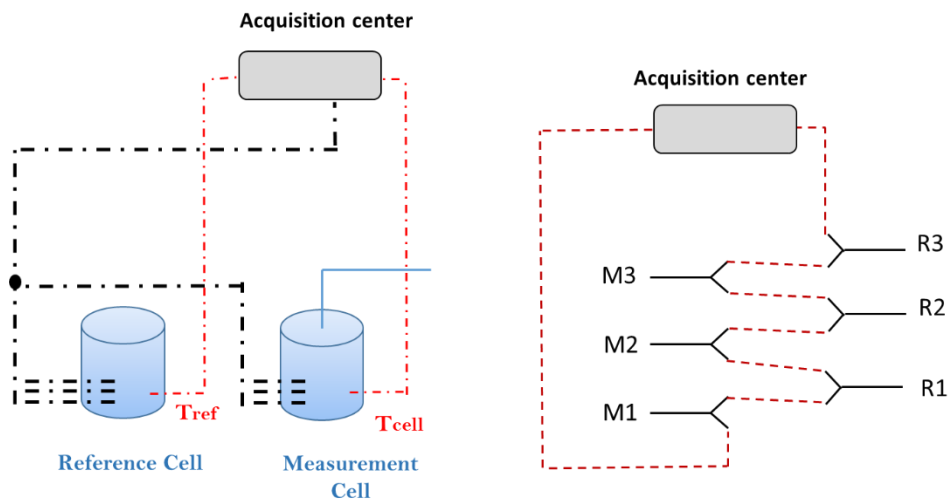

Figure 1: Schematic diagram of the DTA experimental apparatus. (DL) Data logger, (P) Pressure transducer, (T_{cell} , T_{ref}) Thermocouple to measure direct temperature, (VP) Vacuum pump, the blue area corresponds to a temperature-controlled bath in which the two cells are immersed, as well as the sampling cylinder

905

906



907

908 Figure 2: Diagram of the six thermocouples connected in series to obtain the DTA signal. M1,
 909 M2 and M3 correspond to the thermocouples placed in the measuring cell. R1, R2 and R3
 910 correspond to the thermocouples placed in the reference cell

911

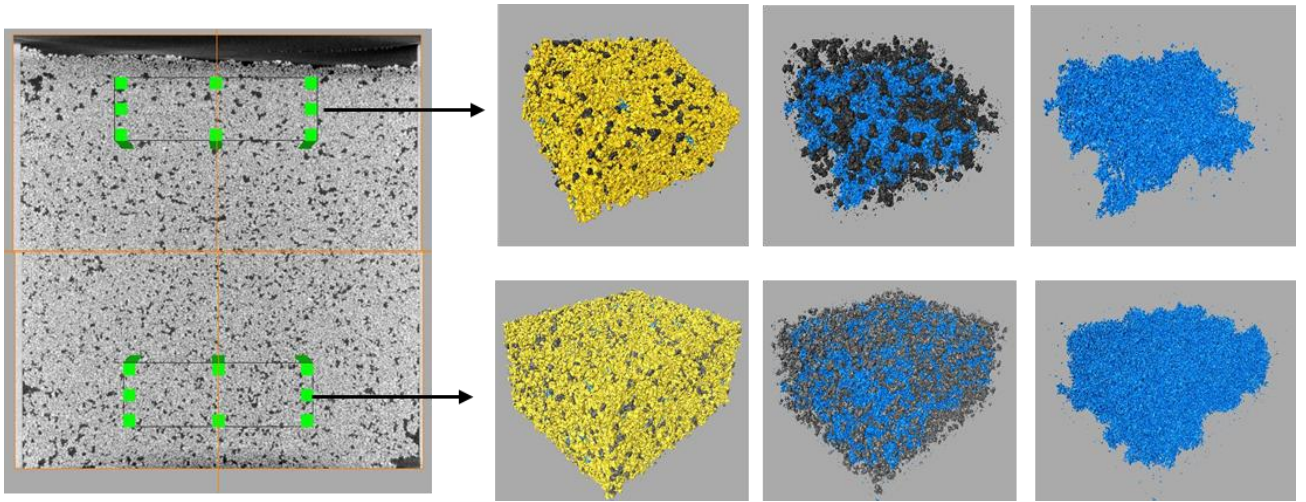
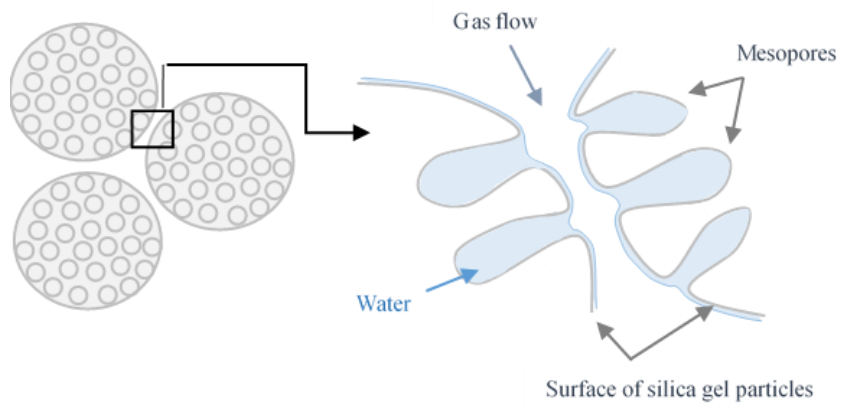

Figure 3: CT scan analysis of a sand sample for a water saturation of 66%. Sand is represented in yellow, water in blue and air in dark grey.

912

913



914 Figure 4: Schematic illustration of water occupying the mesoporous volume of silica gel
915 particles

916

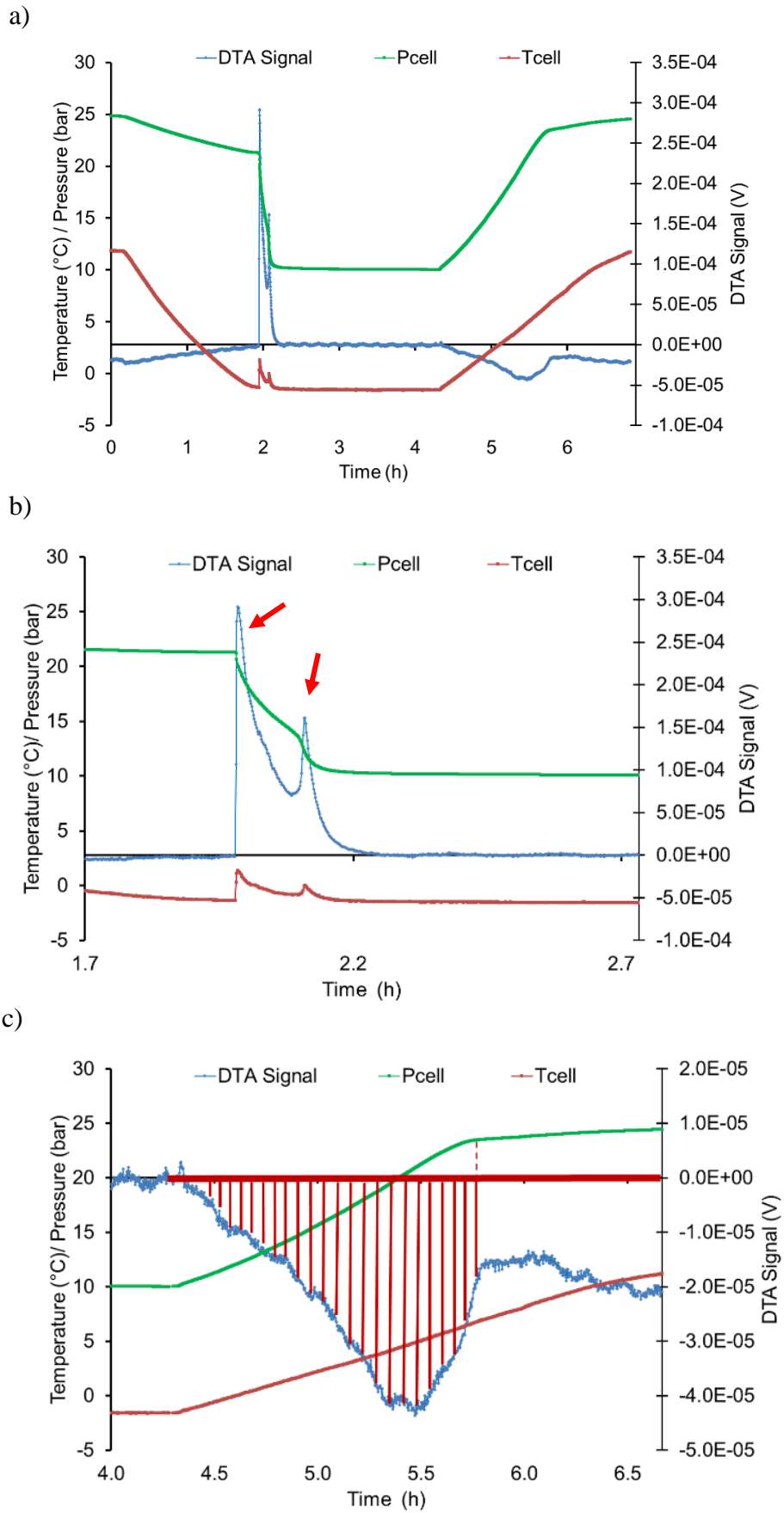

Figure 5: a) Temperature, pressure and DTA signal profiles during CO₂ hydrate formation and dissociation in silica sand at 33 % water

saturation. Figures b) and c) focus on CO₂ hydrates formation peak and CO₂ hydrates dissociation peak respectively.

917

918

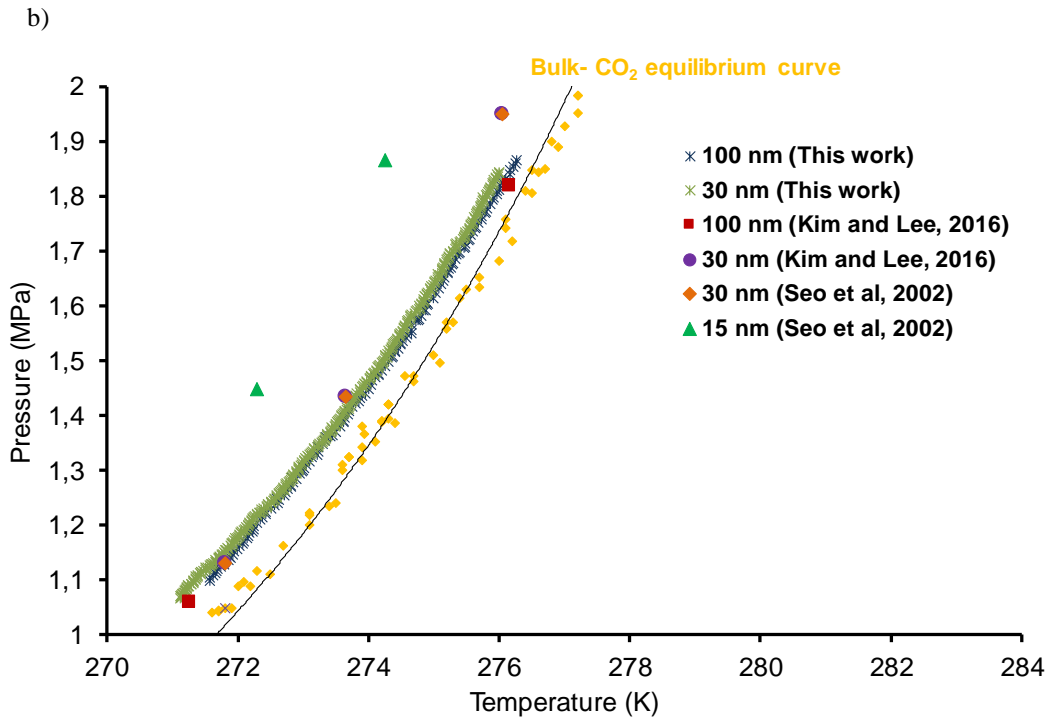
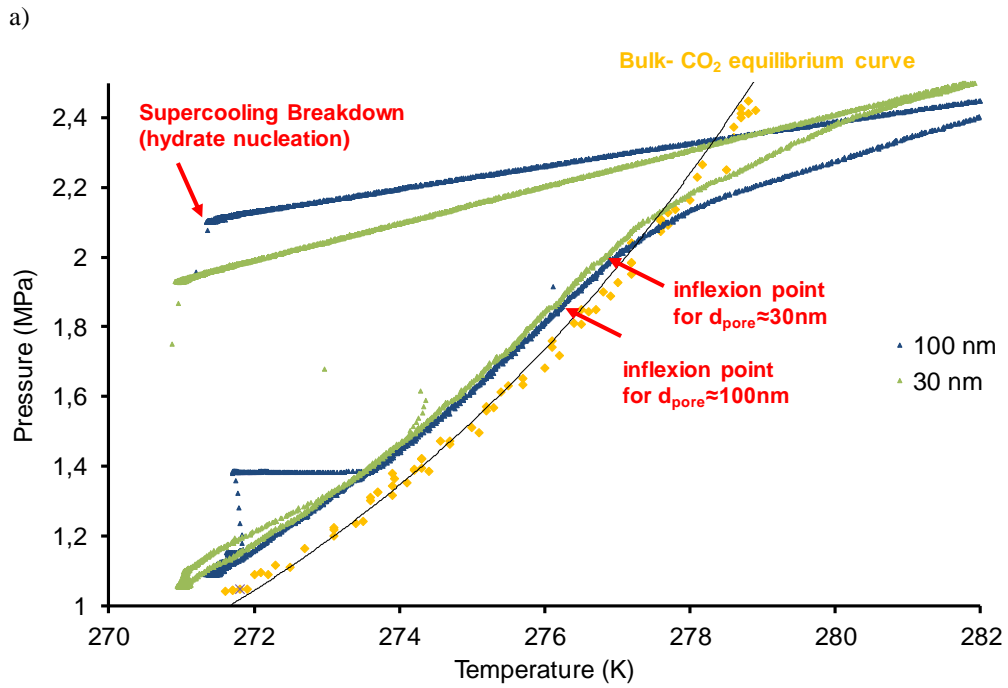

Figure 6: Temperature vs pressure profile of CO₂ gas hydrates in silica gel with several pore sizes. Results of previous studies in the literature are also reported (Kim and Lee, 2016; Seo et al., 2002)

919

920

921

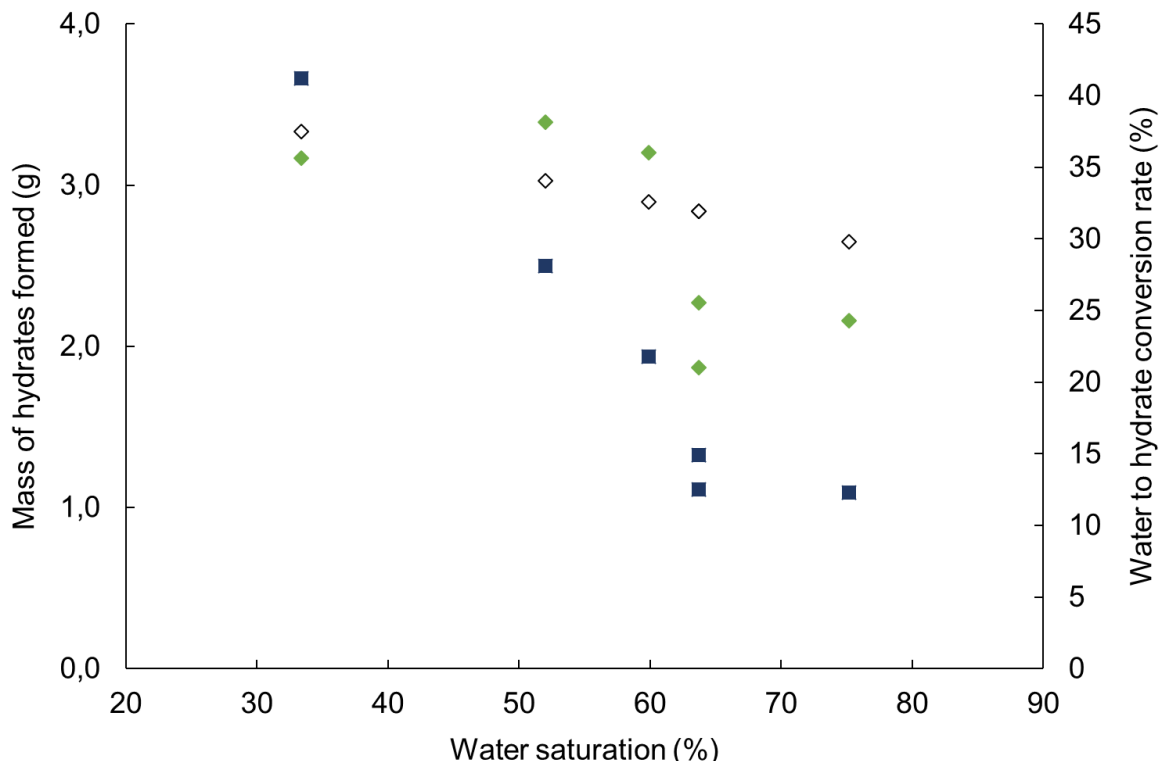

Figure 7: Mass of hydrate formed (◆: present calorimetric approach; ◇: previous mass balance approach (Marinhas et al., 2007) and water to hydrate conversion rate (■) as a function of water saturation of silica sand.

922

923

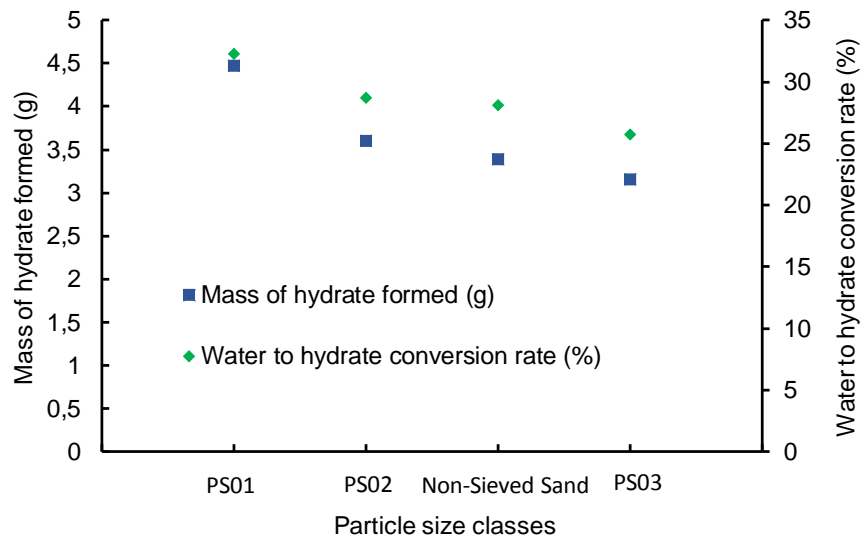

Figure 8: Mass of hydrate formed (◆) and water to hydrate conversion rate (■) as a function of particle size of silica sand.

924

925

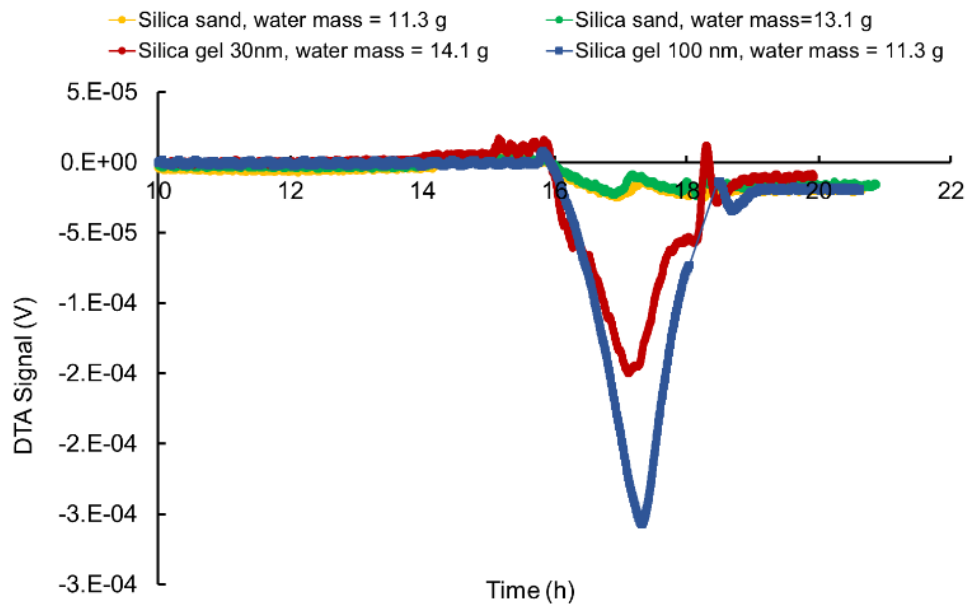
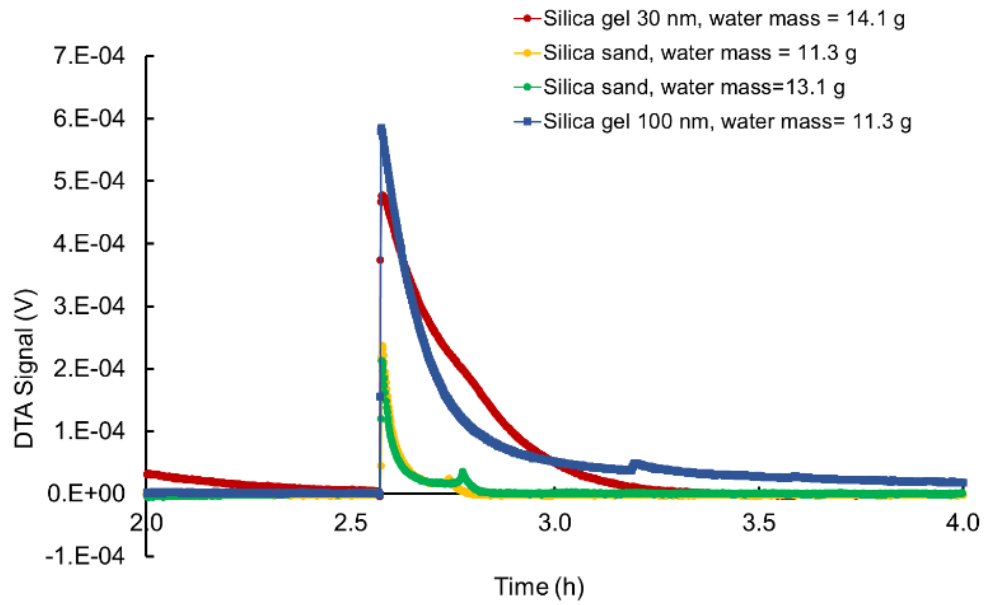

Figure 9: Comparison of DTA signal of CO₂ hydrate formation peaks in silica sand (Run 4 and 6, Table 3), and silica gel (Run 3 and 6, Table 5)

926

927

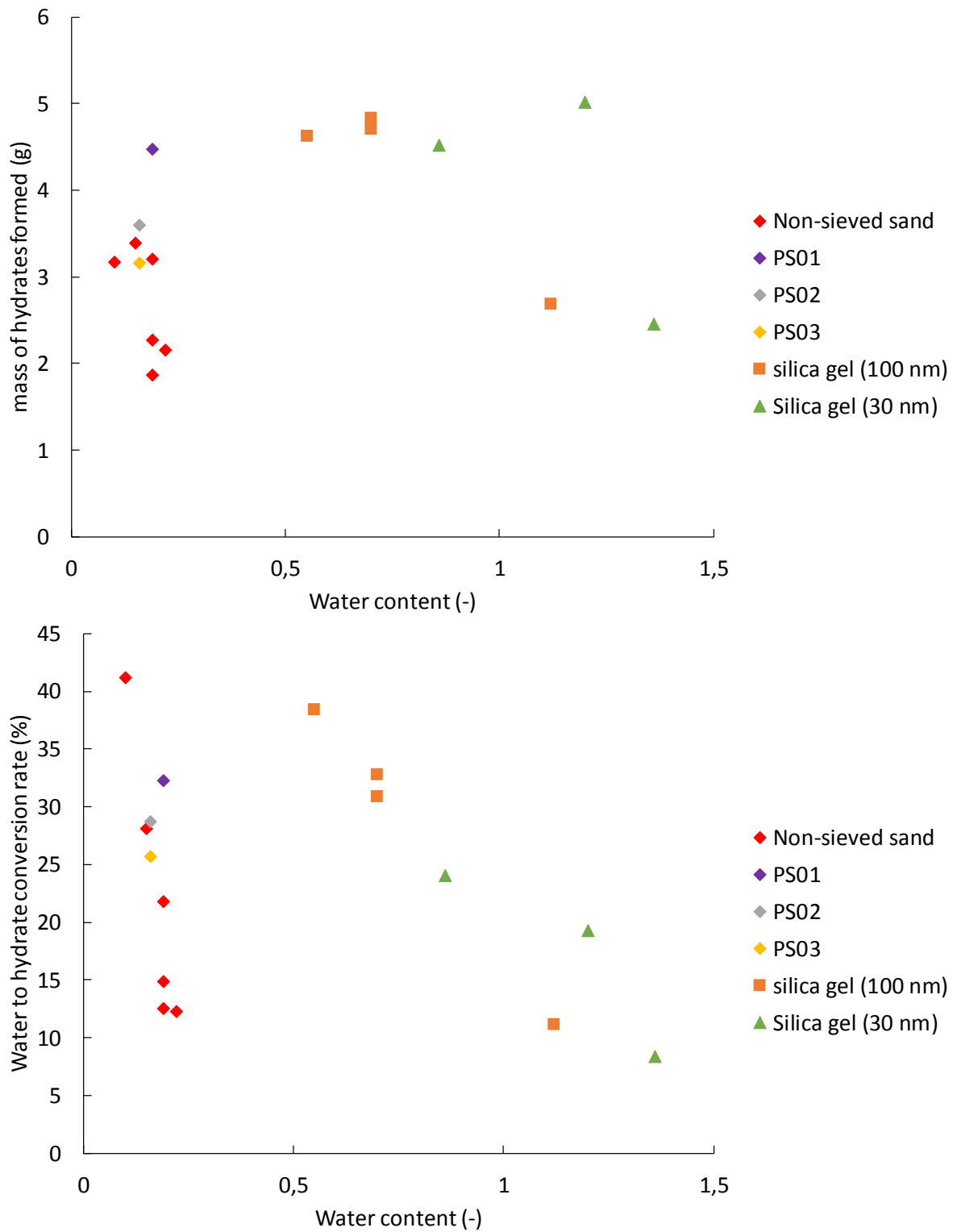

Figure 10: Mass of hydrate formed and water to hydrate conversion rate as a function of initial water content.

928

929

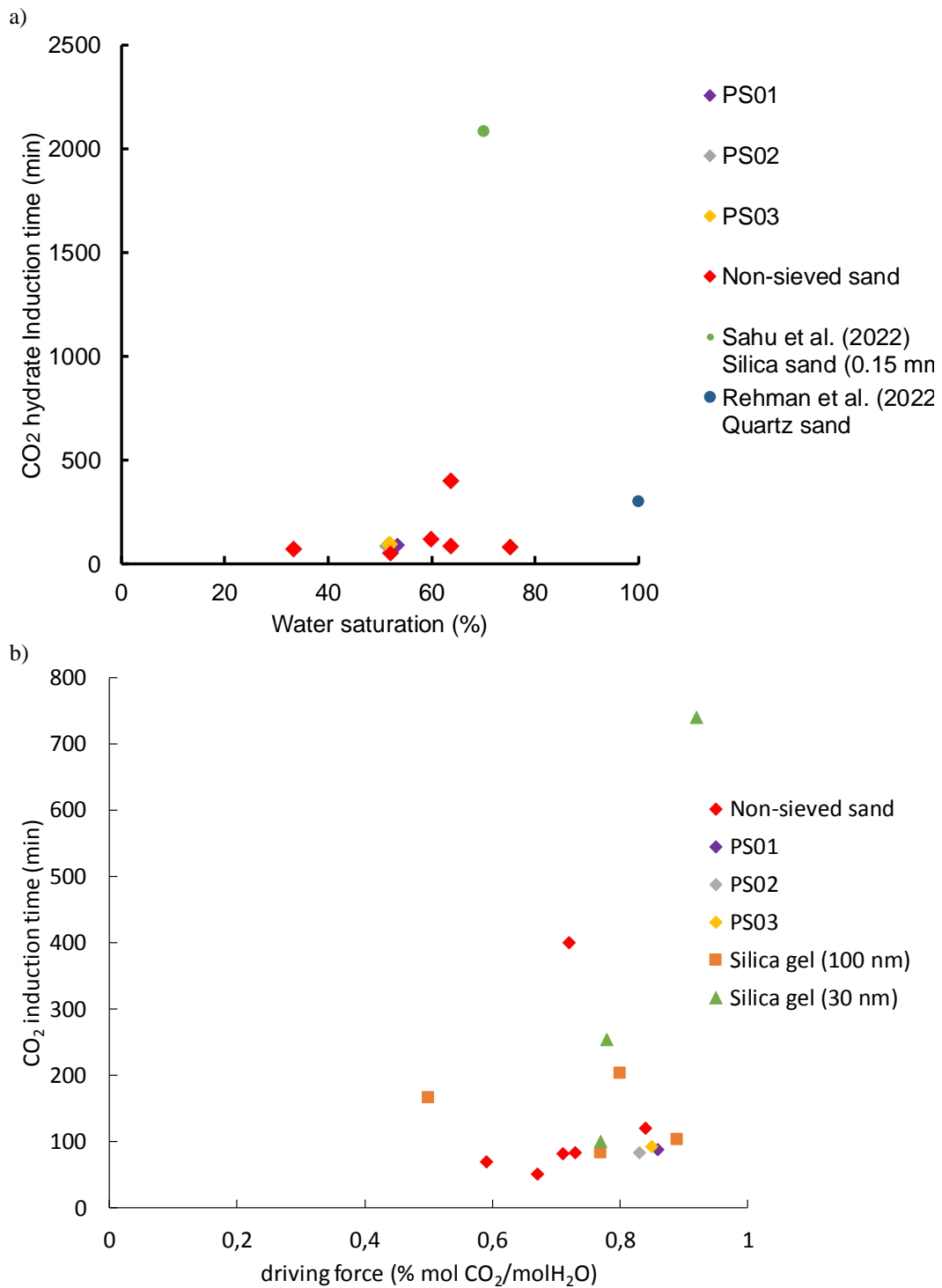

Figure 11: Induction time as a function of a) water saturation of silica sand and particles size, b) the driving force induced by the experimental conditions.

933

934

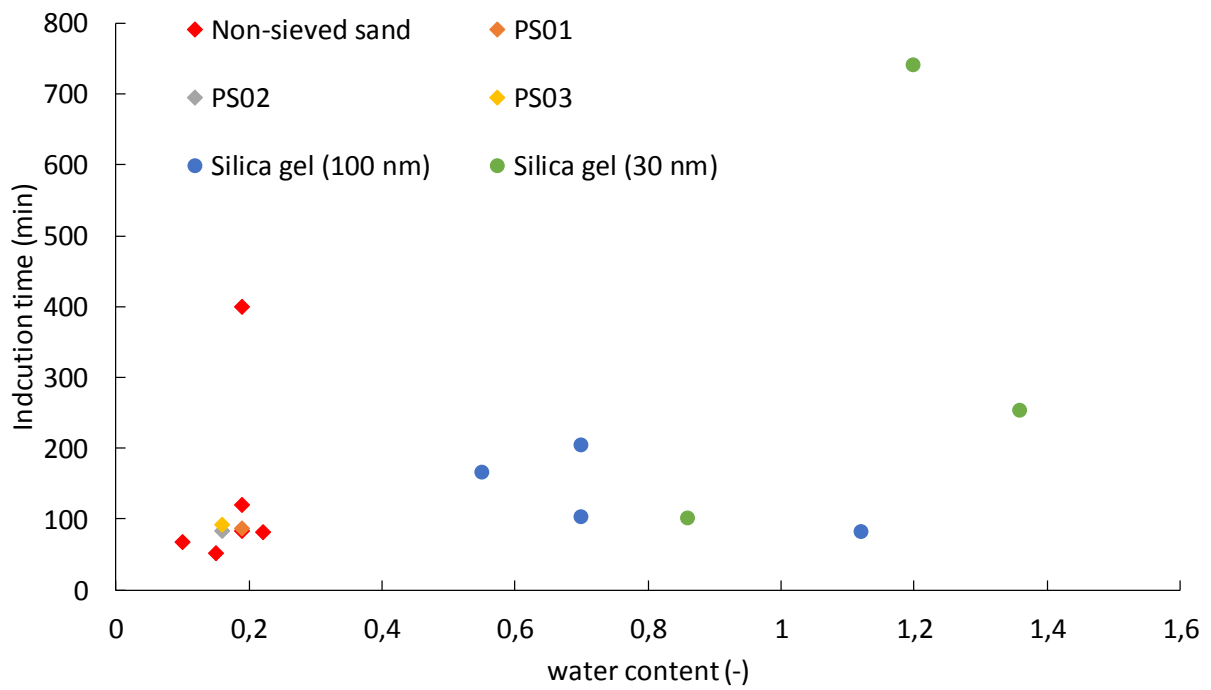

Figure 12: Induction time in silica sand, 100 nm silica gel and 30 nm silica gel as a function of initial water content.

935

936

