



HAL
open science

A collaborative network of digital twins for anomaly detection applications of complex systems. Snitch Digital Twin concept

Pablo Calvo-Bascones, Alexandre Voisin, Phuc Do Van, Miguel A. Sanz-Bobi

► To cite this version:

Pablo Calvo-Bascones, Alexandre Voisin, Phuc Do Van, Miguel A. Sanz-Bobi. A collaborative network of digital twins for anomaly detection applications of complex systems. Snitch Digital Twin concept. *Computers in Industry*, 2023, 144, pp.103767. 10.1016/j.compind.2022.103767 . hal-03784783

HAL Id: hal-03784783

<https://hal.science/hal-03784783>

Submitted on 23 Sep 2022

HAL is a multi-disciplinary open access archive for the deposit and dissemination of scientific research documents, whether they are published or not. The documents may come from teaching and research institutions in France or abroad, or from public or private research centers.

L'archive ouverte pluridisciplinaire **HAL**, est destinée au dépôt et à la diffusion de documents scientifiques de niveau recherche, publiés ou non, émanant des établissements d'enseignement et de recherche français ou étrangers, des laboratoires publics ou privés.



A collaborative network of digital twins for anomaly detection applications of complex systems. Snitch Digital Twin concept

Pablo Calvo-Bascones^{a,*}, Alexandre Voisin^b, Phuc Do^b, Miguel A. Sanz-Bobi^a

^a Department of Intelligent Systems, Comillas Pontifical University - Institute for Research in Technology, Madrid, Spain

^b Université de Lorraine, CNRS, CRAN, F54000, Nancy, France

ARTICLE INFO

Keywords:

Anomaly detection
Digital Twins
Behavior characterization
Quantile regression
Diesel generator

ABSTRACT

This paper proposes a novel anomaly detection methodology for industrial systems based on Digital Twin (DT) ecosystems. In addition to DTs, conceived as a digital representation of a physical entity, this paper proposes a new concept of DT focused on modeling connections between physical behaviors. This new DT concept is called Snitch Digital Twin (SDT). The scope of the SDT is the study of variations between behaviors and support the detection of anomalies between them. The behavior of each physical entity is characterized by three spatiotemporal features computed from each collected measurement. Behavioral anomalies are identified and quantified through modular patterns based on quantile regression and behavioral indexes. Finally, the robustness of the proposed methodology is assessed by comparing it with the other two commonly used algorithms based on Kernel Principal Component Analysis (KPCA) and One-Class Support Vector Machines (OCSVM) in a case study application. The case study is based on the diagnosis of the cooling system of a power-generator diesel engine. The results obtained prove the advantages and goodness of this novel methodology compared to the two traditional algorithms.

1. Introduction

Some of the most challenging areas within the paradigm of Industry 4.0 and the Internet of Things (IoT) aim to achieve better asset management based on data-driven solutions (Leukel et al., 2021). Predictive Maintenance (Zonta et al., 2020) and Prognosis and Health Management (PHM) (Guo et al., 2020) are some of the areas with a higher interest in Industry due to the repercussions that a system failure or unplanned downtimes have on their activities. These areas require more and more effective anomaly detection methods based on Machine Learning (ML) algorithms. These types of algorithms are gaining popularity in anomaly detection for data-driven applications.

ML techniques rely on the information collected by sensors and controllers of the system. Nevertheless, one of the paradoxes of modern systems is the rapid obsolescence of data due to the short-term operating conditions of the system. This fact limits the validity of the models, which become rapidly outdated when the Operating Conditions change or after running a maintenance task. Within the framework of Industry 4.0, and thanks to the vast amount of data provided by IoT and Supervisory Control And Data Acquisition (SCADA) systems, it is possible to compute a digital replica of a physical entity. Such a model is a characterization of behaviors defined by the variables registered

during the operation of the system. Models are used to identify and differentiate anomalous behaviors from normal ones.

Anomalies are also known as outliers, abnormalities, or deviants; and could be classified in the following categories (Chandola et al., 2009):

- Contextual anomalies: anomalous data detected in a specific context only, meaning that, in all other situations they would be perceived as normal;
- Collective anomalies: a group of related data points is anomalous compared to the reference dataset; the individual data points could represent normality, while it is their actual sequence that represents an anomaly.

Anomaly detection methods range from conventional techniques (statistical methods, time-series analysis, signal processing, etc.) to data-driven strategies (supervised/semi-supervised/unsupervised learning, reinforcement learning, deep learning, etc.) (Erhan et al., 2021).

This study proposes a novel methodology for anomaly detection based on collaborative models. The method relies on “elementary” DTs as agents of the system. The collaboration between “elementary” DTs allows for the detection of anomalies and assesses their severity. This

* Correspondence to: Department of Intelligent Systems, Comillas Pontifical University - Institute for Research in Technology, Sta. Cruz de Marcenado, 26, 28015 Madrid, Spain.

E-mail address: pcalvo@comillas.edu (P. Calvo-Bascones).

<https://doi.org/10.1016/j.compind.2022.103767>

Received 7 March 2022; Received in revised form 9 August 2022; Accepted 11 August 2022

Available online 13 September 2022

0166-3615/© 2022 The Author(s). Published by Elsevier B.V. This is an open access article under the CC BY-NC-ND license (<http://creativecommons.org/licenses/by-nc-nd/4.0/>).

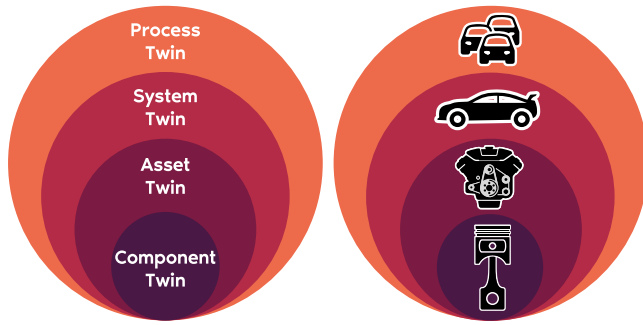

Fig. 1. Implementation levels of Digital Twins (Melesse et al., 2021).

collaboration between DTs aims to improve the detection of contextual and collective anomalies, which are more challenging to be identified using self-reference models.

The initial conceptualization of DTs was proposed by (Grieves, 2007) and defined later by the National Aeronautics and Space Administration (NASA) as a multiphysics, multiscale, probabilistic simulation that uses physical models, sensor updates, fleet history, etc., to mirror the life and behavior of its twin (Huang et al., 2021a). This article focuses on detecting anomalies in multiple agents' behaviors (DTs) based on the information collected from sensors and SCADA systems. The scope of this study is the definition of a data-driven anomaly detection framework without considering other DT applications related to CAD models (Lu et al., 2020), DT communication networks (Li et al., 2020), DT control applications (He et al., 2019), digital representations of real assets (Schluse et al., 2018), or any other type of physics models (Guo et al., 2018).

DT can be implemented at different levels, including component, asset, system, or process as it is shown in Fig. 1.

Among the types of DTs and their applications are remarkable those related to decision support, maintenance, plant and machinery optimization, (Melesse et al., 2021; Alves de Araujo Junior et al., 2021; Falekas and Karlis, 2021; Kunath and Winkler, 2018), among others. This study proposes an anomaly detection methodology for decision support and diagnosis applications.

An anomaly detection algorithm implemented within a DT ecosystem has to be compatible with:

- Modular structure, disposable and scalable: DT applications are commonly built upon independent agents subject to changes or replacements. The anomaly detection algorithm has to be compatible with partial modifications in the architecture of the model.
- Flexible and dynamic: DT applications are characterized by their flexibility when it comes to representing the changing conditions of the assets. These changes must also be included in the anomaly detection model updating their parameters.
- Near Real-time runtime: DT applications can be synchronized in real-time (Uhlemann et al., 2017; Xu et al., 2021) or detached (not synchronized) to the actual systems they are replicating. DT ecosystems might present online and offline interactions during its lifecycle (Khan et al., 2020; Moyne et al., 2020), therefore it is desirable (but not crucial) that the anomaly detection algorithm may be compatible with a near real-time runtime.
- Heterogeneous sources of knowledge. The integration of data analysis and Knowledge-Based Models in the composition of DTs might improve the characterization of processes and systems (Vogel-Heuser et al., 2021).

Based on the requirements of DT ecosystems, this study presents different contributions. Contributions regarding the architecture of the methodology:

- The anomaly detection methodology proposed in this study is fully compatible with a DT implementation: Modularity and scalability (agents can be easily removed or added from the model), flexibility (new index patterns can be easily removed if outdated or added to the model), and speed (compatible with on-line runtime applications).

Contributions regarding the behavior characterization:

- Three features are proposed for the characterization of behaviors. Density distribution, slope, and intercept values.
 - Density distribution analysis identifies biased deviations, outliers, and unusual values.
 - Slope analysis identifies deviation trends and provides a rough estimation of future values.
 - Middle intercept point analysis weights the variations detected as sharp transitions produced by changes in the operating conditions, maintenance tasks, etc.

Contributions regarding the anomaly detection:

- The proposed method allows for detecting contextual and collective anomalies thanks to the modeling of behaviors by collaborative networks based on DTs and SDTs.
- The methodology proposed is able to identify, quantify and assess the anomaly. Identify, it checks which features present variations regarding their reference value; quantify, it measures the size of the variation between test and reference; assess, determines whether an anomaly is very probable or unlikely based on the number of variations detected in the SDTs models.
- The methodology proposed is specially oriented to anomaly detection applications with scarce training sets or fast-changing working conditions.

This study is structured as follows. In Section 2, related works are presented and discussed. Section 3.1 introduces the multiple agents that make up the DT ecosystem and the structure of the methodology proposed. In Section 3.2, the features and elements applied in the characterization of behaviors are presented. At the end of this section, in Section 3.3, the anomaly detection process is described. Section 4 describes the implementation of the proposed methodology and the two existing ones in a real-case study. The results obtained are presented and discussed at the end of this section, in Section 4.4. Finally, the conclusions of this study are presented in 6. A brief description of KPCA and OCSVMs algorithms can be found as part of the Appendix, at the end of the document.

2. Related works

According to Leukel et al. (2021), the most frequently adopted algorithms in anomaly detection applications are Random Forests (RF), Support Vector Machines (SVM), and Artificial Neural Networks (ANN).

Complex models based on Deep Learning (DL) architectures and ANN usually have to tackle some drawbacks related to the requirements of extensive training sets (Xia et al., 2021), and the low physical interpretability of the parameters of such models (Abid et al., 2020).

RF, One-Class Support Vector Machines (OCSVM), and Kernel Principal Component Analysis (KPCA) are well-known algorithms with proven effectiveness in the detection of anomalies (Kerpicci et al., 2021; Barbado et al., 2022; Sun et al., 2020).

Other approaches based on Hierarchical Clustering modeled as RFs can be found in the literature. Kerpicci et al. (2021) proposes an anomaly detection methodology taking into account the sequentiality of samples. Cheng et al. (2021) takes into account spatiotemporal correlations for data recovery applications. Other statistical correlations, such as Spearman Correlation Coefficient, are used (Cheng et al., 2021). In Mensi and Bicego (2021) an algorithm based on Isolation, Forests are

proposed including an aggregation function of tree scores and weighted paths to obtain a more detailed anomaly score. An extended version of Isolation Forest was proposed in Hariri et al. (2021) allowing for the slicing of the data to use hyperplanes with random slopes and intercept points.

The slicing data process in Hierarchical Clustering is crucial for the accuracy of this type of algorithm. In Saeed et al. (2021), Cheng et al. (2021) the authors propose extremely randomized splitting as their best approach. In Kerpicci et al. (2021) the authors propose a novel splitting process based on optimized Kernel Density Estimators.

In Simmini et al. (2021), a KPCA algorithm is proposed for the anomaly detection of cooling systems. The authors, as in the present study, propose the slope and intercept point extracted through a sliding windows method as features to assess multiple operating conditions. Such a study only takes into account steady-state conditions. Whereas the present study aims to compare the effectiveness of KPCA with the proposed methodology for the assessment of steady-state and dynamic working conditions which are the most frequent scenarios for online applications.

In Dhiman et al. (2021), a linear kernel SVM is proposed for the detection of anomalies in gearbox systems based on thermal measurements. The detection of anomalies includes the assessment of variations between measurements. These variations are modeled as the difference between two variables. The present study proposes not only the assessment of variations between thermal variables but also between agents. In addition, a linear kernel SVM is implemented to be compared with the proposed methodology.

DT ecosystems are widely implemented in anomaly detection applications. In Piltan and Kim (2021), a DT-driven anomaly detection based on support vector algorithms is implemented in the detection of defects in bearing systems. Guo et al. (2021) proposes a hierarchical anomaly detection based on DT systems implemented for production lines analysis. Oluwasegun and Jung (2020) proposes the implementation of DTs in a PHM methodology using SVMs as classifiers and anomaly detectors of the Control Element Drive Mechanism of a nuclear plant. Studies like (Gaikwad et al., 2020) have implemented DTs with a linear kernel SVM for the detection of failures in Additive Manufacturing processes.

In comparison to other studies in anomaly detection methods, (Lindemann et al., 2019) implements k-means clustering methods, but such an approach usually requires additional assessment methods such as density distributions (Calvo-Bascones et al., 2021) or isolation forests (Castellani et al., 2021). The proposed method deals with this purpose in one step using quantiles as landmarks (clusters) and density indicators.

Li et al. (2021) proposes the use of encoders for anomaly classification, the encoder proposed aims for binary classifications of anomalies based on labels without assessing the severity of the anomalies detected. The present study proposes an encoder that classifies and assesses the severity of the anomalies detected in an unsupervised manner

Saez et al. (2020) proposes the definition of Global Operation States (GOS) to determine the limits of the acceptance thresholds based on contextual properties. Such contextual properties are determined locally for each variable and do not consider a multivariate GOS definition. The present study considers, by design, all the variables of the agents that make up the DT ecosystem in the definition of each Operation State condition.

None of the previous works take into account the study of interactions between agents for the assessment of local and collective behaviors. The study of these interactions is carried out through the analysis of variations between behaviors through a new type of DT. The purpose of this new type of DT is not the virtualization of an asset, but the virtualization of variations between behaviors. The integration of this new type of knowledge in the assessment of anomalies presents multiple improvements in the characterization and assessment of anomalies as it is shown in subsequent sections.

Considering all these previous works, the next section presents the methodology proposed and its main elements.

3. Anomaly detection methodology based on collaborative networks of DTs

The present study proposes an anomaly detection methodology compatible with a DT ecosystem. Two kinds of DT models are proposed in the definition of the anomaly detection framework: standard DTs and Snitch Digital Twins (SDTs).

3.1. Snitch Digital Twins concept

Standard DT behavior models focus on the virtualization of physical entities' behavior. An entity's behavior is usually computed from independent variables, e.g., temperature, pressure, speed, etc. The variables and features that define a model are called attributes.

Entities that belong to the same system frequently present linked behaviors. The study of variations between linked behaviors is a powerful source of knowledge, especially in anomaly detection. The standard concept of DT does not include the virtualization of linked behaviors as they (linked behaviors) do not represent a physical entity. Modeling linked behaviors as synthetic physical entities define the concept of Snitch Digital Twins.

The features of elementary DTs are based on sensor measurements, physical equations, digital visualizations, or any other source of knowledge used to create a virtual replica of a physical entity. The features of SDTs are based on comparisons between sources of knowledge from multiple DTs. This comparison aims to replicate, in this case, not a physical agent but its interactions with other agents and their operation context. The study of such interaction is the basis of contextual and collective behaviors which play a crucial role in anomaly detection applications. Tripathi and Baruah (2020) asserts that the lack of contextual information within the existing framework is one of the major factors that result in a high false alarm rate when applied to detect anomalies in the areas that involve contextual information while making decisions.

Let us suppose a system (an engine) is made up of multiple entities (cylinders), for the sake of simplicity, only two entities are considered. The attributes of each entity are defined by three variables (v1, v2, and v3). Each variable represents a relevant attribute to be considered in the assessment of the entities' behavior.

A basic DT ecosystem only comprises two DTs with three independent attributes. The proposed ecosystem includes, in addition to the two DT models for each physical entity (DT1 and DT2), two types of SDTs. The first type of SDT comprises the variations between attributes of the same physical entity, (SDT1 and SDT2). The second type comprises the variations between the attributes of two physical entities (SDT1,2).

A comparison of a basic DT ecosystem and the proposed DT ecosystem including SDTs is shown in Fig. 2.

The main difference between DT and STD is the nature of their attributes. DT attributes are defined by individual variables obtained from sensor measurements. SDT attributes are defined by variations between variables within the same entity or between two different entities. The purpose of DTs is the characterization of local behaviors, whereas the main contribution of the SDTs is the characterization of contextual and collective behaviors.

Variations between variables are studied taking into account their nature. Two variables share the same nature when they describe similar physical processes. For example, the exhaust gas temperatures from two different cylinders of an engine share the same nature. The exhaust gas temp. and in-take gas temp. do not share the same nature regardless they belong to the same cylinder or not.

Variations between two variables are obtained as the absolute value of their difference. For instance, the variation between variables X and Y is obtained as stated in Eq. (1):

$$V_{X,Y} = V_{Y,X} = |X - Y| \quad (1)$$

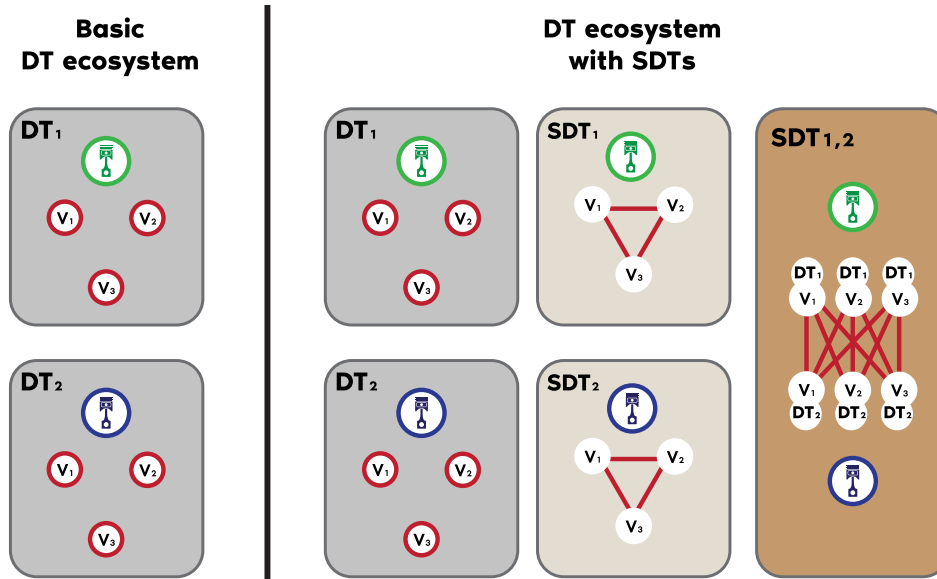

Fig. 2. Comparison of model attributes between a basic DT ecosystem and a DT ecosystem with SDTs.

Comparing two variables of different nature requires a previous scaling of their values. Although the most frequent normalization is a min-max scaling, this type of normalization presents some weaknesses when the min and max reference values change or outlier samples are included as part of the reference data set. This study proposes a zero mean and unit variance scaling (z-score or standard score). The equation of the standard score of a sample x is shown in Eq. (2):

$$x' = \frac{x - \mu_X}{\sigma_X} \quad (2)$$

where μ_X and σ_X are the mean and the standard deviation, respectively, of variable X . Even though the output of this type of scaling is not limited between 0 and 1, the obtained values share the same order of magnitude based on the principle of the three Sigma Criterion (Pukelsheim, 1994). The purpose of scaling is to transform heterogeneous orders of magnitude into measurements of the same order of magnitude.

The equation of the variation between two variables of different nature is (3):

$$V_{X,Y} = V_{Y,X} = \left| \frac{X - \mu_X}{\sigma_X} - \frac{Y - \mu_Y}{\sigma_Y} \right| \quad (3)$$

where μ_X and μ_Y are the mean values, and σ_{V_X} and σ_{V_Y} are the standard deviations of variables X and Y , respectively. Both, μ and σ are computed from the reference data set, assuming that both features remain significant for the test data.

3.2. Characterization of behaviors

The variations between two variables have to be processed using different types of features commonly applied to the characterization of anomalies. This study proposes three behavioral features obtained through sliding time windows:

- Density distribution based on quantiles: This feature allows for identifying which values are more frequent, how they are distributed, and their dispersion level (spatial feature).
- Slope of best-fit line: This feature assesses the trend of the values registered and how they evolve throughout the time window (temporal feature).
- Intercept point of best-fit line: This feature determines the reference value of the best-fit line obtained for a specific time window (spatial-temporal feature).

Distribution Functions (DF) are commonly used in the characterization of behaviors for anomaly detection applications (Calvo-Bascones et al., 2021; Gil et al., 2018). DFs are highly dependent on the bandwidth values of their kernel functions (Calvo-Bascones et al., 2021) and can be easily simplified into a one-dimensional non-parametric estimation using quantiles as distribution and density features (Akbari et al., 2019). Two distributions can be easily compared through their quantile values, see Fig. 3. The first distribution is made up of three normal distribution of 100 samples each, with mean (μ) and standard deviation (σ), $n(\mu, \sigma)$. The second distribution is made up of only two different normal distributions with 150 samples each.

The use of quantiles in this study has a double aim: 1) Quantiles used as density feature, 2) Quantiles used in the feature segmentation process.

For each sliding window $\{\omega_1, \omega_2, \dots, \omega_w, \dots, \omega_W\}$, a set of distribution quantiles $\mu_{q,w}$, a α_w slope value and a ρ_w intercept point value are obtained. An example of these features is shown in Fig. 4, taking the five quartiles as distribution quantiles.

A Hierarchical Clustering can be obtained by splitting the feature values based on their density. Density values are defined through quantiles tagged as Θ for distribution quantiles (μ), Λ for slope values (α), and Y for intercept points (ρ). An example of the splitting process is shown in Fig. 5.

Once reference density split quantiles are defined, input features can be matched as shown in Fig. 6. The matching process is based on the Euclidean distance between the test feature value, and the reference density split quantile value.

Studies like (Kerpicci et al., 2021) highlight the importance of the density splitting process for anomaly detection applications. The optimal level of partitions might not be fixed but time-varying, especially for systems with complex dynamics. Moreover, the same study defends that simpler partitions with a less number of regions are advantageous for short time series, whereas deeper partitions are needed as more data become available.

The present study proposes a method to determine the number of density splits. This approach is based on the analysis of the standard deviation of K standard deviations (σ_k) computed for each of the K regions defined by $(K - 1)$ equally distanced quantiles. Equally distanced quantiles mean that the number of samples (n) between two consecutive quantiles is the same for each pair of quantiles. The standard deviation of each region k is determined by:

$$\sigma_k = \frac{\sum_{i=1}^n (x_i - \mu_k)^2}{n} \quad (4)$$

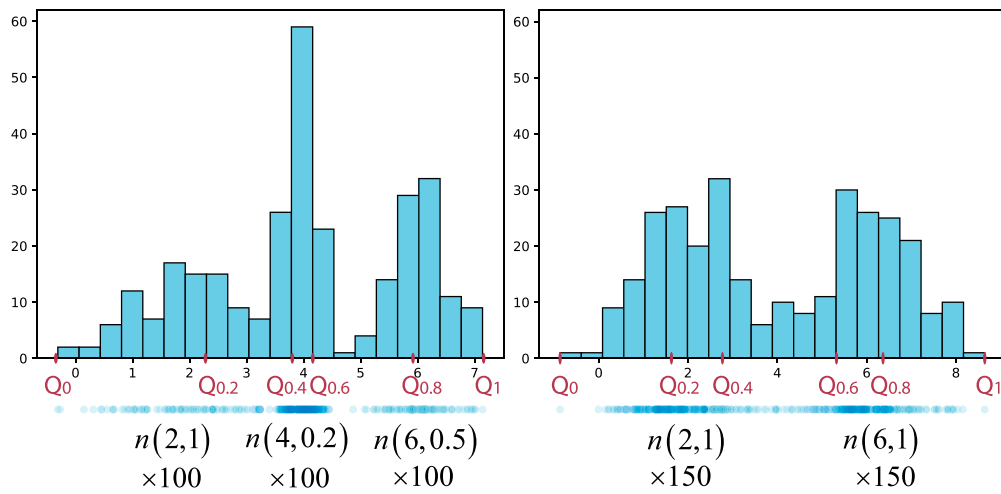

Fig. 3. Two distributions can be easily compared through their quantile values.

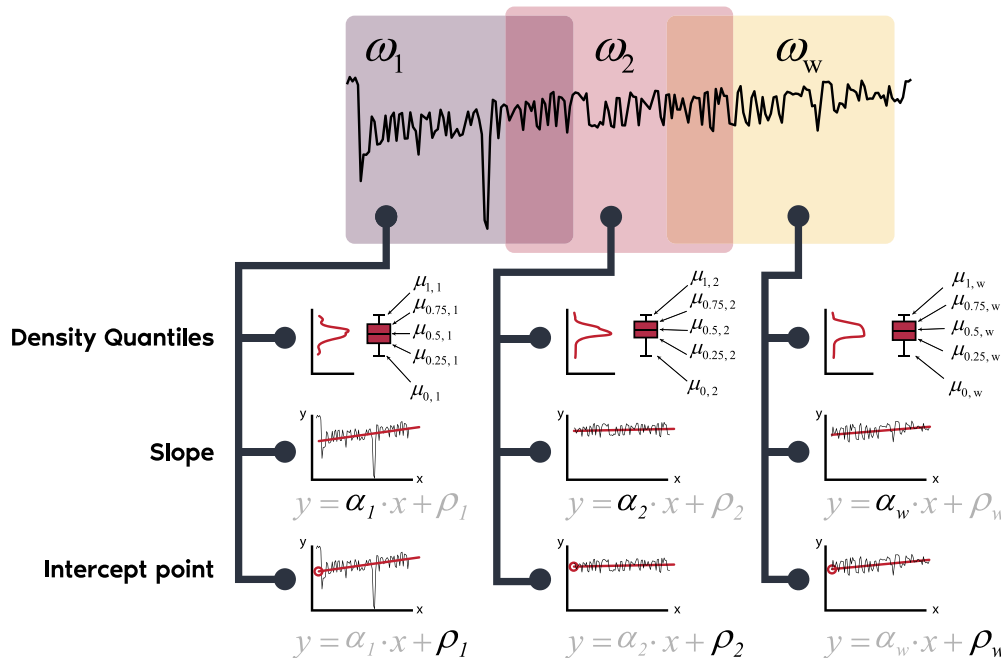

Fig. 4. Example of feature extraction through sliding windows.

where n is the number of samples within the region k and μ_k is the mean value of such samples. The standard deviation of the local standard deviations (σ_σ) if obtained for each region as:

$$\sigma_\sigma = \frac{\sum_{k=1}^K (\sigma_k - \mu_\sigma)^2}{K} \quad (5)$$

where μ_σ is the mean value of all the standard deviations corresponding to each region.

The first difference of σ_σ is computed by:

$$\Delta\sigma_{\sigma,i} = \sigma_{\sigma,i} - \sigma_{\sigma,i-1} \quad (6)$$

Where i is the index of number of regions.

Four different scenarios were identified and presented in Fig. 7. The basic case a) shows 7 regions clearly identified. The value of σ_σ shows a local minimum that coincides with the number of regions. A new local minimum appears periodically. Case b) shows how local minimums soften as distributions start overlapping themselves. Case c) shows a σ_σ graph without a local minimum. For this case, the first difference of σ_σ

is computed, taking as the best solution the global minimum of the first derivative. In case the first derivative does not show a global minimum, the optimal solution would be its first local minimum. Case d) shows the most common shape with a strong overlap between distributions. For this case, a peak (5 regions) appears in the σ_σ graph. The optimal solution would be the closest previous point to the peak, whose first couple (x2 its value) shows a higher σ_σ value. In this case, point B is the closest point to the peak, but Bx2 has a lower σ_σ value; A, on the contrary, has a couple with a higher value; therefore, A is a locally optimal solution. If none of the lower-than-the-peak values fulfill the previous condition or the number of regions must be greater than two, the optimal number of regions is calculated similarly to case c) for regions larger than the peak value (5 regions).

Each density split quantile has an index linked to its value. The lowest index corresponds to the lowest density split quantile value, and the highest index corresponds to the highest split quantile value. In the case of the distribution feature, indexes are sorted based on the mean value of the sequence of density split quantiles. The conversion from split quantile values to indexes is carried out through an encoder.

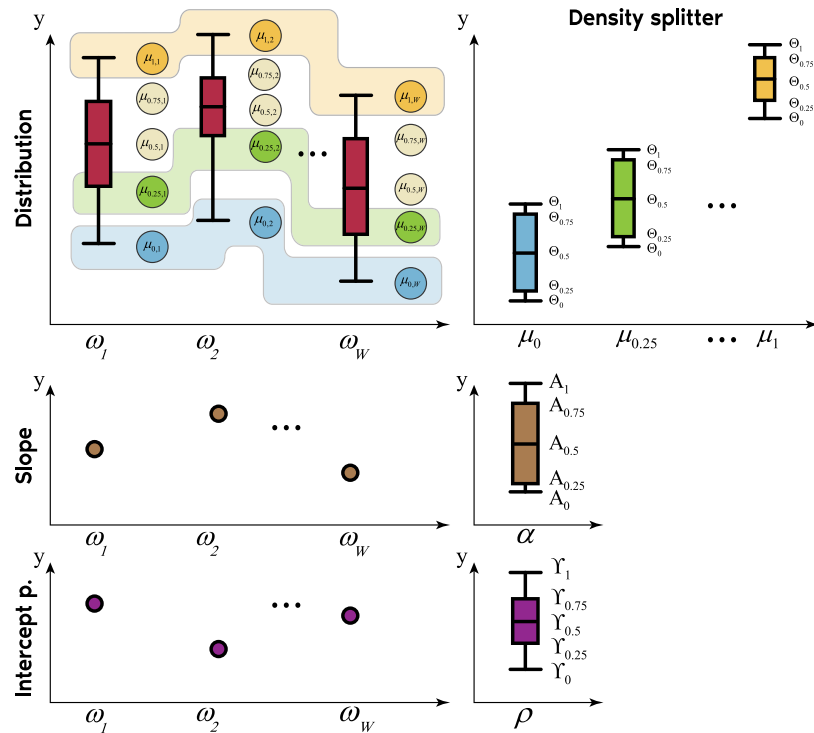

Fig. 5. Example of feature clustering after being extracted through sliding windows.

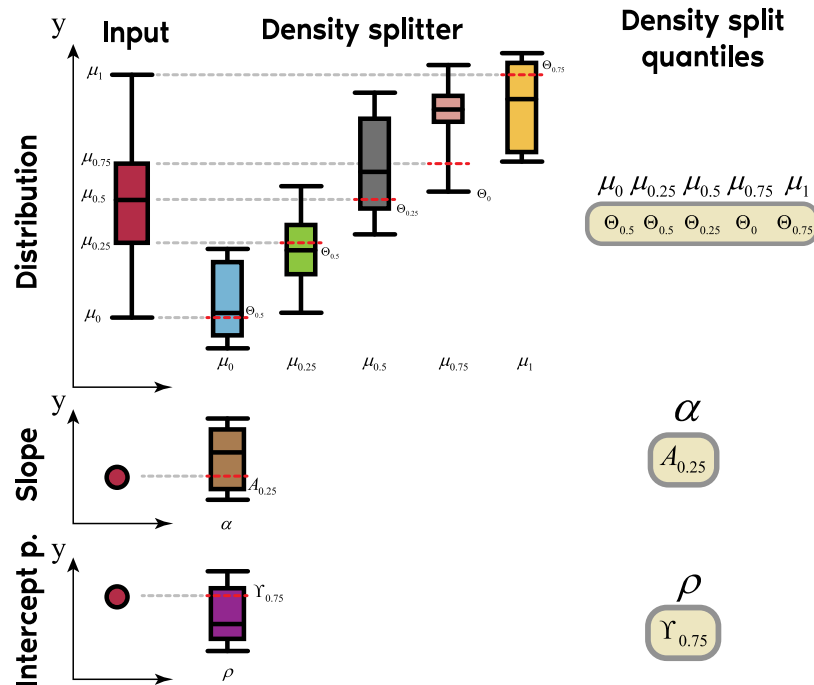

Fig. 6. Example of computation of cluster indexes from the feature values of a window.

In order to illustrate how indexes are computed and sorted, a simplified example is shown in Fig. 8. This examples is made up of density split quantiles $[\Theta_{0.25}, \Theta_{0.5} \text{ and } \Theta_{0.75}]$ for distribution quantiles $[\mu_{0.25} \text{ and } \mu_{0.5}]$, density split quantiles $[A_{0.25}, A_{0.5} \text{ and } A_{0.75}]$ for slope values (α) and density split quantiles $[Y_0, Y_{0.25}, Y_{0.5} \text{ and } Y_{0.75}]$ for intercept points (ρ) .

The task of the encoder is the conversion from a density split quantiles value to their corresponding index. An example based on the previous scenario is shown in Fig. 9.

All the indexes obtained from DT and SDT at the same sample time, make up an index pattern. The stack of indexes defines the DT network.

An example of a DT network made up of index patterns is shown in Fig. 10:

The architecture of the index patterns allows for adding new DTs and SDTs without needing to update the rest of the network. This feature makes this methodology scalable when it comes to adding new agents to the network of DTs, and flexible when it comes to updating the indexes of a particular entity.

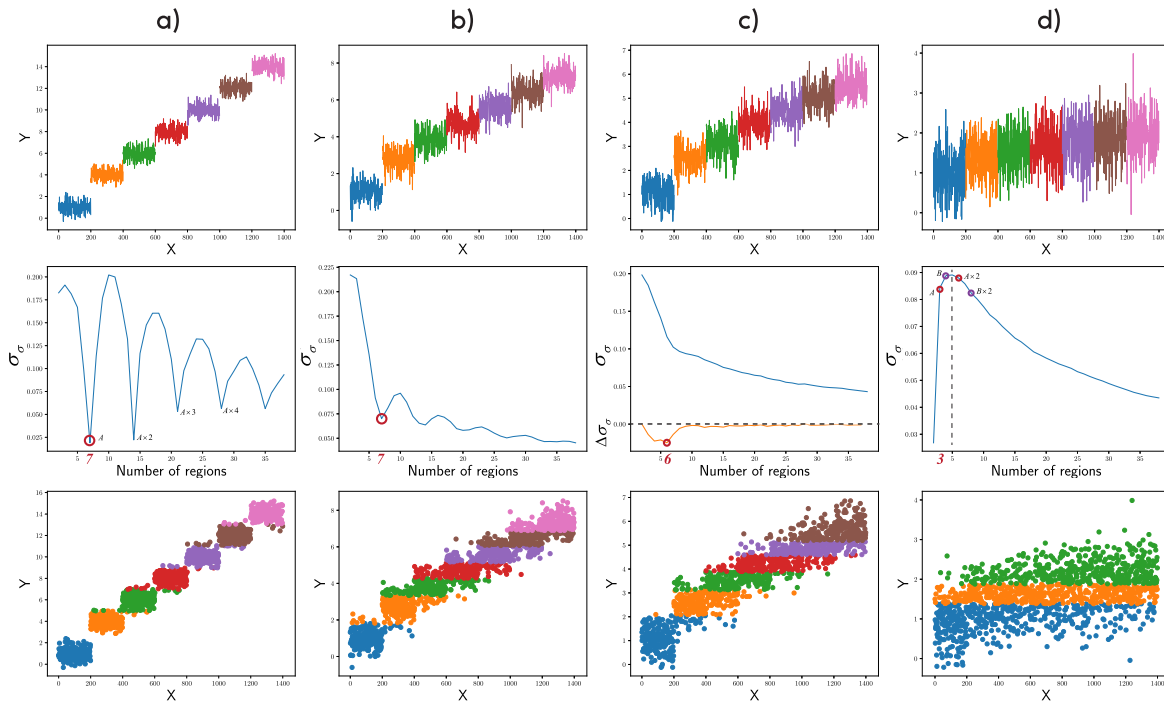

Fig. 7. Optimal partition depth based on the topology of the time series.

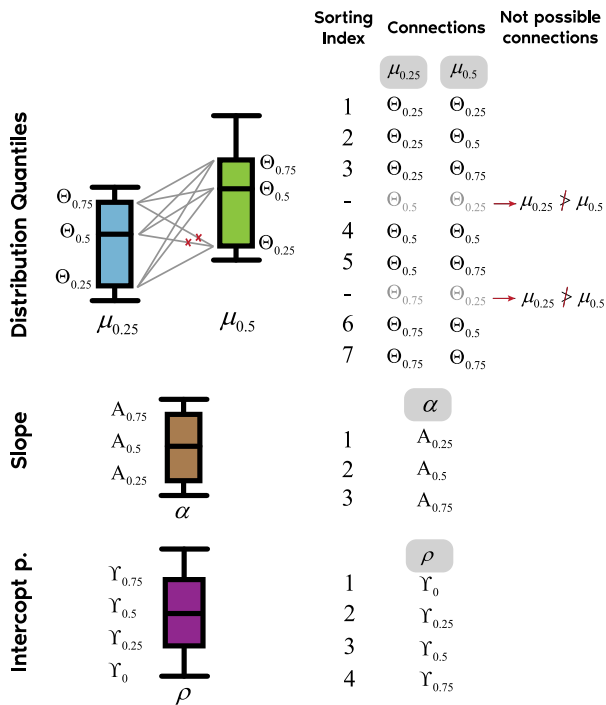

Fig. 8. Example of how a map of indexes is obtained from density split quantiles.

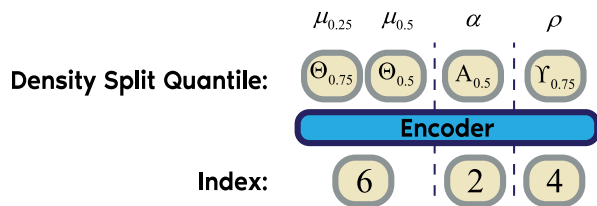

Fig. 9. An encoder converts density split quantile values into indexes.

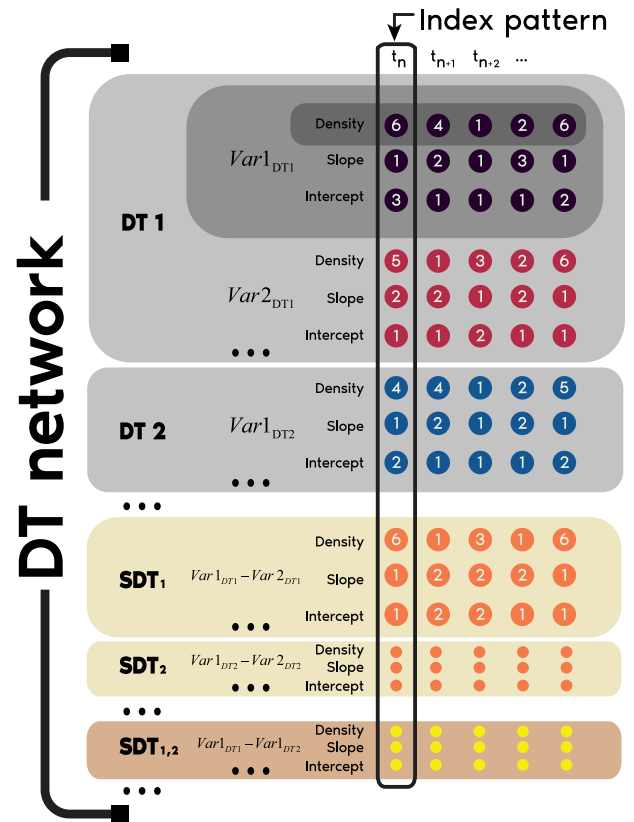

Fig. 10. Example of a DT network.

In case an entity is disconnected or removed from the DT network, all DTs and SDTs related to this entity can be easily removed from the network.

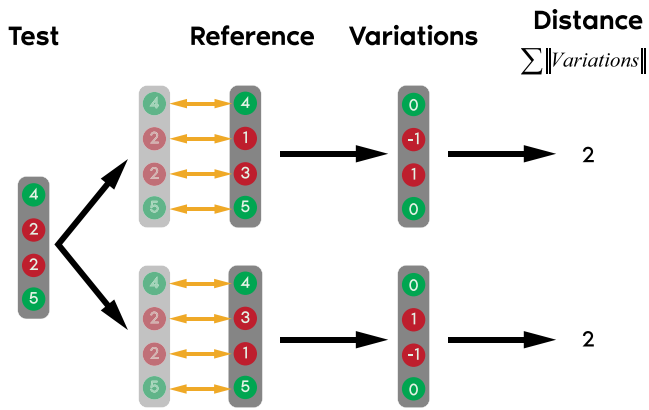

Fig. 11. Example of a matching process with singularities.

3.3. Detection of anomalies

After computing a reference DT network, it is possible to diagnose behavioral anomalies by comparing index patterns. The assessment process between indexes is carried out through an integer matching process. The first condition to detect an anomaly is that the number of equal indexes between test and reference patterns has to be higher than the number of different indexes. Otherwise, a new index pattern is detected. If the test pattern presents the same number of equal integers to two or more reference patterns, the closest pattern is chosen based on the city block distances (L1 norm) between indexes with different values. L1 norm presents a balanced weighting of variations, in comparison to other distances, such as L2 norm (Euclidean), in which large variations between indexes have a greater weight than the small ones. In case two reference patterns present the same minimum distance to the test pattern, such a test pattern can be considered as a new reference pattern. One example is shown in Fig. 11.

Variations are computed as shown in Eq. (7):

$$A_i = T_i - B_i \tag{7}$$

where i is the index of the feature to be compared, T is the index under assessment, and B is the reference index.

This methodology allows for identifying the location of the anomaly based on the location of variations and quantifying their magnitude based on the size of the variations detected in SDTs. The sign of variation indicates whether the value registered is below or above its reference.

The detection of anomalies is based on the “collaboration” between DTs. Anomaly detection is supported by a network of behaviors linked between them. These links are modeled as part of the variables of SDTs. Variations in the indexes of SDTs are only considered when the corresponding DT has previously detected a variation in their indexes.

The steps to detect anomalies are the following:

- Identify which DTs present variations.
- Identify which SDTs present variations.
- The more linked anomalous SDTs a DT has, the higher the likelihood of such an anomaly is.

Anomalies are detected individually for each of the three features to achieve a more accurate anomaly characterization.

4. Application to the cooling system of a diesel engine

The proposed methodology is applied to a real system in order to investigate and validate its capabilities for the detection of anomalies. The system under assessment corresponds to the cooling system of

a diesel engine generator. Older studies like (Manders et al., 2000), proposed an anomaly detection methodology for an engine cooling system based on traditional statistical indicators. Other studies (Tiddle and Jones, 2002) proposed an anomaly detection method based on fuzzy models of an engine cooling system. More recent studies like (Huang et al., 2021b), implemented an online DT-driven anomaly detection framework based on Gradient Boosting Decision Trees for cooling systems.

4.1. System description

The system under assessment corresponds to the diesel engine generator of a power plant made up of nine cylinders. This diesel generator has a two-stroke combustion cycle with a power generation of around 3200 kW.

Each one of the nine cylinders is endowed with a set of temperature sensors that provide a detailed view of the state of each cylinder. A simplified scheme of the gas–water recirculation system is presented in Fig. 12.

The scope of this study is the analysis of the state of the nine cylinders through the temperature measurements obtained from its cooling system. The cooling system of the diesel engine presents a gas circuit, shown in gray, and a water circuit, shown in blue. The critical part of the cooling system is located in the cylinders of the engine, where the greatest amount of thermal energy has to be evacuated. The other three main heat exchanger systems are located at the beginning of the water circuit (heat exchanger) and between the gas and water circuits, such as the inter-cooler and the Exhaust Gas Recirculation (EGR) system. These components are crucial in the cooling process of any engine.

An exceeding temperature operating condition extended over a long period might cause severe damage to cylinders and liners. Cooling system failures might be produced by:

- Cooling system is not completely filled with coolant.
- Air pockets within the cooling system.
- Thermostat malfunction.
- Faulty coolant pump.
- Broken cooling fins.
- Cooling fan malfunction.
- Sleepy or broken belt.

The behavior of the cylinders is defined by their (1) sweeping air temperature, (2) exhaust gas temperature, and (3) exhaust water temperature, including the gross power generated by the engine. (1,2,3) correspond to the tags of Fig. 12. The available variables are:

- Gross power demanded and generated: Power demanded and generated by the engine (MW). This variable allows for determining the operation state of the engine.
- Sweeping air temperature: temperature of the air before entering the combustion chamber of each cylinder. (°C).
- Exhaust gas temperature: temperature of the gas leaving the combustion chamber (°C) after the diesel pressure ignition.

Sweeping air and exhaust gas temperatures are crucial to characterize the behavior of each cylinder as they provide relevant information about the inner conditions of each cylinder.

- Exhaust water temperature: temperature of the cooling water (°C) after surrounding the cylinder liners.

The temperature of the exhaust water provides an overview of the general state of the cooling system. Water temperatures show higher inertia against abrupt changes compared to other gas temperature measurements. Therefore, it is a meaningful indicator to know the state of the cylinder based on its cooling system.

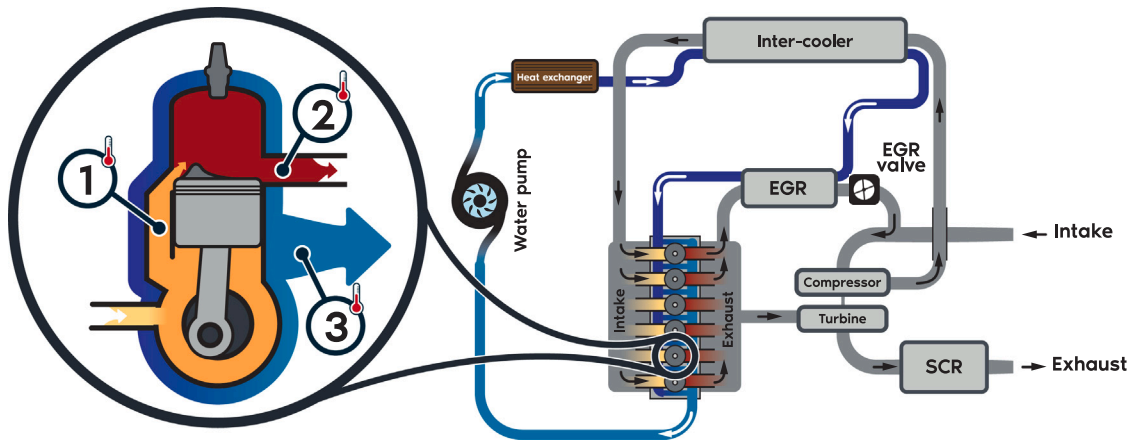

Fig. 12. Simplified scheme of the cooling system of a diesel engine.

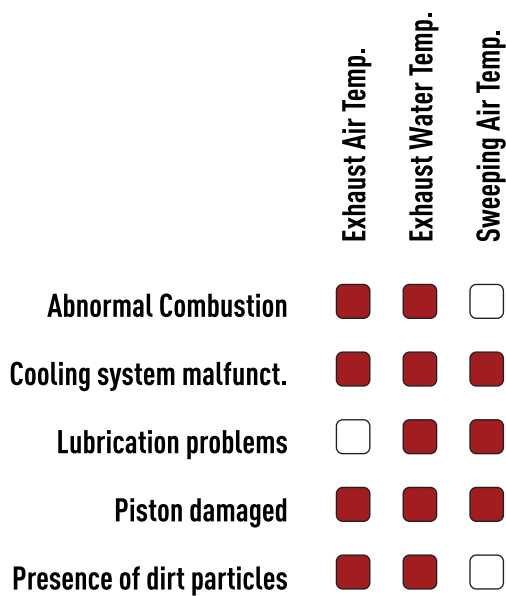

Fig. 13. Concise root cause analysis based on the three temperatures considered.

Table 1
Applied filter values to the input data.

Measurement	Value
Power demanded (KW)	<22000
RPM	>98
Exhaust gas temperature (°C)	>320
Sweeping air temperature (°C)	<100
Exhaust water temperature (°C)	<85

A concise root cause analysis based on the previous measurements is shown in Fig. 13.

Based on the anomalies detected, the root cause analysis allows for identifying which problems are more likely to be present in the operating conditions of the system.

4.2. Sensor measurements preprocessing

Different filters were applied to the input dataset to filter out those samples that are considered irrelevant or outliers for this study. The filters applied are shown in Table 1.

Samples outside of these filters were considered outliers or transient states that correspond to the start or stop of the engine.

4.3. Real case application

A real case is proposed to assess the effectiveness of the methodology proposed in comparison to the other two traditional algorithms. The purpose is to perform an effective anomaly detection from a small training set. This case comprises 2639 samples, where 1173 are used for the training set. The sampling rate is 1 sample per hour grouped into sliding windows of 168 samples (one week of measurements) to reduce variations derived from different days of the week. Maintenance tasks are carried out every 2500 h.

The main events of this dataset are the following:

- A maintenance inspection task is registered between samples 1500 and 2000. There is no information about which components were repaired, cleaned, or replaced.
- A short stop is registered around 2200.
- From sample 2300 on, no more events are registered; the system runs under normal operating conditions.

4.3.1. Anomaly detection setting for SDTs

To determine when a feature (Density, Slope, or Intercept) of a temperature variable (EW, EA, SA) in a cylinder (C1, C2, ..., C9) presents a deviation, the following two conditions must be fulfilled:

1. The feature of a temperature variable of a cylinder DT presents a deviation regarding its expected behavioral index.
2. More than 50% of the SDTs, which include the same cylinder temperature feature, present deviations.

This study is carried out for each feature type separately. This means that density feature indexes are only considered for density assessments, slope feature indexes for slope assessments, etc.

Once all the deviations have been identified, anomalous behaviors are determined by combining three feature deviation conditions.

- The Density index deviation has to be greater or equal to one.
- The slope index deviation has to be greater or equal to one or its index has to be equal to its highest index.
- The intercept value index deviation has to be greater than one or its index has to be equal to its highest index.

These conditions assure:

- The correlation between temperatures from different cylinders is broken due to the fact that the corresponding DT presents a deviation and more than 50% of the SDTs related to that DT also present deviations.
- The trend of the temperature is higher than expected or maximum.

EXHAUST WATER TEMP.

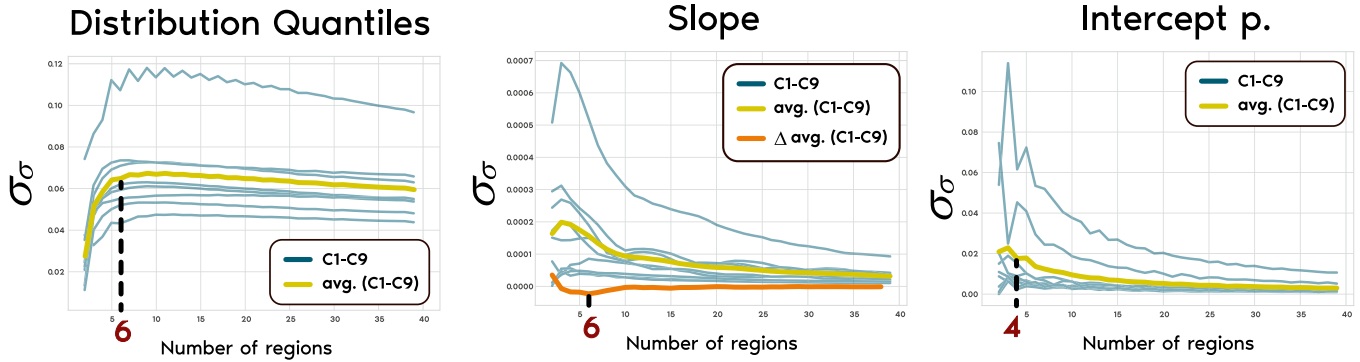

Fig. 14. Number of optimal regions for the features of Exhaust Water temp.

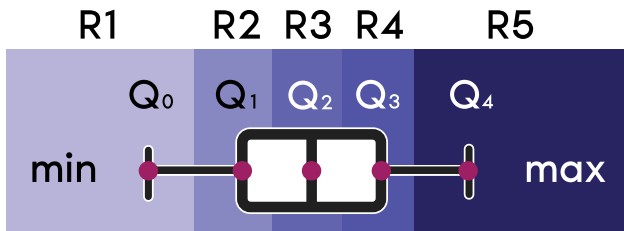

Fig. 15. Five regions are determined by the five quartiles.

- The temperature is above its expected value or belongs to the region of maximum temperatures.

The number of optimal density split quantiles are obtained according to the method explained and scenarios presented in Fig. 7. The results obtained for the features computed for the Exhaust Water temperature are shown in Fig. 14.

Exhaust Water temperature Distribution Quantiles show a topology type (d), Slope values show a topology type (c) and Intercept values present a topology type (b). The number of optimal regions determined for the three features of the Exhaust Water temperature is between 6 and 4. Similar results were obtained for Exhaust gas and Sweeping air temperatures. The final number of equally-sized regions was averaged to 5. This means that the features are split into five regions based on the euclidean distances to the five quartiles, as shown in Fig. 15, where Q_0 and Q_4 are minimum and maximum values, respectively.

Anomalous temperatures are potentially harmful when they are above their reference or expected values. The discrimination of higher-than-expected and lower-than-expected values is critical in the detection of anomalous temperatures. To reduce the influence of low temperatures in the detection of anomalies, R1, R2, and R3 are merged into a single region. This is, Q_0 and Q_1 are discarded.

The results obtained for five quantile splits are shown in Fig. 16. Increasing the number of split quantiles to seven, the number of anomalies detected rises, as shown in Fig. 17. With seven split quantiles, deviations start appearing in Sweeping Air temperatures. According to the expert's assessment, no anomalous behaviors were identified in these temperatures; therefore, they can be considered as false positives. Reducing the number of split quantiles to three, no anomalous behaviors are identified in all the temperatures. Based on the results obtained, the optimum configuration chosen is five split quantiles based on the expert's assessment and events registered.

The results obtained through the SDTs can be summarized as:

- The maintenance task produced variations in water and air exhaust temperatures. An increment in C1 and a decrement in C6 temperatures were detected. It is possible that during the cleaning process of C6, the increment of temperature in C1 can be produced by a fix of its fuel injectors.
- A stop in the system produced a cooling down in the Exhaust Water Temperatures, reducing the anomalies detected in this variable.
- In the last period C6, C7, C8, and C9 show a fast temperature increment, but only C7, C8, and C9 showed an anomalous increment in their temperatures. C6 remains without presenting any anomaly as its temperatures remain below its training set reference values due to the effects of the previous maintenance task. This gradual increment is frequently produced by dirt particles derived from the piston skirt scuffing.

4.3.2. Anomaly detection setting for KPCA

An anomaly is detected when T^2 and SPE (see Appendix) values exceed the maximum value obtained from the preprocessed raw variables of the training set. The number of principal components used can be chosen, defining a threshold of the Cumulative Percent Variance (CPV) determined by:

$$\frac{\sum_{j=1}^p \lambda_j}{\sum_{j=1}^m \lambda_j} > th_{CPV} \quad (8)$$

where p is the number of components selected from a maximum number of m , which coincides with the size of the sliding window. λ is the corresponding eigenvalue of each principal component.

The threshold value chosen is 0.999 due to the fact that for lower threshold values, most of the variables were decomposed into a single principal component reducing its detection capabilities.

4.3.3. Anomaly detection setting for OCSVM

The implementation of the OCSVM is based on Libsvm (Chang and Lin, 2011), the authors of which recommend using polynomial kernels of a small dimension, stating: "if the number of features is large, one may not need to map data to a higher-dimensional space. That is, the nonlinear mapping does not improve the performance". The results obtained using non-linear kernels such as Sigmoid functions or Radial Basis Functions (RBFs) were contrasted with the events registered (maintenance tasks, stop times, and sharp temperature increments), showing no correlation between them.

The parameters required for a polynomial OCSVM setting are the degree of the polynomial and ν , which is an upper bound on the fraction



Fig. 16. Results obtained through SDTs. The anomaly score (0,1,2) corresponds to the variation registered in the feature-slope within anomalous behavior conditions.

of training errors and a lower bound on the fraction of support vectors. Finally, the configuration applied to the OCSVM is a polynomial kernel of 2nd degree. In this case, as the training set is considered free of anomalies, the value of ν was set to 0.999. Increasing the degree of the polynomial to higher degrees produced the same results obtained with a 2nd-degree polynomial kernel.

Due to the fact that there is not an overall “ground truth” in the characterization of the behaviors registered. The selection of the

optimum parameters of the OCSVM was carried out taking into account the temperature logs, the assessment of the expert technicians, and the main events registered throughout the assessment period.

4.4. Results and discussion

The results obtained for each algorithm are presented in Fig. 18. Such results show how the proposed method (Snitch Twins) and the two

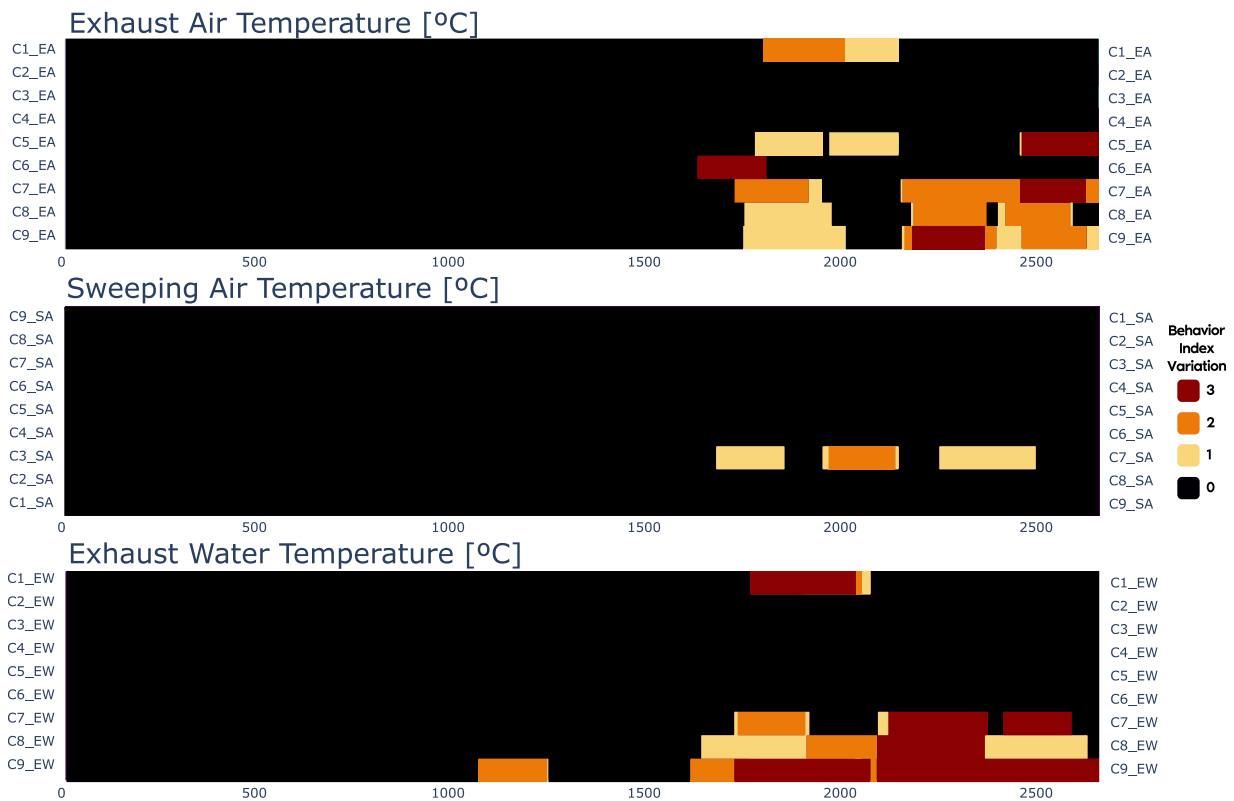

Fig. 17. Results obtained through SDTs increasing the number of equally spaced split quantiles to seven. Q_0 , Q_1 , and Q_2 which correspond to Q_0 , $Q_{0.17}$, and $Q_{0.33}$ were discarded to improve the detection of higher-than-expected temperatures.

Table 2 Comparison of algorithms.

	KPCA	OCSVM	ST
Small training set	~	✓	✓
Physical interpretation of model parameters	X	X	✓
Non binary anomaly characterization	X	X	✓
Relative value analysis	X	X	✓
Contextual behavior analysis	X	X	✓
Shape analysis	✓	X	X

existing algorithms aim to identify anomalous behaviors. The results obtained present a higher similarity between SDTs and OCSVMs than KPCA.

Taking into account the events registered throughout the assessment period (presented at the beginning of Section 4.3), the results obtained through the Snitch Twins are more representative than the ones obtained through KPCA and OCSVM, confront with Fig. 16. This means that the results obtained explain more clearly and understandably the effects that the events registered had over the behavior of the nine cylinders, identifying which cylinders are in a more critical state from a short-term point of view.

A comparison of the algorithms presented in this study is shown in Table 2:

The main differences between these three algorithms are:

- Compatibility with one-sample features. OCSVM and SDT are compatible with learning and processing features of one dimension, e.g. slope or intercept values.
- Physical interpretation of the anomaly detection conditions. In an SDT model, the rules and parameters that determine whether a sample is anomalous or not can be easily tuned and understood from a physical point of view.

- Non-binary anomaly characterization. Only SDT allows for identifying (through binary indicators) and quantifying (through non-binary indicators) anomalies. OCSVM identifies as anomalous any sample outside of the reference hyperplane, and KPCA identifies as anomalous any sample with a T^2 or SPE above the acceptance threshold value.
- Relative value analysis. Only SDT allows for determining whether a sample is below, equal, or above its expected value.
- Contextual behavioral analysis. Only SDT allows for including contextual information obtained from collective behaviors reducing the number of false positives detected.
- Detailed shape analysis. For those applications in which the shape of the time series is critical in the detection of anomalies, KPCA is the most suitable approach. Although this type of assessment produces a higher ratio of false positives in systems with complex behavioral dynamics.

4.5. Improvements achieved in the detection of anomalous behaviors

The proposed SDT method presents multiple improvements in comparison to the two alternative methods proposed in the literature. Three different scenarios were identified in which the proposed algorithm presented a better performance in the characterization of anomalous and normal behaviors. The anomalous behaviors are marked with a red bar. The evaluation of anomalies is carried out based on the assessments of an expert. The scenarios and results presented can be confronted with the results shown in previous Figs. 16 and 18.

The first scenario shown in Fig. 19 presents two cases in the exhaust air temperature of Cylinder 1 (C1_EA).

- (a) Shows an abrupt increment in C1_EA. Temperature values are within normal operating ranges but the rest of the cylinders do not show any increment or abrupt change related to the one registered in C1_EA; therefore, it is considered an incipient

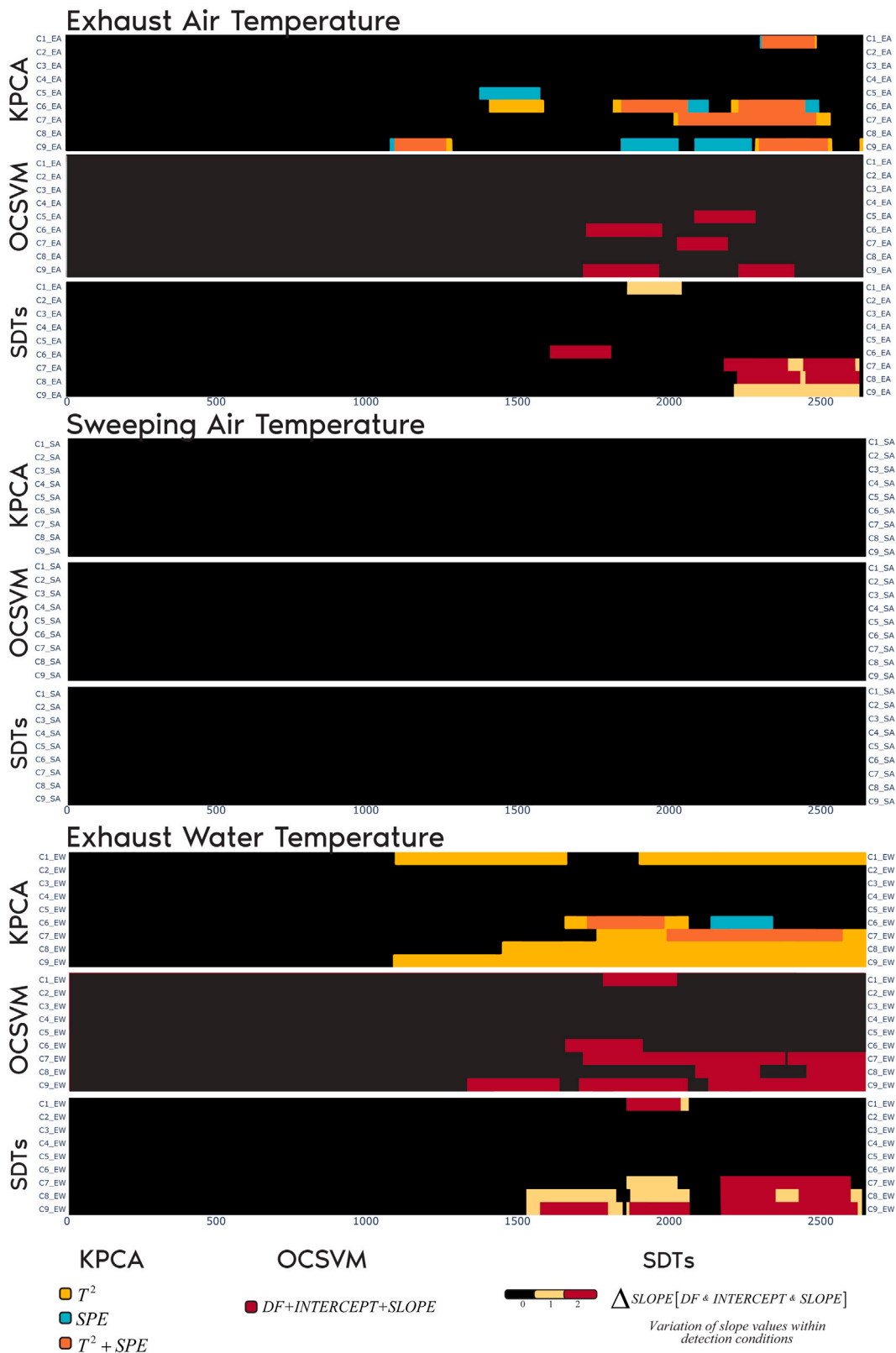

Fig. 18. Comparison of the results obtained with KPCA, OCSVM, and SDTs.

- anomalous behavior. This anomalous behavior was detected by SDTs and categorized as a warning condition.
- (b) C1_EA presents an unusual temperature profile, but its negative trend corresponds to a cooling behavior after an abrupt increment of the temperature. This second scenario can be considered

as a false positive raised by KPCA as cooling temperatures are part of normal behaviors.

The second scenario shown in Fig. 20 presents one case in the exhaust air temperature of Cylinder 6 (C6_EA).

- (a) KPCA, and OCSVM present limitations in classifying sharp transition related to cooling temperatures. This case corresponds to cooling behaviors in the exhaust air temperature of cylinder C6. SDT is capable of identifying faster this type of transition, whereas OCSVM requires a longer period to recognize a normal behavior after the sharp transition took place.

The third scenario shown in Fig. 21 presents how contextual and collective anomalies can influence the assessment of behaviors. In this third scenario KPCA, OCSVM and SDT obtained similar results assessing the Exhaust Water Temperature of Cylinders 7, 8, and 9 (C7_EW, C8_EW, and C9_EW, respectively), except two particular cases in which SDT presents slight variations taking into account collective and contextual behaviors:

- (a) SDT is capable of considering collective deviations in several cylinders produced by high-stress conditions. This case of collective deviations is part of a contextual working condition and is not considered an anomalous behavior by the SDT, which is able to identify that the change in the temperature trends is produced by contextual working conditions instead of multiple local deviations.
- (b) SDT is also capable of recognizing other contextual conditions. In this case, although temperatures are slightly higher than the ones observed in the training set, the trends registered belong to stable (low stress) conditions. Later, steeper trends start appearing raising again the anomalous behavior signals.

According to the results obtained, KPCA shows a higher ratio of false-positive anomalies than OCSVM and SDTs. Only SDT was able to efficiently manage contextual and collective behaviors, improving the characterization of behaviors tagged as anomalous by the other two

algorithms. The results obtained were contrasted with the assessment of an expert shown in Fig. 22 in order to evaluate the effectiveness of the algorithms presented corresponding to the variables C7_EW, C8_EW, C9_EW, C6_E in which several anomalous behaviors were identified.

The numerical assessment of each approach is based on the amount of True Positive (TP), True Negative (TN), False Positive (FP), and False Negative (FN) samples. Each approach is assessed through its True Positive Ratio (TPR), True Negative Ratio (TNR), False Positive Ratio (FPR), False Negative Ratio (FNR), and Accuracy (ACC). The formulation and the results obtained for each metric, temperature variable, and method are shown in Table 3.

The results obtained show an outstanding improvement in the accuracy achieved through SDT, around 14% in comparison to the second best method based on OCSVM. These results prove the soundness of the methodology proposed and its benefits in comparison to other common approaches.

5. Future contributions

SDT is an open methodology in which future contributions can be considered to improve the characterization of behaviors. The first aspect to be considered in future works is the integration of additional features. A good starting point would be considering some of the features presented in Barandas et al. (2020) grouped into Temporal domain, Statistical domain, and Spectral-domain features. This contribution might be complemented with dimensionality reduction techniques applied to the reference index patterns used to define the behaviors within the DT ecosystem. A second contribution might be the study of behavior-data augmentation applied to the field of missing behaviors reconstruction based on the information provided by linked SDTs.

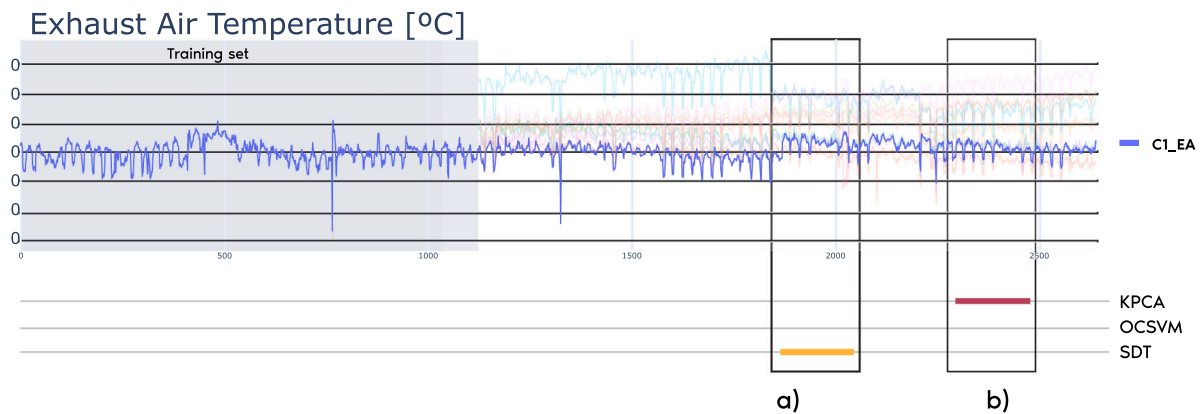

Fig. 19. Improvements in the detection of sharp transitions.

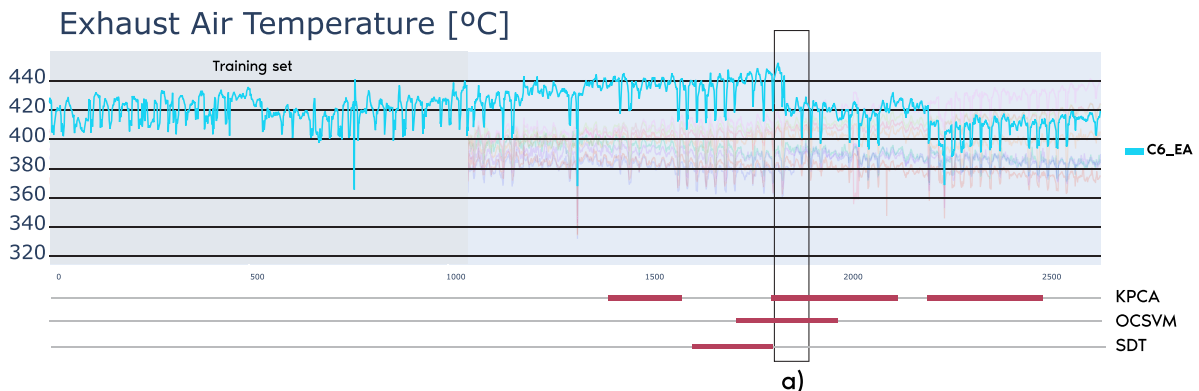

Fig. 20. Improvements in anomaly detection based on relative values.

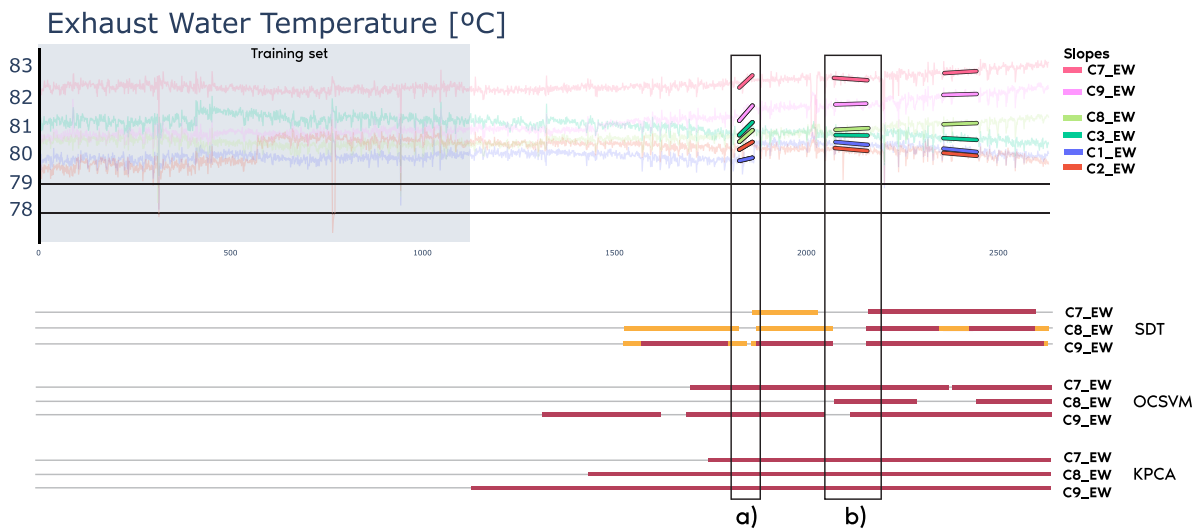

Fig. 21. Improvements in the detection of anomalous behaviors based on collective and contextual knowledge.

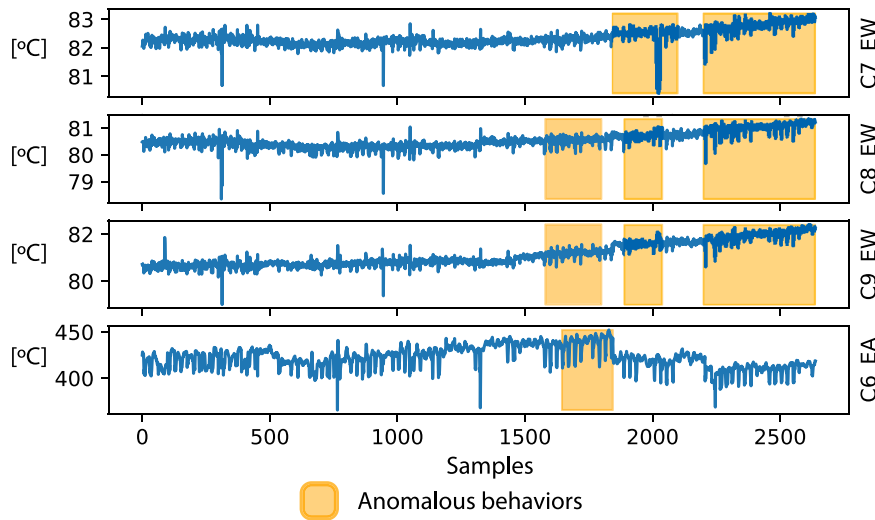

Fig. 22. Identification of anomalous behaviors determined by an expert technician.

Table 3
Comparison of accuracies of the three different methods proposed.

	SDT		OCSVM		KPCA	
C7_EW	0.8011	0.023	0.993	0.125	1	0.159
	0.1988	0.977	0.007	0.875	0	0.841
	0.889		0.848		0.811	
C8_EW	0.984	0.092	0.351	0.07	1	0.267
	0.016	0.908	0.649	0.93	0	0.733
	0.890		0.602		0.702	
C9_EW	0.984	0.11	0.92	0.243	1	0.452
	0.016	0.89	0.08	0.757	0	0.548
	0.869		0.689		0.495	
C6_EA	0.735	0.021	0.63	0.053	0.77	0.406
	0.265	0.979	0.37	0.947	0.23	0.594
	0.936		0.877		0.367	
avg.	0.876	0.057	0.7234	0.123	0.943	0.321
	0.124	0.943	0.2765	0.877	0.057	0.679
	0.895		0.754		0.593	

TPR	FPR
FNR	TNR
ACC	

$$TPR = \frac{TP}{TP + FN}$$

$$TNR = \frac{TN}{TN + FP}$$

$$FNR = \frac{FN}{FN + TP}$$

$$FPR = \frac{FP}{FP + TN}$$

$$ACC = \frac{TP + TN}{TP + TN + FP + FN}$$

6. Conclusions

This paper proposes a novel methodology of anomaly detection compatible with Digital Twin applications. This methodology is based on the characterization of behaviors based on DT networks. The concept of Snitch Digital Twins, which are behavior models used to identify variations between other DT's behaviors, is proposed for the identification of contextual behaviors which are especially relevant for the detection of anomalies in multi-agent systems. The features proposed to characterize a behavior are its density distribution based on quantiles, slope, and intercept values. This study presents a comparison of the goodness of this methodology regarding other traditional algorithms based on Kernel Principal Component Analysis and One-Class Support Vector Machines. This comparison is presented through a real case focused on the thermal diagnosis of a diesel engine. The results obtained show the goodness and advantages of the proposed methodology compared to other traditional approaches.

CRedit authorship contribution statement

Pablo Calvo-Bascones: Conceptualization, Methodology, Software, Writing – original draft. **Alexandre Voisin:** Writing – review. **Phuc Do:** Writing – review. **Miguel A. Sanz-Bobi:** Data curation, Writing – minor review, Funding acquisition.

Appendix

Two existing anomaly detection algorithms are Kernel Principal Component Analysis (KPCA) and Once Class Support Vector Machines (OCSVM).

A.1. KPCA

PCs are defined as orthogonal linear transformations of the data into a new coordinate system. Each axis of the new coordinate system is perpendicular to the rest of the axis, maximizing the variance of the data projected on each of the new axes. The directions of the axes are determined by the eigenvectors obtained from the original space, and the variance of each axis is proportional to the eigenvalue of each eigenvector.

Studies like (Sun et al., 2020), propose an anomaly detection method based on a KPCA approach. The commonly used fault detection indexes in PCA are the Hotelling T^2 and the Squared Prediction Error (SPE) indicators:

$$\begin{cases} T^2 = [t_1, t_2, \dots, t_d] A^{-1} [t_1, t_2, \dots, t_d]^T \\ SPE = \sum_{i=1}^m t_i^2 - \sum_{i=1}^d t_i^2 \end{cases} \quad (9)$$

where $A = \text{diag}(\lambda_1, \dots, \lambda_d)$ are the eigenvalues obtained for a set of eigenvectors $[\alpha_1, \alpha_2, \dots, \alpha_d]$. $[t_1, t_2, \dots, t_d]$ which are the projection of the original samples $[t_1, t_2, \dots, t_m]$ into the space defined by the eigenvectors obtained. The maximum values obtained throughout the training set determine reference threshold values for T^2 and SPE .

A.2. OCSVM

OCSVM is an unsupervised learning method based on SVMs. The task of an OCSVM is the projection of a set of samples into a higher dimensional space. A hyperplane or hypersphere is used to determine the limits of the projected samples minimizing the volume of the hypersphere or the distance of the hyperplane to the reference points. Those points at the other side of the hyperplane or outside the hypersphere are considered anomalous. In Schölkopf et al. (2001) can be found a detailed description of the algorithm and in Ghafoori et al. (2018) an effective tuning process of the parameters of the hyperplane.

OCSVMs implementations based on Libsvm (Chang and Lin, 2011) can be found in previous studies such as Tian et al. (2011).

References

- Abid, F.B., Sallem, M., Braham, A., 2020. Robust interpretable deep learning for intelligent fault diagnosis of induction motors. *IEEE Trans. Instrum. Meas.* 69 (6), 3506–3515.
- Akbari, M., Rezaei, M., Jomhoori, S., Fakoor, V., 2019. Nonparametric estimators for quantile density function under length-biased sampling. *Comm. Statist. Theory Methods* 48 (19), 4918–4935.
- Alves de Araujo Junior, C.A., Mauricio Villanueva, J.M., de Almeida, R.J.S., Azevedo de Medeiros, I.E., 2021. Digital twins of the water cooling system in a power plant based on fuzzy logic. *Sensors* 21 (20), 6737.
- Barandas, M., Folgado, D., Fernandes, L., Santos, S., Abreu, M., Bota, P., Liu, H., Schultz, T., Gamboa, H., 2020. TSFEL: time series feature extraction library. *SoftwareX* 11, 100456.
- Barbado, A., Corcho, Ó., Benjamins, R., 2022. Rule extraction in unsupervised anomaly detection for model explainability: application to OneClass SVM. *Expert Syst. Appl.* 189, 116100.
- Calvo-Bascones, P., Sanz-Bobi, M.A., Welte, T.M., 2021. Anomaly detection method based on the deep knowledge behind behavior patterns in industrial components. application to a hydropower plant. *Comput. Ind.* 125, 103376.
- Castellani, A., Schmitt, S., Squartini, S., 2021. Real-world anomaly detection by using digital twin systems and weakly supervised learning. *IEEE Trans. Ind. Inf.* 17 (7), 4733–4742.
- Chandola, V., Banerjee, A., Kumar, V., 2009. Anomaly detection: A survey. *ACM Comput. Surv.* 41 (3), 1–58.
- Chang, C.-C., Lin, C.-J., 2011. LIBSVM: A library for support vector machines. *ACM Trans. Intell. Syst. Technol. (TIST)* 2, 27:1–27:27, Software available at <http://www.csie.ntu.edu.tw/~cjlin/libsvm>.
- Cheng, H., Shi, Y., Wu, L., Guo, Y., Xiong, N., 2021. An intelligent scheme for big data recovery in internet of things based on multi-attribute assistance and extremely randomized trees. *Inform. Sci.* 557, 66–83.
- Dhiman, H.S., Deb, D., Muyeen, S.M., Kamwa, I., 2021. Wind turbine gearbox anomaly detection based on adaptive threshold and twin support vector machines. *IEEE Trans. Energy Convers.* 36 (4), 3462–3469.
- Erhan, L., Ndubuaku, M., Di Mauro, M., Song, W., Chen, M., Fortino, G., Bagdasar, O., Liotta, A., 2021. Smart anomaly detection in sensor systems: A multi-perspective review. *Inf. Fusion* 67, 64–79.
- Falekas, G., Karlis, A., 2021. Digital twin in electrical machine control and predictive maintenance: state-of-the-art and future prospects. *Energies* 14 (18), 5933.
- Gaikwad, A., Yavari, R., Montazeri, M., Cole, K., Bian, L., Rao, P., 2020. Toward the digital twin of additive manufacturing: integrating thermal simulations, sensing, and analytics to detect process faults. *IIEE Trans.* 52 (11), 1204–1217.
- Ghafoori, Z., Erfani, S.M., Rajasegarar, S., Bezdek, J.C., Karunasekera, S., Leckie, C., 2018. Efficient unsupervised parameter estimation for one-class support vector machines. *IEEE Trans. Neural Netw. Learn. Syst.* 29 (10), 5057–5070.
- Gil, A., Sanz-Bobi, M.A., Rodríguez-López, M.A., 2018. Behavior anomaly indicators based on reference patterns—application to the gearbox and electrical generator of a wind turbine. *Energies* 11 (1), 87.
- Grievens, M., 2007. Multiplying MES value with PLM integration. Whitepaper, March.
- Guo, J., Li, Z., Li, M., 2020. A review on prognostics methods for engineering systems. *IEEE Trans. Reliab.* 69 (3), 1110–1129.
- Guo, K., Wan, X., Liu, L., Gao, Z., Yang, M., 2021. Fault diagnosis of intelligent production line based on digital twin and improved random forest. *Appl. Sci.* 11 (16), 7733.
- Guo, F., Zou, F., Liu, J., Wang, Z., 2018. Working mode in aircraft manufacturing based on digital coordination model. *Int. J. Adv. Manuf. Technol.* 98 (5), 1547–1571.
- Hariri, S., Kind, M.C., Brunner, R.J., 2021. Extended isolation forest. *IEEE Trans. Knowl. Data Eng.* 33 (4), 1479–1489.
- He, R., Chen, G., Dong, C., Sun, S., Shen, X., 2019. Data-driven digital twin technology for optimized control in process systems. *ISA Trans.* 95, 221–234.
- Huang, Z., Shen, Y., Li, J., Fey, M., Brecher, C., 2021a. A survey on AI-driven digital twins in industry 4.0: smart manufacturing and advanced robotics. *Sensors* 21 (19), 6340.
- Huang, H., Yang, L., Wang, Y., Xu, X., Lu, Y., 2021b. Digital twin-driven online anomaly detection for an automation system based on edge intelligence. *J. Manuf. Syst.* 59, 138–150.
- Kerpicci, M., Ozkan, H., Kozat, S.S., 2021. Online anomaly detection with bandwidth optimized hierarchical kernel density estimators. *IEEE Trans. Neural Netw. Learn. Syst.* 32 (9), 4253–4266.
- Khan, S., Farnsworth, M., McWilliam, R., Erkoynucu, J., 2020. On the requirements of digital twin-driven autonomous maintenance. *Annu. Rev. Control* 50, 13–28.
- Kunath, M., Winkler, H., 2018. Integrating the digital twin of the manufacturing system into a decision support system for improving the order management process. 51st CIRP Conference on Manufacturing Systems, Procedia CIRP 51st CIRP Conference on Manufacturing Systems, 72.225–231.
- Leukel, J., González, J., Riekert, M., 2021. Adoption of machine learning technology for failure prediction in industrial maintenance: A systematic review. *J. Manuf. Syst.* 61, 87–96.

- Li, Y., Fang, H., Chen, J., 2020. Anomaly detection and identification for multiagent systems subjected to physical faults and cyberattacks. *IEEE Trans. Ind. Electron.* 67 (11), 9724–9733.
- Li, D., Gebraeel, N., Paynabar, K., 2021. Detection and differentiation of replay attack and equipment faults in SCADA systems. *IEEE Trans. Autom. Sci. Eng.* 18 (4), 1626–1639.
- Lindemann, B., Fesenmayr, F., Jazdi, N., Weyrich, M., 2019. Anomaly detection in discrete manufacturing using self-learning approaches. 12th CIRP Conference on Intelligent Computation in Manufacturing Engineering, 18-20 July 2018, Gulf of Naples, Italy, *Procedia CIRP* 12th CIRP Conference on Intelligent Computation in Manufacturing Engineering, 18-20 July 2018, Gulf of Naples, Italy, 79.313–318.
- Lu, Q., Chen, L., Li, S., Pitt, M., 2020. Semi-automatic geometric digital twinning for existing buildings based on images and CAD drawings. *Autom. Constr.* 115, 103183.
- Manders, E.-J., Biswas, G., Mosterman, P., Barford, L., Barnett, R., 2000. Signal interpretation for monitoring and diagnosis, a cooling system testbed. *IEEE Trans. Instrum. Meas.* 49 (3), 503–508.
- Melesse, T.Y., Di Pasquale, V., Riemma, S., 2021. Digital twin models in industrial operations: state-of-the-art and future research directions. *IET Collab. Intell. Manuf.* 3 (1), 37–47.
- Mensi, A., Bicego, M., 2021. Enhanced anomaly scores for isolation forests. *Pattern Recognit.* 120, 108115.
- Moyne, J., Qamsane, Y., Balta, E.C., Kovalenko, I., Faris, J., Barton, K., Tilbury, D.M., 2020. A requirements driven digital twin framework: specification and opportunities. *IEEE Access* 8, 107781–107801.
- Oluwasegun, A., Jung, J.-C., 2020. The application of machine learning for the prognostics and health management of control element drive system. *Nucl. Eng. Technol.* 52 (10), 2262–2273.
- Piltan, F., Kim, J.-M., 2021. Bearing anomaly recognition using an intelligent digital twin integrated with machine learning. *Appl. Sci. (Switzerland)* 11 (10).
- Pukelsheim, F., 1994. The three sigma rule. *Amer. Statist.* 48 (2), 88–91.
- Saeed, U., Jan, S.U., Lee, Y.-D., Koo, I., 2021. Fault diagnosis based on extremely randomized trees in wireless sensor networks. *Reliab. Eng. Syst. Saf.* 205, 107284.
- Saez, M.A., Maturana, F.P., Barton, K., Tilbury, D.M., 2020. Context-sensitive modeling and analysis of cyber-physical manufacturing systems for anomaly detection and diagnosis. *IEEE Trans. Autom. Sci. Eng.* 17 (1), 29–40.
- Schluse, M., Priggemeyer, M., Atorf, L., Rossmann, J., 2018. Experimentable digital twins—streamlining simulation-based systems engineering for industry 4.0. *IEEE Trans. Ind. Inf.* 14 (4), 1722–1731.
- Schölkopf, B., Platt, J.C., Shawe-Taylor, J., Smola, A.J., Williamson, R.C., 2001. Estimating the support of a high-dimensional distribution. *Neural Comput.* 13 (7), 1443–1471.
- Simmini, F., Rampazzo, M., Peterle, F., Susto, G.A., Beghi, A., 2021. A self-tuning KPCA-based approach to fault detection in chiller systems. *IEEE Trans. Control Syst. Technol.* 1–16.
- Sun, H., Guo, Y., Zhao, W., 2020. Fault detection for aircraft turbofan engine using a modified moving window KPCA. *IEEE Access* 8, 166541–166552.
- Tian, J., Gu, H., Gao, C., Lian, J., 2011. Local density one-class support vector machines for anomaly detection. *Nonlinear Dynam.* 64 (1), 127–130.
- Tripathi, A.M., Baruah, R.D., 2020. Contextual anomaly detection in time series using dynamic Bayesian network. In: Nguyen, N.T., Jearanaitanakij, K., Selamat, A., Trawiński, B., Chittayasothorn, S. (Eds.), *Intelligent Information and Database Systems*. In: *Lecture Notes in Computer Science*, Springer International Publishing, Cham, pp. 333–342.
- Twiddle, J.A., Jones, N.B., 2002. Fuzzy model-based condition monitoring and fault diagnosis of a diesel engine cooling system. 216, p. 10.
- Uhlemann, T.H.J., Schock, C., Lehmann, C., Freiburger, S., Steinhilper, R., 2017. The digital twin: demonstrating the potential of real time data acquisition in production systems. 7th Conference on Learning Factories, CLF 2017, *Procedia Manuf.* 7th Conference on Learning Factories, CLF 2017, 9.113–120.
- Vogel-Heuser, B., Ocker, F., Weiß, I., Mieth, R., Mann, F., 2021. Potential for combining semantics and data analysis in the context of digital twins. *Phil. Trans. R. Soc. A* 379 (2207), 20200368.
- Xia, M., Shao, H., Williams, D., Lu, S., Shu, L., de Silva, C.W., 2021. Intelligent fault diagnosis of machinery using digital twin-assisted deep transfer learning. *Reliab. Eng. Syst. Saf.* 215, 107938.
- Xu, Q., Ali, S., Yue, T., 2021. Digital twin-based anomaly detection in cyber-physical systems. In: 2021 14th IEEE Conference on Software Testing, Verification and Validation (ICST). pp. 205–216.
- Zonta, T., da Costa, C.A., da Rosa Righi, R., de Lima, M.J., da Trindade, E.S., Li, G.P., 2020. Predictive maintenance in the industry 4.0: A systematic literature review. *Comput. Ind. Eng.* 150, 106889.