



HAL
open science

Effect of Gamma-Irradiation on Creation and Dynamic of Space Charge in PTFE

A. Mezouar, Virginie Griseri, N. Saidi-Amroun, G. Teyssedre, M. Saidi

► **To cite this version:**

A. Mezouar, Virginie Griseri, N. Saidi-Amroun, G. Teyssedre, M. Saidi. Effect of Gamma-Irradiation on Creation and Dynamic of Space Charge in PTFE. 2022 IEEE 4th International Conference on Dielectrics (ICD 2022), Jul 2022, Palermo, Italy. pp.553-556, 10.1109/ICD53806.2022.9863233 . hal-03784574

HAL Id: hal-03784574

<https://hal.science/hal-03784574>

Submitted on 23 Sep 2022

HAL is a multi-disciplinary open access archive for the deposit and dissemination of scientific research documents, whether they are published or not. The documents may come from teaching and research institutions in France or abroad, or from public or private research centers.

L'archive ouverte pluridisciplinaire **HAL**, est destinée au dépôt et à la diffusion de documents scientifiques de niveau recherche, publiés ou non, émanant des établissements d'enseignement et de recherche français ou étrangers, des laboratoires publics ou privés.

Effect of Gamma-Irradiation on Creation and Dynamic of Space Charge in PTFE

¹A. Mezouar, ²V. Griseri, ¹N. Saidi-Amroun, ²G. Teyssède, ¹M. Saidi

¹Material Physics Laboratory, Physics Faculty, University of Sciences and Technology (USTHB), BP 32 El-Alia, Bab-Ezzouar, Algiers, Algeria.

²LAPLACE, University of Toulouse, CNRS, INPT, UPS, Toulouse, France.

Abstract- Electrical properties of polymers undergo significant changes when exposed to ionizing radiation which may alter insulation reliability in radiative environment. The aim of this work is to investigate the effect of gamma-irradiation on the creation and the dynamic of space charges in PolyTetraFluoroEthylene (PTFE). The 200 μm thick PTFE films were exposed to a ^{60}Co gamma radiation source to different doses 30, 60 and 100 kGy at a constant dose rate. Space charge measurements were achieved by Pulsed Electro-Acoustic method under a field of 40 kV/mm on virgin and irradiated films. Unlike in virgin sample, positive and negative heterocharges were observed in a few minutes after irradiation. The results highlight the creation of pair of charges and the structural modification of the polymer that enhances their mobility. These space charge effects go with a strong increase of the polymer conductivity.

I. INTRODUCTION

For several decades, one of the main uses of PolyTetraFluoroEthylene (PTFE) has been to insulate electrical wires in many industrial sectors, including nuclear facilities and the aerospace industry [1], where extreme conditions such as radiation and high temperatures exist [2], [3].

The polymer may be degraded by ionizing radiation through processes such as chain scission when exposed to a high dose of gamma radiation [4]. This may also cause the formation of space charges within the polymer, as seen in crosslinked polyethylene (XLPE). For the latter, changes in the electrical behavior has been related to radiation-induced structural changes [5] [6]. Many studies have shown that space charges contribute to the electrical behavior of XLPE. A substantial amount of research has been conducted on the origin and effect of space charge formation on dielectric reliability [6–8]. Conversely, the origin of the space charge in PTFE is still poorly understood. Thus, it is of great importance to study the effect of irradiation on the formation and dynamics of space charge in PTFE to avoid undesirable effects such as breakdown or premature aging.

In this work, experimental research was carried out to investigate the effect of gamma-irradiation on the creation and dynamic of space charge in PTFE. PTFE thin films of 200 μm were exposed to gamma irradiation in the air at room temperature at various doses in the range [30-100 kGy]. The Pulsed Electro-Acoustic (PEA) method was used to quantify space charge [9].

II. EXPERIMENTAL SET-UP

A. PTFE Samples

The PTFE samples used in this investigation are commercially available PTFE supplied by Goodfellow. Films with a thickness of 200 μm were used as best fitted for PEA measurements.

B. Gamma Irradiation

PTFE samples of 5x5 cm² area were irradiated in air at room temperature air at the Nuclear Research Centre of Algiers, Algeria. A ^{60}Co gamma radiation source provided a dose rate of 22 Gy/min. Doses from 30 to 100 kGy were applied, representing up to 6 months of continuous irradiation.

C. Space Charge Measurements

Fig. 1 shows the scheme of the experimental set-up used for the present experiments. Experiments were carried out at room temperature and atmosphere. A semi conductive layer (a carbon black doped polymer) [10] is placed between the top electrode and the sample to ensure electrical contact and acoustic impedance matching with the sample. Pulses of 250 V amplitude and frequency of 2 kHz were applied from the top electrode. The charging potential is also applied from this electrode. On the bottom side the sample is in contact with an aluminum ground electrode. The space charge profiles were recorded every 60 seconds along the stress cycle. Samples were stressed (Volts-On) under a field of 40 kV/mm applying a

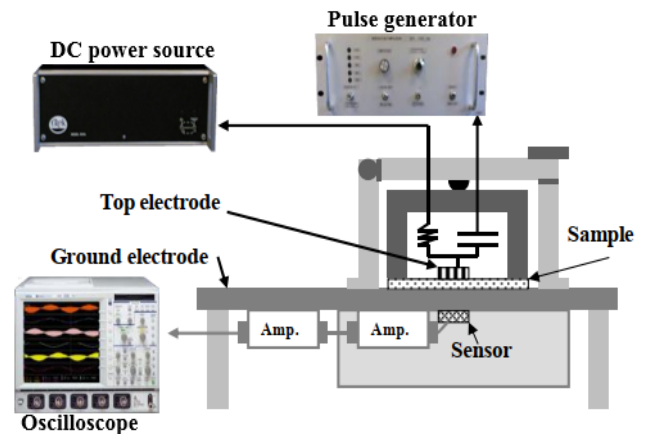

Fig. 1. The Pulse Electro-Acoustic (PEA) set-up of space charge measurement.

positive DC voltage for 1 h with a rising rate of 1 kV/mm/s. Then, the charge distributions were recorded immediately after removing the applied voltage for 1 h (Volts Off).

Results presented here concern a virgin sample and irradiated ones at doses of 30, 60 and 100 kGy. Samples were not metallized prior to measurements, therefore electrodes are aluminum to the ground and semicon on the high voltage side.

It should be noted that with the rising rate selected, it takes 40 s to reach the target electric field value. During this rising time period, the space charge distribution is interrupted to prevent any averaging while the signal is growing.

III. EXPERIMENTAL RESULTS

A. Space Charge Distribution in Virgin PTFE

Benchmark was achieved on a non-irradiated sample. Though profiles were recorded all along the polarization and depolarization steps, we in Fig. 2 only the profiles at the beginning and end of the polarization under 40 kV/mm and depolarization steps, each lasting for 60 min.

PTFE is a relatively dispersive material for the acoustic wave, hence the signal to the top electrode is broad. Here, will focus our attention on the signal detected close to the ground electrode (left part of Fig. 2) where the resolution is better. During voltage application the signal shows a small variation, with a trend to a decrease of the influence charge peak. After voltage removal, a very small quantity of injected negative charges are detected in the bulk while positive induced charges are observed on the surface. After one hour of relaxation, the amount of negative charge decays gradually while the positive image peak at the surface grows slightly. We will consider that the creation of space charge at 40 kV/mm for the non-irradiated sample remains very small ($< 4 \text{ C/m}^3$) and is essentially injected charges.

B. The Dynamics of Space Charge in Gamma-Irradiated PTFE.

Fig. 3 shows space charge results from an PTFE sample irradiated at 30 kGy during 60 min of polarization.

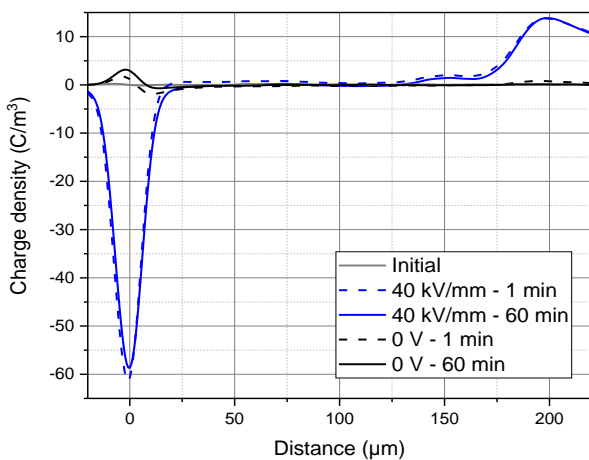

Fig. 2. Charge profiles of a 200 μm -thick virgin PTFE during polarization (Volt On) for 60 min under 40 kV/mm and 60 min of relaxation (Volt Off).

Charge dynamics in a 30 kGy irradiated sample are quite different from those in a non-irradiated sample. At first glance, in the first instants when an electric field is applied, a considerable amount of charges builds-up deep in the bulk. This seems a common feature for the irradiated PTFE samples as shown below. A negative charge region develops in the front of the anode and a negative one in front of the cathode. The positive heterocharge grows and moves slowly towards the cathode. As a result of this there is a relative increase of the electric field at the cathode. On the anode side, even if the resolution is not so good we can see that almost all of the negative heterocharges remain static and do not really evolve over time.

Fig 4 shows the relaxation of space charge during 60 min following the removal of the applied voltage. The positive heterocharges in the bulk decay slowly with the peak maximum remaining stable in position. On the other hand, the negative peak of heterocharges splits in two. It appears that one part of the charges remains close to the pre-Anode while the other part migrates in the direction of the positive charges region. Because

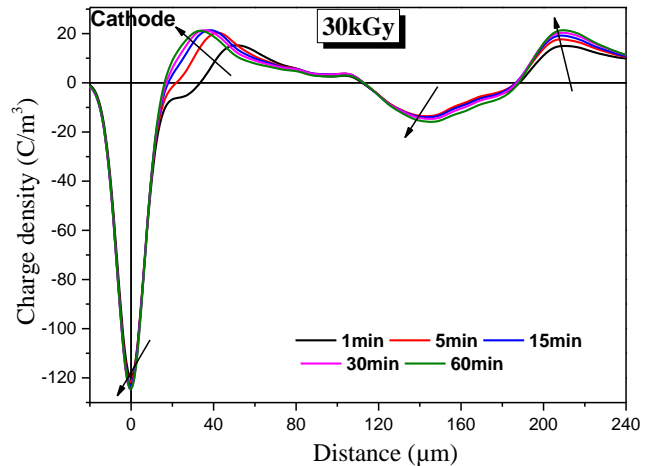

Fig. 3. Charge profile dynamics recorded during 60 min polarization under 40 kV/mm in a 30 kGy irradiated PTFE sample

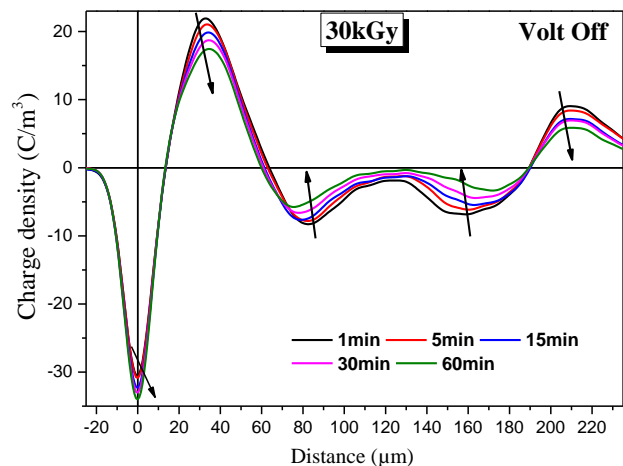

Fig. 4. Charge relaxation during 60 min in a 30 kGy irradiated PTFE sample after charging for 60 min under 40 kV/mm.

negative charges are displaced towards the bulk in comparison to virgin PTFE, we postulate that positive charges are recombined with negative charges. When the applied voltage is removed, a new behavior emerges due to charge movement driven by the space charge own electric field. Negative charges (electrons) are apparently more mobility than positive ones. As negative heterocharges move more freely under the influence of their own field, the charge might leak from electrodes or be recombined [11].

Space charge measurement results obtained in the same conditions as above for a dose of 60 kGy are shown in Fig. 5. Globally, the same behavior as for 30 kGy is obtained, though with an increased magnitude, whether in polarization (Fig. 5) or in relaxation (not shown). The charge peak exceeds 30 C/m³ and the profile builds up nearly instantaneously.

Fig. 6 shows the charge distribution in a PTFE sample exposed to 100 kGy of gamma-irradiation during polarization under 40 kV/mm. Even if the radiation dose is increased to 100 kGy, the charge dynamics is similar to the one observed with 30 and 60 kGy. Once again, an abundance of negative and positive heterocharges are detected in the bulk in the vicinity of the anode and cathode. The charge peak here is twice as that for a those of 30 kGy. The build-up of the heterocharge region is very fast and does not evolve with time as is was the case in the sample irradiated with 30 kGy.

Charge dynamics during the relaxation in the 100 kGy irradiated PTFE is shown in Fig. 7. As soon as the polarization is stopped the positive peak of heterocharges close to the pre-cathode starts to decay. While the positive peak decays in amplitude, there is a shift toward the ground electrode. In the present case a large amount of negative mobile charges move into the bulk of the sample due to its own electric field. Recombination with positive ions may have led to the reduction in heterocharge after the voltage was removed. Note that at the end of the 1 h relaxation all internal charges have disappeared though an influence charge on the ground electrode remains. This behavior is possibly related to the build-up of orientation polarization in the material. It could result from the formation of polar groups under the effect of the irradiation.

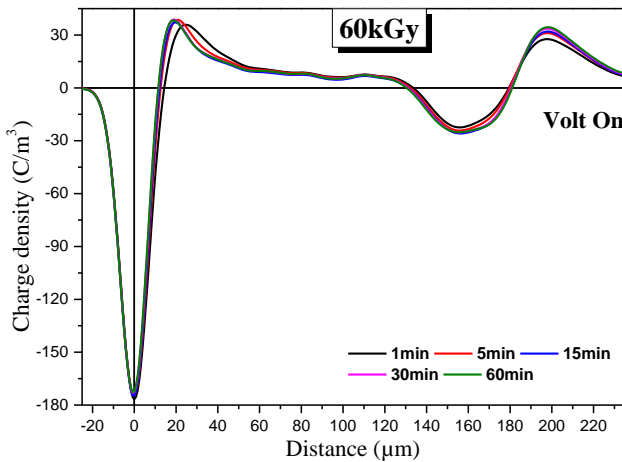

Fig. 5. Charge build-up in 60 kGy irradiated sample recorded during polarization for 60 min under 40 kV/mm.

IV. DISCUSSION

The manner in which space charge distributions decay varies depending on the dose. When comparing a 30 kGy to a 100 kGy irradiated sample, one can say that 60 minutes of relaxation is nearly sufficient to dissipate all of the charges present in the bulk of the sample if the dose is high enough to modify the internal structure.

Indeed, electrical conductivity measurements realized at the same temperature (20 °C) as space charge measurements have revealed an important change of the conductivity in gamma irradiated sample, and the change depends on the dose: in respect to the virgin PTFE, the conductivity for 30 kGy is increased by a factor of ≈ 100 . For 100 kGy, the increase is by a factor of ≈ 200 . These changes can be explained by the cumulative increase of the mobility and density of charges due to gamma irradiation as evidenced by these space charge measurements.

As previously reported [10], PTFE undergoes structural alteration due to degradation by gamma irradiation. The fact that gamma irradiation were performed in the presence of

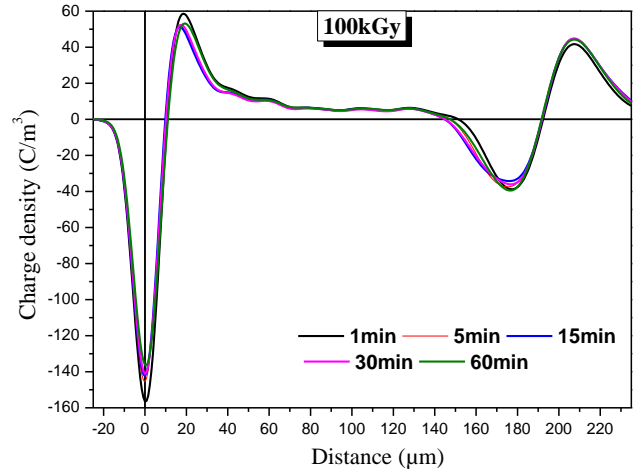

Fig. 6. Charge dynamics in 100 kGy irradiated sample recorded by PEA during polarization for 60 min under 40 kV/mm.

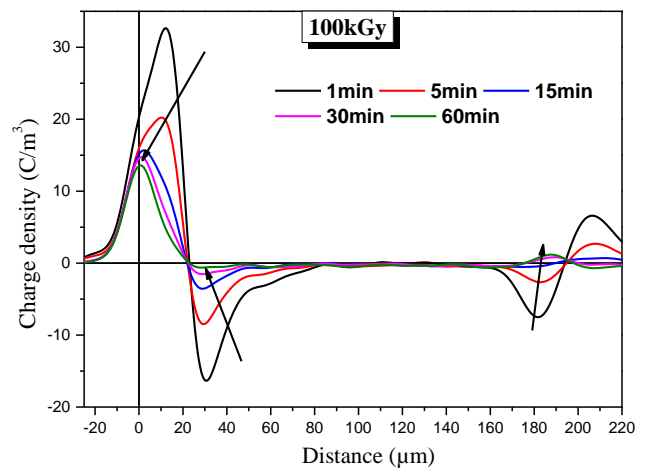

Fig. 7. Charge decay in 100 kGy irradiated sample during relaxation for 60 min after polarization under 40 kV/mm.

oxygen favors chain scission, which leads to a decrease in the average molecular weight [12]. This was confirmed by the presence of carbonyl groups and acid fluoride [5], [13]. The structural changes caused by gamma irradiation also reduce residual stresses in the amorphous phase, which leads to more molecular mobility in the material [12], [14]. The movement of charges in low molecular weight PTFE chains generated by chain scission is thought to be the origin of the emergence of heterocharges in irradiated PTFE.

One probable explanation for the formation of heterocharges is that rising irradiation doses in the air cause an increase in the density of electron-ion pairs and in the concentration of carbonyl groups via chain scission and oxidation reactions [15]. It has been shown that carbonyl groups generate shallow traps that promote charge transport [15].

It is noteworthy that electron-ion pairs arise during gamma radiation when electrons separate from their ions. Most of the electrons remain within the region of influence of the "parent" ions, and the other part can move within the material. However, when the electric field of 40 kV/mm is applied, it looks as mobile electrons have been pushed toward the anode but have left the more stable and less mobile positive ions at the cathode.

One may finally note that as the dose increases, the heterocharge regions stay closer to the electrodes. This may be due to an impact of the dose on the charge mobility. Another possibility is that the material modification is not homogeneous along the insulation thickness and that part of the charge measured is a result of conductivity gradient.

V. CONCLUSIONS

In this work, the motivation behind this investigation was to see how gamma-irradiation affects the generation and dynamics of space charge in PTFE. Significant differences in the space charge profiles of virgin and irradiated PTFE with gamma rays in the presence of oxygen were shown. When the radiation dose is increased, the charge dynamics show an abundance of negative and positive heterocharges.

From previous analyses, the presence of carbonyl groups and acid fluoride confirms that gamma irradiation in the presence of oxygen promotes chain scission, which results in a drop in the average molecular weight. During this work it has been shown that the emergence of space charge in PTFE samples may be an indication of the degree of oxidation and degradation of the material.

ACKNOWLEDGMENT

The authors are grateful to the Director and staff (especially M. R. Yefsah) of the Nuclear Research Centre of Algiers, for the provision of the irradiation facility. The work is supported by French-Algerian Tassili research program in the frame of Partenariat Hubert Curien (PHC) and DGRSDT of Algeria.

- [1] L. Li, N. Bowler, M. R. Kessler, and S. H. Yoon, "Dielectric response of PTFE and ETFE wiring insulation to thermal exposure," *IEEE Trans. Dielectr. Electr. Insul.*, vol. 17, pp. 1234-1241, 2010.
- [2] M. Mohammadian-Kohol, M. Asgari, and H.R. Shakur, "Effect of gamma irradiation on the structural, mechanical and optical properties of polytetrafluoroethylene sheet," *Radiat. Phys. Chem.*, vol. 145, pp. 11-18, 2018.
- [3] S. V. Suraci and D. Fabiani, "Aging Assessment of Insulating Materials Through Broadband Dielectric Measurements: The Appropriate Frequency Choice," in *2021 IEEE Conference on Electrical Insulation and Dielectric Phenomena (CEIDP)*, 2021, pp. 32–35
- [4] S. V. Suraci, D. Fabiani, A. Xu, S. Roland and X. Colin, "Ageing Assessment of XLPE LV Cables for Nuclear Applications Through Physico-Chemical and Electrical Measurements," *IEEE Access*, vol. 8, pp. 27086-27096, 2020.
- [5] W. K. Fisher, "Effect of Ionizing Radiation on the Chemical Composition, Crystallinity, and Processibility of Polytetrafluoroethylene," *J. Ind. Irradiat. Technol.*, vol. 1, pp. 105-139, 1983.
- [6] C. Mouchache, V. Griseri, N. Saidi-Amroun, G. Teyssedre, S. Mouaci, and M. Saidi, "Dynamic of a Space Charge in Gamma-Irradiated Cross-Linked Polyethylene (XLPE)," *Proc. 2020 IEEE 3rd Int. Conf. Dielectr. (ICD)*, 2020, pp. 409-412.
- [7] G. Chen, Y. Tanaka, T. Takada, and L. Zhong, "Effect of Polyethylene Interface on Space Charge Formation," *IEEE Trans. Dielectr. Electr. Insul.*, vol. 11, pp. 113-121, 2004.
- [8] M. Fu and G. Chen, "Space charge measurement in polymer insulated power cables using flat ground electrode PEA system," *IEE Proc. Sci. Meas. Technol.*, vol. 150, npp. 89-96, 2003.
- [9] A. Mezouar, V. Griseri, N. Saidi-Amroun, G. Teyssedre, and M. Saidi, "Effect of Gamma Radiation on Charge Storage in PTFE Exposed to Electron Beam," in *2021 IEEE Conference on Electrical Insulation and Dielectric Phenomena (CEIDP)*, 2021, pp. 367–370.
- [10] N. Saidi-Amroun, S. Mouaci, A. Mezouar, M. Saidi, V. Griseri, and G. Teyssedre, "Analysis of the Gamma Irradiation Effect on PTFE Films by FTIR and DSC," *Annu. Rep. - Conf. Electr. Insul. Dielectr. Phenomena, (CEIDP)*, 2018, pp. 430–433.
- [11] G. Chen and M. Fu, "The influence of gamma irradiation on space charge in LDPE," *Proc. IEEE Int. Conf. Prop. Appl. Dielectr. Mater. (ICPADM)*, 2006, pp. 131-134.
- [12] X. Zhong, L. Yu, W. Zhao, J. Sun, and Y. Zhang, "Radiation-induced crystal defects in PTFE," *Polym. Degrad. Stab.*, vol. 40, pp. 97-100, 1993.
- [13] D. Fischer, U. Lappan, I. Hopfe, K. J. Eichhorn, and K. Lunkwitz, "FTi.r. Spectroscopy on electron irradiated polytetrafluoroethylene," *Polymer*, vol. 39, pp. 573-582, 1998.
- [14] J. Su, G. Wu, Y. Liu, and H. Zeng, "Study on polytetrafluoroethylene aqueous dispersion irradiated by gamma ray," *J. Fluor. Chem.*, vol. 127, pp. 91-96, 2006.
- [15] G. Chen, H. M. Banford, and A. E. Davies, "The influence of gamma radiation on space charge formation in low-density polyethylene," in *Proceedings 2016 Conference on Electrical Insulation and Dielectric Phenomena (CEIDP)*, 1996, vol. 2, pp. 821-824.