



HAL
open science

Controlling the rheology of a solid emulsion with liquid droplets

E Gilbert, A Salonen, C Poulard

► **To cite this version:**

E Gilbert, A Salonen, C Poulard. Controlling the rheology of a solid emulsion with liquid droplets. Annual European Rheology Conference 2021, Apr 2021, Online, France. hal-03781867

HAL Id: hal-03781867

<https://hal.science/hal-03781867>

Submitted on 20 Sep 2022

HAL is a multi-disciplinary open access archive for the deposit and dissemination of scientific research documents, whether they are published or not. The documents may come from teaching and research institutions in France or abroad, or from public or private research centers.

L'archive ouverte pluridisciplinaire **HAL**, est destinée au dépôt et à la diffusion de documents scientifiques de niveau recherche, publiés ou non, émanant des établissements d'enseignement et de recherche français ou étrangers, des laboratoires publics ou privés.

Motivation

Usual viscoelastic materials: coupling of elasticity and viscosity



By Babi Hijau - Photo taken by own, Public Domain, <https://commons.wikimedia.org/w/index.php?curid=2801347>

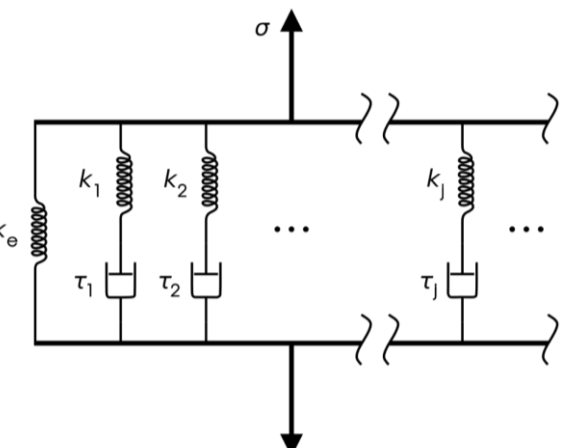

By Pekaje at English Wikipedia - Transferred from en.wikipedia to Commons., Public Domain, <https://commons.wikimedia.org/w/index.php?curid=280267>

Decorrelation of a composite's storage and loss moduli

Sample

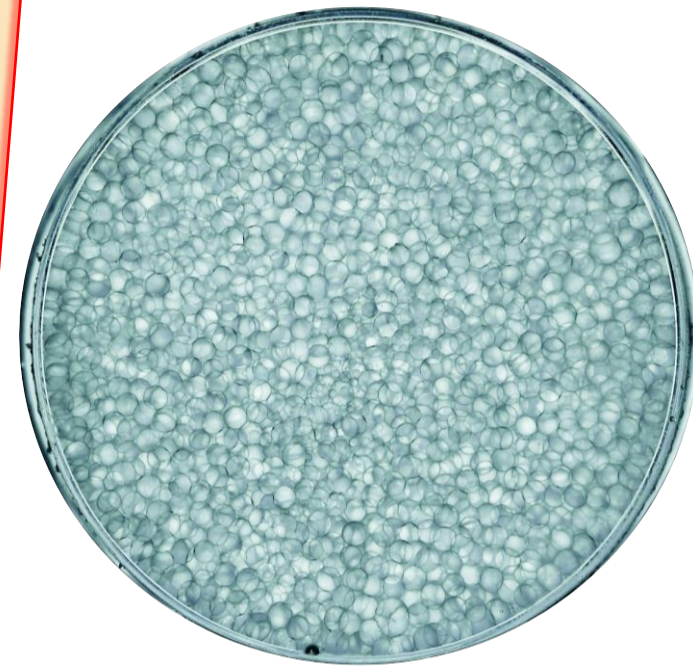

- Solid continuous phase, elastic (PDMS)
- Liquid dispersed phase, Newtonian fluid (PEG)
- Surfactant: block copolymer

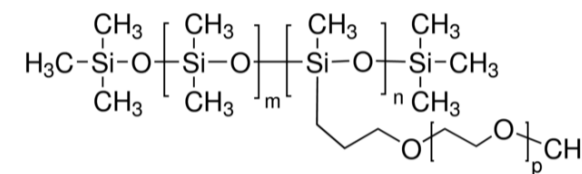
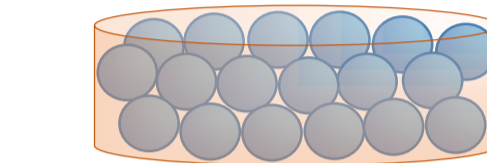

Generation methods:

- Breakup under shear (control over Φ)
- Millifluidic (control over R)

Preliminary results

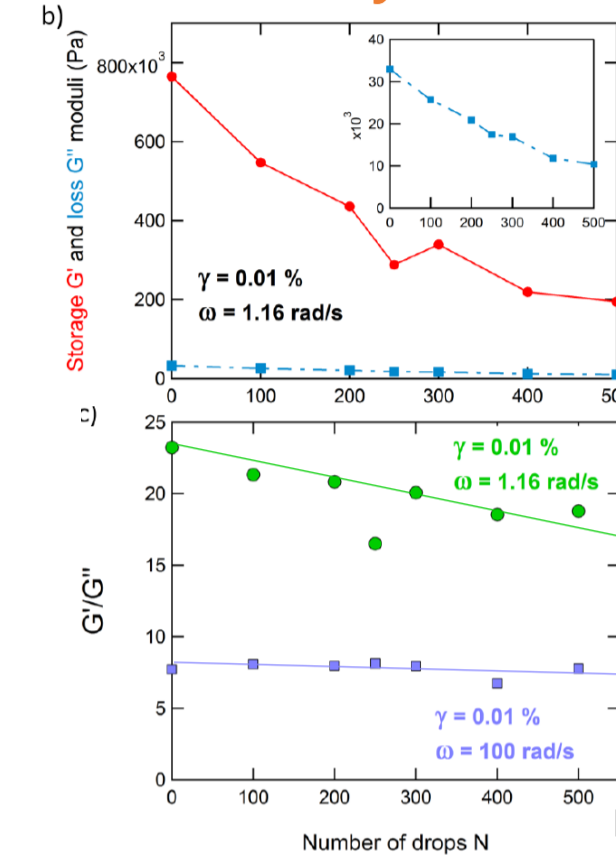

From [1]

What key parameters to observe a larger variation?

Results: Frequency sweep

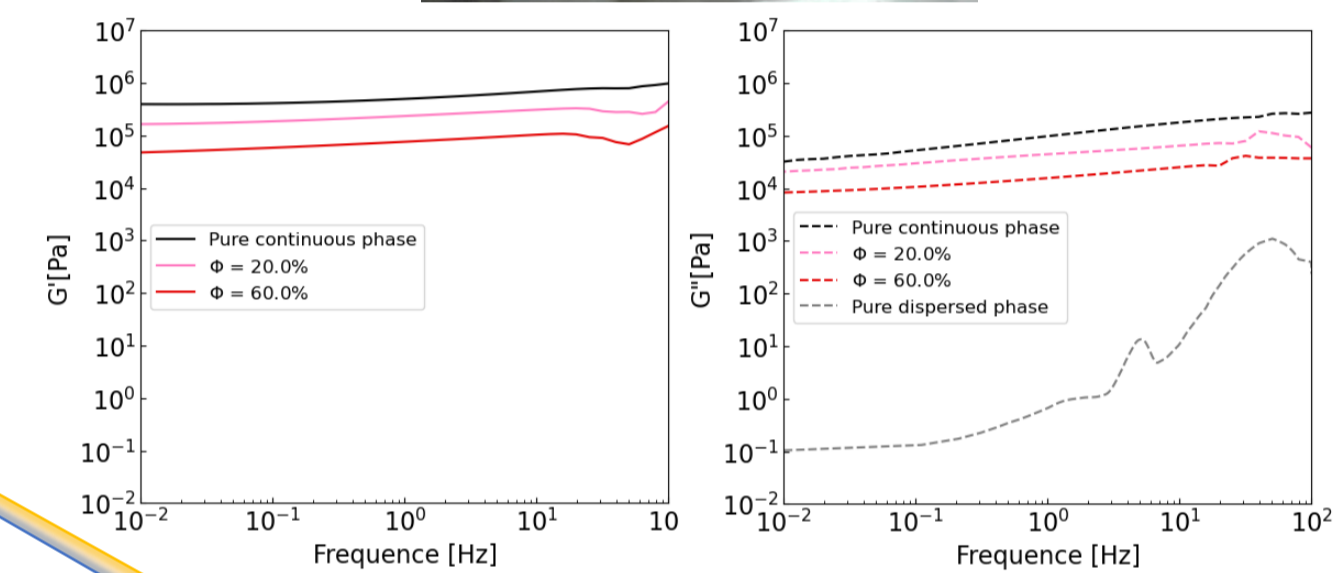
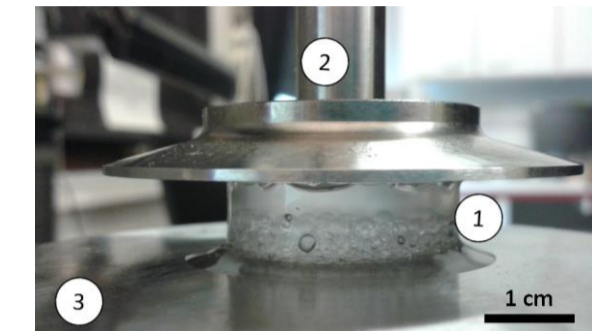

Palierne model for polymer blends: [2]

$$H^* = \frac{(G_d^* - G_m^*)(19G_d^* + 16G_m^*) + 4\sigma/R(5G_d^* + 2G_m^*)}{(2G_d^* + 3G_m^*)(19G_d^* + 16G_m^*) + 40\sigma/R(5G_d^* + 2G_m^*)}$$

$$G^* = G_m^* \frac{1 + 3\Phi H^*}{1 - 2\Phi H^*}$$

Moduli of our emulsion as defined by Palierne

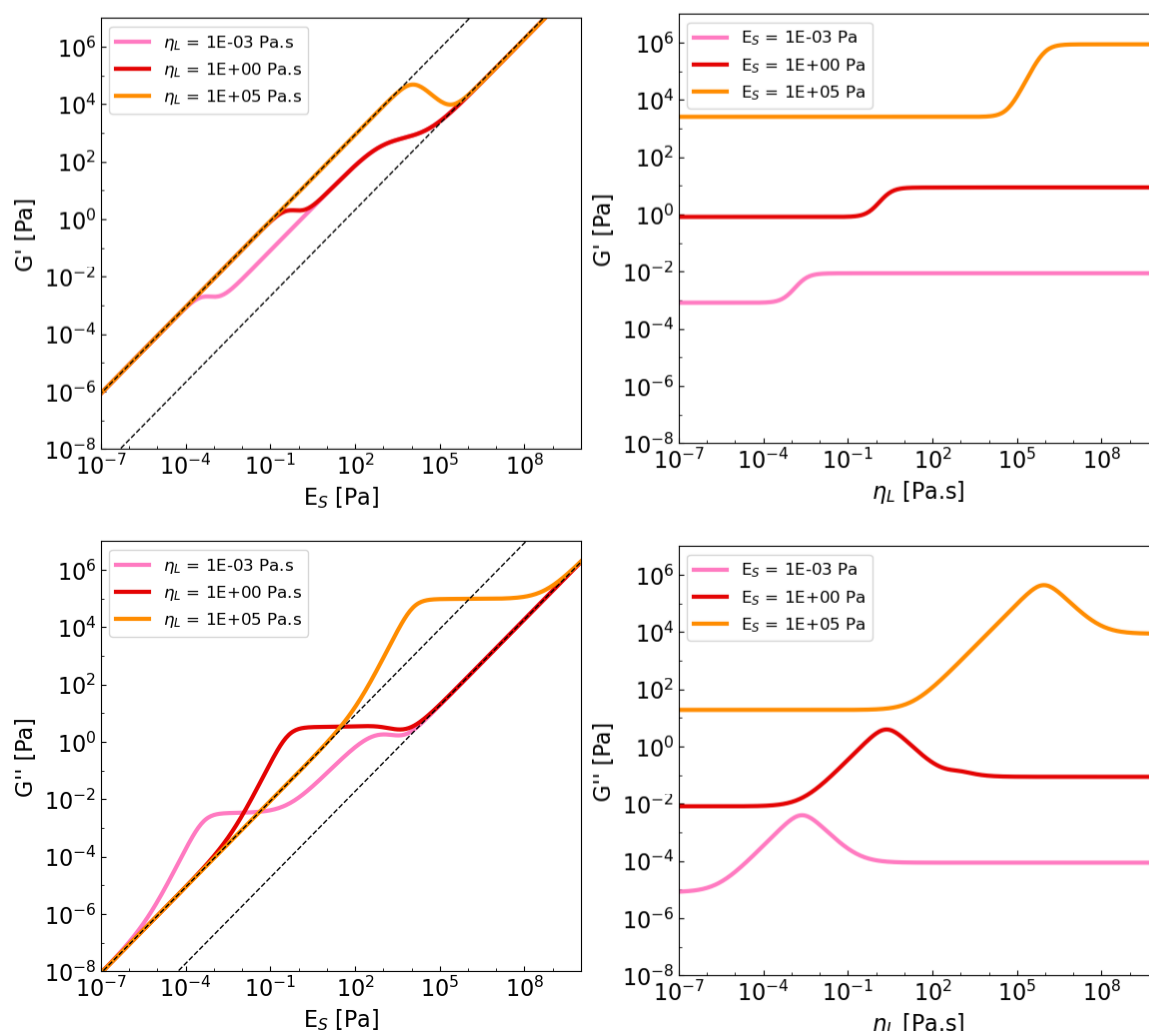

- G^* : modulus of the composite
- G_d^* : modulus of the dispersed phase
- G_m^* : modulus of the matrix
- σ : surface tension
- R : average radius of the droplets
- Φ : volume fraction

Results: Effect of volume fraction

Unexpected behavior compared to Palierne

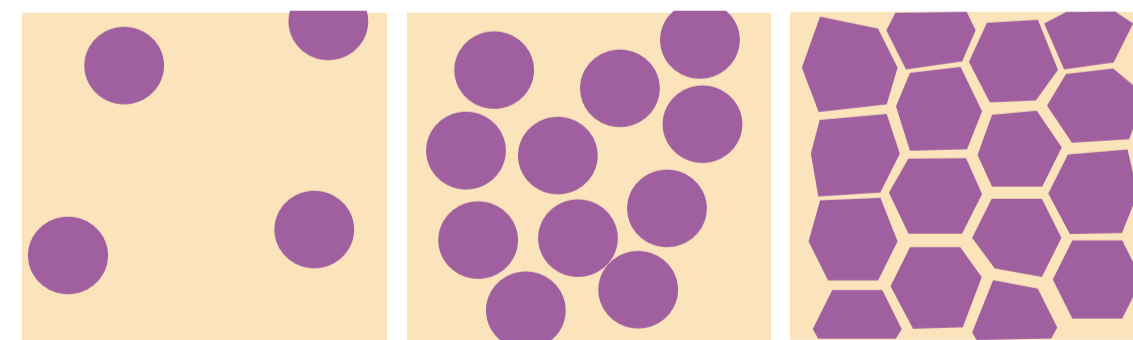
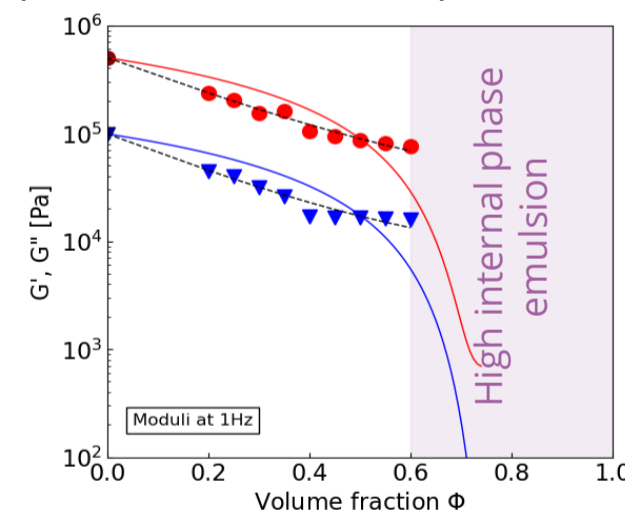

0,3

0,6

Volume fraction

Perspectives

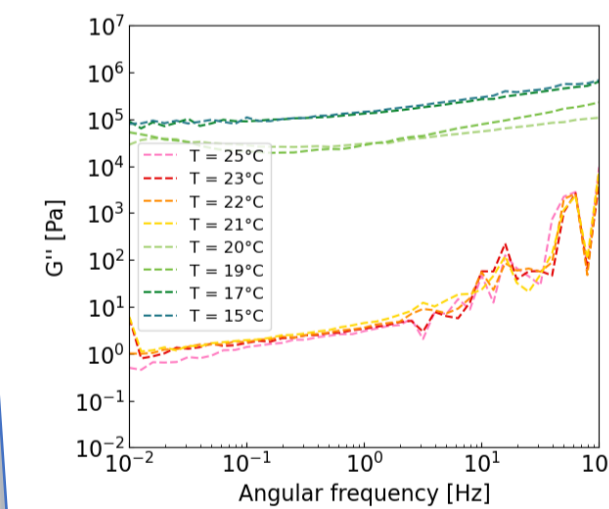

Dynamical properties of PEG600 with temperature

Storage modulus of mixtures of PDMS

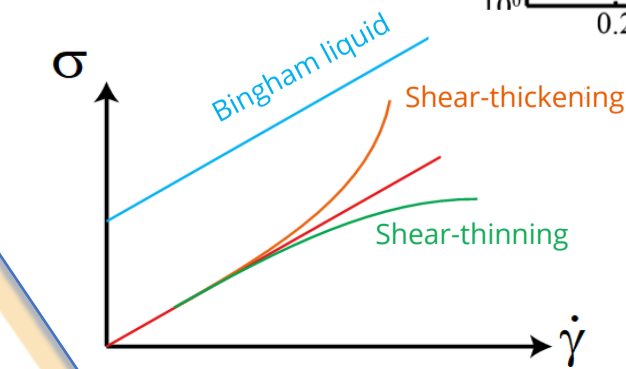
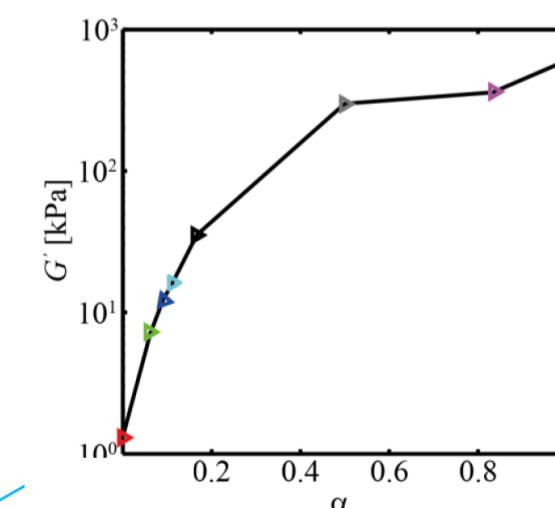

Non-Newtonian drops?

From [3]

Bibliography

- [1] Anaïs Giustiniani. Linking Adhesive Properties and Pore Organisation of Silicone Emulsions Obtained by Reactive Blending. *Soft Condensed Matter* [cond-mat.soft]. Université Paris-Saclay, 2017.
- [2] J. F. Palierne, Linear rheology of viscoelastic emulsions with interfacial tension. *Rheologica Acta* 29(3), 204-214, 1990
- [3] Menghua Zhao. Wetting on soft gels. *Chemical Physics* [physics.chem-ph]. PSL Research University, 2017.
- [4] Ducloué et al., Coupling of elasticity to capillarity in soft aerated materials, *Soft matter* 10(28), 5093-5098, 2014
- [5] Style et al., Stiffening solids with liquid inclusions, *Nature Physics*, 11(2), 1-7, 2014