



HAL
open science

Article 8 MSFD Assessment Guidance

Antonella Acangeli, Matthieu Authier, Nicola Baccetti, Junio Fabrizio Borsani, Marie Cachera, Valerie Cariou, Miquel Canals, Maud Casier, Elise Cavenne, Françoise Claro, et al.

► **To cite this version:**

Antonella Acangeli, Matthieu Authier, Nicola Baccetti, Junio Fabrizio Borsani, Marie Cachera, et al.. Article 8 MSFD Assessment Guidance. pp.1-193, 2022, Marine Strategy Framework Directive (MSFD). Common Implementation Strategy. MSFD GUIDANCE DOCUMENT 19. MAY 2022. hal-03780306

HAL Id: hal-03780306

<https://hal.science/hal-03780306>

Submitted on 7 Dec 2022

HAL is a multi-disciplinary open access archive for the deposit and dissemination of scientific research documents, whether they are published or not. The documents may come from teaching and research institutions in France or abroad, or from public or private research centers.

L'archive ouverte pluridisciplinaire **HAL**, est destinée au dépôt et à la diffusion de documents scientifiques de niveau recherche, publiés ou non, émanant des établissements d'enseignement et de recherche français ou étrangers, des laboratoires publics ou privés.



Marine Strategy Framework Directive (MSFD)

Common Implementation Strategy

Article 8 MSFD Assessment Guidance

MSFD GUIDANCE DOCUMENT 19

MAY 2022

Further information and documentation about WGGES and the present document can be found in the [WG GES meetings folder on CIRCABC](#)

Disclaimer:

This document has been developed through a collaborative programme involving the European Commission, all EU Member States, the Accession Countries, and Norway, international organisations, including the Regional Sea Conventions and other stakeholders and Non-Governmental Organisations. The document should be regarded as presenting an informal consensus position on best practice agreed by all partners. However, the document does not necessarily represent the official, formal position of any of the partners. Hence, the views expressed in the document do not necessarily represent the views of the European Commission.

Recommended citation:

European Commission, 2022. MSFD CIS Guidance Document No. 19, Article 8 MSFD, May 2022.

Acknowledgements

This Guidance Document is a collective effort of the EU MSFD CIS process and was developed under the mandate of Working Group on Good Environmental Status (WGGES). Inputs to the development of this document are gratefully acknowledged from: the Drafting Group on Good Environmental Status (DGGES); Task Groups on Marine Litter (TG ML), Underwater Noise (TG Noise), and Seabed (TG Seabed); MSFD CIS Expert Networks on Non-indigenous Species, Contaminants, Eutrophication, Biodiversity, Pelagic Habitats; ICES advice services; and Member States. Particular thanks go to the following co-authors of guidance contributions.

Authors list (in alphabetical order according to surname):

Antonella Acangeli, Matthieu Authier, Nicola Baccetti, Junio Fabrizio Borsani, Marie Cachera, Valerie CariouMiquel Canals, Maud Casier, Elise Cavenne, Françoise Claro, Valentina Coatu, David Connor, Ivan Consalvo, Ana-Cristina Cardoso, Massimo Dalu, Volker Dierschke, Laure Ducommun, Vivi Fleming, Tomaso Fortibuoni, François Galgani, Cesar Gonzalez-Pola, François Gaudin, Olivia Gerigny, Anita Gilles, Giordano Giorgi, Fanny Girard, Norbert Häubner, Mirko Hauswirth, Ioannis Hatzianestis, Maria Teresa Hernández Sánchez, Birgit Heyden, Paul Kennouch, Samuli Korpinen, Sven Koschniski, Axel Kreutle, Camille Lacroix, Gabriele Lamesa, Giancarlo Lauriano, Florent Le Courtois, Evgenia Lefkadiou, Chiara Maggi, Lucía Martínez García-Denche, Marco Matiddi, Otilia Mihail, Giulia Mo, Heloise Muller, Antonia Nyström Sandman, Oliver Ocadhla, Joana Otero Matias, Andreas Pali Alexis, Nadia Papadopoulou, Monika Peterlin, Karin Pettersson, Francesco Pezzo, Marina Pulcini, Antonio Punzon, Thomas Raabe, Sasa Raicevich, Anna Rindorf, Jehanne Rivet, Francesca Ronchi, Lara Salvany, Jos Schilder, Alexander Schroeder, Peter Sigray, Cecilia Silvestri, Jerome Spitz, Jakob Strand, Céline Tixier, Victoria Tornero, Leonardo Tunesi, Sebastian Valanko, Gert van Hoey, Vera van Lancker, Willem van Loon, Kerstin Varenus, Sandrine Vaz, Andrea Weiß, Marco Zenatello

Contents

1. Introduction	4
1.1 Purpose and scope	4
1.2 About this Guidance	5
1.3 Links between Article 8 and other MSFD Article-reports.....	6
1.4 Terminology.....	7
2. Overarching Principles and Approaches	11
2.1 Integrated assessment framework.....	11
2.2 Steps to assess environmental status and extent of GES achieved	17
2.3 Change in status	32
2.4 Relationship between regional and national assessments	34
2.5 Gaps in knowledge and outstanding issues.....	36
3. Role of climate change in the assessment framework	37
3.1 Key concepts and definitions of the subject	37
3.2 General approach and key recommendations	39
3.3 Next steps	43
4. Pressure-based Descriptor Assessments	44
4.1 Descriptor 2: Non-indigenous species.....	44
4.2 Descriptor 5: Eutrophication	50
4.3 Descriptor 7: Hydrographical changes.....	62
4.4 Descriptor 8: Contaminants in the environment	66
4.5 Descriptor 9: Contaminants in seafood.....	74
4.6 Descriptor 10: Marine Litter	78
4.7 Descriptor 11: Underwater noise	86
5. Status-based Descriptor Assessment.....	95
5.1 Descriptor 1: Birds	95
5.2 Descriptor 1: Mammals	106
5.3 Descriptor 1: Reptiles	117
5.4 Descriptor 1: Fish.....	128
5.5 Descriptor 3: Commercial Fish and Shellfish	136
5.6 Descriptor 1: Pelagic Habitats	146
5.7 Descriptor 6: Seafloor Integrity and Descriptor 1: Benthic Habitats.....	147
5.8 Descriptor 4: Food webs.....	162
6. References and literature	173
7. Abbreviations.....	186
Annex 1: Overview of the scales given in the GES Decision for each Descriptor and criterion.....	188
Annex 2: Overview of the scales given in the GES Decision for each MSFD Region.....	192

1. Introduction

1.1 Purpose and scope

The **purpose** of this Document is to guide Member States in the review and update of the assessment of their marine waters in respect of each marine region or subregion, according to Article 17(2)(a) in conjunction with Articles 8(1) and 9(1) MSFD, which is due for reporting by 15 October 2024 and in subsequent reporting rounds. The aim is that Member States' assessments under Article 8 MSFD are comparable at EU-level, coherent within marine regions, consistent with Union legislation and with agreements in marine regions (e.g. Regional Sea Conventions), transparent and repeatable. The ultimate goal is that Member States' outputs from assessments are compatible. Compatibility is needed as a basis for a regionally coherent management of Member States' waters. It is also needed to allow an EU-scale evaluation under Article 20(3)(b) MSFD of the extent to which good environmental status (GES) is achieved or maintained across EU Member States' marine waters, and a coherent communication of the status of the marine environment to managers and the public.

The **Marine Strategy Framework Directive (MSFD, 2008/56/EU)** requires Member States to prepare and update every six years an analysis of the current environmental status of their marine waters (Article 8(1)(a)), an analysis of the predominant pressures and impacts upon them (Article 8(1)(b)), and a social and economic analysis of the uses of those waters and the cost of degradation of the marine environment (Article 8(1)(c)). Annex III MSFD, as amended by Commission Directive (EU) 2017/845, provides indicative lists of ecosystem elements, anthropogenic pressures, and human activities relevant to marine waters to be covered by these assessments. All references to Annex III MSFD in this Guidance Document relate to the currently valid version of 2017. This Guidance Document addresses the analysis under Article 8(1)(a) and (b), but not Article 8(1)(c) MSFD¹.

The assessments under Article 8(1)(a) and (b) link closely to Member States' **determinations of GES** under Article 9(1) MSFD. Determination of GES and assessment of the extent to which GES is achieved need to be structured in a mutually compatible way. Commission Decision (EU) 2017/848 (hereafter 'GES Decision') lays down the criteria and methodological standards for determining GES and for assessing the status of marine waters², i.e. the extent to which GES has been achieved (Article 9(3) MSFD). This Document includes guidance on determining GES under Article 9(1) and (3) MSFD according to the GES Decision as an integral part of the Article 8 MSFD assessment framework.

The assessment under Article 8 MSFD is the basis for Member States to establish and review a set of **environmental targets** under Article 10 MSFD in relation to all relevant pressures to achieve GES. This Document focusses in its current version on Guidance for status assessments in relation to Article 9 MSFD. Future reviews will need to revisit the need for Guidance on assessments of progress on environmental targets and their associated indicators for Article 10 MSFD.

The GES Decision also lays down the specifications and standardised methods (Article 11 (4) MSFD) for monitoring and assessment. The Guidance addresses the assessment of the environmental status, but not monitoring.

¹ MSFD CIS Guidance Document No. 1: <https://circabc.europa.eu/ui/group/326ae5ac-0419-4167-83ca-e3c210534a69/library/45ba0632-5eba-42dd-a26f-305fd3376331/details>

² <https://eur-lex.europa.eu/legal-content/EN/ALL/?uri=CELEX%3A32017D0848>

1.2 About this Guidance

The Document sets out general guidance cutting across all MSFD Descriptors and criteria in Chapters 2 and 3 and, based thereon, specific guidance for each Descriptor / ecosystem component in Chapters 4 and 5, following the structure of the GES Decision.

The [Guidance builds on the initial draft guidance \(test version 2017\)](#) for assessing the status of marine waters (→ [GES-17-2017-02](#)). It develops the test version further, based on progress made by Member States in implementing the GES Decision through the EU Common Implementation Strategy (CIS) process and through (sub)regional cooperation within Regional Sea Conventions, as documented in publications to which this Guidance will refer. Referenced documentation includes evaluations by the Commission according to Article 12 MSFD of Member States' previous Article 8 assessments (→ [DG ENV site](#) with latest review of 2018 reporting, including → [JRC in depth review of Member States' reports](#)) and the EU Commission's Article 20 MSFD report to the European Parliament and the Council on the implementation of the MSFD (→ [DG ENV site](#)). Staff Working Document → [SWD\(2020\) 62 final](#) 'Background document for Marine Strategy Framework Directive on the determination of good environmental status and its links to assessments and the setting of environmental targets', associated with the Article 20 MSFD report, specifies the general concepts and approaches of Articles 8 and 9 MSFD and the basic requirements for their implementation and of the GES Decision. It provides a basis and reference for this Guidance Document.

The guidance developed in the EU MSFD CIS process for this Document draws on established methodological standards, knowledge and experience in the [marine regions, including the experience of past regional assessments which supported EU Member States in their Article 8 MSFD reporting](#).³ This Document also draws on multiple research and development projects at Union and (sub)regional level which were carried out over the past years, specifically designed to support implementation of the GES Decision.

This Guidance aims to define the [MSFD assessment framework overall and for each Descriptor](#). It has a particular emphasis on lists of criteria elements, threshold values, and methodological standards for assessment (e.g. methods for the spatial and temporal aggregation of data and use of criteria in assessments), which the GES Decision requires Member States to establish through Union, regional or subregional cooperation. To this end, the Guidance lays down as a priority the agreements reached to date (February 2022) on criteria elements, threshold values and the use of criteria (integration rules) established through cooperation at Union level. It also provides supporting guidance for regional and subregional cooperation on lists of criteria elements, threshold values and methodological approaches for assessments to ensure an implementation of the GES Decision that is coherent across marine regions. On this basis, assessments are expected to be both EU-wide compatible and specific to the conditions in the marine (sub)region concerned.

The Guidance is not conclusive but remains '[work in progress](#)': It will be developed further and updated in the next MSFD cycles as Member States progress on implementing the GES Decision and other MSFD assessment requirements under Article 8(1)(a) and (b) MSFD. An overview of the follow-up on the GES Decision which sets out progress in the EU CIS process and marine regions per Descriptor and criterion on determining elements, threshold values and integration rules is revisited regularly by WG GES and MSCG (latest example → [WGGES-24-2021-3a](#), status April 2021).

³ OSPAR, 2017; HELCOM, 2018; UNEP/MAP-MED POL, 2017; BSC, 2019

Chapter 2 on overarching principles and approaches, Chapter 3 on the role of climate change in the assessment as well as the Descriptor / GES component-specific sections of Chapters 4 and 5 of this Guidance include headlines which allow listing gaps in knowledge and outstanding issues. These lists provide a basis for Member States to prioritise and advance science and technical implementation under the EU CIS process and in the marine regions in the period leading up to the subsequent assessments due by 2030 and thereafter.

It is recognised that Member States are at varying stages of developing, through (sub)regional cooperation and nationally, scientific methods and tools for assessments as well as of collecting the necessary data through monitoring programmes. It is likely that Member States and Regional Sea Conventions will have differing abilities to produce assessments against each criterion of the GES Decision and, where appropriate, integration of these, to indicate the extent to which GES has been achieved or maintained.

1.3 Links between Article 8 and other MSFD Article-reports

Article 1 (3) MSFD requires marine strategies to apply an ecosystem-based approach to the management of human activities. This is an integrated approach to management of human activities that considers the entire ecosystem including humans. The goal is to maintain ecosystems in a healthy, clean, productive and resilient condition, so that they can provide humans with the services and goods upon which we depend. It is a spatial approach that builds around a) acknowledging connections, b) cumulative impacts and c) multiple objectives. A comprehensive integrated management of human activities, based on best available scientific knowledge about the ecosystem and its dynamics, can lead to the identification and action on influences which are critical to the health of marine ecosystems, thereby achieving sustainable use of ecosystem goods and services and maintenance of ecosystem integrity (→ glossary of [SWD\(2020\) 62 final](#)). Figure 1-1 illustrates that the Article 8 MSFD assessment forms part of the MSFD's ecosystem-based approach to the management of human activities and integrated implementation framework (→ [SWD\(2020\) 62 final](#)).

The iterative assessments of the environmental state and of the extent to which GES is achieved or maintained in Member States' marine waters (Article 8(1)(a) and (b) MSFD) are an instrument to follow up changes in the quality of the marine environment (in relation to activities, pressures, impacts and the state of ecosystem components). The quality of the marine environment determines the benefits society can or cannot derive from the ecosystem's services it provides and is, in turn, affected by the various uses of marine waters and the nature and intensity of anthropogenic pressures that result from these uses (Article 8(1)(c) MSFD).

Quantified assessments detect the aspects of the environment that are not yet in GES (as determined through Article 9 MSFD). The distance between the actual state of the marine environment and GES is the basis for determining the environmental targets (Article 10 MSFD) for pressure and conservation levels required to progress towards GES. The environmental targets guide in turn the devising of measures to achieve GES (Article 13 MSFD). Indicators associated with environmental targets allow the assessment of the success of measures, depending on the status of their implementation (Article 18 MSFD), in reducing pressures and/or increasing conservation levels, and moving towards GES. Article 14 MSFD, on exceptions, provides a conclusive list of situations that Member States can invoke to justify why they have not yet achieved GES and associated environment targets.

Marine monitoring as well as other data collection systems (Article 11 MSFD) provide the necessary data to perform the assessments.

For guidance on analysis according to Article 8(1)(c) MSFD and on implementing Articles 11, 13, 14 and 18 MSFD, see specific EU CIS MSFD Guidance Documents.⁴

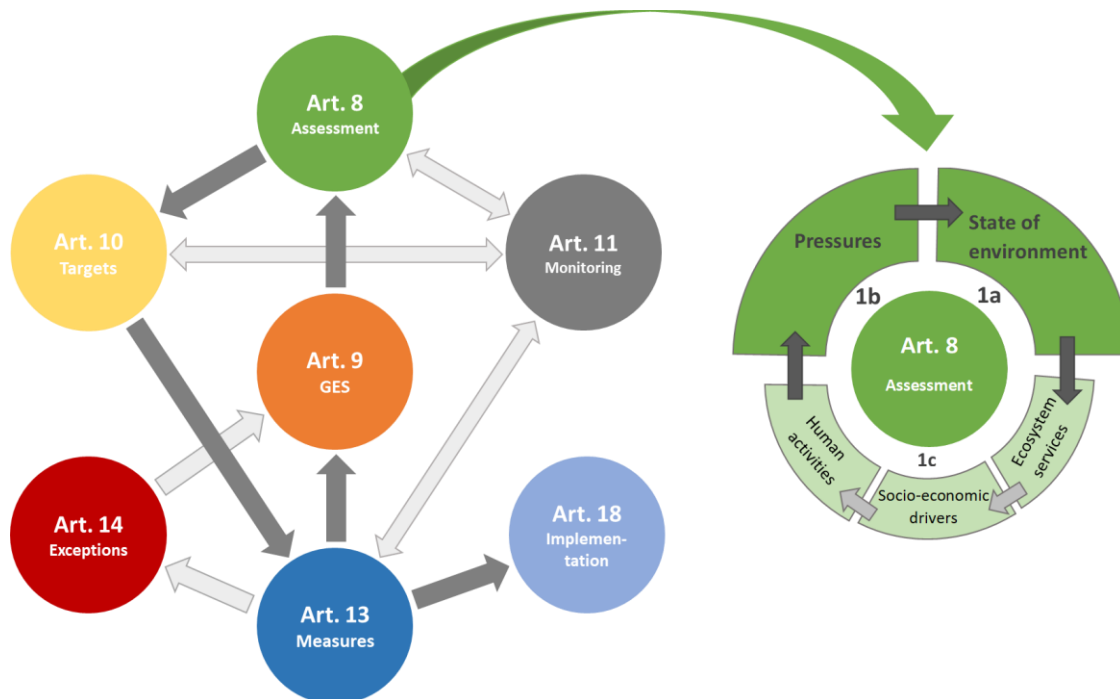

Figure 1-1: Illustration of action flow according to Article 5(2) MSFD and flow of Article 8 assessment components. Arrows colour: dark grey illustrates main linkages; light grey shows secondary links of action flow.

1.4 Terminology

Annex 1 of → SWD(2020) 62 final provides a glossary of all relevant terms used in the MSFD context, some of which are legally defined in the MSFD and the GES Decision, others are not. This Guidance follows, and refers to the definitions in, the glossary of terms and the following complementing definitions:

Aggregation: combination of data and/or assessment information across space and time for one assessment aspect (e.g. a criterion).

Integration: combination of assessment information across different assessment aspects (e.g. combination of information from two or more criteria or underlying indicators).

Assessment area: the specified area within which an assessment of the environmental status of an ecosystem, or ecosystem component and a pressure element takes place. The assessment area is specified based on the geographic scale of assessment described in the GES Decision. For MSFD reporting purposes, the results for an assessment area are reported for a particular Marine Reporting Unit, as specified by the Member States.

⁴ Guidance Documents: https://circabc.europa.eu/ui/group/326ae5ac-0419-4167-83ca-e3c210534a69/library/1dfbd5c7-5177-4828-9d60-ca1340879afc?p=1&n=10&sort=modified_DESC

Assessment unit: relates to finer scales (sub-units) within an assessment area and are used in this Document in relation to the distribution of populations within a species' assessment area.

Not assessed: relates to the status at parameter, criterion, element and feature level if the lack of assessment is based on a decision not to assess the aspect at stake.

Unknown: relates to status at parameter, criterion, element and feature level, if a lack of knowledge (e.g. data, methodologies, agreed values) does not allow a conclusion whether a threshold value or GES is achieved or not.

The 11 Descriptors defining the topics covered by MSFD are spelled out and defined in Annex I to MSFD. For ease of reading, the Descriptors are referred to in this Guidance with a short name as set out in the table below together with the Descriptor labels used in electronic reporting.

Descriptor (Annex I MSFD)		Reporting label ⁵	Short name used in this Guidance
D1	Biological diversity is maintained. The quality and occurrence of habitats and the distribution and abundance of species are in line with prevailing physiographic, geographic and climatic conditions.	D1 Biodiversity D1 Biodiversity – birds D1 Biodiversity – mammals D1 Biodiversity – reptiles D1 Biodiversity – fish D1 Biodiversity – cephalopods D1 Biodiversity – pelagic habitats D6 seafloor integrity/D1 Biodiversity – benthic habitats	Biodiversity: Birds Mammals Reptiles Fish Cephalopods Pelagic Habitats Seafloor integrity and benthic habitats
D2	Non-indigenous species introduced by human activities are at levels that do not adversely alter the ecosystems.	D2 Non-indigenous species	Non-indigenous species
D3	Populations of all commercially exploited fish and shellfish are within safe biological limits, exhibiting a population age and size distribution that is indicative of a healthy stock.	D3 Commercial fish and shellfish	Commercial fish and shellfish
D4	All elements of the marine food webs, to the extent that they are known, occur at normal abundance and diversity and levels capable of ensuring the long-term abundance of the species and the retention of their full reproductive capacity.	D4 Food webs/D1 Biodiversity – ecosystems	Food webs
D5	Human-induced eutrophication is minimised, especially adverse effects thereof, such as losses in biodiversity, ecosystem degradation, harmful algae blooms and oxygen deficiency in bottom waters.	D5 Eutrophication	Eutrophication
D6	Seafloor integrity is at a level that ensures that the structure and functions of the ecosystems are safeguarded and benthic ecosystems, in particular, are not adversely affected.	D6 Seafloor integrity/D1 Biodiversity – benthic habitats	Seafloor integrity and benthic habitats
D7	Permanent alteration of hydrographical conditions does not adversely affect marine ecosystems.	D7 Hydrographical changes	Hydrographical changes
D8	Concentrations of contaminants are at levels not giving rise to pollution effects.	D8 Contaminants	Contaminants

⁵ EU MSFD CIS Guidance Document No. 14 (under review): <https://circabc.europa.eu/ui/group/326ae5ac-0419-4167-83ca-e3c210534a69/library/5b9e26e4-e03c-4a45-a4b0-f510592803d2/details>

Descriptor (Annex I MSFD)		Reporting label ⁵	Short name used in this Guidance
D9	Contaminants in fish and other seafood for human consumption do not exceed levels established by Community legislation or other relevant standards.	D9 Contaminants in seafood	Contaminants in seafood
D10	Properties and quantities of marine litter do not cause harm to the coastal and marine environment.	D10 Marine litter	Marine litter
D11	Introduction of energy, including underwater noise, is at levels that do not adversely affect the marine environment.	D11 Energy, including underwater noise	Underwater noise

The GES Decision assigns the Descriptors to

- the assessment of predominant pressures and impacts under point (b) of Article 8(1) MSFD (Part I). These so-called ‘pressure-based Descriptors’ relate to the indicative list of pressures in Annex III Table 2a MSFD; and
- the assessment of essential features and characteristics and current environmental status of marine waters under point (a) of Article 8(1) MSFD (Part II). These so-called ‘status-based Descriptors’ relate to the indicative list of ecosystem elements in Annex III Table 1 MSFD.

This assignment follows theoretic considerations of a Descriptor’s main focus on pressure/impact or state related aspects to structure the Directive and its implementation. The assignment is one of convenience given that Descriptors include criteria addressing different aspects of the DPSIR (**D**iving forces, **P**ressures, **S**tates, **I**mpacts and **R**esponses) model. Criteria of the GES Decision for assessing pressure-based Descriptors can relate to pressure, impact and state aspects. This is expressed in this guidance when using the terms ‘pressure criteria’, ‘impact criteria’ and ‘state criteria’.

The MSFD uses the term ‘pressure’⁶ to relate to the direct physical, chemical and biological consequences of human activities which can lead to adverse environmental impacts. Pressures are described in Annex III Table 2a MSFD⁷ as an input, alteration, or extraction in relation to natural conditions. Pressures can be considered in two ways⁸:

- At source, i.e. close to the activity generating the pressure. This aspect is particularly relevant for setting environmental targets and for measures as these need to focus on reducing the pressures, when needed to achieve or maintain GES. These are pressures *on* the marine environment.
- At sea, i.e. the level of the pressure *in* the marine environment to which the different elements of the ecosystem are subject. This aspect is particularly relevant for determining GES (for pressure-based Descriptors) and for assessment of environmental status in relation to GES. The pressures addressed by the GES Decision and this Guidance relate to pressures at sea.

This Guidance follows the structure of the GES Decision as closely as possible but allows deviation for practical considerations to provide assessment frameworks fit for application. Therefore, the Guidance presents one assessment framework addressing all benthic aspects – pressures and impacts on the seafloor addressed by D6, and status of benthic habitats addressed by D1 – together in section 5.8 ‘Descriptors 6 and 1: Seafloor integrity and benthic habitats’. Given the linkages in use of criteria and assessment frameworks, the assessment framework for commercially

⁶ Cf. Glossary and section 3.4 in SWD(2020)62 final

⁷ As revised by Commission Directive (EU) 2017/845

⁸ Cf. Section 4.2 in SWD(2020)62 final

exploited fish stocks (a pressure-based Descriptor according to GES Decision) is presented here in Section 5.5, next to the status assessment of fish species.

The Guidance Chapters 4 and 5 relate to the individual Descriptors, using their number and/or short name, as follows:

Guidance Chapter 4:		Guidance Chapter 5:	
D2	Non-indigenous species	D1	Birds, mammals, reptiles and fish*
D5	Eutrophication	D3	Commercial fish and shellfish
D7	Hydrographical changes	D1	Pelagic habitats
D8	Contaminants	D6/D1	Seafloor integrity and benthic habitats
D9	Contaminants in seafood	D4/D1	Food webs
D10	Marine litter		
D11	Underwater noise		

** Cephalopods are not covered in this version of the Guidance given that to date no progress has been made to develop an assessment framework for this ecosystem feature. This was not a priority of MSFD CIS and regional work so far.*

2. Overarching Principles and Approaches

2.1 Integrated assessment framework

For a description of the MSFD assessment framework see section 5 in → [SWD\(2020\) 62 final](#).

2.1.1 Assessment aspects

Article 8(1)(a) and (b) assessments include:

- Assessments of the status of the marine environment and the extent to which GES is achieved or maintained based on the criteria of the GES Decision
- Evaluation of change in environmental status between assessment periods
- Assessments of long-term trends in parameters
- Analysis of activities, pressures, and their cumulative and synergistic effects as well as ecosystem characteristics which generate technical information that feeds in or is ancillary to the assessment of criteria set out in the GES Decision

Annex III MSFD provides an indicative list of broad elements (ecosystem elements in Table 1 and pressures in Table 2a) for determining GES and assessing the extent to which GES has been achieved for the eleven Descriptors (Annex I MSFD). The detailed determination of elements under Article 9(1) MSFD to be covered by the assessments are specified in the GES Decision or subject to determination by Member States through EU or (sub)regional cooperation. Annex III MSFD also provides an indicative list of uses and human activities in or affecting the marine environment for use in relation to Article 8(1)(b) and 8(1)(c) MSFD.

2.1.2 Integrating aspects

For a description of the MSFD integrated assessment framework, see section 5.1 in → [SWD\(2020\) 62 final](#).

The GES Decision organises the assessment of the environmental status along:

- **Predominant pressures and impacts:** Part I, Article 8(1)(b) MSFD – Descriptors 2, 5, 8, 9, 10 and 11 with additional pressures ‘extraction of wild species’ (D3), ‘physical disturbance’ (D6), ‘physical loss’ and associated ‘hydrographical changes’ (D6 and D7)
- **Ecosystem state:** Part II, Article 8(1)(a) MSFD – main elements of marine ecosystems (birds, mammals, reptiles, fish and cephalopods, pelagic and benthic habitats including their biological communities), integrating the state-based aspects of Descriptors D1, 3, 4 and 6

Pressure and impact criteria conceptually link with the status of ecosystem components (Article 8(1)(a) MSFD: physical and chemical features, birds, mammals, reptiles, fish and cephalopods; pelagic habitats, benthic habitats, ecosystem and food webs) and feed into their assessment. Figure 2-1 illustrates the integrated assessment framework.

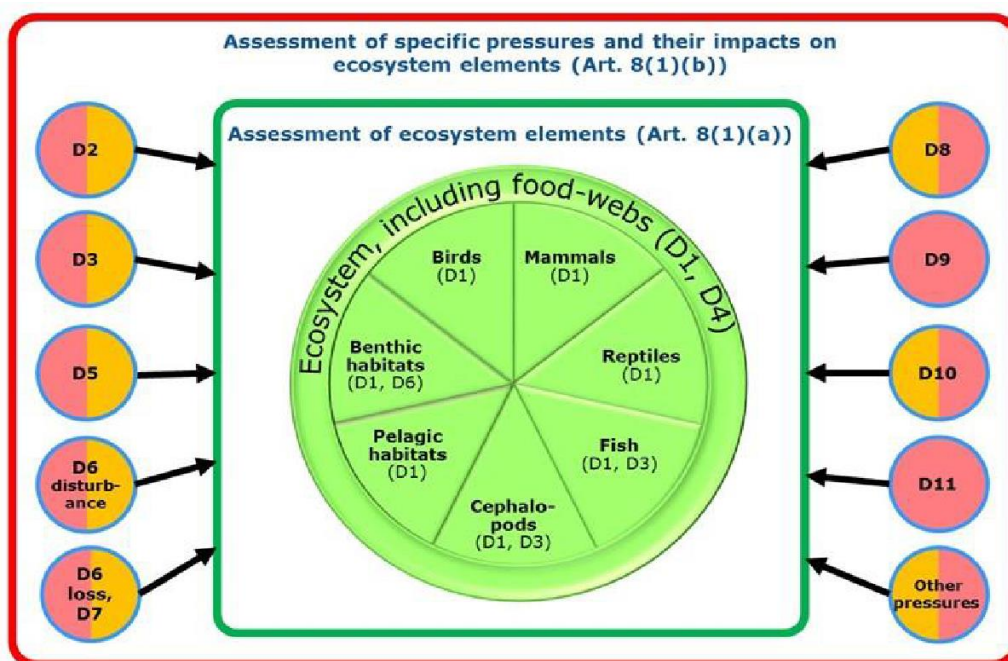

Figure 2-1: An ecosystem-based approach to determination and assessment of GES follows the main elements of the ecosystem (state-based Descriptors, centre, green) and is closely linked to the adverse effects of pressures from human activities via their environmental impacts (pressure-based Descriptors, satellite circles, in which pink depicts pressure and orange the impact). Note in relation to the satellite circles that Descriptors D2, D3, D5, D6, D7, D8 and D10 include both pressure (pink) and impact (orange) criteria in the GES Decision. For D11, impact criteria are not yet available. Source: SWD(2020) 62 final

For a structured approach to Article 8(1)(a) and (b) MSFD, it is recommended to assess the following components in the given sequence (Figure 2-2):

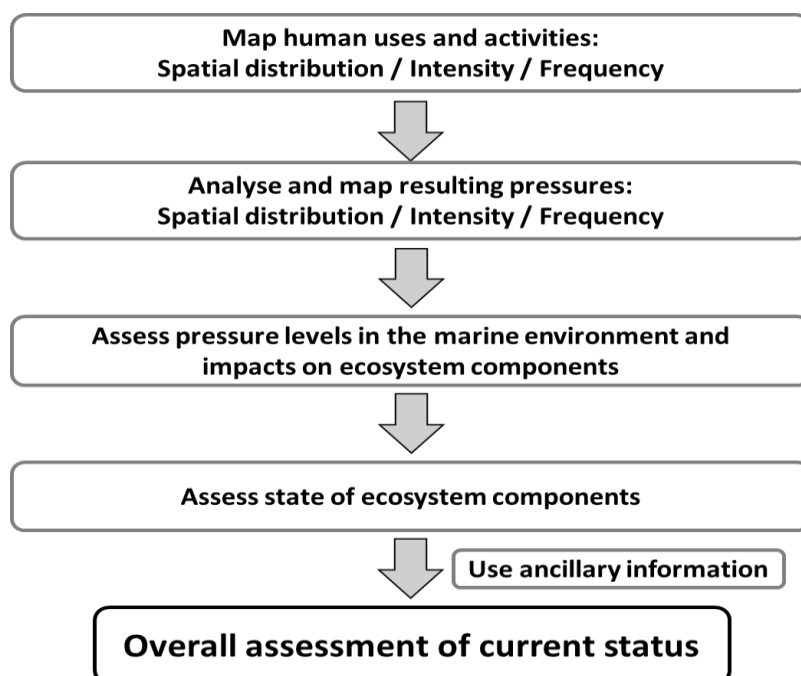

Figure 2-2: Integrated assessment framework

The integrated framework invokes a number of aspects and challenges for which a common understanding and methodologies are still under development. They include the following:

Using pressure and impact criteria in the assessment of species and habitats

The GES Decision sets out the criteria for assessing the level of predominant pressures and their impacts in Part I in relation to the assessment of the status of ecosystem components in Part II. The GES Decision requires that the assessment of the status of ecosystem components considers the assessment of pressures and their adverse effects (Table 2-1).

*Table 2-1: Criteria to be considered in the status assessments of species, pelagic and benthic habitats as required by GES Decision. * marks additional criteria recommended for the assessment framework in Chapters 4 and 5.*

Status assessment of:	Take into account assessments of (primary criteria in bold):
Species	D1C1 , D2C3, D3C1 , D3C2, D3C3, D6C1*, D6C2*, D6C3*, D6C4*, D6C5*, D8C2, D8C4, D9C1 , D10C3, D10C4, D11C1 and D11C2
Pelagic habitats	D2C3, D3C2*, D3C3*, D5C2 , D5C3, D5C4, D7C1, D8C2 and D8C4
Benthic habitats	D2C3, D3C1 , D3C2 , D3C3 , D5C4, D5C5 , D5C6, D5C7, D5C8 , D6C3 , D7C2, D8C2 and D8C4, D10C4*

This framework facilitates the [assessment of cumulative effects of multiple pressures](#) on the ecosystem elements (Article 8(1)(b)(ii) MSFD), whereby the impacts assessed under individual pressures (Article 8(1)(b) MSFD) can be considered collectively for the assessment of each element under Article 8(1)(a) MSFD. To do so, spatial scales and time periods of the various criteria assessments should be sufficiently compatible, where possible.

To date, there is no agreed methodology to link criteria across Descriptors for status assessments. This discussion must be continued, and guidance developed. As an initial step, take into account the relevant pressure and impact criteria by [combining the assessment information in a qualitative manner](#), i.e. use the information to interpret the status assessment results for species and habitats. Where a criterion under a pressure-based Descriptor assesses anthropogenic mortality of a species (e.g. D10C4), the information can be included under D1C1 to complement the assessment of bycatch mortality (→ section 5.1 Birds).

Using pressure and impact criteria results for interpretation of a species / habitat status is particularly relevant where individual pressures meet their threshold values while an ecosystem component fails good status. The reasons for the failure can be various, including the combined effect of the pressures and inconsistencies in assessment tools (see below).

To [identify specific pressure-effect-relationships](#), ensure that the assessment tools (scientific indicators) underlying the assessments of pressure, impact and state criteria are designed and assessment elements selected in a way that allows linking this information. Look at criteria and underlying indicators across the MSFD Descriptors to check overlap and compatibility of assessments in relation to time, space and elements as well as of threshold values (including underlying values for assessing parameters and elements) for pressures, impacts and state aspects.

[Use the mapping](#) of the spatial distribution, intensity and frequency of human activities and pressures at sea, and of the state of ecosystem components to support the compatibility of assessment tools and elements in each area as well as the prioritisation of the most pertinent pressure-effect-relationships and areas which are considered to be most at risk of adverse effects. The mapping can help to overcome limitations of the integrated assessment framework as assessment tools for several pressures and in particular impact criteria are less advanced and not yet ready for use. Also, data gaps on ecosystem components and/or pressures and impacts hamper our understanding of these relationships and existing monitoring programmes are often not

designed to close these gaps. It is important to identify the data needs for a future development of monitoring programmes. Finally, many of the criteria are secondary criteria and often knowledge and methodologies for assessing the impact are still under development.

The mapping also provides an intersection with information on changing marine environmental conditions induced by climate change for interpretation of the status assessment results (→ chapter 3).

»» *Consistency of assessments within and across Descriptors*

The GES Decision assigns to each Descriptor assessment criteria for a theme-specific assessment. There are also linkages and overlaps of assessment criteria and their underlying scientific indicators across Descriptors/themes. Examples include the assessment of benthic macrofauna for eutrophication and benthic habitats, the assessment of plankton for eutrophication, pelagic habitats and food web processes, and the assessment of fish for commercially exploited stocks, health of fish species and food web processes. Potential to use scientific indicators for more than one assessment criterion or theme, e.g. re-use of criteria outcomes in the context of food webs, needs still to be explored with a view to keeping the assessment framework both slim and effective.

To avoid discrepancies when [comparing assessment results across Descriptors and criteria](#), seek to align threshold values (including underlying values for assessing parameters and elements), in particular for those criteria and Descriptors that are directly linked (e.g. chlorophyll *a* in the water column under Descriptor 5 ‘Eutrophication’ and the assessment of plankton biomass for Descriptor 1 ‘Pelagic Habitats’), and that spatial and temporal assessment scales are compatible where overlaps in assessments exist. Tangible discrepancies require explanation for communication purposes. Such discrepancies may result also for example from the use of quality standards and assessment results from other EU legislation as required by the GES Decision in combination with MSFD-specific quality standards and assessment tools.

To date, little discussion has taken place in the EU MSFD CIS process to consider the consistency of assessment approaches and tools across the Descriptors and their criteria. A MSFD CIS horizontal issues workshop focusing on methods and underlying narratives for baseline and threshold value setting (September 2020) initiated a comparison within and across descriptors (including pressure-state relationships).⁹ This discussion needs to continue, and specific guidance is still to be developed.

»» *Use of assessment results from other EU legislation in GES assessments*

The GES Decision requires the use of specific assessment results derived under other EU legislation. These assessments serve the purpose of the relevant EU legislation and may not always be in line with specific MSFD requirements or assessment structure. Differences may occur in relation to assessment periods, scales, elements, and methods, including quality standards and methods to combine information. Examples for the re-use of assessment results from other EU legislation are those of commercially exploited species (Common Fisheries Policy, CFP) for use under D3 and D1/fish, of the Habitats Directive, Birds Directive or Water Framework Directive for use under D1/D6 for species and habitats, of the Water Framework Directive for use e.g. under D5/D8 for eutrophication and contaminants, and of the Foodstuffs Regulation for use under D9 for

⁹ <https://circabc.europa.eu/ui/group/326ae5ac-0419-4167-83ca-e3c210534a69/library/7c701398-fd63-41d0-a976-e07561694ef8/details>

contaminants in seafood. When using assessments of the Water Framework Directive in regional assessments, ensure coherence along the coastal-waters open-sea continuum.

The *differing requirements of the policies*, including different timelines, and the processes in place to establish methods and standards to be used, can mean that harmonisation across policies is a complex task that may only be partially achievable. This may lead to different assessment outcomes (i.e. classification of environmental status) for the same quality element. It also poses questions on how to integrate single results into a broader criterion / element assessment ensuring that the MSFD assessment is consistent.

The challenges of *integrating assessment results from other EU legislation* differ depending on the criterion / element concerned and will be addressed and concrete guidance given in Chapters 4 and 5 for the specific assessment framework. General approach options include for example:

- Use the assessment result as it is (unchanged) and integrate with individual MSFD results in a coherent MSFD status assessment (e.g. *assessments under Habitats Directive for the assessment of species (D1)* → section 5.2–5.4; CFP assessments (D3C1, D3C2, D3C3) for the assessment of fish (D1C1, D1C2, D1C3) → section 5.5).
- Use the assessment result as it is (unchanged), present it separately to a MSFD status assessment and undertake a qualitative appraisal of the overall status.
- Break down an assessment result into its individual parts (disintegration) and use the MSFD-relevant part(s) to rebuild a MSFD-specific assessment (MSFD integration rules) (e.g. eutrophication assessment of coastal waters in some areas → section 4.2).
- Use assessment result to balance a MSFD-specific assessment, i.e. to support it and reduce uncertainty where relevant.

When *deciding on an approach in Chapters 4 and 5*, consider which option is best suited to achieve consistency both between differing policy assessments and within MSFD assessments. Explain discrepancies and ensure transparency in the communication of the assessment results.

»» *Multiple pressures and cumulative effects*

The assessment of multiple pressures and cumulative effects from (all) human activities at sea (Figure 2-3) and from land-based sources is a requirement of the MSFD. The MSFD Descriptors capture most of the anthropogenic pressures at sea or from land-based sources, but their cumulative and synergistic effects requested by Article 8.1(b) require a *separate assessment*, which takes into account all activities, pressures and interactions with effects on ecosystems and supports the precautionary principle. This knowledge is needed for three purposes of the MSFD: (1) to identify the main anthropogenic causes behind the state assessments as guidance for planning of measures (Article 13), (2) to enable setting environmental targets under Article 10 and (3) to provide a link to Article 8(1)(c) assessments of human activities and socio-economic analyses.

The assessments of multiple pressures and cumulative effects also *support other marine policies*. They can be a basis for zoning under the EU Maritime Spatial Planning Directive (MSPD; 2014/89/EU), useful as support for the implementation of the Biodiversity Strategy 2030, relate to conservation and restoration of biodiversity as well as for planning of future human activities (EC, 2019). They would also support monitoring of the European Green Deal (EC, 2019) and pave the way towards informed decision making and the sustainability of the EU's maritime economy.

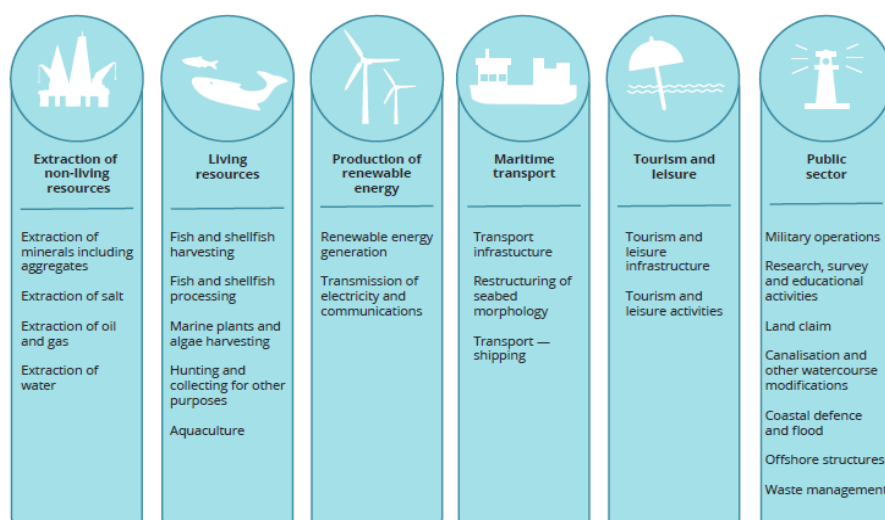

Figure 2-3: Classification of EU coastal and maritime sectors with related activities according to MSFD Annex III as amended by Commission Directive (EU) 2017/845 (EEA, 2019).

The assessment of multiple pressures and cumulative effects is included in [quality status reports](#), e.g. the HELCOM State of the Baltic Sea Report (HELCOM, 2018)¹⁰, and assessments, e.g. the OSPAR Intermediate Assessment (OSPAR, 2017)¹¹. The first overview of anthropogenic pressures and their combined effects in Europe’s seas was prepared by the EEA (ETC/ICM, 2019; Korpinen et al. 2021). The methods for this assessment require understanding of pressures from human activities in regional settings and effects of pressures on the various elements of the marine ecosystem. The method can vary depending on assessment questions, assessed scales, and differences in data availability. However, the main components include mapping and assessment of human activities, the level of pressures they exert, and the likely (or actual) effects of each of the pressures for the marine elements (ETC/ICM, 2019; Figure 2-4).

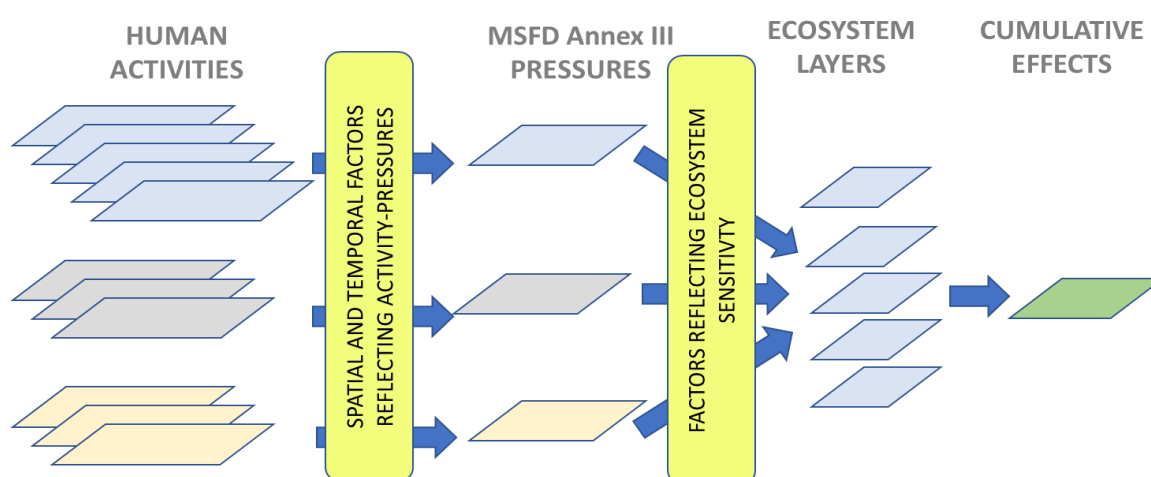

Figure 2-4: The main components of multiple pressures and cumulative effects assessment: mapping and assessment of human activities, the level of pressures they exert, and the likely (or actual) effects of each of the pressures for the marine elements (based on ETC/ICM, 2019).

¹⁰ <http://stateofthebalticsea.helcom.fi/cumulative-impacts/>

¹¹ <https://oap.ospar.org/en/ospar-assessments/intermediate-assessment-2017/chapter-6-ecosystem-assessment-outlook-developing-approach-cumul/>

While the MSFD does not require spatially resolved pressure or cumulative effect assessments, they would be beneficial for [management purposes](#) as well as for [risk-based assessments](#) under Article 8(1)(a) MSFD (e.g. seafloor integrity D6). Spatial pressure and cumulative effect assessments can be tailor-made, developed to inform on pressure hot-spots, so-called cocktail effects, or can inform of areas where anthropogenic pressures are likely not to disturb the environmental status. They can also be designed to address more specific targets for each of the pressure-based Descriptors to support decision-making. Various methods for these have been developed (see e.g. a review by Korpinen and Andersen, 2016; OSPAR, 2017; ETC/ICM, 2019).

The marine pressure and cumulative effect assessment and a set of relevant spatial data layers should be used also in the processes of maritime spatial planning. Concerted action at EU level (including ocean observation efforts) should be designed to increase reliability of data and information on the state of marine ecosystems to decrease uncertainties and build knowledge. Further guidance on assessing multiple pressures and cumulative effects needs to be developed.

2.2 Steps to assess environmental status and extent of GES achieved

The extent to which GES is achieved is reported at feature level. The extent builds on the assessment of individual elements. The criteria of the GES Decision provide a means to define the status of elements and features.

The status of the feature and the extent to which GES is determined against threshold values (→ section 2.2.6). The status is expressed as good status achieved, not achieved, not assessed or unknown. The extent to which GES is achieved is expressed in different ways, depending on the feature concerned. The GES Decision mainly relates to:

- Number / proportion of elements achieving or not achieving their threshold value, not assessed or whose status is unknown
- Extent / proportion (percentage) of marine waters (area) achieving or not achieving their threshold value, not assessed or whose status is unknown

The concept of 'extent of GES achieved' aims to visualise the distance between the state of the marine environment and GES as well as between the actual pressures and a sustainable use of marine waters.

The [main steps in the assessment](#) of the pressure-based and state-based Descriptors and the environmental status provide the structure for Chapters 4 and 5 of this Guidance. For the assessment, start with the selection of elements (e.g. species and habitats under D1/D6 to which assessment criteria apply) or of criteria (e.g. concentration of substances D8C1 as a basis for selecting the assessment elements under this criterion). Whether element or criteria selection comes first in the assessment flow, depends on the Descriptor concerned (see Chapters 4 and 5). For example, contaminant assessments (D8) address among others chemical status (D8C1, elements are substances), impacts of contaminants and acute pollution (D8C2 and D8C4, elements are species and habitats) and acute pollution events (D8C3, element so far not relevant). For the assessment flow and guidance, it is useful in this case to firstly determine which criterion to consider before specifying the element for assessment. In contrast, for the assessment of the status of birds, for example, the first step is to clarify which species (elements) to assess and then to select the criteria for the assessment of the elements.

Figure 2-5 describes the steps for determining GES (Article 9 MSFD) and assessing the extent to which it is achieved (Article 8 MSFD).

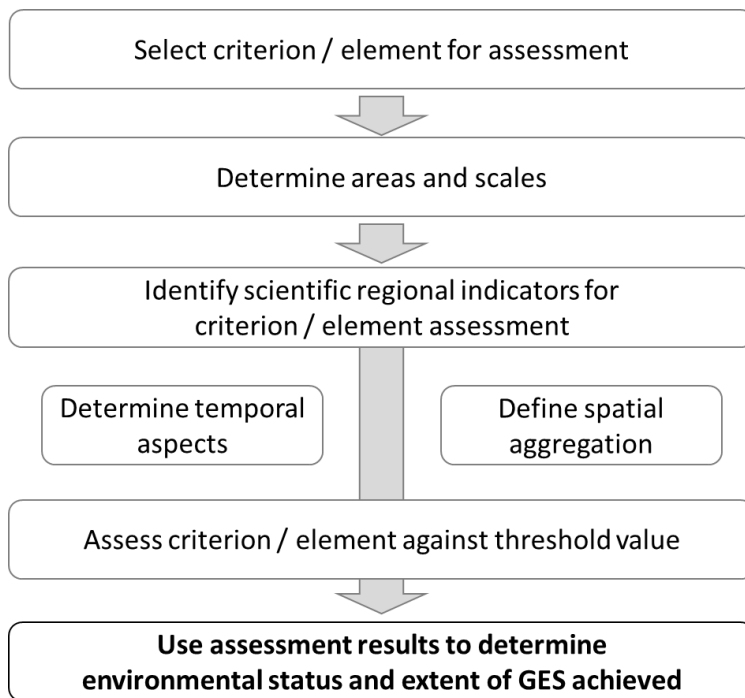

Figure 2-5: Steps to assess environmental status and extent of GES achieved.

2.2.1 Primary and secondary criteria

»» Distinction

The GES Decision intends to give Member States, under specified conditions, sufficient flexibility to focus on the predominant pressures and their environmental impacts on the different ecosystem elements in each region or subregion in order to monitor and assess their marine waters in an efficient and effective manner and to facilitate prioritisation of actions to be taken to achieve good environmental status (cf. recital 19 of GES Decision). For that purpose, Member States should be able to consider that some of the criteria are not appropriate to apply, provided that this is justified. They should also be able not to use certain criteria elements or to select additional elements or to focus on certain matrices or areas of their waters, provided that this is based on a risk assessment in relation to the pressures and their impacts.

One means of introducing flexibility is that the GES Decision distinguishes between primary and secondary criteria. The terms and definitions of primary and secondary criteria were introduced in the GES Decision. While primary criteria should be used to ensure consistency across the Union, flexibility should be granted with regard to secondary criteria.

Primary criteria are mandatory for all Member States and in all regions as the minimum common denominator for the determination of GES and assessment of the environmental status. Article 3(1) GES Decision allows Member States, in justified circumstances, to consider not to use one or more of the primary criteria. In such cases, Member States have to inform Member States sharing the same region of their intention prior to the decision, and, when reporting their determinations of GES pursuant to Article 17(2)(a) MSFD, provide the Commission with a justification for not using a criterion.

Secondary criteria are defined in Article 3(2) GES Decision and are to be used to complement a primary criterion or when the marine environment is at risk of not achieving or not maintaining good environmental status for that particular secondary criterion. While the use of a secondary

criterion is to be decided by each Member State (except where otherwise specified in the Annex, as for D5C8 when substituting D5C5), such decisions should be taken based on agreement at the regional or (sub) regional level. If a secondary criterion is used, the requirements of Annex I of the GES Decision apply in relation to agreements of Member States through cooperation at EU level or (sub)regional level for determining criteria elements, threshold values, use of criteria and the methodological standards, specifications and standardised methods associated with that criterion.

When secondary criteria are decided to be used, the requirements of the GES Decision apply in the same way for secondary and primary criteria. How primary and secondary criteria are used in assessments depends on the specific science-based assessment framework described in Chapters 4 and 5 for each Descriptor and ecosystem component. The described assessment frameworks are generic and take account of all primary and secondary criteria of the GES Decision. Their application in practice depends on the criteria which a Member State decides to use for determining and assessing good status in compliance with the requirements of the GES Decision. These requirements lay strong focus on cooperation between Member States and their joint agreement on elements, criteria, and threshold values at EU or at (sub)regional level (as individually specified in the GES Decision to achieve regionally coherent assessments).

»» *Complementary use of secondary criteria*

The GES Decision defines specific circumstances in which a primary criterion may be **substituted** by a secondary criterion. This concerns the use of the secondary criterion on macrofauna communities of benthic habitats (D5C8) in lieu of the primary criterion on dissolved oxygen in the bottom of the water column in the context of eutrophication (D5) assessments.

Considerations for use of secondary criteria to **complement** primary criteria include for example:

- **Supporting value** of the criterion where it reflects a main environmental problem in marine waters and is essential for describing a good status
- **Explanatory value** of the criterion where good status is failed, e.g. use of D1C3 to add precision in the assessment of D1C2 and for the management of associated pressures
- **Validation value** of the criterion where a primary criterion has achieved or is close to achieving thresholds for good status
- **Gap filling value** of the criterion where a primary criterion is still under development and cannot be used for status assessment

»» *Risk aspects*

For a description of the concept of risk-based approach in MSFD implementation, see chapter 7 in → [SWD\(2020\) 62 final](#).

The selection of both, criteria and criteria elements to be assessed, may follow a risk-based approach. The choice of secondary criteria should be based mainly on risk which means there is a risk to species, habitats or ecosystems to be impacted by a certain pressure and not achieving GES, taking into account the role and values of the secondary criteria in the assessment (see considerations above). Guidance on the application of a risk-based approach still needs to be developed and agreed. The selection of elements and pressures should mirror the most relevant elements in the area in question, i.e. if activities and hence their pressures are present or not in the marine waters of a Member State, and focus on the risk from the main pressures.

2.2.2 Criteria elements for assessment

‘Criteria elements’ means constituent elements of an ecosystem, particularly its biological elements (species, habitats, and their communities), or aspects of pressures on the marine environment (biological, physical, substances, litter, and energy), which are assessed under each criterion. For a description of the concept of GES elements, see section 3.3.3 and 5.3 in → [SWD\(2020\) 62 final](#).

The [GES Decision](#) defines, or lays down requirements for defining, elements to be covered by determining GES (Article 9(1) MSFD) and by a criterion assessment. The provisions take account of other Union legislation and provide a framework within which lists of elements are to be determined for use in the assessment context. Member States are required to establish such lists of elements through regional and subregional cooperation, unless they are defined in the GES Decision and/or require EU level agreement (e.g. litter categories as elements for D10).

Elements specify the [characteristics of marine waters](#) which are pertinent to describe and assess GES. Climate change may have an impact on the occurrence e.g. of species or habitats as a characteristic of a given area (→ section 3). Also, human activities may change (e.g. new contaminants being released to water). Therefore, review the list of criteria elements periodically and at longer term scales, if possible, to ensure that they capture the specific characteristics of GES in the given area.

The EU MSFD CIS process compiled [lists of elements](#) for each Descriptor which Member States used in previous MSFD reporting rounds (enumeration lists for electronic reporting). These lists can provide a common reference and starting point for Member States to agree list of elements at EU or (sub)regional level for use in the forthcoming Article 8 MSFD assessment in 2024 and beyond. The EU MSFD CIS process also started to establish criteria or methods to support comparable refinement of lists of elements for assessment to improve consistency of Article 8 assessments between Member States and across marine regions.

Use the CIS reference lists and methods, as far as available and set out in → [Chapters 4 and 5](#) per Descriptor/criterion, as a common basis for Member States to refine the lists and establish (sub)regionally specified lists of criteria elements for assessment. Use the lists defined by the GES Decision or (sub) regionally agreed for the assessment and for reporting of assessment results.

There may be cases justifying a [national deviation](#) from an established list of criteria elements for assessment and reporting:

- An element occurs only locally where it is a relevant characteristic for determining GES of the national marine waters but is not of (sub)regional relevance.
- An element occurs in parts of a larger assessment area but not in the national waters where it is not a relevant characteristic for determining GES.

In compliance with the methods for selecting and deselecting elements agreed at Union level and specified in → [Chapters 4 and 5](#), Member States may in these cases include or exclude an element for assessment. The exclusion of elements from the assessment follows in principle the procedures of the Union legislation, or the regional agreements under which the list has been established. Cases of inclusion or exclusion of criteria elements must be substantiated by the Member State to justify the deviation from agreed lists of criteria elements for assessment.

2.2.3 Assessment areas and scales

For a description of the concept of geographic scales of assessment and assessment areas see section 3.3.3 and 5.4 in → [SWD\(2020\) 62 final](#). For the relationship of assessment areas and marine reporting units see below → section 2.4

The [GES Decision](#) sets out generic scales to be used in the four marine regions for the assessment of criteria / elements and for reporting the extent to which GES has been achieved at feature level (→ Annexes 1 and 2). The generic scales reflect the need to do assessments at scales which are ecologically / hydrologically relevant (Article 3(2) GES Decision) and which accommodate management considerations (e.g. use of national boundaries, WFD water bodies or aggregated water types).

For some assessments, the scale for assessing criteria / elements is the same as the scale at which criteria / elements are combined for feature assessments. In other cases, where multiple criteria / elements are used to assess a feature, they are sometimes assessed at different scales.

[Use a nested system of assessment areas](#) agreed through cooperation in marine regions to determine the specific assessment areas, based on the GES Decision scales and associated ecological and managerial considerations, for the assessment of criteria or elements and features. The nested system should offer a fixed set of assessment areas of varied spatial resolution to be applied across all criteria or elements and features. They should ensure that smaller areas are contained within the boundaries of larger areas to allow combining assessment results from differing scales. Keep the number of subdivisions defined per region or subregion low. Use the main three principal scales for building a nested system: region/subregion, subdivision and national waters, with national waters divided into coastal and offshore or by subdivision (e.g. water bodies for use of assessment results from Water Framework Directive). Use, as far as possible, the same or compatible assessment areas for multiple features to help minimise complexity of the assessment system and to relate assessment results for criteria and elements across Descriptors. Ensure as far as possible that state-based (Article 8(1)(a) MSFD) and pressure-based (Article 8(1)(b) MSFD) assessments are compatible in scales and resolution of the assessments.

A nested system is available for

- the Baltic Sea in HELCOM (→ [HELCOM 2013 Monitoring and Assessment Strategy](#))
- the North-East Atlantic in OSPAR (→ [OSPAR 2014 Joint Assessment and Monitoring Programme JAMP 2014–2023](#))
- the Mediterranean Sea in UNEP/MAP (→ [MED POL 2016 Integrated Monitoring and Assessment Programme of the Mediterranean Sea and Coast and Related Assessment Criteria IMAP](#))
- for EU waters in the Black Sea (→ [BSC 2017 Black Sea Integrated Monitoring and Assessment Programme BSIMAP](#))

Chapters 4 and 5 provide specific guidance on determining assessment areas and scales for the assessment of criteria or elements concerned and methodological standards for the spatial aggregation of data or assessment results.

2.2.4 Scientific indicators for the criterion / element assessment

‘Indicator’ is an established term which is used in different ways. In general, an indicator consists of one or several parameters chosen to represent (‘indicate’) a certain situation or aspect and to

simplify a complex reality. For the purpose of assessing environmental status, the GES Decision gave up the term ‘indicator’. Scientifically based indicators continue to be used as a concept and term in the marine regions for environmental assessments and can be linked to criteria of the GES Decision.

Use scientific indicators developed through EU (e.g. D10) and mainly through regional cooperation as common and regionally coordinated methodological standards to feed into MSFD assessments of the extent of GES achieved. Regionally agreed indicators include

- core indicators or equivalent developed by → [HELCOM](#)¹²
- common indicators developed by → [OSPAR](#)¹³
- common indicators developed by → [UNEP/MAP-MED POL](#)¹⁴
- common indicators developed by → [BSC](#)¹⁵

In addition to ‘core’ and ‘common’ indicators which relate mostly to region-wide application, indicators otherwise agreed within marine regions at varying scales (e.g. supporting indicators for specific areas of the Baltic Sea¹⁶) or for test purpose (e.g. pilot assessments) are available and can be used.

The GES Decision requires the assessment of features at different levels of complexity, building on assessments of elements and using assessment criteria. As a result, various steps of aggregation and integration are required across parameters, criteria, and elements. Member States have developed and continue to develop through EU cooperation (D10 and D11) and, in particular, through regional cooperation scientific indicators which address aspects of the MSFD assessment at different levels of integration. Ideally, regionally developed indicators are reviewed and organised so that they correspond well with the assessment structure of the GES Decision and lend themselves to direct use by EU Member States in element and/or criteria assessments for MSFD purposes. This includes approaches to combining information from data points to parameters and via indicators to criteria, element, and final status classification (→ section 2.2.7). Guidance on the relationship between regional and national assessments for MSFD purposes is provided in → section 2.4.

2.2.5 Temporal aspects of the assessment

For a description of the time period for assessment and consideration of use and update of data for the assessment period, see section 5.12 in → [SWD\(2020\) 62 final](#).

Status assessments cover **six-year intervals (nominal assessment period)** relating to the Article 8 reporting year, which marks the start of each MSFD cycle (2012, 2018, 2024, 2030 etc). Ideally, the assessment period is aligned among Member States in marine regions and between national and regional assessments to facilitate comparability of the assessments. The planned assessment periods of regional assessments which intend to support EU Member States’ Article 8 assessments and reporting due by 2024 include 2016–2021 for the OSPAR Quality Status Report (QSR) 2023, the

¹² HELCOM indicators, <https://helcom.fi/wp-content/uploads/2021/01/BSEP175.pdf>

¹³ OSPAR indicators, <https://www.ospar.org/work-areas/cross-cutting-issues/ospar-common-indicators>

¹⁴ UNEP/MAP-MED POL indicators, <https://www.medqsr.org/integrated-monitoring-and-assessment-programme-mediterranean-sea-and-coast>

¹⁵ BSC, 2017: https://ec.europa.eu/environment/marine/international-cooperation/regional-sea-conventions/bucharest/pdf/BSIMAP_2017_to_2022_en.pdf; cf. also Anemone Project, <http://anemoneproject.eu/wp-content/uploads/2021/09/deliverables/Deliverable%201.3.pdf>

¹⁶ HELCOM, 2021: <https://helcom.fi/wp-content/uploads/2021/01/BSEP175.pdf>

third HELCOM Holistic Assessment (HOLAS) 2023, the Mediterranean Quality Status Report 2023 and the Black Sea State of Environment Report. Therefore, the assessment period for 2024 reporting should be 2016–2021.

To show progress, the results of the recent assessment period are compared with those of the previous six-year assessment periods, i.e. ideally 2010–2015, noting that the periods assessed in marine regions and reported by Member States varied for 2018. Given these variations for 2018 reporting, it may not be possible to avoid overlaps between assessment periods in all cases, e.g. through re-assessing the previous period with matching years for comparison (→ section 2.3).

Chapters 4 and 5 determine the [methodological standards](#) for aggregating data or assessment results within the six-year period to assess and express the extent to which GES is achieved or maintained. The aggregation approach and methods differ for each criterion or element.

The [data years for assessment](#) ideally coincide with the nominal assessment period and are the same for criteria or elements intended to be combined in the assessment. It is acknowledged that this is not possible in all cases, for example because use is made of assessment results from other EU legislation with differing temporal coverage. A better alignment of reporting cycles with other EU Directives (e.g. Habitats and Birds Directive, WFD) is desirable. Other examples are that data collection is carried out at low frequency, or monitoring has started only recently and does not cover the full assessment period. Limitations in data coverage within the assessment period must be clearly documented to facilitate transparent interpretation of assessment results and should be expressed through confidence levels associated with the assessment. As a minimum, use data years representative for the assessment period and update the data to be used for assessments at least once in the six-year period.

Further, the process of preparing [regional status assessments](#) through OSPAR, HELCOM, Barcelona Convention and Bucharest Convention in time for their use in MSFD Article 8 assessments, typically leads to a cut-off date for the data used (e.g. 2021) that is well ahead of the MSFD reporting date (e.g. 2024). The benefits of having regionally coordinated and consistent assessments can be considered to somewhat overcome this time limitation, bearing in mind that the state of the marine environment generally changes only slowly.

For [trend assessments](#), cover as long a time series as possible to help understand changes in parameters, including natural variability and anthropogenic influences, and interpret assessment results. The long-term trend in data, reflected in an indicator assessment, should not be confused with the reporting of change in status from one six-year period to the next (→ section 2.3).

2.2.6 Setting and applying threshold values

For general guidance on setting threshold values and determining GES (Article 9 MSFD), see section 5.6 and 5.7 in → [SWD\(2020\) 62 final](#). The following section is based on discussions and outcomes of the → [MSFD CIS Workshop 2020 on horizontal issues](#).¹⁷

¹⁷ MSFD CIS Workshop, 2020: <https://circabc.europa.eu/ui/group/326ae5ac-0419-4167-83ca-e3c210534a69/library/7c701398-fd63-41d0-a976-e07561694ef8/detail>

»» *Concept of threshold values*

‘Threshold value’ means a value or range of values that allows for an assessment of the quality level achieved for a particular criterion or element, thereby contributing to the assessment of the extent to which GES is being achieved (Article 2(5) GES Decision). Threshold values are set under Article 9 MSFD to express the desired quality or pressure level for GES and applied under Article 8 MSFD as a benchmark for the status assessment.

Threshold values in the meaning of the GES Decision operate at **different levels of integration**. They build up from values set for single parameters which are combined (e.g. via scientific indicators) to criterion, element and feature level. At each stage in the assessment hierarchy, a quantified decision is taken whether a parameter, a criterion, an element and a feature meets/fails the threshold values. In combination, they help to express the extent to which good environmental status is achieved at feature level.

The **quantified decisions** on status and GES build up on ‘quality standards’ (e.g. concentration of a parameter in a particular matrix, mortality of a species). For the final expression of GES and its extent achieved, the GES Decision distinguishes different approaches. Main expressions include a ‘quality standard’ (e.g. a value for the maximum introduction of new indigenous species D2C1), a minimum proportion of elements keeping within their relevant quality standards (e.g. species D1), and the minimum spatial extent, i.e. proportion of the assessed area (e.g. of benthic habitats D6C5), keeping within their relevant quality standards.

The **GES Decision** requires setting of threshold values except for D1C5, D2C2, D6C1, D6C2, D7C1, D8C3 and D8C4. The data and analysis generated under those criteria is technical information which feeds into and informs the assessment of (other) criteria, elements and features. Annex I to the GES Decision requires Member States, depending on the criteria/element concerned, to establish threshold values through Union, regional or subregional cooperation. Article 4(1)(a)–(j) GES Decision sets out the requirements for setting threshold values. Until Member States have established threshold values through Union, regional or subregional cooperation, Article 4(2) GES Decision allows the use of:

- National threshold values, provided the obligation of regional cooperation laid down in Articles 5 and 6 MSFD is complied with
- Directional trends of the values
- Pressure-based threshold values as proxies

Article 4(2) GES Decision requires that these interim threshold values follow, where possible, the principles set out in points (a) to (i) of Article 4(1) GES Decision.

Threshold values are set at the **geographic scales** of the assessment (→ section 2.2.3). The geographic scales should be chosen to take account of the different biotic and abiotic characteristics of the regions, subregions, and subdivisions.

Setting threshold values is a **scientific approach**, not a political one, even if at the end society will decide what state of the environment is acceptable.

Setting threshold values involves **two sets of determinations**: defining a baseline in relation to which the threshold value is set and defining the threshold value itself. Climate change affects baselines as a result of changing background environmental conditions (→ section 3). Review baselines periodically and at longer term scales to ensure that the basis for GES determination and assessment is still valid.

Threshold values should be set **consistent** with Union legislation and across different criteria when they relate to the same ecosystem element (Article 4(1)(b) and (f) GES Decision). The dual consistency requirement may result in conflicts, e.g. where a threshold value selected from another Union legislation for a quality element (e.g. benthic quality element under D5) does not match a regionally agreed threshold value for the same element under another Descriptor (e.g. benthic element under D2 or D6) (→ section 2.1.2). Solutions to handle such variances still need to be explored.

»» *Defining baselines / reference conditions*

‘Baseline’ is a specified environmental state against which subsequent/other values of state, impact or pressure can be set and compared. Baselines / reference conditions may be reviewed and updated according to progress in knowledge, data, and methods, but avoiding the ‘shifting/sliding baseline syndrome’¹⁸ which compromise comparison of values and trends along time. See section 2.3 for guidance on change in status in this case.

Which type of baseline to use depends on the purpose. Main types of baselines:

- ‘**Reference conditions**’: an environmental state which is considered not to be impacted by pressures from human activities or where such impact is only very minor.

The approach is highly scientifically robust as it demonstrates conditions under current physiographic, geographic, and climatic conditions. It is a relatively transparent and comprehensible approach. It is dependent on the existence of areas where impacts are non-existent or negligible. If data permit, reference conditions can also be derived from historical data sets (including modelling) of a past unimpacted state or from modelling of a future unimpacted state under present climatic conditions, but this requires careful consideration of possible regime shifts or new stable states (e.g. effects of established non-indigenous species). For pollution with matter that does not exist in nature, such as marine litter made up of artificial polymers and synthetic substances, the reference condition can be set at zero as the unimpacted natural condition.

Reference conditions are used under the Water Framework Directive as a basis to classify the status of quality elements.¹⁹ The assessment of macrophytes is an example where historical distribution data was used to define area-specific reference conditions (Domin et al., 2004).

The use of reference condition is the preferred option for baselines across Descriptors in the context of setting threshold values under Article 9 and for assessments under Article 8. Given limitations in knowledge, ‘reference conditions’ are recommended e.g. for use for Descriptor 5 (eutrophication), e.g. for criteria D5C1 (nutrient concentrations) and D5C2 (chlorophyll *a* concentrations), and Descriptor 1 for those species groups where historical data are available to allow the setting of related thresholds (→ sections 5.1–5.4).

- ‘**Past state**’: a known state in the past, such as first data points in a time series which are considered the least impacted state of the time series. The first data point is not intended to

¹⁸ Pauly, 1995; [http://dx.doi.org/10.1016/S0169-5347\(00\)89171-5](http://dx.doi.org/10.1016/S0169-5347(00)89171-5); Papworth et al., 2009, doi: 10.1111/j.1755-263X.2009.00049.x

¹⁹ WFD CIS Guidance Document No. 5: [https://circabc.europa.eu/sd/a/85912f96-4dca-432e-84d6-a4dded785da5/Guidance%20No%205%20-%20characterisation%20of%20coastal%20waters%20-%20COAST%20\(WG%202.4\).pdf](https://circabc.europa.eu/sd/a/85912f96-4dca-432e-84d6-a4dded785da5/Guidance%20No%205%20-%20characterisation%20of%20coastal%20waters%20-%20COAST%20(WG%202.4).pdf); WFD CIS Guidance Document No. 13: [https://circabc.europa.eu/sd/a/06480e87-27a6-41e6-b165-0581c2b046ad/Guidance%20No%2013%20-%20Classification%20of%20Ecological%20Status%20\(WG%20A\).pdf](https://circabc.europa.eu/sd/a/06480e87-27a6-41e6-b165-0581c2b046ad/Guidance%20No%2013%20-%20Classification%20of%20Ecological%20Status%20(WG%20A).pdf)

represent an unimpacted state, but simply when research or data recording on a particular feature began.

The approach is generally robust as it is based on data time series and should indicate change of the state of a feature over time. To avoid effects of interannual variability, the past state can also be a mean of several years in the beginning of data series. Level of robustness depends on quantity and quality of data. The approach is comprehensible but resulting threshold values run the risk of being based on an already significantly impacted scenario. Each time series needs expert evaluation to determine whether the first point (or some other point) in the time series is to be selected as the baseline, taking into account the changes in associated pressures over the time period and other relevant factors. To account for the known shortcomings of this approach, regular reviews of the thresholds and adjustments to improved knowledge need to be undertaken. The six-yearly assessment requirement provides an opportunity for reviewing state of knowledge and need for adjustment.

The approach is used for example for the HELCOM seabird indicator where the baseline is defined as a mean of a time period in 1990s.²⁰

Unless a reference condition can be derived, the approach is recommended for use for different criteria elements (species groups, pelagic and benthic habitats) under Descriptor 1 (→sections 5.1–5.4).

- **‘Current state’**: Baselines can be set at the date of inception of a particular environmental policy or the first assessment of state. The intention of this baseline type is to prevent any further deterioration from the current state.

The approach is quick, practical, and transparent, but the current state most probably does not reflect undisturbed conditions and provides much less scope for recovery of the systems. Such an approach is appropriate when GES has already been achieved and requires to be maintained. It is not appropriate when deterioration or degradation has already occurred as it may not meet the overall aims of the MSFD. Current state can be used instead as a baseline for setting environmental targets (Article 10 MSFD).

This approach is used in the context of the Habitats Directive, where the date when the Directive came into force was used by many European countries as the baseline for favourable reference values.²¹ An example is the assessment of Atlantic grey seals in the OSPAR area using, as one part of the assessment procedure, the abundance of seals in 1992 as the baseline year. The threshold value is defined as less than 25% change in abundance from the fixed baseline in 1992.²²

The approach is not recommended for use in threshold value setting under the GES Decision.

- **‘Potential future state’**: a desired future state with or without an endpoint. An approach with endpoint is to model a future condition, possibly a reference condition. An approach without identified endpoint is to use directional / trend-based objectives, i.e. a desired trend in state in relation to the chosen baseline, a continuous improvement in state.

²⁰ <https://helcom.fi/media/core%20indicators/Abundance-of-waterbirds-in-the-wintering-season-HELCOM-core-indicator-2018.pdf>

²¹ According to Article 17 of the Habitats Directive guidance on assessment and reporting the favourable reference values in a given biogeographical region are "sufficiently large to allow the long-term survival of the habitat/species" and, as a minimum, the ecological state when the Directive came into force. However, the guidance also acknowledges that historical data and expert judgement may also be used to help define these values.

²² <https://oap.ospar.org/en/ospar-assessments/intermediate-assessment-2017/biodiversity-status/marine-mammals/seal-abundance-and-distribution/>

This approach is used for marine birds (criterion D1C1 under Descriptor 1) by applying the Integrated Population Model (IPM) to predict the future population size for selected seabird species (→ section 5.1).

The approach is not recommended for use in threshold value setting under the GES Decision, but can be used at national level until suitable threshold values are defined.

»» *Defining the value*

The threshold value is set in relation to the baseline chosen, namely by defining an acceptable deviation from the reference condition (Article 4(1)(c) GES Decision).

Threshold values can be formulated as a target to be achieved (e.g. abundance of a species), or a limit not to be exceeded (e.g. concentration of a substance), or a lower limit not to be fallen below (e.g. oxygen minimum values). The method to use depends on the use of the threshold value (assessment context).

Based on the reasoning on how threshold values are set and used, the generic narrative types and approaches below can be distinguished. Any of the science-based approaches involve to some degree expert judgement. The precautionary principle, risk considerations, and the legal requirement of non-deterioration (Article 1 MSFD) are principles guiding and complementing any type of narrative.

- **Acceptable deviation from reference condition/baseline:** This is used for example by the HELCOM and OSPAR bird indicators where x % deviation is allowed in relation to a baseline condition.²³ This approach has so far been used by the OSPAR Common Indicator for nutrient concentrations where 50 % deviation related to a baseline condition of around 1900 based on modelled nutrient loads data defines the GES threshold.²⁴ Recommended for use for Descriptors D1 and D5 (→ sections 5.1 and 4.2).
- **Cut-off values:** This is used, e.g., for oxygen or hazardous substances indicators where specific concentrations are known to cause adverse effects. This approach is also used for marine litter to define acceptable levels of pollution. Recommended for use for Descriptors 5, 8, 9 and 10 (→ sections 4.2, 4.4, 4.5 and 4.6).
- **Removal and conservation targets:** This approach is used for the HELCOM indicator for drowned mammals and waterbirds in fishing gear by defining removal targets for harbour porpoise and different waterbirds. These are based on the Catch Limit Algorithm (CLA), Removal Limit Algorithm (RLA) and the Potential Biological Removal model (PBR) for mammals and on Population Viability Analysis (PVA) for waterbirds, to set anthropogenic mortality limits. Recommended for use for different species groups under Descriptor 1 (→ sections 5.1-5.4).
- **Lowest endpoint:** The MSY indicators use modelling approaches where risks for over-exploitation of fish stocks are estimated, and the threshold values indicate levels where this risk is reasonably low. Recommended for use under Descriptor 3 for criteria D3C1 and D3C2 (→ section 5.5)

²³ <https://helcom.fi/media/core%20indicators/Abundance-of-waterbirds-in-the-wintering-season-HELCOM-core-indicator-2018.pdf>

²⁴ Approach is undergoing review. <https://www.ospar.org/documents?d=32957>

- **Limit reference level:** The HELCOM seal abundance indicators use limit reference levels which are derived from a population viability analysis which defines a population abundance where a certain low risk of extinction is accepted.²⁵
- **Vulnerability approach:** Species or habitats are vulnerable to specific pressures and the thresholds can be set according to the adverse effects from these pressures. This will be easiest if the threshold is set for a pressure element (e.g. noise, bycatch, entanglement by litter). The approach is currently used for example in D6 and D11 assessments (→ sections 5.7 and 4.7).

»» *Practical steps for accelerating progress on threshold value setting*

The choice of methods for threshold setting (baseline and value derivation) needs to take account of what is practically required to implement the method and what is available. Considering gaps in knowledge, tools and data, and the time it takes to close such gaps to develop complex threshold values, alternative approaches, which are concurrent to work on improving data, defining and implementing the optimal approach, can be used to progress in the interim. Different methods for threshold setting can be combined to overcome shortcomings of using only one approach with relatively high uncertainty, e.g. the combination of reference (baseline and acceptable deviation) and trend-based approach in the HELCOM indicator for abundance of key coastal fish species, which considers data availability and uncertainty. There is a need for regular review and update built into the implementation of the GES Decision (adaptive process), following the six-year cycle of updating Article 9 MSFD reporting, including threshold values.

Follow a stepwise approach; start with an 'imperfect', pragmatic threshold value. See how it fits and adjust as necessary ('adaptive approach') or use time to develop a more sophisticated threshold value ('placeholder' or 'proxy approach'). Use confidence rating (→ section 2.2.8) to express the uncertainty associated with such 'imperfect' status classification.

Approaches for pragmatic threshold values:

- **Set margins and bands** within which the threshold value is to be located but cannot yet be set due to limitations in knowledge / data. This holds for measurement values or an assessment result which falls within the band and means that there is a risk of failing the future threshold value or good status. Based on risk and precautionary considerations, status within the band is classed 'not good'. This allows to trigger investigations and appropriate measures to move status towards the margin for 'good status'.
- **Use existing and proven threshold values** even if they represent only parts of a criterion or element. Use the threshold value to determine whether the threshold value or good status is met/failed and add missing threshold values to complement the criterion or element once knowledge allows. If the threshold changes between assessment periods due to further developments, use the reassessment of the previous period under amended assessment conditions to determine changes (→ section 2.3). Keep track of these changes.
- **Use a pragmatic value** based on best knowledge and expert judgement at the time. Ensure regular adjustment and updating of thresholds based on further development and improved knowledge. Keep track of changes.
- **Use direction of trend**, related to the baseline or the finally aimed at state, while developing a threshold value at EU or regional level. Where a trend shows deterioration, it can be equated to 'not good' status based on Article 1(2)(a) MSFD to prevent deterioration of the marine

²⁵ <https://helcom.fi/media/core%20indicators/Population-trends-and-abundance-of-seals-HELCOM-core-indicator-2018.pdf>

environment and the risk of failing good status. This will allow taking measures to halt or turn the trend. Where a trend shows no change or improvement, it can be equated to ‘unknown’ status based on the precautionary principle and lack of knowledge whether the current status is good or not. This will allow taking measures to maintain the status or to continue the good direction of the trend.

Options to overcome (potential) hindrances for baseline- and threshold-setting processes to improve coherence and to [achieve interim solutions](#) (based on discussions at → [MSFD CIS Horizontal Issues Workshop 2020](#)):

- Investigate and compare methods within and across regions, encourage at political and coordination level to test approaches from another country/region.
- Coherence should be sought at the indicator, criterion and feature level within a region first. As a next step seek coherence between regions.
- In case of spatially heterogeneous pressures and/or ecosystem characteristics, define smaller assessment areas or apply varying baselines/thresholds within a larger area.
- When using trends as an interim approach: The system should at least not deteriorate. Apply standstill principle, whenever possible, and combine with expert judgement, when possible and relevant.

2.2.7 Use of criteria (integration rules)

The use of criteria in the assessments as described in the GES Decision relates to [combining individual assessment results to an expression of the extent to which good status is achieved](#) (integration rules). The GES Decision describes the level of integration which differs for the Descriptors and the ecosystem components concerned. The GES Decision requires that Member States agree integration rules mainly through cooperation at EU level. Chapters 4 and 5 set out the integration rules to be used for each of the Descriptors and ecosystem components. Several assessment approaches can be applied on a Descriptor-specific basis, such as ‘one-out all-out’, simple or weighted averaging, a proportional rule, various conditional rules, or a combination of different principles.

Considerations for integration rules include the following:

- In principle, good status should require that all primary criteria meet their threshold values. Depending on the assessment framework (e.g. for birds), Descriptor-specific integration rules may give weight to other (e.g. impact criteria) assessment results, for a robust status conclusion.
- Lack of assessment of a primary criterion does not, in principle, prevent a status assessment, depending on the assessment framework (example of D3 assessment in the absence of D3C3 assessment tools, → section 5.5).
- Status classification should acknowledge the status of red listed species and habitats (e.g. use flagging of threatened species with a risk of extinction throughout the integration process to ensure the information is kept, → section 5.4).
- Precautionary and risk considerations should be applied when aspects are not assessed, or their conditions are unknown (e.g. for mammals → section 5.2).

For some Descriptors / ecosystem components, Chapters 4 and 5 guide the combination of assessment results in [scenarios](#) to ensure consistent status classification. Considerations for scenarios should include the following:

- Distinguish lack of assessment due to
 - lack of knowledge (status ‘unknown’);

- a decision not to assess a particular element or criterion (status ‘not assessed’).
- In case of lacking assessment, consider consequences and possible actions, such as enhancing scientific approaches or re-considering decisions.
- Combine trend and status information to create a consistent scenario (e.g. recommended for D8).
- Set up and lay down transparent Descriptor-specific rules for combining heterogeneous information such as trend and status information to achieve a statement of whether GES is achieved or not.

2.2.8 Confidence assessment

Environmental assessment procedures are based on data that have different resolutions in time and space. Moreover, most underlying data are based on measurements and counting, and thus, strongly dependent on the testing method, sample properties, and analytical skills – a measure of dispersion is inherent in these measurements. This is even more true when expert judgement is involved due to missing data.

Consequently, [assessment results will differ in quality](#). Since assessment results provide a basis for decision making and management, it is important to describe the uncertainty associated with any assessment-related statement. Thus, the necessity exists to establish a confidence rating for assessments at all levels to provide a solid basis for estimating the assessment quality.

Wherever possible, [use quantitative confidence analysis](#) to assess the temporal and spatial distribution of measured or modelled data, preferably based on data statistics rather than on expert judgement, providing a measure of the accuracy of the assessment outcome in relation to the threshold value (as described e.g. in section 4.2 for confidence assessment of Descriptor 5). Besides confidence assessment of the data, determine methodological confidence and confidence of the threshold setting to allow judgement how well-founded assessment results are. This enables to identify differences in uncertainties of indicators, criteria, and overall assessment results. Combination of different confidence aspects should be carried out in parallel with status assessments, using the same integration rules (e.g. as applied in automated assessment tools of Regional Sea Conventions for biodiversity assessments (HELCOM BEAT) and eutrophication assessments (HELCOM HEAT, OSPAR COMPEAT and BSC BEAST), or adjusted integration steps if appropriate, to produce accompanying confidence assessment results at the different levels of the assessment process (indicator, criteria, element). Minimum requirements can be defined for the assessment, e.g. the number of species per species group or the number of indicators evaluated at criteria level for satisfactory confidence, with penalties applied such as reduction of confidence by a certain percentage if not met. In case of ‘low’ confidence, this will help to identify necessary methodological or strategical improvements such as intensified or focused monitoring of areas with high uncertainty in assessment results.

The [minimum requirement for a confidence assessment](#) setup should include data, methodology, and threshold value setting (if thresholds are in place), at least on the qualitative level (mainly based on expert judgement), but primarily on a quantitative basis (data-driven, including statistical analysis). Depending on the criteria or element to be assessed, confidence assessment procedures need to be customised for the type of underlying data, assumptions made, and methods used. Specific guidance is provided in Chapters 4 and 5.

To make confidence in assessment results comparable across Descriptors and marine regions, further consideration needs to be given to an overarching, aggregated qualitative confidence rating

system to which more or less sophisticated individual confidence assessment results are assigned and which provides a high-level confidence summary, e.g. categorised into general but clearly defined classes of ‘low’, ‘moderate’, and ‘high’ confidence.

In a guidance note, the IPCC Fifth Assessment Report (2010) suggests two approaches of **analysing the degree of uncertainty** for key findings that can be employed independently or as a combined method:

- **Qualitative (methodological) confidence rating:** Estimating the ‘validity of a finding, based on the type, amount, quality, and consistency of evidence (e.g., mechanistic understanding, theory, data, models, expert judgement) and the degree of agreement.’
- **Quantitative confidence rating:** Determining of uncertainty in a finding expressed probabilistically based on statistical analysis of observations or model results, or expert judgement.

In a first step, the level of evidence is evaluated as ‘robust’, ‘medium’ or ‘limited’ and the degree of agreement is estimated as ‘high’, ‘medium’ and ‘low’. The level of ‘evidence’ considers the quality of assessments including appropriate spatial and temporal scales, while the level of ‘agreement’ takes account of consensus or deviation of different assessment results. For combining evidence and agreement, the matrix below (Figure 2-6) provides a generic scheme, with increasing confidence towards the top-right corner. It is used where no quantitative and elaborate confidence assessment systems are in place to date. The qualitative approach enables to judge the validity of assessment on an overarching level. The application of this procedure is recommended for estimating confidence in the assessment of birds and mammals as described in Descriptor sections 5.1 and 5.2. Where elaborate confidence assessment systems exist for specific Descriptors, the scheme can help translating the various results into a common language which allows comparing confidence across descriptors, marine regions, and Member States.

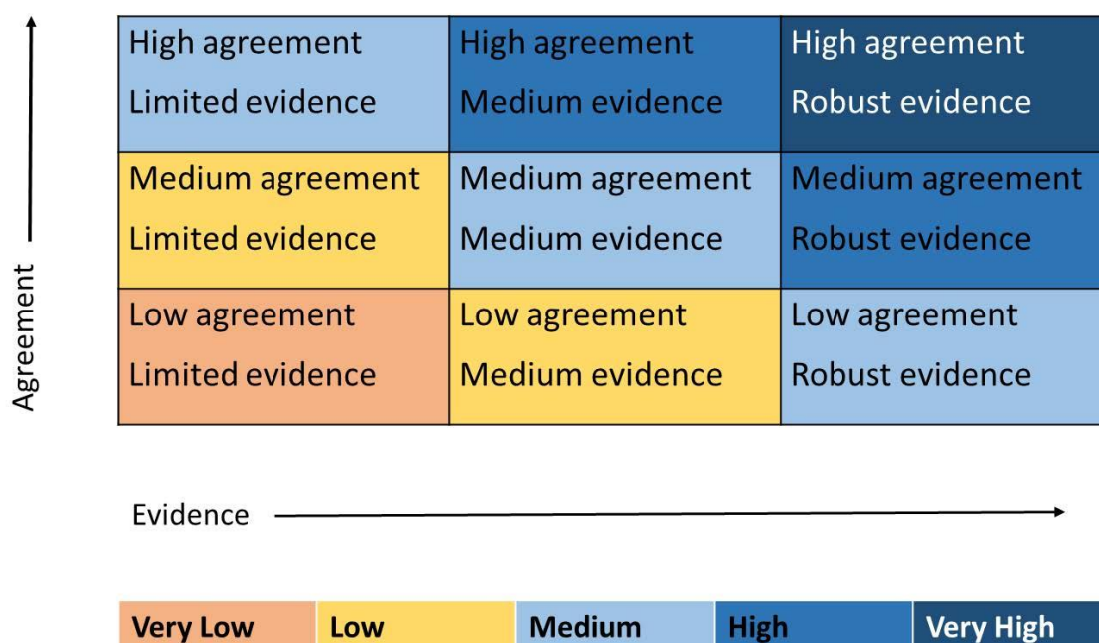

Figure 2-6: A depiction of the evidence (quality of assessments) and agreement statement (consensus or deviation of different assessment results) and their relationship to the confidence criteria. Source: OSPAR Agreement 2019-02 on QSR 2023 Guidance Document, based on IPCC Fifth Assessment Report, 2010.

2.2.9 Visualising assessment results

The presentation of assessment results should link up with presentations of reported information in the [WISE Marine Dashboard](#) and with [transparency of national approaches](#). Transparency is particularly relevant where Member States enjoy flexibility in assessment approaches or use national discretion in carrying out assessments and status classifications. If Member States carry out proceedings differently, they should do so transparently for the comparability of assessment results. Within this context, all applied methods with regard to integration, aggregation, and statistical evaluation of data should be laid down.

Where assessments involve many elements and integration steps, use [detailed tables](#) to capture the assessment result per criterion, possibly per parameter (e.g. D8C1, D10C1), possibly per element (e.g. D1/species, D3/stocks, D6/habitats) and per feature, depending on the specific assessment requirements and integration flow. Compiling individual assessment results for aspects meeting/failing threshold values, being unknown or not assessed or being assessed through trend will help to understand how the expression of the extent to which good status is achieved can be interpreted.

Chapters 4 and 5 recommend [Descriptor-specific presentations](#) for use by Member States. This includes different types of charts (pie or bar charts) to visualise assessment results at species, species group, indicator, or criteria level with different proportions or percentages. Map presentations are particularly useful for a general overview of assessment results and to identify regional differences and uncertainties in the assessment outcome. Trend assessments can be included in detailed tables, bar charts or pie charts as well as in maps in the form of arrows, trend lines, or providing additional information on statistical values for significance of trends.

2.3 Change in status

When assessing the status of their marine waters in accordance with Article 17(2)(a) MSFD, Member States should express any change in status as improving, stable or deteriorating, compared to the previous reporting period (recital 16 GES Decision). If GES has already been achieved, stable conditions will ensure that this status is maintained, while deterioration in status has the risk of leading to a status failing GES. Information on identified deterioration is particularly important to enable additional measures to be taken as soon as possible to address the situation. In this context, consideration of timelines is important since the marine environment often responds slowly to management changes.

The GES Decision refers to a comparison of [status between two six-year assessment periods](#). For reporting in 2024, this would be a comparison of the period 2016–2021 with 2010–2015 (→ section 2.2.5). The change in status should not be confused with trend assessments involving long-term data sets (→ section 2.2.5).

The [method to indicate the change](#) in status is dependent on the assessment concept for the respective criteria, element, feature, and their level of development.

Change of status relates to:

- **Overall status:** The MSFD knows only two status classifications – good environmental status achieved or not achieved. Status classification takes place at feature level, i.e. at higher integration level. A change between GES not achieved and GES achieved may not be readily seen: Improvements of the environment in response to measures may take time or integration may hide unwanted directions. To make changes at status level visible between assessment periods, the change in the extent to which GES is achieved should be looked at. This extent is expressed according to the GES Decision as a proportion of elements or waters (area) for which

threshold values are achieved. Change of such proportions provide an indication of whether the marine environment is improving, stable or deteriorating, compared to the previous assessment period, even if GES is not yet achieved. Change of status could also be calculated as the percentage of deviation from a threshold or by using additional classes or class subdivisions to express the distance of current state from GES.

- **Parameter or indicator level:** Changes in the environment will often be more readily visible at a more detailed, i.e. finer assessment level (e.g. parameter, indicator level). This information can provide early signals for the direction in which the environment is developing. This may provide evidence that measures start showing effects in the marine environment or that parameters take an unwanted direction, requiring action.

To determine a change in status or parameter, it is necessary to understand whether the change observed is due to a change in the ecosystem component/pressure considered, or due to other factors. Such confounding factors include:

- A **change of assessment method** from the previous reporting due to evolving knowledge and methodological advances (e.g. change in definition or value of threshold values, change of integration rules, change of the assessment scales). This includes situations where assessment tools were not available in the previous reporting round and the status was reported as 'not assessed', 'unknown', or as a trend.
- A **change in data coverage**. For some topics, monitoring started only recently, and data were not available in previous assessment periods. In other cases, data may have been available but not used, or older data sets may have been revised.

Comparability of change in status across Member States may also be compromised by differing assessment periods and data year coverage in the 2018 reporting round, which may lead to gaps and overlaps with the 2016–2021 assessment period.

Depending on the complexity of the assessments, options are:

- **Re-assess the previously reported data sets** using the methods of the latest assessment or to re-assess the previous period based on the new/revised data sets for that period. Whether this is feasible is a case-by-case decision. This may be easier at parameter and indicator level than for integrated assessments. The OSPAR arrangement for the forthcoming eutrophication assessment is an example for a re-assessment of an integrated assessment to allow conclusions on change. Re-assessments not only allow to compare the results, but also help explaining the differences in status observed from one cycle to another. Re-assessments should also be considered, where necessary and feasible, to align the six-year period of the past assessment with 2010–2015 to enhance comparability of conclusions on the change of status with the recent assessment for 2024.
- **Use expert judgement** to provide a qualitative conclusion on a possible change of status. If data permit, use a trend analysis over the assessment periods to substantiate expert judgement with data-based evidence and allow a semi-quantitative evaluation. Trend analysis may be feasible mainly at parameter and indicator level less so at the level of overall status.
- **Change in status is 'unknown':** Explain factors preventing judgement of change.

Expressing the confidence level of the observed change may support conclusions and steer on whether measures must be taken or adapted to achieve GES.

Article 8 MSFD reporting to date covers change in status only at parameter level. To cover change in overall status, a reporting field needs to be added for 2024 reporting.

2.4 Relationship between regional and national assessments

This section considers the linkage between Article 8 MSFD assessments and national Article 8 MSFD reporting. Reporting guidance is given in a separate document. EU MSFD CIS Guidance Document No. 14 on Reporting on the 2018 update of articles 8, 9 and 10 for the MSFD is currently under revision and will address the details of the issues considered in this section. For final guidance on the relationship between regional and national assessments consult the revised reporting guidance once available. This section takes account of the state-of-play of discussion presented in → [DIKE 25-2021-06](#) (first proposal for updating EU MSFD CIS Guidance Document No. 14) and → [DIKE 24-2021-06](#) (discussion paper on use of regional assessments in national reporting).

2.4.1 Regionally coherent assessments

The MSFD and the GES Decision require regional coordination in undertaking Article 8 assessments, firstly to yield results which are consistent and compatible between countries in a (sub)region, and secondly, to ensure the assessments are undertaken at ecologically or hydrologically relevant scales.

Member States are encouraged to undertake the Article 8 assessment due by 2024 through regional cooperation, following this Guidance Document as far as possible and to use the regional assessments (quality status reports under development in the marine regions) to fulfill their reporting obligations under Article 8 MSFD.

For regional assessments for which this Guidance Document comes too late to allow for full alignment, Member States are encouraged to coordinate regionally their use and to consider, where possible, giving priority to regional coherence over the national application of this Guidance Document in all aspects.

Regional coordination on reporting should also be sought where regionally agreed methodological standards are not yet in place. This includes regional coordination for example on the use by Member States of national threshold values (Article 4(2) GES Decision) where these have not yet been agreed at regional level.

If regionally agreed threshold values are not available, the assessment should be reported as 'unknown' or 'based on national threshold values'. Such a twofold approach would meet national management needs and avoid incompatible assessment results across the region and preemption of a final – regionally coordinated – status classification and statement on the extent of GES achieved.

Similar considerations underpin the recommendation in → section 4.6 where, in the absence of an agreement of integration rules, the status of macro- and micro-litter in the marine environment (criterion and feature level) should be reported 'unknown' in 2024. In that case status reporting stops at the parameter level which coincides with indicator assessments available through regional cooperation.

If such approaches are taken, Article 12 MSFD evaluation of Member States' reports would need to take these into account as in those cases Member States can achieve either compliance with GES Decision (and following the guidance) or regional coherence, but not both.

2.4.2 Assessment area and marine reporting unit

Assessments take place at varying scales. Depending on the feature, the assessment scales may involve a high resolution (including national subdivisions) or take place in large areas cutting across national boundaries. The actual areas subject to assessment are defined in line with the relevant scales and are organised through a nested approach (→ section 2.2.3).

The MSFD obliges Member States to report the status of ‘their marine waters’ to the Commission. This has led to the distinction between:

- assessment areas, i.e. ecologically or hydrologically relevant scales for the assessment ; and
- marine reporting units (MRUs), i.e. units covering all or parts of a Member State’s marine waters used for reporting.

MRUs may coincide with the boundaries of assessment areas or they may be specifically related to national boundaries. MRUs should fit with the nested approaches, i.e. smaller units should fit with the boundaries of larger areas. Whether to use a (sub)regional or national scale as MRU should be agreed through regional cooperation per feature. Regional agreement ensures that, unlike in the 2018 reporting, Member States’ reports do not spatially overlap and lead to contradictory status results for the same area. Further guidance on which descriptors / features are more relevant for either a (sub)regional scale or national MRU scale may become available through ongoing DIKE discussions.

Motivations for using MRUs with national boundaries include for example:

- The national definition of good status
- Local specifics (elements not/occurring in national waters)
- The need for high assessment resolution to devise measures and management action
- Demonstrate and communicate status of national waters as a basis for national programmes of measures

2.4.3 Linking regional assessment and national reporting

There are three main scenarios to link regional assessments and national reporting whose application per feature is subject to (sub)regional agreement:

- MRU reflects the ecologically / hydrologically relevant assessment area: regional assessment results are reported one to one, using the regional data set.
- MRU within national boundaries is part of a larger regional assessment area and the regional results are fully valid for national waters: regional results are reported one to one, using the national subset of the regional data set.
- MRU within national boundaries is part of a larger regional assessment area but the regional results are not fully valid for national waters because e.g. a specific local element is missing in the assessment or an element part of the assessment is not relevant for determining good status for the national waters: The additional national element is assessed, following regionally agreed methodologies, based on national data. The national assessment results are combined with same level regional assessment results, using the regionally applicable integration method. In this scenario, the national subset of the regional data set, supplemented with data

for the additional element, is used. Similarly, the regional assessment is reconstructed without the element not relevant for national waters.

Linking regional assessment and national reporting may raise a number of specialities, namely in relation to the assessment of species and habitats:

A speciality relates to the status assessment of species with wide distribution or range, i.e. large assessment areas (e.g. marine mammals, → section 5.2). Species assessments are based on the assessment of their populations within the assessment area. To date status is reported in relation to the species, not the populations. While a population relevant in a MRU (with national boundaries) may be of one status (good / not good), the species may be in the opposite status.

Another speciality relates to benthic habitats (→ section 5.7). The extent (% of area) to which GES is achieved for a benthic broad habitat type or an other habitat type relates to a reference area. If a MRU with national boundaries is chosen, the extent of GES will differ from that relating to the assessment area of the habitat type.

2.4.4 National assessments

In contrast to the cases illustrated under → section 2.4.3, assessments building on specific national data sets (i.e. not a subset of the regional data set) or following national assessment methodologies are national assessments and will relate to national MRU. They are assumed not to be compatible with other Member States' results.

2.5 Gaps in knowledge and outstanding issues

Chapters 4 and 5 capture specific gaps in knowledge and outstanding issues on the Descriptor-specific assessment frameworks. In addition, the following cross-cutting issues still require to be addressed for guidance:

- Consistency of criteria/indicator assessments across Descriptors
- Use of pressure and impact criteria in status assessments of species and habitats
- Translation of specific confidence assessments into one high level confidence scheme to be reported under Article 8 MSFD for comparability of assessment results

3. Role of climate change in the assessment framework

Climate change is one of the cross-cutting horizontal issues in need of attention under the MSFD. To date, climate change and ocean acidification are not specifically addressed by the MSFD. So far, no expert discussion has taken place in the EU MSFD CIS process on their role in the assessment framework of the MSFD. Also in the Regional Sea Conventions, the assessment of physical and chemical changes of the marine waters and associated impacts on marine ecosystems started only recently, although national monitoring programmes may already be in place.

Against this background, this chapter describes aspects of climate change and ocean acidification interfering with MSFD assessments, as well as potential avenues for future monitoring and assessment in an MSFD context. The chapter intends to provide a starting point for further discussion on the role of climate change and ocean acidification for MSFD status assessments and on any future monitoring and assessment needs, recognising the importance and emerging nature of climate change and ocean acidification impacts on the marine environment. This chapter is not intended to be mandatory or instruct Member States for 2024 reporting under Article 8 MSFD.

3.1 Key concepts and definitions of the subject

3.1.1 Definitions

- *Climate change*: variation in the state of climate that can be identified (e.g. by using statistical tests) by changes in the mean and/or the variability of its properties, and that persists for an extended period of time, typically decades or longer. Climate change may be due to natural internal processes, such as variations in ocean currents or atmospheric circulation, or external forces such as modulations of the solar cycles, volcanic eruptions and persistent anthropogenic changes in the composition of the atmosphere, or in land uses. Note that the United Nations Framework Convention on Climate Change (UNFCCC), in its Article 1, defines climate change as: ‘a change of climate which is attributed directly or indirectly to human activity that alters the composition of the global atmosphere and which is in addition to natural climate variability observed over comparable time periods’. The UNFCCC, thus, makes a distinction between climate change attributable to human activities and climate variability attributable to natural causes (IPCC, 2019).
- *Greenhouse gases (GHGs)*: gaseous constituents of the atmosphere, both natural and anthropogenic, that absorb and emit radiation at specific wavelengths within the spectrum of radiation emitted by the Earth’s ocean and land surface, by the atmosphere itself, and by clouds. This property causes the greenhouse effect. Water vapour (H₂O), carbon dioxide (CO₂), nitrous oxide (N₂O), methane (CH₄) and ozone (O₃) are the primary GHGs in the Earth’s atmosphere. Human-made GHGs include sulphur hexafluoride (SF₆), hydrofluorocarbons (HFCs), chlorofluorocarbons (CFCs) and perfluorocarbons (PFCs); several of these are also O₃-depleting (and are regulated under the Montreal Protocol) (IPCC, 2019).
- *Ocean acidification (OA)*: reduction in the pH of the ocean, accompanied by other chemical changes (primarily the levels of carbonate and bicarbonate ions) over an extended period, typically decades or longer, which is caused primarily by the uptake of carbon dioxide (CO₂) from the atmosphere. Anthropogenic OA refers to the component of pH reduction that is caused by human activity (IPCC, 2019). While OA links to the carbon cycle and not to climate, it is included for convenience in this chapter under the headline of climate change given the interactions with

chemical and physical changes of marine waters induced by climate change and potential feedback effects on climate change.

- **Stratification:** process of forming layers of (ocean) water with different properties such as salinity, density and temperature that may act as a barrier for water mixing. The strengthening of near-surface stratification generally results in warmer surface waters, decreased oxygen levels in deeper water, reduced upward mixing of nutrient-rich deep waters and plankton vertical migration, and leads to intensification of ocean acidification (OA) in the upper ocean. (IPCC, 2019).
- **Biogeochemistry:** scientific discipline that involves the study of the chemical, physical, geological, and biological processes and reactions that govern the composition of the natural environment (including the biosphere, the cryosphere, the hydrosphere, the atmosphere, and the lithosphere). In particular, it focuses on the study of the cycles of chemical elements, such as carbon and nitrogen, and their interactions with and incorporation into living organisms transported through earth-scale biological systems in space through time. The field focuses on chemical cycles which are either driven by or influence biological activity. (IPCC, 2019).
- **Background environmental conditions (BEC):** physical, chemical, and biological conditions existing in a particular marine area, including hydrographic and climatic components. The concept refers to the mean environmental conditions prevailing in a given marine region/subregion/area over a defined period of time.
- **Resilience of ecosystems:** property of ecosystems that allows them to resist undergoing extensive changes due to climate change. Intact ecosystems are more resilient to these changes than anthropogenically weakened ecosystems and therefore could play a critical role in mitigating the negative impacts of climate change. For example, reefs act as natural coastal protection; seagrass beds are natural carbon sinks and nurseries for juvenile fish; sufficient areas without anthropogenic pressures offer marine animal and plant species the opportunity to regenerate.

3.1.2 Climate change: the phenomenon and its implications for the marine environment

Climate change can be defined as the variability observed in Earth's climate through time. This variability is caused by both natural processes (e.g. changes on Earth's orbit, volcanic activity) and human activities (e.g. deforestation, fossil-fuel burning). Throughout Earth's history, climate change has been mainly driven by natural processes, resulting in slow changes (millennial timescales) that allowed adaptation of organisms. However, since the industrial revolution, greenhouse gases have been released to the atmosphere, via human activities, at an unprecedented rate. This has led to rapid changes in the climate system such as global warming or increased frequency of extreme events that compromise the adaptation and survival of terrestrial and marine ecosystems.

A warmer climate leads to a warmer surface ocean, given that most thermal energy stored in the atmosphere is taken up by the ocean. As a result, an increase in mean surface temperature of 0.11 °C per decade has been observed since 1970 (IPCC, 2019) and this warming trend is expected to continue during the 21st century. The ocean has also absorbed around a third of the anthropogenic CO₂ released to the atmosphere since the industrial revolution (Cais et al., 2013). As a result, pH has decreased by 0.1, corresponding to an increase in acidity of 26 %. Additionally, there is increasing evidence that the ocean's oxygen content is declining via solubility effects, changes in circulation, eutrophication, mixing and oxygen respiration (Oschlies et al., 2019). Lastly, the global water cycle

has also been altered due to global warming, leading to regional changes in sea surface salinity (Rhein et al., 2013), which are also expected to continue.

The aforementioned changes may cause a variety of impacts on marine systems. Physical and chemical effects derived from climate change, such as increasing temperature might have a direct impact on certain species and/or habitats (e.g. changes in the distribution/migration patterns of (commercial) fish). They might also lead to further changes, such as alteration of ocean dynamics or water column structure (mixing/stratification), which ultimately has an effect on heat transport and biogeochemical cycles, and therefore on marine habitats/species. Thus, climate change-derived effects (direct and indirect) constitute stress factors for marine ecosystems and should be reflected better in the MSFD. Acidification of marine waters also has a range of effects on marine organisms and habitats, including dissolution of exposed carbonate structures and reduced performance especially in early life stages of organisms.

3.1.3 Climate change within the MSFD

The MSFD addresses climate change as a horizontal issue. Background environmental conditions (BEC) and climate change are mentioned along MSFD documents (preamble, recital no. 42), but are not specifically addressed within any Descriptor or pressure. Climate change has also been considered to be part of Descriptor 7 (D7) by some countries (besides alterations of hydrographic conditions resulting from human-made infrastructures).

During the first cycle of MSFD implementation, through Regional Sea Convention cooperation (HELCOM, OSPAR, Barcelona and Bucharest Conventions), a set of common indicators and monitoring programmes for different environmental conditions have been developed. However, it has been proved difficult to obtain quantitative values for the agreed indicators (numerical reference values) for most Descriptors, and even more difficult to establish specific thresholds that allow to classify the GES as 'achieved' or 'not achieved'. To date, no quantitative reference or threshold value has been established for D7 or climate change.

Further work, such as the technical guidance by Joint Research Center (JRC) on monitoring for the Marine Strategy Framework Directive (Zampoukas et al., 2014) acknowledges that hydrographic conditions constitute fundamental background information for other Descriptors and that they should be strongly tied to existing observing systems. As such, the horizontal character of these environmental conditions (including biogeochemistry) is highlighted.

Finally, based on the last versions of different technical documents (Guidance Document on how to reflect changes in hydrographical conditions in relevant assessments (Deltares, 2015), EU MSFD CIS Article 8 Assessment Guidance (test version 2017)), and according to the approach of the GES Decision, D7 can no longer be related to general BEC (→ section 4.3). These documents link D7 with local hydrographical alterations caused by human-made structures, and their effects on habitats, while they acknowledge that BEC are horizontal cross-cutting factors of key importance for all MSFD Descriptors and that resources need to be allocated for this task. Thus, hydrographic parameters are essential for the assessment of other Descriptors, such as eutrophication, biodiversity, or marine litter.

3.2 General approach and key recommendations

Climate change and ocean acidification lead to variations in marine environmental conditions such as pH, temperature, salinity and/or dissolved oxygen concentration. Besides their direct effects on marine ecosystems, these variations might cause further alterations such as changes in ice cover,

ocean currents, or water column structure. These (direct and indirect) changes may impact ocean biogeochemistry, species distribution and/or food change dynamics. Thus, climate change and ocean acidification act as a pressure, given that these changes constitute stress factors for marine ecosystems.

Climate change and ocean acidification, therefore, have an effect on marine BEC that should be monitored within the MSFD, but also act as a stress factor/pressure that should be taken into account. As such, climate change and ocean acidification must be considered in the marine environment assessment within the framework of the marine strategies. Considering their dual nature (pressure and BEC), such an assessment might be complex to achieve. Here, an approach to assess climate change within the context of the MSFD is proposed based on the following pillars:

- Monitoring and analysis of climate change-derived variations and carbonate chemistry as background environmental conditions.
- Monitoring and analysis of current and potential impacts on marine ecosystems.

3.2.1 Monitoring and analysis of climate change-derived variations as background environmental conditions

As stated above, BEC monitoring is not part of the MSFD specifically. It is not addressed as part of a descriptor, as a pressure, or as a separate topic. However, BEC are required as fundamental information to determine the status of various Descriptors, to interpret the changes observed in such status, as well as to set reference and threshold values for those Descriptors. Therefore, it is essential to establish regular data collection of these BEC; including certain parameters within the MSFD monitoring programmes is a very effective way to ensure that these surveys are carried out on a continuous basis.

The key issue for considering climate change and ocean acidification within the MSFD is to determine whether current status of the ecosystem and its components is not good and if this is affected by anthropogenic pressures (that can be managed by MSFD policy). Within this scenario, it becomes important to understand the natural variability of the ocean, and the contribution of climate change and CO₂ absorption to the variability of the state of the ecosystem and its components (i.e. to understand if state/change in state is attributable to a manageable pressure or to changes in climate or the carbonate system that can be reported, but cannot be managed within MSFD itself).

For this understanding, a continuous monitoring of the variations related to those changes within European seas is needed. Thus, monitoring of BEC such as hydrography, dynamics, and chemistry (including the carbon cycle) within European seas is of key importance. For this purpose, it would be crucial that the MSFD strengthens its relationship with current ocean monitoring systems (euroGOOS and regional OOS, CMEMS-Copernicus, C3S-Copernicus, JERICO-RI, national climate services, UNESCO/IOC, etc.), and fosters regional expertise in the interpretation of the information. The following recommendations are proposed as a starting point and could be further discussed in the EU MSFD CIS process, once the role of climate change and ocean acidification in MSFD assessments will have been confirmed:

- MSFD monitoring programmes might include additional environmental variables (e.g. carbonate chemistry integrating atmospheric deposition), reinforcing *in situ* monitoring systems, while ensuring that such information is properly managed into international databases. In this regard, it would be crucial to monitor the carbonate system, allowing an assessment of ocean acidification through time.

- Partners involved in regional MSFD work should have continuous feedback with euroGOOS, EMODnet, JERICO-RI, CMEMS and C3S, providing interpretations of ocean status at regional level to frame the MSFD indicators development (regional expertise).

At the same time, new environmental information comes along with the new monitoring programmes created to follow the implementation of the MSFD. These programmes include monitoring of environmental conditions such as physical and chemical elements, habitat and species distribution, introduction and establishment of non-indigenous species, trophic guilds, or frequency and intensity of red tides. These data could be used to analyse trends and identify possible linkages with climate change variables.

3.2.2 Monitoring and analysis of current and potential impacts on marine ecosystems

As previously described, changing marine environmental conditions derived from changes in climate and the carbonate system constitute stress factors for marine ecosystems and must be considered in the marine environment assessment within the framework of the marine strategies. However, evaluating to what extent variations in the state of marine ecosystems are due to direct local/regional anthropogenic pressures or due to change in climate and carbonate system might be difficult to ascertain.

A continuous analysis of how climate change and acidification are affecting marine ecosystems, distinguishing those effects from natural variability, is needed, and must be integrated within the MSFD. Such an analysis could be possibly achieved through the use of indicator species or habitats (or other parameters, e.g. sea ice cover) which are particularly sensitive to these changes, taking into account the following steps:

»» *Identification of indicator species/habitats (or other parameters)*

Habitats and/or species (or other elements) sensitive to changes in climate and the carbonate system (as well as affected areas), should be identified for each marine region by Member States. Given the complexity of climate change and ocean acidification, each region/subregion is recommended to use more than one indicator species/habitat (or other parameter) when developing its assessment strategy. Ideally indicator species/habitats (or other parameters) should cover more than one climate change-derived effect (e.g. species/habitats/other vulnerable to temperature, salinity, or further changes) or ocean acidification. Identification of indicator species/habitats (or other parameters) could be achieved using already published and/or ongoing research (if that is the case) within a specific region. As an example, the species *Posidonia oceanica* is vulnerable to climate change (Marbá and Duarte, 2010; Chefaoui et al., 2018) and might therefore be chosen as one potential climate change indicator species within the Mediterranean Sea. Also, *Lophelia spp.* is being studied by OSPAR to assess the effects of ocean acidification. Identification of specific climate change indicators (species/habitats/other parameters) could be further explored by Member States through new research/analysis depending on their resources (funding/time available).

»» *Monitoring of indicator species/habitats (or other parameter)*

It is recommended that monitoring of the indicator species/habitats (or other parameter) identified in the previous step is included in that of each specific Descriptor considered under the MSFD, always taking into account its sensitivity to climate change.

»» *Comparison of (monitored) environmental conditions with indicator species/habitat (or other parameter) distribution (or abundance)*

Based on the best available monitoring data previously described, it is recommended that variations in BEC are considered to evaluate the extent to which changes in the state/distribution of habitats and populations are due to direct local/regional anthropogenic pressures (other than climate change) or changes in climate and the carbonate system.

»» *Taking into account the effects due to climate change variability in the establishment of the threshold values of the selected indicators (such as habitat regression, or mass mortality of species)*

This is proposed to ensure that climate change and ocean acidification are considered in the assessment and in the GES determination of the affected Descriptors. As an example, it would not be acceptable that *Posidonia oceanica* reduces its distribution significantly as a result of temperatures rising to unacceptable levels. Such unacceptable levels should be considered/established in the assessment.

»» *Outlook on future reporting*

A specific descriptive chapter for climate change analysis could be included in the general part of a future Article 8 reporting schema. This chapter could describe the elements considered for the assessment of climate change and ocean acidification as well as for the conclusions reached from this assessment.

The above proposed stepwise approach would constitute a starting point for evaluating to what extent European seas are being affected by climate change and ocean acidification, and will likely help identify impacts that may compromise the achievement of GES for those seas (e.g. if a species is disappearing or changing their habitat or distribution rapidly probably due to climate change). This approach should be basin/region-specific.

In addition to this, such an approach may also be useful when assessing the implementation of climate change policy.

A group of experts could be created in the WGGES framework for supporting this task to be developed in a homogenous way throughout the EU, although this analysis must be done at regional and local levels.

Finally, the implementation of this approach could be used for the identification of actions to include in the MSFD programmes of measures (Article 13 MSFD). Mitigation of climate change and acidification could seem difficult through the MSFD, as their main drivers (increasing CO₂ and other greenhouse gas emissions) are addressed by the United Nations Framework Convention on Climate Change through the Paris Agreement or other tools such as the European Union Emissions Trading Scheme. Within the context of the MSFD, climate change adaptation and mitigation could be approached via conservation/restoration and ecosystem management (e.g. Roberts et al., 2007), that each Member State could implement through its environmental targets (Article 10 MSFD) and programmes of measures (Article 13 MSFD). The MSFD should help anticipate and avoid cumulative effects (→ section 2.1.2), targeting actions on habitats or species whose response to climate change will likely be worsened or exacerbated by the other anthropogenic threats they face, or the other way around, on habitats, species, or locations whose resilience to new stressors is already weakened by climate change.

3.3 Next steps

The following steps are recommended under MSFD in relation to future assessments beyond 2024:

- The review of the MSFD, due by 2023, may consider addressing climate change and ocean acidification in relation to the assessment of GES of marine waters.
- If climate change and ocean acidification were considered under MSFD in the future, an expert group dedicated to climate change should be established related to other EU MSFD CIS expert groups.
- Develop a common minimum set of parameters for background environment conditions (including e.g. pH) and appropriate assessment approaches through EU or (sub)regional cooperation.
- Investigate further possible linkages of monitoring and assessment for climate change, acidification and D7 on hydrographical changes, at a (sub)regional level.

4. Pressure-based Descriptor Assessments

4.1 Descriptor 2: Non-indigenous species

Descriptor 2: Non-indigenous species introduced by human activities are at levels that do not adversely alter the ecosystems. (MSFD Annex I)

DESCRIPTOR PROFILE		D2C1 Newly introduced NIS	D2C2 Established NIS	D2C3 Impact of NIS
Feature		Newly introduced NIS	Established NIS	Species, pelagic and benthic broad habitats
Primary criterion		X		
Information type		Pressure	Pressure	State/Impact
Annex III MSFD	State (Table 1)	Species	Species	Species; Habitats
	Pressure (Table 2a)	Input or spread of non-indigenous species		
	Activity (Table 2b)	Cultivation of living resources; Transport – shipping; Tourism and leisure		
GES Decision	Elements		EU Reg. No. 1143/2014; (sub)regional	(sub)regional
	Threshold values	(sub)regional	(sub)regional	(sub)regional
	Use of criteria	(sub)regional		
Criteria linkages			D2C3	D1C2-D1C5, D1C6, D4C1*, D6C5
Descriptor linkages		D1, D4*, D6		

* Not included in the GES Decision

» Elements

Guidance for D2C1

As criterion D2C1 considers newly introduced non-indigenous species (NIS), there is no requirement for an agreed list of elements for assessment. D2C1 should cover NIS that were not known to be present in the area in the previous assessment period. First observations of NIS, cryptogenic and questionable species should be included in the reporting, even if it is unknown whether a new arrival is due to human activity or natural dispersal, and species found in coastal water regardless of their oligohaline/marine/freshwater status.²⁶

From the reported species, first observations of species are excluded from the threshold-based criterion assessment if there is uncertainty about their non-native nature (i.e., ‘questionable species’ and ‘cryptogenic species’), or if they are partly native (i.e., species which are native and non-native in parts of the same subregion) and the cause of discrepancy in the subregional assessment. Species are questionable due to unresolved taxonomy and lack of expert verification. Species are cryptogenic if explicit evidence of their origin is lacking. The questionable and cryptogenic species should remain excluded from the status assessment until the uncertainty about their non-native nature is resolved. Species typically having such statuses, due to large gaps of knowledge, are e.g. phytoplankton and parasitic species.

²⁶ Addressed by D2 experts at a Workshop on 6-7 October 2020 due to potential discrepancy on how these NIS were included in Member States’ D2 assessments. For Workshop report see Tsiamis et al., 2021a: <https://data.europa.eu/doi/10.2760/035071>

For NIS introduced from one infested area to another through natural dispersal, it might be that secondary spreading occurs also through other means (e.g., ship hull fouling, ballast water, etc.). Their inclusion in / exclusion from the D2C1 assessment should be handled case-by-case depending on certainty of pathway information.

Presumed extinct species, i.e. species reported in Member States several decades ago but never recorded again in the wild in these Member States, and thus considered as possibly extinct, should be examined case-by-case as to whether they correspond to a new introduction in an area and should be included under D2C1 reporting and assessment.

For identifying whether a species is 'newly introduced', a baseline list of marine NIS previously recorded for the European seas is available based on coordinated evaluations by JRC, CIS expert network, Member States and RSCs representatives. For each Member State, the baseline list includes the records of 'newly introduced' species until 2012 (Annex 2 in Tsiamis et al., 2021a).

Note that the baseline list has not yet been included in the → [element enumeration list](#) for reporting. It is recommended to use the baseline list as a reference for 2024 reporting as well as the additional information available in EASIN²⁷, i.e., pathways at Member States and subregional level (Annexes 2 and 3 in Tsiamis et al., 2021a) in the context of CIS.

Guidance for D2C2

Criterion D2C2 considers established NIS, particularly invasive NIS on the list of Union concern of the Regulation (EU) No. 1143/2014, contributing significantly to adverse effects on particular species groups or broad habitat types. 'Established' NIS are understood as those known to be present in the area, having established a viable population and being able of spreading unaided in the environment. The list of those species should be established through (sub)regional cooperation. Elements for assessment are NIS established in the waters under Member States' jurisdiction in the (sub)region except for phytoplankton (due to uncertainty regarding native versus non-indigenous status), parasitic species with insufficient information, and partly native species.

Guidance for D2C3

Criterion D2C3 requires to establish the species groups and the broad habitat types that are at risk from NIS, including relevant invasive NIS of Union concern, through (sub)regional cooperation.

»» Assessment areas and scales

The review and analysis of the EU Member States' 2018 reports (Tsiamis et al., 2021b²⁸) showed that Member States applied D2 at: a) regional level (e.g. for FI: entire Baltic Sea), b) national part of a subregion (e.g. for DE: national part of the Great North Sea and Baltic Sea), c) subdivision of national part of a subregion (e.g. for ES: northern part of the national waters of the Bay of Biscay), and d) a combination of the above.

It is recommended to assess and report D2C1 at the scale of national waters within a marine (sub)region. The Macaronesia is an exception given the sharp ecological and geographical differences between the Portuguese archipelagos. Here D2 should be assessed at the subdivision level (Azores, Madeira) of the national part of the MSFD subregion (PT part of Macaronesia) (Tsiamis et al., 2021b).

²⁷ <https://easin.jrc.ec.europa.eu/easin/Documentation/MSFDDescriptor2>

²⁸ <https://data.europa.eu/doi/10.2760/7897>

This is in line with recommendations and practices for NIS assessment scales applied by OSPAR for the North-East Atlantic (OSPAR, 2018)²⁹ and UNEP/MAP-MED POL for the Mediterranean Sea (UNEP/MAP, 2021)³⁰. The HELCOM holistic assessment in 2017 took place at subbasin level.³¹ The same is valid for the Black Sea Convention.³²

Guidance on assessment areas and scales for D2C2 and D2C3 is still to be developed.

»» Temporal aspects of assessment

The review and analysis of the EU Member States' 2018 reports (Tsiamis et al., 2021b) showed that Member States have started the D2 assessment in 2011, 2012 or 2013, and as a result had different assessment periods 2011–2016, 2012–2017, or 2013–2018.

The six-year period for the assessment due for reporting in 2024 should be 2016–2021 and should be applied uniformly within and across marine regions. For assessment period, trend assessment and change of status see → section 2.2.5 and 2.4.

»» Spatial aggregation of assessment

Guidance on spatial aggregation is still to be developed. In the interim, Member States determine the spatial resolution of assessments and methods for spatial aggregation and do so through regional coordination.

»» Threshold values

Guidance for D2C1

Threshold values are to be established through (sub)regional cooperation. In support of the 2018 Article 8 assessments, the following indicators, threshold values and assessment methods were used in marine regions (status 2017):

Marine region	Indicator	Threshold value	Interim approach
North-East Atlantic	OSPAR: Trends in new records of NIS introduced by human activities ³³	---	Interannual trends within and between assessment periods are analysed and interpreted
Baltic Sea	HELCOM: Trends in arrival of new non-indigenous species ³⁴	Zero: No new introductions of NIS per assessment unit through human activities during a six-year assessment period	
Mediterranean Sea	UNEP/MAP: Trends in abundance, temporal occurrence and spatial	---	Interannual trends within and between assessment periods

²⁹ <https://www.ospar.org/work-areas/cross-cutting-issues/ospar-common-indicators>

³⁰ <https://www.medqsr.org/integrated-monitoring-and-assessment-programme-mediterranean-sea-and-coast>

³¹ <https://www.helcom.fi/wp-content/uploads/2019/08/Trends-in-arrival-of-new-non-indigenous-species-HELCOM-core-indicator-2018.pdf>

³² https://ec.europa.eu/environment/marine/international-cooperation/regional-sea-conventions/bucharest/pdf/BSIMAP_2017_to_2022_en.pdf

³³ <https://oap.ospar.org/en/ospar-assessments/intermediate-assessment-2017/pressures-human-activities/non-indigenous/>

³⁴ <https://www.helcom.fi/wp-content/uploads/2019/08/Trends-in-arrival-of-new-non-indigenous-species-HELCOM-core-indicator-2018.pdf>

Marine region	Indicator	Threshold value	Interim approach
	distribution of NIS, particularly invasive NIS, notably in risk areas ³⁵		
Black Sea	Trends in number of recently introduced non-indigenous species. Name and number of newly introduced threatened species		Interannual trends within and between assessment periods

During the JRC-led workshop (6–7 October 2020), it was suggested that a possible approach for setting D2C1 threshold values could be to use a percentage of reduction of new NIS compared to the average number of new introductions that occurred in the previous six-year MSFD assessment periods (Tsiamis et al., 2021a). For example, assuming a percentage of reduction of 50 % for a subregion, and a number of new NIS introduction of 30 taxa during the last three six-year assessment periods (18 years in total), the threshold value would correspond to the 50 % reduction of the average number of NIS of the three assessment periods (i.e., 10), that is five new NIS. The percentage reduction would need to be decided at regional and subregional scale considering i) the pressure of pathways of introduction, ii) the monitoring coverage in each region and subregion, and iii) the number of NIS of previous MSFD assessment periods (Tsiamis et al., 2021a). The approach requires further discussion. The discussion on the approach on any exact value of percentage reduction and on the number of the previous six-year assessment periods required at regional and/or subregional scale, will be held within the context of an EU MSFD CIS D2 core group (JRC and representatives from Regional Sea Conventions).

Please see → section ‘Elements’ above for the species groups to be excluded in the calculation of the threshold values.

Guidance for D2C2 and D2C3

At a regional, subregional, or European level, there is not an agreed vision of GES for both criteria. It has been suggested during the JRC-led workshop (6–7 October 2020) that the species of Union concern included in the Regulation (EU) No. 1143/2014 could be a starting point for the assessment of the criteria (Tsiamis et al. 2021a). Both criteria are relevant for the GES assessment, but more work is needed to collect NIS data and agree on common methodologies.

»» Use of criteria

Guidance is still to be developed. Figure 4.1-1 illustrates the use of D2 criteria and levels of integration.

³⁵ <https://www.medqsr.org/integrated-monitoring-and-assessment-programme-mediterranean-sea-and-coast>

Scale: D2C1: region or subregional, if necessary divided by national boundaries. D2C2/C3: as used for Descriptors 1 and 6

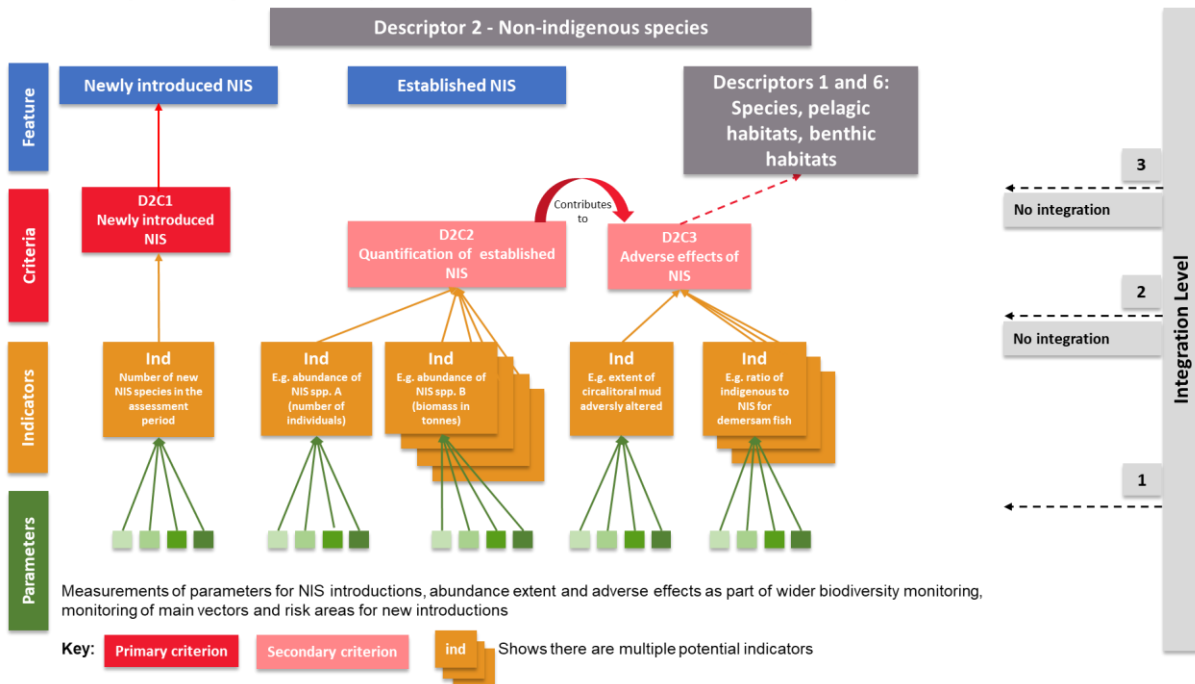

Figure 4.1-1: Levels of assessment and integration for Descriptor 2.

»» Confidence

Guidance is still to be developed.

»» Visualising assessment results

Guidance is still to be developed. For examples see → [OSPAR Intermediate Assessment 2017](#), → [HELCOM Status of the Baltic Sea Report 2017](#) and → [Mediterranean Quality Status Report 2017](#).

»» Gaps in knowledge and outstanding issues

Gaps in knowledge

- Monitoring of NIS: Monitoring is biased in space and time and there is a need for harmonisation at subregional and regional levels. Spatially, monitoring should be prioritised in hotspot areas (ports and aquaculture units) and in vulnerable areas (islands, lagoons, marine protected areas, etc.). Temporally, it should consider the species ecology and life history. Monitoring is also biased by the taxonomic expertise capacity and reference used. As a result, there is a need to promote the establishment of a (sub)regional coordinated expert network.
- Data, databases, and data flow for assessments: Sharing and exchanging data on NIS is key to decrease the uncertainty of species pathways and date of first record, and to keep information updated. There is a need to consider the role of existing databases in relation to regional and EU level integration, working towards interoperability.

Outstanding issues

- Close identified guidance gaps (e.g. method for threshold setting, spatial aggregation, confidence, and visualisation of assessment results).

GD 19: Article 8 Assessment Guidance

- Develop a common understanding and further guidance on the role and use of D2C2 and D2C3.
- Agree threshold values through regional cooperation.

4.2 Descriptor 5: Eutrophication

Descriptor 5: Human-induced eutrophication is minimised, especially adverse effects thereof, such as losses in biodiversity, ecosystem degradation, harmful algae blooms and oxygen deficiency in bottom waters. (MSFD Annex I)

DESCRIPTOR PROFILE		D5C1 Nutrients	D5C2 Chl <i>a</i>	D5C3 HAB	D5C4 Photic limit	D5C5 Oxygen	D5C6 Opp. macro- algae	D5C7 Macro- phytes	D5C8 Macro- fauna
Feature		Eutrophication							
Primary criterion		X	X			X			(X)*
Information type		Pressure	Impact	Impact	Impact	Impact	Impact	Impact	Impact
Annex III MSFD	State (Table 1)	Ecosystems/food webs; Habitats				Eco- systems/ food webs; Habitats; Species	Habitats; Species		
	Pressure (Table 2a)	Input of nutrients; Input of organic matter							
	Activity (Table 2b)	Cultivation of living resources; Transport; Urban and industrial uses; Physical restructuring of rivers, coastline or seabed (water management)							
GES Decision	Elements	Directive 2000/60/EC; (sub)regional							
	Threshold values	Directive 2000/60/EC; (sub)regional							
	Use of criteria	EU or (sub)regional							
Criteria linkages			D1C6, D4C2**	D1C6	D1C6, D6C5	D6C5	D6C5	D6C5	D6C5
Descriptor linkages		D1, D4, D6							

* D5C8 is a primary criterion if it replaces D5C5

** Not included in the GES Guidance

»» Overview of assessment framework

The criteria of the GES Decision for Descriptor 5 can be divided into three groups, which provide a conceptual cause-effect relationship framework for eutrophication (the association of D5C4 with direct or indirect effects is still to be decided):

- Causes of eutrophication: D5C1 defines the concentrations of nutrients in the water column.
- Direct effects of nutrient enrichment: D5C2–D5C3, (D5C4), D5C6–D5C7 which indicate what impacts the nutrients have directly on the marine environment (by enhanced primary production).
- Indirect effects of nutrient enrichment: (D5C4), D5C5, D5C8 which indicate the impacts of enhanced primary production.

When setting up the assessment for Descriptor 5 at a regional level, the cause-effect relationship should be established. The link between the pressure (enrichment of nutrients in the water column) and its effects on the accelerated growth and change in species composition of phytoplankton and macrophyte communities, resulting in undesirable disturbance to the balance of organisms present and on water quality, is necessary. Additionally, the benthic macrofauna may benefit from an increased food supply, leading to an increase in macrofaunal biomass as indirect effect. Also

depending on the degree of eutrophication, the effects can finally lead to oxygen depletion in waters near the seabed as another indirect effect with consequent adverse effects on macrofaunal communities.

Existing assessment frameworks already follow cause-effect relationships. Identifying the causal relationship can be done at different stages of the preparation for the assessment. For example, it may be shown at the point of choosing the set of elements used in the assessment (as is done in the HELCOM approach); or may be structured in the assessment tool, at the criteria level or groupings of criteria.

Descriptor 5 is to be implemented in accordance with assessments under the WFD: This means that the quality elements applied in the WFD assessment of ecological status (except for river-basin-specific pollutants) are to be applied in coastal waters (1 nm from baseline). Member States may decide to supplement these with criteria/elements listed in the GES Decision, for example in cases where those have been absent from the WFD assessment (e.g. coastal fish).

»» Elements

The GES Decision defines the assessment criteria for Descriptor 5 at a high level of specification. This means that, in some cases (e.g. D5C2 chlorophyll *a*, D5C4 photic limit, D5C5 oxygen), the criterion coincides with the assessment element. The choice of elements and the application of criteria (or (sub)regional indicators) are closely linked and this section gives guidance to both aspects.

The choice of elements is made through (sub)regional cooperation, fitting the specific characteristics of the area in question. In coastal waters, the elements are to be consistent with those chosen for WFD reporting and may be supplemented with others. The enumeration list of elements based on Member States' reporting in 2018 can be used as a general reference for Member States to develop and agree lists of assessment elements in (sub)regional cooperation.

Regional lists of eutrophication indicators and associated elements can be found for the following regional seas:

- the Baltic Sea developed by → [HELCOM](#)³⁶
- the North-East Atlantic developed by → [OSPAR](#)³⁷
- the Mediterranean Sea developed by → [UNEP/MAP-MED POL](#)³⁸
- the Black Sea developed by → [BSC](#)³⁹

The primary criteria are to be included in the assessment. Certain criteria elements may be excluded if a risk assessment proves that they are redundant.

The decision on the application of secondary criteria for D5 is taken through (sub)regional cooperation to complement primary criteria or when the marine environment is at risk of not achieving or maintaining good environmental status for that criterion (→ section 2.2.1). Specific element lists (e.g. species to be included in the assessment of harmful algal blooms) are not explicitly

³⁶ Cf. Indicators included in last holistic assessment 2017, <http://stateofthebalticsea.helcom.fi/pressures-and-their-status/eutrophication/#indicators-included-in-the-assessment>

³⁷ Cf. Common Procedure 2013 (agreement 2013-08), <https://www.ospar.org/documents?d=32957>; indicators included in the intermediate assessment 2017, <https://oap.ospar.org/en/ospar-assessments/intermediate-assessment-2017/pressures-human-activities/eutrophication/>

³⁸ Cf. Indicators included in last Quality Status Report 2017, <https://www.medqsr.org/land-and-sea-based-pollution>

³⁹ Cf. also Anemone Project, <http://anemoneproject.eu/wp-content/uploads/2021/09/deliverables/Deliverable%201.3.pdf>

required by the GES Decision, but should also be agreed at (sub)regional level if the need arose. Elements of secondary criteria may be excluded from the assessment if they have been deemed ecologically irrelevant for the subregion or if a cause-effect relationship to pressures is not shown. For the same reason, the GES Decision allows to exclude the primary criterion 'dissolved oxygen' from the assessment provided that it is substituted by an element representing the (secondary) macrozoobenthos criterion that does show a cause-effect relationship to eutrophication pressures.

Secondary criteria may also be excluded from the assessments of coastal waters if they have not been considered under the WFD. For each of the elements, some commonly identified issues are described and guidance for their assessment is provided.

Guidance for D5C1

D5C1 comprises the nutrient parameters Dissolved Inorganic Nitrogen (DIN), Total Nitrogen (TN), Dissolved Inorganic Phosphorus (DIP), and Total Phosphorus (TP) in the water column.

In regions with colder conditions (Baltic Sea and most regions of the North-East Atlantic), wintertime DIN and DIP concentrations are not affected by uptake of algae/macrophytes and are very suitable for assessments. TN and TP are useful assessment parameters, not only in areas where primary production continues outside the main growing season, as they include all forms of the elements N and P, but also for other areas and reasons. They can be used to explain long-term nutrient enrichment in certain areas, caused by transboundary transport and are a prerequisite to calculate nutrient budgets. They can be helpful to deduce reference conditions throughout estuarine and coastal waters because for rivers TN and TP data are usually available, either measured or modelled. With increasing climate change, TN and TP might prove to be the more robust assessment parameters since winter nutrient concentrations may decrease when phytoplankton productivity continues throughout warmer winters.

In the EU MSFD CIS process, more discussion on the role of the total nutrients (TN, TP) in assessing eutrophication effects is still required and more concrete guidance needs to be developed.

Guidance for D5C2

D5C2 relates to the element chlorophyll *a* in the water column, or an alternative indicator of phytoplankton biomass.

The abundance of phytoplankton in the water column is regarded as a direct result of nutrient enhancement; yet it is affected by a number of processes. Physical factors such as turbidity, depth, vertical and horizontal mixing and stratification, and biological factors such as algal species composition, zooplankton grazing and competition with other primary producers have an impact on phytoplankton production, growth, and mortality. Also, the nutrient ratio may influence the composition of the phytoplankton community and the abundance of certain phytoplankton groups. Due to these many interacting factors, the response of phytoplankton to changes in nutrient input is complex and system-specific and might not lead to shifts in phytoplankton production.

Chlorophyll *a* concentration is the most applied phytoplankton indicator, but also phytoplankton biomass is used. Both function as a proxy of phytoplankton (carbon) biomass – though chlorophyll *a* actually measures the pigment abundance and is thus susceptible to variation within the phytoplankton community. Traditionally, phytoplankton is measured *in situ*, either from discrete water samples analysed in the laboratory or by estimates made from continuous fluorescence observations from fixed stations/buoys or on ships. Estimates can be made also from satellite-based Earth Observations, which can provide more information to take better account of spatial and temporal variation. In the future, it is expected to see data quality control tools facilitating the combined use of different monitoring platforms, as well as modelled phytoplankton products applied

for assessment purposes. When applying different measurement approaches and platforms, the limited comparability of different sampling and analytical techniques must be considered in some way.

Guidance for D5C3

D5C3 relates to the number, extent and duration of events of Harmful Algal Blooms (HAB) in the water column. HAB relate to e.g. cyanobacteria as mentioned in the GES Decision, and other algae such as e.g. certain dinoflagellates. In addition to biomass, species composition and abundance of HAB can be assessed. HAB species, the elements of D5C3, should be defined through (sub)regional cooperation.

HAB species can be toxic or nuisance algae. Several approaches have been developed to assess this criterion, ranging from simple cell counts of selected toxic or nuisance species to complex indices using biomass such as the cyanobacterial bloom index that is assessed in the Baltic Sea. While for some regions clear relationships between nutrient composition and the occurrence of HAB can be demonstrated (e.g. cyanobacteria in the Baltic Sea), this is not the case for other regions and D5C3 is not always a useful criterion to diagnose eutrophication. Through its impact on bathing water quality, this is one of the D5 criteria that can be easily linked to ecosystem services; nevertheless, it should be applied only when a relationship to eutrophication related pressures has been established.

Guidance for D5C4

D5C4 relates to the photic limit of the water column. In the context of D5C4, the term 'photic limit' means the same as 'transparency' or 'Secchi depth'.

Photic limit is indirectly related to eutrophication and is an important parameter reflecting the light regime and thereby the structure of primary production and the associated habitats. For macrophytes and benthic algae, light attenuation determines the depth limit and hence the area of the seafloor with vegetation. For pelagic ecosystems, light attenuation regulates the growth of phytoplankton at or below the pycnocline. As a result, it controls whether oxygen production can take place below the pycnocline, i.e. whether the water masses are susceptible to low oxygen conditions. Light limitation, estimated by photic limit or Secchi depth, is dependent on suspended particulate matter, water depths, humic substances and chlorophyll *a*. In eutrophic areas, photic limit is reduced due to accumulation of organic matter, both as dissolved substances and organic particles, and in bloom situations, directly related to the pigments in phytoplankton. D5C4 is not a suitable criterion for the assessment of eutrophication in areas with naturally turbid waters or areas with naturally high contents of humic substances in the water column unless this is shown to be related to eutrophication. As a visible component of water quality, this is one of the D5 criteria most easily linked to ecosystem services.

Guidance for D5C5

D5C5 relates to dissolved oxygen in the bottom of the water column.

Oxygen deficiency is most often the element used to assess the criterion on dissolved oxygen. Where extreme bottom oxygen depletion (anoxia) occurs, hydrogen sulphide concentrations should be observed. The latter can be considered as 'negative concentrations' of oxygen as they must be fully oxidised before oxygen concentrations can exceed zero. Oxygen deficiency is induced by decaying algal blooms and long-term nutrient and associated organic matter enrichment. It is in particular observed in areas susceptible to eutrophication effects, e.g. in sedimentation areas, in waters where the stratification lies close to the bottom or occurs permanently, in areas with long residence time, little or infrequent water exchange by wind-induced mixing or currents (e.g. the deep basins in the Baltic Sea), but also in (shallow) waters covered with surface algal 'blooms' of increased abundance

and biomass, including of nuisance algal species. Although oxygen depletion is often an indirect effect of nutrient enrichment, other pressures may complicate the identification of causal links between nutrient enrichment and oxygen deficiency. Factors that influence oxygen concentrations include changes in water temperature and salinity and are thus highly susceptible to climate change. Seasonal oxygen depletion can be a natural localised process, particularly in deep basins where oxygen deficiency can even be permanent, but also in shallow areas where the water column stratifies seasonally. Sufficient near-bottom oxygen concentrations are a pre-requisite for healthy and abundant zoobenthic communities, and the threshold levels should encompass the requirements of these communities. This probably requires paying attention to the risk, duration and frequency of hypoxia in addition to the oxygen concentration. Bottom oxygen conditions are very much dependent on the hydrographical characteristics of the area. The natural oxygen levels and tendency to natural oxygen depletion must always be considered when setting thresholds. Besides oxygen concentrations, it is recommended also to consider oxygen saturation, or salinity/temperature-normalised oxygen. These parameters better characterise the amount of oxygen available for benthic organisms under an existing salinity and temperature regime, or in some cases, better reflect the eutrophication-related changes in oxygen concentration.

Despite having over 100 years of dissolved oxygen observations with a consistent and accurate analysis method, assessing oxygen deficiency is challenging due to the high variability of oxygen conditions in space and time, requiring high frequency measurements and a spatially explicit assessment approach. *In situ* measurements are often insufficient in space or time and could be complemented by automated measuring devices and/or modelling. Approaches to assess oxygen deficiency are dependent on data availability and region or subregion-specific characteristics, and include for instance oxygen concentrations, oxygen saturation, the volume and spatial extent of the oxygen-depleted water mass or oxygen debt at a permanently stratified bottom layer. Where high-frequency data are available, the frequency and/or duration of hypoxia would be an ecologically relevant indicator.

Guidance for D5C6

D5C6 relates to opportunistic macroalgae of benthic habitats.

The assessment of the biomass of specific opportunistic macroalgae has been applied by some Member States in their coastal WFD reporting. To take it into broader use in shallow open-sea areas, species should be defined at (sub)regional level.

Guidance for D5C7

D5C7 relates to macrophyte communities (perennial seaweeds and seagrasses such as fucoids, eelgrass and Neptune grass) of benthic habitats.

The criterion is confined to nearshore coastal waters, or shallow offshore areas. It should describe species composition and relative abundance or depth distribution of macrophyte communities. Shifts in species (from long-lived species like eelgrass to nuisance short-lived species like opportunistic macroalgae) form an important area-specific indicator/assessment parameter in shallow waters, estuaries and embayments, and have been used by some Member States in their coastal WFD reporting. To take the criterion into broader use in shallow open-sea areas, species should be defined at (sub)regional level. It should be applied only when a relationship to eutrophication-related pressure has been established.

Guidance for D5C8

D5C8 relates to macrofaunal communities of benthic habitats. The element should describe species composition and relative abundance of macrofaunal communities.

The criterion is indirectly related to nutrient enrichment. A distinction can be made between acute kills directly related to oxygen deficiency and/or toxic blooms, and long-term changes in zoobenthos. However, the latter can also be caused by other factors such as fisheries (bottom trawling), which may have an overriding effect compared with eutrophication effects. Therefore, it is often difficult to relate changes in macrozoobenthos community composition directly to eutrophication; using this criterion as a substitute for D5C5 needs to be carefully considered. Still, macrofauna is recommended to be used as secondary criterion if so agreed at (sub)regional level. Macrofauna biomass could be a promising eutrophication-related indicator in this respect.

»» Assessment areas and scales

The GES Decision indicates the following spatial scales for assessment:

- Coastal waters: the water bodies as used under the WFD, aggregated into larger units (e.g. water types) if deemed appropriate. Particularly, using the water bodies of the WFD will facilitate the re-use of information from the WFD.
- Beyond coastal waters, subdivisions of the region or subregion, agreed in the marine region. The assessment areas may be divided, where needed, by national boundaries.

It is recommended to use the same assessment areas across all D5 criteria where possible (rather than considering different criteria at different scales). When delineating assessment areas beyond coastal waters, this should be based on considerations of hydrodynamics and ecosystem characteristics, such as seasonal patterns of phytoplankton biomass or productivity, as well as issues such as monitoring design, assessment of direct and indirect effects of nutrient enrichment in the sea, and links with nutrient inputs and sources. Areas that are too small are not efficient for monitoring and assessment purposes, and areas that are too large may disguise local problems. The consideration of salinity regimes from the river outflows to offshore areas helps to identify and quantify cause-effect relationships and to determine assessment scales. The size of geographic and ecologically relevant assessment areas is expected to increase from smaller inshore waters to bigger offshore areas.

The assessment areas for D5 criteria should be compatible with those used for other criteria and elements, especially under state-based Descriptors. This compatibility may be achieved through a hierarchically defined nested system, defined preferably at the regional level (→ section 2.2.3).

Temporal aspects of assessment

The six-year period for the assessment due for reporting in 2024 should be 2016–2021 and should be applied uniformly within and across marine regions. If this is not feasible, e.g. due to a mismatch between reporting periods of WFD and MSFD, differences in assessment periods may occur. For assessment period, trend assessment and change of status see → section 2.2.5 and 2.4.

In addition, use as long time-series as possible for trend assessments to help understand changes and to interpret assessment results and get an early warning on deteriorating conditions.

It is also recommended to standardise the temporal aspects per criterion/indicator, such as the exact definition of growing season or winter months, at regional or subregional level. Ecological and climate-related gradients should be taken into account when doing so – in some cases standardised

temporal definitions will not be achievable without compromising the ecological relevance of the criterion/indicator, thus requiring area-specific adjustments.

»» Spatial aggregation of assessment

Marine areas should be divided into ecologically relevant assessment areas, agreed at regional level. Coastal areas may be divided into water bodies as determined by the WFD. For coastal waters, aggregation of water bodies to water types may be appropriate to decrease the reporting burden and to avoid double reporting. Where this is done, suitable aggregation rules need to be defined to arrive at an assessment at the water type level, and such aggregation should not lead to a decrease in the ambition level. Where boundaries between WFD water bodies coincide with national boundaries, assessments should strive for consistent WFD threshold values across these national boundaries and allow plausible gradients into adjacent offshore areas as far as possible.

Linking regional assessments to national reporting is addressed in → section 2.4. The status of open sea areas shared by several Member States may be reported by all those Member States. This acknowledges that eutrophication is a shared problem across national boundaries and that transboundary nutrient transports contribute to eutrophication problems. Such reporting implies that anthropogenic eutrophication can only be remediated by common efforts of all countries sharing an assessment area.

An estimate of the extent of the area that is not subject to eutrophication needs to be reported. This estimate should be expressed for each area assessed as the spatial proportion of the area over which the threshold value is achieved for each criterion, and which is not subject to eutrophication (i.e. area in good status), in relation to the area as a whole. In addition, there is also the possibility to carry out a spatially more differentiated assessment within an assessment area (e.g. by using a gridded approach in particular for indicators with satellite monitoring), as long as the possible natural spatial variation in relation to threshold values is taken into account. If this was done, regionally agreed aggregation rules should be applied to reach an assessment result per individual assessment area. A spatially explicit assessment using a gridded approach can aid in identifying eutrophication hotspots and deciding upon suitable management measures.

»» Threshold values

Thresholds are to be agreed through regional or subregional cooperation for each assessment area (area-specific threshold values). This approach reflects the fact that the European seas and areas within the marine regions have different characteristics and a different susceptibility to eutrophication; in coastal waters, thresholds have to be consistent with those implemented under the WFD (some of which are defined in the Commission Decision (EU) 2018/229).

Threshold values are set to reflect a level where the impact of anthropogenic pressure has not led to significant eutrophication effects, preferably in relation to reference conditions. They should be set on the basis of the precautionary principle, reflecting the potential risks to the marine environment, aiming to distinguish between desirable and undesirable level or concentration.

Thresholds have in practice been set either by defining the level between good and non-good status directly, or through an acceptable deviation from the reference conditions. In addition to agreeing on reference conditions, it is also crucial to define the acceptable deviation from the reference conditions – both should be derived on a scientific basis and specifically adapted for each assessment area and indicator.

Thresholds are to be defined starting at the lowest appropriate aggregation level (parameters, elements, or criteria). The approaches for establishing thresholds may be defined, for example, in relation to a point in time where eutrophication levels still were not significant, in relation to unaffected reference sites, or through relationships to other eutrophication-related elements/indicators or processes. Methods such as data mining, ecological modelling or expert evaluation may be applied.

In coastal waters, the applied threshold values need to be in accordance with those determined under the WFD. Furthermore, it is important that coastal threshold values are consistent with threshold values used for adjacent open waters, so that the gradient of threshold values that follows the salinity gradient is plausible. This is relevant for all areas where eutrophication is predominantly caused by riverine nutrient inputs. Additional nationally or regionally agreed thresholds may be applied in coastal waters, where a need for supporting indicators/criteria is identified to fully capture changes in eutrophication and/or better relate the assessments of coastal and open sea assessment areas. Harmonisation of coastal and beyond-coastal threshold values is important from a management perspective so that the achievement of good ecological status under the WFD in coastal waters constitutes the basis for achieving good environmental status under the MSFD beyond coastal waters. Beyond coastal waters, values consistent with those for coastal waters under WFD should be established as described above.

»» Use of criteria

All criteria used are integrated per assessment area to a judgement on status of eutrophication for Descriptor 5. The integration rules need to be agreed at the regional level, as local conditions may change the relative importance of different elements, criteria, or groups.

- Beyond coastal waters, the integration should follow the approach described below; assessment tools such as HEAT (Baltic Sea), TRIX/BEAST (Black Sea), COMPEAT (OSPAR) and TRIX/NEAT (Mediterranean) may be used.
- For coastal waters, the integration is in accordance with the assessment of ecological status under the WFD or follows the approach beyond coastal waters.

Figure 4.2-1 provides an illustration of how elements/indicators, criteria and criteria groups are integrated to assess eutrophication. Four levels are identified:

- Level 1: elements
- Level 2: criteria
- Level 3 (optional and to be agreed at regional sea level): criteria groups
- Level 4: integrated assessment of eutrophication

The primary (obligatory) criteria and their elements are shown in full colour, whereas the secondary (optional) criteria and their elements in light colour. The dotted line instructing the grouping of criteria D5C4, D5C6 and D5C7 indicates that these criteria should be grouped according to their causal reference (direct vs. indirect effect of eutrophication) in the specific region / subregion.

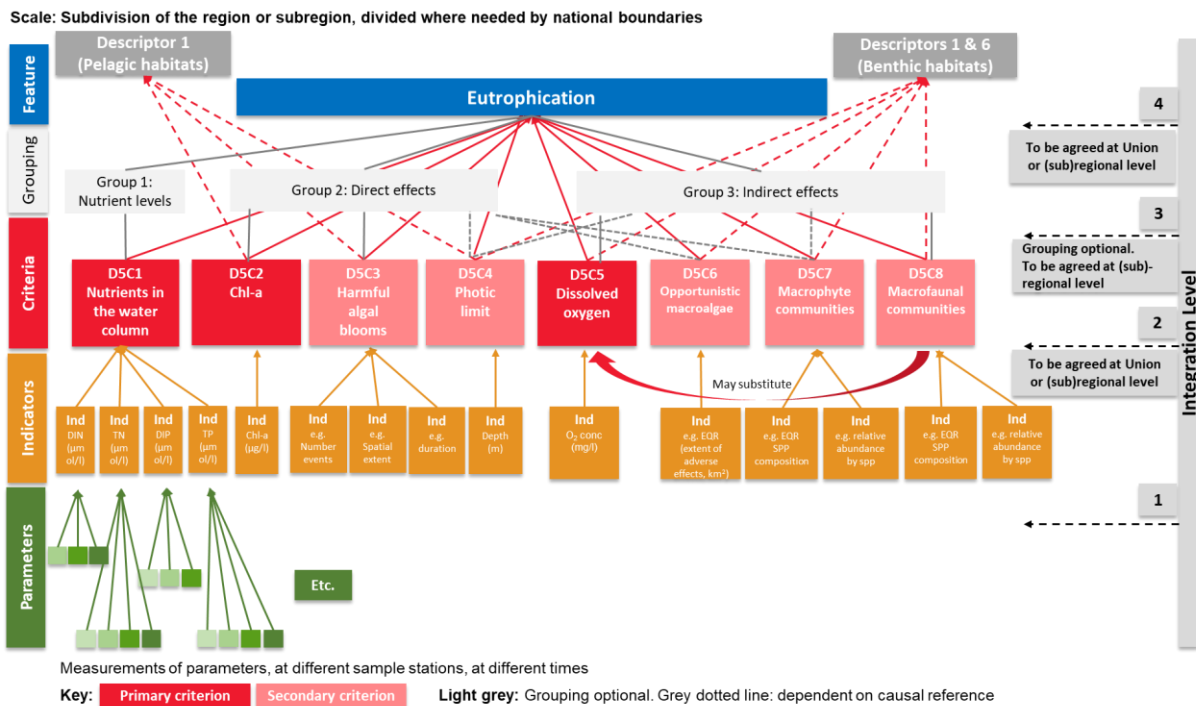

Figure 4.2-1: Use of D5 criteria and levels of integration. Integration to criteria groups is optional.

Eutrophication assessment beyond coastal waters

The assessment of eutrophication should follow a common conceptual framework across the European seas, considering well-established cause-effect relationships. This framework distinguishes nutrient inputs and concentrations as the causative factors for eutrophication, and direct and indirect eutrophication effects as the ecosystem response. The criteria of the GES Decision for eutrophication should be grouped into these three categories and the categories should be assessed separately in a first step and integrated into an overall assessment in a second step. The different integration steps are carried out using weighted averaging or the ‘one-out all-out’ principle adapted to region-specific needs and agreed integration rules. Further discussion is needed on aligning integration rules across European seas to enhance comparability of eutrophication assessments and management. In particular, the role of criterion D5C1 in the overall assessment is handled differently in the marine regions.

Work on integration procedures and tools has been undertaken in the marine regions by HELCOM (2015) for → [HEAT](#), by OSPAR (2022) for → [COMPEAT](#), by BSC (2017) for → [BEAST](#) and by UNEP/MAP-MED POL (2022) for → [TRIX/NEAT](#) (not endorsed by all Contracting Parties so far).⁴⁰

Eutrophication assessment in coastal waters

According to the WFD, the ecological status assessment in coastal waters is based on biological quality components, supporting physico-chemical parameters and river-basin specific pollutants. According to the MSFD, the assessment of eutrophication should include the first two components but not the pollutants. The criteria D5C1 (nutrients), D5C4 (photic limit) and D5C5 (dissolved oxygen) have a supporting role in the WFD but are listed as primary (D5C1 and D5C5) or secondary (D5C4) criteria in the MSFD, giving them a more prominent role. It is therefore recommended to apply the same assessment rules in coastal waters as set beyond coastal waters. However, where differences

⁴⁰ Manual for HEAT is under review for 2024, adoption and publication of manual for OSPAR COMPEAT is expected in July 2022, publication of manual for MED POL NEAT is expected soon.

arise in the coastal waters between the assessment of ecological status according to the WFD and the assessment of eutrophication according to the MSFD, they must be carefully analysed to provide consistent signals for the management.

Assessing eutrophication effects on pelagic and benthic habitats

The GES Decision stipulates that the outcomes of the assessment of eutrophication should also contribute to the assessments of pelagic habitats under Descriptor 1 (→ section 5.6) by determining ‘the distribution and an estimate of the extent of the area as a proportion (percentage) that is subject to eutrophication in the water column (as indicated by whether the threshold values for criteria D5C2, D5C3 and D5C4, when used, have been achieved)’. A quantitative assessment approach (e.g. weighted averaging of the three criteria) would allow to conclude whether the eutrophication pressure has a significant effect on the condition of pelagic habitats. Guidance on how to achieve this is still to be developed.

Concerning benthic habitats, the GES Decision stipulates that the outcomes of the assessments of eutrophication should also contribute to the assessments of benthic habitats under Descriptors 1 and 6 (→ section 5.7 on ‘Use of criteria’) by determining ‘the distribution and an estimate of the extent of the area as a proportion (percentage) that is subject to eutrophication on the seabed (as indicated by whether the threshold values for criteria D5C4, D5C5, D5C6, D5C7 and D5C8, when used, have been achieved)’. It is recommended that a quantitative assessment approach is applied to conclude whether the eutrophication pressure has a significant effect on the condition of benthic habitats. The assessment approach should consider the causal relationships between D5C4, D5C6 and D5C7 (light-limitation of macrophytes) as well as between D5C5 and D5C8 (effects of oxygen deficiency on macrozoobenthos).

The respective assessment approaches for eutrophication effects on pelagic and benthic habitats should be determined at the regional or subregional level.

»» Confidence

It is important to express confidence in the status assessment, as assessment results and associated uncertainty provide a basis for decision making and management, e.g. for setting environmental targets under Article 10 MSFD following the precautionary principle and related to environmental change. The confidence assessment is also useful when evaluating the sufficiency of monitoring programmes under Article 11 MSFD.

The confidence assessment should be conducted at least at the criteria level and for the integrated assessment of Descriptor 5 (→ section 2.2.8). The assessment should take into account the temporal and spatial confidence and should also consider accuracy aspects related to the probability of classifications and uncertainty of the underlying observations. These confidence aspects should be assessed quantitatively and consider the specific data types required to evaluate the elements/indicators. In addition, the confidence of the assessment methodology and of the threshold values could also be assessed. The aspect of temporal coverage of monitoring data considers the confidence of the criterion in terms of its year-to-year variation and the frequency and continuity of observations during the criterion-specific assessment seasons (winter, growing season). The aspect of spatial confidence considers the spatial coverage and representability of the assessment data within the assessment area. It can be based on a gridded approach. The accuracy of the criterion result indicates how certain the assessment is in relation to the variability of the data. The accuracy aspect of the confidence assessment can be considered by calculating variable confidence level per indicator/criterion to estimate the probability or certainty of the classification

of being below or above the area-specific threshold value (depending on the response of the indicator/criterion to eutrophication). The different confidence aspects used in the assessment can be combined by averaging or weighing to arrive at an overall confidence result divided into different confidence classes, such as 'low', 'moderate' and 'high'.

The result of the confidence assessment should be expressed aside from the status assessment rather than embedded into the status. When using the latter approach, follow the precautionary principle: low confidence should not be applied as motivation for downweighing the effect of elements / indicators in the status assessment.

Some Regional Sea Conventions have undertaken work on confidence assessments and included confidence in their assessment tools (HEAT, COMPEAT, BEAST, TRIX/NEAT).

» Visualising assessment results

For the eutrophication assessment, at least the assessment result of each criterion as well as for the overall eutrophication status should be expressed for each assessment area. If criteria are combined to criteria groups, their individual status should also be expressed. Additionally, the evaluation of each element / indicator may be expressed. The presentation of assessment results should express, in a table format, the threshold value, the evaluation value and the status (in relation to the threshold value). Additional information on short- and long-term trend assessments can also be included. Table 4.2-1 is an example for a simplified overview presentation of assessment results per criterion and assessment area in relation to the proportion of national waters to which the assessment results apply.

Table 4.2-1: Illustration for presenting assessment results. Status of area A2 (colour) depends on integration rule used. Status: red – not good; green – good; grey – unknown; white – not assessed.

Assessment area	% national waters	Nutrients	Direct effects					Indirect effects		Status area
		D5C1	D5C2	D5C3	D5C4	D5C6	D5C7	D5C5	D5C8	
A1	23 %	Red	Red	Green	Green	Grey	Grey	Red	Grey	Red
A2	4 %	Red	Green	Grey	White	Grey	Grey	Green	Grey	Colour
Ax										

The confidence assessment should be expressed in connection with the status assessment (in table format and/or maps according to the different confidence classes). In addition, information linking the assessment to e.g. risk and pressure assessments is recommendable.

The information on status assessment results should be provided as maps, where deemed useful. The maps should show whether the threshold has been met. Additional sub-classes may be expressed as well.

Express temporal change of the status of criteria, criteria groups (if relevant) and overall eutrophication, as well as for elements / indicators if deemed appropriate. This should be done at least in relation to the previous eutrophication assessment period. Preferably, present also the results of longer time series or trends.

For each Member State, the percentage of marine waters achieving threshold value / in good status, calculated as described above (→subsection 'Spatial aggregation of assessment'), should be expressed, in addition to the assessment area percentages described in the same sub-section above.

»» Gaps in knowledge and outstanding issues

Gaps in knowledge

- **Harmonise threshold values between criteria and criteria elements:** In general, the assessment of eutrophication based on the criteria of the GES Decision is well established and there are only a few knowledge gaps. Concerning future work, it is necessary to harmonise the threshold values between criteria or criteria elements. While pressure-response relationships between D5C1, D5C2 and D5C4 are mostly well established and the threshold values well aligned, this is often not yet the case for the other eutrophication criteria/elements. For instance, ensuring that the threshold value for D5C4 is aligned with the threshold value of D5C7 is challenging but necessary, since light limitation influences the depth limit of macrophyte communities. Equally, it needs to be ensured that the threshold values established for D5C5 permit achieving the threshold values for D5C8.
- **Develop a better understanding of eutrophication effects on biodiversity:** This is required in relation to the different trophic levels of the food web and the pelagic and benthic communities. Separate eutrophication effects from other human pressures on biodiversity to allow effective management. The condition of pelagic habitats (D1C6) is influenced by eutrophication. However, separating eutrophication effects from effects of climate change or changes in the food web is proving difficult. Furthermore, the effect of changes in the species composition and food web, including possible top-down control, on eutrophication is not yet fully understood.
- **Improve use of monitoring techniques complementing *in situ* measurements:** Satellite and ferrybox data are already routinely used for the assessment of D5C2 and routines are being developed to combine such data with *in situ* data. In the future, the assessment of eutrophication may incorporate data from automated high-frequency measurements and modelling, thereby increasing the confidence of the assessment. Suitable routines need to be developed for combining data from such different sources.
- **Link with climate change:** Future eutrophication assessments need to take into account the impacts of climate change, e.g. by understanding the changes on the marine ecosystem and establishing threshold values that remain achievable in a changing climate.

Outstanding issues

Close identified guidance gaps including:

- Clarify integration rules to be used for integrating WFD assessment results into MSFD eutrophication assessments in coastal waters.
- Further harmonise assessment approaches and integration rules across European seas in general, and the use of criterion D5C1 in the overall assessment as well as issues of consistency of assessments within and across national boundaries in particular.
- Clarify methods for a quantitative assessment of criteria D5C2, D5C3 and D5C4 to contribute to the assessments of pelagic habitats under D1C6.

4.3 Descriptor 7: Hydrographical changes

Descriptor 7: Permanent alteration of hydrographical conditions does not adversely affect marine ecosystems. (MSFD Annex I)

DESCRIPTOR PROFILE		D7C1	D7C2
Feature		Hydrographical changes to the seabed and water column	Benthic broad habitat types and other habitat types
Primary criterion			
Information type		Pressure	Impact
Annex III MSFD	State (Table 1)		
	Pressure (Table 2a)	Physical loss (due to permanent change of seabed substrate or morphology and to extraction of seabed substrate); Changes to hydrographical conditions	Physical loss (due to permanent change of seabed substrate or morphology and to extraction of seabed substrate); Changes to hydrographical conditions
	Activity (Table 2b)	Physical restructuring of rivers, coastline or seabed; Extraction of non-living resources; production of energy; Extraction of living resources; Cultivation of living resources; Tourism and leisure; Transport – shipping; Transport – infrastructure	
GES Decision	Elements		GES Decision
	Threshold values		(sub)regional
	Use of criteria	GES Decision	GES Decision
Criteria linkages		D7C2, D6C1	D7C1, D6C5
Descriptor linkages		D6	D1/D6

The development of an assessment framework for hydrographical changes was not a priority in MSFD implementation at national, EU and regional level in the past MSFD cycle. Guidance given in this section reflects mostly the guidance developed back in 2017 with few updates. Specific guidance is still to be developed. In the following the term ‘hydrographical’ is used consistently including in relation to MSFD Annex III.

»» Elements

The GES Decision does not require to determine elements for D7C1 and D7C2. The element of D7C1 is ‘hydrographical changes to the seabed and water column (including intertidal areas)’, which are associated with human activities. Such activities include all offshore structures affecting hydrographical conditions, including those with small footprint on the seabed (anchoring mechanisms). Other possible sources of hydrographical changes may be cables and pipelines, or other anthropogenic activities, in so far as they contribute to the risk of habitat types failing to be in good status. The GES Decision sets out, in line with Commission Directive (EU) 2017/845 amending Annex III to the MSFD, possible parameters to assess hydrographical conditions and associated changes in conjunction with human activities and pressures, such as change in wave and current regimes, salinity and temperature. The wider ecosystem parameters and impacts of climate change, e.g. temperature, current, storminess and acidification changes are not subject to assessments of hydrographical changes (→ section 3.1.3).

The elements of D7C2 follow those of the benthic broad habitat types (BHT) and other habitat types (OHT) which are to be determined as assessment elements under D1/D6 (→ section 5.7). BHT are defined through GES Decision, OHT are agreed by Member States through (sub)regional cooperation.

The habitat types to be addressed under D7C2 are those which are at risk of failing to be in good status and for which permanent alteration of hydrographical conditions is considered to make a significant contribution to this risk.

»» Assessment areas and scales

The GES Decision indicates the use of scales used for assessments of the benthic broad habitat types under Descriptors 1 and 6 (→ section 5.7). The scales to address D7C1 and D7C2 must be adequate to assess any changes in the benthic broad habitat type or other habitat types as used in D1 and D6. In case of transboundary impacts, a regional collaboration should be established to enforce a consistent assessment and reporting. Specific guidance on scales for D7C1 and D7C2 is still to be developed.

»» Temporal aspects of assessment

The six-year period for the assessment due for reporting in 2024 should be 2016–2021 and should be applied uniformly within and across marine regions. For assessment period, trend assessment and change of status see → section 2.2.5 and 2.4.

To be consistent with D6C1, the assessment should consider any relevant hydrographical changes that have been lasting or are going to last more than 12 years.

Guidance on temporal aspects of D7 assessments is still to be developed.

»» Spatial aggregation of assessment

Guidance on spatial aggregation of D7 assessments is still to be developed.

»» Threshold values

D7C1 assessments provide technical information for use in D7C2. The GES Decision does not require a threshold value and status assessment.

D7C2 assessments provide technical information for use in D6C5. The GES Decision does not require a status assessment. Threshold values need to be established to define when permanent alterations of hydrographical conditions generate adverse effects on a benthic habitat.

»» Use of criteria

The parameters assessed under D7C1 are combined to express the spatial extent (km²) and distribution of permanent alteration of hydrographical conditions to the seabed and water column. The information from D6C1 needs to be complemented only with information from other pressures (e.g. changes in near-field and far-field hydrographical conditions as a result of uses or human activities such as renewable energy installations, oil and gas installations, coastal defence structures etc.) compared to those considered under D6C1.

Combination takes place through appropriate methods such as combining spatial data layers for different types of pressure causing hydrographical changes, including loss of natural seabed (D6C1). Spatial overlaps of different pressures should be accounted for (no double-counting). The output should be the extent of the assessment area subjected to changes in hydrographical conditions. The output should be used for the assessment of criterion D7C2.

The spatial extent to which each habitat type is adversely affected (physical and hydrographical characteristics and associated biological communities) by changes to hydrographical conditions are

not combined; the results remain specific for each habitat type and contribute to the status assessment of habitats under D6C5 (→ section 5.7).

No further integration steps are envisaged for D7C1 and D7C2.

Figure 4.3-1 illustrates the use of the criteria and levels of integration. More specific guidance on the use of D7C1 and D7C2 is still to be developed.

Scale: As used for benthic broad habitat types under Descriptors 1 and 6

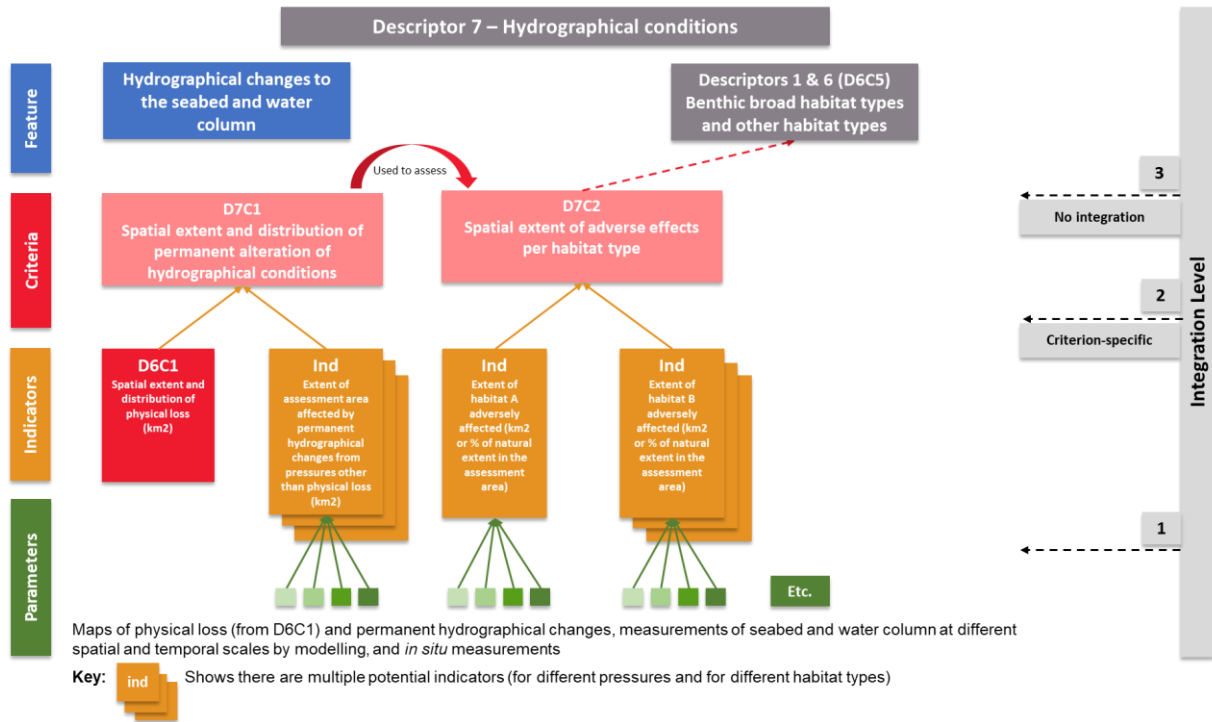

Figure 4.3-1: Use of D7 criteria and level of integration.

»» Confidence

Guidance on confidence aspects of D7 assessments is still to be developed.

»» Visualising assessment results

Results can be presented in maps to show spatial extent and distribution of permanent alterations of hydrographical conditions to the seabed and water column (D7C1). This will allow intersecting the results with benthic habitat maps to determine the spatial extent and distribution of individual benthic habitat types adversely affected by hydrographical changes (D7C2).

D7C1 and D7C2 do not require status assessments.

More guidance is still to be developed.

»» Gaps in knowledge and outstanding issues

Outstanding issues

- Develop a common understanding of the use of D7 criteria in status assessment and associated guidance for an assessment framework and close identified guidance gaps: A coherent assessment of D7C1 and D7C2 requires more specific guidance on all aspects set out in this section to develop a common understanding and use of these criteria in status assessments.

Clarification on their role is needed to follow up on potentially increasing offshore pressures e.g. from other EU and national policies including on alternative energy generation (expansion of offshore wind farms) and blue economy objectives. It is timely to start working on an assessment framework for D7 to accompany major infrastructure developments and mitigate their impacts on hydrographical conditions in the period up to 2030.

- Methodological standards for linking WFD assessments with D7 assessments under MSFD (e.g. related to scales of assessment) may also require further guidance.
- For need of clarification on the links of D7 and climate change see → chapter 3.

4.4 Descriptor 8: Contaminants in the environment

Descriptor 8: Concentrations of contaminants are at levels not giving rise to pollution effects. (MSFD Annex I)

DESCRIPTOR PROFILE		D8C1 Concentration of contaminants	D8C2 Contaminant effects	D8C3 Acute pollution events	D8C4 Effects of acute pollution
Feature		Contaminants – uPBT substances; Contaminants – non-uPBT substances	Species; Habitats	Acute pollution events	Species; Habitats
Primary criterion		X		X	
Information type		Pressure	Impact	Pressure	Impact
Annex III MSFD	State (Table 1)	Ecosystems/food webs; Habitats	Species; Habitats	Chemical characteristics; Ecosystems/food webs; Species; Habitats	Species; Habitats
	Pressure (Table 2a)	Input of hazardous substances (synthetic substances, non-synthetic substances, radionuclides) from diffuse sources, point sources, atmospheric deposition, acute events			
	Activity (Table 2b)	Extraction of oil and gas, including infrastructure; Marine aquaculture, including infrastructure ; Transport — infrastructure ; Transport — shipping ; Urban and industrial uses ; Military operations (subject to Article 2(2))		Extraction of oil and gas, including infrastructure; Transport — infrastructure ; Transport — shipping	
GES Decision	Elements	EU, (sub)regional	EU, (sub)regional	EU	EU
	Threshold values	EU, (sub)regional	(sub)regional		(sub)regional
	Use of criteria		(sub)regional		(sub)regional
Criteria linkages		D9C1*	D6C5	D8C4	D8C3
Descriptor linkages		D9	D1, D6		D1, D6

*Not included in the GES Decision

»» Elements

The elements are defined in the GES Decision for D8C1. Further commonly agreed aspects and guidance are provided below for each criterion.

Guidance for D8C1

The elements for assessment (contaminants) differ between coastal/territorial waters and areas beyond territorial waters, taking into account the following:

- The complementary role of the MSFD in coastal waters (Article 3(1)(b) MSFD), i.e. MSFD covers those aspects not already addressed through WFD or other Community legislation

- Agreed procedures under the WFD⁴¹ to select and monitor contaminants for assessment, taking into account transboundary aspects
- Agreed procedures in marine regions for a risk-based approach to selecting and monitoring contaminants for assessment, taking into account transboundary aspects
- The geographical scope of WFD and MSFD, which overlaps in coastal waters (1 nm) and territorial waters (12 nm)
- Agreed procedures under MSFD to select and monitor contaminants beyond territorial waters⁴²

As a minimum standard, the assessment elements cover the contaminants selected in accordance with WFD: priority substances⁴³ and River Basin Specific Pollutants (RBSP)⁴⁴. Additional contaminants which may give rise to pollution effects can be selected by Member States through (sub)regional cooperation. Use a risk assessment to identify these additional contaminants.

The resulting lists of contaminants should be treated individually or as groups, as agreed at Union level. The current lists of priority contaminants in each marine region are provided in Table 4.4-1. Please, note that there is ongoing work to update the lists, which currently overlap with WFD priority substances to some degree.

According to the GES Decision, contaminants refer to single substances or groups of substances. For consistency and comparability of assessments and reporting, the grouping of substances should be agreed at Union level. However, so far, no common grouping of substances has been agreed upon for many relevant contaminants.

⁴¹ EU WFD CIS Guidance Document No. 7: [https://circabc.europa.eu/sd/a/63f7715f-0f45-4955-b7cb-58ca305e42a8/Guidance%20No%207%20-%20Monitoring%20\(WG%202.7\).pdf](https://circabc.europa.eu/sd/a/63f7715f-0f45-4955-b7cb-58ca305e42a8/Guidance%20No%207%20-%20Monitoring%20(WG%202.7).pdf); EU WGD CIS Guidance Document No. 25: <https://circabc.europa.eu/sd/a/7f47ccd9-ce47-4f4a-b4f0-cc61db518b1c/Guidance%20No%2025%20-%20Chemical%20Monitoring%20of%20Sediment%20and%20Biota.pdf>

⁴² Tornero et al., 2021a: <https://doi.org/10.2760/839892>

⁴³ Contaminants for which an environmental quality standard (EQS) is laid down in part A of Annex I of Directive 2008/105/EC (the Priority Substances Directive)

⁴⁴ River Basin Specific Pollutants are considered as part of ecological status under the WFD. They are substances of national or local concern that are selected by Member States for control at the relevant level (<http://ec.europa.eu/environment/water/water-dangersub/>). Identified as 'Pollution by other substances identified as being discharged in significant quantities into the body of water' under 'Chemical and physico-chemical elements' of ecological status in Annex V of the WFD.

Table 4.4-1 : Agreed lists of priority contaminants and assessment indicators for D8C1 in each marine region (status February 2022)

Marine Region	Baltic Sea	North-East Atlantic	Mediterranean Sea	Black Sea
Contaminants of priority	Seawater, sediments, biota (depending on contaminant): HELCOM core indicators ⁴⁵ : Metals (lead, cadmium, mercury, copper) PAHs PFOS HBCDD PBDEs PCBs, dioxins, furans TBT Cesium-137	Seawater, sediments, biota (depending on contaminant): OSPAR common indicators ⁴⁶ : Metals (lead, cadmium, mercury) PAHs PBDEs PCBs TBT	Biota and Sediments: UNEP/MAP indicators ⁴⁷ : Metals (lead, mercury, cadmium) PCBs HCB Lindane DDTs PAHs	Seawater, sediments, biota: BSC indicators ⁴⁸ : Metals (lead, cadmium) Organochlorinated pesticides (lindane, aldrin, dieldrin, HCB, DDTs, Heptachlor) PCBs PAHs

Guidance for D8C2

While MSFD criterion D8C1 regards concentrations of chemical substances in different marine matrices, criterion D8C2 includes provisions for the assessment of the effects of contaminants on the health of species and the condition of habitats. According to the GES Decision, Member States should establish those adverse effects through (sub)regional cooperation. Member States should also establish through (sub)regional cooperation a list of species (and relevant tissues for assessment) and habitats which are at risk of adverse effects from contaminants, including cumulative and synergistic effects. Table 4.4-2 provides an overview of currently agreed elements for D8C2 assessments in each marine region.

Table 4.4-2 : Agreed elements for monitoring and assessment of D8C2 in each marine region (status February 2022) (for references to indicators see footnotes to Table 4.4-1)

Marine region	Baltic Sea	North-East Atlantic	Mediterranean Sea	Black Sea
Agreed elements	HELCOM core indicators: Imposex White-tailed eagle productivity	OSPAR common indicators: Imposex	UNEP/MAP indicators: In marine bivalves (such as <i>Mytilus galloprovincialis</i>) and/or fish (such as <i>Mullus barbatus</i>): Lysosomal Membrane Stability (LMS), Acetylcholinesterase (AChE), Micronucleus assay/DNA damage. Only bivalves: Metallothionein. Only in fish: Ethoxyresorufin-O-deethylase (EROD)	Black Sea indicators

⁴⁵ <https://helcom.fi/baltic-sea-trends/indicators/>

⁴⁶ <https://www.ospar.org/work-areas/cross-cutting-issues/ospar-common-indicators>

⁴⁷ IMAP Guidance Factsheets: Update for Common Indicators 13, 14, 17, 18, 20 and 21; New proposal for Candidate Indicators 26 and 27 (UNEP/MED WG.467/5); <https://www.medqsr.org/land-and-sea-based-pollution>

⁴⁸ BSC, 2017: https://ec.europa.eu/environment/marine/international-cooperation/regional-sea-conventions/bucharest/pdf/BSIMAP_2017_to_2022_en.pdf

Guidance for D8C3

The elements for assessment are significant acute pollution events involving polluting substances⁴⁹, including oil and noxious liquid substances. The spatial extent and duration of such events needs to be monitored. The pollution events that should be defined as ‘significant’, including both guidance on reporting for D8C3 e.g. spill types, metrics and units, as well as triggers for D8C4 monitoring and assessment, is still under discussion⁵⁰ and guidance still needs to be developed.

Guidance for D8C4

D8C3 should be used to trigger assessment of criterion D8C4 which requires ‘the adverse effects of significant acute pollution events on the health of species and on the condition of habitats are minimised and, where possible, eliminated’. The species and habitat types assessed under Descriptors 1 and 6 are relevant elements for assessment of D8C4. A common approach on the scope of D8C4 impact monitoring is still under discussion⁵¹ and guidance still needs to be developed.

»» Assessment areas and scales

The general assessment scales are defined in the GES Decision as set out below and are specified through regional cooperation. Further, commonly agreed aspects and guidance on assessment scales and areas are provided below for each criterion:

For D8C1 and D8C2

- Within coastal and territorial waters: as used under WFD. This implies the use of WFD water bodies in coastal waters, and other polygons if defined for territorial waters, and will facilitate the re-use of information from WFD. Note that for good ecological status, WFD requires Member States to define water bodies for assessment (i.e. assessment areas) within 1 nm. Other polygons for coastal or territorial waters can also be considered for other marine matrices (biota or sediment) attending to the real spatial representativity of each specific sample. These alternative polygons can be used considering several of the water bodies or polygons proposed by WFD.
- Beyond territorial waters: subdivisions of the region or subregion, divided where needed by national boundaries.

For D8C3

Region or subregion, divided where needed by national boundaries.

For D8C4

The same assessment scales and areas as used for the species groups or benthic broad habitat types under Descriptors 1 and 6.

The scales for assessment take into account the different approaches of Member States to monitoring beyond 1 nm and/or 12 nm, such as offshore monitoring, modelling, or extrapolation of WFD results from within 1 nm and/or 12 nm to larger areas.

⁴⁹ ‘Polluting substances’ are defined in Article 2(2) of Directive 2005/35/EC of the European Parliament and of the Council as the substances covered by Annexes I (oil) and II (noxious liquid substances in bulk) to MARPOL 73/78.

⁵⁰ Cf. GES_24-2021-10_D8: Discussion paper acute pollution under development, <https://circabc.europa.eu/ui/group/326ae5ac-0419-4167-83ca-e3c210534a69/library/14f8e009-66c1-4791-86bd-c2c1e47ee989/details>

⁵¹ Ibidem

»» Temporal aspects of assessment

The six-year period for the assessment due for reporting in 2024 should be 2016–2021 and should be applied uniformly within and across marine regions. If this is not feasible, e.g. due to a mismatch between reporting periods of WFD and MSFD, differences in assessment periods may occur. For assessment period, trend assessment and change of status see → section 2.2.5 and 2.4.

There are currently no commonly agreed temporal aspects of assessment.

»» Spatial aggregation of assessment

There is currently no commonly agreed spatial aggregation of assessment.

»» Threshold values

Threshold values are partly defined in the GES Decision for D8C1. Further commonly agreed aspects and guidance are provided below for each criterion.

Guidance for D8C1

Within coastal and territorial waters:

- For WFD contaminants, the values set in accordance with WFD, should be used, i.e.:
 - the environmental quality standards (EQS) for WFD priority substances, noting that they use environmental or human health as protective goals. The use of EQS based on human health may be in conflict with assessments under D9. Further guidance is still to be developed.
 - the national values set by Member States for RBSPs. National threshold values used for 2018 reporting are summarised in JRC's review of Member States' reports.⁵²
- When a WFD priority substance or RBSP is measured in a matrix for which no value is set under WFD, threshold values for the concentrations in that matrix should be set through (sub)regional cooperation. Technical guidance documents developed under the WFD⁵³ can be used for this purpose, although interpretations and hence implementation of these documents currently differ among Member States. Efforts are ongoing to ensure a harmonised approach for threshold value setting.
- For (sub)regionally selected additional contaminants, threshold values for the concentrations in the specified matrix (water, sediment, or biota) should be established through (sub)regional cooperation⁵⁴.

Beyond territorial waters:

- For WFD contaminants and additional contaminants within coastal and territorial waters, values should be used as applicable within those waters.
- For WFD contaminants for which no threshold values have been set under WFD for the matrix (sediment, biota) relevant offshore, the values should be used that are already established through (sub)regional cooperation.

⁵² Tornero et al., 2021b: <http://dx.doi.org/10.2760/621757>

⁵³ EU WFD CIS Guidance Document No. 27: <https://data.europa.eu/doi/10.2875/018826>; EU WFD/CIS Guidance Document No. 38: https://circabc.europa.eu/ui/group/9ab5926d-bed4-4322-9aa7-9964bbe8312d/library/9276554c-b76f-4bd2-b229-01539115eced?p=1&n=10&sort=modified_DESC

⁵⁴ Cf. for HELCOM indicators: <https://helcom.fi/baltic-sea-trends/indicators/>; for OSPAR indicators: <https://www.ospar.org/work-areas/cross-cutting-issues/ospar-common-indicators>

- For additional contaminants, threshold values for concentrations in the specified matrix (water, sediment or biota), should be established through (sub)regional cooperation. For improved consistency, the matrices used for monitoring under WFD should be aligned with MSFD where appropriate, taking into account the purpose of monitoring. Threshold-setting may take into consideration existing thresholds already developed at regional level, such as Ecological Assessment Criteria (EAC) and Background Assessment Concentrations (BAC).

Ensure that threshold values allow coherent and consistent assessments of freshwater and marine environment and that WFD approaches are scientifically applicable to marine waters.

Guidance for D8C2

Threshold values for adverse effects (including cumulative and synergistic effects) on the health of species and the condition of habitats (e.g. species composition and their relative abundance at locations of chronic pollution) should be set by Member States through (sub)regional cooperation. There are currently some regionally adopted threshold values available⁵⁵, but they are not consistently used by Member States⁵⁶.

Guidance for D8C3

No threshold values are required. However, in the Baltic Sea region, there is an agreed threshold value for oil spills from ships⁵⁷.

Guidance for D8C4

No threshold values are required.

»» Use of criteria

The GES Decision describes in general terms the use of the criteria for the assessment of good environmental status and requires the details to be agreed at (sub)regional level. An integration across the criteria is not required by the GES Decision. Figure 4.4-1 illustrates the use of D8 criteria and the levels of integration.

There are currently no commonly agreed rules for integrating the results per parameter or criterion. Most (but not all) Member States use the 'one-out all-out' (OOAO) rule for assessments of D8C1. There are alternative approaches to the OOAO rule. For example, OSPAR and HELCOM use the CHASE tool, which enables a more mathematical assessment, without loosening the precautionary principle. For D8C2 and D8C3/C4 integration rules are so far generally not applied⁵⁸. Guidance needs still to be developed.

⁵⁵ Davies and Vethaak, 2012: <https://doi.org/10.17895/ices.pub.5403>

⁵⁶ Tornero et al., 2021b: <http://dx.doi.org/10.2760/621757>

⁵⁷ Cf. HELCOM common indicator on oil spills affecting the marine environment, <https://helcom.fi/wp-content/uploads/2019/08/Operational-oil-spills-from-ships-HELCOM-core-indicator-2018.pdf>

⁵⁸ Tornero et al., 2021b: <http://dx.doi.org/10.2760/621757>

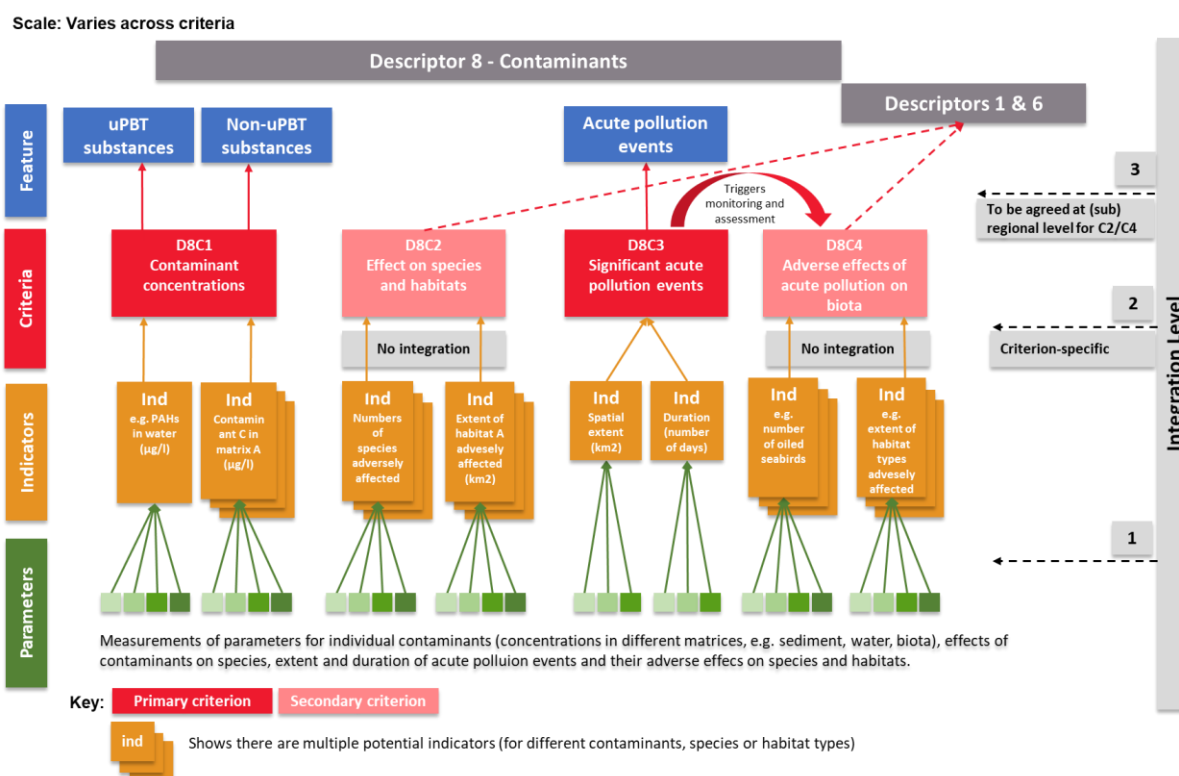

Figure 4.4-1: Use of D8 criteria and levels of integration.

»» Confidence

There are no commonly agreed methods to assess confidence. However, regionally applied tools for integrated assessments of hazardous substance do include confidence assessments. In the Baltic Sea, the HELCOM Hazardous Substances Assessment Tool (CHASE) integrates results from the individual HELCOM indicators and includes confidence assessments⁵⁹. In the North-East Atlantic, the OSPAR Quality Status Report 2023 will include confidence assessments based on data/numbers and/or statistical methods applied at indicator level, using the OSPAR Hazardous Substances Assessment Tool (OHAT)⁶⁰. In the Mediterranean Sea, the UNEP/MAP-MED POL Quality Status Report 2023 will include statistical methods applied on some of the common indicators (e.g. in the Eutrophication Assessment Tool (NEAT) for GES assessment).⁶¹

»» Visualising assessment results

Guidance on the presentation of assessment results still needs to be developed. Options for discussion regarding D8C1 include:

- Graphic presentation of proportion of contaminants meeting their threshold values, failing their threshold values, and not being assessed or with status unknown

⁵⁹ HELCOM, 2021: <https://helcom.fi/wp-content/uploads/2021/01/BSEP175.pdf>

⁶⁰ OSPAR agreement 2019-02: <https://www.ospar.org/documents?v=40951>; OHAT: <https://github.com/ices-taf/OHAT>

⁶¹ UNEP/MAP-MED POL, 2016: <https://wedocs.unep.org/handle/20.500.11822/10576>

- Tables of assessment results (threshold values met, failed; unknown) per contaminant, matrix, and assessment areas (<1 nm, <12 nm, > 12 nm, summary status national waters) as well as summary status for D8C1

»» Gaps in knowledge and outstanding issues

Many relevant gaps and outstanding issues are highlighted in the JRC review of 2018 reporting, which require further guidance as summarised below⁶². There is a need for harmonisation i.e. regarding the way results are integrated and presented, with regard to groups of substances and spatially.

For D8C1

- Improved identification of marine-relevant contaminants for assessment under MSFD
- Improved coverage of radionuclides and consistency across marine regions and with assessments carried out under EURATOM
- Comparable grouping of individual substances for reporting assessments
- Consistent application of available WFD EQS values, improved comparability of threshold values used across Member States and marine regions and with WFD, and closing of gaps in threshold values for substance/matrix combinations. This includes clarification how to deal with WFD assessments that are based on human health threshold values and are therefore not consistent with the purpose of D8.
- Linking WFD assessment areas and results with MSFD assessments
- Rules on combining individual assessment results and on the use of criteria to express whether and to which extent GES is achieved or not (integration rules)

For D8C2

- More efforts to establish a harmonised approach to monitor biological effects as well as guidance on the application of biological effect methods in integrated assessments of contaminants

For D8C3 and D8C4

- EU-wide understanding of 'significant' pollution events (including spill type, metrics, and units) as a basis for reporting events under MSFD D8C3 and of triggers for D8C4 monitoring and assessment
- Potential synergies across policy frameworks on spill data collection and management, and reporting (there is ongoing work in this regard)
- EU-wide understanding of how D8C3 and D8C4 should be used in the overall D8 assessment, ensuring that spills of oil (and other chemicals) and their effects are considered in a holistic GES assessment

⁶² Tornero, V. et al., 2021b: <http://dx.doi.org/10.2760/621757>

4.5 Descriptor 9: Contaminants in seafood

Descriptor 9: Contaminants in fish and other seafood for human consumption do not exceed levels established by Union legislation or other relevant standards. (MSFD Annex I)

DESCRIPTOR PROFILE		D9C1
Feature		Contaminants in seafood
Primary criterion		X
Information type		Pressure
Annex III MSFD	State (Table 1)	Ecosystems/food webs; Species; Habitats
	Pressure (Table 2a)	Input of hazardous substances (synthetic substances, non-synthetic substances, radionuclides) from diffuse sources, point sources, atmospheric deposition, acute events
	Activity (Table 2b)	Extraction of oil and gas, including infrastructure; Extraction of minerals (rock, metal ores, gravel, sand, shell); Aquaculture – marine, including infrastructure; Transport – infrastructure; Transport – shipping; Urban and industrial uses; Military operations (subject to Article 2(2))
GES Decision	Elements	GES Decision
	Threshold values	Regulation (EC) No. 1881/2006; (sub)regional
	Use of criteria	
Criteria linkages		D8C1*
Descriptor linkages		D1

* Not included in the GES Decision

»» Elements

The GES Decision defines the contaminants listed in Regulation (EC) No. 1881/2006 setting maximum levels for certain contaminants in foodstuffs as the elements for assessment under Descriptor 9. These contaminants are lead, cadmium, mercury, dioxins and PCBs, and PAHs. The regulation of additional contaminants under Regulation (EC) No. 1881/2006 is under discussion.⁶³

Secondary elements are the species for which concentrations are measured in edible tissues (muscle, liver, roe, flesh or other soft parts, as appropriate) of seafood. Species link to unprocessed seafood of fish, crustaceans, molluscs, echinoderms, seaweed and other marine plants caught or harvested in the wild (excluding finfish from mariculture). Unprocessed seafood means that e.g. PAHs in smoked seafood are not covered by D9C1.

Member States may decide not to consider contaminants from Regulation (EC) No. 1881/2006 for the purpose of MSFD assessment. The GES Decision requires that Member States justify their decision based on a risk-assessment. Guidance on requirements for providing such justification still needs to be developed.

Member States may assess additional contaminants that are not included in Regulation (EC) No. 1881/2006. They should establish a list of those contaminants as well as the list of species and relevant tissues to be assessed through (sub)regional cooperation in accordance with the specifications of the GES Decision. When establishing the list of species to be used under D9C1, the species should:

⁶³ Examples include PFAs, Brominated Flame Retardants (PBDE, HBCDD, tetrabromobisphenol-A, brominated phenols), chlorinated paraffins, polychlorinated naphthalenes, review of dioxins and dioxin-like PCBs

- be relevant to the marine region or subregion concerned
- fall under the scope of Regulation (EC) No. 1881/2006
- be suitable for the contaminant being assessed
- be among the most consumed in the Member State or the most caught or harvested for consumption

As D9 focuses on popular and commonly eaten species, these can have a local profile and do not necessarily represent a good coverage of the (sub)region. Including such species in assessments may make comparable assessments across marine (sub)regions challenging. It is therefore advisable to focus on a limited number of target species from the most consumed species and to ensure traceability of the catching or harvesting location (→ [SWD\(2020\)61 final](#)). Further guidance on developing list of species through (sub)regional cooperation is still to be developed.

»» Assessment areas and scales

The GES Decision sets out the scale of assessment as the catch or production area in accordance with Article 38 of Regulation (EU) No. 1379/2013 on the common organisation of the markets in fishery and aquaculture products. The catch or production area is the ‘sub-area of division listed in the FAO fishing areas’ as set out under the following links:

- North-East Atlantic and Baltic Sea (Area 27): <https://www.fao.org/fishery/en/area/Area27/en>
- Mediterranean and Black Sea (Area 37): <https://www.fao.org/fishery/en/area/Area37/en>

The main challenge is that the area of origin is currently not a mandatory field in reporting food safety data. Samples are therefore difficult to trace within the broad FAO areas 27 and 37, making it difficult to relate samples to the assessment area or even to smaller national marine reporting units. The required precision of traceability is under discussion and guidance still needs to be developed.

»» Temporal aspects of assessment

The six-year period for the assessment due for reporting in 2024 should be 2016–2021 and should be applied uniformly within and across marine regions. For assessment period, trend assessment and change of status see → section 2.2.5 and 2.4. Guidance on temporal aspects of D9 assessments is still to be developed as needed.

»» Spatial aggregation of assessment

Guidance on spatial aggregation of D9 assessments is still to be developed as needed.

»» Threshold values

The GES Decision requires to use the maximum levels laid down in Regulation (EC) No. 1881/2006 as threshold values for those contaminants listed in this Regulation. For additional contaminants Member States are required to establish threshold values through (sub)regional cooperation. The lack of agreed threshold values is one of the main reasons adduced by Member States for not providing GES assessments for substances other than those regulated under Food Safety Regulation.

»» Use of criteria

The assessment of contaminants in seafood is based on one criterion only (D9C1).

Measurements of individual elements (i.e. substance) in the relevant species and matrix (tissue) are compared to the contaminant-species-matrix-specific threshold value. For example, concentrations of mercury in the muscle tissue of different species of fish, concentrations of dioxins and PCBs in fish liver, are combined to produce information on levels of contaminants in different tissues of different species of seafood, which can be assessed against the maximum permitted levels under Regulation (EC) No. 1881/2006, or threshold values for additional contaminants agreed through (sub)regional cooperation.

According to the GES Decision, the results for the various contaminants and matrices are not integrated. They are presented individually and as a proportion of contaminants assessed achieving the threshold values.

At parameter level, the ‘one out all out’ (OOAO) approach may result in a ‘not good’ status for a contaminant with a single exceedance over several tens or even hundreds of measurements. While this can be regarded as a precautionary principle, it does not seem applicable to a long-term management policy since it does not reflect the reality of food safety status. Therefore, it is needed to work towards an agreed range of acceptance or ‘tolerance threshold’ (percentage exceedances of regulatory limits) at EU level.

Figure 4.5-1 illustrates the levels of assessment and integration for D9. Further guidance is still to be developed.

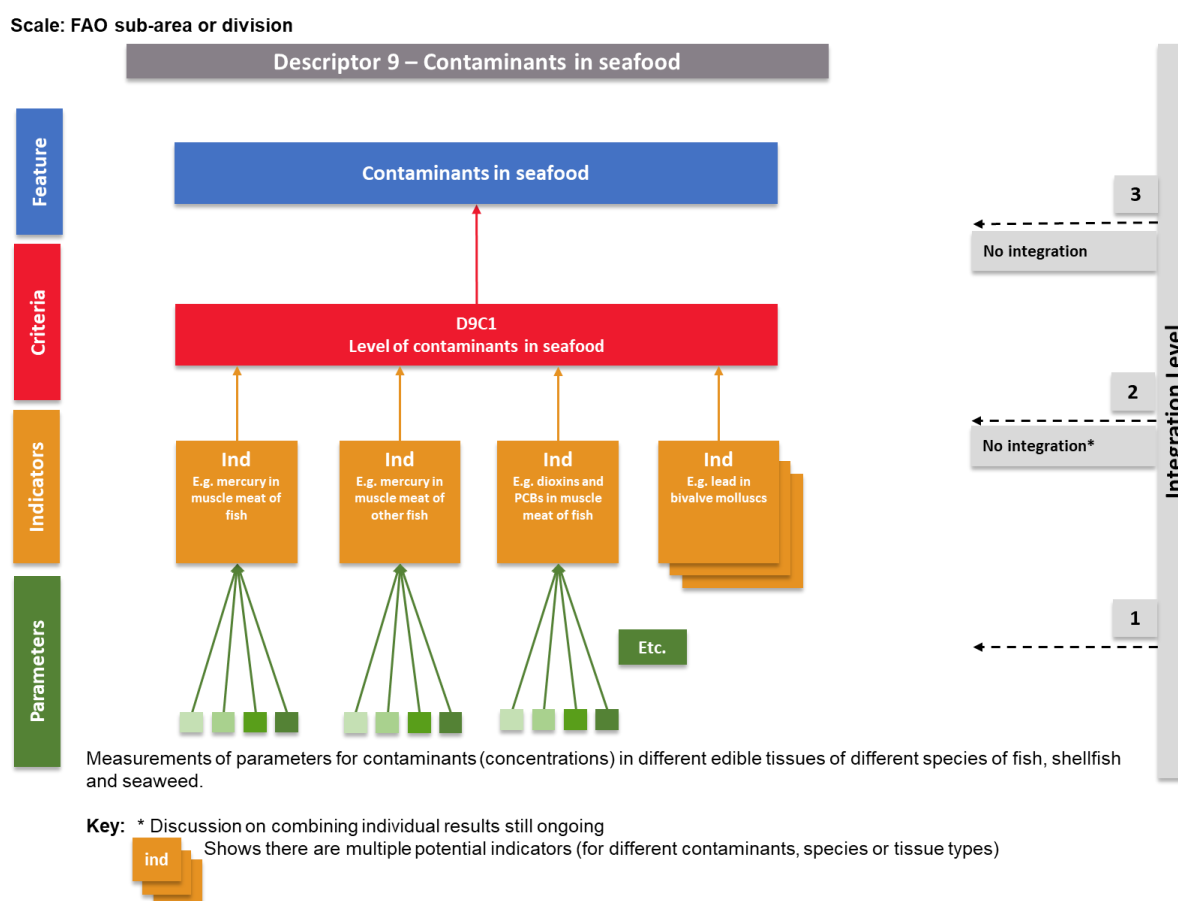

Figure 4.5-1: Levels of assessment and integration for D9.

» Confidence

Guidance on temporal aspects of D9 assessments is still to be developed.

» Visualising assessment results

The assessment output for D9 is expressed for each assessment area for each contaminant as a percentage of the contaminants meeting their threshold values, failing the value, and not being assessed or with status unknown. Further guidance is still to be developed.

» Gaps in knowledge and outstanding issues

The CIS process identified a number of issues that require further discussion and ultimately guidance to enhance comparable approaches of Member States across marine regions in assessing and reporting contaminant levels in seafood and the extent to which good environmental status is achieved for contaminants in seafood. Starting points for outstanding issues are among others:

- JRC/MSFD Expert Network on Contaminants Discussion paper 'Approaches to implement MSFD D9' (→ [GES_22-2019-11](#) and updates)⁶⁴
- Meeting Summary 'Joint meeting of Member States' Food Safety and Marine Environmental Authorities' (→ [GES_24-2021-11](#))⁶⁵
- JRC review of EU Member States' 2018 reports for updating Articles 8, 9 and 10 of the MSFD⁶⁶

There is a need for continued communication and information exchange between Food Safety and Environmental Authorities at national and EU level to advance coordination of Food Regulation and MSFD requirements, with the aim to enable use of food stuff data for environmental purposes. The following issues are outstanding and require further discussion and guidance in the CIS process:

- Identified guidance gaps
- Traceability of the catching or harvesting location or production area of the samples collected under food monitoring programmes
- Representativeness of samples (e.g. by selecting a limited number of target species from most consumed species)
- Assessment of contaminant levels by species (as requested by the GES Decision) or by species groups (most consumed species, predatory species, eels)
- Options for linking D8 monitoring and analysis routines with D9 requirements to yield measurements which can support D9 assessments
- Integration rules for combining individual assessment results

⁶⁴ <https://circabc.europa.eu/ui/group/326ae5ac-0419-4167-83ca-e3c210534a69/library/33c4cc4d-0319-451b-9738-bb0a2bdd24fc/details>; update is not yet available for referencing.

⁶⁵ <https://circabc.europa.eu/ui/group/326ae5ac-0419-4167-83ca-e3c210534a69/library/0b0d347f-5e93-4985-9de6-ea1031e653c4/details>

⁶⁶ Tornero et al., 2021b: <https://doi.org/10.2760/839892>

4.6 Descriptor 10: Marine Litter

Descriptor 10: Properties and quantities of marine litter do not cause harm to the coastal and marine environment. (MSFD Annex I)

DESCRIPTOR PROFILE		D10C1 Litter in the environment	D10C2 Micro-litter in the environment	D10C3 Litter in biota (ingested)	D10C4 Adverse effects on species
Feature		Litter in the environment	Micro-litter in the environment	Litter in biota (ingested)	Adverse effects on species
Primary criterion		X	X		
Information type		Pressure	Pressure	Pressure	Impact
Annex III MSFD	State (Table 1)	Ecosystems/food webs	Ecosystems/food webs	Species	Species
	Pressure (Table 2a)	Input of litter (solid waste matter, including micro-sized litter)			
	Activity (Table 2b)	Urban and industrial uses; Fish and shellfish harvesting; Aquaculture – marine, including infrastructure; Transport – shipping; Tourism and leisure; Production of energy; Extraction of non-living resources; Waste treatment and disposal			
GES Decision	Elements	EU/GES Decision	EU/GES Decision	(sub)regional	(sub)regional
	Threshold values	EU	EU	(sub)regional	(sub)regional
	Use of criteria	EU			
Criteria linkages				D1C2	D1C2, D6C5*
Descriptor linkages				D1	D1, D6*

* Not included in the GES Decision

»» Elements

The elements (litter categories) for assessment of the primary criteria D10C1 and D10C2 and the secondary criterion D10C3 are set out in the GES Decision. Follow Fleet et al. (2021)⁶⁷ which provides detailed descriptions of the elements and the specification of subcategories and litter items covered by these elements. The GES Decision requires their assessment in the compartments coastline, surface layer of the water column, and seabed. The GES Decision requires for

- D10C1 that litter on the coastline is monitored; litter in the surface layer of the water column and on the seabed may additionally be monitored.
- D10C2 that micro-litter is monitored in the surface layer of the water column and in the seabed sediment and may be additionally monitored on the coastline.

Agreement of species for assessing litter in biota under D10C3 and of adverse effects on species under D10C4 takes place through regional cooperation. Follow Galgani et al. (2013)⁶⁸ on further guidance on monitoring and selecting species for assessment under D10C3 and D10C4. When selecting indicator species consider links and synergies with other descriptors.

Guidance for D10C1

The GES Decision sets out the macro-litter categories to be covered as criteria elements in the assessment. They are artificial polymer materials; rubber; cloth/textile; paper/cardboard; processed/worked wood; metal; glass/ceramics; chemicals; food waste; undefined. To allow

⁶⁷ <http://dx.doi.org/10.2760/127473>

⁶⁸ <http://dx.doi.org/10.2788/99475>

tracking the effectiveness of measures under the Single Use Plastics Directive (Directive (EU) 2019/904), additional elements should be added to cover ‘single use plastics’ and ‘fishing gear’, following the definitions of that Directive (cf. EU, 2018⁶⁹; referenced in Fleet et al., 2021).

The EU list of elements, including those added for ‘single use plastics’ and ‘fishing gear’ will be available in the EU reporting → [enumeration list](#). For reporting, the list includes the option to use macro-litter (all) as an element. This allows assessing status and the extent to which GES is achieved in relation to the total amount of macro-litter. For statistical reasons, it is not feasible to define threshold values for each litter category where the number of litter items found is limited. For the individual litter categories (artificial polymer material, single use plastics and fishing gear), trend assessments are recommended, as far as data sets allow for statistical analysis.

Guidance for D10C2

The GES Decision sets out ‘artificial polymer materials’ and ‘other’ as assessment elements for micro-litter (particles <5 mm). For reporting, the EU → [enumeration list](#) includes the option to use micro-litter (all) as an element. This allows assessing status and the extent to which GES is achieved in relation to the total amount of micro-litter. Assessment tools for D10C2 are still under development.

To allow linking up with other policy instruments and tracking the effectiveness of measures, additional elements can be added in future to cover ‘pellets’. Starting point should be the development of standardised monitoring methods.

Guidance for D10C3

The GES Decision requires to assess the amount of litter and micro-litter ingested by species only in relation to the element ‘artificial polymer material’ and ‘other’. Follow Fleet et al. (2021) which provides detailed guidance on the specification of litter sub-categories and items covered by the material category ‘artificial polymer material’. ‘Single use plastic’ as defined by Directive 2019/904 (cf. EU, 2018; referenced in Fleet et al., 2021) should be added as an additional element and will be available in the EU reporting → [enumeration list](#). For future assessments, inclusion of ‘pellets’ as new element should be considered. Threshold-based assessments of status and the extent to which GES is achieved relate to the amount of artificial polymer material ingested by species. This reflects the understanding that ingestion relates to litter floating on or under the seawater surface which consists of more than 95 % plastic. For specific sub-categories (e.g. single use plastic), trend assessments are recommended, as far as data sets allow for a statistical analysis.

Litter and micro-litter should be assessed, where possible, in representative species from the following groups: birds, reptiles, fish, or invertebrates. Fish and invertebrates are particularly relevant species for the assessment of ingested micro-litter. Identification of suitable indicator species is ongoing in all marine regions with first assessment tools available for 2024 in the North-East Atlantic and the Mediterranean Sea (Table 4.6-1).

Table 4.6-1: Availability of regionally agreed indicator species (status February 2022) as assessment elements for D10C3.

Criterion	North-East Atlantic	Baltic Sea	Mediterranean Sea	Black Sea
D10C3	Region II ⁷⁰ : → Fulmar Regions III, IV, V ⁷¹ : Sea turtles (under development)	---	Loggerhead turtle	---

⁷⁰ Greater North Sea; <https://www.sciencedirect.com/science/article/pii/S0025326X21002800>

Guidance for D10C4

For assessing adverse effects, where possible, select species of birds, mammals, reptiles, fish or invertebrates. Select species based on the risk of harm caused by marine litter, e.g. from entanglement, other types of injury, mortality or health effects. There are no regionally agreed indicator species available for assessment (status February 2022).

»» **Assessment areas and scales**

The GES Decision sets out the broad scales for assessment. Based on this, the scales are specified as follows depending on the assessment criterion and environmental compartment:

For D10C1: region or subregion divided by national borders

For D10C2: region or subregion divided by national borders

For D10C3 and D10C4: use the (sub)regionally agreed scales for assessment

For D10C3 the GES Decision sets out to use the subdivisions of the region or subregion, divided where needed by national boundaries. For reporting, use national boundaries when sufficient samples are available for assessment (e.g. > 50 individuals for the North-East Atlantic fulmar indicator) and MSFD (sub)regions if national samples are insufficient.

For D10C4 the GES Decision sets out to use the scales for the assessment of species groups under D1. Assessment areas will depend on areas of risk of impact for the selected species (e.g. entanglement of birds in nesting areas) and may not necessarily coincide with the area of a species' / populations' distribution. Assessment area results will be aggregated to express impact at the scales used for species group assessment under D1.

»» **Temporal aspects of assessment**

The six-year period for the assessment due for reporting in 2024 should be 2016–2021 and should be applied uniformly within and across marine regions. For assessment period, trend assessment and change of status see → section 2.2.5 and 2.4.

Galgani et al. (2013) provides guidance on the frequency of surveys and sampling for D10C1, D10C3 and D10C4. Monitoring guidance for D10C2 will be included in the updated version of MSFD Guidance for Marine Litter.

For the status assessment of litter on the coastline under D10C1, calculate the median of the data from all surveys within a country or a marine subregion, with a recommended minimum of 40 surveys in a three-year period. This means putting all the data from all sites and all years together to calculate the median value (Van Loon et al., 2020). For seafloor litter, the assessment is based on annual surveys; their aggregation follows the approaches set out in the marine regions. For D10C2, no regular sampling applies to date; it is advised to aggregate samples per year. Further guidance on temporal aggregation of data for the various environmental compartments of D10C1 and D10C2 is still to be developed at EU level. If more than one compartment is assessed, it is recommended to consider the same time period for the assessment.

For D10C3 and D10C4, it is recommended to aggregate samples per year or an agreed period of years. Further temporal aggregation rules are agreed or under development at (sub)regional level. For trend assessments, see Schultz et al. (2017) on detailed methodologies for D10C1 and Fleet et al. (2021) for litter categories.

⁷⁰ Greater North Sea; <https://www.sciencedirect.com/science/article/pii/S0025326X21002800>

⁷¹ Celtic seas, Bay of Biscay and Iberian Coast and Wider Atlantic (includes Azores, Portugal)

»» Spatial aggregation of assessment

For the status assessment of litter on the coastline under D10C1, calculate the median of the data from all surveys within a country or a marine subregion, with a recommended minimum of 40 surveys in a three-year period. This means putting all the data from all sites and all years together to calculate the median value (Van Loon et al., 2020).

Spatial aggregation schemes for other environmental compartments of D10C1 as well as for D10C2 are still to be developed at EU level. Spatial aggregation rules for D10C3 and D10C4 apply as agreed or under development at (sub)regional level.

»» Threshold values

The threshold values for D10C1 and D10C2 are to be developed through cooperation at EU level, those for D10C3 and D10C4 through (sub)regional cooperation.

Guidance for D10C1

For litter on the coastline, the threshold value is 20 litter items per 100 m beach length as a median value, which corresponds to the 15th percentile of the EU baseline dataset of the total amount of litter on European coastlines in 2015–2016 (Van Loon et al., 2020; Hanke et al., 2019). The threshold value applies to the total amount of macro-litter on the coastline (macro-litter (all)). Threshold values cannot be defined per litter category as required by the GES Decision, where the number of category items found is limited (e.g. metals, glass, rubber). For macro-litter in the environmental compartments seafloor and water surface, threshold values are still to be developed. In the absence of threshold values for macro-litter (all) on the seafloor and water surface, the assessment should be based on trend analysis to detect the direction of development within a six-year assessment period and between six-year assessment periods, if these compartments are used for assessment (see below on → ‘Use of criteria’ for guidance on how to use trends in the assessment). Trend assessments for the individual categories ‘artificial polymer material’, ‘single use plastics’ and ‘fishing gear’ are recommended for all compartments, to the extent Member States make use of them in the assessment. Follow Schultz et al. (2017) for trend assessment methodologies.

Guidance for D10C2

For micro-litter, threshold values are still to be developed at EU level for all relevant environmental compartments. In the interim, for the compartments which Member States decide to assess, assessment should be based on trend analysis to detect the evolution or tendency of amounts of micro-litter (all) (see below on → ‘Use of criteria’ for guidance on how to use trends in the assessment).

Guidance for D10C3

The threshold values for D10C3 will be developed by Member States through cooperation at (sub)regional level. Assess amounts of ‘artificial polymer material’ in biota (D10C3) against a threshold value. Use trends for amounts of ‘single use plastics’ in biota.

To date, a threshold value is available for the ingested litter in fulmars in the North-East Atlantic: ‘Over a period of at least five consecutive years, no more than 10 % of northern fulmar (*Fulmarus glacialis*) in samples of at least 100 birds may exceed the level of 0.1 g plastic particles in the stomach’ (Van Franeker, 2021). Threshold values for ingested litter in loggerhead turtles in the Mediterranean and sea turtles in Regions III, IV and V of the North-East Atlantic⁷² are under development. In the interim, use trends for the amount of litter ingested by the corresponding sea turtles to indicate the

⁷² Celtic seas, Bay of Biscay and Iberian Coast, and Wider Atlantic (includes Azores, Portugal)

direction of development (see below on → ‘Use of criteria’ for guidance on how to use trends in the assessment).

Guidance for D10C4

Threshold values for D10C4 will be developed by Member States through cooperation at (sub)regional level. Assessment methods for D10C4 are still under development.

»» Use of criteria

The extent to which good environmental status has been achieved or maintained relates to the features macro-litter and micro-litter in the marine environment, litter and micro-litter in biota and marine species. For reporting, the assessment outcomes are expressed for each of the four criteria separately. For this, individual outcomes from each compartment need to be combined. Use the rules as depicted in Figure 4.6-1 and explained here for combining assessment information to assess criteria, element and feature, and finally to express the extent to which good environmental status has been achieved

Guidance for D10C1 and D10C2

For each parameter used (amount on the coastline, in the surface layer of the water column and on the seafloor) for D10C1 and D10C2, use survey data per litter categories concerned over time and space. Combine the litter categories data for macro-litter (all) (D10C1) and micro-litter (all) (D10C2) per compartment used. The parameter outcomes are assessed against threshold values. In the absence of a threshold value, the achievement of the parameter is assessed by trend analysis.

The combination of parameter outcomes for D10C1 and for D10C2 depends on the number of compartments used, i.e. on the extent to which compartments, in addition to those for which GES Decision requires monitoring, are assessed.

For D10C1, some Member States have indicated that they may not use all three compartments in the future. The compartments relate to different pressures and activities and yield different results in terms of amount and categories of litter impacting the marine environment. The more compartments – preferably all three – are assessed, the better and more robust is the understanding of the status of the marine environment in relation to marine litter and the knowledge base for taking measures. To date, there is no agreement on how many and which additional compartments to use for the assessment, and, as a consequence, on rules of integrating compartment results to a statement whether or not good environmental status has been achieved in relation to the feature macro-litter in the marine environment. For comparability and transparency, it is recommended that Member States report in 2024 the achievement (or not) of the chosen parameter and ‘unknown’ for the status at feature and criterion level.

For D10C2, monitoring is still in the development and assessments are not expected for 2024. Like for D10C1, there is no agreement about the use of the three compartments for assessment, and, as a consequence, on rules of integration. For comparability and transparency, it is recommended that Member States report in 2024 the achievement (or not) of the chosen parameters and ‘unknown’ for the status at feature and criterion level”.

Where trends are used and express improvement (decreasing litter pollution), stable level (no change) or trend ‘unknown’ (statistical reasons, e.g. high variability, limited number of items) for litter pollution they do not allow a conclusion on the achievement of a parameter. The achievement of the parameter is considered ‘unknown’. The trend information is provided.

Where trends are used and express increasing litter pollution the parameter is ‘not achieved’, following the MSFD principle of non-deterioration of state.

Guidance for D10C3 and D10C4

For D10C3, use the data on amounts of plastic litter ingested (grams) and the number of individuals affected per species, over time and space, following the rules agreed at (sub)regional level. For D10C4, use the number of individuals affected (e.g. by entanglement) per species, or the number of interactions observed along distance, over time and space, following the rules agreed at (sub)regional level. There is no further integration of parameter results. The parameter results are used for the assessment of the status of the criteria. The criteria status for the indicator species contributes to the assessment of the species/habitat under Descriptor 1.

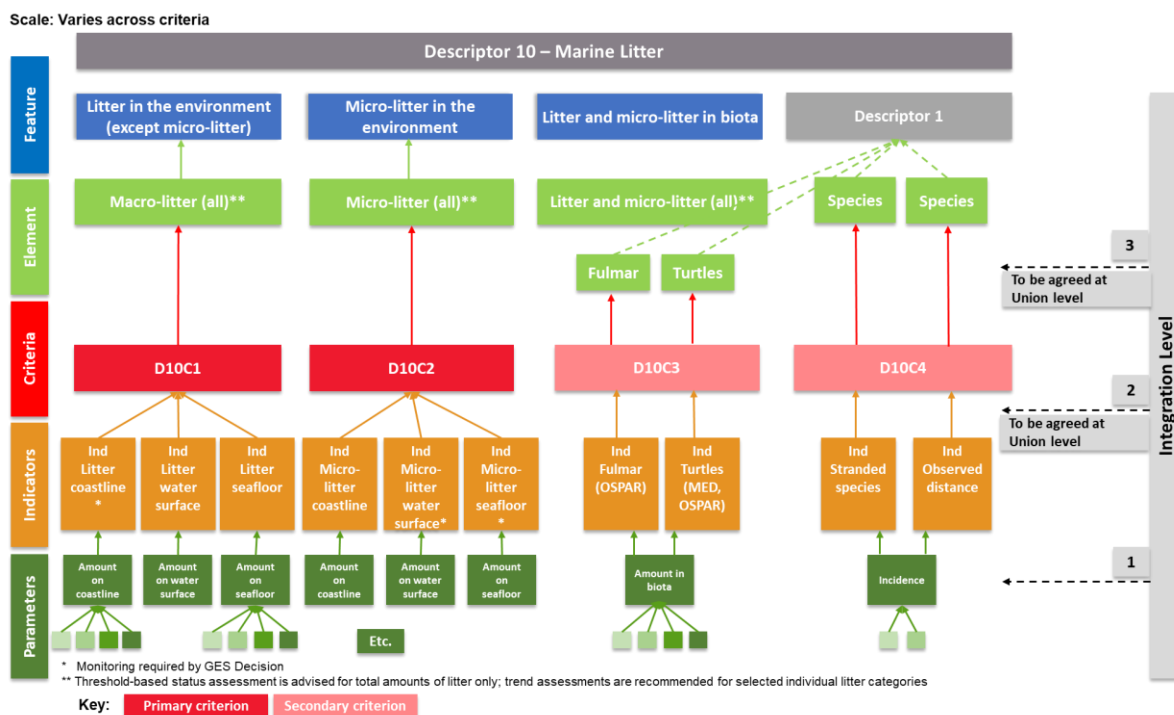

Figure 4.6-1: Levels of assessment and integration. Rules for integration are still to be developed.

»» Confidence

Guidance on confidence statements is still to be developed. Confidence information for the beach litter threshold value is available (Van Loon et al., 2020).

»» Visualising assessment results

The assessment output for Descriptor 10 on marine litter is presented best in a table (see example Table 4.6-2) to allow transparency of assessment results per parameter. In the absence of agreed integration rules, results should be presented in 2024 at parameter level. Complementary assessment information on the development of pollution with specific litter categories is also best presented in a table format (see example Table 4.6-3).

It is recommended that WISE Marine Dashboard displays the assessment results at parameter level.

Table 4.6-2: Example for presenting status assessment output for Descriptor 10. Basis for assessment can be a threshold value (red=not achieved, green=achieved, grey=not assessed (NA)/unknown) or, in the absence of a threshold a trend (improving; deteriorating; no change; not assessed; unknown). (---) no basis of assessment/not assessed.

Criterion	Parameter	Basis of assessment in assessment period		Change in status vs. last assessment
		Current	Last	
D10C1	Amount on coastline*	Threshold	Trend	Unknown
	Amount on seafloor	Trend	---	Not assessed / Unknown**
	Amount on water surface	---	---	Not assessed / Unknown**
D10C2	Amount on coastline	---	---	Not assessed / Unknown**
	Amount on seafloor*	---	---	Unknown
	Amount on water surface*	---	---	Unknown
D10C3	Prevalence above weight limit	Threshold	---	Improving
	Amount in biota (ingested) and type of ingested litter	Threshold	---	Improving
D10C4	Incidence	Trend	---	Unknown
	Sub-lethal / lethal interactions with litter	---	---	Not assessed

* parameters for which GES Decision requires monitoring under D10C1 and D10C2

** unknown / not assessed depends on whether a Member States chooses to assess the parameter or not

Table 4.6-3: Example for presenting complementary assessment information on specific litter categories for D10C1 (trend: improving; deteriorating; no change; not assessed; unknown)

Element	Parameter	Trend within assessment period	Change compared to last assessment period
Artificial polymer materials	Amount on coastline*	Improving	Improving
	Amount on seafloor	Deteriorating	Deteriorating
	Amount on water surface	No change	No change
Single use plastic	Amount on coastline*	Unknown	Unknown
	Amount on seafloor	Not assessed / unknown	Not assessed / unknown
	Amount on water surface	No change	Unknown
Fishing gear	Amount on coastline*	No change	Unknown
	Amount on seafloor	Not assessed / unknown	Not assessed / unknown
	Amount on water surface	Not assessed / unknown	Not assessed / unknown

*parameters for which GES Decision requires monitoring under D10C1

** unknown / not assessed depends on whether a Member States chooses to assess the parameter or not

»» Gaps in knowledge and outstanding issues

Gaps in knowledge

There is a lack of information to quantify pathways of litter to the sea (e.g. riverine inputs), and about the links of litter items found to some of the sources and measures. Relations between the amount of litter and the threat for selected species are often not well defined.

Outstanding issues

- Explore standardised monitoring methods for pellets with a view to allow conclusion on future reporting of pellets as an additional element under D10C2 and D10C3.

- Develop standardised methods for monitoring of floating litter (D10C1) and guidance for use of the compartment in assessments (e.g. relating to transboundary litter pressures).
- Determine the compartments for assessment under D10C1 and D10C2, noting that realistically Member States will not monitor all three compartments in the same robust way.
- Develop integration rules for the assessment of features under D10.
- Define baselines and thresholds for litter in the surface layer of the water column and on the seabed for macro-litter (D10C1) and for the environmental components of D10C2 through EU-level cooperation. Defining threshold values does not pre-empt a decision on the use of compartment. However, if Member States use a compartment, they should do so based on the requirements of the GES Decision for agreed methodological standards.
- Develop assessment methods and threshold values for D10C3 (at present only available for *Fulmar glacialis*), and D10C4 through cooperation at EU or (sub)regional level.
- Explore ways to cover meso-litter through EU-level cooperation.
- Close identified guidance gaps.

4.7 Descriptor 11: Underwater noise

Descriptor 11: Introduction of energy, including underwater noise, is at levels that do not adversely affect the marine environment. (MSFD Annex I)

DESCRIPTOR PROFILE		D11C1 Anthropogenic impulsive sound	D11C2 Anthropogenic continuous low-frequency sound
Features		Impulsive sound in water	Continuous low-frequency sound in water
Primary criterion		X	X
Information type		Pressure	Pressure
Annex III MSFD	State (Table 1)	Species; Habitats	Species; Habitats
	Pressure (Table 2a)	Input of anthropogenic sound	Input of anthropogenic sound
	Activity (Table 2b)	Production of energy; Extraction of living and non-living resources; Military operations (subject to Article 2(2))	Transport – shipping; Production of energy
GES Decision	Elements	GES Decision	GES Decision
	Threshold values	EU	EU
	Use of criteria	EU	EU
Criteria linkages		D1C4, D1C2-D1C5	D1C4, D1C2-D1C5
Descriptor linkages		D1	D1

Note on the scope of this section:

Since 2017 and the adoption of Commission Decision 2017/848, the EU MSFD CIS process has focussed on the assessment of impacts of noise and the development of threshold values in relation to indicators developed in the framework of the MSFD, as described below:

- An → [assessment framework to define EU threshold values for impulsive underwater noise](#) (TG Noise Deliverable 1) was adopted as a guidance by the Marine Strategy Coordination Group (MSCG) on 28 May 2021.⁷³
- An → [assessment framework to define EU threshold values for continuous underwater sound](#) (TG Noise Deliverable 3) was adopted as a guidance by the MSCG on 12 November 2021.⁷⁴
- Based on these recommended methodologies, work is ongoing to deliver options for EU threshold values for impulsive and continuous noise (respectively TG Noise Deliverables 2 and 4). This work is expected to be finalised in 2022, to achieve the objectives set by the → [Zero pollution action plan](#)⁷⁵.

The assessment framework for impulsive noise (TG Noise Deliverable 1) will be updated based on the outcomes of the ongoing project HARMONIZE⁷⁶. This will be addressed in the guidance aiming at proposing threshold values for impulsive noise, planned for adoption by the end of 2022 (TG Noise

⁷³ https://ec.europa.eu/environment/marine/pdf/Doc%201-%20TG%20Noise%20DL1%20-%20AF%20for%20EU%20TV%20for%20impulsive%20noise_2021.pdf

⁷⁴ <https://ec.europa.eu/environment/marine/pdf/Doc%202%20-%20TG%20Noise%20DL3%20-%20AF%20for%20EU%20TV%20for%20continuous%20noise.pdf>

⁷⁵ COM(2021) 400 final: <https://eur-lex.europa.eu/legal-content/EN/TXT/?uri=CELEX%3A52021DC0400&qid=1623311742827>

⁷⁶ https://www.bsh.de/EN/TOPICS/Research_and_development/Current_projects/Harmonize/Harmonize_node.html

Deliverable 2). In that regard, the present guidance is more detailed on the framework for D11C2 (Deliverable 3), which shares similar steps with the available guidance on D11C1 (TG Noise Deliverable 1).

If endorsed by MSCG, Member States are encouraged to make use of the guidances to be published in 2022 (TG Noise Deliverables 2 and 4) in their (sub)regional cooperation on the forthcoming status assessments of impulsive and continuous noise.

»» Overview of assessment framework

The guidance builds on ongoing EU MSFD CIS work to compile existing information for the assessment of underwater noise and develop assessment frameworks for D11C1 (TG Noise Deliverable 1) and D11C2 (TG Noise Deliverable 3) based on the available knowledge. Work divides into development of a methodology for assessment, followed by a methodology for setting of threshold values. The first parts of the Assessment Frameworks for EU threshold values for impulsive and continuous noise are the basis for guidance in this section (hereinafter TG Noise Deliverables 1 and 3).

A sequential approach is proposed for assessing GES. It is not required to implement the approach in a specific order. It is, however, desirable that the reporting is structured according to the sequential approach.

The sequence of the steps of the framework for continuous sound is:

- Step 1. Define indicator species and their habitats
- Step 2. Define the level of onset of biologically significant adverse effects
- Step 3. Determine time periods for the assessment
- Step 4. Assess the acoustic status by monitoring
- Step 5. Establish the reference condition
- Step 6. Establish the current condition
- Step 7. Evaluate the condition of the grid cells
- Step 8. Determine the status of the habitats
- Step 9. Assess the status of the MRU as being GES or not GES.

The last step depends on established threshold values for GES and is not addressed in detail in this guidance. It will be addressed in the guidance aiming at proposing threshold values, planned for adoption by the end of 2022 (TG Noise Deliverables 2 and 4).

The assessment framework for impulsive noise follows common principles that were used to further develop the methodology. This includes e.g. to use the data being collected in the existing impulsive noise registry for determining 'affected areas' and to overlay this information with species distribution information for quantification of potential exposure of marine species to underwater sound. This approach is similar to 'traditional' risk assessment techniques for hazardous substances.

»» Elements

The element of D11C1 is 'anthropogenic impulsive noise in water', which is associated with the populations of marine animals adversely affected.

The element of D11C2 is ‘anthropogenic continuous low-frequency sound in water’, which is associated with the populations of marine animals and habitats adversely affected. As a result, to adhere to the intent of the GES Decision there is a need to develop an indicator, based on adverse effects on individual animals, that relates to the effects on populations. The two one-third octave bands centred on 63 Hz and 125 Hz are assessed.

Adverse effects of underwater noise

Any of the following are examples that may be considered as adverse effects from underwater noise, depending on their magnitude:

- Temporary loss of habitat due to noise: This would not be considered as a loss of range in the context of the Habitats Directive but could affect the population dynamics and would be considered an adverse impact if there is a risk that the conservation status of the population within an assessment area is compromised.
- Effects on population dynamics through habitat degradation due to noise so that there is a risk that the conservation status of the population within an assessment area is compromised.
- Permanent loss of habitat due to noise (i.e. the sound levels within an area are such that the species no longer inhabits that area): This may affect the population dynamics but would also be considered as a loss of range in the context of the Habitats Directive.
- Effects on population dynamics which result in a loss of range (e.g. basin effect or loss of individuals with strong site fidelity): The loss of range may not be in the areas most affected by noise.
- For continuous noise: Masking of the low-frequency communication can happen over large areas; significant behavioral changes may occur.
- For impulsive noise: Individual hearing impairment (auditory threshold shifts) can happen after exposure of impulsive noise that may have consequences for a population.

Use of indicator species and habitats

For impulsive noise, the assessment framework will be updated in the document providing recommendations for options for EU threshold values (TG Noise Deliverable 4), based on the results of the HARMONIZE project. For continuous noise see details in Annexes 2 and 4 of the dedicated assessment framework (TG Noise Deliverable 3) and the following summary:

- The proposed approach to identifying indicator species and habitats is based on metrics relevant to assessments of masking and behavioural disturbance. It should also capture the necessary information on the acoustic environment to assess the risks of chronic stress or hearing loss, as more information on these impacts becomes available in the future.
- The first step in the assessment framework is to decide which biological component of the ecosystem should be included in the assessment. The representative or indicator species may be selected either because a) they are believed to respond to noise in a representative way or b) because they are of particular concern in terms of underwater noise with respect to their conservation status.
- Member States need to select one or more indicator species for which to assess the habitat in relation to potential acoustic impacts. The selection of the species, other than in relation to its vulnerability, should be made with respect to the data available for a specific time span and spatial area.

- Another essential aspect of this first step is the selection of habitats (with the habitat defined as: where the indicator species live), which is done at regional or subregional level. Habitats should be understood as a geographical domain, i.e. an area occupied by the species or species community, or – in the case of, for example, the deep sea – a volume of water further defined within some upper and lower depth limits.
- Enough scientific data should be available to correctly describe the habitat. Habitats and indicator species are considered at Member State level. When habitats expand to more than one Member State, then habitats and indicator species are considered at (sub)regional level.

»» Assessment areas and scales

As defined by the GES Decision, the assessment frameworks for impulsive and continuous noise assume that effects of underwater noise are both spatially and temporally distributed and, therefore, both spatial and temporal aspects must be considered. As Member States' waters cover a large range of habitats and species, regional differences also need to be considered. The frameworks allow for a broad spectrum of regional specificities. This implies that the details of the implementation are dealt with at a regional level, in particular by the Regional Sea Conventions, as well as subregional bodies and regional expert groups.

The GES Decision sets out the region, subregion or subdivisions as the appropriate assessment scales for both impulsive and continuous noise.

Based on the assessment framework for EU threshold values for continuous noise (TG Noise Deliverable 3), the following three assessment scales can be distinguished for continuous noise:

- The grid cell where the condition is evaluated: The grid cell can be non-significantly or significantly affected (Section 3 and Annexes 2 and 4 of TG Noise Deliverable 3). The grid cell size is selected at (sub)regional level taking account of regional specificities. It is the basic building block to assess the status of the habitat. The size depends on the assessment purpose (fine grid for acoustical parameter assessments, coarse grid for the assessment of GES). It is advised to use existing grid definitions for the grid cell to facilitate comparison and integration with other environmental themes. There is not one grid suited for all EU Member States' marine waters in resolution or coverage and the choice is left to the marine regions. Grid systems include:
 - ICES statistical grid for the Atlantic region and the Baltic Sea⁷⁷. ICES statistical rectangles provide a grid covering the area between 36°N and 85°30'N and 44°W and 68°30'E
 - General Fisheries Commission for the Mediterranean (GFCM) grid for the Mediterranean and the Black Sea⁷⁸
 - EEA marine assessment grid for all European marine areas⁷⁹
 - C-squares – concise spatial query and representation system: a global systems of grid cells⁸⁰
- The habitat where the status is determined: The habitat can be in a tolerable or non-tolerable status. To assess its status, the habitat is divided into grid cells (Annex 2 of TG Noise Deliverable 3).

⁷⁷ <https://www.ices.dk/data/maps/Pages/ICES-statistical-rectangles.aspx>

⁷⁸ <http://www.fao.org/gfcm/data/maps/grid/en/>

⁷⁹ <https://www.eea.europa.eu/data-and-maps/data/eea-marine-assessment-grid>

⁸⁰ <https://en.wikipedia.org/wiki/C-squares>

- The marine reporting unit (MRU) for which the environmental status is reported: The MRU can be in good status (GES in area achieved) or not.

»» Threshold values

The threshold values for GES are set in terms of ‘tolerable impacted area’ (percentage of the habitat) and ‘tolerable duration’ (in percent) depending on the ‘level of onset of biologically significant adverse effects’ (LOSE) in line with the criteria defined for Descriptor 11 in the GES Decision. GES is maintained or achieved if the tolerable impacted area and tolerable duration are not exceeded.

Options for threshold values for both impulsive and continuous noise are under development and a proposal is expected to become available in 2022.

See Step 8 of the Assessment Framework for EU threshold values for continuous noise (TG Noise deliverable 3) for details on the determination of status of the habitats considered in relation to continuous noise. The potential for adverse effects at population level is assumed to occur when a certain fraction of the habitat is exposed to continuous sound for a certain fraction of time. Area and duration of exposure to anthropogenic sound can be assessed in terms of tolerable impacted area of the habitat and tolerable duration of the noise.

One of the steps in the D11C2 assessment is to evaluate the condition in each grid cell (see Annexes 4 and 6 of the Assessment Framework for EU threshold values for continuous noise, for details on geographic unit and assessment metrics of the grid cell). This is done by estimating the reference condition and the current condition of the cell. The reference condition quantifies the natural occurring state and the current condition a state with ships present. The deviation of the current state from the reference state provides an estimate of the condition of the grid cell. Depending on the indicator species, the condition of the grid cell can either be non-significantly or significantly affected by the anthropogenic noise. The effect on population level is addressed by applying the grid cell methodology to all grid cells of the habitat of a population (see Annex 7 of the Assessment Framework for EU threshold values for continuous noise, for details on the assessment of impact on habitats and populations). All the grid cells of the habitat will thus be quantified both in time and space as significantly or non-significantly affected. Thus, for a specific time period, a certain fraction of the grid cells will be significantly affected.

»» Temporal aspects of assessment

The six-year period for the assessment due for reporting in 2024 should be 2016–2021 and should be applied uniformly within and across marine regions. For assessment period, trend assessment and change of status see → section 2.2.5 and 2.4.

The basic time scale (temporal analysis period) for determining the status of the habitat is recommended to be one month. The assessment (temporal observational period) can be done on shorter time scales.

The determination of time periods for the assessments corresponds to step 3 of the assessment framework for EU threshold values for continuous noise (TG Noise Deliverable 3). The evaluation period can be monthly, seasonally, or annually. The time periods are decided and set at regional level. It is advised to use the guidelines of the International Quiet Oceans Experiment⁸¹.

⁸¹ <https://www.iqoe.org/>

»» Spatial aggregation of assessment

Some of the acoustical parameters in the assessment framework for EU threshold values for continuous noise need to be expressed as a grid, as defined above under → ‘Assessment areas and scales’. A fine grid needs to be used for soundscape maps as a result of modelling and a coarser grid as a means to display the (intermediate) results for comparison with other information (e.g. the distribution of indicator species).

The grid cells should be the smallest unit over which it is practicable to evaluate the condition of the area covered by the grid cell. Within a grid cell the acoustical parameters are described by a single quantity, which will vary over time. The grid of the grid cell must be viewed as an intermediate step in the assessment and further aggregation towards the assessment area must be done. Various input data is also supplied on a grid (e.g. bathymetry), which may be different from the assessment area. There should be sufficient numbers of grid cells within an assessment area such that any summary statistics reported (e.g. proportion of area assessed to be in GES) are not substantially affected by the choice of grid cell size.

The resolution of the grid must be sufficient to cover the spatial variability of sound field, but also computationally efficient.

»» Use of criteria

Based on the GES Decision, the use of criteria D11C1 and D11C2 in the assessment of GES for Descriptor 11 should be agreed through cooperation at EU level. Guidance on the integration rules of D11 assessments is still to be developed. Figure 4.7-1 illustrates the levels of assessment and integration for D11.

The scope of the assessment framework for EU threshold values for continuous noise (TG Noise Deliverable 3) is the evaluation of the condition of the grid cells (the first of the three levels covered in ‘assessment areas and scales’ section) and the determination of the status in a habitat. GES assessment in a MRU (level 3) and the link between levels 2 (habitat) and 3 are expected to be considered in TG Noise Deliverables 2 and 4 aimed at setting options for threshold values at EU level. Final decisions are to be made at regulatory and political level.

Scale: Region, subregion or subdivision

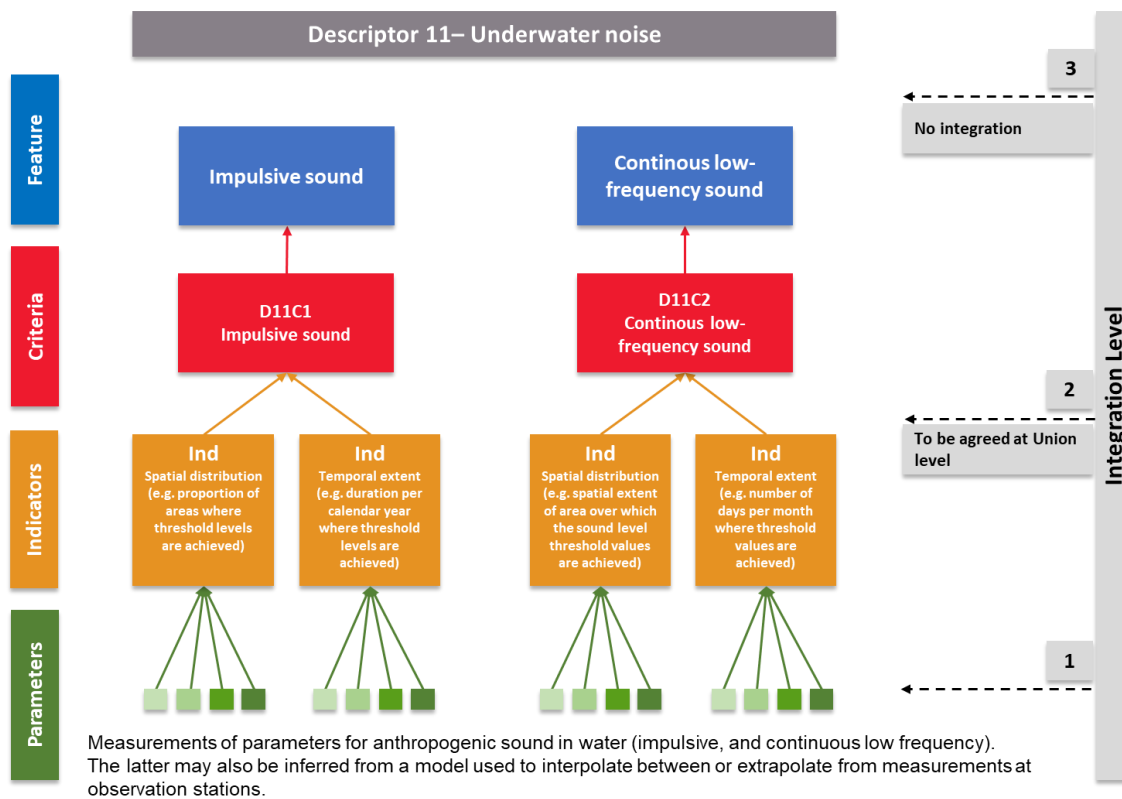

Figure 4.7-1: Levels of assessment and integration for Descriptor 11. Methods for integration are still to be developed.

»» Confidence

Annex 7 of the assessment framework for EU threshold values for continuous noise (TG Noise Deliverable 3) highlights that the assessment of the impact and the risk of an impact on population dynamics of animals can be undertaken at various levels of detail depending on the available data and the methods used. As a general principle, the greater the uncertainty and the less data that is available the more precaution needs to be taken when setting thresholds.

Further guidance on confidence assessment needs to be developed.

»» Visualising assessment results

Assessments are reported in relation to marine reporting units (MRUs), as defined by the Member States and covering all or parts of their marine waters. This means that data used for indicators are typically aggregated in space and time to provide summary values per MRU and, where necessary, the indicators are integrated to provide a conclusion on status for the criteria. The purpose is to provide a clear understanding of whether GES has been achieved in the MRU. In cases where the status is below GES, it should trigger a need for action (measures).

Visualisation should provide a clear overview whether GES has been achieved in the reference area (assessment area or MRU). The extent to which GES has been achieved could be expressed e.g. in a table format per reference area as the percentage (%) of the area over which the threshold values have been achieved. The assessment results can also be presented on maps in WISE-Marine. Further guidance on the visualisation of assessment results needs to be developed.

»» Gaps in knowledge and outstanding issues

Knowledge gaps

- *Improve understanding of impacts from noise on populations:*

The Population Consequences of Disturbance (PCoD) framework has been developed to estimate how sub-lethal disturbances such as effects of underwater noise can influence population dynamics (New et al., 2014; New et al., 2015). The framework was developed for marine mammals but could potentially be applied to other taxa. The PCoD framework aims at explaining how the exposure to stressors may lead to physiological and behavioural changes that can have effects on the individual fitness such as chronic effects on the health or acute effects on energetics, and thus likely on their vital rates. The effects on individuals can provide some basic insights into the population dynamics but the PCoD framework requires a considerable amount of demographic information on the species and specific population of interest, behaviour, distribution etc. (King et al., 2015). When some data are missing, PCoD models have been combined with bioenergetic models (Reed et al., 2020). In most cases, it has not been possible to fully parameterise PCoD models using empirical data, and surrogate data from another species, proxy relationships or inferences from some broad assumptions have been required (Pirodda et al., 2018).

For most species, empirical data on vital rates are lacking to validate model outputs. This limits the assessment of the reliability of PCoD model predictions. This situation is unlikely to change soon. Underestimations of the impacts of noise on populations cannot be excluded and the models may not be sufficiently robust to support assessments of whether measures to prevent or reduce adverse effects are sufficient.

While PCoD models can describe basic mechanisms and increase understanding of possible impacts of disturbance on vital rates, they cannot be considered operational for defining GES thresholds for most species. The assessment framework for EU threshold values for impulsive noise (TG Noise Deliverable 1, step 8) recognises the current limits of such models for the ability to quantify population consequences of noise impacts. For continuous noise, knowledge gaps are greater than for impulsive noise and so at this stage, the input data on vital rates are insufficiently accurate for GES assessments.

Outstanding issues

There may be areas and conditions where the assessment may be particularly challenging. Here is a list of potential areas and suggestions for possible solutions.

- *Deep sea areas*

Assessment of underwater noise in deep sea areas is challenging because in these areas environmental data are very limited and when they are available, confidence is generally low. In deep sea areas, offshore Automatic Identification Systems (AIS) have a lower temporal resolution even if satellites and relay station deployment will improve it. Interpolation looks like a good alternative especially around shipping routes where confidence is acceptable. Simple methods have been developed to estimate shipping density from AIS signals received by satellite (e.g., Frantzis et al., 2019). An alternative to increase confidence in modelling is to complement modelling with *in situ* measurements. However, it should be stressed that it is very challenging to deploy measuring stations in deep sea areas both financially and technically, as illustrated by MAMBO French monitoring program of MSFD (Kinda et al., 2017).

As for the measurements, available continuous acoustic data from the existing deep-sea cabled observatories/infrastructures which are equipped with hydrophones, such as the NEMO SN1 (East of Sicily), the EMSO-ERIC Hellenic Site (Poseidon-Pylos), the EMSO-Azores (SeaMon West) and the ANTARES neutrino telescope, can be used. Apart from the sound pressure, analysis of those data could provide information concerning the presence of deep diving species (sperm whales, Cuvier's beaked whales), thus contributing to partially filling the lack of biodiversity data for deep sea waters. Other alternatives can be used to improve data collection such as short-time deployments and glider-based measurements.

- *Coastal areas with considerable pleasure boat and small vessel traffic*

Recreational vessels without AIS dominate underwater noise contributions in coastal shallow water (Hermannsen et al., 2019). Radar from seashore could be a useful complement to track small vessels without AIS even if the range of tracking is limited (Cope et al., 2020). Density patterns of vessels based on AIS data can differ from radar-based patterns, especially inside and outside shipping lanes and depending on the season (Barco et al., 2012). Further, acoustical detection of recreational ships can help to assess their contribution into the underwater soundscape, although in this case source levels of the individual boats cannot be assessed. Some recent studies have combined measurements with monitoring of tracks of recreational vessels (e.g. Cope et al., 2021). If applicable, individual pleasure boats can be tracked with the help of cell phone onboard.
- *Ice-covered seas*

In case of ice-covered areas, the wind-generated surface wave noise is drastically decreasing and reference condition might reach very low noise levels. On the other hand, there are winter conditions when the ice produces a substantial amount of sound. Further, the sound speed profile near the sea surface has a positive gradient, favoring upward refraction of the acoustical rays and formation of the surface sound channel (Jensen et al., 2011). In these conditions, the excess of shipping noise over the natural ambient sound can reach considerable values at larger distances from the shipping lanes, while in the other periods natural ambient sound is dominating (Prawirasasra et al., 2021). As a result, offshore wind parks will probably contribute more to the soundscape under the ice cover. Under-ice sound propagation modelling is challenging because of the lack of information about propagation loss due to ice cover. Arctic parabolic equation is often used for the modelling (Collins et al., 2019) but it is not yet operational or commercially available.
- *Data and knowledge gaps for impulsive noise*

Assessment of D11C1 relies strongly on the available data in the impulsive noise registries. Depending on the activity, the information may lack comprehensiveness and accuracy (De Santis et al., 2018; Merchant et al., 2019). It remains to be seen how these uncertainties affect the reliability of D11C1 assessments. The HARMONIZE project and TG Noise Deliverable 2 will contribute to defining worst case scenarios in data availability for assessments.

5. Status-based Descriptor Assessment

5.1 Descriptor 1: Birds

Descriptor 1: Biological diversity is maintained. The quality and occurrence of habitats and the distribution and abundance of species are in line with prevailing physiographic, geographic and climatic conditions. (MSFD Annex I)

DESCRIPTOR PROFILE		D1C1 Bycatch	D1C2 Abundance	D1C3 Demography	D1C4 Distribution	D1C5 Habitat
Feature		Species groups: Grazing birds; Wading birds; Surface-feeding birds; Pelagic-feeding birds, Benthic-feeding birds				
Primary criterion		X	X			
Information type		Impact	State	State	State	State (species)
Annex III MSFD	State (Table 1)	Species / Birds				
	Pressure (Table 2a)	Extraction of, or mortality/injury to, wild species (by commercial and recreational fishing and other activities)	Input or spread of non-indigenous species; Input of microbial pathogens; Disturbance of species (e.g. where they breed, rest and feed) due to human presence; Selective extraction of species, including non-target catches; Extraction of, or mortality/injury to, wild species (by commercial and recreational fishing and other activities); Loss of, or change to, natural biological communities due to cultivation of animal or plant species; Physical loss (due to permanent change of seabed substrate or morphology and to extraction of seabed substrate); Physical disturbance to seabed (temporary or reversible); Input of other substances (e.g. synthetic substances, non-synthetic substances, radionuclides) — diffuse sources, point sources, atmospheric deposition, acute events; Input of litter (solid waste matter, including micro-sized litter); Input of anthropogenic sound (impulsive, continuous); Input of other forms of energy (including electromagnetic fields, light and heat)			
	Activity (Table 2b)	Extraction of living resources: Fish and shellfish harvesting (professional, recreational); Hunting and collecting for other purposes	Renewable energy generation (wind, wave & tidal power); Fish and shellfish harvesting (professional, recreational); Hunting and collecting for other purposes; Extraction of minerals (rock, metal, ores, gravel, sand, shell); Extraction of oil and gas; Aquaculture; Agriculture; Land claim; Coastal defence and flood protection; Offshore structures (other than for oil/gas/renewables); Restructuring of seabed morphology, including dredging and depositing of materials; Military operations (subject to Article 2(2)); Tourism and leisure activities; Transport – Shipping			
GES Decision	Elements	(sub)regional	(sub)regional	(sub)regional	(sub)regional	(sub)regional
	Threshold values	(sub)regional	(sub)regional	(sub)regional	(sub)regional	
	Use of criteria	EU				
Criteria linkages		D8C4, D10C4, D11C1	D2C3, D3C1, D4C1*, D4C2*, D4C3*, D4C4*, D8C2, D8C4, D9C1, D10C3, D10C4, D11C1	D2C3, D3C1, D4C3*, D4C4*, D8C2, D8C4, D9C1, D10C3, D10C4	D2C3, D3C1, D6C1*	D2C3, D3C1, D6C1*, D6C2*, D6C3*, D6C4*, D6C5*, D10C3, D10C4
Descriptor linkages		D8, D10, D11	D2, D3, D4*, D8, D9, D10, D11	D2, D3, D4*, D8, D9, D10	D2, D3, D6*	D2, D3, D10, D6*

* Not included in the GES Decision

»» Elements

Elements are marine bird species occurring in the respective marine (sub)regions. Assessments based on species are integrated to assessments of five species groups:

- Grazing birds
- Wading birds
- Surface-feeding birds
- Pelagic-feeding birds
- Benthic-feeding birds

Member States should first draw up a list of the bird species that need to be considered for each species group through (sub)regional cooperation. The main scientific criteria for selecting species should be considered. These species may be drawn from:

- Birds Directive
- Regional Sea Conventions
- Other sources

The GES Decision requires that the selected species should be representative of the species group and their ecosystem functioning but should also be relevant for the assessment of anthropogenic pressure. The set of species selected per species group should cover, as far as possible, the full range of ecological functions of the species group. As each species has its role in the ecosystem and Descriptor 1 aims to maintain biodiversity, there is no reason to omit a species from the established list of elements for the assessment.

If a species occurs in an assessment area with two or more populations, e.g. when breeding birds and wintering birds from the same species do not belong to the same population, these are assessed separately. For reporting purposes, it is recommended to create an associated element for 'non-breeding' and 'breeding' populations.

Complete species lists are largely lacking for the different marine regions. However, the following sources provide an indication of which species can be assessed:

- North-East Atlantic: → [ICES JWGBIRD Report \(2014\)](#)⁸² and → [MISTIC SEAS Macaronesian Roof Report \(2018\)](#)⁸³
- Baltic Sea (breeding birds only): → [HELCOM Checklist 2.0 of Baltic Sea Macrospecies \(2020\)](#)⁸⁴
- Mediterranean Sea: → [Waterbirds in the Mediterranean region](#)⁸⁵ (does not include marine birds from the families Stercorariidae, Alcidae, Hydrobatidae, Procellariidae, Sulidae)

In addition, indicator reports from previous assessments at → [OSPAR](#), → [HELCOM](#) and → [UNEP/MAP-MED POL](#) can be used to obtain a minimum scope of species to be assessed. Regarding breeding birds, the European Breeding Bird Atlas (Keller et al., 2020) can be consulted for an overview of marine bird species breeding in the respective assessment units.

⁸² https://www.ices.dk/sites/pub/Publication%20Reports/Expert%20Group%20Report/acom/2014/JWGBIRD/JWGBIRD_2014.pdf

⁸³ https://misticseas3.com/sites/default/files/material-divulgativo/main_results_macaronesian_roof_report_en.pdf

⁸⁴ <https://helcom.fi/wp-content/uploads/2020/12/BSEP174.pdf>

⁸⁵ <https://www.medwaterbirds.net/>

There is no specifically agreed guidance for Member States on excluding and adding elements from/to the regional lists.

Specific guidance for D1C1

In relation to D1C1, Member States should draw up a list of the bird species at risk from incidental bycatch in the region or subregion, through (sub)regional cooperation. According to the Commission Delegated Decision on the CFP data collection framework (DCF) (currently Commission Delegated Decision (EU) 2021/1167, Table 2 (former 1D)), all marine birds, including migratory species are to be monitored.

»» Assessment areas and scales

Assessment should be at ecologically relevant spatial scales to the species. The following assessment scales are provided in the GES Decision:

- Baltic Sea – region or subdivisions (HELCOM HOLAS II: seven subdivisions, each consisting of up to four aggregated subbasins)⁸⁶
- North-East Atlantic – subregion (OSPAR Intermediate Assessment 2017: used subdivisions of subregions in addition)⁸⁷
- Mediterranean Sea – subregion⁸⁸
- Black Sea – region or subdivisions⁸⁹

Member States through (sub)regional cooperation should determine the appropriate ecologically relevant assessment scales and assessment areas. If subdivisions are used, reasonable assessment areas from an ecological point of view are to be defined. If separate populations of a species exist within a particular region or subregion, they should be assessed individually.

It is important to analyse the indicators on the smallest scale possible to allow for area-specific measures where needed. For linking assessments to Marine Reporting Units see → section 2.4.

»» Threshold values

Agreed method to derive threshold values for criteria, depending on action level

Threshold values are agreed regionally for indicator assessments conducted on a regional scale. If national indicators are used, threshold values can be determined specifically. In principle, threshold values should be based on reference conditions. For the reference conditions, historical data, the state of knowledge for certain periods of time (e.g. at the beginning of data series or before the beginning of a certain human activity) or areas lacking human pressures can be used as a baseline.

Threshold values should be connected to the conservation objective that the long-term viability of populations is not threatened. They are best defined by modelling population growth using demographic data from the respective populations and updates gained from the indicator assessments (also across indicators).

⁸⁶ HELCOM, 2017; cf. core indicator report 'Abundance of waterbirds in the breeding season': <https://helcom.fi/wp-content/uploads/2019/08/Abundance-of-waterbirds-in-the-breeding-season-HELCOM-core-indicator-2018.pdf>

⁸⁷ OSPAR, 2017; cf. common indicator assessments: <https://oap.ospar.org/en/ospar-assessments/intermediate-assessment-2017/biodiversity-status/marine-birds/>

⁸⁸ UNEP/MAP-MED POL, 2017: https://www.medqsr.org/sites/default/files/inline-files/2017MedQSR_Online_0.pdf

⁸⁹ BSC, 2017: <http://www.blacksea-commission.org/Inf.%20and%20Resources/Publications/SOE2014/>

Criteria threshold values agreed at (sub)regional level

The regional indicators have agreed threshold values, but for the individual criteria the threshold values may vary between regions (Table 5.1-1). Where population modelling is part of the indicator, the thresholds are species-specific. The threshold values are intended to indicate levels at which the long-term viability of a species is at risk. A regularly updated state of regionally agreed indicators is available on Regional Sea Conventions' websites.⁹⁰

Table 5.1-1: Overview of the type and coverage of threshold values available for regional indicators. Indication of whether threshold value is available at criterion (C), species-specific (S) or feature (F) level or whether no threshold value or indicator is available. C: All elements of a criterion (i.e. mostly species) have the same threshold value (in brackets: threshold value not yet defined but foreseen for future assessments). S: Threshold values for all elements are derived in the same way, but have different absolute values (e.g. because based on population modelling). N: No threshold value. -: No indicator.

	D1C1	D1C2	D1C3	D1C4	D1C5
OSPAR*	S/C	C	S	-	(C)
HELCOM**	S/C	C	S	-	(C)
UNEP/MAP***	-	N	N	N	-
BSC	-	-	-	-	-

* based on QSR 2023 preparations; ** based on HOLAS III preparations; *** based on QSR 2017

»» Temporal aspects of assessment

The six-year period for the assessment due for reporting in 2024 should be 2016–2021 and should be applied uniformly within and across marine regions. If this is not feasible, e.g. due to a mismatch between reporting periods of Birds Directive and MSFD, differences in assessment periods may occur. For assessment period, trend assessment and change of status see → section 2.2.5 and 2.4.

In line with Article 17 MSFD, the criteria and data used for the assessment must be representative for the respective MSFD assessment period of six years.

Depending on the scope and effort of the individual assessments as well as on data availability, not every single year needs to be considered. If long-term data series are used, they must extend into the assessment period.

Seasonality in the occurrence of marine birds needs to be considered, because most marine birds are migrating and thus use different parts of the marine environment during their annual cycle. To treat breeding and non-breeding populations of one species separately, it is recommended to assess them independently of each other.

»» Spatial aggregation of assessment

Member States are expected to deliver the assessment of the environmental status of marine bird species groups at the scale of the four marine regions through regional cooperation and common

⁹⁰ OSPAR: <https://www.ospar.org/work-areas/cross-cutting-issues/ospar-common-indicators>; HELCOM: <https://helcom.fi/baltic-sea-trends/indicators/>; UNEP/MAP-MED POL: <https://www.medqsr.org/integrated-monitoring-and-assessment-programme-mediterranean-sea-and-coast>; BSC: Integrated monitoring and assessment programme 2017–2022, https://ec.europa.eu/environment/marine/international-cooperation/regional-sea-conventions/bucharest/pdf/BSIMAP_2017_to_2022_en.pdf; cf. also Anemone Project, <http://anemoneproject.eu/wp-content/uploads/2021/09/deliverables/Deliverable%201.3.pdf>

regional assessment frameworks. It is recognised that Member States may assess additional aspects at a national level for various reasons:

- Regional assessments are not ready, but additional national assessments are available (e.g. supplementary indicators, Red Lists) which partly address the issue.
- There is no plan for a regional assessment of the element because there is no political agreement.
- An element is only of national relevance.

If population-specific assessment areas and marine reporting units do not have the same spatial coverage, linking them should follow regional conventions and EU MSFD CIS guidance (→ section 2.4; EU MSFD CIS Guidance Document No. 14 under revision). National reporting should take the relevant assessment areas into account. For D1C1, data available on the scale of ICES areas, GFCM Geographical Sub-Area or FAO fishing areas need to be linked to MSFD assessment areas and marine reporting units.

Guidance on methods for spatial aggregation of D1 assessments is still to be developed.

»» Use of criteria

Use of D1 criteria in birds' assessment

According to the GES Decision, criteria results should be integrated per species to reach an assessment of status at the element (species) level, before these results are combined to express the status of the species group (feature) level. The integration stops at the species group level. Species groups are not integrated to ecosystem component. However, integration from species group to ecosystem component could be beneficial for the purpose of communication, i.e. to present assessment results to decision-makers and the public (Dierschke et al., 2021).

Integration of criteria results per species

Use conditional rules as depicted in Figure 5.1-1 and listed in Table 5.1-2. Indicator assessments of the primary criteria (D1C1, D1C2) are complemented by the indicator assessments of the secondary criteria (D1C3, D1C4, D1C5) in case these are used. These rules acknowledge the high informative value of criterion D1C3 without neglecting the importance of the primary criteria. The rationales behind these rules are described in the JRC report Dierschke et al. (2021)⁹¹.

D1C1 is not needed for species which are not under threat from incidental bycatch. If not all criteria are applicable to a population or cannot be assessed, the conditional rules must be modified as shown in assessment scenario b and c (Table 5.1-2) for breeding and wintering birds respectively. In the case of missing data to assess a primary criterion or a secondary criterion when considered relevant (i.e. there is risk), the Member States should act on monitoring and assessment tools to ensure that at the next update under Article 8 MSFD an assessment can be undertaken.

⁹¹ <https://doi.org/10.2760/4751>

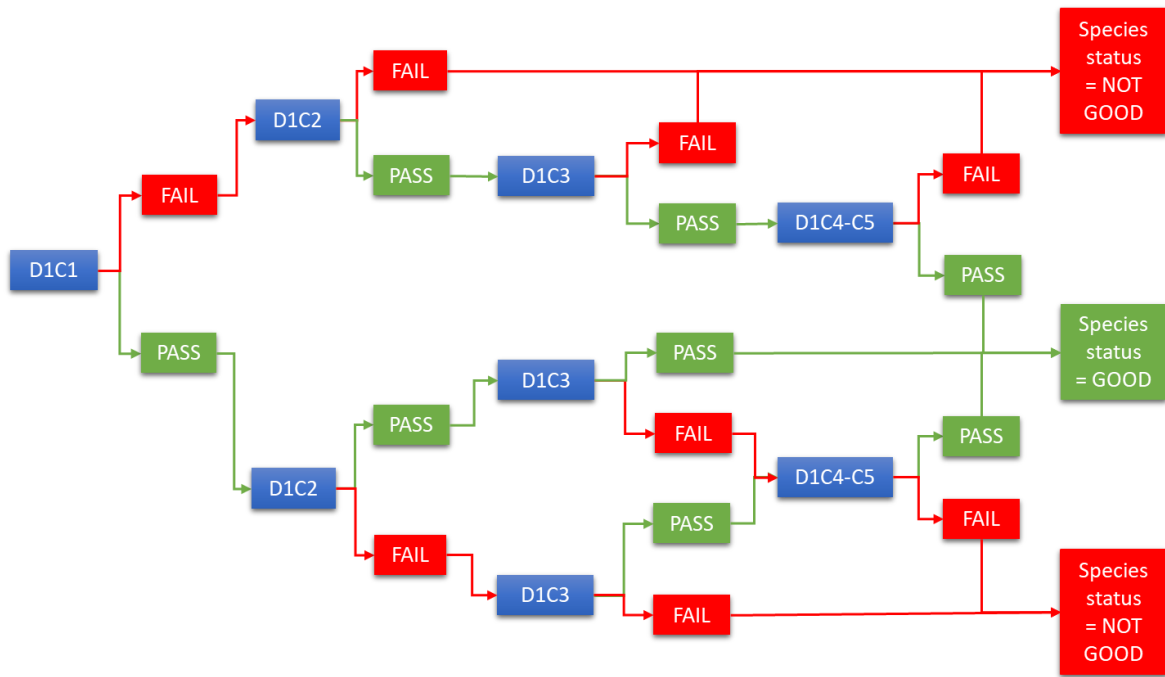

Figure 5.1-1: Conditional rules for integrating criteria to assess the status of a marine bird species (see also Table 5.1-2). FAIL = Species is not reaching criterion (indicator) specific threshold values; O = Criterion/indicator is not assessed; PASS = Species is reaching the criterion (indicator) specific threshold values. The figure does not show all assessment scenarios included in Table 5.1-2.

Table 5.1-2: Guide to integrating assessments from criteria to species status, with all criteria assessed (see also Figure 5.1-2). Assessment scenario (a) shows the application of the conditional rules in the ideal case that all criteria are applicable. In practice, it is recommended that assessment scenario (b) is followed for breeding birds and assessment scenario (c) for wintering birds. Legend: N/red: criterion fails to achieve threshold value; Y/green: criterion meets threshold value; O/gray: missing data or reference level but criterion relevant to assessment; NA/grey: not applicable, criterion result irrelevant to assessment. On species at risk from incidental bycatch: Missing data for criterion D1C1 are treated differently for species regionally classified as being threatened and declining or red-listed (O**) and those not classified as being threatened and declining or red-listed (O*).

Assessment scenario a											
Criteria	E1	E2	E3	E4	E5	E6	E7	E8	E9	E10	E11
D1C1	Y	Y	Y	Y	Y	N	N	Y	N	N	N
D1C2	Y	N	N	Y	Y	Y	Y	N	Y	N	N
D1C3	Y	Y	Y	N	N	Y	Y	N	N	Y	N
D1C4 and D1C5 combined	Y or N	Y	N	Y	N	Y	N	Y or N	Y or N	Y or N	Y or N
Species status	Good	Good	Not good	Good	Not good	Good	Not good	Not good	Not good	Not good	Not good

Assessment scenario b							
Criteria	E12	E13	E14	E15	E16	E17	E18
D1C2	Y	N	N	Y	Y	N	N
D1C3	Y	Y	Y, O or NA	N, O or NA	N, O or NA	N	O or NA
D1C4 and D1C5 combined	Y, N, O or NA	Y	N, O or NA	Y, O or NA	N	Y, N, O or NA	Y
Species status	Good	Good	Not good	Good	Not good	Not good	Not good
Assessment scenario c							
Criteria	E19	E20	E21	E22			
D1C1	Y, NA or O (*)	Y, NA or O (*)	Y, NA or O (*)	N or O (**)			
D1C2	Y	N or O	N	Y or N			
D1C4 and D1C5 combined	Y or N	Y	N or O	Y or N			
Species status	Good	Good	Not good	Not good			

If regionally red-listed species cannot be assessed by the indicators due to lack of data they are treated as not in good status, because their red-list status is based on scientific criteria such as low population size and declining trend in population size (Dierschke et al., 2021).

Integration from species to species group

Apply proportional method if at least five elements (species or populations) of a species group can be assessed. If 75 % of all elements (including those not assessed or unknown) are in good status, then the species group is considered to be in good status. The 75 % threshold was developed for the OSPAR Ecological Quality Objective (EcoQO) on seabird population trends (ICES, 2011) and is recommended for use by Humphreys et al. (2012).

Figure 5.1-2 summarises the levels and methods for integration for the assessment of birds under Descriptor 1.

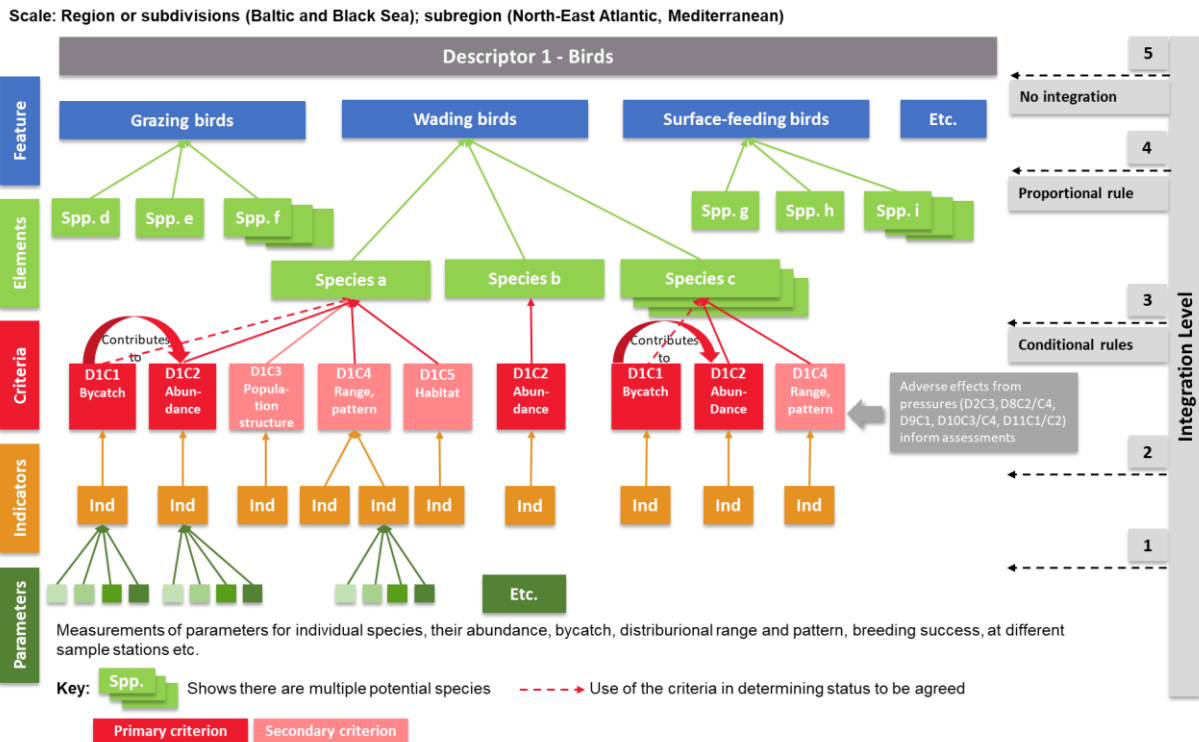

Figure 5.1-2: Levels and methods of integration for birds under Descriptor 1.

Voluntary integration from species group to ecosystem component

This integration step is not required by the GES Decision. However, a Member State may wish to do so to help with the presentation of assessment results to politicians and the public. It is considered that no species group can replace another species group in the ecosystem, because each species group is representing a particular functional role in the marine ecosystem. Therefore, it is suggested that an ecosystem component cannot be in good status if one or more of the assessed species groups are considered not to be in good status.

Use of criteria from other Descriptors in birds' assessment

Assessments of adverse effects on species under other Descriptors (→ Descriptor profile for D1 Birds) are not integrated with the Descriptor 1 assessments, but the information they provide should help the interpretation of the assessment of status at species and species groups level as relevant. For example, in cases where criteria under other Descriptors assess anthropogenic mortality (such as D10C4), the information should be included to complement the assessment of bycatch mortality under criterion D1C1. Likewise, information from other Descriptors can be included in a similar way into the presentation of assessment results at criterion level. However, it is not used as independent criterion in the integration on the status of species (Dierschke et al., 2021).

More specific guidance on linking assessment results under other Descriptors with the status assessment of birds still needs to be developed.

»» Confidence

While individual indicators discuss data quality and include confidence intervals in their assessments of species, there is no statistical approach to combine uncertainties from indicators during integration to the level of species groups.

Until a statistical framework is developed for expressing confidence of species group assessments, as a minimum, a qualitative approach should be applied by experts. They aggregate their judgements about the validity of assessments by evaluating both evidence of the assessment and agreement (→ Figure 2-6; → section 2.2.8). Confidence varies due to the flexibility in the relationship between evidence and agreement.

» Visualising assessment results

The assessment output for Descriptor 1 component ‘Birds’ is presented for the marine region or its subregions or subdivisions:

- by criterion for each species
- as the overall status of each species
- as the overall status of the species group

These assessment results are best shown by a comprehensive table (with extended results provided in annex tables). See Table 5.1-3 for illustration.

Table 5.1-3: Illustration for presenting assessment results. Results are fictional. Status: Green = good according to the MSFD; red = not good according to the MSFD; grey = unknown. Trend: ↑ improving, ↓ deteriorating, ↔ stable.

Species group	Species	D1C1 Anthropogenic Mortality	D1C2/D1C3 Population	D1C4 Distribution	D1C5 Habitat	Status of the species (MSFD)	Change in status
Species group 1	Species 1	...	↑	↑	↑	Green	↑
	Species 2	...	↑	↔	↔	Green	↑
Species group 2	Species 3	...	↔	↔	↔	Red	↔
...

In addition, a summary can be provided in a graphical format for the individual species groups, preferably also showing the distance to the threshold value (see example in

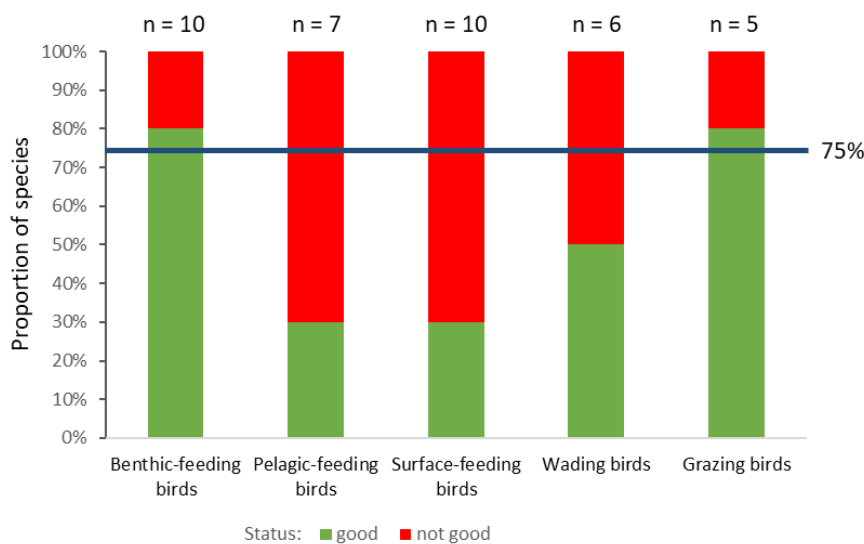

Figure 1.1-4).

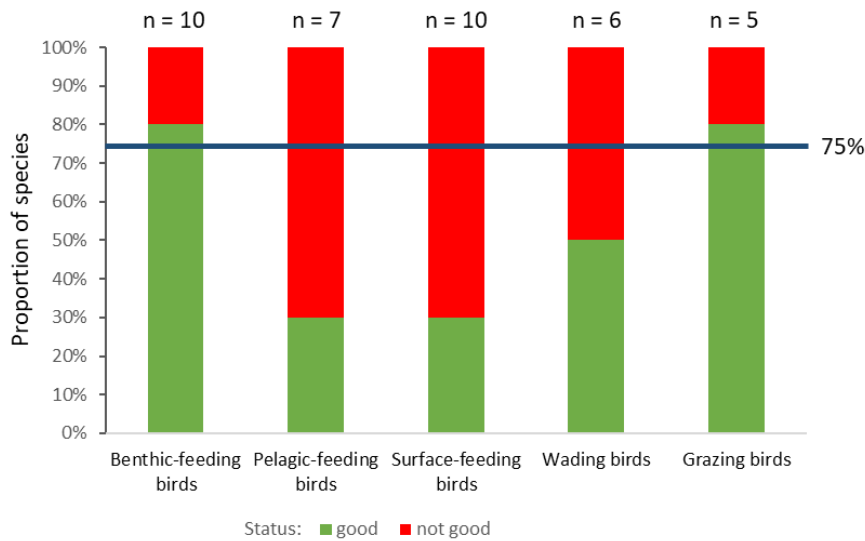

Figure 1.1-4: Proportions of species and populations per species group which are assessed to be in good or not good status. The blue line indicates the proportional rule of 75 % of species/populations in good status to achieve good status of a species group.

»» Gaps in knowledge and outstanding issues

The following issues remain outstanding and require future guidance:

Gaps in knowledge

- Coverage of criteria by indicators:** In all marine regions, the five criteria are inadequately populated with indicators. As a result, the last Article 8 MSFD assessments for 2018 were based on few aspects, and threats to species may not be comprehensively identified. While this often refers to secondary criteria, which, according to Article 3(2) GES Decision, ‘shall be used to complement a primary criterion or when the marine environment is at risk of not achieving or not maintaining good environmental status for that particular criterion’, Member States should strive to complete the set of indicators as relevant through regional cooperation to allow assessments that inform about main threats and needed measures.
- Data availability:** Existing indicators are not sufficiently supplied with data. This concerns, on the one hand, the number of species for which data are collected within the framework of the indicators, and, on the other hand, time series that only incompletely extend into the assessment period. Particularly in the case of criterion D1C1 (bycatch), it is noticeable that almost none of the Member States carries out suitable monitoring to be able to assess this criterion. All Member States should endeavour to collect and provide sufficient quality and quantity for future assessments.

Outstanding issues

Close identified guidance gaps, including:

- Guidance for Member States on excluding and adding elements from/to the regional lists
- Guidance on methods for spatial aggregation of D1 assessments
- Threshold values agreed through regional cooperation

- Specific guidance on linking assessment results under other Descriptors with the status assessment of birds

There is a need to harmonise the timing of MSFD reporting and Birds Directive reporting. On a longer term also timeframes and schedules for assessment should be harmonised between Birds Directive and MSFD. Ongoing review processes on reporting formats should take these needs into account and ease the way towards a single common reporting of biological components in Birds Directive and MSFD.

5.2 Descriptor 1: Mammals

Descriptor 1: Biological diversity is maintained. The quality and occurrence of habitats and the distribution and abundance of species are in line with prevailing physiographic, geographic and climatic conditions. (MSFD Annex I)

DESCRIPTOR PROFILE		D1C1 Bycatch	D1C2 Abundance	D1C3 Demography	D1C4 Distribution	D1C5 Habitat
Feature		Small toothed cetaceans; Deep-diving toothed cetaceans; Baleen whales; Seals				
Primary criterion		X	X		X	X
Information type		Impact	State	State	State	State (species)
Annex III MSFD	State (Table 1)	Species / Mammals				
	Pressure (Table 2a)	Extraction of, or mortality/injury to, wild species (by commercial and recreational fishing and other activities)	Disturbance of species (e.g. where they breed, rest and feed) due to human presence; Extraction of, or mortality/injury to, wild species (by commercial and recreational fishing and other activities); Physical loss (due to permanent change of seabed substrate or morphology and to extraction of seabed substrate); Input of other substances (e.g. synthetic substances, non-synthetic substances, radionuclides) — diffuse sources, point sources, atmospheric deposition, acute events; Input of litter (solid waste matter, including micro-sized litter); Input of anthropogenic sound (impulsive, continuous); Input of microbial pathogens; Input or spread of non-indigenous species;			
	Activity (Table 2b)	Extraction of living resources: Fish and shellfish harvesting (professional, recreational); Hunting and collecting for other purposes	Physical restructuring of rivers, coastline or seabed (water management); Extraction of non-living resources; Production of energy; Extraction of living resources; Cultivation of living resources; Transport – shipping; Urban and industrial uses; Tourism and leisure; Military operations (subject to Article 2(2))			
GES Decision	Elements	(sub)regional	(sub)regional	(sub)regional	(sub)regional	(sub)regional
	Threshold values	(sub)regional	(sub)regional	(sub)regional	(sub)regional	
	Use of criteria	EU				
Criteria linkages		D8C4, D10C4, D11C1	D3C1, D4C1, D4C2, D4C3, D4C4, D6C3, D8C2, D8C4, D9C1, D10C3, D10C4, D11C1, D11C2	D3C1, D4C3, D4C4, D8C2, D8C4, D9C1, D10C3, D10C4, D11C1, D11C2	D3C1, D6C3, D11C1, D11C2	D3C1, D6C3, D10C3, D10C4, D11C1, D11C2
Descriptor linkages		D8, D10, D11	D3, D4*, D6*, D8, D9, D10, D11	D3, D4*, D8, D9, D10, D11	D3, D6, D11	D3D6, D10, D11

*Not included in the GES Decision

»» Elements

Elements are marine mammal species occurring in the respective marine subregions/regions. Assessments based on species are integrated into assessments of four species groups (features), of which all species groups must be assessed if they occur in the respective marine subregions/regions. These are:

- Small toothed cetaceans
- Deep-diving toothed cetaceans
- Baleen whales
- Seals

The GES Decision outlines scientific and additional practical criteria for species selection. The criteria include that species selected for an area must be representative of the species group and their ecosystem functioning, but also be relevant for the assessment of anthropogenic pressure. This is true for all marine mammal species. The set of species selected per species group must cover the full range of ecological functions of the species group. As each species has its role in the ecosystem and Descriptor 1 aims to maintain biodiversity, there is no reason to omit any of the species, occurring in a region more than occasionally, from the assessment. All species listed in Annexes II, IV and V of the Habitats Directive must be included, which are all marine mammal species. It is acknowledged that, despite best efforts, it may take time to build up data sets supporting assessments.

Complete species lists are largely lacking for the different marine regions. For the Baltic Sea and the North-East Atlantic, the tables in the technical annex to the joint OSPAR/HELCOM bycatch report (Evans et al., 2021)⁹², and for the Mediterranean, the Cetacean species list by ACCOBAMS (Franzolini et al., 2013)⁹³ provide an indication of which species are represented by populations which are regularly present and should be assessed. In addition, indicator reports from previous assessments at → [OSPAR](#), → [HELCOM](#) and → [UNEP/MAP-MED POL](#) can be used to obtain a minimum scope of species to be assessed.

D1C1 and D1C2 are primary criteria, D1C3 is secondary for all species which are not commercially exploited. All marine mammals are listed in either of the Annexes II, IV and V of the Habitats Directive, which is a condition determining whether D1C4 and D1C5 are primary or secondary. Therefore, these two criteria are also primary for mammals. For mammals, the criteria should be consistent to those used under the Habitats Directive as follows:

- D1C2 and D1C3 equate to ‘population’.
- D1C4 equates to ‘range’.
- D1C5 equates to ‘habitat for the species’.

D1C1 is not assessed under the Habitats Directive and does not equate to the Habitats Directive’s ‘future prospects’. However, the ‘future prospects’ parameter requires the assessment of pressures and threats, of which incidental capture (i.e. bycatch) is an important feature for a number of species. These data can be used for D1C1.

If a species occurs in an assessment area with two or more populations (for example, harbour porpoise in the Baltic Sea area), these populations should be assessed separately. Based on terminology used by the International Whaling Commission (IWC), for some species, ‘units to conserve’ may better describe what is meant by ‘population’. In conservation practice, determining these units has been guided by a list of characteristics which include genetics, life history characteristics, behaviour, culture, morphology, or a combination of these (Brakes et al., 2021). The occurrence of certain behaviours or cultures has been recognised as an important way to define ‘units to conserve’ for cetaceans with a strong fidelity to specific areas.

⁹² submitted for publication

⁹³ https://www.rac-spa.org/sites/default/files/doc_cetacean/manuel_cetaces_amp.pdf

Specific Guidance for D1C1

In relation to D1C1, Member States should draw up a list of the mammal species at risk from incidental bycatch in the (sub)region, through (sub)regional cooperation. According to the Commission Delegated Decision on the CFP data collection framework (DCF) (currently Commission Delegated Decision (EU) 2021/1167, Table 2 (former 1D)) all marine species listed in Annexes II, IV and V of the Habitats Directive, i.e. all marine mammals species, are to be monitored. For these species, D1C1 is a primary criterion and bycatch must be assessed.

»» **Assessment areas and scales**

Assessment should take place at ecologically relevant spatial scales for the species. The following scales are provided in the GES Decision:

- For small-toothed cetaceans: marine region or subdivisions for Baltic Sea and Black Sea; subregion for North-East Atlantic and Mediterranean Sea
- For deep-diving toothed cetaceans: marine region
- For baleen whales: marine region
- For seals: marine region or subdivisions for Baltic Sea; subregion for North-East Atlantic and Mediterranean Sea

Member States and Regional Sea Conventions should determine the appropriate ecologically relevant assessment scales and assessment areas. If subdivisions or assessments on a smaller scale are used, reasonable assessment areas from an ecological point of view should be defined. If two or more populations of a species exist within a particular region or subregion, they should be assessed individually.

»» **Threshold values***Agreed method to derive threshold values for criteria, depending on action level*

Threshold values are agreed regionally for indicator assessments conducted on a regional scale. If regional threshold values are not available, national indicators could be used, including national threshold values. In principle, threshold values are based on historical or modern reference conditions, whichever is more relevant. The state of knowledge for certain periods of time could therefore also be used (e.g. at the beginning of data series, before the beginning of a certain human activity or when Directives came into force) as a baseline. Knowledge of the species (such as generation length, population size, number of mature individuals) can be derived from IUCN Red List website⁹⁴.

Threshold values must be consistent with quantitative conservation objectives. The overall management goal is defined in Article 1 of the Habitats Directive (i.e. Favourable Conservation Status which is connected to viability, range and habitat of a species). Where such data exist, threshold values are best defined by modelling population dynamics using abundance and demographic data from the respective populations/‘units to conserve’ or species and time series from regular updates gained from the indicator assessments (also across indicators).

Criteria threshold values agreed at (sub)regional level

The regional indicators have agreed threshold values. However, threshold values may vary between regions for the individual criteria. A list of criteria with threshold values applied in marine regions is

⁹⁴ <https://www.iucnredlist.org/>

available in the Table 5.2-1. Where population modelling is part of the indicator, the thresholds are specific for the population and quantitative conservation objectives need to be agreed on. In such cases, the numerical values for the threshold will change over time. They differ on every occasion an analysis is run, depending on the data input. Threshold values are defined levels at which the long-term viability of a species is at risk. For example, for D1C1, OSPAR and HELCOM suggest algorithms to explore likely population dynamics under different management scenarios and estimate the limit of anthropogenic removals, such as Catch Limit Algorithm (CLA), Removal Limit Algorithm (RLA), Potential Biological Removal (PBR) or mPBR modified to a conservation objective which differs from PBR approach under the US Marine Mammal Protection Act. Such model-based frameworks and management strategy evaluations (MSE) can project the simulated population forward to determine how well management or conservation objectives might be achieved. Based on conservation objectives, threshold values can be set in such a way that the desired population development can be reached with a given certainty (Genu et al., 2021).

If population dynamics are assessed, threshold values should take into account the generation time of a species. A combination of two species-specific trend-based thresholds should be used addressing both, the long-term population dynamics, e.g. in relation to a fixed historic baseline, and the short-term population dynamics related to a rolling baseline, e.g. the previous assessment period. The use of the two thresholds aims to provide an indicator that would warn against both a slow but long-term steady decline and against a recovery followed by a subsequent decline. Using only a rolling baseline generates the problem of ‘shifting baselines’ whereas using only a fixed baseline could obscure recovery and decline periods. The two assessment values together would be able to act as a late trigger for investigation of any necessary management measures to promote a steady recovery and subsequent slowing of growth when carrying capacity is approached. This reactive approach is not precautionary as it requires to diagnose a decline first which would require a certain time series of data points. This is notoriously difficult with marine mammals, and, by the time a decline is detected, it is often too late to remedy it. Therefore, further work is needed; measures should be applied much earlier. Assessments of D1C1 and D1C3 can aid in detecting potentials for a population decline before this is seen in D1C2.

Table 5.2-1: Overview of the type and coverage of threshold values available for regional indicators. Indication of whether threshold value is available at criterion (C), species specific (S) or feature (F) level or whether no threshold value or indicators is available. C: All elements of a criterion (i.e., mostly species) have the same threshold value (in brackets: threshold value not yet defined but foreseen for future assessments). S: Threshold values for all elements are derived in the same way, but have different absolute values (e.g., because based on population modelling). F: There is only one threshold value for the feature (i.e., in a criterion for all elements together), which is applied to all elements. N: No threshold value. -: No indicator.

	D1C1	D1C2	D1C3	D1C4	D1C5
OSPAR *	S	S/F	S****	-	-
HELCOM **	S	S	S	S	-
UNEP ***					
BSC**** 95	C/F	C/S		C/S	

** based on QSR 2023 preparations; ** based on HOLAS3 preparations; *** based on QSR2017; **** seals only; preliminary values for dolphins*

⁹⁵ Based on CeNoBS project: Baseline values proposed for D1C2 and D1C4 at species levels, regional and for each EU Member States. They under further review but are proposed, in the interim, for use as threshold values: https://cenobs.eu/sites/default/files/Deliverable_2.2_Detailed_Report_on_cetacean_populations_distribution_and_abundance_in_the_Black_Sea.pdf. For D1C1, additional monitoring effort is recommended based on the findings of the pilot performed by CeBoBS: [https://cenobs.eu/sites/default/files/Deliverable_2.3_Detailed_Report_of_the_pilot\(s\)_on_bycatch_monitoring.pdf](https://cenobs.eu/sites/default/files/Deliverable_2.3_Detailed_Report_of_the_pilot(s)_on_bycatch_monitoring.pdf)

»» Temporal aspects of assessment

The six-year period for the assessment due for reporting in 2024 should be 2016–2021 and should be applied uniformly within and across marine regions. If this is not feasible, e.g. due to a mismatch between reporting periods of Habitats Directive and MSFD, differences in assessment periods may occur. For assessment period, trend assessment and change of status see → section 2.2.5 and 2.4.

The criteria and data used for the assessment must be representative for the respective MSFD assessment period of six years. This period should be harmonised with assessment periods of the Regional Seas Conventions and Member States.

Depending on the scope and effort of the individual assessments as well as on data availability, not every single year needs to be considered. If long-term data series are used, they must extend into the assessment period. For data-poor species when data is not extending into the assessment period, the latest available data must be used. For reporting, it is important to be clear about which data have been used (years, trends over the six-year period, rolling baseline, etc.).

Specific guidance for D1C1

For the short-term, if monitoring data from the onboard observer programmes under the DCF does not allow annual assessments (despite a legal requirement to monitor bycatch) due to low monitoring effort and incomplete reporting of fishing effort, data should be acquired via other coordinated monitoring frameworks (e.g. HELCOM, 2020). In the longer term, D1C1 should be assessed annually. This will require sufficient observer or Remote Electronic Monitoring coverage in the relevant métiers.

Specific guidance for D1C2

For the North-East Atlantic, including Celtic Sea, western Baltic and North Sea, abundance and distribution data for many cetacean species have been collected and are expected to continue to be collected in the SCANS surveys and similar ship-based or aerial line-transect surveys. Some national or multilaterally co-ordinated surveys are carried out at a higher frequency than SCANS (e.g. miniSCANS in the Kattegat and Belt Sea). This is further supplemented by research projects such as SAMBAH on the abundance of Baltic Proper harbour porpoises. For the Mediterranean Sea, data are available from the ACCOBAMS Survey Initiative (ASI) as well as from national scale monitoring activities. Both data sets should be considered in close combination, since they can even provide trends in abundance estimate for some areas and this will help in the D1C2 assessments. Seals are counted on haul-outs in multilaterally co-ordinated surveys during moulting or pupping season when a large part of the population is outside the water. Future surveys aiming at abundance estimates should ideally match with the reporting cycle, i.e. every 6 years.

»» Spatial aggregation of assessment

Member States are expected to deliver the assessment of the environmental status of the four marine regions through (sub)regional cooperation and common (sub)regional assessment frameworks. It is recognised that Member States may assess additional aspects at a national level for various reasons including:

- Further regional assessments are not available but assessments on a national geographic scale (e.g. under the Habitats Directive, MSFD monitoring activities, supplementary indicators, LIFE projects or Red Lists) could partly address the issue.
- An element is only of national relevance.

If population-specific assessment areas and marine reporting units do not have the same spatial coverage, linking them should follow regionally agreed aggregation methods and EU MSFD CIS guidance (→ section 2.4).⁹⁶ National reporting should take the relevant assessment areas into account. For D1C1, bycatch data for various métiers available on the scale of ICES areas, GFCM Geographical Sub-Area or FAO fishing areas need to be linked to MSFD assessment areas and marine reporting units.

To implement measures where they are needed, national assessments should reflect the situation in their national waters. Therefore, results can differ between national and (sub)regional assessments if an element (population and/or pressure) is only of national relevance. Ideally, the (sub)regional assessments are the basis for national assessments, e.g. that national assessments refer to or re-use (sub)regional assessments as they are, and complement them with additional elements, whilst seeking harmonisation with neighbouring countries (→ section 2.4).

Species assessments are based on population assessments. If more than one population occurs in a marine reporting unit, all populations/‘units to conserve’ must contribute to ensure that good status or favourable conservation status of a mammal species could be achieved within the Member State’s biogeographic marine region. If the assessment area of the population covers more than one reporting unit, assessment results for the population are applied to each reporting unit in which the population occurs.

»» Use of criteria

Use of D1 criteria in mammals’ assessment

Level of integration to classify status

Clear and transparent methods for an overall conclusion on the extent to which GES is achieved are necessary and need to be followed on both the regional and national scale. According to the GES Decision, criteria results should be integrated per species to reach an assessment of status at the element (species) level, before these results are combined to express the status of the species group (feature) level. The integration stops at the species group level. Species groups are not integrated to ecosystem component. However, integration from species group to ecosystem component could be beneficial for the purpose of communication, i.e. to present assessment results to decision-makers and public (Dierschke et al., 2021).

Integration from indicators to criteria

If more than one indicator is used for a criterion, other integration methods than OAO between indicators up to criteria level could be used and should be agreed regionally.

Integration from criteria to species

According to the GES Decision, integration between criteria follows the Habitats Directive. Under the Habitats Directive, the conservation status of a species is assigned at parameter level (population, range, habitat, and future prospects). The parameters are evaluated per species by assigning the conservation status of a species as ‘favourable’ (green), ‘unfavourable-inadequate’ (amber), ‘unfavourable-bad’ (red) and ‘unknown’ (grey) at parameter level and across parameters (overall conservation status) using a conditional approach (DG Environment, 2017; Dierschke et al., 2021). Based on this, only ‘favourable’ (green) would translate into good status of a species under MSFD.

⁹⁶ Detailed guidance on linking regional assessments and national reporting is subject to ongoing discussions in WG DIKE in the process of updating EU MSFD CIS Guidance Document No. 14 on Article 8 MSFD reporting.

The overall status of species covered by the Habitats Directive should be derived using the method provided under that Directive: For a favourable conservation status under the Habitats Directive, at least three parameters need to be favourable, and the fourth either unknown or favourable. Bycatch is not assessed as a specific parameter under the Habitats Directive. The integration of the additional criterion D1C1 should be based on an agreed conservation objective.

The use of the conservation objective *‘Minimise and where possible eliminate incidental catches of all marine mammal species such that they do not represent a threat to the conservation status of these species’* as proposed within OSPAR and HELCOM, implies an integration using the OAO principle between criterion D1C1, when assessed, and other primary criteria under Descriptor 1 because in the case that the threshold for the bycatch criterion is exceeded, the conservation status would be compromised.

Indicators relevant for criterion D1C3 are usually not assessed under the Habitats Directive as part of the parameter ‘population’. If it is deemed necessary to assess this criterion, D1C3 should be treated equal to other used criteria in the conditional integration approach.

If red-listed species (or units to conserve) cannot be assessed due to lack of data for all criteria used, they are treated as not in good status because their red-list status is based on scientific criteria such as low population size and declining trend in population size (Dierschke et al., 2021).

If a primary criterion cannot be assessed for a species due to a lack of data, the resultant assessment of that criterion for the species cannot be assigned a status (i.e. status ‘unknown’). ‘Not assessed’ should be selected in situations where a criterion is deliberately not used (→ section 2.2.7).

It is important to keep the lack of confidence in the assessment in mind if essential parameters are missing, i.e. abundance or range. Furthermore, a scientific judgement of status for the species may be possible if information on no more than one of the five criteria is missing. However, it also means that the Member State (maybe together with other Member States) should act on monitoring and assessment tools to ensure that at the next update under Article 8 MSFD an assessment of the criterion can be undertaken. This is also in line with the Biodiversity Strategy for 2030, according to which there should be no unassessed species by 2030.

Integration from species to species group

All species within a species group must be in good status. This includes the need to reach or maintain favourable conservation status according to the Habitats Directive.

Figure 5.2-1 summarises the levels and methods for integration for the assessment of mammals under Descriptor 1.

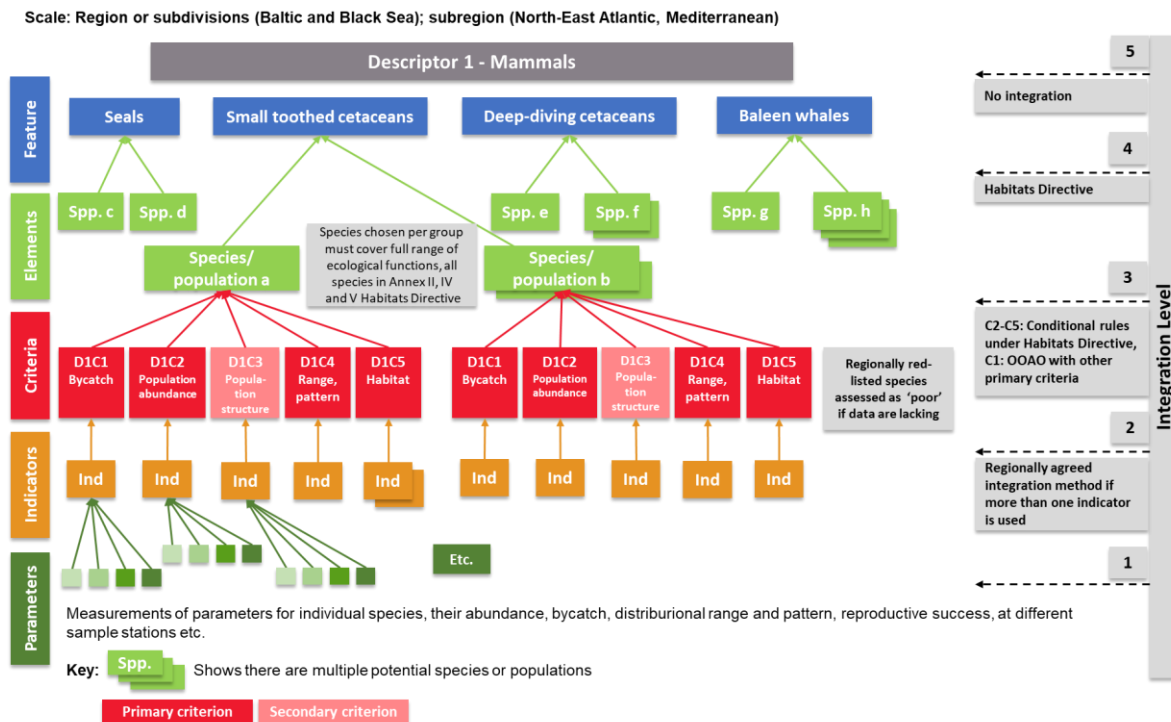

Figure 5.2-1: Levels and methods of integration for mammals under Descriptor 1.

Voluntary integration from species group to ecosystem component

This integration step is not required by the GES Decision. However, a Member State may wish to do so to help with the presentation of assessment results to politicians and the public. It is considered that no species group can replace another species group in the ecosystem, because each species group is representing a particular functional role in the marine ecosystem. Therefore, it is suggested that an ecosystem component cannot be considered to be in good status if one or more of the assessed species groups are not in good status.

Use of criteria from other Descriptors in mammals' assessment

Assessments of adverse effects on species under other Descriptors (→ Descriptor profile for D1 Mammals) are not integrated with the Descriptor 1 assessments, but the information they provide should help interpreting the assessment of status at species and species group level, as relevant. For example, in cases where criteria under other Descriptors assess anthropogenic mortality (such as lethal impacts of marine litter, e.g. strangling animals, acute oil pollution or explosions), the information should be included to complement the assessment of bycatch mortality under criterion D1C1. Likewise, information from other Descriptors can be included in a similar way into the presentation of assessment results at criterion level. However, it is not used as independent criterion in the integration on the status of species (Dierschke et al., 2021).

More specific guidance on linking assessment results under other Descriptors with the status assessment of mammals still needs to be developed.

»» Confidence

The confidence level of all assessments should be considered. While individual indicators discuss data quality and include confidence intervals in their assessments of species, there is yet no statistical approach to take into account such uncertainties at criteria level and integration to the level of species groups.

Until a statistical framework is developed for expressing confidence of species group assessments, a qualitative approach should be applied by experts. They aggregate their judgements about the validity of assessments by evaluating both evidence of the assessment and agreement (Figure 2-6; → section 2.2.8). Confidence varies due to the flexibility in the relationship between evidence and agreement.

» Visualising assessment results

The assessment output for mammals is presented for the marine region or its subregions or subdivisions:

- by criterion for each species
- as the overall status of each species
- as the overall status of the species group

These assessment results are best shown in a comprehensive table (with extended results given in annex tables), see an example in Table 1.2-2.

Table 1.2-2: Assessment results are based on the current assessment according to Article 17 Habitats Directive (2013). Status: Green = favourable according to the Habitats Directive/good according to the MSFD, amber = unfavourable-inadequate according to the Habitats Directive/not good according to the MSFD, dark red = unfavourable-bad according to the Habitats Directive/not good according to the MSFD. Grey = not assessed or unknown. Trend (Ellwanger et al., 2015): ↑improving, ↓deteriorating, ↔stable.

Species group	Species	D1C1 Anthropogenic mortality	D1C2/D1C3 Population	D1C4 Distribution	D1C5 Habitat	Future Prospects	Overall status (Habitats Directive)	Status of the species (MSFD)	Change in status
Species group 1	Species 1	Grey	↑	↑	↑	Green	Green	Green	↑
	Species 2	Grey	↑	Green	↔	Green	Green	Green	↑
Species group 2	Species 3	Grey	↔	↔	↔	Yellow	Yellow	Red	↔
...

In addition, a summary can be provided in a bar chart for the four individual species groups showing the fraction of overall species status good (green), not good (red) or not assessed (grey) as illustrated in Figure 5.2-3. The status of the four species groups can be shown in a pie chart (Figure 5.2-2). The status of the ecosystem component is not addressed in the MSFD assessment. Therefore, no such illustration is required.

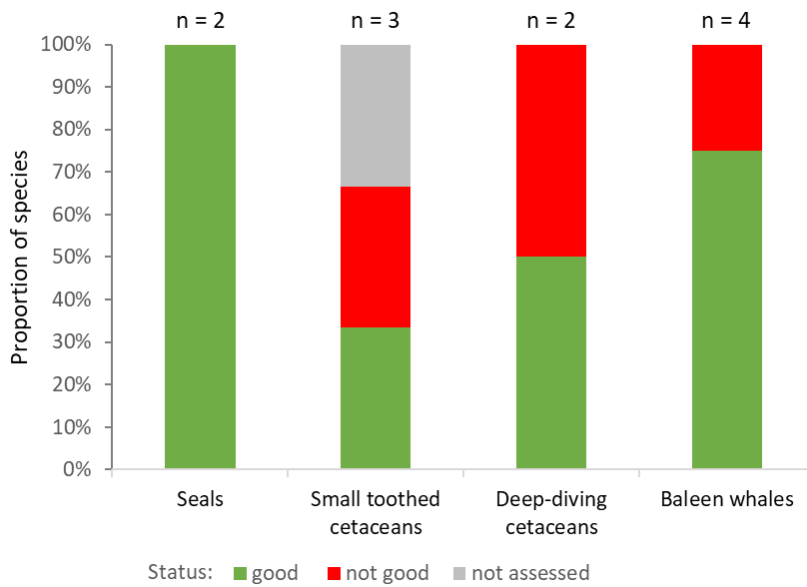

Figure 5.2-2: Proportion of species and populations per species group which are in good, not in good status or not assessed or unknown.

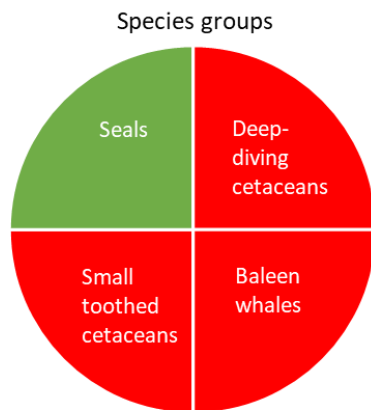

Figure 5.2-3: Status for the four species groups.

»» Gaps in knowledge and outstanding issues

Gaps in knowledge

- Data availability:** Existing indicators are not sufficiently supplied with data. This concerns the number of species for which data are collected in the indicator frameworks, and the time series that extend insufficiently into the assessment period. Particularly in the case of criterion D1C1 (bycatch), it is noticeable that almost none of the Member States carries out suitable monitoring to be able to assess this criterion. All Member States are legally required to collect and provide sufficient data quality and quantity for future assessments (e.g. DCF, Article 12 Habitats Directive). Onboard observer programmes under the DCF, however, currently focus on trawl fisheries with set net fisheries being monitored at a particularly low rate so that data cannot be used for bycatch assessments. Furthermore, a better coverage is needed to enable the necessary population models for the assessments. Strandings are an important source of information on marine mammal bycatch that should also be considered.

Even fishing effort data reporting is incomplete. Fisheries monitoring must be regulated so that it is usable for MSFD assessment. There is a need to harmonise monitoring obligations and make clear references to MSFD in Commission Delegated Decision (EU) 2021/1167) and Commission Decision (2010/93/EU).

Specific data gaps are as follows:

- For seals there is no offshore monitoring and assessments are currently based on counts on land.
- For harbour porpoises the critically endangered Baltic Proper population has only been completely surveyed once. Subsequently, only some Member States have continued monitoring.
- For offshore cetacean species there is no systematic monitoring.
- **Coverage of criteria by indicators:** In all marine regions, the five criteria are incompletely populated with indicators. As a result, the assessments are mainly based on assessments under the Habitats Directive. D1C1 is not covered by a parameter of the Habitats Directive and requires a separate indicator.

Outstanding issues

Further guidance is required on:

- Visualisation of assessment results for criteria from other Descriptors
- Relationship between regional and national assessments
- Inclusion of supplementary national indicators
- Seals, for which habitat and distribution are difficult to define based on haul-out surveys
- Many cetaceans, for which habitat and distribution are difficult to define in absence of systematic offshore data
- How to deal with data-poor species
- D1C4, for which there is currently no good method to determine distribution status. Therefore, a threshold value for the distribution cannot be proposed for all species. Distribution or range changes should serve as warning signals, but more research will be needed about the causes of such changes.

There is a need to harmonise the timing of MSFD reporting and Habitats Directive reporting. On a longer term also timeframes and schedules for assessment should be harmonised between Habitats Directive and MSFD. Ongoing review processes on reporting formats should take these needs into account and ease the way towards a single common reporting of biological components in Habitats Directive and MSFD.

5.3 Descriptor 1: Reptiles

Descriptor 1: Biological diversity is maintained. The quality and occurrence of habitats and the distribution and abundance of species are in line with prevailing physiographic, geographic and climatic conditions. (MSFD Annex I)

DESCRIPTOR PROFILE		D1C1 Bycatch	D1C2 Abundance	D1C3 Demography	D1C4 Distribution	D1C5 Habitat
Feature		Turtles				
Primary criterion		X	X		X	X
Information type		Impact	State	State	State	State (species)
Annex III MSFD	State (Table 1)	Species / Reptiles				
	Pressure (Table 2a)	Biological Extraction of, or mortality/injury to, wild species (by commercial and recreational fishing and other activities)	Input or spread of non-indigenous species; Input of microbial pathogens; Disturbance of species (e.g. where they breed, rest and feed) due to human presence; Extraction of, or mortality/injury to, wild species (by commercial and recreational fishing and other activities); Physical loss (due to permanent change of seabed substrate or morphology and to extraction of seabed substrate); Input of other substances (e.g. synthetic substances, non-synthetic substances, radionuclides) – diffuse sources, point sources, atmospheric deposition, acute events; Input of litter (solid waste matter, including micro-sized litter); Input of anthropogenic sound (impulsive, continuous)			
	Activity (Table 2b)	Extraction of living resources	Physical restructuring of rivers, coastline or seabed (water management); Extraction of non-living resources; Production of energy; Extraction of living resources; Transport; Tourism and leisure; Military operations (subject to Article 2(2)); Education and research			
GES Decision	Elements	(sub)regional	(sub)regional	(sub)regional	(sub)regional	(sub)regional
	Threshold values	(sub)regional	(sub)regional	(sub)regional	(sub)regional	
	Use of criteria	EU	EU	EU	EU	EU
Criteria linkages		D8C4, D10C4, 11C1	D3C1, D4C1*, D4C2*, D4C3*, D4C4*, D8C2, D8C4, D9C1, D10C3, D10C4, D11C1, D11C2	D3C1, D4C3*, D4C4*, D8C2, D8C4, D9C1, D10C3, D10C4, D11C1, D11C2	D3C1, D6C3	D3C1, D6C3, D10C3, D10C4
Descriptor linkages		D8, D10, D11	D2, D3, D4*, D8, D9, D10, D11	D2, D3, D4*, D8, D9, D10		

*Not included in the GES Decision

» Elements

Reptiles are relevant for determining and assessing good environmental status only for parts of the North-East Atlantic and the Mediterranean Sea, not for the Baltic and Black Seas.

Member States should first draw up a list of the turtle species that need to be considered, through regional or subregional cooperation. The main scientific criteria for selecting species set out by the GES Decision should be taken into account.

The species can be drawn from the Habitats Directive under which all species listed in Annex II and Annex IV should be considered (where relevant):

- Annex II: loggerhead turtle and green turtle
- Annex IV: loggerhead, green, leatherback, Kemp's ridley and hawksbill turtles

These species are also listed under the Regional Sea Conventions and IUCN Red List. Palialexis et al. (2018) lists all marine turtles that should be considered for the MSFD and these are included in the → [enumeration list](#) of elements for Member States' EU reporting.

Species (elements) that should be selected for the assessment of reptiles include

- In the North-East Atlantic: the leatherback turtle, loggerhead turtle, green and Kemp's ridley
- In the Mediterranean Sea: the loggerhead turtle and green turtle

Although the hawksbill turtle is listed in Annex IV of the Habitats Directive, observations of this species in the North-East Atlantic and Mediterranean regions are rare. Insufficient data are available for the assessment of this species. Furthermore, considering that only the margins of the Regional Management Units (RMUs) for the North-East Atlantic species overlap with EU Member States' waters⁹⁷ (see Figure 5.3-1), only criterion D1C1 should be evaluated in this region. Biologically, it would not make sense to base the species assessment on the other criteria without considering the entire RMU. However, the abundance (D1C2), demographic parameters (D1C3), distribution (D1C4) and habitat extent (D1C5) should still be quantified, as resulting information will directly contribute to the assessment of D1C1 and the identification of pressures affecting these species. To do so, European and regional collaborations are encouraged.

Relevant regional indicators that are available should be identified and allocated to the relevant species and criteria. To date, no indicators have been proposed under OSPAR. In the Mediterranean Sea, regional indicators include:

- CI 12 under the Barcelona Convention for D1C1
- CI 4 under the Barcelona Convention for D1C2
- CI 5 under the Barcelona Convention for D1C3
- CI 3 under the Barcelona Convention for D1C4

For any remaining gap identified, use national assessments where available, pending the development of regionally coordinated assessments.

⁹⁷ Wallace et al., 2010: <https://doi.org/10.1371/journal.pone.0015465>

»» Assessment areas and scales

Information and dynamic link to scales used in the marine regions

The GES Decision sets out the broad scales for assessment which are the region or subregion of the North-East Atlantic or the Mediterranean Sea.

Within this frame, Member States should determine the appropriate ecologically relevant scales of assessment and assessment areas for each turtle species. RMUs (Figure 5.3-1) have been defined for the different sea turtle species and are considered equivalent to sub-populations. To date, RMUs are widely recognised as the best unit to evaluate the conservation status of sea turtles by the international community, including the IUCN Marine Turtle Specialist Group (MTSG). If the different populations cannot be identified (for instance using genetic tools), then the assessment should be carried out at the species level.

Whilst the assessment scale may differ between criteria depending on available data, it should be defined based on existing RMUs, keeping in mind that the extent of RMUs may be occasionally updated. Throughout the assessment, it is important to consider the extent of the different RMUs as, in some cases, the entire RMU will be contained within a MSFD region (e.g. Mediterranean green and loggerhead turtles), while in others only the margins of the RMU will overlap with MSFD regions (e.g. leatherback turtles in the Atlantic). These overlaps should be considered for the assessment, the monitoring and for the evaluation of the management programmes.

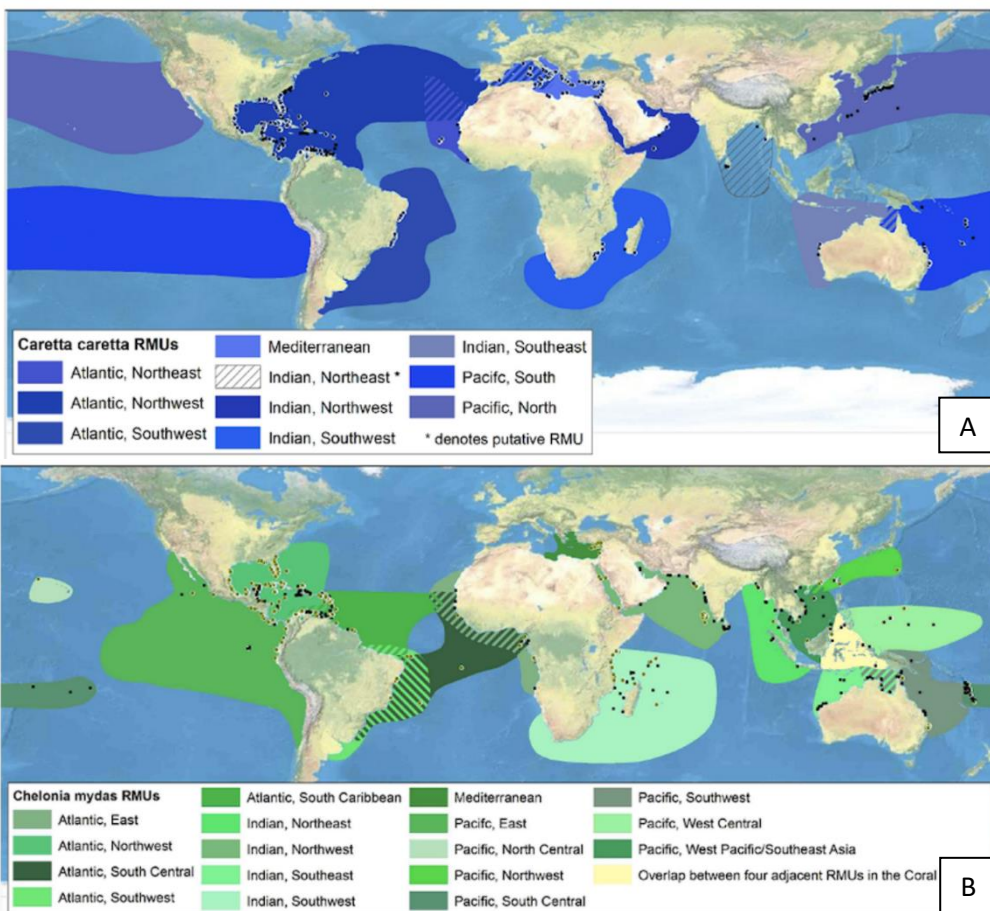

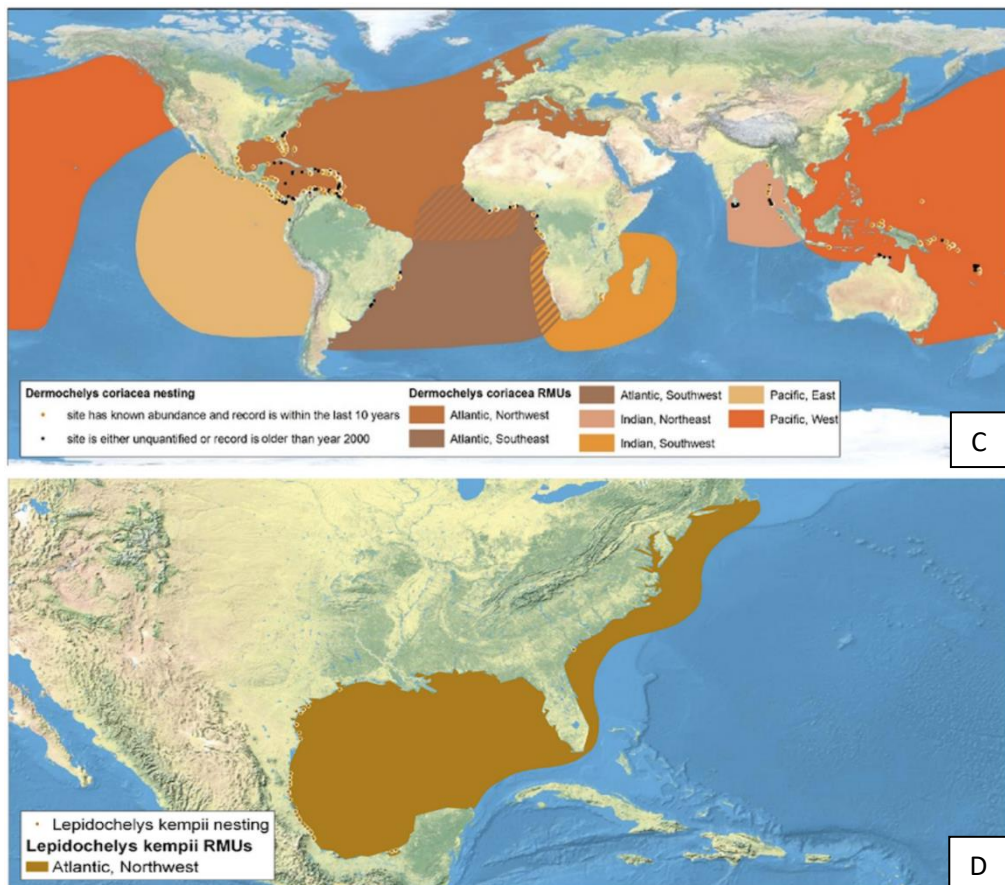

Figure 5.3-1: Regional Management Units (RMUs) for (A) loggerhead, (B) green, (C) leatherback and (D) Kemp's ridley turtles. Modified from Wallace et al. (2010).

Descriptor-specific guidance

If separate populations of a species exist, and can be discriminated, within a particular region or subregion, they should be assessed individually (e.g. three loggerhead sub-populations co-occur in the Mediterranean Sea).

Assessments carried out under the Habitats Directive should be used, accounting for the different assessment scales of the Habitats Directive and the MSFD⁹⁸:

- 'Population' for D1C2 and D1C3
- 'Range' for D1C4
- 'Habitat for the species' for D1C5

»» Temporal aspect of assessment

The six-year period for the assessment due for reporting in 2024 should be 2016–2021 and should be applied uniformly within and across marine regions. If this is not feasible, e.g. due to a mismatch between reporting periods of Habitats Directive and MSFD, differences in assessment periods may occur. For assessment period, trend assessment and change of status see → section 2.2.5 and 2.4. Specific guidance on temporal aspects of the assessment is still to be developed.

⁹⁸ Habitats Directive assessments are carried at national or subnational scale, whereas the MSFD assessments should be carried out at regional or subregional level, at ecologically relevant scales to the species (may involve assessment of smaller population units).

»» Spatial aggregation of assessment

Guidance is still to be developed.

»» Threshold values

Threshold values are agreed regionally for indicator assessments conducted on a regional scale. If national indicators are used, threshold values can be determined specifically. In principle, threshold values should be based on historical reference conditions. Where historical data are not available, the state of knowledge for certain periods of time (e.g. at the beginning of data series or before the beginning of a certain human activity) can be used as a baseline.

Threshold values should be connected to the conservation objective that the long-term viability of populations is not threatened. They are best defined by modelling population growth using demographic data from the respective populations and updates gained from the indicator assessments (also across indicators).

Criteria threshold values agreed at (sub)regional level

The regional indicators have agreed threshold values, but in the individual criteria the threshold values may vary between regions. Where population modelling is part of the indicator, the thresholds are species-specific. The threshold values are intended to indicate levels at which the long-term viability of a species is at risk.

Criteria	Thresholds
D1C1	Threshold values required No agreed developed thresholds
D1C2	No threshold values are needed. Assessment should be based on trends, which should account for the natural variation in population size and the mortality rates derived from D1C1, D8C4 and D10C4 and other relevant pressures
D1C3	Threshold values should take into account adverse effects on health derived from D8C2, D8C4 and other relevant pressures
D1C4	No threshold values. Assessment based on trends.
D1C5	No threshold values. Assessment based on trends.

Specific Guidance for D1C1

D1C1 relates to the proportion of the population estimated to have died due to incidental bycatch. Only the section of the population most at risk should be considered (e.g. individuals > 20 cm in the case of the Mediterranean Loggerhead population⁹⁹). Mortality rates, and all relevant indicators leading to their estimation, should be determined separately for juveniles and adults.

Indicators to measure D1C1 include:

- Population abundance estimate (number of individuals, see D1C2)
- Potential biological removal (PBR; number of individuals; estimated from demographic models)
- Bycatch rate (number of individuals dying from bycatch per observed fishing trip or day) per fishing technique
- Fishing effort (e.g. total number of fishing trips or days at sea) by fishing technique per year

⁹⁹ Casale, 2011: <https://doi.org/10.1111/j.1467-2979.2010.00394.x>

- Total bycatch (number of individuals dying from bycatch per fishing technique and per year) = bycatch rate x fishing effort
- Mortality rate from bycatch per fishing technique = (total bycatch/population estimate) x 100

It is noted that demographic parameters vary depending on the RMU considered. Therefore, separate demographic models should be developed for the different RMUs.

In case of partial overlap between the RMU for the species and the MSFD region (e.g. leatherback turtle in the North-East Atlantic region), where possible, population abundance estimates, and PBR, calculated for the entire RMU, should be used in the calculation of mortality rate from bycatch and the assessment of the criterion.

Criteria status			
Good	Good based on low risk	Not good	Unknown
Annual mortality rates from bycatch are decreasing over the six-year assessment period AND below reference value (removal target based on PBR).	Annual mortality rates from bycatch are stable or increasing over the six-year assessment period AND below reference value (removal target based on PBR).	Annual mortality rates from bycatch are above reference value (removal target based on PBR) during the six-year assessment period.	No or insufficient reliable information available.

Guidance for D1C2

Parameters to be considered for D1C2 are trend in population abundance at sea and trend in population abundance at nesting sites.

Indicators to measure D1C2 include:

- Abundance at sea estimated from aerial surveys, shipboard observation platforms (observers onboard ferries or fishing vessels), or other platforms using standardised protocols (e.g. number of individuals, density, number of individuals/observation effort). Potential estimation methods (data analysis): Distance sampling, density surface modelling or kriging
- Estimated abundance at nesting sites (e.g. number of nesting females, number of tracks or nests)
- Population abundance (including different life stages; at sea and at nesting sites) estimated from demographic models, taking into account mortality rates from bycatch (see D1C1)

Criteria status			
Good	Good based on low risk	Not good	Unknown
Increase in population abundance at sea over the six-year assessment period AND at nesting sites over the longest time series available. The outcomes of the different estimation methods must be in agreement.	The population abundance at sea over the six-year assessment period AND at nesting sites over the longest time series available is stable or increasing. The outcomes of the different estimation methods may not agree as long as no decline is detected.	Decline in population abundance at sea over the six-year assessment period AND/OR at nesting sites over the longest time series available.	No or insufficient reliable information available.

Guidance for D1C3

This criterion was only partially discussed during the workshops of a dedicated regional expert group (REG) and no consensus was reached.

A few options were discussed during the first REG Workshop in November 2019. For instance:

- The assessment of criterion D1C3 could be based on the evaluation of different demographic parameters (i.e. survival rate of different life stages, remigration intervals, number of clutches per year, sex ratio etc.). In particular, the number of recorded nests, used to infer the number of nesting females, has been proposed as a potential parameter for the assessment of D1C3.
- The assessment could be based on size distribution and estimation of the juvenile/adult ratio (cf. 'reaction norm of the size of sexual maturity' method developed by Girondot et al. (2021)).

At this stage the most coherent approach may be to continue to collect data in line with the IUCN MTSG reporting requirements, which includes biological parameters for demographic models.

Guidance for D1C4

Changes in the observed distributional range of the species between six-year assessment periods should be considered for D1C4 parameters. A different time period may be used for the assessment if biologically relevant. All life stages should be individually considered and different seasons should be evaluated separately.

Indicators to measure D1C4 include:

- Extent of observed species distributional range at sea (km² or number of occupied cells). Potential estimation methods (data analysis): Distance sampling, density surface modelling or kriging
- Extent of observed species distributional range at nesting sites (km² or number of occupied cells)
- Proportion difference in the extent of observed species distributional range between the current and previous assessment periods (considering all seasons and habitats)
- Proportion of the observed distributional range overlapping between the current and previous assessment periods (considering all seasons and habitats, normalised by observation effort)

Additional work will be required to determine the best assessment approach for this criterion. Biologically, changes in the species distributional range are difficult to interpret as they can be caused by a variety of factors (natural variations in the species distribution, direct or indirect response to climate change or other anthropogenic pressures etc.).

Regarding the proportion difference in the extent of observed species distributional range between assessment periods, the following potential assessment approach has been discussed:

Criteria status			
Good	Good based on low risk	Not good	Unknown
The extent of observed distributional range increases between six-year assessment periods.	The extent of observed distributional range remains stable between six-year assessment periods.	The extent of observed distributional range decreases between six-year assessment periods.	No or insufficient reliable information available.

The next step will be to agree on an ‘acceptable’ proportion of change that could be used as a threshold value to determine whether the status of this criterion is good or not good. The method currently employed for IUCN¹⁰⁰ assessments should be considered.

Similarly, the interpretation of a spatial shift in species distribution between assessment periods should be further discussed before recommendations can be issued.

Guidance for D1C5

D1C5 parameters may include changes in the extent of suitable habitat for a given population between six-year assessment periods. A different time period may be used for assessment if biologically relevant. All life stages should be individually considered, and different seasons should be evaluated separately.

Indicators to measure D1C5 include:

- Extent of suitable habitats (km² or number of occupied cells) at sea (developmental, foraging and wintering areas). Potential estimation methods: modelling approaches based on telemetry data and/or observations from aerial surveys/ferries
- Extent of suitable habitats (km² or number or number of occupied cell) at nesting sites
- Proportion difference in the extent of suitable habitats between the current and previous assessment periods (considering all habitats and seasons)

Criteria status			
Good	Good based on low risk	Not good	Unknown
The extent of suitable habitats is increasing between six-year assessment periods.	The extent of suitable habitats is stable between six-year assessment periods.	The extent of suitable habitats is decreasing between six-year assessment periods.	No or insufficient reliable information available.

As for criterion D1C4, it will be necessary to agree on a threshold proportion value to assess changes in the extent of suitable habitats. The approach developed for the assessment under Article 17 of the Habitats Directive¹⁰¹ should be considered.

»» Use of criteria

Use of D1 criteria in reptiles’ assessment

Criteria should be integrated within species, before species are integrated to species group. The overall status of the species group should be determined, based on the combination of outcomes per assessed species. Figure 5.3-2 shows the levels of integration and integration methods for reptiles. The same integration method as presented in this figure is to be used in each assessment area.

Although D1C3 is a secondary criterion, it is considered central to the assessment of the other criteria (e.g. D1C1 & D1C2) and should be used in assessments, if that is possible based on the availability of such data.

¹⁰⁰ IUCN, 2019: <http://www.iucnredlist.org/documents/RedListGuidelines.pdf>
¹⁰¹ DG Environment, 2017: <https://circabc.europa.eu/sd/a/d0eb5cef-a216-4cad-8e77-6e4839a5471d/Reporting%20guidelines%20Article%2017%20final%20May%202017.pdf>

Integration from individual parameters to a single one

This represents the Level 0 (not represented on the figure) of the integration method. Measurements of individual parameters — for example species distribution, abundance of individual species at different times of year in different locations etc. — are combined into a single parameter. This level of integration is not addressed in this Guidance.

It is noted that when several life stages, or different seasons, are considered in the assessment, the 'one-out all-out' (OOAO) approach should be employed (the status of all life stages, in all seasons, should be good for the criterion to achieve good status).

Integration from parameter to criterion

This is the Level 1 of the integration method. Where there is more than one parameter for a species for a particular criterion (e.g. different population abundance estimates for D1C2; Figure 5.3-2), the parameters are combined to form a judgement for each criterion. The integration rules at this level need to be further discussed.

Integration from criteria to species

This is the Level 2 of the integration method. The relevant criteria for each element (species) are integrated to form a judgement on the status for each species (different species may be represented by different numbers of criteria). The integration method is that used under the Habitats Directive (OOAO), and there must be information on at least three parameters (primary criteria) to provide a judgement of Favourable Conservation Status for a species, such that the species' status is consistent with that under the Habitats Directive. D1C1 contributes to the assessment of D1C2 for the corresponding species.

In the case where several RMUs (equivalent to sub-populations) for the same species (discrimination between populations possible with genetics) overlap within the same region, the OOAO approach should be employed to determine the status of the species (the status of all RMUs (sub-populations) should be good for the species to achieve a good status). More discussion is needed to tackle the inclusion of the secondary D1C3 in the integration, which can be ecologically more meaningful than other primary criteria (e.g. D1C4). The assessment results for marine birds and mammals should be considered.

Integration from species to species group

The results for each species are brought together to the species group (Level 3 of the integration method). The integration method should be agreed at Union level, taking into account regional or subregional specificities.

The OOAO approach is recommended. All assessed species should be at good status for the species group to achieve GES.

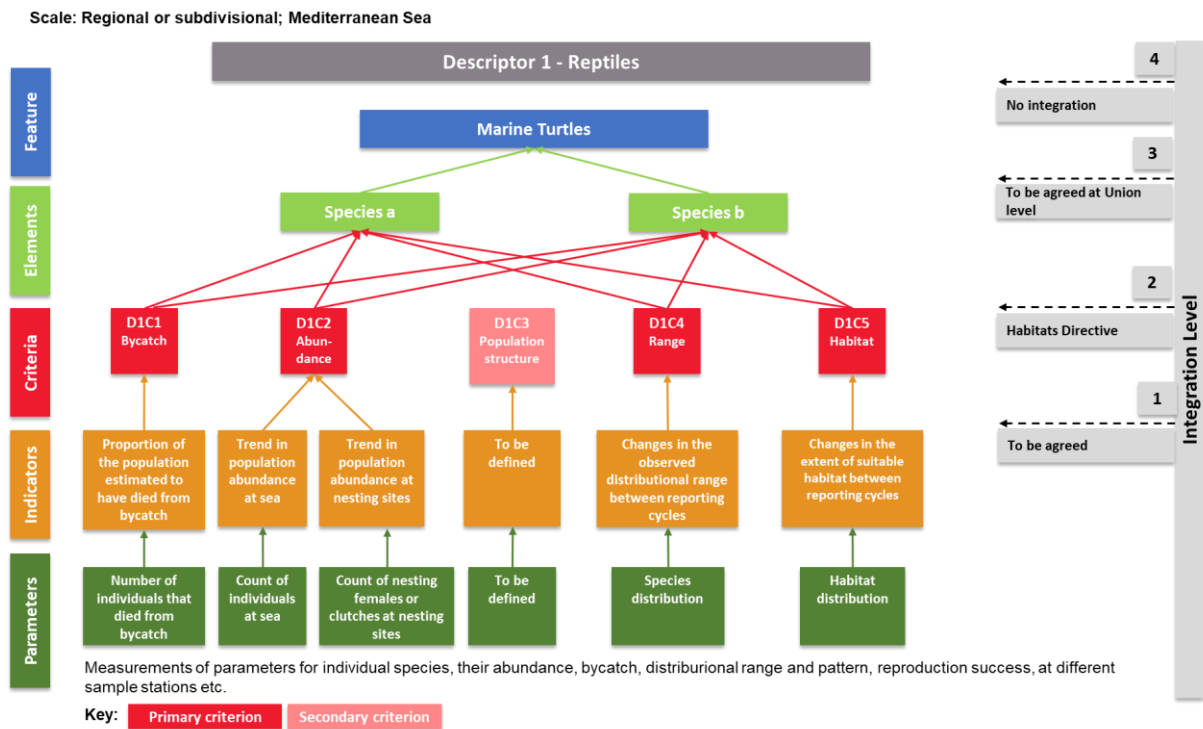

Figure 5.3-2: Levels and methods of integration for reptiles under Descriptor 1. D1C1 is primary for species identified as being at risk from incidental bycatch in the region or subregion (i.e. also included in the list of species for D1C1). Criteria from other pressure descriptors may also be taken into account when setting threshold values for D1C2 (e.g. C8C4, D10C4). Same method should be applied for the Mediterranean and North-East Atlantic region. Modified from Palialexis et al. 2016.

Voluntary integration from species group to the ecosystem component

This integration step is not required by the GES Decision. As there is only one species groups, a suggestion for voluntary integration across features (species groups) to the ecosystem component (Level 4 of the integration method) is not relevant.

Use of data from other legislation in reptiles' assessment

If a primary criterion cannot be assessed for a species due to a lack of data, then the resultant assessment of that criterion for the species cannot be assigned a status (i.e. it is 'unknown'). Under the Habitats Directive, a judgement of status can be provided for a species if there is information on at least three parameters (primary criteria), therefore a judgement of status for the species may be possible if information on only one criterion is missing. However, it also means that the Member State should take action on monitoring and assessment tools to ensure that at the next update under Article 8 MSFD an assessment of the criterion can be undertaken.

» Confidence

Guidance is still to be developed.

» Visualising assessment results

Guidance is still to be developed.

»» Gaps in knowledge and outstanding issues

This Guidance offers practical recommendations for the assessment of the different criteria for reptiles¹⁰². However, the publication of an additional document, including detailed methodological recommendations and lists of data requirements for the different approaches will be necessary to complement this guidance.

Gaps in knowledge

Data are needed to refine estimations of demographic parameters and improve demographic models. This work should be carried out as part of the ongoing IUCN MTSG effort and will eventually significantly contribute to the assessment of D1C1, D1C2 and D1C3.

Outstanding issues

- Close identified guidance gaps including on temporal and spatial aggregation, confidence and visualisation of assessment results.
- Agree on assessment and monitoring methods, in particular for secondary criterion D1C3.
- Finalise the assessment approaches for D1C4 and D1C5. In particular, agree on a threshold proportion to determine whether changes in the observed distribution (D1C4) and extent of suitable habitat (D1C5) between reporting cycles are significant.
- Ensure that the developed assessment and monitoring approaches are coherent with efforts of other international initiatives. In particular, the definition of habitats for D1C5 should be coherent with the Important Marine Turtle Area (IMTA) initiative. Moreover, MSFD assessments should rely on data collected at the RMU scale, in line with IUCN reporting. For instance, in the case of leatherback turtles, the estimation of mortality rates from bycatch, and the definition of threshold values to determine GES, should be based on population abundance estimates corresponding to the North-West Atlantic RMU.
- Need for a better harmonisation between the different environmental policies (EU Directives and Regional Sea Conventions). The development of indicators should align across policies. Whilst some MSFD criteria are equivalent to indicators used in the Habitats Directive and Barcelona Convention, a better harmonisation of the definition of these indicators will be required to ensure a common assessment. Moreover, to date, no indicators have been proposed under OSPAR for sea turtles.

A better synchronisation between reporting cycles under the different environmental policies should be ensured. Although significant effort has been made to synchronise reporting between the MSFD, Habitats Directive and, more recently, OSPAR (QSR 2023), reporting under the Barcelona Convention still does not match the MSFD cycle. Therefore, additional effort should be made to ensure that the same data can be used for the assessments of the different policies.

Having a common expert group for the different environmental policies would greatly facilitate this harmonisation, and the entire assessment process.

¹⁰² Supporting documentation on the guidance is still under development.

5.4 Descriptor 1: Fish

Descriptor 1: Biological diversity is maintained. The quality and occurrence of habitats and the distribution and abundance of species are in line with prevailing physiographic, geographic and climatic conditions. (MSFD Annex I)

DESCRIPTOR PROFILE		D1C1 Bycatch	D1C2 Abundance	D1C3 Demography	D1C4 Distribution	D1C5 Habitat
Features		Coastal fish; pelagic shelf fish; demersal shelf fish; deep-sea fish				
Primary criterion		X	X	(X)**	(X)***	(X)***
Information type)		Impact	State	State	State	State (species)
Annex III MSFD	State (Table 1)	Species / Fish				
	Pressure (Table 2a)	Extraction of, or mortality/injury to, wild species (by commercial and recreational fishing and other activities)	Input or spread of non-indigenous species; Input of microbial pathogens; Disturbance of species (e.g. where they breed, rest and feed) due to human presence; Extraction of, or mortality/injury to, wild species (by commercial and recreational fishing and other activities); Physical loss (due to permanent change of seabed substrate or morphology and to extraction of seabed substrate); Input of other substances (e.g. synthetic substances, non-synthetic substances, radionuclides) — diffuse sources, point sources, atmospheric deposition, acute events; Input of litter (solid waste matter, including micro-sized litter); Input of anthropogenic sound (impulsive, continuous)			
	Activity (Table 2b)	Fish and shellfish harvesting (professional, recreational)	Fish and shellfish harvesting (professional, recreational); Restructuring of seabed morphology, including dredging and depositing of materials; cumulative impacts of most human activities listed in table 2b: Renewable energy generation (wind, wave & tidal power); Extraction of minerals (rock, metal, ores, gravel, sand, shell); Extraction of oil and gas; Aquaculture; Land claim; Coastal defence and flood protection; Offshore structures (other than for oil/gas/renewables); Restructuring of seabed morphology, including dredging and depositing of materials; Military operations (subject to Article 2(2)); Tourism and leisure activities			
GES Decision	Elements	(sub)regional	(sub)regional	(sub)regional	(sub)regional	(sub)regional
	Threshold values	(sub)regional	(sub)regional	(sub)regional	(sub)regional	
	Use of criteria	EU	EU	EU	EU	EU
Criteria linkages		D3C1, D8C4, D10C4, D11C1	D3C2; D3C1 ; D2C3, D4C1*, D4C2*, D4C3*, D4C4*, D8C2, D8C4, D9C1, D10C3, D10C4, D11C1*	D3C3 D2C3, D3C1, D4C3*, D4C4*, D8C2, D8C4, D9C1, D10C3, D10C4	D2C3, D3C1, D6C1*, D6C2*, D6C3*, D6C4*, D6C5*	D2C3, D3C1, D6C1*, D6C2*, D6C3*, D6C4*, D6C5*, D10C3, D10C4
Descriptor linkages		D3, D8, D10, D11	D3, D2, D4, D6, D8, D9, D10, D11			

*Not included in the GES decision

** Primary only for commercially exploited fish species

*** Primary only for species covered by Annexes II, IV and V Habitat Directive

Note that cephalopods are not covered in this version of the Guidance given that to date no progress has been made to develop an assessment framework for this ecosystem feature. This was not a priority of MSFD CIS and regional work so far. However, cephalopods could be assessed using relevant methods described in this chapter.

Elements

The list of elements (fish species) chosen for the assessment should be a subset of the reference list for Article 8 reporting – fish. The assessment should be conducted for four different species groups:

- Coastal fish
- Pelagic fish
- Demersal fish
- Deep-sea fish

To all four fish species groups, relevant species have to be assigned:

So far, no clear definition of coastal fish is available. It is recommended to assign to this group fish species which are related to shallow, onshore habitats throughout their whole lifetime or during key stages of their lifetime.

It is recommended to include diadromous fish species in the species groups and mark them as such in the reporting. Alternatively, it should be discussed whether diadromous fishes could be defined as a fifth species group for assessment.

It might be necessary to differentiate between the assessment of bycatch (D1C1) and criteria D1C2.

This list of elements should be established through regional cooperation, preferably using regional seas conventions. The GES Decision requires to establish a list for each fish species group for each marine region, taking account of (sub)regional specifications and the most adequate ecological scale of the species group concerned. It is acknowledged that species composition can differ between areas within a subregion.

The species selected from the reference list should include species listed according to:

- Habitats Directive
- Common Fisheries Policy (Regulation (EU) No. 1380/2013)
- Other sources such as red lists or lists provided by the Regional Sea Conventions

For the Mediterranean Sea, an initial species list is already available under → [SPA/BD-UNEP/MAP & GFCN/FAO for Mediterranean](#).

The GES Decision requires that the selected species should be representative of the species group and their ecosystem functioning but should also be relevant for the assessment of anthropogenic pressure. The set of species selected per species group should cover, as far as possible, the full range of ecological functions of the species group.

These criteria might be difficult to apply to fish species and it could be necessary to conduct an expert judgement based on the reference list for Article 8 reporting. Preferably a scoring system is used to identify the most prioritised species for each species group. This process could be done based on an analysis of catch-profiles of the Gross métiers for a relevant assessment area, to identify more specific métiers (targeting certain species in certain habitats) and then look for the prioritised species for the assessment, participating in the relevant catches. These species could form the core of a subgroup (of coastal, or pelagic or benthic species of the continental shelf) which might also include commercial species. For further grouping of subgroups, comparison of the results of the first step might help to identify similarities within or across assessment areas through

regional cooperation, in which common priority species should be decided at the level of regional assessment.

In addition, technical criteria such as a) monitoring/technical feasibility, b) monitoring costs, and c) adequate time series of the data should be considered.

In relation to D1C1 (i.e. incidental bycatch of non-commercially exploited species of fish), Member States should draw up a list of the fish species at risk from incidental bycatch in the region or subregion, through (sub)regional cooperation. According to the Commission Delegated Decision on the CFP data collection framework (DCF) (currently Commission Delegated Decision (EU) 2021/1167, Table 2 (former 1D)) all marine species listed in Annexes II, IV and V of the Habitats Directive, i.e. all listed fish species, are to be monitored.

The selected species should reflect the métiers causing the greatest bycatch problem, and those species most affected, allowing efforts on data collection and assessment to be prioritised.

Not all fish species selected for the assessment of D1C2–D1C5 must be assessed under D1C1, depending on whether they are at risk of being adversely affected by bycatch or not. Therefore, it is necessary that all species that are assessed under D1C1 are included in the lists of species for D1C2–D1C5, to ensure an ecologically relevant assessment of the different fish species groups.

»» Assessment areas and scales

The scale of the assessment should reflect the distributional range of the species (populations) in the respective marine region and species group. Wherever possible use the same scale for all species within a species group. If species within a species group are assessed at different scales, results may need to be aggregated across spatial areas, or down-scaled to smaller spatial areas, to allow for integration of indicators and criteria on a harmonised spatial scale. In presence of shared stock assessments, the spatial scale should be agreed at (sub)regional level or should be consistent with the spatial range of distribution.

Furthermore, it is important to choose the smallest scale possible for the assessment to allow area-specific measures, if these are deemed necessary under Article 13 MSFD. Preferably, the scale chosen for both pelagic and demersal species should be the same. According to the GES Decision, it is recommended to use the following:

- Subdivision of relevant region for coastal fish
- (Sub)region or subdivision for demersal and pelagic fish species
- Region for deep-sea fish

In the case of species which are also assessed under Descriptor 3, it is important to choose assessment areas which are comparable or, if possible, identical to those used under Descriptor 3.

»» Temporal aspect of assessment

The six-year period for the assessment due for reporting in 2024 should be 2016–2021 and should be applied uniformly within and across marine regions. If this is not feasible, e.g. due to a mismatch between reporting periods of Habitats Directive and MSFD, differences in assessment periods may occur. For assessment period, trend assessment and change of status see → section 2.2.5 and 2.4.

In order to secure comparability between Descriptors 1 and 3 for those species assessed under both Descriptors the same integration method over time should be used.

»» Spatial aggregation of assessments

Spatial aggregation might be necessary where the ecologically relevant scales for the assessment could be smaller than the smallest reporting unit. Especially coastal fish species might be monitored at a local scale, e.g. specific bays or inlets. Results from this monitoring has to be aggregated towards relevant reporting units. A proportional method as applied for the integration of species up to species group level could be applied for the spatial integration in coastal areas. An example of a proportional rule could be that a percentage (for example 90 %) of the known key coastal water types in the respective (sub)region have to achieve good status for assessing the whole region or subregion to achieve GES. If such a rule is used, the percentage will have to be agreed through (sub)regional cooperation.

No need for spatial aggregation for the deep-sea fish species is foreseen, since the distributional range of these species corresponds with the assessment area. If there is a need to aggregate the assessment areas for pelagic and demersal species the proportional method as used for coastal fish species might not be practical, and 'one-out all-out' is recommended.

»» Threshold values

Threshold values are agreed regionally for indicator assessments conducted on a regional scale. If national indicators are used, threshold values can be determined specifically. In principle, threshold values should be based on historical reference conditions.

Thresholds values defined under Descriptor 3 for fish populations should be used for the assessment under Descriptor 1. If no threshold value is available for a fish population, threshold values should be established by Member States through (sub)regional cooperation. Threshold values should be defined using historic reference values or other baseline setting approaches linked to individual criteria (Table 5.4-1).

Table 5.4-1 : Direct links between criteria used in the assessment of fish under D1 and criteria from other descriptors and the Habitats Directive, indicating thresholds required by the GES Decision. Criteria missing in this table may link indirectly to the assessment. In the absence of threshold values, trend indicators could be used in accordance with the GES Decision (→ section 2.2.6).

Criteria	(sub)regional coordination	Link to other descriptor, criteria / EU legislation
D1C1	Yes, thresholds required	Possible link to D3C1
D1C2	Yes, thresholds required	<ul style="list-style-type: none"> ▪ Mortality rates (if available) derived from D1C1, D8C4 and D10C4 to be accounted for ▪ Link to D3C2 ▪ Favourable reference population values from Habitats Directive should be used, if species are assessed under Habitats Directive
D1C3	Yes, thresholds required	<ul style="list-style-type: none"> ▪ Health parameters are assessed: take account of assessments of criteria D8C2 and D8C4 ▪ Size parameters assessed: for commercially exploited species, thresholds defined for D3C3 should be used

Criteria	(sub)regional coordination	Link to other descriptor, criteria / EU legislation
D1C4	Yes, thresholds required	<ul style="list-style-type: none"> Thresholds to be consistent with favourable range values from Habitats Directive if relevant
D1C5	No thresholds required	<ul style="list-style-type: none"> If thresholds are defined: to be consistent with reference values from Habitats Directive, if relevant and linked to possible indicators/thresholds used for D6, D5 and D1C6

GES is assessed per species group (feature level). The assessment should apply a proportional method if at least five species of a species group can be assessed. The proportion is to be agreed through regional cooperation. ICES recommends a range of limits between 60–80%. In order to align with other species assessments, e.g. birds (→ section 5.1), a threshold value of 75 % could be used¹⁰³. However, this conditional rule is sensitive to the number of species in a species group. In species poor systems where only a representative share of species, i.e. less than five species, belong to a species group, ‘one-out all-out’ should be applied (→ ‘Use of criteria’ below).

»» Use of criteria

Use of D1 criteria

Both criteria D1C1 and D1C2 are primary and should be used in every assessment. If commercially exploited fish species are used in the D1 assessment, same results from D3 assessment should be used in D1 for specific criteria. Even for non-commercially exploited fish species, the assessment of the size distribution within species or populations, although being a secondary criterion, might be an essential parameter for the definition of GES and could be considered in the assessment. According to Article 3 of the GES Decision, secondary criteria should be used when there is a risk that good status is not achieved or not maintained for the respective criterion. Since most species might be impacted by selective extraction it is likely that size distribution is affected. It is up to the Member States to decide on the use of secondary criteria based on a risk assessment and through regional cooperation (→ section 2.2.1).

Integration from criteria to species

The criteria should be integrated using conditional rules (→ Figure 5.4-1). If criterion D1C3 is used, it should be treated equal to D1C2 and D1C1 (if used), which means that a ‘one-out all-out’ approach could be used in the absence of information from the criteria D1C1, D1C4 and D1C5. Table 5.4-2 gives an overview of possible scenarios for integration of primary and, depending on their use, secondary criteria.

Assessing D1C1 for a species would involve aggregating bycatch estimates from different métiers, as far as data is available, to give a mortality level per species before integrating to criterion level.

¹⁰³[https://www.ices.dk/sites/pub/Publication%20Reports/Expert%20Group%20Report/acom/2018/WKDIVERExtinct/01%20WKDIVERExtinct%20Report.pdf](https://www.ices.dk/sites/pub/Publication%20Reports/Expert%20Group%20Report/acom/2018/WKDIVExtinct/01%20WKDIVERExtinct%20Report.pdf)

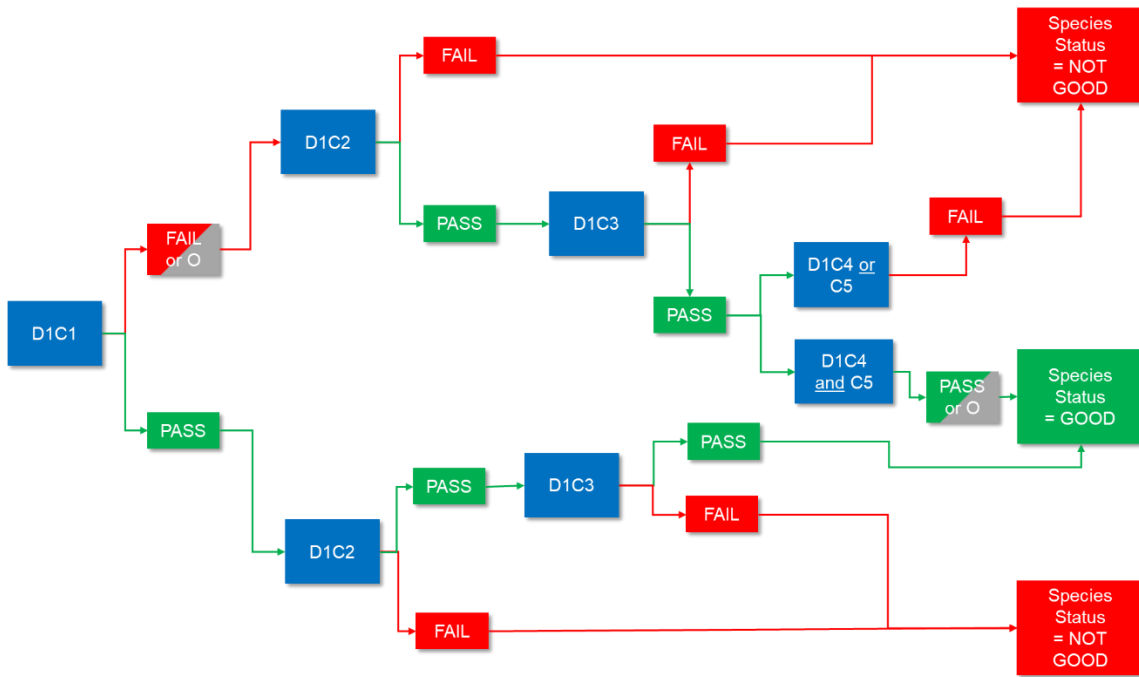

Figure 5.4-1: Conditional rules for integrating criteria to assess the status of fish species (see also Table 5.4-2). FAIL = Species is not reaching criterion (indicator) specific threshold values; O = Criterion/indicator is not assessed; PASS = Species is reaching the criterion (indicator) specific threshold values.

Table 5.4-2. All possible scenarios based on used criteria for the integration of the primary criteria D1C1, D1C2 and the secondary criteria D1C3-D1C5. Results marked with * will result in relatively low confidence compared to other options. N = criterion does not meet threshold; Y = criterion meets threshold and O = no status assessment for the criterion (i.e. ‘unknown’ (U) in case of lack of data/knowledge or ‘not assessed’ (NA) in case of element / criterion not included in assessment).

criteria	Assessment scenario												
	Fish 1	Fish 2	Fish 3	Fish 4	Fish 5	Fish 6	Fish 7	Fish 8	Fish 9	Fish 10	Fish 11	Fish 12	Fish 13
D1C1	N or O	N or O	N or O	N or O	N or O	N or O	Y	Y	Y	N	N	NA or U	NA or U
D1C2	N	Y or N	Y	Y	Y	Y	Y	N	O	O	Y	O	O
D1C3	Y or N	N	Y	Y	Y	Y	Y	Y, N or O	N	Y	O	O	O
D1C4	Y or N	Y or N	N	Y or O	N	Y	Y, N or O	Y, N or O	Y, N or O	Y, N or O	Y, N or O	Y	N
D1C5	Y or N	Y or N	Y or O	N	N	Y	Y, N or O	Y, N or O	Y, N or O	Y, N or O	Y, N or O	Y	N
species status	Not good	Not good	Not good	Not good	Not good	Good	Good	Not good	Not good	Not good*	Good*	U	Not good*

Integration from species to species groups

Populations (stocks) should be seen as independent assessment components in the assessment area concerned, i.e. all selected populations within an assessment area should be assessed separately and integrated for determining the status of the species group. If this is not possible, population (stocks) should be integrated to species level using ‘one-out-all-out’ before integrating species to species group.

It is suggested that critically endangered species or those upgraded to a higher risk class enter the integration from species to species group as species not in good status. However, still then alarms from species facing extinction might be obscured by other species of the same species group achieving good status. Therefore, it is recommended to attach 'red flags' to species classified from 'near threatened' to 'critically endangered'¹⁰⁴, to ensure that the signal of extinction risk remains visible throughout the integration process. In the MSFD framework this is required because status assessments under Article 8 trigger measures under Article 13 in cases of status not being good. Information about the need for measures should not be lost in the assessment.

The integration rule depends on the number of species covered by a species group to ensure satisfying confidence in the status assessment. Use conditional rules if at least five species are assigned to a species group. Use 'one-out all-out' if less than five species are assigned to a species group (e.g. in species poor regions and if only a representative share of species could be used).

Figure 5.4-2 summarises the levels and methods of integration for the assessment of fish species under D1.

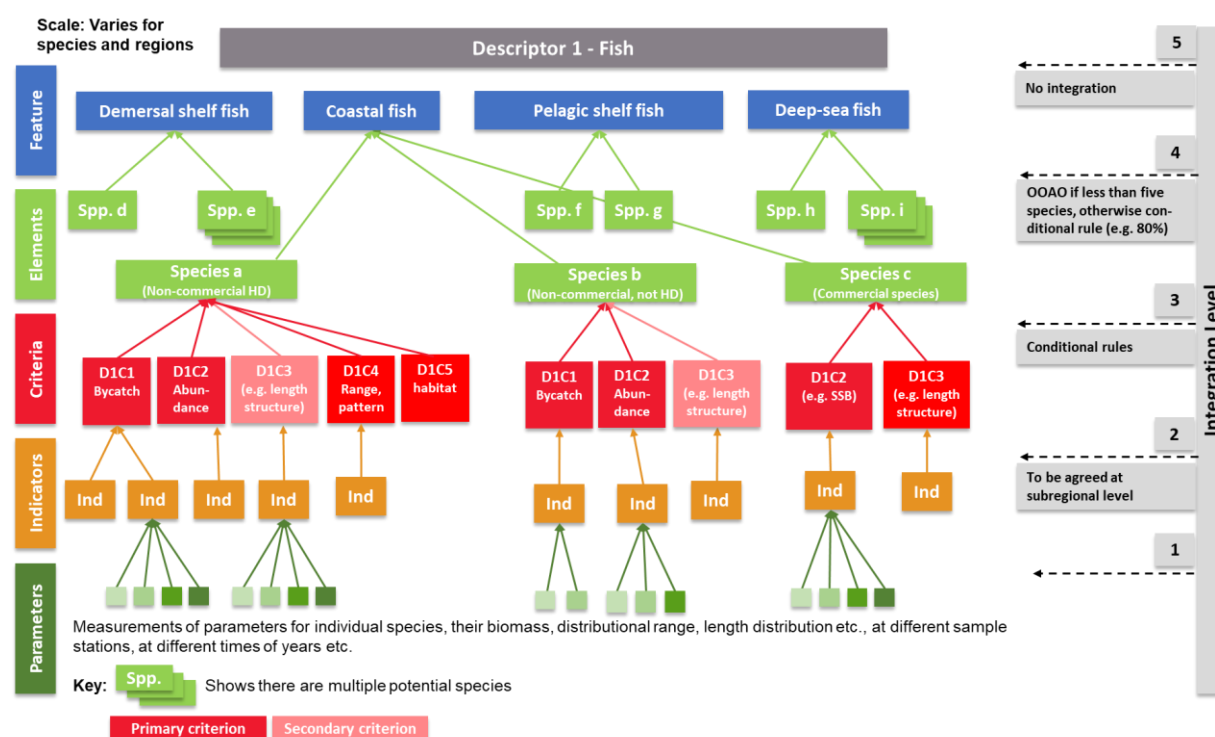

Figure 5.4-2: Levels and methods of integration for fish under Descriptor 1.

Voluntary integration from species group to ecosystem component

This integration step is not required by the GES Decision. However, a Member State may wish to do so to help with the presentation of assessment results to politicians and the public. It is considered that no species group can replace another species group in the ecosystem, because each species group is representing a particular functional role in the marine ecosystem. Therefore, it is suggested that an ecosystem component cannot be in good status if one or more of the assessed species groups are considered not to be in good status.

¹⁰⁴ IUCN, 2012: <https://www.iucnredlist.org/resources/regionalguidelines>

»» Confidence

Confidence could be defined at indicator level using statistical parameters of variance, preferably 95 % confidence interval (CI), if possible, to calculate from a time series or similar. The overall confidence for the GES assessment (feature level) should be given at least in three classes: high, moderate or low (→ section 2.2.8). A categorical approach integrating confidence is necessary, because it is likely that, besides quantitative assessments of indicators, including confidence, also expert judgement is used for some species (populations).

To judge confidence, it is important to consider the length of time series used, including quality of reference or baseline, i.e. relating to variations within, and to the length of, these time intervals. If available, also indicate the ICES data category (from category 1 'data-rich stocks' to category 5 'data-poor stocks') and whether and how expert judgement has been applied and conducted. Confidence level 'high' can only be achieved if all relevant criteria in the assessment of all species in a relevant species group have been assessed against quantitative threshold values using reliable time series.

»» Visualising assessment results

Presentation could be harmonised with the presentations of assessment results under Descriptor 3. Pie charts showing the proportion of species in good status, not in good status and not assessed or with status unknown could be used to illustrate results. Bar charts could be used to illustrate changes in status compared to the last assessment. Furthermore, list the species, especially those not in good status, together with the assessment results for the individual criteria. The tables allow to see which criteria caused the failure of a species to be in good status.

»» Gaps in knowledge and outstanding issues

Gaps in knowledge

Gaps in knowledge are diverse. Most dominant is the lack of knowledge concerning the impact of different pressures. It is not trivial to assess the relative impact of pressures from hazardous substances (D8C4) or marine litter (D10C2) on the abundance of different species or populations. Furthermore, indicators to assess size distribution might still be missing or are under development, in particular for the definition of threshold values. Even indicators describing the quality of habitats and distributional range are under development. Whether these assessments are needed for all species requires discussion in the future. Quantification of bycatch rates for rare species is also very challenging.

Outstanding issues

- Consider whether diadromous fishes should be assessed as a separate fish species group.
- How to deal with bycatch (or even targeted catch) of vulnerable commercially exploited species and particularly in case where there is still no assessment under D3C1?
- Proportion of species needed to achieve their criterion (indicator) specific threshold value per species group.
- Integration of stocks/populations to species level.
- Spatial aggregation for both demersal and pelagic fish species.
- Quantitative estimation of confidence in the assessment, i.e. statistical integration of all parameters possibly contributing to confidence in the assessment.

5.5 Descriptor 3: Commercial Fish and Shellfish

Descriptor 3: Populations of all commercially exploited fish and shellfish are within safe biological limits, exhibiting a population age and size distribution that is indicative of a healthy stock. (MSFD Annex I)

DESCRIPTOR PROFILE		D3C1 Fishing mortality (F)	D3C2 Spawning stock biomass (SSB)	D3C3 Age and size distribution
Feature		Commercially exploited fish and shellfish		
Primary criterion		X	X	X
Information type		Impact	State	State
Annex III MSFD	State (Table 1)	Stock	Stock	Stock
	Pressure (Table 2a)	Extraction of or mortality/injury to wild species including target and non-target species		
	Activity (Table 2b)	Fish and shellfish harvesting (professional and recreational)		
GES Decision	Elements	(Sub)regional	(Sub)regional	(Sub)regional
	Threshold values	EU	EU	(Sub)regional
	Use of criteria	EU		
Criteria linkages		D1C1	D1C2, D4C1, D4C2	D1C3, D4C3
Descriptor linkages		D1, D4*		

*Not included in the GES Decision

»» Elements

Definition of commercially exploited species

The regional list of commercial species is defined by identifying the minimum number of species/stocks that together contribute to a regionally agreed percentage of reported (sub)regional landings by weight. The agreed percentage should not be less than 90 %. Additionally, species/stocks that contribute to a regionally agreed percentage of reported regional landings by value can be added.

The estimation should be based on a (sub)regionally coherent collection of fisheries dependent data for a time period which represents a relevant reference period in relation to fisheries pressures, but at least covering the last six-year assessment period (e.g. 2016–2021). Guidance on an appropriate reference period is expected to be developed further as part of the ICES advice request (expected to deliver in 2022) on a reference list for Member States to use when agreeing region-specific lists of commercial fish stocks for D3 assessments through (sub)regional cooperation.

The list of commercially exploited species/stocks is identified at regional level unless a subregional level is deemed more ecologically relevant for the region. Individual Member States can choose to add species/stocks of national relevance to the regionally agreed list of commercially exploited stocks/species or not to assess a species on the regional list if not relevant in a Member State's waters (→ sections 2.2.2). Further guidance on criteria for selecting stocks for the purpose of national reporting under Article 8 MSFD is expected to be developed as part of the ICES advice request (expected to deliver in 2022) on a reference list on elements for D3. For guidance on the relationship between regional assessments and national reporting see → section 2.4.

The selected species/stocks should remain on the list even if not contributing to the agreed percentage in subsequent MSFD assessments. However, if it can be clearly demonstrated that a stock has consistently achieved good status and the lack of contribution to the agreed percentage is caused by the species/stock no longer being fished at noticeable levels, the species can, after regional agreement, be removed from the list. Species/stocks which have been commercially important in previous MSFD assessments but are currently at very low abundance due to previous fishing impact should be retained on the regional list of commercially exploited species/stocks.

Species/stocks which are both on the list of commercially exploited species/stocks and on the list of fish species for the purpose of biodiversity assessment under D1 should be integrated under D1 using the assessment status determined under D3. If a species included under D1 is divided into two or more stocks within the MSFD assessment area, only part of these stocks may be included in the list of commercially exploited species assessed under D3; the remaining stocks should be assessed under D1.

Further guidance is expected to become available on defining fish species groups under D1 (such as 'coastal fish', → section 5.4) and on the assignment of commercial species to these groups.

Data used and appropriate indicators

D3 status is assessed based on stock assessment results from ICES (North-East Atlantic), GFCM (Mediterranean and Black seas), ICCAT and NEAFC wherever these are available. Stocks that are not assessed by ICES, GFCM, ICCAT or NEAFC can be assessed by Member States following the principles of stock assessment outlined by any of the three bodies as well as the guidance given in this document. Data should be collected according to agreed standards for MSFD regions. The data for a stock to be assessed should, as a minimum, include information on either annual total catch as well as information on length distribution of catches, or annual total catch and time series of biomass/abundance indices.

»» Assessment areas and scales

The status of individual commercial stocks/species should be evaluated and reported at the level of the stock, whereas the integrated D3 assessment should be conducted at the spatial scale most relevant to most of the stocks/species in each spatial assessment area, which may correspond to an MSFD region, combined regions, a subregion, or (if relevant) a smaller unit (e.g. national waters for local fish species). In cases where stocks/species occur in wider areas, they should be assessed in all assessment areas in which they occur and are included on the regionally agreed list. This means that widespread stocks may contribute to the D3 status assessment in more than one assessment area, as well as region.

»» Threshold values

For GES and threshold values use ICES' latest approach and advice.¹⁰⁵ The description below relates to the current approaches defined by ICES, GFCM, ICCAT or NEAFC for D3C1 and D3C2 and (sub)regionally agreed values for D3C3.

For stocks for which regionally agreed values are not available for D3, national threshold values can be used provided they are based on regionally agreed best available knowledge and approaches.

¹⁰⁵ https://www.ices.dk/sites/pub/Publication%20Reports/Advice/2021/2021/Advice_on_fishing_opportunities.pdf

Guidance for criterion D3C1

The indicator used to assess status under D3C1 is the fishing mortality rate of the stock, and this indicator should be at or below the fishing mortality which in the long term leads to maximum sustainable yield (MSY), F_{MSY} . Alternative thresholds to F_{MSY} can be used in cases where a full management strategy evaluation (as conducted in support of e.g. the CFP or a multiannual plan (MAP)) has shown that these are more appropriate with respect to obtaining MSY and maintaining full stock productivity potential.

To support alignment between the MFSD and the CFP, the average F over the six-year assessment period for the MSFD should not exceed the F_{MSY} .

For exploited stocks which remain below levels at which recruitment is considered impaired (B_{lim}), measures should be taken to reduce F (see e.g. MAPs/CFP). To fulfil the requirement for reduced pressure, the F threshold for such stocks must be lower than F_{MSY} . In such cases, the F threshold could be defined as linearly decreasing below MSY $B_{trigger}$. Hence, if biomass on average was 80 % of MSY $B_{trigger}$ in the assessment period, the F threshold would be 80 % of F_{MSY} .

F_{MSY} estimation is not simple for stocks which do not have full age-, length- or biomass-based assessments. For these stocks, a variety of proxies are available depending on the existing information (e.g. Chong et al., 2020; Arkhipkin et al., 2021; Armelloni et al., 2021; ICES, 2021a). A recommendation of methodological approaches should be addressed in a future update of this guidance document.

For short-lived species, for which recruitment is highly variable, the biomass can fluctuate widely between years even in the absence of fishing. Applying the precautionary principle to attain MSY in this situation implies that a minimum stock size, $B_{escapement}$, should remain in the sea every year after fishing. This biomass is consistent with a less than 5 % risk that future recruitment is impaired. Fishing opportunities are defined to target this biomass with additional precautionary restrictions where this is deemed necessary.

Guidance for criterion D3C2

The indicator used to assess status under D3C2 is the spawning-stock biomass (SSB) of the stock, and this indicator should be above biomass levels capable of producing MSY. The CFP and the associated MAPs refer to biomass thresholds in accordance with ICES MSY approach, something that is also being applied in the Mediterranean context (e.g. MAP in the Western Mediterranean Sea, 2019). ICES MSY approach defines the biomass capable of producing MSY as the highest values of these two:

- The lower 5th percentile of the projected annual biomass of a stock fished for long time periods at F_{MSY} (MSY $B_{trigger}$). This value accounts for the natural variability in biomass caused by e.g. variation in recruitment and growth in a stock fished at F_{MSY} .
- The biomass required to ensure that recruitment is impaired (below B_{lim}) in 5 % or less of the years in the long-term projection (B_{pa} ; ICES, 2021a), i.e. $B_{threshold} = \max(B_{pa}, MSY B_{trigger})$.

Alternative approaches to identify thresholds can be used in cases where a full management strategy evaluation (as conducted in support of e.g. the CFP or a MAP) has shown that these are more appropriate with respect to obtaining MSY and maintaining full stock productivity potential. In the absence of information on B_{lim} , B_{pa} , and MSY $B_{trigger}$, regionally agreed proxies of unfished biomass can be used as the basis for estimating the biomass threshold (e.g. $B_{lim} = 0.2 * B_{oproxy}$, $B_{pa} = 2 * B_{lim}$; see also the approach from FAO-GFCM (2014)).

For short-lived species, the biomass threshold is defined in relation to a target, with B_{pa} representing a level to ensure MSY with a 95 % probability of not adversely affecting recruitment (ICES, 2021a). For other stocks, the biomass threshold $B_{threshold}$ sometimes represents a limit that should not be subceded on average in simulations to determine F_{MSY} . These considerations would also apply for stocks if there was a perfect understanding of stock dynamics and perfectly implemented management. To accommodate this interannual variability, the average biomass over the six-year assessment period for the MSFD for all stocks (short-lived or otherwise) should not be less than the biomass threshold though this may occur in individual years as a result of the conditions laid out in the CFP and MAPs.

For stocks which do not have full age-, length- or biomass-based assessments, $B_{threshold}$ estimation is not simple. For these stocks a variety of proxies can be used depending on the information available (Chong et al., 2020; Arkhipkin et al., 2021; Armelloni et al., 2021; FAO WGSAD, 2021; ICES, 2021a), including but not limited to biomass-related indices such as catch per unit effort or survey abundance indices. Results should be reported in a way that reflects on potential biases and limits to interpretation with respect to the data used as well as confidence in the methods, and threshold values should be provided. Examples of some application at regional level may be found in the Mediterranean Ecological Quality Status Report (UNEP, 2017).

Certain stocks/species which are severely depleted compared to historical levels may not have sufficient information for a full analytical assessment with associated thresholds. Rather than reporting SSB for such stocks as 'unknown', these species could be evaluated as having 'biomass depleted below the last estimated reference level' with an associated estimated confidence in that rating based on the data and information available. For example, if survey catches of the species have not increased, it is unlikely that the stock has rebuilt.

Species which have historically been lightly fished, and for which biomass indices from surveys can be assumed to be indicative of unfished biomass for at least some years of the time series, are typically not the target of directed fisheries. As bycatch species, they may be more or less sensitive to fisheries. Species which are not sensitive (ICES, 2021b) and which are only lightly impacted by fisheries can possibly be evaluated by regional expert judgement (far from likely reference points; close to likely reference points) provided that the results are reported with a clear indication of the quality of this information. In case of doubt, the evaluation for D3C2 should be reported as 'unknown'.

Guidance for criterion D3C3

Approaches to define threshold values for D3C3 indicators have yet to be agreed. A request for ICES advice is planned for 2022 with the aim to support future discussion and agreement on the assessment of D3C3.

When developing D3C3 indicators, compatibility between any threshold values of D3C3 and the threshold values of criteria D3C1 and D3C2 should be ensured to ascertain that all criteria can in fact be attained simultaneously. The current guidance does not address which criterion to adapt, i.e. which criterion should take precedence if two criteria are in conflict.

The status should be evaluated using the average over the six-year assessment period for the MSFD as status in individual years may fall on either side of the threshold due to natural variability, and it should be considered that both very high and very low values might be undesirable for certain indicators.

Comparisons of D1 and D3 show that the formulations of criteria D1C3 and D3C3 differ in their contents, with D3C3 being considerably more restrictive than D1C3 as it pertains only to changes in stock size and age structure whereas D1C3 also pertains to species productivity. As several commercial stocks have exhibited changes in stock productivity due to e.g. changes in individual growth, condition, maturity, recruitment, and mortality, it is recommended to expand the focus of D3C3 beyond size- and age-composition and genetic diversity. In this regard, criteria D3C3 can function as an early warning indicator for D3C2 and thereby D3C1.

The following Tables 5.5-1 and Table provide examples of potential indicators for the current criterion and its expanded form. The lists are not conclusive, and work and discussion on appropriate indicators for D3C3 assessment continue.

Table 5.5-1: Examples of potential indicators for the current D3C3

Aspects assessed	Potential indicator
Length	<p>Median, 95 % or other quantiles of length of individuals in the population.</p> <p>This indicator will reflect the combined impacts of recruitment, individual growth, and mortality. It should preferably be monitored by fish length distribution from stock assessments combining length distribution-at-age and numbers-at-age in the population, or data on length distribution from surveys. Where representative survey catches are lacking, data on length distribution in catches may be used. Results should be reported in a way that reflects on potential biases and limits to interpretation with respect to the data used</p>
Age distribution	<p>Median/mean, 95 % or other quantiles of age of individuals in the population.</p> <p>This indicator will reflect the combined impacts of recruitment and mortality. It should be monitored by age distribution from stock assessment estimates of age and numbers-at-age in the population, or data on age distribution from surveys.</p> <p>Where representative survey catches are lacking, data on age distribution in catches may be used.</p>
Maturity	<p>Length at 50 % maturity or age at 50 % maturity.</p> <p>Maturity should be estimated from representative sampling of the population in a biologically relevant season. Smaller length- or age-at-maturity can be indicative of high mortality, changes in size selective mortality, or of both enhanced or deteriorating individual condition.</p>

Table 5.5-2: Examples of potential indicators for an expanded D3C3

Aspects assessed	Potential indicator
Recruitment	<p>Recruitment per spawner.</p> <p>It should be estimated by SSB and the number in the population at the earliest observed age from stock assessments, or by data on recruitment and SSB from surveys.</p> <p>Where representative survey catches are lacking, data on recruitment and SSB from catches may be used.</p> <p>For stocks with high fishing impact on juveniles, recruitment can be measured at later ages and will then incorporate the juvenile mortality induced by fishing.</p>

Aspects assessed	Potential indicator
Individual growth	Mean weight-at-age-anomaly averaged across appropriate ages. It should be estimated by weight-at-age in the stock from surveys or, where representative survey catches are lacking, data from catches
Condition	Mean condition or mean relative condition (ratio between observed weight-at-length and predicted weight-at-length based on a reference data set for the stock) averaged across individuals or proportion of individuals in poor condition (poor condition to be defined on a stock basis). It should be estimated from condition in the stock from surveys.
Natural mortality	Estimated natural mortality. Increased natural mortality due to e.g. predation or disease can decrease stock productivity to levels where previously estimated thresholds of fishing mortality are no longer sustainable and vice versa. With the rebuilding of apex predator populations, the natural mortality of particularly planktivores and sub-apex predators is likely to increase. Natural mortality can be estimated from multispecies models. However, these models are not widely available and difficult to validate.

»» Temporal aspects of assessment

The six-year period for the assessment due for reporting in 2024 should be 2016–2021 and should be applied uniformly within and across marine regions. For assessment period, trend assessment and change of status see → section 2.2.5 and 2.4.

To reflect the status of the descriptor within the six-year assessment period, indicator status in each of the six years should be considered in the evaluation. Temporal aggregation of the annual results is explained for each criterion in subsection → ‘Threshold values’ above.

As results of D3 are to be integrated with results under D1 and D4, the calendar years of the applied six-year assessment period should be coordinated across the three descriptors to ensure consistency in the evaluations of food web and diversity aspects.

»» Spatial aggregation of assessment

No guidance needed as assessment results are provided by stocks.

»» Use of criteria

Whether a stock is in good status is based on the combination of the assessment results for D3C1 and D3C2. In the absence of a common understanding as well as agreed methodologies and thresholds for D3C3, assessment results for D3C3 do not change the status of the stock based on D3C1 and D3C2. D3C3 can be assessed qualitatively using indicative threshold values or descriptions of trends. The use of D3C3 in D3 assessment will be addressed in the next update of this guidance.

To ensure consistency with existing management approaches, the following integration rules are suggested with respect to the potential combination of assessment results for D3C1 and D3C2 (

Integration across stocks is not conducted. See → ‘Visualisation of assessment results’ below for illustrating the assessments results.

Table 5.5-3) to determine a stock's status.

Integration across stocks is not conducted. See → 'Visualisation of assessment results' below for illustrating the assessments results.

Table 5.5-3: Suggestions for combining assessment results for D3C1 and D3C2 to express stock status

D3C1 Meeting the threshold values	D3C2 Meeting the threshold values	Stock status
Yes	Yes	Good
Yes	No	Not good
No	Yes	Not good
Unknown; short-lived stocks managed by $B_{escapement}$	Yes	Good
Unknown; short-lived stocks managed by $B_{escapement}$	No	Not good
Unknown; all other stocks than short-lived stocks ones managed by $B_{escapement}$	Yes	Unknown
Unknown; all other stocks than short-lived stocks managed by $B_{escapement}$	No	Not good
Yes	Unknown	Unknown
No	Unknown	Not good

Figure 5.5-1 gives an overview of levels of integration for the assessment of fish stocks under D3.

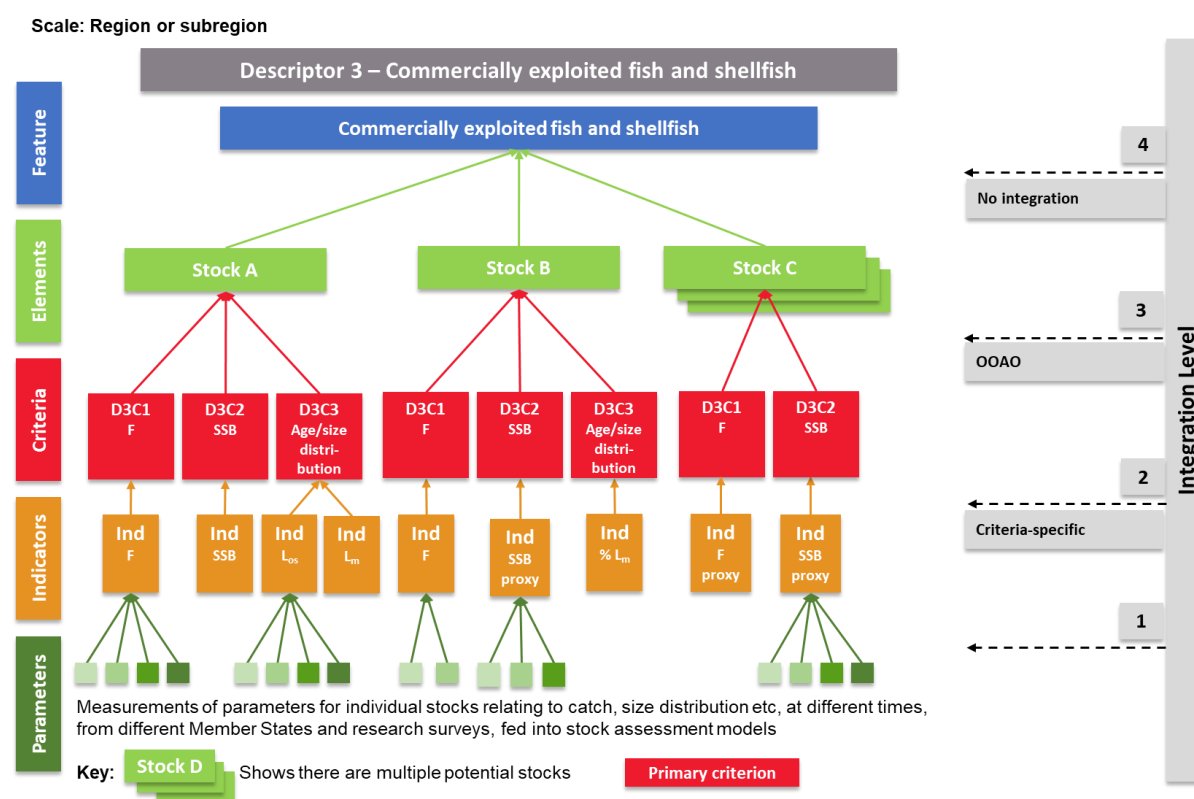

Figure 5.5-1: Levels and methods of integration for Descriptor 3. In the absence of agreed methodologies for D3C3, the assessment will be based only on D3C1 and D3C2.

»» Confidence

The D3 assessment should be accompanied by an evaluation of the confidence in the assessment per stock. Further guidance on confidence is expected to be developed as part of the ICES advice request (expected to deliver in 2022) on a reference list of elements for D3. The evaluation of confidence could for example include (per criterion/parameter addressed): the appropriateness of stock data with respect to length of time series and spatial coverage of data collected, the appropriateness of

the models used for estimating indicators, and the appropriateness of the approach for estimating stock thresholds values.

» Visualising assessment results

D3 criteria assessments are presented using bar charts depicting the proportion/number of stocks whose status is good, not good or unknown in the agreed assessment area (super-regional, regional, subregional, or, if relevant, smaller). An example illustration is given in Figure 5.5-2.

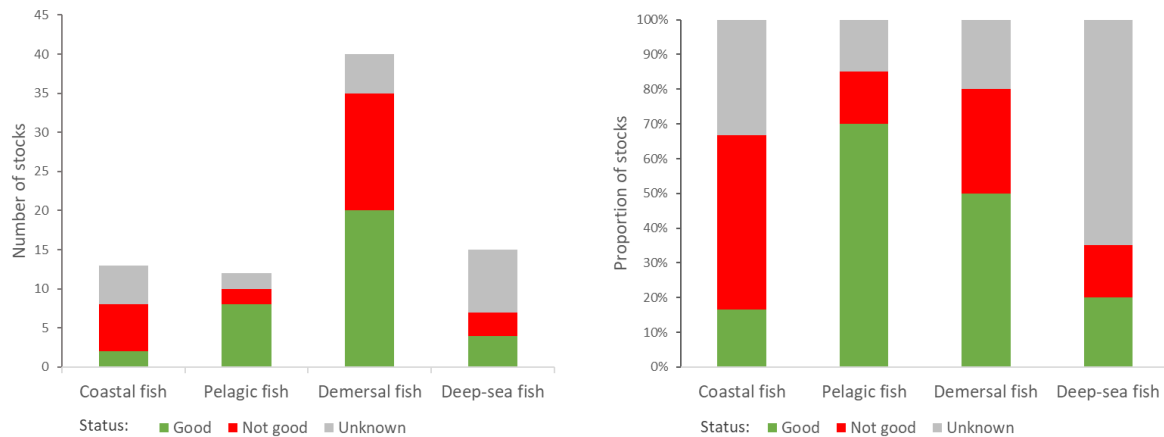

Figure 5.5-2: Examples to visualise the assessment results under D3 on stock status (based on criteria D3C1 and D3C2) per fish species group). Stock status: red – not good; green – good; grey – unknown

» Gaps in knowledge and outstanding issues

Outstanding issues

Close the identified guidance gaps, including:

- Guidance on (sub)regionally relevant stocks and on a reference period for regional cooperation on lists of stocks for assessment, criteria for selecting species for national reporting and assigning stocks to D1 fish species groups
- Recommendations of methodological approaches to F_{MSY} estimates for data-limited stocks
- Evolve guidance in accordance with ICES agreed and adopted assessment methods, including any potential update of these methods e.g. in light of present and future discussions on reviewing values (e.g. $B_{trigger}$) to assess SSB and considerations for their use as threshold values for GES.¹⁰⁶
- Guidance on confidence assessment
- Seek coordination of data collection across regional fisheries management organisations
- Further development of indicators and thresholds for D3C3: Further discussion on the potential need for broadening the indicators under D3C3 to reflect changes in productivity beyond size structure and evaluation of the methodological approaches should be conducted. This work should provide firmer guidelines on which indicators and approaches are most appropriate for specific regions and stocks and how thresholds should be defined.

¹⁰⁶ Ongoing ICES work (e.g. working WKREF) may result in ICES reviewing its approach to certain reference points, in particular B_{lim} and $B_{trigger}$. If confirmed, these new approaches should be presented and discussed at WGGES. An update to the relevant parts of this guidance (D3C2 and C3C3) should be considered as soon as possible, preferably in good time to allow the Member States implementing it for their 2024 reporting.

- Changes in stock productivity and comparability of MSFD assessments over time: Stock productivity and hence F_{MSY} varies over time. To adjust for this, F_{MSY} is regularly updated to match current productivity conditions. Such updated F_{MSY} pertains to current conditions but not historical conditions and using the value for a historical time period provides a biased view with respect to the development of fishing pressure relative to F_{MSY} . If F_{MSY} was increased with the update, stocks may appear historically underexploited and vice versa. Other updates are also frequently made, meaning it is difficult to derive historically comparable thresholds for F_{MSY} from the literature. In order to allow an unbiased assessment of the temporal development, F_{MSY} should ideally be re-evaluated for each six-year assessment period. For stocks where F_{MSY} has changed over time due to changes in stock productivity and/or selectivity, the F_{MSY} threshold used for a given year should be the value relevant to the stock productivity and selectivity in that specific year.
- The links between assessment frameworks for D1, D4, and D3 require consistency of (guidance on) the assessments. Whether and how these links could be expressed in Article 8 reporting is still to be discussed.

5.6 Descriptor 1: Pelagic Habitats

Descriptor 1: Biological diversity is maintained. The quality and occurrence of habitats and the distribution and abundance of species are in line with prevailing physiographic, geographic and climatic conditions (Annex I MSFD).

DESCRIPTOR PROFILE		D1C6 Pelagic habitats
Feature		Pelagic broad habitats; other pelagic habitats
Primary criterion		X
Information type		State
Annex III MSFD	State (Table 1)	Habitats/Pelagic
	Pressure (Table 2a)	Input or spread of non-indigenous species, changes in hydrodynamic and hydrological conditions, input of nutrients and organic matter, input of other substances (e.g. synthetic substances, non-synthetic substances, radionuclides) – diffuse sources, point sources, atmospheric deposition, acute events.
	Activity (Table 2b)	Physical restructuring of rivers, coastline or seabed (water management), extraction of non-living resources, production of energy, extraction of living resources, cultivation of living resources, transport, urban and industrial uses, security/defence
GES Decision	Elements	GES Decision; (sub)regional
	Threshold values	(Sub)regional
	Use of criteria	(Sub)regional
Criteria linkages		D2C3, D5C2, D5C3, D5C4, D7C1, D8C2, D8C4
Descriptor linkages		D2, D5, D7, D8, D4*

* Not included in the GES Decision

Development of an assessment framework for pelagic habitats was not a priority in MSFD implementation at national, EU and regional level in the past MSFD cycle. Member States used various approaches in 2012 and 2018 in their Article 8 MSFD assessments. While all considered plankton communities, some used assessment results under other Descriptors, e.g. on species under D1, to conclude in an overall appraisal of assessment information on the status of pelagic habitats. Since then, progress has been made in marine regions on developing plankton indicators. The absence of a precise understanding of causal processes driving plankton diversity patterns continues to hamper the implementation of reliable indicators responding to anthropogenic pressures. Despite good progress, constraints in taxonomy remain and provide another challenge for the assessment of plankton communities.

A ‘MSFD Pelagic Habitats Workshop’ organised by JRC in March 2021 kicked off dedicated EU MSFD CIS discussions on how to support future harmonised assessment of pelagic habitats.¹⁰⁷ Based on the Workshop results, an approach and a guidance are under development. They will be taken up in an update of this Guidance Document.

¹⁰⁷ https://publications.jrc.ec.europa.eu/repository/bitstream/JRC124882/final_20042021.pdf

5.7 Descriptor 6: Seafloor Integrity and Descriptor 1: Benthic Habitats

Descriptor 6: Seafloor integrity is at a level that ensures that the structure and functions of the ecosystems are safeguarded and benthic ecosystems, in particular, are not adversely affected. (MSFD Annex I)

DESCRIPTOR PROFILE		D6C1 Physical loss of the seabed	D6C2 Physical disturbance to the seabed	D6C3 Adverse effects from physical disturbance on benthic habitats (spatial extent)	D6C4 Benthic habitat extent (Extent of habitat loss from anthropogenic pressures)	D6C5 Benthic habitat condition (extent of adverse effects from anthropogenic pressures)
Feature		Physical loss of the seabed	Physical disturbance to the seabed	Benthic broad habitat types (BHT) and other habitat types (OHT)		
Primary criterion		X	X	X	X	X
Information type		Pressure	Pressure	Impact	State	State
Annex III MSFD	State (Table 1)			Benthic habitats	Benthic habitats	Benthic habitats
	Pressure (Table 2a)	Physical loss	Physical disturbance to the seabed	Physical disturbance to the seabed; Changes to hydrological conditions	Physical loss and other pressures leading to habitat loss	All relevant biological and physical pressures, including physical loss and disturbance; Pressures from substances and litter
	Activity (Table 2b)	Physical restructuring; Extraction of non-living resources; Extraction of living resources; Production of energy; Cultivation of living resources; Transport; Tourism and leisure; Military operations (subject to Article 2(2)); Urban and industrial uses	Physical restructuring; Extraction of non-living resources; Extraction of living resources; Production of energy; Cultivation of living resources; Transport; Urban and industrial uses; Tourism and leisure; Military operations (subject to Article 2(2)); Education and research	See under D6C1; all activities in Table 2b are potentially relevant	All activities in Table 2b are potentially relevant	
GES Decision	Elements	EU		EU: BHT (sub)regional: OHT		
	Threshold values	Not required	Not required	(Sub)regional	EU level, taking account of (sub)regional specificities	EU level, taking account of (sub)regional specificities

DESCRIPTOR PROFILE		D6C1 Physical loss of the seabed	D6C2 Physical disturbance to the seabed	D6C3 Adverse effects from physical disturbance on benthic habitats (spatial extent)	D6C4 Benthic habitat extent (Extent of habitat loss from anthropogenic pressures)	D6C5 Benthic habitat condition (extent of adverse effects from anthropogenic pressures)
	Use of criteria	EU				
	Criteria linkages	D6C4, D7C1	D6C3	D6C2, D6C5 (may also require D7C2*)	D6C1, D6C5 (may also require D7C1*)	D2C3, D3C1, D3C2, D3C3, D5C4, D5C5, D5C6, D5C7, D5C8, D6C3, D6C4, D7C2, D8C2, D8C4 (may also require D10C4*) <small>108</small>
	Descriptor linkages	D7		D1, D2, D3, D4, D5, D7, D8, D10*		

*Not included in the GES Decision

»» Overview of assessment framework

The assessment of seabed habitats and seafloor integrity under Descriptors 1 and 6 are undertaken together through the assessment of a set of ‘Broad Habitat Types’ (BHT), as specified in the GES Decision, which together cover the range of seabed habitats present in marine waters. The assessment may also include ‘Other Habitat Types’ (OHT), as specified by Member States and selected through (sub)regional cooperation.

Assessing the environmental status of these habitats requires knowledge on the extent, persistence and distribution of the anthropogenic pressures affecting the seabed, and the extent and intensity of their impacts (adverse effects) on each habitat. Two key pressure types (physical loss and physical disturbance) and their impacts are directly addressed by Descriptor 6 (D6) criteria (D6C1, D6C2, D6C3 and D6C4). Criteria under other descriptors address other key pressures whose impacts also need to be considered under D6C4 and D6C5 (e.g. non-indigenous species, nutrient enrichment, hydrographic changes, contaminants). Habitat status is derived from the extent of habitat loss (D6C4) and the state of the benthic communities and extent of adverse effects from all relevant pressures (D6C5, including the assessment of D6C3). These are assessed in relation to the ‘quality’ threshold to be achieved and the ‘extent’ thresholds set for the maximum allowable extent of loss and adverse effect.

Due to the very extensive areas of seabed to be assessed across Member States’ marine waters, and the range of pressures and associated impacts to be considered, it is necessary to use a mixture of spatial models and ground-truth validation (i.e. *in situ* sampling and/or observations of seabed habitats). This may require mapping of activities (e.g. aggregate extraction, bottom fishing) as a basis for developing maps of the distribution and intensity of pressures (e.g. of physical disturbance) and ideally modelling their impacts in relation to the sensitivity of each habitat to each pressure. Where such detailed models are not available, expert interpretation of the benthic community status using pressure assessments from other Descriptors may be an alternative.

¹⁰⁸ These refer to the impact criteria. Is it worth noting that some pressure criteria may be relevant to consider (e.g. in absence of the impact assessments): D2C2, D7C1, D8C3, D10C1 (seabed).

Confidence in the assessments is improved through developing pressure-state relationships for all relevant BHTs and OHTs, and ground-truth validation of the models as well as direct observation/sampling of seabed habitats for additional direct habitat state assessment.

For some aspects several options are given to allow for regional/national differences in natural habitats and methodologies.

» Elements

The elements to be assessed under the GES Decision concerning seafloor integrity differ according to the considered criteria:

For criteria D6C1 and D6C2 the evaluation should be carried out for the whole physical 'seabed', including intertidal areas (i.e. each assessment area).

For criteria D6C3, D6C4, and D6C5 the assessment should be conducted on:

- BHTs, as listed in GES Decision Table 2
- OHTs, i.e. additional habitat types that MS may select (see below)

Selection and use of Broad Habitat Types for the assessment

It is noted that all BHTs occurring in Member States' marine waters are to be assessed. BHTs provide a common set of habitat types across Member States for reporting on the extent of adverse effects and loss associated to criteria D6C3, D6C4 and D6C5.

BHTs, including their associated biological communities, equate directly to the European Nature Information System (EUNIS) marine habitat classification level 2 classes, or to aggregations of them. This → [EUNIS classification](#) was restructured in 2016 and a new version released in 2019 (EUNIS, 2019), but it may still be deficient in certain regions of the North-East Atlantic and Mediterranean Sea. Future assessments should aim to use the latest version of the EUNIS classification, linked to the BHTs specified in the GES Decision. The version of EUNIS used for each six-year assessment period should be specified.

A provisional list of BHTs per Member State per subregion is available in → [SEABED_3-2020-05annexRev](#).

Of the full set of 22 BHTs in the GES Decision, Member States should assess all those BHT present in their marine waters. The question of how to approach habitats which cover a very small proportion of national marine waters is still under discussion in TG Seabed. As the Baltic, Mediterranean and Black Seas are microtidal, a decision is needed whether an assessment of littoral rock and sediment BHTs are required in these regions, bearing in mind that EUNIS includes habitat types for the littoral zone in these regions.

Selection and use of Other Habitat Types for the assessment

BHTs within the MSFD framework are defined by substrate type and biological zone. They are not defined by specific biotic components, nor the geomorphic or other abiotic characteristics, which are needed for the assessment of impacts and status. Indeed, the assessment of status without these specifications would not be functional, as the parameters used to assess habitat condition (under D6C5) need to reflect the habitat's biology (i.e. the actual biological composition) and/or associated abiotic characteristics, allowing assessment of habitat sensitivity in relation to each pressure.

The GES Decision states that Member States can also assess OHTs, which should be chosen through regional or subregional cooperation, e.g. in Regional Sea Conventions (RSCs). The assessment of

OHTs allows Member States to highlight the importance of such habitats in the context of their marine strategies. OHTs may include:

- Habitat types listed under the Habitats Directive (Annex I habitat types)
- Habitat types selected for protection by RSCs (e.g. on a red list, → [OSPAR List](#) of threatened and/or declining species and habitats¹⁰⁹, → [HELCOM Red List](#) of biotopes, habitats and biotope complexes¹¹⁰, or also SPA/RAC-UN Environment/MAP → [Updated Reference List](#) of marine habitat types for the selection of sites to be included in the national inventories of natural sites of conservation interest in the Mediterranean¹¹¹)
- Habitat types as defined according to biocenoses/communities (at EUNIS level 4, 5 or 6)
- Habitat types selected by Member States considering their vulnerability (e.g. according to their national red lists)

Member States may assess OHTs as part of BHT assessments or in their own right. Some habitat types from the Habitats Directive and RSCs are in fact habitat complexes and so their suitability for assessment of BHTs has to be carefully evaluated. Criteria for selection of OHTs are given in the GES Decision, which sets out a series of ‘main scientific criteria (ecological relevance)’ to select OHTs as representative habitats to be assessed within BHT or separately. Any assessment carried out at higher resolution with OHTs needs to allow for aggregation to BHT level, considering the BHTs’ extent and spatial distribution. Specific guidance on aggregation methods is given in → subsection ‘Spatial aggregation of assessment’ below.

Reference maps for Broad Habitat Types and reporting

Assessment of habitats requires maps of their distribution and extent. Extensive coverage ‘predicted’ (i.e. modelled) habitat maps are available for all European seas from → [EMODnet's EUSeaMap](#)¹¹², along with an account of the confidence in the classification reported according to three levels. EUSeaMap was updated in September 2021, using the 2019 EUNIS classification, and is fully compatible with the BHTs of the GES Decision. The version of EUSeaMap used for each six-year assessment period should be specified.

The use of BHT maps from EUSeaMap allows consistent assessments of BHTs across Member States and regions in the EU for MSFD implementation. To allow Member States to use the most suitable data, the assessment could be carried out using the most relevant local maps and data. If national maps are used these should be made available to EMODnet.

»» Assessment areas and scales

Ecologically defined scales

The GES Decision requires assessments for Descriptor 6 to be undertaken at the scale of ecologically defined subdivisions of each (sub)region. These subdivisions are intended to reflect biogeographic differences in community composition of the BHTs, such that achievement of GES for each BHT within each subdivision would ensure that a representative range of seabed biodiversity across the EU is conserved.

The oceanographic characteristics of the water column (particularly its temperature and salinity regime), which influence the biogeographic characteristics of the pelagic and benthic habitats, can

¹⁰⁹ <https://www.ospar.org/work-areas/bdc/species-habitats>

¹¹⁰ <https://helcom.fi/baltic-sea-trends/biodiversity/red-list-of-biotopes-habitats-and-biotope-complexes/>

¹¹¹ https://www.rac-spa.org/nfp13/documents/01_working_documents/wg_431_06_eng_24_04_2017.pdf

¹¹² <https://www.emodnet-seabedhabitats.eu/access-data/launch-map-viewer/>

be used to distinguish subdivisions within each (sub)region. Also, aspects like mixing/stratification patterns, and habitat distribution and connectivity should be considered. Additionally, management implications can be used to delineate subdivisions. The subdivisions may span several Member States' waters. As their size could vary considerably, due to different scales of biogeographic variation, further consideration is needed on how their absolute size (and that of the BHTs within marine reporting units (MRUs)) affects the comparability of assessments and the achievement of GES.

The definition of subdivisions per (sub)region for D6 should take account of links to other descriptors that assess relevant pressures/impacts on seabed habitats.

Linking assessments to marine reporting units

In the 2012 and 2018 Article 8 MSFD assessments, MRUs were defined by the Member States individually, with considerable variation in approaches between Member State and across descriptors. A more harmonised approach within and across regions is needed to fulfil the aims of the GES Decision to assess seabed habitats at ecologically relevant scales.

Consideration of national reporting needs (e.g. for management purposes, and to reflect the status of habitats at national level) may lead to reporting results at national level within each subdivision (i.e. using national MRUs covering all or parts of national marine waters). See guidance below on → 'Visualising assessment results' to ensure transparency of assessment results. For linking assessment to marine reporting units see → section 2.4.

Information and dynamic link to scales used in the marine regions

It is a task for Member States, through (sub)regional cooperation such as via RSCs, to define an operational set of assessment areas for each (sub)region and to reflect these in their national MRUs for reporting purposes. Because of the interlinkages between descriptors, particularly pelagic and benthic habitats, and with the pressure-based descriptors affecting seabed habitats, this should ideally be a combined process for all descriptors at once, using hydrogeographically defined spatial patterns. Validation with community data is recommended from the benthic habitats' perspective. Typically, references (i.e. reference values for habitat quality indicators) deviate for the same habitat type among assessment areas but are the same within assessment area.

An indicative set of assessment areas for each (sub)region has been identified by TG Seabed (→ [SEABED_8-2021-04](#)) based on large-scale patterns in key abiotic parameters. These indicative proposals take the work developed by → [HELCOM](#) (HOLAS III), → [OSPAR](#) (QSR2023/NEA-PANACEA), → [ICES](#) (WKTRADE3), → [PERSEUS](#) (Marine Ecoregions), and MSFD reporting units used by Member States, into account, typically aggregating them to provide a more limited number of subdivisions.

»» Temporal aspects of assessment

The six-year period for the assessment due for reporting in 2024 should be 2016–2021 and should be applied uniformly within and across marine regions. If this is not feasible, e.g. due to a mismatch between reporting periods of related EU Directives and MSFD, differences in assessment periods may occur.¹¹³ For assessment period, trend assessment and change of status see → section 2.2.5 and 2.4.

¹¹³ Harmonisation of assessment cycles between related EU Directives need to be tackled by the EU in a separate process.

Assessments should use all data available and representative for this period, while clearly stating the actual dates, and using data (e.g. for relevant activities and pressures) which has been updated from the previous six-year period. The actual data set used (e.g. 2016–2021 or 2022, for reporting in 2024) for the assessment period depends on data flows and the time needed to collate relevant data for the assessment. Where possible, this period should be harmonised with related assessments from other descriptors and between Member States in the (sub)region, preferably using existing processes in the respective RSCs.

Whether or not the information used is representative for the period of concern (e.g. based on information from a singular or from multiple years or seasons) should be reflected in the assessment results' uncertainty (→subsection 'Confidence' below).

The overall assessment of habitat status (for the six-year period) should include a comparison (improving, stable, deteriorating) with the previous reporting period. Where possible, trends in pressures/impacts during the six-year period should also be identified as overall status of a BHT (in GES or not) may not change in one cycle and showing trends is important for communication and management purposes, as well as to anticipate changes.

More concrete methodological advice is under development in TG Seabed. Details and examples will be outlined in the extended guidance document for D6.

»» Spatial aggregation of assessment

Spatial resolution of assessments (assessment areas in national and regional context)

The delineation of assessment areas, and BHTs within them, constitutes the areas for reporting of assessment results at (sub)regional level; assessment results may then be reported for the nationally defined MRUs within the assessment areas. The definition/selection of indicators per criterion, the setting of threshold (and reference) levels and the monitoring effort required, need to be tailored to the scale of the assessment.

In practice, assessments may take place at finer scales than a BHT, e.g. at the level of sampling sites or grid cells. Smaller functional units, e.g. reflecting biological communities (higher EUNIS levels), management, distinct pressure patterns or national borders, can thus be used, aggregating the results up to the BHT and assessment area level for reporting. Footprints of activities and pressures occurring within an assessment area need to be mapped at sufficient resolution and overlaid on habitat maps to assess the extent of pressure/impact per habitat. Also, *in situ* data on habitat quality need to be used to assess status, together with an estimate of its adequacy/representativity in relation to each BHT in the assessment area.

Assessment data, such as spatial data on pressures and *in situ* monitoring data should be representative for the MRU and habitat type. In case monitoring (effort) varies within the MRU, subunits could be defined to reflect those differences. Assessment results for the smaller subunits within a specific MRU could be combined to assessments at MRU level based on surface area ratio. The use of subunits also provides opportunities to use results from other policy assessments (→subsection 'Use of criteria' / 'Use of habitat assessments from other policies' below).

Methods for spatial aggregation of assessments

A combined qualitative and quantitative approach is suggested where qualitative assessment results are combined taking surface-area ratios and reliability of the assessment into account.

If *in situ* observation data on benthic communities from monitoring are available (through MSFD indicators or assessments by other policies), their use for assessment of D6C5 should be prioritised, as they offer the highest confidence for the assessment. For wider areas that lack detailed state data (in sufficient density), spatial interpolation using predicted impact maps from D6C4 and D6C3 and/or spatial footprints of the impacts from other (most relevant) pressures can be used.

Models of predicted impact can be developed based on the spatial footprints of the most relevant pressures in each (sub-)region. These include other types of pressures such as introduction or spread of non-indigenous species, extraction of species by fishing, cultivation of species (aquaculture), input of nutrients and organic matter, hydrographical change, chemical contaminants and litter. Assessments of the footprint of impacts from these pressures should, wherever possible, come from assessments under the other relevant Descriptors, and be provided in a form (spatial data layer of pressures or preferably impacts, with associated confidence) that can be readily integrated with the spatial data layers from D6C3 and the *in situ* observational data for D6C5. Pressure data from other criteria have to be combined with the sensitivity of benthic species or habitats towards the specific pressure. The resulting spatial layers of this impact modelling and the spatial extent of adverse effects from D6C3 could then be integrated, once appropriate methods are available, taking into account cumulative effects, which may be additive, synergistic or antagonistic. These can be used for the assessment of extensive areas which lack (sufficient) *in situ* benthic state data. The development of appropriate models based on (sub-)regionally relevant pressures should be coordinated across the region or subregion.

The maps of areas of adverse effects from physical disturbance levels (D6C3), habitat loss (D6C4), and adverse effects levels (D6C5), are constructed by intersecting pressure/impact maps with habitat maps to determine the extent to which each benthic habitat type is affected by disturbance, loss, and adverse effects.

Several possible methods for spatial aggregations are being discussed in TG Seabed in combination with quality classes, confidence levels and monitoring approaches. Concrete advice will be formulated in the extended guidance document for D6.

Results from other status assessments (e.g. Habitats Directive or WFD) can be used to give the status of particular areas or habitat types, provided the quality threshold values used under Habitats Directive and WFD are not lower than those under MSFD. Several assessments for the same area (e.g. WFD and MSFD indicator assessments) could be integrated, depending on the spatial extent of the assessments (→subsection 'Use of criteria' / 'Use of habitat assessments from other policies' below). However, an estimation of confidence and sufficiency is required if status assessments from other policies are to be included in a spatial *context*.

»» Threshold values

For benthic habitat assessments, a terminological distinction is used for threshold values which relate to environmental quality attributes and those which relate to the spatial extent of adverse effects from pressures. 'Quality' threshold values are required for D6C5 and 'extent' thresholds are required for D6C4 (maximum extent of loss) and D6C5 (maximum extent of adverse effects from all anthropogenic pressures), all to be agreed at EU level. Threshold values for D6C3 are to be established through regional or subregional cooperation.

Defining adverse effects of anthropogenic pressures on benthic habitats and setting quality thresholds is not straightforward. Given the complexity of the relationships between habitats and pressures, and the variety of possible indicators that could be used to assess adverse effects, TG

Seabed is considering a more generic approach to setting quality thresholds, based on expressing indicator values on a common scale, possibly expressing them as Environmental Quality Ratio (EQR) values. Pressures on seabed habitats can have physical, biological and/or chemical effects on the habitat concerned. The magnitude of these effects varies according to the nature, frequency, persistence and intensity of the pressure and the sensitivity (resistance/resilience) of the habitat and its species to the respective, eventually combined, pressure. Synergistic effects of multiple pressures may lead to adverse effects while the effects of the individual pressures do not. Therefore, these parameters are needed to construct pressure-response curves, which should form the basis for determining threshold values for adverse effects of a certain pressure on a habitat. The response should primarily be defined based on changes in species composition and their relative abundance within the community compared to an unimpacted or less impacted state. Other attributes of a habitat, that reflect changes in its structure or functions (e.g. total biomass of the community, absence of particularly sensitive or fragile species, age and size distribution of individuals within a population or abiotic attributes such as morphology and carbon content), may additionally be useful for assessing adverse effects and habitat status. In some cases, there may be no information available on biotic characteristics of the habitat in an unimpacted state, and these will only become available if the habitat is allowed to (fully) recover from current and past pressures. In such cases, the recovery of the biological communities may not be to a state seen in the past (species composition), but to a new 'unimpacted' state.

Estimating the extent of physical loss for D6C1 in relation to BHTs can be done pragmatically by assessing the current extent of physical infrastructure and coastal restructuring, setting a historical baseline for the latter.

Threshold values need to be defined in relation to reference state/condition. Defining reference conditions based on historical data on the undisturbed condition of each habitat type is typically not possible due to lack of data. Therefore, the use of suitable reference sites which are currently subject to limited pressures, and/or modelling approaches need to be used. Alternatively, a reference condition may be defined when a habitat has recovered from current and past pressures.

In accordance with the GES Decision (Article 4(1)(f)), the threshold values for adverse effects on seabed habitats (i.e. as assessed under different criteria) should be compatible. Nevertheless, threshold values have not been discussed in detail in the EU MSFD CIS process but will be a major topic for 2022. Details will be outlined in the extended guidance document for D6.

»» Use of criteria

Use of D6C1 and D6C2

Regarding the physical pressures for assessing D6C1 and D6C2, human activities may induce four types of physical pressure on the seabed:

- Abrasion: the scraping of the substrate without sediment removal
- Removal: the net transfer of substrate away from the seabed (e.g. extraction, dredging of navigational channels, scouring around installations)
- Deposition: the accumulation of sediment on top of existing substrates
- Sealing: the capping of the original substrate with artificial structures or other allochthonous material

The first three pressure types (abrasion, removal and deposition) result in physical disturbances (D6C2) and may lead to physical loss (D6C1) depending on the intensity and/or persistence of the pressure. Sealing automatically implies physical loss.

Guidance on use of D6C1 - Physical loss

Physical loss is defined as a permanent change of one of the following types:

- Sealing of natural substrate by an artificial structure or other allochthonous material.
- Loss of biogenic substrate.
- Seabed change at EUNIS level 2 (e.g. from sand to mud), or morphology or sediment changes at a more detailed level if significant and documented.

A permanent change is defined if one of the following conditions is true:

- When reversal is only possible by active human intervention (e.g. by coral, seagrass and kelp transplantations, by removal of artificial structures, by sand capping, etc.).
- When natural recovery rates exceed 12 years¹¹⁴ (such as the recovery time of some coral reefs or seagrass beds or the long-lasting effect of hydrographical or substrate change), or
- when natural recovery rates are unknown or undocumented but suspected to exceed 12 years.

All relevant physical losses, e.g. sealing of the seabed or permanent sediment type changes including loss of biogenic substrate, should be listed and accounted for under D6C1 and re-evaluated in every six-year cycle, especially after conservation or restoration actions aimed to improve or reverse the situation where possible. In each assessment cycle, the loss evaluation should be updated to take into account new permanent loss and also improved knowledge on recovery rates or the restoration or recovery of the original physical habitats.

The assessment of physical loss also requires the incorporation of impacts that occurred before the current assessment period, e.g. where dredging or depositing has led to loss and the habitat has not (yet) recovered. Historical loss of e.g. biogenic substrates should also be included in the assessment process. Pragmatically, physical loss can also be based on mapping the extent of artificial substrates (structures)/physically restructured coastlines and seabed, as the availability of historical data may be low or null.

Guidance on use of D6C2 – Physical disturbance (D6C2)

Any other physical pressures on the seabed that do not correspond to physical loss should be classified as physical disturbance. Such pressures do not induce permanent change since natural recovery, once the pressure has ceased, may be expected without human intervention. All relevant physical disturbances, even those that may not necessarily induce adverse effects, should be listed and accounted for under D6C2.

Use of criteria from other descriptors

Other pressures and their adverse effects on seabed habitats are assessed under other Descriptors: non-indigenous species (D2C2-C3), commercial fish and shellfish (D3C1-C3), nutrient and organic matter enrichment (D5C4-C8), hydrographical changes (D7C1-C2), contaminants including acute pollution events (D8C1-C4) and litter (D10C1, D10C4). See proposal for quantified assessment contributions of eutrophication criteria to the assessment of benthic habitats (→ section 4.2 on 'Use of criteria').

¹¹⁴ Temporal aspects of physical loss will be detailed in the extended guidance document for D6

Where possible these assessments should provide a spatial footprint of adverse effects that can be quantitatively incorporated into the D6C5 assessment; however, it is expected that such assessments will more often provide qualitative information, at least in the short term.

Use of D6 criteria and integration rules

D6C1 and D6C2 should provide outputs (extent of physical loss and disturbance) which are directly used to calculate D6C4 and D6C3 respectively. These in turn contribute to the D6C5 assessment, which should take into account the assessments of other pressures and impacts from other Descriptors. See Figure 5.7-1 on levels and methods of integration.

The overall status is represented by the assessment of D6C5 per BHT, including the assessment of D6C3 and D6C4. GES of the BHT is achieved when these criteria have met the respective threshold values (extent threshold for D6C4, and quality and extent thresholds for D6C5). The extent of adverse effects from disturbance (D6C3) and the state (impact) assessment, and inputs from other descriptors (either as spatial impact analysis or qualitative description, as deemed appropriate) contribute to D6C5. D6C4 is incorporated into D6C5 by adding the extent of habitat area lost to the extent of adverse effects. D6C5 thereby integrates all other D6 criteria as well as contributions from other descriptors, as relevant, to each subdivision assessment area. The integrative assessment of D6C5 will be detailed with examples in the extended guidance document for D6. D6C3 and D6C4 contribute to D6C5, but can also be used separately to assess the status of BHTs, e.g. where a full assessment of D6C5 is not possible.

OHTs, selected through agreement of Member States in each (sub)region, are assessed separately. They may be reported separately or contribute to the BHT assessments.

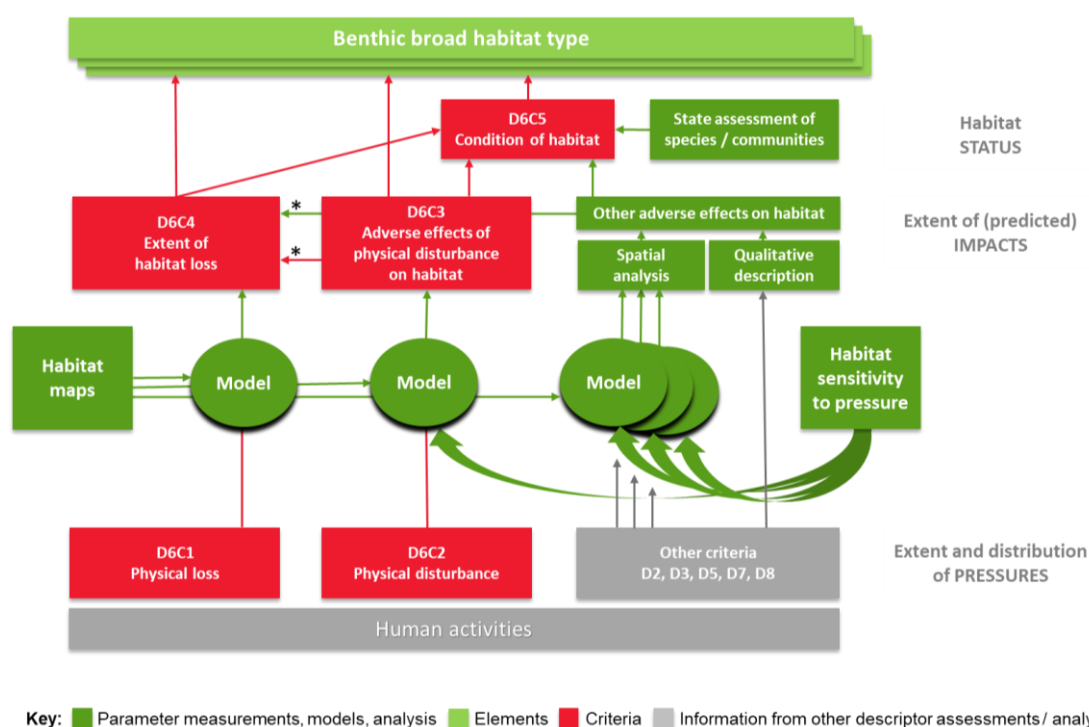

Figure 5.7-1: Levels and methods of integration for benthic habitats and seafloor integrity under D1 and D6. The combination of pressure maps, habitat maps and sensitivity of benthic communities is achieved via the depicted “models”. (*Habitat loss can result not only from physical loss, but also from intense other pressures).

Progress towards good status should be expressed as the proportion (%) of the habitat in good condition (i.e. not adversely affected, including the extent of habitat loss from D6C4) in the assessment area, in relation to the extent threshold (%).

GES for BHTs should be expressed as the proportion (%) of the respective BHTs in the assessment areas that should be in good status, with the overall current status expressed as the proportion (%) of BHTs that have achieved good status in the assessment area.

A flexible approach, depending on data availability and confidence, aims at incorporating the most reliable status information available for each location. Where *in situ* measurements of state are available, these should be preferred over models. Where representative data are not available, spatial models, based on the most relevant pressures/impacts, can be used for assessments.

Use of habitat assessments from other policies

The GES Decision advocates to re-use assessments from other policies (e.g. Habitat Directive and WFD), wherever possible; several MS have already done so. The application of indicators and assessments for several directives can improve coherence of assessments under various policies and avoid inconsistencies in different state of the environment reports dealing with the same habitats. In principle, there are three options to re-use and apply WFD or Habitat Directive assessments. These options are not mutually exclusive but can be used jointly to inform the assessment of benthic habitats. Due to the nature of the original data/assessments, not all of the options may be appropriate to apply in every Member State's waters; so Member States may decide if the use of any of them is adequate for supporting their MSFD assessment.

The exact methodologies are still under development in TG Seabed and will be detailed with examples in the extended guidance document for D6.

Option 1: Assessment of 'Other Habitat Types'

In addition to BHTs, Member States may assess OHTs in their own right. OHTs can be habitat types listed under international or regional agreements such as Habitat Directive or RSCs. It is recommended to apply the conservation status as reported for the Habitats Directive (or a similar assessment status from another international or regional agreement), if deemed relevant, for the MSFD assessment of the OHT and not to split the assessment into MSFD criteria. For a combined assessment of BHTs and OHTs, the following three step-procedure is recommended:

1. A complete assessment of benthic BHT according to criteria D6C1-C5
2. An assessment of OHT (Habitat Directive types or other relevant assessments, e.g. from RSCs), according to the assessment status of the respective directive or agreement
3. An overall assessment of BHTs and OHTs with the assessment status of OHT (Habitat Directive types or other relevant assessments, e.g. from RSCs) on top of BHTs. Thus, every area will have only one assessment result. However, for reporting purposes, the results of BHTs and OHTs will have to be presented separately.

This would ensure that the protection status of OHTs is maintained and the assessment of BHTs is not contradictory to the assessment of other policies.

Option 2: Assessment re-use for criterion D6C5

Assessment results from WFD or Habitat Directive can be re-used to assess BHTs or subtypes of BHTs under D6C5. This is done by a spatial overlay of WFD assessment results for water bodies or

Habitat Directive assessment results for Annex I habitat types with BHTs. If several BHTs occur in one water body, either the assessment result can be applied to all habitat types within the water body, or it has to be decided which BHT is assessed by considering the location of the monitoring stations. For WFD it is recommended to use only the assessment results for the relevant benthic elements (e.g. the macroalgae results could be used for the assessment of the BHT ‘infralittoral rock’) and not to use the overall assessment result for the ecological status of the water body. The quality threshold values used in the WFD and Habitat Directive assessments should not be lower than those for MSFD.

Option 3: Extension of indicators developed under other policies for application under MSFD

Indices developed for the WFD (e.g. M-AMBI, M-BENTIX, BQI, MARBIT) could be adapted (e.g. with regard to reference conditions and threshold values) to cover other pressures and also BHTs in areas beyond WFD coastal waters for state assessments under D6C5.

»» Confidence

Assessments of seabed habitats are influenced by many different sources of uncertainty that affect confidence in the final assessment. Since large areas of seabed need assessing, and monitoring programmes using direct sampling and/or observation often have limited coverage, models are required for predicting habitat distribution, pressures and their impacts. The overall data and model uncertainty propagates and grows with an increasing number of assumptions, and shortcomings accumulate. Whilst there is not yet a general framework to quantify uncertainty of the individual and cumulative components, nor common modelling approaches to assess D6, it is recommended to comprehensively compile information to address confidence in the data and models, related, but not limited, to:

- Status/condition assessment (e.g. indicators, thresholds and state)
- Pressure layers
- Benthic habitat maps for upscaling the assessment

Improving confidence in the assessments is most important:

- at the boundary between a good and not good quality of a habitat (i.e. around the quality threshold value), where improved confidence is needed to determine whether the state of a habitat is above or below the threshold value; and
- when large areas of a habitat are assessed as adversely affected, but with a level of impact that is close to the quality threshold value, and when this large extent then results in the habitat being in poor status (i.e. the extent of adverse effect exceeds the extent threshold set).

In such cases where the confidence is very low, improving the confidence, such as through more focused ground truthing in these boundary zones, may be needed to support taking management action. However, this issue should not be used to avoid actions in cases where the habitat is clearly not in good status.

Whilst it is very important to provide some assessment of confidence, concrete methodologies have not been specified yet.

Awaiting further standardised combined uncertainty assessments, it is proposed, as a minimum, to assign a three-tiered qualitative confidence scoring for each assessment product based on the metadata of the individual contributions:

- Low, where uncertainty is only limitedly assessed or is estimated to be high

- Medium, where there is a reasonable confidence in a component description
- High, where confidence level in a component description is robust

When estimating cumulative uncertainty throughout the assessment process, the lowest confidence class of all contributing components should be retained to assess the confidence of the final product. Considering the fact that D6 criteria require spatial assessments, spatially explicit uncertainty classes should be provided as maps and accompany the mapped assessment results.

» Visualising assessment results

Resolution of assessment summary complementing e-reporting for easy comparison

The assessment outcomes are presented for each benthic BHT and OHT which MS have selected in each assessment area (subdivision of the region or subregion). In cases where the assessment area spans several Member States' waters, the results can be adopted from the larger scale or specified in more detail for the national MRUs. Whether one or both options are used is still under discussion in TG Seabed.

The assessment outcomes should be expressed both as the percentage in relation to the reference area (BHT, OHT, MRU, etc.) and in km², aiming to allow integration at different spatial scales (i.e. nested approach). All habitats of undetermined status in the assessment area need to be accounted for (i.e. status reported as 'unknown').

Options for presentation

Table 5.7-1 propose graphs and maps to visualise assessment results. Graphs are suggested to depict the results as percentages in relation to the reference area and/or km². For D6C1 and D6C2, information on the extent area (% and km²) lost, disturbed area per pressure (by disturbance intensity) and by all disturbances together should be given. A map, or maps, are suggested to visualise these outcomes spatially.

Graphs should provide for each habitat type per assessment area and/or MRU the extent of adverse effects from physical disturbance (D6C3), from physical loss (D6C4), and from all pressures (D6C5), in relation to the thresholds.

Changes in status compared to the last assessment

To follow the temporal trends of criteria, a line graph with the total area affected by physical disturbance (D6C3), loss (D6C4) and adverse effect (D6C5) per assessment area/MRU in relation to the thresholds should be provided. It is also recommended that the overall status of the BHTs and OHTs is presented separately, including simple pie graphs or equivalent graphs, for the purposes of communication of the assessment results.

Table 5.7-1: Suggestions for graphs and maps to visualise the main results of the assessment. Examples and templates will be made available in the upcoming extended guidance document for D6.

	Bar and pie graphs	Maps	Line graphs (time series)
D6C1 D6C2	Stacked bars showing the lost or disturbed area type per assessment area/MRU	Maps for each assessment area/MRU of total loss and spatial extent and distribution of intensity per pressure and for the combination of all pressures	Line graph of cumulative total loss or disturbed area per assessment area/MRU and for the six-year assessment period
D6C3	Stacked bars for each disturbance type per BHT	Maps for each assessment area/MRU and disturbance impact per BHT (including BHT 'not assessed'/ with status 'unknown'))	Line graph for each assessment area/MRU of adversely affected total area per BHT and for the six-year assessment period
D6C4 D6C5	Stacked bars for each assessment area/MRU by types of loss or adverse effects levels by BHT Pie graph for each assessment area/MRU with number and percentage of BHT 'not assessed'/'status unknown', 'threshold achieved', and 'threshold not achieved'	Maps for each assessment area/MRU of total loss or adversely affected (by levels) per BHT, including areas marked as 'not assessed'/status 'unknown'. Map of BHT status (good, not good, not assessed/status unknown)	Line graph for each assessment area/MRU of cumulative total area lost or adversely affected (by levels) per BHT and for the six-year assessment period

»» Gaps in knowledge and outstanding issues

Knowledge gaps

The assessment of benthic habitats is complex by nature and includes a huge variety of different ecosystem components and taxonomic levels. Furthermore, the likely cumulative impact of a variety of anthropogenic pressures and natural events makes it difficult to define concrete pressure-state relationships. Mapping of cumulative disturbances is a challenge in itself, e.g. due to differing resolution of data. Hence, many challenges remain and will affect the confidence of the assessments. Many issues are addressed in the guidance on assessing seafloor integrity and benthic habitats above; here only the most important knowledge gaps are listed, which need to be resolved to improve the assessment of benthic habitats significantly in the future:

More work is necessary to clarify:

- How to estimate the spatial extent of activity-pressures (even valid for where pressure data is point-based).
- How to establish pressure/state relationships for relevant habitats.
- How to define and include habitat quality, sensitivity and resilience in the assessments.

- To improve confidence in habitat maps, particularly through undertaking high resolution mapping in poorly mapped areas, using state-of-the-art techniques (e.g. multibeam echosounder with adequate substrate type and biological ground validation) based on (sub)regionally clearly defined delineation methodology for habitat types.
- To improve the EUNIS habitat classification, both to ensure coverage of all areas (particularly gaps in the North-East Atlantic), and to better validate the higher levels (4-6) through improved analysis with *in situ* data and high-quality spatial habitat maps.

Outstanding issues

Outstanding issues for D1/D6 assessments include, among others:

- How to aggregate the assessment from different sub-habitat types up to BHT.
- The need to develop spatial impact layers for pressure types other than physical disturbance and loss; if other descriptors provide spatial information, these could likely be used as pressure layers.
- How to deal with the variation in confidence of maps using modelled data (e.g. EUSeaMap), and how confidence affects the assessment.
- How to integrate both quantitative and qualitative assessments, jointly for the assessment of adverse effects as well as the functioning and structure of benthic habitats.
- The necessity to establish commonly agreed reference conditions and baselines against which disturbance and loss is to be assessed, especially in the light of using assessments of other policies with potentially different baselines (e.g. against 2012 for the first MSFD assessment, and often 1992 for the Habitats Directive).
- How to best align the reporting of other policies to better support the use of their assessments for MSFD purposes.
- How to align the reporting of 'pressure' criteria and 'state' criteria. If D6C5 builds on many criteria of other descriptors, it should be assessed last to allow time for integrating the results of those criteria.
- How to handle assessment results from pressure-based assessments in cases where the quality threshold values differ (significantly) from those in D6C5.
- How to integrate human-induced seabed geomorphic change at various scales (up to 10s of meters in the vertical dimension and 10's to 1000's of km in the horizontal dimension) into D6 assessments.

5.8 Descriptor 4: Food webs

Descriptor 4: All elements of the marine food webs, to the extent that they are known, occur at normal abundance and diversity and levels capable of ensuring the long-term abundance of the species and the retention of their full reproductive capacity. (MSFD Annex I)

DESCRIPTOR PROFILE		D4C1 Diversity of the trophic guild	D4C2 Balance of abundance between trophic guilds	D4C3 Size distribution of individuals across the trophic guild	D4C4 Productivity of the trophic guild
Features		Coastal ecosystems; Shelf ecosystems; Oceanic/deep-sea ecosystems			
Primary criterion		X	X		
Information type		State	State	State	State
Annex III MSFD	State (Table 1)	Ecosystems, including food webs			
	Pressure (Table 2a)	Extraction of or mortality/injury to wild species including target and non-target species			
	Activity (Table 2b)	Fish and shellfish harvesting (professional and recreational)			
GES DecisionI	Elements	(Sub)regional	(Sub)regional	(Sub)regional	(Sub)regional
	Threshold values	(Sub)regional	(Sub)regional	(Sub)regional	(Sub)regional
	Use of criteria	(Sub)regional			
Criteria linkages		D1C2*, D3C2*	D1C2*, D1C6*, D2C2*, D3C2*, D5C2*	D1C3*, D3C3*	D1C2*, D1C3*, D3C2*, D3C3*
Descriptor linkages		D1*, D2*, D3*, D5*, D6*			

*Not included in the GES Decision

The development of a common understanding of Member States on the role of D4 food webs in MSFD assessments was not a priority in MSFD implementation so far, notwithstanding the fact that D4 is cross-cutting and will require regional input parameters being developed for other descriptors. Hence, at present national and regional approaches vary widely, and relevant gaps exist to date in assessing and reporting the status of D4. While elements, threshold values and integration rules require agreement by Member States through regional cooperation, a common understanding of the assessment framework at EU level ensures that assessments of D4 are comparable across marine regions.

To date, Member States have developed or are developing in their marine regions selected indicators, either specifically for D4 or for other descriptors, which can support future assessments of food webs. The following section provides examples of types of indicators used in marine regions but does not list specific regional indicators. The examples of indicator types are not intended to be comprehensive or conclusive at this stage of discussion. Relating specific regional indicators to criteria will be part of further detailed discussions on the assessment framework.

The following section is based on ICES' Technical Service (2021)¹¹⁵. It presents a first suggestion for a conceptual assessment approach to D4. It provides a starting point for Member States to develop, through further EU and regional cooperation, a coherent food web assessment framework with a view to guiding assessments beyond 2024. The presentation below provides an opportunity for Member States, nationally and through regional cooperation, to test recommendations in assessment of individual guilds for 2024 and thereby aid continued discussions on the assessment framework. The presentation below triggered a large number of detailed and technical questions which will serve expert discussions as a starting point to further consider, specify and develop this initial guidance.

Elements

Trophic guild definition

Guilds preferably represent at least the top, middle and bottom of the food chain. Table 5.8-1 suggests a minimum set of guilds relevant to all regions. The suggested list of guilds is intended to ensure that comparison between different components of a "food web" is possible. The suggested guilds can be further subdivided into sub-guilds (e.g. sub-apex demersal predators feeding on smaller items and sub-apex demersal predators feeding on larger prey items) where relevant for the assessment area and agreed regionally. Further guilds can be added where this is considered key to the food web in the marine region.

For example, marine birds are currently not included in the suggest list of guilds as they often have limited impact on the biomass of the other guilds at a regional scale, though obviously, exceptions to this appear as do bottom-up impacts on marine birds. Adding these to the suggested list of guilds would require all regions to consider these. Instead, the recommendation is to include additional guilds if these appear as a key to the food web in the marine region. Defining guilds will require further detailed discussion.

Table 2: Suggested minimum set of trophic guilds to enhance regional comparability.

Guild	Description	Example species/groups
Pelagic primary producers	Phytoplankton	Diatoms, dinoflagellates
Benthic primary producers	Macrovegetation, included where relevant for the food web assessment area	Seagrass meadows, kelp forests
Secondary producers	Mesozooplankton (200 micron–20 mm)	Copepods, cladocerans
Benthic filter-feeding invertebrates	Benthic filter-feeding invertebrates, included where relevant for the food web assessment area	Mussel, scallops, brittle stars
Benthic feeding invertebrates	Benthic invertebrates feeding predominantly on detritus or other benthic invertebrates, and/or constituting prey for sub-apex predators.	<i>Nephrops</i> , crabs, shrimps
Planktivorous fish and invertebrates	Fish and invertebrates feeding predominantly on zooplankton	Anchovy, herring, horse mackerel, jellyfish
Sub-apex pelagic predators	Fish and invertebrates feeding pelagically on fish and other prey types	Mackerel, saithe, tunids, Loligo
Sub-apex demersal predators	Fish and invertebrates feeding demersally or on the bottom on fish and other food	Sole, hake, haddock, octopus
Apex marine mammal predators	Marine mammal piscivores feeding on sub-apex predators	Killer whale
Apex fish predators	Fish piscivores feeding on sub-apex predators	Large tuna, large cod, large sharks

¹¹⁵ https://ices-library.figshare.com/articles/report/EU_request_for_a_Technical_Service_on_MSFD_Article_8_guidance_on_undertaking_assessments_for_Descriptor_3_commercially_exploited_fish_and_shellfish_and_Descriptor_4_marine_foodwebs_/18639710

Assigning individuals to guilds in a food web assessment area

The guild concept is broader than a simple estimation of trophic level by species. However, estimates of trophic level may help to assign species to guilds. Estimated trophic levels can be derived from a variety of sources and methods including from literature, diet analyses, ecosystem models, stable isotope analyses, and genetic analyses. Species could also be assigned to guilds based on diet composition at a given size, although this requires more data. Estimated diet composition can vary between locations and depths for the same species, as well as between different assessments, seasons, and years. Hence, estimations may need to be repeated to ascertain whether diet compositions change over space and time.

A species often belongs to different guilds through its life cycle (e.g. planktivorous, benthivorous, and finally piscivorous). With the rather broad guild categories given in Table 5.8-1, most species will remain in a guild for the duration of their life after the early stages (e.g. flatfish will remain in 'sub-apex demersal predators' and herring in 'planktivorous fish and invertebrates'). However, there are species that grow sufficiently large to achieve a diet with a large contribution of sub-apex predators, thus making them apex predators at large sizes. Such species can be allocated to different guilds at different ages or sizes.

Stocks or assessed populations straddling several food web assessment areas such as mackerel, tuna and larger whales, should contribute to a certain food web assessment area depending on the proportion of the stock residing in the area and the time spent in it. It is recommended to include non-indigenous species (NIS) in an assessment of D4 as they often make an important contribution to the food web in terms of biomass. They may also trigger a shift in classical trophic pathways without significantly contributing to biomass, as exemplified for NIS of jellyfish. It is noted that, in some instances, including specific NIS in an assessment of D4 may improve the status of some food web indicators as the NIS species may fill a gap in the food web and contribute critically to required biomass. This 'positive result' will contradict the objective to reduce the introduction and spread of NIS under D2. Further consideration is required how to reconcile the trade-offs between different management objectives, also in terms of how to communicate the results of different assessments.

Indicator estimation considerations with respect to guilds

If information only exists for some of the species included in the assessed guild, the guild can still be assessed as long as the species included are considered representative of the entire guild. All individuals contributing to a guild cannot be monitored in the marine environment. Instead, the guild-based indicators are based on the monitoring or modelling of representative components in the ecosystem. In cases where guilds are monitored through only a few of their components, it is particularly important to investigate whether these components are likely to be representative of the remainder of the guild.

Considering that abundance estimates of individuals which are small relative to the items targeted by the sampling tool or fragile are often highly uncertain, adding data on these smaller individuals may add more noise than signal to the estimated food web indicators. In order to ensure that signals in data are not swamped by uncertainty, smaller individuals can be excluded from the indicator estimation assigning species to guilds based on diet from the life stages at which reliable data on e.g. size and biomass becomes available. This lower size or age cut-off should be constant through time.

»» Assessment areas and scales

Food webs should be assessed at the scale of marine ecosystems, requiring regional coordination. Assessments can be undertaken at the subregional scale provided there is scientific evidence showing that this is a more appropriate scale to assess the trophic guilds and their links to other descriptors. Only in rare cases, it may be appropriate to assess food webs solely in relation to Member State's national waters. However, if a Member State collects information to suggest that smaller areas are consistent with these requirements, additional food web assessments can be completed for these smaller areas.

The spatial scale at which the food web is assessed should be selected to be relevant to most guilds. The food web assessment area should be chosen to either have limited migration/exchange or good information on the timing and extent of migration/exchange. Compatibility of results with those of other descriptors can be fulfilled by assessing food webs in a spatial area where there is limited net transport of biomass across the area boundary for the concerned guilds. It is noted that some pragmatism is required when combining data to one assessment area from different components of the ecosystem that vary in spatial distribution or when for example using results from other descriptors given that they may also relate to varying spatial scales depending on the assessment context.

One option to define assessment areas could be to relate to areas corresponding to specific mean depths: Each food web assessment area would be assigned as either 'coastal' (mean depth 0–50 m), 'shelf' (50–200 m), 'slope' (200–800 m), or 'deep' (> 800 m). Such an approach would require further discussion.

It should be noted that while entirely pelagic food webs can be analysed where relevant, based on the selection of trophic guilds included in the assessment, they are still assigned to one of these four features according to the bottom depth.

»» Temporal aspects of assessment

The six-year period for the assessment due for reporting in 2024 should be 2016–2021 and should be applied uniformly within and across marine regions. If this is not feasible, e.g. due to a mismatch between reporting periods of other EU legislation and MSFD, differences in assessment periods may occur. For assessment period, trend assessment and change of status see → section 2.2.5 and 2.4.

To reflect the status of the descriptor within the six-year assessment period, indicator status in each of the six years should ideally be considered in the evaluation. As results of D4 are dependent on results under D1, D2, D3, D5, and D6, the calendar years in this six-year assessment period should be coordinated across these descriptors. The assessment of D4 is based on the average indicator over the assessment period. If possible, the status assessment should be accompanied by a description of trends to facilitate the use of D4 as an early warning indicator of changes in the food web.

»» Spatial aggregation of assessment

The need for further guidance on spatial aggregation of assessments still needs to be explored in the light of the different scales and types of biota assessments that are to be combined in the assessment.

»» Threshold values

It is recommended to use indicators for the assessment of all four criteria under D4, giving priority to the two primary criteria. Indicators should be assessed separately for each guild.

As the indicators are expected to be highly impacted by natural variation and complex interactions, threshold values should be defined as ranges, with lower and upper levels. The threshold range should encompass natural variability and the possibility of the indicator to reflect structural changes over time, thus long-term observations are required. Indicator values inside the threshold range correspond to good status for the specific guild.

Data for a species/stock should be consistent with the estimated biomass within the food web assessment area under all D4 criteria, and the indicator assessment requires consideration of cross descriptor spatial coherence between D1, D2, D3, D5, and D6.

Indicators for D4C1: diversity of the guild

Indicators for this criterion should reflect the relative abundance of species (also known as species dominance) or the relative change in abundance of species within the guild. Examples include diversity indices such as the Simpson or Shannon indices. Indicators should preferably measure abundances in terms of biomass to ensure consistency with D4C2. Indicators of the proportion of species that are increasing/decreasing (e.g. for marine birds; OSPAR/HELCOM/ICES JWGBIRD, 2020) can also be used if they reflect development in a guild and even if they do not reflect species diversity directly.

Data at the lowest available and applicable taxonomic level should be used. Where several stocks or assessed populations of a species reside within the food web assessment area, these stocks or assessed populations are treated as separate entities in the diversity analysis. Data representing several taxonomic levels can be included in the analysis as long as data for a specific stock/species only appears once (e.g. division between *Sepia elegans* and 'all other Sepiidae').

Indicators for D4C1 are only applicable for guilds that contain at least two species/species groups. Where taxonomic information is not available for a guild, a D4C3 indicator based on size distribution should be used instead.

Indicators for D4C2: balance in abundance of guilds

D4C2 relates to the balance of total abundance between guilds. The following section focusses on the estimation of biomass per guild as a first step. The balance of abundance between guilds is assessed in the subsequent integration of guild-specific results. Guidance on assessing the balance of abundance between guilds still needs to be developed (→ 'Use of criteria' below).

All regionally relevant guilds should be included in D4C2 to allow for the subsequent assessment of the balance between guilds. The indicators used to assess D4C2 should provide estimates of development in the biomass of each guild, which should be scaled to provide information on total biomass of the guild in the food web assessment area. Additionally, information on the surface area (in km²) of the food web assessment area should be included to facilitate comparisons with other assessment areas and (possibly) regions. Regional agreement on the way in which biomass for any non-assessed species or subareas is included is key to the assessment result.

The biomass estimates can be attained in various ways. Common for most approaches is that they use models (simple as well as complex) to derive biomass from samples, which usually represent temporal development. Biomass is ideally estimated from repeated annual wide scale sampling

corrected for changes in sampling efficiency, or by modelled biomass. Where biomass changes greatly between seasons, the indicators should reflect biomass in each season as well as season length in a way that allows comparison with biomass in other guilds. If seasonal data are not available, information about timing and length of the season should be explicitly provided and monitored season should be consistent over time and qualitative information on the expected representability of the data and variation between seasons provided. The applied approaches should be regionally agreed upon and quality assured to ascertain their capacity to estimate biomass.

- *Biomass of primary producers (pelagic and benthic)*
 Can, as a minimum acceptable indicator, be assessed using ocean greenness (i.e. using remote sensing) together with a transformation factor to convert quantitative observations to biomass. These *in situ* observations can be supplemented using numerical biogeochemical models. Methods and indicators developed for D5 or D1 pelagic habitats (phytoplankton biomass) can be used either to supplement observations and models or as standalone estimates where they are appropriate for the entire food web assessment area and annual phytoplankton development cycle.
- *Biomass of secondary producers: mesozooplankton (200 micron–20 mm)*
 Is ideally estimated from repeated annual wide scale sampling. This can, however, be difficult to attain due to low or inconsistent sampling effort, as well as due to small or fragile individuals. Member States are encouraged to initiate coordinated widespread spatiotemporal sampling of mesozooplankton to ensure that the large variability in e.g. spring blooms is covered, and to make use of existing data whenever possible. Mesozooplankton biomass is ideally estimated from repeated annual wide scale sampling corrected for changes in sampling efficiency.
- *Biomass of benthic filter-feeding invertebrates*
 Should, as a minimum, include the biomass of benthic filter-feeding invertebrates, using assessments under D3, D5, or D6, as far as these are relevant. Where species biomass data is considered unreliable or highly uncertain, it should not be included. The biomasses of species which are not assessed should be investigated to ideally determine the likely scale of their contribution to the guild biomass.
- *Biomass of benthic-feeding invertebrates*
 Should, as a minimum, include the biomass of assessed stocks of benthic-feeding invertebrate predators under D3, D5, or D6. Where species biomass data is considered unreliable or highly uncertain, it should not be included. The biomasses of species which are not assessed should be investigated to ideally determine the likely scale of their contribution to the guild biomass.
- *Biomass of planktivorous fish and invertebrates*
 Should, as a minimum, be assessed using all existing stock assessments of planktivorous fish and invertebrates. Information from surveys can be added for species which are not assessed, using methods such as those of Yang (1982) or Walker et al. (2017) to adjust for differences in catchability. The biomasses of species which are not assessed and not representatively caught in surveys should ideally be investigated to determine the likely scale of their contribution to the guild biomass. Where species biomass estimates are considered unreliable or highly uncertain, they should not be included in indicators under D4. This will generally include the large undersampled biomass of individuals < 5–10 cm. The exact cut-off level within this span will depend on regional monitoring methods but should remain

constant over assessment years. Additional taxa that may be relevant in some assessment areas include filter-feeding animals such as baleen whales (D1) and jellyfish.

- *Biomass of sub-apex pelagic predators*
Should, as a minimum, be assessed using all existing stock assessments of sub-apex pelagically feeding fish and invertebrates. Information from surveys can be added for species which are not assessed using methods such as those of Yang (1982) or Walker et al. (2017). The biomasses of species which are not assessed and not representatively caught in surveys should ideally be investigated to determine the likely scale of their contribution to the guild biomass. Where species biomass estimates are considered unreliable or highly uncertain, they should not be included in indicators under D4. This will generally include the large undersampled biomass of individuals < 5–10 cm. The exact cut-off level within this span will depend on regional monitoring methods but should remain constant over assessment years. Additional taxa that may be relevant in some assessment areas include pelagically feeding marine birds assessed under D1.
- *Biomass of sub-apex demersal predators*
Should, as a minimum, be assessed using all existing stock assessments of sub-apex demersally feeding fish and invertebrates. Information from surveys can be added for species which are not assessed using methods such as those of Yang (1982) or Walker et al. (2017). The biomasses of species which are not assessed and not representatively caught in surveys should ideally be investigated to determine the likely scale of their contribution to the guild biomass. Where species biomass estimates are considered unreliable or highly uncertain, they should not be included in indicators under D4. This will generally include the large undersampled biomass of individuals < 5–10 cm. The exact cut-off level within this span will depend on regional monitoring methods but should remain constant over assessment years. Additional taxa that may be relevant in some assessment areas include demersally feeding marine birds assessed under D1.
- *Biomass of apex fish predators (and invertebrate predators)*
Should as a minimum be assessed using all existing stock assessments of predators on sub-apex predators. As a minimum, the estimated biomass should use all existing stock assessments, adding information from surveys for species which are not assessed. Species that grow into being apex predators at a specific size or age can be included by agreeing regionally to split their biomass according to size or age, e.g. into sub-apex and apex predators. Note that if biomass of the species is included in e.g. the sub-apex predators, the same biomass should not also be included in apex predators.
- *Biomass of apex marine mammal predators*
Should include the combined biomass estimates of mammals feeding on sub-apex predators. Examples include mammals monitored under D1. Where only abundances in numbers are available, information on mean weight of individuals can be used to derive biomass.

Indicators for D4C3: size distribution within guilds

D4C3 refers to the size distribution across trophic guilds. The following section focusses on size distribution within guilds to reach an assessment result per guild (as a first step). Size distribution across trophic guilds is assessed in the subsequent integration of guild-specific results. Guidance on assessing size distribution across trophic guilds still needs to be developed (→ ‘Use of criteria’ below).

A size distribution indicator within a guild reflects a species' population composition, growth, and total mortality. Therefore, assessment results using indicators under D4C3 are not independent of the indicators and their results under the other criteria.

Further, size-based indicators are reliant on information on size distribution of the community, and the estimated indicator is highly dependent on the size selectivity of the method used to derive the data. Data on length distribution of individuals within the guild can be derived from either scientific surveys, stock assessments, or literature. The method used to derive the input data must be consistent over time.

Potential data sources include catch rates from scientific monitoring and surveys, commercial catches, commercial landings, and age- or size-based stock assessments (age-based assessments should be combined with information on length distribution-at-age). Among these, survey catch rates and stock assessments are considered most reliable, as commercial catch data will be based on a variety of fishing gears each with its own size selectivity. Commercial landings are not considered appropriate because of the unknown quantity of discards of particularly smaller fish.

Indicator estimation should be performed separately for each guild, and biomass measures should be used preferably to ensure consistency with D4C2. Examples of size-based indicators applied for fish and zooplankton include the large fish indicator (LFI), typical/median/mean/95th percentile of length, and mean maximum length (MML). Among these, median or 95th percentile length is preferred over mean length due to the greater stability of the median when applied to highly skewed data. The LFI relies on the estimation of the size of a 'large fish' to be estimated separately by guild and region, and the indicator is therefore not directly comparable between regions but may provide useful results within a region. Mean maximum length (MML) integrates aspects of species diversity and size structure (mean possible length in the guild) and has the advantage that it can be estimated without information on size distribution of individuals in the guild. It is, however, less responsive to changes in mean size in the guild than median length and if used, the source of the maximum length used in the study should be clearly given and maximum length should be constant over time within the region. Size indicators can be based on weight or length.

If only one species is present in the guild and this species is already assessed under D1 or D3, for consistency, it is recommended to reuse the relevant assessment outcome for D4C3.

Indicators for D4C4: productivity of the guild

Examples of indicators that can be used to assess the productivity of a guild include primary productivity, mean recruitment success, mean somatic growth, mean condition factor, and mean total mortality within a guild (ICES, 2014; Shephard et al., 2014; Eero et al., 2015). Several of these aspects are highly variable, spatially as well as over the course of the year, and the indicators should therefore be estimated at the same time of year and for a fixed spatial coverage.

If only one species is present in the guild and this species is already assessed under D1 or D3, for consistency, it is recommended to reuse the relevant assessment outcome for D4C4.

Productivity has a large influence on biomass development and any change in productivity is likely to be followed by a subsequent change in D4C2. Hence, D4C4 can provide early warning for changes in D4C2. For this link to be direct, the species included in a guild under this criterion should be representative of species included under D4C2.

Identification of appropriate threshold values

Threshold values should be developed both for criteria and guilds as well as at the integration level where balance between guilds is assessed.

There are as yet no agreed methods to estimate threshold values for food web assessments under D4C1-D4C4. Further, as parameters being measured under D4 criteria are expected to be impacted by large natural variability, it will be difficult to assign a direct link to specific human pressures and hence to management actions. It has been suggested that food web indicators can be used in management as early warning indicators, eliciting either further study or precaution in management aimed at other descriptors.

»» Use of criteria

Methods to integrate the different guilds or monitor the balance of the food web within (e.g. D4C2, D4C3) and across criteria are still not at a development stage where they can be tested or where peer-reviewed approaches are commonly agreed upon. This is a key issue that needs to be addressed before assessing the overall status of the food web from the monitored guilds.

The evaluation of the balance of the food web is highly dependent on the guilds selected for assessment. All assessed guilds should be included in the integration.

There have been suggestions to base integration on various weighting approaches, the most notable being the mean trophic level (MTL). The MTL indicator is interpretable as the average trophic level of a unit of biomass in the system and is essentially the sum of guild biomass times the guild trophic level divided by total biomass. However, it is unclear how the indicator relates to balance between guilds and the balance between pelagic and demersal guilds.

Further work is required to develop integration methods reflecting the balance of the food web. However, the lack of agreed integration methods should not be used as an excuse to refrain from reporting the status of individual guilds.

»» Confidence

Confidence should be assessed at the level of individual guilds and criteria. The confidence assessment should, as a minimum, reflect the degree to which the assessed indicators cover each guild, its spatial and temporal relevance, and confidence in data sources and methods. Further work is required to develop guidelines for confidence assessments of D4.

»» Visualising assessment results

Assessment results for guilds should be visually presented using pie charts with each of the four criteria having a quarter (Figure 5.8-1). Quarter colour depicts the status of each criteria for the guild (clockwise, criteria D4C11, C2,C3, and C4). The pie size can potentially be scaled to reflect total guild biomass, although a minimum size will have to be applied to smaller guilds to ensure that they are readable. The figure is ordered according to the position of the guild in the water column and could be accompanied by pictures/icons of species representing the guild. Any guilds that are not applicable in the food web assessment area would be omitted, or they could be visualized by a white circle when needed to clarify if the lack of assessment results is explained by lack of assessment or lack of ecological relevance (see definition of status as 'not assessed' or 'unknown' in → section 2.2.7). Further guidance on how to visualise the assessment result for D4C2 (comparing biomass across guilds) is still to be developed and will also depend on integration rules that are still under development.

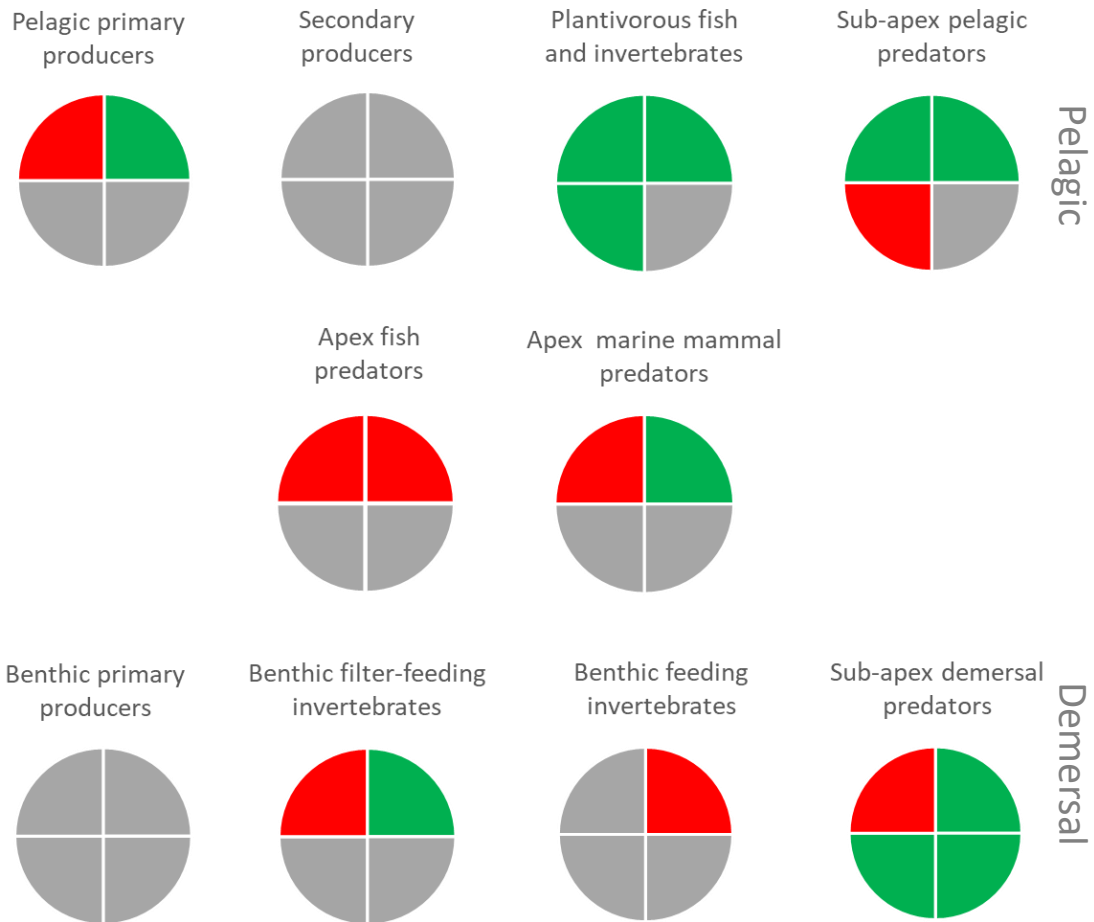

Figure 5.8-1: Example to visually represent the assessment results per guild and assessment area when assessments are done. Status of guild: red – not good; green – good, grey – unknown.

»» Gaps in knowledge and outstanding issues

Gaps in knowledge

- Climatic impact: For D4, as a minimum, enhanced studies are required to improve our understanding of how climate change affects the food web and how this needs to be taken into account when developing indicator assessments and/or the setting of threshold values.
- Data availability: Availability of data, adequacy of current monitoring programmes and role of models to support the assessment of a minimum set of guilds and of the D4 criteria need to be explored and better understood.

Outstanding issues

Further develop the assessment framework for D4 and close identified guidance gaps, including:

- Technical specifications relating to the definition of guilds.
- The development of agreed methods to monitor the balance of the food web to advance the assessment of food web status.
- Derive agreed methods to define thresholds. The development of methods should consider consistency across relevant descriptors/criteria and include expression of uncertainties. Also

noting that for food webs a surveillance indicator type of approach may be required, allowing fluctuation but only when either and upper or lower maximum boundary of fluctuation is exceeded would it trigger a concern that the food web is not in GES.

- Develop guidance on open issues such as spatial aggregation, as needed, and confidence assessment.
- Develop integration methods across guilds and criteria and to reflect the balance of the food web.
- Develop guidance on implications of D4 assessment across descriptors: Observed ecosystem and food web changes can provide information needed for improving the predictions of future stock productivity under Descriptor 3. For example, changes to the abundance and composition of zooplankton, as often anticipated under climate change, are likely to impact the productivity of planktivorous fish, including the larval stages of most of the commercially exploited stocks. Another example could be when an increased population of marine mammals is likely to result in a sustained elevated natural mortality of their prey (Descriptor 1). Further, non-indigenous species introduced or migrating into a new area (Descriptor 2) may increase in abundance to the level where they significantly alter the food web, either increasing predation, decreasing food abundance, or providing a new alternative food source. All of these provide easy to understand examples of interactions between assessment elements of Descriptors 1, 2, and 3, mediated through food webs as assessed under D4
- Additionally, D4C4 productivity measures should be detailed and reviewed from a technical point of view with the aim to recommend whether the criterion should remain secondary or should be proposed to change to a primary criterion.

6. References and literature

1. Introduction

- BSC, 2019. Black Sea State of the Environment Report 20092014/5, <http://www.blacksea-commission.org/Inf.%20and%20Resources/Publications/SOE2014/>
- Commission Decision (EU) 2017/848 of 17 May 2017 laying down the criteria and methodological standards on good environmental status of marine waters and specifications and standardised methods for monitoring and assessment, and repealing Decision 2010/477/EU, referred to as ‘GES Decision’, <https://eur-lex.europa.eu/legal-content/EN/ALL/?uri=CELEX%3A32017D0848>
- Commission Directive (EU) 2017/845 of 17 May 2017 amending Directive 2008/56/EC of the European Parliament and of the Council as regards the indicative lists of elements to be taken into account for the preparation of marine strategies, referred to as ‘Annex III MSFD’, <https://eur-lex.europa.eu/legal-content/EN/TXT/?uri=CELEX%3A32017L0845>
- Communication from the Commission (2022/C 118/01): Commission Note on recommendations per Member State and region on the 2018 updated reports for Articles 8, 9 and 10 of the Marine Strategy Framework Directive (2008/56/EC): <https://eur-lex.europa.eu/legal-content/EN/TXT/?uri=CELEX%3A52022XC0314%2801%29&qid=1647271585632>
 accompanied by:
 Commission Staff Working Document SWD(2022) 55 final, accompanying Commission Note (2022/C 118/01): https://ec.europa.eu/environment/marine/eu-coast-and-marine-policy/implementation/pdf/SWD_2022_55_3_EN.pdf
- National technical reports of Member State’s 2018 updates of MSFD Article 8, 9, 10: <https://ec.europa.eu/environment/marine/eu-coast-and-marine-policy/implementation/pdf/National%20technical%20reports%20MSFD%202018.zip>
- Regional technical reports of Member State’s 2018 updates of MSFD Article 8, 9, 10: <https://ec.europa.eu/environment/marine/eu-coast-and-marine-policy/implementation/pdf/Regional%20technical%20reports%20MSFD%202018.zip>
- JRC reviews of 2018 Member States’ 2018 reports under Article 8 MSFD: <https://mcc.jrc.ec.europa.eu/main/dev.py?N=18&O=460>
- Directive 2008/56/EC of the European Parliament and of the Council of 17 June 2008 establishing a framework for community action in the field of marine environmental policy (Marine Strategy Framework Directive), referred to as ‘MSFD’, <https://eur-lex.europa.eu/legal-content/EN/TXT/?uri=CELEX:32008L0056>
- EU MSFD CIS Article 8 Assessment Guidance (test version 2017): <https://circabc.europa.eu/rest/download/cea61b55-06df-4e9e-9830-b0f41ca46fbe?ticket=>
- EU MSFD CIS Guidance Document No. 1: Economic and Social Analysis for the Initial Assessment for the Marine Strategy Framework Directive: A Guidance Document, April 2018. <https://circabc.europa.eu/ui/group/326ae5ac-0419-4167-83ca-e3c210534a69/library/83ab5944-211a-40ac-a398-67d1de36d30e/details>
- EU MSFD CIS Guidance Document No. 14: Reporting on the 2018 update of articles 8, 9 & 10 for the Marine Strategy Framework Directive, April 2018 (under review for 2024 reporting): <https://circabc.europa.eu/ui/group/326ae5ac-0419-4167-83ca-e3c210534a69/library/5b9e26e4-e03c-4a45-a4b0-f510592803d2/details>
- Worked examples: <https://circabc.europa.eu/ui/group/326ae5ac-0419-4167-83ca-e3c210534a69/library/ce41fc38-1835-4810-b27c-cc2fc5cf6cd4/details>
- HELCOM, 2018. State of the Baltic Sea. Second HELCOM holistic assessment 20112016. Baltic Sea Environmental Proceedings No. 155, <http://stateofthebalticsea.helcom.fi/>
- OSPAR, 2017. Intermediate Assessment 2017. <https://oap.ospar.org/en/ospar-assessments/intermediate-assessment-2017/>
- Report from the Commission to the European Parliament and the Council on the implementation of the Marine Strategy Framework Directive (Directive 2008/56/EC), COM(2020) 256 final: <https://eur-lex.europa.eu/legal-content/EN/TXT/PDF/?uri=CELEX:52020DC0259&from=EN>

Accompanied by:

Commission Staff Working Document, SWD(2020)60 final – Annex on implementation: <https://eur-lex.europa.eu/legal-content/EN/TXT/?uri=CELEX%3A52020SC0060>

Commission Staff Working Document, SWD(2020)61 final – Annex on state of EU seas and oceans: <https://eur-lex.europa.eu/legal-content/EN/TXT/?uri=CELEX%3A52020SC0061>

Commission Staff Working Document, SWD(2020)62 final – Annex on horizontal issues on implementing the MSFD: <https://eur-lex.europa.eu/legal-content/EN/TXT/?uri=SWD:2020:62:FIN>

UNEP/MAP-MED POL, 2017. 2017 Mediterranean Quality Status Report, https://www.medqsr.org/sites/default/files/inline-files/2017MedQSR_Online_0.pdf

2. Overarching principles and approaches

Birds Directive, Directive 2009/147/EC of the European Parliament and of the Council of 30 November 2009 on the conservation of wild birds, <https://eur-lex.europa.eu/legal-content/EN/TXT/?uri=CELEX%3A32009L0147>

Commission Staff Working Document, SWD(2020)62 final – Annex on horizontal issues on implementing the MSFD: <https://eur-lex.europa.eu/legal-content/EN/TXT/?uri=SWD:2020:62:FIN>

Habitats Directive, Council Directive 92/43/EEC of 21 May 1992 on the conservation of natural habitats and of wild fauna and flora, <https://eur-lex.europa.eu/legal-content/EN/TXT/?uri=CELEX:31992L0043>

Water Framework Directive (WFD), Directive 2000/60/EC of the European Parliament and of the Council of 23 October 2000 establishing a framework for Community action in the field of water policy, <https://eur-lex.europa.eu/legal-content/EN/TXT/?uri=CELEX:32000L0060>

2.1 Integrated assessment framework

2.1.1 Assessment aspects

Commission Staff Working Document, SWD(2020)62 final – Annex on horizontal issues on implementing the MSFD: <https://eur-lex.europa.eu/legal-content/EN/TXT/?uri=SWD:2020:62:FIN>

MSFD CIS Workshop, 2020. Horizontal Issues Workshop: Threshold values, Workshop report 2021, GES_24-2021-04, https://circabc.europa.eu/ui/group/326ae5ac-0419-4167-83ca-e3c210534a69/library/57c639b6-85f7-40ad-9e04-e39694be148b?p=1&n=10&sort=modified_DESC

Water Framework Directive (WFD), Directive 2000/60/EC of the European Parliament and of the Council of 23 October 2000 establishing a framework for Community action in the field of water policy, <https://eur-lex.europa.eu/legal-content/EN/TXT/?uri=CELEX:32000L0060>

2.1.2 Integrated aspects: Multiple Pressures and combined effects

Biodiversity Strategy 2030. Communication from the Commission to the European Parliament, the Council, the European Economic and Social Committee and the Committee of the Regions, EU Biodiversity Strategy for 2030 – Bringing nature back into our lives, COM(2020) 380 of 20.05.2020, <https://eur-lex.europa.eu/legal-content/EN/TXT/?qid=1590574123338&uri=CELEX%3A52020DC0380>

EEA, 2019. Marine messages II, EEA Report No 17/2019, <https://www.eea.europa.eu/publications/marine-messages-2>.

EC, 2019. Communication from the Commission to the European Parliament, the European Council, the Council, the European Economic and Social Committee and the Committee of the Regions, The European Green Deal, COM(2019) 640 final of 11.12.2019, <https://www.politico.eu/wp-content/uploads/2019/12/The-European-Green-Deal-Communication.pdf>

ETC/ICM, 2019. Multiple pressures and their combined effects in Europe's seas, ETC/ICM Technical Report 4/2019, European Topic Centre for Inland, Coastal and Marine Waters, <https://www.eionet.europa.eu/etcs/etc-icm/products/etc-icm-report-4-2019-multiple-pressures-and-their-combined-effects-in-europes-seas>

HELCOM, 2018. Thematic assessment of cumulative impacts on the Baltic Sea 2011-2016. Baltic Sea Environment Proceedings No. 159. Available at: <http://www.helcom.fi/baltic-sea-trends/holistic-assessments/state-of-the-baltic-sea-2018/reports-and-materials/>

- Korpinen, S. & Andersen, J.H., 2016. A global review of cumulative pressure and impact assessments in marine environment. *Frontiers in Marine Science*, <http://dx.doi.org/10.3389/fmars.2016.00153>
- Korpinen, S., Laamanen, L., Bergström, L., Nurmi, M., Andersen, J.H., Haapaniemi, J., Harvey, E.T., Murray, C.J., Peterlin, M., Kallenbach, E., Klančnic, K., Stein, U., Tunesi, L., Vaughan, D., and Reker, J., 2021. Combined effects of human pressures on Europe's marine ecosystems. *Ambio*, <https://dx.doi.org/10.1007/s13280-020-01482-x>
- Maritime Spatial Planning Directive (MSPD). Directive 2014/89/EU of the European Parliament and of the Council of 23 July 2014 establishing a framework for maritime spatial planning, <https://eur-lex.europa.eu/legal-content/EN/TXT/?uri=celex%3A32014L0089>
- OSPAR, 2017: Intermediate Assessment 2017, <https://oap.ospar.org/en/ospar-assessments/intermediate-assessment-2017/chapter-6-ecosystem-assessment-outlook-developing-approach-cumul/>

2.2.1 Primary and secondary criteria

- Commission Staff Working Document, SWD(2020)62 final – Annex on horizontal issues on implementing the MSFD: <https://ec.europa.eu/info/sites/default/files/swd202062final.pdf>

2.2.2 Criteria elements for assessment

- Commission Staff Working Document, SWD(2020)62 final – Annex on horizontal issues on implementing the MSFD: <https://eur-lex.europa.eu/legal-content/EN/TXT/?uri=SWD:2020:62:FIN>

2.2.3 Assessment areas and scales

- BSC, 2017. Black Sea Integrated Monitoring and Assessment Program for years 2017–2022 (BSIMAP 2017–2022), 2017, https://ec.europa.eu/environment/marine/international-cooperation/regional-sea-conventions/bucharest/pdf/BSIMAP_2017_to_2022_en.pdf
- Commission Staff Working Document, SWD(2020)62 final – Annex on horizontal issues on implementing the MSFD: <https://ec.europa.eu/info/sites/default/files/swd202062final.pdf>
- HELCOM, 2013. HELCOM Monitoring and Assessment Strategy, Ministerial Meeting 2013, <https://helcom.fi/media/publications/Monitoring-and-assessment-strategy.pdf>
- OSPAR, 2014. OSPAR Joint Assessment and Monitoring Programme (JAMP) 2014–2023, Agreement 2014-02, <https://www.ospar.org/documents?v=44125>
- UNEP/MAP-MED POL, 2016. Integrated Monitoring and Assessment Programme of the Mediterranean Sea and Coast and Related Assessment Criteria (IMAP), 2016, <https://wedocs.unep.org/handle/20.500.11822/10576>
- Water Framework Directive (WFD), Directive 2000/60/EC of the European Parliament and of the Council of 23 October 2000 establishing a framework for Community action in the field of water policy, <https://eur-lex.europa.eu/legal-content/EN/TXT/?uri=CELEX:32000L0060>

2.2.4 Scientific indicators for the criterion / element assessment

- BSC, 2017. Black Sea Integrated Monitoring and Assessment Program for years 2017–2022 (BSIMAP 2017–2022), 2017, https://ec.europa.eu/environment/marine/international-cooperation/regional-sea-conventions/bucharest/pdf/BSIMAP_2017_to_2022_en.pdf HELCOM indicators: <https://helcom.fi/baltic-sea-trends/indicators/>
- HELCOM, 2020: HELCOM Indicator Manual, Version 2020-1. Baltic Sea Environmental Proceedings no. 175, HELCOM, 2020, <https://helcom.fi/wp-content/uploads/2021/01/BSEP175.pdf>.
- OSPAR indicators: <https://www.ospar.org/work-areas/cross-cutting-issues/ospar-common-indicators>
- UNEP/MAP-MED POL indicators: <https://www.medqsr.org/integrated-monitoring-and-assessment-programme-mediterranean-sea-and-coast>

2.2.5 Temporal aspects of the assessment

- Birds Directive, Directive 2009/147/EC of the European Parliament and of the Council of 30 November 2009 on the conservation of wild birds, <https://eur-lex.europa.eu/legal-content/EN/TXT/?uri=CELEX%3A32009L0147>

Commission Staff Working Document, SWD(2020)62 final – Annex on horizontal issues on implementing the MSFD: <https://eur-lex.europa.eu/legal-content/EN/TXT/?uri=SWD:2020:62:FIN>

Habitats Directive, Council Directive 92/43/EEC of 21 May 1992 on the conservation of natural habitats and of wild fauna and flora, <https://eur-lex.europa.eu/legal-content/EN/TXT/?uri=CELEX:31992L0043>

Water Framework Directive (WFD), Directive 2000/60/EC of the European Parliament and of the Council of 23 October 2000 establishing a framework for Community action in the field of water policy, <https://eur-lex.europa.eu/legal-content/EN/TXT/?uri=CELEX:32000L0060>

2.2.6 Setting and applying threshold values

Domin, A., Schubert, H., Krause, J.C., Schiewer, U., 2004. Modelling of pristine depth limits for macrophyte growth in the southern Baltic Sea. *Hydrobiologia* 514:29-39. Habitats Directive, Council Directive 92/43/EEC of 21 May 1992 on the conservation of natural habitats and of wild fauna and flora, <https://eur-lex.europa.eu/legal-content/EN/TXT/?uri=CELEX:31992L0043>

MSFD CIS Workshop, 2020. Horizontal Issues Workshop: Threshold values, Workshop report 2021, GES_24-2021-04, https://circabc.europa.eu/ui/group/326ae5ac-0419-4167-83ca-e3c210534a69/library/57c639b6-85f7-40ad-9e04-e39694be148b?p=1&n=10&sort=modified_DESC

Pauly, D., 1995. Anecdotes and the Shifting Baseline Syndrome of Fisheries. *Trends in Ecology & Evolution*, 10, 430, [http://dx.doi.org/10.1016/S0169-5347\(00\)89171-5](http://dx.doi.org/10.1016/S0169-5347(00)89171-5)

Papworth, S.J., Coad, L., Rist, J., Miller-Gulland, E.J., 2009. Evidence for shifting baseline syndrome in conservation. *Conserv Lett* 2:93–100, <http://dx.doi.org/10.1111/j.1755-263X.2009.00049.x>

Water Framework Directive (WFD), Directive 2000/60/EC of the European Parliament and of the Council of 23 October 2000 establishing a framework for Community action in the field of water policy, <https://eur-lex.europa.eu/legal-content/EN/TXT/?uri=CELEX:32000L0060>

WFD CIS Guidance Document No. 5, 2003. Transitional and Coastal Waters – Typology, Reference Conditions and Classification Systems, 2003, [https://circabc.europa.eu/sd/a/85912f96-4dca-432e-84d6-a4dded785da5/Guidance%20No%205%20-%20characterisation%20of%20coastal%20waters%20-%20COAST%20\(WG%202.4\).pdf](https://circabc.europa.eu/sd/a/85912f96-4dca-432e-84d6-a4dded785da5/Guidance%20No%205%20-%20characterisation%20of%20coastal%20waters%20-%20COAST%20(WG%202.4).pdf)

WFD CIS Guidance Document No. 13, 2005. Overall Approach to the Classification of the Ecological Status and Ecological Potential, 2005, [https://circabc.europa.eu/sd/a/06480e87-27a6-41e6-b165-0581c2b046ad/Guidance%20No%2013%20-%20Classification%20of%20Ecological%20Status%20\(WG%20A\).pdf](https://circabc.europa.eu/sd/a/06480e87-27a6-41e6-b165-0581c2b046ad/Guidance%20No%2013%20-%20Classification%20of%20Ecological%20Status%20(WG%20A).pdf)

2.2.8 Confidence Assessment and Reports

IPCC, 2010. Fifth Assessment Report. Guidance Note for Lead Authors of the IPCC Fifth Assessment Report on Consistent Treatment of Uncertainties. IPCC Cross-Working Group Meeting on Consistent Treatment of Uncertainties, Jasper Ridge, CA, USA, 6-7 July 2010, https://www.ipcc.ch/site/assets/uploads/2017/08/AR5_Uncertainty_Guidance_Note.pdf

OSPAR Agreement 2019-02. Guidance on the Production of the Quality Status Report 2023. Update 2021. <https://www.ospar.org/documents?d=40951>

3. Role of Climate Change in the assessment framework

Cais, W.-J., Chen, C.-T. A., Borges, A.V., 2013. Carbon dioxide dynamics and fluxes in coastal waters influenced by river plumes, in *Biogeochemical Dynamics at Major River-Coastal Interfaces: Linkages with Global Change*, edited by Bianchi, T.S., Allison, M.A., and Cai, W.-J., Cambridge University Press, N.Y.

Chefaoui, R.M., Duarte, C.M., Serrão, E.A., 2018. Dramatic loss of seagrass habitat under projected climate change in the Mediterranean Sea. *Global Change Biology* 24, 4919-4928, <https://dx.doi.org/10.1111/gcb.14401>

Deltares, 2015. Guidance Document on how to reflect changes in hydrographical conditions in relevant assessments, prepared by C. Spiteri, 2015, <https://iczmplatform.org/storage/documents/gGPxabvSlgIUQMf1ZJEZDZQT742yHvuSn74WylgJ.pdf>

EU MSFD CIS Article 8 Assessment Guidance (test version 2017): <https://circabc.europa.eu/rest/download/cea61b55-06df-4e9e-9830-b0f41ca46fbe?ticket=>

- IPCC, 2019. IPCC Special Report on the Ocean and the Cryosphere in a Changing Climate [H.-O. Pörtner, D.C. Roberts, V. Masson-Delmotte, P. Zhai, M. Tignor, E. Poloczanska, K. Mintenbeck, A. Alegría, M. Nicolai, A. Okem, J. Petzold, B. Rama, N.M. Weyer (eds.)], <https://www.ipcc.ch/srocc/>
- Marbá, N. & Duarte, C. M., 2010. Mediterranean warming triggers seagrass (*Posidonia oceanica*) shoot mortality. *Global Change Biology* 16, 2366-2375, <https://dx.doi.org/10.1111/j.1365-2486.2009.02130.x>
- Oschlies, A., Brandt, P., Stramma, L., Schmidtko, S., 2019. Drivers and mechanisms of ocean deoxygenation. *Nature Geosciences* 11, 467–473, <https://doi.org/10.1038/s41561-018-0152-2>
- Rhein M., Rintoul, S.R., Aoki, S., Campos, E., Chambers, D., Feely, R.A., Gulev, S., Johnson, G.C., Josey, S.A., Kostianoy, A., Mauritzen, C., Roemmich, D., Talley, L.D. and Wang, F., 2013 : Observations: Ocean. In: Climate Change 2013: The Physical Science Basis. Contribution of Working Group I to the Fifth Assessment Report of the Intergovernmental Panel on Climate Change. [Stocker, T.F., Qin, D., Plattner, G.-K., Tignor, M., Allen, S.K., Boschung, J., Nauels, A., Xia, Y., Bex, V., and Midgley, P.M. (eds.)]. Cambridge University Press, Cambridge and New York, pp. 255–297. <https://www.ipcc.ch/report/ar5/wg1/>
- Roberts, C. M., O’Leary, C. O., McCauley, D. J., Cury, P. M., Duarte, C. M., Lubchenco, J., Pauly, D., Sáenz-Arroyo, A., Sumaila, U. R., Wilson, R. W., Worm, B., Castilla, J. C., 2017. Marine reserves can mitigate and promote adaptation to climate change. *PNAS* 114 (24), 6167-6175, <https://dx.doi.org/10.1073/pnas.1701262114>
- Zampoukas, N., Palialexis, A., Duffek, A., Graveland, J., Giorgi, G., Hagebro, C., Hanke, G., Korpinen, S., Tasker, M., Tornero Alvarez, M., Abaza, V., Battaglia, P., Caparis, M., Dekeling, R., Frias Vega, M., Haarich, M., Katsanevakis, S., Klein, H., Krzyminski, W., Laamanen, M., Le Gac, J., Leppanen, J., Lips, U., Maes, T., Magaletti, E., Malcolm, S., Marques, J., Mihail, O., Moxon, R., O’Brien, C., Panagiotidis, P., Penna, M., Piroddi, C., Probst, W., Raicevich, S., Trabucco, B., Tunesi, L., Van Der Graaf, S., Weiss, A., Wernersson, A., Zevenboom, W. Technical guidance on monitoring for the Marine Strategy Framework Directive. EUR 26499. Luxembourg (Luxembourg): Publications Office of the European Union; 2014. JRC88073

4. Pressure-Based Descriptor Assessments

4.1 Descriptor 2: Non-indigenous Species

- Regulation (EU) No 1143/2014 of the European Parliament and of the Council of 22 October 2014 on the prevention and management of the introduction and spread of invasive alien species. <https://eur-lex.europa.eu/legal-content/EN/TXT/?uri=celex%3A32014R1143>
- Tsiamis, K., Palialexis, A., Connor, D., et al., 2021a. Marine strategy framework directive, descriptor 2, non-indigenous species: delivering solid recommendations for setting threshold values for non-indigenous species pressure on European seas. Publications Office, <https://data.europa.eu/doi/10.2760/035071>
- Tsiamis, K., Boschetti, S., Palialexis, A., et al., 2021b. Marine Strategy Framework Directive : descriptor 2 : non-indigenous species, review and analyses of Member States' 2018 reports for articles 8, 9, and 10. Publications Office, <https://data.europa.eu/doi/10.2760/7897>

4.2 Descriptor 5: Eutrophication

- Water Framework Directive (WFD), Directive 2000/60/EC of the European Parliament and of the Council of 23 October 2000 establishing a framework for Community action in the field of water policy, <https://eur-lex.europa.eu/legal-content/EN/TXT/?uri=CELEX:32000L0060>
- HELCOM, 2015. HELCOM Eutrophication Assessment Manual. Update 31.12.2015. *Under review for 2024.* <https://helcom.fi/media/publications/Eutrophication-assessment-manual.pdf>
- OSPAR, 2022. Revised Common Procedure for the Identification of the Eutrophication Status of the OSPAR Maritime Area. For adoption by HASEC 2022 and publication by OSPAR 2022.
- BSC, 2017. Black Sea Integrated Monitoring and Assessment Program for years 2017–2022 (BSIMAP 2017–2022), 2017, https://ec.europa.eu/environment/marine/international-cooperation/regional-sea-conventions/bucharest/pdf/BSIMAP_2017_to_2022_en.pdf
- UNEP/MAP-MED POL, 2022. Publication of Manual for Eutrophication Assessment Tool (NEAT) expected soon.
- Commission Decision (EU) 2018/229 of 12 February 2018 establishing, pursuant to Directive 2000/60/EC of the European Parliament and of the Council, the values of the Member State monitoring system

classifications as a result of the intercalibration exercise and repealing Commission Decision 2013/480/EU, <https://eur-lex.europa.eu/legal-content/EN/TXT/?uri=CELEX%3A32018D0229>

4.3 Descriptor 7: Hydrographical Changes

EU MSFD CIS Article 8 Assessment Guidance (test version 2017):

<https://circabc.europa.eu/rest/download/cea61b55-06df-4e9e-9830-b0f41ca46fbe?ticket=>

Water Framework Directive (WFD), Directive 2000/60/EC of the European Parliament and of the Council of 23 October 2000 establishing a framework for Community action in the field of water policy, <https://eur-lex.europa.eu/legal-content/EN/TXT/?uri=CELEX:32000L0060>

4.4 Descriptor 8: Contaminants in the Environment

BSC, 2017. Black Sea Integrated Monitoring and Assessment Program for years 2017–2022 (BSIMAP 2017–2022), 2017, https://ec.europa.eu/environment/marine/international-cooperation/regional-sea-conventions/bucharest/pdf/BSIMAP_2017_to_2022_en.pdf

Davies, I.M. and Vethaak, D. (eds.), 2012. Integrated marine environmental monitoring of chemicals and their effects, ICES Cooperative Research Report No. 315, 277 pp, <https://dx.doi.org/10.17895/ices.pub.5403>

Directive 2008/105/EC of the European Parliament and of the Council of 16 December 2008 on environmental quality standards in the field of water policy, amending and subsequently repealing Council Directives 82/176/EEC, 84/156/EEC, 84/491/EEC, 86/280/EEC and amending Directive 2000/60/EC of the European Parliament and of the Council, <https://eur-lex.europa.eu/eli/dir/2008/105/oj>

EU MSFD CIS, 2021. Discussion paper on acute pollution under development. GES_24-2021-10_D8, <https://circabc.europa.eu/ui/group/326ae5ac-0419-4167-83ca-e3c210534a69/library/14f8e009-66c1-4791-86bd-c2c1e47ee989/details>

EU WFD CIS Guidance Document No. 7: Monitoring under the Water Framework Directive, European Commission, 2003, [https://circabc.europa.eu/sd/a/63f7715f-0f45-4955-b7cb-58ca305e42a8/Guidance%20No%207%20-%20Monitoring%20\(WG%202.7\).pdf](https://circabc.europa.eu/sd/a/63f7715f-0f45-4955-b7cb-58ca305e42a8/Guidance%20No%207%20-%20Monitoring%20(WG%202.7).pdf)

EU WFD CIS Guidance Document No. 25: On Chemical monitoring of sediment and biota under the Water Framework Directive, European Commission, 2010, <https://circabc.europa.eu/sd/a/7f47ccd9-ce47-4f4a-b4f0-cc61db518b1c/Guidance%20No%2025%20-%20Chemical%20Monitoring%20of%20Sediment%20and%20Biota.pdf>

EU WFD CIS Guidance Document No. 27 : Technical guidance for deriving environmental quality standards, European Commission, 2018 (previous version from 2011), <https://data.europa.eu/doi/10.2875/018826>

EU WFD CIS Guidance Document No. 38: Technical Guidance for implementing Environmental Quality Standards (EQS) for metals, European Commission, 2021, https://circabc.europa.eu/ui/group/9ab5926d-bed4-4322-9aa7-9964bbe8312d/library/9276554c-b76f-4bd2-b229-01539115eced?p=1&n=10&sort=modified_DESC

HELCOM indicators: <https://helcom.fi/baltic-sea-trends/indicators/>

HELCOM, 2020. HELCOM Indicator Manual, Version 2020-1, Baltic Sea Environmental Proceedings N 275, HELCOM, 2020, <https://helcom.fi/wp-content/uploads/2021/01/BSEP175.pdf>

OSPAR agreement 2019-02. Update 2020. QSR 2023 Guidance Document, <https://www.ospar.org/documents?v=40951>

OSPAR indicators: <https://www.ospar.org/work-areas/cross-cutting-issues/ospar-common-indicators>

Tornero, V., Hanke, G., Haber, A., Kunitzer, A., Mauffret, A., Much Christensen, A., Oros, A., McHugh, B., Maggi, C., Bijstra, D., Ten Hulscher, D., McGovern, E., Vaha, E., Giorgi, G., Hatzianestis, I., Aigars, J., Bellas, J., Campillo, J.A., Lusic, J., Manno, J., Antoniadis, K., Kamenova, K., Parmentier, K., Varenus, K., Van der Stap, I., Viñas, L., Furdek Turk, M., Korsjukov, M., Laht, M., Wessel, N., Dimitrova, S., Porsbring, T., Zalewska, T., Kammann, U., Pirntke, U., Coatu, V., Leon, V., 2021a. Guidance on potential exclusion of certain WFD priority substances from MSFD monitoring beyond coastal and territorial waters: A pragmatic and qualitative approach for the open sea, EUR 30655 EN, JRC124593. Publications Office of the European Union, Luxembourg, 2021, <https://dx.doi.org/10.2760/839892>

Tornero, V., Boschetti, S., Hanke, G., 2021b. Marine Strategy Framework Directive, Review and analysis of Member States' 2018 reports – Descriptor 8: Contaminants in the environment - Descriptor 9:

Contaminants in seafood, EUR 30659 EN, JRC124588. Publications Office of the European Union, Luxembourg, 2021, <http://dx.doi.org/10.2760/621757>

UNEP/MAP-MED POL, 2016. Integrated Monitoring and Assessment Programme of the Mediterranean Sea and Coast and Related Assessment Criteria (IMAP), 2016, <https://wedocs.unep.org/handle/20.500.11822/10576>

UNEP/MAP-MED POL indicators: <https://www.medqsr.org/integrated-monitoring-and-assessment-programme-mediterranean-sea-and-coast>

Water Framework Directive (WFD), Directive 2000/60/EC of the European Parliament and of the Council of 23 October 2000 establishing a framework for Community action in the field of water policy, <https://eur-lex.europa.eu/legal-content/EN/TXT/?uri=CELEX:32000L0060>

4.5 Descriptor 9: Contaminants in Seafood

Commission Regulation (EC) No. 1881/2006 of 19 December 2016 setting maximum levels for certain contaminants in foodstuffs, <https://eur-lex.europa.eu/legal-content/EN/TXT/?uri=celex%3A32006R1881>

Commission Staff Working Document, SWD(2020)61 final – Annex on state of EU seas and oceans: <https://eur-lex.europa.eu/legal-content/EN/TXT/?uri=CELEX%3A52020SC0061>

Regulation (EU) No 1379/2013 of the European Parliament and of the Council of 11 December 2013 on the common organization of the markets in fishery and aquaculture products, amending Council Regulation (EC) 1184/2006 and (EC) No. 1224/2009 and repealing Council Regulation (EC) No. 104/2000, <https://eur-lex.europa.eu/legal-content/EN/TXT/?uri=celex%3A32013R1379>

Tornero, V., Boschetti, S., Hanke, G., 2021b. Marine Strategy Framework Directive, Review and analysis of Member States' 2018 reports – Descriptor 8: Contaminants in the environment - Descriptor 9: Contaminants in seafood, EUR 30659 EN, JRC124588. Publications Office of the European Union, Luxembourg, 2021, <http://dx.doi.org/10.2760/621757>

Working Group Good Environmental Status 22, 19-20 September 2019, Meeting Document No. 11, Discussion paper : Approaches to implement MSFD D9, <https://circabc.europa.eu/ui/group/326ae5ac-0419-4167-83ca-e3c210534a69/library/33c4cc4d-0319-451b-9738-bb0a2bdd24fc/details>

Working Group Good Environmental Status 24, 22-23 April 2021, Meeting Document No. 11, Meeting summary : Joint meeting of Member States' Food Safety and Marine Environmental Authorities, <https://circabc.europa.eu/ui/group/326ae5ac-0419-4167-83ca-e3c210534a69/library/0b0d347f-5e93-4985-9de6-aa1031e653c4/details>

4.6 Descriptor 10: Marine Litter

Directive (EU) 2019/904 of the European Parliament and of the Council of 5 June 2019 on the reduction of the impact of certain plastic products on the environment, <https://eur-lex.europa.eu/eli/dir/2019/904/oj>

EU, 2018. Commission Staff Working Document. Impact Assessment – Reducing Marine Litter: action on single use plastics and fishing gear, SWD(2018) 254 final, https://eur-lex.europa.eu/resource.html?uri=cellar:4d0542a2-6256-11e8-ab9c-01aa75ed71a1.0001.02/DOC_1&format=PDF

Fleet, D., Vlachogianni, Th. and Hanke, G., 2021. A Joint List of Litter Categories for Marine Macrolitter Monitoring. EUR 30348 EN, Publications Office of the European Union, Luxembourg, 2021, JRC121708, <http://dx.doi.org/10.2760/127473>

Galgani, F., Hanke, G., Werner, S., Oosterbaan, L., Nilsson, P., Fleet, D., Kinsey, S., Thompson, R., van Franeker, J., Vlachogianni, T., Scoullou, M., Mira Veiga, J., Palatinus, A., Matiddi, M., Maes, T. Korpinen, S., Budziak, A., Leslie, H., Gago, J., Liebezeit, G., 2013. Guidance on Monitoring of Marine Litter in European Seas. EUR – Scientific and Technical Research series, 128 pages, – ISSN 1831-9424 (online), ISBN 978-92-79-32709-4, <http://dx.doi.org/10.2788/99475>

Hanke, G., Walvoort, D., van Loon, W. M. G. M., Addamo, A. M., Brosich, A., del Mar Chaves Montero, M., ... & Giorgetti, A. (2019). EU Marine Beach Litter Baselines. EU Science Hub. Luxembourg: Publications Office of the European Union.

- Van Franeker, J. A., Kühn, S., Anker-Nilssen, T., Edwards, E. W., Gallien, F., Guse, N., ... & van Loon, W. M. (2021). New tools to evaluate plastic ingestion by northern fulmars applied to North Sea monitoring data 2002–2018. *Marine Pollution Bulletin*, 166, 112246.
- Van Loon, W., Hanke, G., Fleet, D., Werner, S., Barry, J., Strand, J., Eriksson, J., Galgani, F., Gräwe, D., Schulz, M., Vlachogianni, T., Press, M., Blidberg, E. and Walvoort, D., A, 2020. European threshold value and assessment method for macro litter on coastlines, EUR 30347 EN, Publications Office of the European Union, Luxembourg, 2020, ISBN 978-92-76-21444-1, JRC121707, <http://dx.doi.org/10.2760/54369>

4.7 Descriptor 11: Underwater Noise

- Barco, S.G., Lockhart, G.G., Swingle, W.M., 2012. Using RADAR & AIS to investigate ship behavior in the Chesapeake Bay ocean approach off of Virginia, USA, *Oceans*, pp. 1-8, <https://dx.doi.org/10.1109/OCEANS.2012.6404872>
- Collins M.D., Turgut A., Menis R. et al. (2019). Acoustic recordings and modeling under seasonally varying sea ice. *Sci Rep* 9, 8323, <https://dx.doi.org/10.1038/s41598-019-44707-0>
- Communication from the Commission to the European Parliament, the Council, the European Economic and Social Committee and the Committee of the Regions on the Pathway to a Healthy Planet for All, EU Action Plan: 'Towards Zero Pollution for Air, Water and Soil', COM(2021) 400 final, 12.5.2021, <https://eur-lex.europa.eu/legal-content/EN/TXT/?uri=CELEX%3A52021DC0400&qid=1623311742827>
- Cope S., Hines E., Bland R., Davis J.D., Tougher B. and Zetterlind V., 2021. Multi-sensor integration for an assessment of underwater radiated noise from common vessels in San Francisco Bay. *The Journal of the Acoustical Society of America* 149, 2451, <https://dx.doi.org/10.1121/10.0003963>
- Cope, S., Hines, E., Bland, R., Davis, J.D., Tougher, B. and Zetterlind, V., 2020. Application of a New Shore-Based Vessel Traffic Monitoring System Within San Francisco Bay. *Front. Mar. Sci.* 7(86), <https://dx.doi.org/10.3389/fmars.2020.00086>
- De Santis V., Lanfredi C., Azzelino A., Prospathopoulos A., Vella A., Sánchez, M., 2018 National barriers and difficulties for the establishment of thresholds (summary report), *QuietMED* 2 D6.1
- Frantzis A., Leaper R., Alexiadou P., Prospathopoulos A., Lekkas D., 2019. Shipping routes through core habitat of endangered sperm whales along the Hellenic Trench, Greece: Can we reduce collision risks? *PLoS ONE* 14(2): e0212016, <https://dx.doi.org/10.1371/journal.pone.0212016>
- Habitats Directive, Council Directive 92/43/EEC of 21 May 1992 on the conservation of natural habitats and of wild fauna and flora, <https://eur-lex.europa.eu/legal-content/EN/TXT/?uri=CELEX:31992L0043>
- Hermanssen, L., Mikkelsen, L., Tougaard, J., Beedholm, K., Johnson, M., Madsen, P.T., 2019. Recreational vessels without Automatic Identification System (AIS) dominate anthropogenic noise contributions to a shallow water soundscape. *Sci Rep* 9, no. 15477 (2019), <https://dx.doi.org/10.1038/s41598-019-51222-9>
- Jensen, F.B., Kuperman, W.A., Porter, M.B., Schmidt, H., 2011. *Computational ocean acoustics*. Springer Science & Business Media, <https://dx.doi.org/10.1007/978-1-4419-8678-8>
- Kinda G.B., Le Courtois F., St., St Y. (2017). Ambient noise dynamics in a heavy shipping area. *Mar Pollut Bull.* 2017 Nov 15 ;124(1):535-546, <https://dx.doi.org/10.1016/j.marpolbul.2017.07.031>
- King, S. L., Schick, R. S., Donovan, C., Booth, C. G., Burgman, M., Thomas, L., et al. (2015). An interim framework for assessing the population consequences of disturbance. *Methods Ecol. Evol.* 6, 1150– 1158, <https://dx.doi.org/10.1111/2041-210x.12411>
- Merchant ND, Andersson MH, Box T, Le Courtois F, Cronin D, Holdsworth N, Kinneging N, Mendes S, Merck T, Mouat J, Norro AM. Impulsive noise pollution in the Northeast Atlantic: Reported activity during 2015–2017. *Marine Pollution Bulletin.* 2020 Mar 1;152:110951.
- New. L.F., Hall, A.J., Harcourt, R., Kaufman, G., Parsons, E.C.M., Pearson, H.C., Cosentino, A.M., Schick, R.S., 2015. The modelling and assessment of whale-watching impacts. *Ocean & Coastal Management* 115 (2015), 10– 16, <https://dx.doi.org/10.1016/j.ocecoaman.2015.04.006>
- New, L.F., Clark, J.S., Costa, D.P., Fleishman, E., Hindell, M.A., Klanjšček, T., Lussuau, D., Kraus, S., McMahon, C.R., Robinson, P.W., Schick, R.S., Schwarz, L.K., Simmons, S.E., Thomas, L., Tyack, P., Harwood J., 2014. Using short-term measures of behaviour to estimate long-term fitness of southern elephant seals. *Mar. Ecol. Prog. Ser.*, 496 (2014), pp. 99-108, <https://dx.doi.org/10.3354/meps10547>
- Pirotta, E., Booth, C. G., Costa, D. P., Fleishman, E., Kraus, S. D., Lusseau, D., et al.(2018). Understanding the population consequences of disturbance. *Ecol. Evol.* 8, 9934–9946.
- Prawirasasra, M.S.; Mustonen, M.; Klauson, A. The Underwater Soundscape at Gulf of Riga Marine-Protected Areas. *J. Mar. Sci. Eng.* 2021, 9, 915, <https://dx.doi.org/10.3390/jmse9080915>

Reed J, Harcourt R, New L and Bilgmann K, 2020. Extreme Effects of Extreme Disturbances: A Simulation Approach to Assess Population Specific Responses. *Front. Mar. Sci.* 7:519845, <https://dx.doi.org/10.3389/fmars.2020.519845>

TG Noise Deliverable 1: Assessment Framework for EU Thresholds Values for impulsive noise 2021, https://ec.europa.eu/environment/marine/pdf/Doc%201-%20TG%20Noise%20DL1%20-%20AF%20for%20EU%20TV%20for%20impulsive%20noise_2021.pdf

TG Noise Deliverable 3: Assessment Framework for EU Thresholds Values for continuous noise 2021, <https://ec.europa.eu/environment/marine/pdf/Doc%202%20-%20TG%20Noise%20DL3%20-%20AF%20for%20EU%20TV%20for%20continuous%20noise.pdf>

5. State-Based Descriptor Assessments

5.1 Descriptor 1: Birds

BSC, 2019. Black Sea State of the Environment Report 2009/2014/5, <http://www.blacksea-commission.org/Inf.%20and%20Resources/Publications/SOE2014/>

Birds Directive, Directive 2009/147/EC of the European Parliament and of the Council of 30 November 2009 on the conservation of wild birds, <https://eur-lex.europa.eu/legal-content/EN/TXT/?uri=CELEX%3A32009L0147>

Commission Delegated Decision (EU) 2021/1167 of 27 April 2021 establishing the multiannual Union programme for the collection and management of biological, environmental, technical and socioeconomic data in the fisheries and aquaculture sectors from 2022, <https://eur-lex.europa.eu/legal-content/EN/TXT/?uri=CELEX%3A32021D1167>

Dierschke, V., Kreutle, A., Häubner, N., Magliozzi, C., Bennecke, S., Bergström, L., Borja, A., Boschetti, S.T., Cheilari, A., Connor, D., Haas, F., Hauswirth, M., Koschinski, S., Liqueste, C., Olsson, J., Schönberg-Alm, D., Somma, F., Wennhage, H., Palialexis, A., 2021. Integration methods for Marine Strategy Framework Directive's biodiversity assessments. EUR 30656 EN, JRC124613, Publications Office of the European Union, Luxembourg, <https://doi.org/10.2760/4751>

HELCOM, 2018. State of the Baltic Sea. Second HELCOM holistic assessment 2011/2016. Baltic Sea Environmental Proceedings No. 155, <http://stateofthebalticsea.helcom.fi/>

HELCOM, 2020. HELCOM Checklist 2.0 of Baltic Sea Macrospecies. Baltic Sea Environmental Proceedings No 174, <https://helcom.fi/wp-content/uploads/2020/12/BSEP174.pdf>

Hymphreys, E.M., Risely, K., Austin, G.E., Johnston, A., Burton, N.H.K., 2012. Development of MSFD Indicators, Baselines and Targets for Population Size and Distribution of Marine Birds in the UK. BTO Research Report No. 626. British Trust for Ornithology, Thetford.

ICES, 2011. Report of the Working Group on Seabird Ecology (WGSE), 1–4 November 2011, Madeira, Portugal. ICES CM 2011/SSGEF:07. 87 pp.

ICES JWGBIRD, 2014. Report of the Joint ICES/OSPAR Working Group on Seabirds (JWGBIRD), 17-21 November 2014, https://www.ices.dk/sites/pub/Publication%20Reports/Expert%20Group%20Report/acom/2014/JWGBIRD/JWGBIRD_2014.pdf

Keller, V., Herrando, S., Voříšek, P., Franch, M., Kipson, M., Milanese, P., Martí, D., Anton, M., Klvaňová, A., Kalyakin, M.V., Bauer, H.G., Foppen, R.P.B., 2020. European Breeding Bird Atlas 2: Distribution, Abundance and Change. European Bird Census Council & Lynx Edicions, Barcelona.

MISITIC Seas, 2018. Macaronesian Roof Report 2018. Main results. Mistic Seas II, Macaronesia. https://misticseas3.com/sites/default/files/material-divulgativo/main_results_macaronesian_roof_report_en.pdf

OSPAR, 2017. Intermediate Assessment 2017, <https://oap.ospar.org/en/ospar-assessments/intermediate-assessment-2017/>

UNEP/MAP-MED POL, 2017. 2017 Mediterranean Quality Status Report, https://www.medqsr.org/sites/default/files/inline-files/2017MedQSR_Online_0.pdf

Waterbirds in the Mediterranean region: <https://www.medwaterbirds.net/>

5.2 Descriptor 1: Mammals

- Brakes, P. et al., 2021. A deepening understanding of animal culture suggests lessons for conservation. *Proc. R. Soc. B* 288: 20202718, <https://doi.org/10.1098/rspb.2020.2718>
- Commission Decision 2010/93/EU of 18 December 2009 adopting a multiannual Community programme for the collection, management and use of data in the fisheries sector for the period 2011-2013, [https://eur-lex.europa.eu/eli/dec/2010/93\(1\)/oj](https://eur-lex.europa.eu/eli/dec/2010/93(1)/oj)
- Commission Delegated Decision (EU) 2021/1167 of 27 April 2021 establishing the multiannual Union programme for the collection and management of biological, environmental, technical and socioeconomic data in the fisheries and aquaculture sectors from 2022, <https://eur-lex.europa.eu/legal-content/EN/TXT/?uri=CELEX%3A32021D1167>
- Dierschke, V., Kreutle, A., Häubner, N., Magliozzi, C., Bennecke, S., Bergström, L., Borja, A., Boschetti, S.T., Cheilari, A., Connor, D., Haas, F., Hauswirth, M., Koschinski, S., Liqueste, C., Olsson, J., Schönberg-Alm, D., Somma, F., Wennhage, H., Palialexis, A., 2021. Integration methods for Marine Strategy Framework Directive's biodiversity assessments. EUR 30656 EN, JRC124613, Publications Office of the European Union, Luxembourg, <https://dx.doi.org/10.2760/4751>
- DG Environment, *Reporting under Article 17 of the Habitats Directive: Explanatory notes and guidelines for the period 2013-2018*, Brussels, 2017.
- Ellwanger, G., Ssymank, A., Buschmann, A., Ersfeld, M., Frederking, W., Lehrke, S., Neukrichen, M., Raths, U., Sukopp, U., Vischer-Leopold, M., 2015. The German national report 2013 according to art. 17 Habitats Directive - part 2: results for species - Der nationale Bericht 2013 zur FFH-Richtlinie - Ergebnisse und Bewertung der Erhaltungszustände Teil 2 – Die Arten der Anhänge II, IV und V. BfN Skripten 421/2. Federal Agency for Nature Conservation, Bonn, Germany.
- Evans, 2021, submitted for publication.
- Franzosini, C., Genov, T., Tempesta, M., 2013. Cetacean manual for MPA managers. ACCOBAMS, MedPAN and UNEP/MAP-RAC/SPA. Ed. RAC/SPA, Tunis. 77 p, https://www.rac-spa.org/sites/default/files/doc_cetacean/manuel_cetaces_amp.pdf
- Genu, M., Gilles, A., Hammond, P.S., Macleod, K., Paillé, J., Paradinas, I., Smout, S., Winship, A.J. and Authier, M., 2021. Evaluating Strategies for Managing Anthropogenic Mortality on Marine Mammals: An R Implementation With the Package RLA. *Front. Mar. Sci.* 8:795953. doi: 10.3389/fmars.2021.795953
- Habitats Directive, Council Directive 92/43/EEC of 21 May 1992 on the conservation of natural habitats and of wild fauna and flora, <https://eur-lex.europa.eu/legal-content/EN/TXT/?uri=CELEX:31992L0043>
- HELCOM, 2020. Roadmap on fisheries data in order to assess incidental bycatch and fisheries impact on benthic biotopes in the Baltic Sea, Adopted by HELCOM 41-2020 on 4 March 2020 , Annex 7 to Outcome of HELCOM 41-2000. Baltic Marine Environment Protection Commission, Helsinki, Finland, 17 pp. <https://portal.helcom.fi/meetings/HELCOM%2041-2020-679/MeetingDocuments/Outcome%20of%20HELCOM%2041-2020.pdf>
- ICES, *Report of the Workshop on extinction risk of MSFD biodiversity approach (WKDIVExtinct)*, 12–15 June 2018, ICES HQ, Copenhagen, Denmark. ICES CM 2018/ACOM:48. 43pp. <http://ices.dk/sites/pub/Publication%20Reports/Expert%20Group%20Report/acom/2018/WKDIVExtinct/01%20WKDIVExtinct%20Report.pdf>

5.3 Descriptor 1: Reptiles

- Casale, P., 2011. Sea turtle bycatch in the Mediterranean, *Fish and Fisheries* 12:299–316, <https://dx.doi.org/10.1111/j.1467-2979.2010.00394.x>
- DG Environment, 2017. Reporting under Article 17 of the Habitats Directive: Explanatory notes and guidelines for the period 2013-2018, Brussels, pp 188, <https://circabc.europa.eu/sd/a/d0eb5cef-a216-4cad-8e77-6e4839a5471d/Reporting%20guidelines%20Article%2017%20final%20May%202017.pdf>
- Girondot M, Mourrain B, Chevallier D, Godfrey MH (2021) *Maturity of a Giant: Age and size reaction norm for sexual maturity for Atlantic leatherback turtles*. *Marine Ecology* 42(5):e12631

Habitats Directive, Council Directive 92/43/EEC of 21 May 1992 on the conservation of natural habitats and of wild fauna and flora, <https://eur-lex.europa.eu/legal-content/EN/TXT/?uri=CELEX:31992L0043>

IUCN Standards and Petitions Committee, 2019. Guidelines for Using the IUCN Red List Categories and Criteria. Version 14. Prepared by the Standards and Petitions Committee.
<http://www.iucnredlist.org/documents/RedListGuidelines.pdf>

Palialexis A., Cardoso, A.C., Avellan, L., Batsleer, J., Campos, B., Connor, D., Greenstreet, S., Guérin, L., Häubner, N., Hawkridge, J., Heslenfeld, P., Coull, K., Krause, J., Mavri, B., Miossec, L., Orlando-Bonaca, M., Reker, J., Romao, C., Teixeira, H., Tsiamis, K., 2016. Report of the JRC's Descriptor 1 workshop to support the review of the Commission Decision 2010/477/EU concerning MSFD criteria for assessing Good Environmental Status; EUR 27715, <https://dx.doi.org/10.2788/162330>

Palialexis, A., Cardoso, A.C., Somma, F., 2018. JRC's reference lists of MSFD species and habitats, EUR 29125 EN, JRC117126, Publications Office of the European Union, Luxembourg, 2018,
<https://dx.doi.org/10.2760/794186>

Wallace, B.P., DiMatteo, A.D., Hurley, B.J., Finkbeiner, E.M., Bolten, A.B., Chaloupka, M.Y., Hutchinson, B.U., Abreu-Grobois, F.A., Amorocho, D., Bjørndal, K.A., Bourjea, J., Bowen, B.W., Dueñas R.B., Casale, P., Choudhury, B.C., Costa, A., Dutton, P.H., Fallabrino, A., Girard, A., Girondot, M., Godfrey, M.H., Hamann, M., López-Menhilarsu, M., Marcovaldi, M.A., Mortimer, J.A., Musick, J.A., Nel, R., Pilcher, N.J., Seminoff, J.A., Troëng, S., Witherington, B., Mast, R.B., 2010. Regional Management Units for Marine Turtles: A Novel Framework for Prioritizing Conservation and Research across Multiple Scales, PLoS ONE 5(12):e15465, <https://dx.doi.org/10.1371/journal.pone.0015465>

5.4 Descriptor 1: Fish

Habitats Directive, Council Directive 92/43/EEC of 21 May 1992 on the conservation of natural habitats and of wild fauna and flora, <https://eur-lex.europa.eu/legal-content/EN/TXT/?uri=CELEX:31992L0043>

Common Fisheries Policy, Regulation (EU) No 1380/2013 of the European Parliament and of the Council of 11 December 2013 on the Common Fisheries Policy, amending Council Regulations (EC) No. 1954/2003 and (EC) N 1224/2009 and repealing Council Regulations (EC) No 2371/2002 and (EC) No 639/2004 and Council Decision 2004/585/EC, <https://eur-lex.europa.eu/legal-content/EN/TXT/?uri=CELEX%3A32013R1380>

Commission Delegated Decision (EU) 2021/1167 of 27 April 2021 establishing the multiannual Union programme for the collection and management of biological, environmental, technical and socioeconomic data in the fisheries and aquaculture sectors from 2022, <https://eur-lex.europa.eu/legal-content/EN/TXT/?uri=CELEX%3A32021D1167>

ICES Working Group on Bycatch of Protected species (WGBYC), 2020. ICES Scientific Reports. 2:81. 216 pp.
<http://dx.doi.org/10.17895/ices.pub.7471>

IUCN rest list criteria: <https://portals.iucn.org/library/node/10336>

5.5 Descriptor 3: Commercial Fish and Shellfish

Arkhipkin, A. I., Hendrickson, L. C., Payá, I., Pierce, G. J., Roa-Ureta, R. H., Robin, J. P., and Winter, A. 2021. Stock assessment and management of cephalopods: advances and challenges for short-lived fishery resources. ICES Journal of Marine Science, 78(2), 714–730,
<https://dx.doi.org/10.1093/icesjms/fsaa038>

Armelloni, E. N., Scanu, M., Masnadi, F., Coro, G., Angelini, S. and Scarcella, G. 2021. Data Poor Approach for the Assessment of the Main Target Species of Rapido Trawl Fishery in Adriatic Sea. Front. Mar. Sci. 8:552076, <https://dx.doi.org/10.3389/fmars.2021.552076>

Chong, L., Mildenerger, T. K., Rudd, M. B., Taylor, M. H., Cope, J. M., Branch, T. A., Wolff, M., and Stäbler, M. 2020. Performance evaluation of data-limited, length-based stock assessment methods. ICES Journal of Marine Science, 77(1), 97–108,
<https://dx.doi.org/10.1093/icesjms/fsz212>

EU. 2019. Regulation (EU) 2019/1022 of the European Parliament and of the Council of 20 June 2019 establishing a multiannual plan for the fisheries exploiting demersal stocks in the western Mediterranean Sea and amending Regulation (EU) No 508/2014, <https://eur-lex.europa.eu/eli/reg/2019/1022/oj>

- FAO-GFCM. 2014. Report of the fifteenth session of the SAC Subcommittee on Stock Assessment (SCSA). Bar (Montenegro), <https://gfcmsitestorage.blob.core.windows.net/documents/Reports/GFCM-Report-2014-SCSA-15.pdf>
- FAO-WGSAD. 2021. Report of the Working Group on Stock Assessment of Demersal Species (WGSAD), <https://gfcmsitestorage.blob.core.windows.net/documents/Reports/GFCM-Report-2021-WGSAD-15.pdf>
- ICES. 2021a. Tenth Workshop on the Development of Quantitative Assessment Methodologies based on LIFE-history traits, exploitation characteristics, and other relevant parameters for data-limited stocks (WKLIFE X). ICES Scientific Reports, 2:98. 72 p, <http://dx.doi.org/10.17895/ices.pub.5985>
- ICES. 2021b. Workshop on Fish of Conservation and Bycatch Relevance (WKCOFIBYC). ICES Scientific Reports, 3:57. 125 pp, <https://dx.doi.org/10.17895/ices.pub.8194>
- UNEP. 2017. The First Quality Status Report for the Mediterranean –MEDQSR (2017), https://www.medqsr.org/sites/default/files/inline-files/2017MedQSR_Online_0.pdf

5.6 Descriptor 1: Pelagic Habitats

5.7 Descriptor 6: Seafloor Integrity and Descriptor 1: Benthic Habitats

- EMODnet's EUSeaMap, <https://www.emodnet-seabedhabitats.eu/access-data/launch-map-viewer/>
- EUNIS, 2019. EUNIS habitat classification, https://www.eea.europa.eu/data-and-maps/data/eunis-habitat-classification/eunis-marine-habitat-classification-review-2019/eunis-marine-habitat-classification-2019/at_download/file
- Habitats Directive, Council Directive 92/43/EEC of 21 May 1992 on the conservation of natural habitats and of wild fauna and flora, <https://eur-lex.europa.eu/legal-content/EN/TXT/?uri=CELEX:31992L0043>
- HELCOM Red List of biotopes, habitats and biotope complexes, <https://helcom.fi/baltic-sea-trends/biodiversity/red-list-of-biotopes-habitats-and-biotope-complexes/>
- OSPAR List of threatened and/or declining species and habitats, <https://www.ospar.org/work-areas/bdc/species-habitats>
- TG Seabed, 2020. EUNIS marine habitat classification and MSFD broad habitat types, SEABED_3-2020-05annexRev, <https://circabc.europa.eu/ui/group/326ae5ac-0419-4167-83ca-e3c210534a69/library/85f995b6-819a-4d1b-aecd-630df32f83d6/details>
- TG Seabed, 2021. Assessment scales and areas, SEABED_8-2021-04, <https://circabc.europa.eu/ui/group/326ae5ac-0419-4167-83ca-e3c210534a69/library/1ba4e9a8-abfa-4516-b76e-594a291869a9/details>
- Updated Reference List of marine habitat types for the selection of sites to be included in the national inventories of natural sites of conservation interest in the Mediterranean, https://www.rac-spa.org/nfp13/documents/01_working_documents/wg_431_06_eng_24_04_2017.pdf
- Water Framework Directive (WFD), Directive 2000/60/EC of the European Parliament and of the Council of 23 October 2000 establishing a framework for Community action in the field of water policy, <https://eur-lex.europa.eu/legal-content/EN/TXT/?uri=CELEX:32000L0060>

5.8 Descriptor 4: Food webs

- Eero, M., Hjelm, J., Behrens, J., Buchmann, K., Cardinale, M., Casini, M., Gasyukov, P., et al. 2015. Eastern Baltic cod in distress: biological changes and challenges for stock assessment. ICES Journal of Marine Science, 72(8), 2180–2186, <https://dx.doi.org/10.1093/icesjms/fsv109>
- ICES, 2014. Report of the Workshop to develop recommendations for potentially useful Food Web Indicators (WKFooWI), 31 March–3 April 2014, ICES Headquarters, Copenhagen, Denmark. ICES CM 2014\ACOM:48. 75 pp.

- ICES, 2020. Joint OSPAR/HELCOM/ICES Working Group on Seabirds (JWGBIRD; outputs from 2019 meeting). ICES Scientific Reports. 2:80. 101 pp, <http://dx.doi.org/10.17895/ices.pub.7466>
- Shephard, S., Rindorf, A., Dickey-Collas, M., Hintzen, N. T., Farnsworth, K., and Reid, D. G. 2014. Assessing the state of pelagic fish communities within an ecosystem approach and the European Marine Strategy Framework Directive. ICES Journal of Marine Science, 71(7), 1572–1585, <https://dx.doi.org/10.1093/icesjms/fsu005>
- Walker, N.D., Maxwell, D.L., Le Quesne, W.J., Jennings, S., 2017. Estimating efficiency of survey and commercial trawl gears from comparisons of catch rations. ICES Journal of Marine Science, 74(5), 1448-1457, <https://dx.doi.org/10.1093/icesjms/fsw250>
- Yang, J. 1982. An estimate of the fish biomass in the North Sea. ICES Journal of Marine Science, 40(2), 161–172, <https://doi.org/10.1093/icesjms/40.2.161>

7. Abbreviations

AIS	Automated Identification Systems
Annex III MSFD	Commission Directive (EU) 2017/845 amending Directive 2008/56/EC of the European Parliament and of the Council as regards the indicative lists of elements to be taken into account for the preparation of marine strategies
BAC	Background Assessment Concentration
BEAST	Black Sea Eutrophication Assessment Tool
BEAT	HELCOM Biodiversity and Ecosystems Assessment Tool
BEC	Background environmental conditions
BSC	Black Sea Commission – Bucharest Convention
BSIMAP	Black Sea Integrated Monitoring and Assessment Programme – BSC
C1, C2 etc	Criterion 1, criterion 2 etc linked to Descriptors (D1C1, D1C2 etc) – GES Decision
C3S	Copernicus application
CFCs	chlorofluorocarbons
CFP	Common Fisheries Policy
CH ₄	Methane
CHASE	HELCOM Hazardous Substances Assessment Tool
Chl <i>a</i>	Chlorophyll <i>a</i>
CIS	Common Implementation Strategy
CLA	Catch Limit Algorithm
CMEMS	Copernicus Marine Environment Monitoring Services
CO ₂	carbon dioxide
COMPEAT	OSPAR Common Procedure Eutrophication Assessment Tool
D1, D2 etc	Descriptor 1, Descriptor 2 etc, Annex I MSFD
DFC	Data Collection Framework
DIN	Dissolved Inorganic Nitrogen
DIP	Dissolved Inorganic Phosphorus
DPSIR	Driving forces, Pressures, Impacts, States and Responses
EAC	Ecological Assessment Concentration
EcoQO	OSPAR Ecological Quality Objective
EEZ	Exclusive Economic Zone
EMODnet	European Marine Observation and Data Network
EMSO	European Multidisciplinary Seafloor and Water Column Observatory
EQR	Environmental Quality Ratio
EQS	Environmental Quality Standards
EU	European Union
euroGOOS	European Global Ocean Observing System
F	Fishing mortality
FAO	United Nations Food and Agriculture Organization
GES	Good Environmental Status
GES Decision	Commission Decision (EU) 2017/848 laying down criteria and methodological standards on good environmental status of marine waters and specifications and standardised methods for monitoring and assessment, and repealing Decision 2010/477/EU
GFCM	General Fisheries Commission for the Mediterranean
GHG	Greenhouse gases
HAB	Harmful Algal Blooms
H ₂ O	Water vapour
HD	Habitats Directive (Directive 92/43/EEC)
HEAT	HELCOM Eutrophication Assessment Tool
HELCOM	Baltic Marine Environment Protection Commission – Helsinki Convention
HFCs	hydrofluorocarbons
ICES	International Council for the Exploration of the Sea
IMAP	Integrated Monitoring and Assessment Programme of the Mediterranean Sea and Coast and Related Assessment Criteria – UNEP/MAP-MED POL

IOC	Intergovernmental Oceanographic Commission – UNESCO
IPCC	Intergovernmental Panel on Climate Change
IPM	Integrated Population Model
IUCN	International Union for Conservation of Nature
IWC	International Whaling Commission
JAMP	Joint Assessment and Monitoring Programme – OSPAR
JERICO-RI	Joint European Research Infrastructure of Coastal Observations
JRC	Joint Research Center
MAP	Multiannual Plan
MED POL	Programme for the Assessment and Control of Marine Pollution in the Mediterranean
mPBR	Modified Potential Biological Removal model
MRU	Marine Reporting Unit
MSCG	EU MSFD CIS Marine Strategy Coordination Group
MSE	Management Strategy Evaluations
MSFD	Marine Strategy Framework Directive (Directive 2008/56/EC)
MSPD	Maritime Spatial Planning Directive (Directive 2014/89/EU)
MSY	Maximum Sustainable Yield
MTSG	Marine Turtle Specialist Group
N	Nitrogen
N ₂ O	nitrous oxide
NEAT	UNEP/MAP-MED POL Eutrophication Assessment Tool
NIS	non-indigenous species
Nm	nautical mile
O ₃	ozone
OA	Ocean acidification
OHAT	OSPAR Hazardous Substances Assessment Tool
OOAO	One-Out All-Out rule
OOS	Ocean Observing System
OSPAR	OSPAR Commission – OSPAR Convention
P	Phosphorus
PBR	Potential Biological Removal model
PFCs	perfluorocarbons
PcoD	Population Consequences of Disturbance
PVA	Population Viability Analysis
RBSP	River Basin Specific Pollutants
REG	Regional Expert Group
RLA	Removal Limit Algorithm
RMU	Regional Management Unit
RSC	Regional Sea Conventions
SF ₆	sulphur hexafluoride
SSB	Spawning stock biomass
STEG	Sea Turtle Expert Group
(sub)regional	regional or subregional
SWD	EU Commission Staff Working Document
TN	Total Nitrogen
TP	Total Phosphorus
UNEP	United Nations Environment Plan
UNEP/MAP	Mediterranean Action Plan – Barcelona Convention
UNESCO	United Nations Educational, Scientific and Cultural Organisation
UNFCCC	United Nations Framework Convention on Climate Change
WFD	Water Framework Directive (Directive 2000/60/EC)
WGBYC	ICES Working Group on Bycatch of Protected Species
WGGES	EU MSFD CIS Working Group on Good Environmental Status

Annex 1: Overview of the scales given in the GES Decision for each Descriptor and criterion

(Source: DIKE-24-2021-06)

	Descriptor	Features to be assessed (from GD14 Annex VI)	Scale of assessment	Criteria (primary, secondary)	
Pressures and their impacts	D2 Non-indigenous species	Newly introduced non-indigenous species	Subdivisions of the region or subregion, divided where needed by national boundaries.	D2C1 Newly-introduced NIS	
		Established non-indigenous species	As used for assessment of the corresponding species groups or broad habitat types under Descriptors 1 and 6.	D2C2 Established NIS	
		Benthic broad habitats Pelagic broad habitats Species groups		D2C3 Adverse effects of NIS	
	D5 Eutrophication	Eutrophication		Within coastal waters , as used under the Water Framework Directive. Beyond coastal waters, subdivisions of the region or subregion, divided where needed by national boundaries.	D5C1 Nutrient concentrations
					D5C2 Chlorophyll <i>a</i> concentration
					D5C3 Harmful algal blooms
					D5C4 Photic limit
					D5C5 Dissolved oxygen concentration
					D5C6 Opportunistic macroalgae of benthic habitats
					D5C7 Macrophyte communities of benthic habitats
	D7 Hydrographical changes	Hydrographical changes		As used for assessment of the benthic broad habitat types under Descriptors 1 and 6.	D7C1 Permanent alteration of hydrographical conditions
		Benthic broad habitats [Other benthic habitats]			D7C2 Adverse effects from permanent alteration of hydrographical conditions
	D8 Contaminants	Contaminants - non UPBT substances		Within coastal and territorial waters , as used under the Water Framework Directive. Beyond territorial waters, subdivisions of the region or subregion, divided where needed by national boundaries.	D8C1 Contaminant in environment
		Contaminants - UPBT substances			D8C1 Contaminant in environment
Species Benthic habitats		D8C2 Adverse effects of contaminants			
Acute pollution events		D8C3 Significant acute pollution events			
Species groups Benthic broad habitats		As used for assessment of the species groups or benthic broad habitat types under Descriptors 1 and 6.			D8C4 Adverse effects of significant acute pollution events
D9 Contaminants in seafood	Contaminants – in seafood		The catch or production area in accordance with Article 38 of Regulation (EU) No 1379/2013 of the European Parliament and of the Council.	D9C1 Contaminants in seafood	
D10 Marine litter	Litter in the environment		Subdivisions of the region or subregion, divided where	D10C1 Litter (excluding micro-litter)	

GD 19: Article 8 Assessment Guidance

	Descriptor	Features to be assessed (from GD14 Annex VI)	Scale of assessment	Criteria (primary, secondary)
		Micro-litter in the environment	needed by national boundaries.	D10C2 Micro-litter
		Litter and micro-litter in species		D10C3 Litter ingested
		Species	As used for assessment of the species group under Descriptor 1.	D10C4 Adverse effects of litter
	D11 Energy, including underwater noise	Impulsive sound in water	Region, subregion or subdivisions.	D11C1 Anthropogenic impulsive sound
Continuous low-frequency sound	D11C2 Anthropogenic continuous low-frequency sound			
[Mobile] species	D1 Birds	Grazing birds Wading birds Surface-feeding birds Pelagic-feeding birds Benthic-feeding birds	As used for assessment of the corresponding species or species groups under criteria D1C2-D1C5.	D1C1 Mortality rate from incidental bycatch
			Ecologically-relevant scales for each species group shall be used, as follows: — for birds: region or subdivisions for Baltic Sea and Black Sea; subregion for North-East Atlantic Ocean and Mediterranean Sea	D1C2 Population abundance
				D1C3 Population demographic characteristics
				D1C4 Population distributional range and pattern
				D1C5 Habitat for the species
	D1 Mammals	Small toothed cetaceans Deep-diving toothed cetaceans Baleen whales Seals	As used for assessment of the corresponding species or species groups under criteria D1C2-D1C5.	D1C1 Mortality rate from incidental bycatch
			Ecologically-relevant scales for each species group shall be used, as follows: — for deep-diving toothed cetaceans, baleen whales: region, — for small toothed cetaceans: region or subdivisions for Baltic Sea and Black Sea; subregion for North-East Atlantic Ocean and Mediterranean Sea — for seals: region or subdivisions for Baltic Sea; subregion for North-East Atlantic Ocean and Mediterranean Sea	D1C2 Population abundance
				D1C3 Population demographic characteristics
				D1C4 Population distributional range and pattern
				D1C5 Habitat for the species
	D1 Reptiles	Turtles	As used for assessment of the corresponding species or species groups under criteria D1C2-D1C5.	D1C1 Mortality rate from incidental bycatch
			Ecologically-relevant scales for each species group shall be used, as follows: — for turtles: region or subdivisions for Baltic Sea; subregion for North-East Atlantic Ocean and Mediterranean Sea	D1C2 Population abundance
D1C3 Population demographic characteristics				
D1C4 Population distributional range and pattern				
D1C5 Habitat for the species				
D1 Fish	Coastal fish Pelagic shelf fish	As used for assessment of the corresponding species or	D1C1 Mortality rate from incidental bycatch	

GD 19: Article 8 Assessment Guidance

	Descriptor	Features to be assessed (from GD14 Annex VI)	Scale of assessment	Criteria (primary, secondary)
		Demersal shelf fish Deep-sea fish	species groups under criteria D1C2-D1C5.	
			Ecologically-relevant scales for each species group shall be used, as follows: — for deep-sea fish : region , — for pelagic and demersal shelf fish : region or subdivisions for Baltic Sea and Black Sea; subregion for North-East Atlantic Ocean and Mediterranean Sea — for coastal fish : subdivision of region or subregion , — for commercially-exploited fish and cephalopods : as used under Descriptor 3 .	D1C2 Population abundance D1C3 Population demographic characteristics [primary for commercial species] D1C4 Population distributional range and pattern [primary for HD fish] D1C5 Habitat for the species [primary for HD fish]
	D1 Cephalopods	Coastal/shelf cephalopods Deep-sea cephalopods	As used for assessment of the corresponding species or species groups under criteria D1C2-D1C5.	D1C1 Mortality rate from incidental bycatch
			Ecologically-relevant scales for each species group shall be used, as follows: — for cephalopods : region or subdivisions for Baltic Sea; subregion for North-East Atlantic Ocean and Mediterranean Sea, — for commercially-exploited fish and cephalopods : as used under Descriptor 3 .	D1C2 Population abundance D1C3 Population demographic characteristics [primary for commercial species] D1C4 Population distributional range and pattern D1C5 Habitat for the species
	D3 Commercially exploited fish and shellfish	Commercially exploited fish and shellfish	Populations of each species are assessed at ecologically-relevant scales within each region or subregion , as established by appropriate scientific bodies as referred to in Article 26 of Regulation (EU) No 1380/2013, based on specified aggregations of International Council for the Exploration of the Sea (ICES) areas, General Fisheries Commission for the Mediterranean (GFCM) geographical sub-areas and Food and Agriculture Organisation (FAO) fishing areas for the Macaronesian biogeographic region.	D3C1 Fishing mortality rate (F) D3C2 Spawning stock biomass (SSB) D3C3 Population age/size distribution
Habitats	D1 Pelagic habitats	Pelagic broad habitats [Other pelagic habitats]	Subdivision of region or subregion as used for assessments of benthic broad habitat types , reflecting biogeographic differences in species composition of the habitat type.	D1C6 Pelagic habitat condition

GD 19: Article 8 Assessment Guidance

	Descriptor	Features to be assessed (from GD14 Annex VI)	Scale of assessment	Criteria (primary, secondary)
	D6 Seafloor integrity/D1 Benthic habitats	Physical loss of the seabed	As used for assessment of the benthic broad habitat types under Descriptors 1 and 6.	D6C1 Physical loss of the seabed
		Physical disturbance to seabed		D6C2 Physical disturbance to the seabed
		Benthic broad habitats [Other benthic habitats]		D6C3 Adverse effects from physical disturbance
			D6C4 Benthic habitat extent	
		D6C5 Benthic habitat condition		
Ecosystems	D4/D1 Ecosystems, including food webs	Coastal ecosystems Shelf ecosystems Oceanic/deep-sea ecosystems	Regional level for Baltic Sea and Black Sea; subregional level for North-East Atlantic and Mediterranean Sea. Subdivisions may be used where appropriate.	D4C1 Trophic guild species diversity
				D4C2 Abundance across trophic guilds
				D4C3 Trophic guild size distribution
				D4C4 Trophic guild productivity

Annex 2: Overview of the scales given in the GES Decision for each MSFD Region

(Source: DIKE-24-2021-06)

Region	Scales (large to small)	Features	Criteria
Baltic Sea, Black Sea ¹¹⁶	Region	Deep-diving toothed cetaceans Baleen whales Deep-sea fish	D1C1-D1C5
	Catch or production area [sub-area or division listed in the FAO fishing areas] ¹¹⁷	Contaminants – in seafood	D9C1
	Ecologically-relevant scales [populations] based on specified aggregations of ICES or GFCM areas	Commercially-exploited fish, cephalopods and shellfish	D3C1-D3C3
	Region or subdivisions	Birds (all groups) Small toothed cetaceans Seals Turtles Pelagic shelf fish Demersal shelf fish Cephalopods (all groups) Ecosystems (all types) Species (for D8C4) Impulsive sound in water Continuous low-frequency sound	D1C1-D1C5 D2C2, D2C3 D4C1-D4C4 D8C4 D10C4 D11C1, D11C2
	Subdivision	Coastal fish	D1C1-D1C5
	Subdivision	Pelagic habitats (broad, other) Hydrographical changes Physical loss of the seabed Physical disturbance to the seabed Benthic habitats (broad, other)	D1C6 D2C2, D2C3 D6C1-D6C5 D7C1, D7C2 D8C4
	Region, divided where needed by national boundaries	Acute pollution events	D8C3
	Subdivisions, divided where needed by national boundaries	Newly introduced non-indigenous species Litter in the environment Micro-litter in the environment Litter and micro-litter in species	D2C1 D10C1, D10C2, D10C3
	Subdivisions, divided where needed by national boundaries (beyond coastal waters)	Eutrophication	D5C1-D5C8
	WFD coastal and territorial waters	Contaminants - non UPBT substances Contaminants - UPBT substances Species Benthic habitats	D8C1, D8C2
	WFD coastal waters	Eutrophication	D5C1-D5C8

¹¹⁶ Some species groups occur only rarely or not at all in the Baltic Sea and Black Sea.

¹¹⁷ Regulation (EU) No 1379/2013 Article 38

GD 19: Article 8 Assessment Guidance

Region	Scales (large to small)	Features	Criteria
North-East Atlantic Ocean, Mediterranean Sea	Region	Deep-diving toothed cetaceans Baleen whales Deep-sea fish	D1C1-D1C5
	Catch or production area [sub-area or division listed in the FAO fishing areas] ¹¹⁸	Contaminants – in seafood	D9C1
	Ecologically-relevant scales [populations] based on specified aggregations of ICES, GFCM or FAO areas	Commercially-exploited fish, cephalopods and shellfish	D3C1-D3C3
	Subregion	Birds (all groups) Small toothed cetaceans Seals Turtles Pelagic shelf fish Demersal shelf fish Cephalopods (all groups) Species (for D8C4)	D1C1-D1C5 D2C2, D2C3 D8C4 D10C4
	Subregion or subdivisions	Ecosystems (all types) Impulsive sound in water Continuous low-frequency sound	D4C1-D4C4 D11C1, D11C2
	Subdivision of subregion	Coastal fish	D1C1-D1C5
	Subdivision of subregion	Pelagic habitats (broad, other) Hydrographical changes Physical loss of the seabed Physical disturbance to the seabed Benthic habitats (broad, other)	D1C6 D2C2, D2C3 D6C1-D6C5 D7C1, D7C2 D8C4
	Subregion, divided where needed by national boundaries	Acute pollution events	D8C3
	Subdivision of subregion, divided where needed by national boundaries	Newly introduced non-indigenous species Litter in the environment Micro-litter in the environment Litter and micro-litter in species	D2C1 D10C1, D10C2, D10C3
	Subdivision of subregion, divided where needed by national boundaries (beyond coastal waters)	Eutrophication	D5C1-D5C8
	WFD coastal and territorial waters	Contaminants - non UPBT substances Contaminants - UPBT substances Species Benthic habitats	D8C1, D8C2
WFD coastal waters	Eutrophication	D5C1-D5C8	

¹¹⁸ Regulation (EU) No 1379/2013 Article 38