



HAL
open science

Overview of the EROI, a tool to measure energy availability through the energy transition

Kevin Pahud, Greg de Temmerman

► To cite this version:

Kevin Pahud, Greg de Temmerman. Overview of the EROI, a tool to measure energy availability through the energy transition. 2022 8th International Youth Conference on Energy (IYCE'22), Jul 2022, Eger, Hungary. 10.1109/IYCE54153.2022.9857542 . hal-03780085

HAL Id: hal-03780085

<https://hal.science/hal-03780085>

Submitted on 19 Sep 2022

HAL is a multi-disciplinary open access archive for the deposit and dissemination of scientific research documents, whether they are published or not. The documents may come from teaching and research institutions in France or abroad, or from public or private research centers.

L'archive ouverte pluridisciplinaire **HAL**, est destinée au dépôt et à la diffusion de documents scientifiques de niveau recherche, publiés ou non, émanant des établissements d'enseignement et de recherche français ou étrangers, des laboratoires publics ou privés.

Overview of the EROI, a tool to measure energy availability through the energy transition.

Kevin Pahud
Swiss Federal Institute of Technology in Lausanne (EPFL),
Switzerland
Zenon Research, 75006 Paris, France
k.pahud@gmail.com

Greg De Temmerman
Zenon Research, 75006 Paris, France
Mines Paris PSL, IHEIE, 75006 Paris, France
Institut Louis Bachelier, 75002 Paris, France
greg@zenonresearch.com

Abstract— The importance of energy consumption to allow societies to thrive is well established and prospects of energy needs is well derived through the scientific literature. Yet, lesser discussions persist on the future availability of energy for current industrial economies, a crucial indicator for development. It is defined as net-energy analysis, where one must appropriate more energy than required to get it. The most common indicators are the energy payback time and the EROI (Energy Return of Investment). These indicators are used throughout literature either for energy vectors, energy systems or for broader societal applications.

Following growing concerns about climate change, and with the increasing difficulty of extraction of fossil fuels, EROIs became tools to study the global energy transition with a focus on a possible minimum EROI required to maintain a complex society. However, the indicator is used with a large variety of methods, definitions, and boundaries. This led to a lack of consensus on whether a transition to renewable-based energy systems could still provide sufficient net energy for societies to thrive. The concepts of EROI were studied by compiling its various definitions, boundaries, and limits, allowing a clear view of the indicator to understand where and how it could be used. This led to finding three main classes of indicators: the physical EROI, an indicator based on energy consumption, a price-based societal EROI, an indicator using monetary expenditures to look at energy-related expenditures, and finally a socioeconomic EROI which looks at energy expenditures within a nation's economy.

A detailed review of those use cases led to understanding that the EROI is often badly calculated through wrong boundaries, goals, or with old data and that no norm exists for its calculation. These inconsistencies tend to negatively bias renewable technologies as a solution to the energy transition. Furthermore, most calculations of minimal EROIs are based on fossil fuel infrastructure, with current energy systems being highly inefficient. The previously calculated minimal EROIs through literature, penalizing renewable technologies, are challenged.

The study discusses the possibility of transitioning away from fossil fuels' dependence based on updated data and literature to finally conclude that renewable can offer sufficient energy through the energy transition. This sufficiency however comes with short-term limits followed by a possible drop in net-energy due to the transitory nature of the global shift to mitigate climate change.

Keywords—*Net-energy, EROI, Energy transition*

I. INTRODUCTION

The concept of energy consumption throughout societies has been studied thoroughly and its links to development are well established nowadays [1]. Current trends indicate an ever-increasing energy use and the question of energy needs in the future has been examined through various lenses [2]. Regarding energy availability to societies, being able to use energy requires extracting it from nature and transforming it, which de facto requires investing energy to acquire it. Yet

only a few discussions arise on the net availability of energy i.e., the surplus to society. For any living organism, an excess of energy is required to survive and reproduce [3]. Observing human societies from a biophysical standpoint, the same requirements exist. Growth and sustainability require that the effort necessary to obtain energy be lower than the received energy [4]. This concept of surplus energy can be assimilated to the “abundance” aspect of energy, in other terms how difficult it is to obtain this energy. As opposed to the “quantity” aspect of energy, how much a society consumes in total. The energy surplus is defined as the net available energy, where one must get more energy into the system than was required to obtain it.

Human development, economic and societal growth were supported by energy resources providing higher and higher energy payback ratios [5]. Following Fig. 1, looking at world primary energy consumption [6], starting with pre-industrial societies, energy returns were low as energy resources consumed were agricultural products (food and fodder) and wood fuel [7]: sparse and with low energy densities. The industrial revolution, with the replacement of biomass by high energy density fossil fuels, such as coal and later crude oil, led to increases in net energy returns to society which fueled economic growth. A typical example is Great Britain, where easy access to coal between 1700 and 1800 led, amongst other things, to a head start towards the industrial revolution [1]. The post-WWII economic growth was sustained by abundant access to high energy density sources such as large-scale extraction of cheap oil with very low energy investments, followed by other sources such as natural gas, nuclear energy [8]. The continuously increasing consumption of fossil fuels was shaken by the 1970s energy crisis (the 1973 and 1979 oil shocks) which led to a growing concern relating the availability of fossil fuels. As oil extraction increased in difficulty (seen in the increasing extraction costs), gross energy analysis (neglecting energy costs of extraction, refining, distribution) became limited to assess the surplus to society [9]. The lack of net available energy data and the vulnerability of OECD nations to energy spikes [10] led to the creation of net-energy analysis (NEA), which includes the estimates of all costs incurred to obtain a given energy vector.

The most common indicators in net energy analyses, developed in the 1970s [10], are the energy payback time and the EROI [12]. The specific term EROI was popularized in a 1986 publication by Hall, Cleveland, and Kaufmann, *Energy and Resource Quality: The Ecology of the Economic Process* [13]. The former is defined as the time required to produce sufficient energy to reimburse the embodied energy used to build the studied energy systems or extract the studied

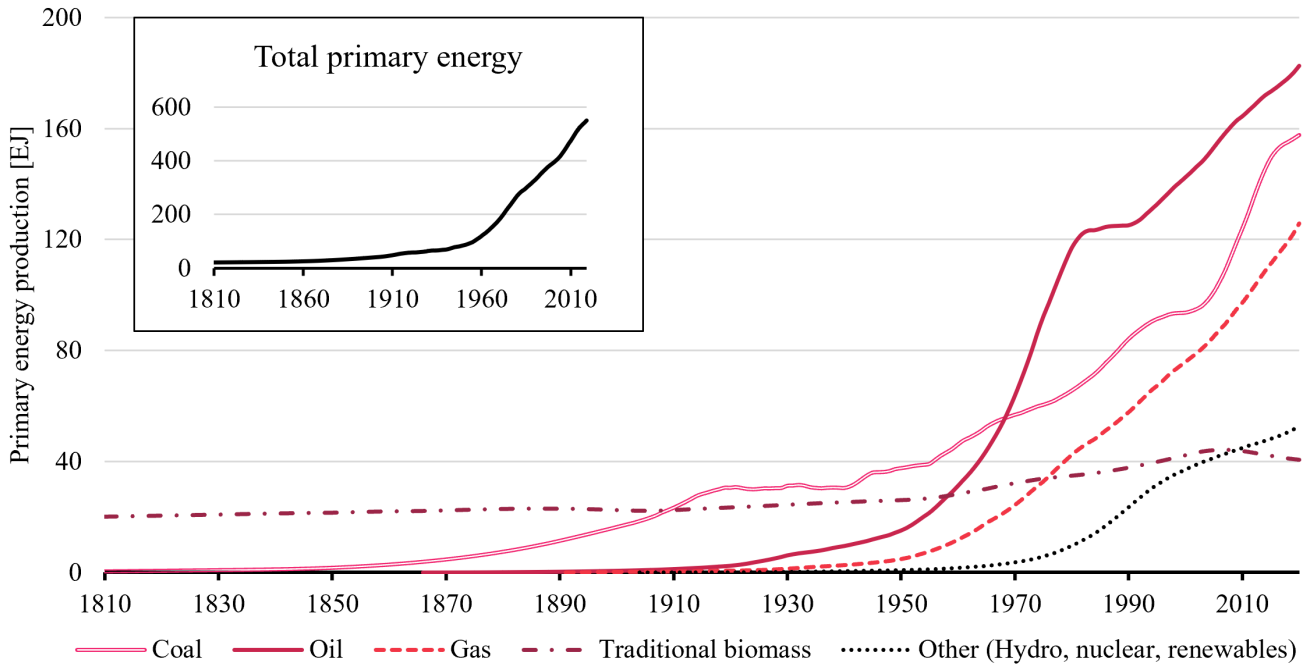

Fig. 1. World primary energy production, by source, between 1810 and 2020. Data retrieved from *Our World in Data*. Physical content method.

resource. Energy vectors with high energy density have the advantage of low payback times. The latter can be defined analogously to a monetary return on investment.

The EROI, based on (1), is defined as the energy return on energy invested for a given energy system or vector EROI [14]. It measures how much energy output is obtained given the initial required energy investments and is a dimensionless number.

$$EROI = \text{Energy obtained} / \text{Energy invested} \quad (1)$$

Yet, following growing concerns about climate change, and concerns about Variable Renewable Energy (VRE) technologies, the EROI became a tool to study the possible consequences of the energy transition, rather than only the yield of specific energy vectors. For example, many authors were concerned that the energy transition might see a decreasing EROI and thus decrease the energy available to society. Looking at Fig. 2, a higher EROI is translated in a higher net available energy towards society.

Indeed some authors postulate that a minimum EROI is required to sustain our modern society [15], for example a minimum of around 3 [16]. Furthermore, some point a threshold of an EROI of 25 to obtain social welfare and well-being [17]. And indeed, there is a strong correlation between energy use and the human development index (for example) and the global net energy available is therefore important, although one should note that a lot of room exists to improve the energy efficiency of our society.

The focus was increasingly put on modern VRE systems, as they will most likely represent a large share of future energy systems [18] and because they have a much lower energy density than fossil fuels. This low energy density also implies a high material demand per unit of energy, especially in terms of metals. Hydropower and nuclear technologies, despite not being the focus of the study, are used in examples as they represent future energy systems as well.

The question thus asked by the scientific literature is whether the energy transition will lead to a decrease in the net available energy, even if temporary. Some scholars insist that renewables won't provide sufficient net-energy to society [10], [15], [19], [20], whereas other scholars insist that renewables can compete with current energy systems [21]–[23]. Such strong disagreements deserve a deeper examination. By focusing on the EROI as main indicator for net energy, this report will attempt to answer whether the upcoming energy transition towards a mostly renewable based energy system can solve the two-challenge: meet climate goals and provide sufficient energy to society.

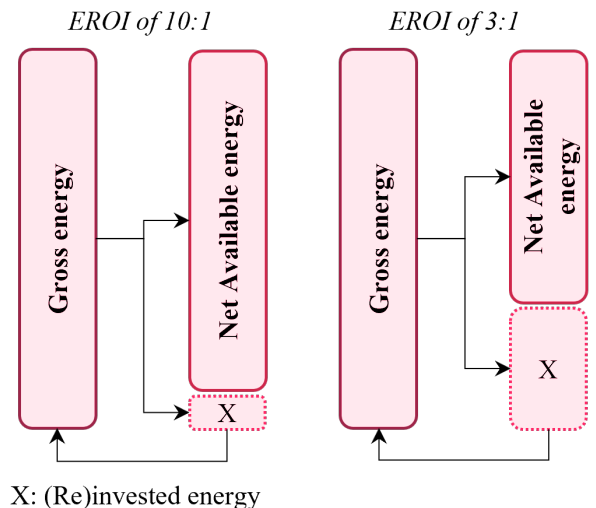

Fig. 2. Links between EROI, gross energy and net available energy for societies.

II. CONCEPTS OF THE EROI

While the EROI definition is relatively simple, estimating it relies on significant efforts and end results are very sensitive to the used method [24]. This includes the definition of the boundaries, the definition applied to the

indicator, and the data gathering process. It is thus important to clearly specify the method and the assumptions made in the calculations. Finally, it is crucial to consider the dynamic aspect of the EROI, given the evolution of technologies and/or given the scarcity of a particular energy vector, as well as how its value changes with scale (i.e., a lab-scale project versus industrial scale project). This relates to the necessity of explicitly defining the EROI before assessing its implications for societal needs and energy availability. It is thus clear that the conclusions of EROI calculations are only valid within the scope of the estimates.

Given the various problematics associated with the EROI concept following a survey of the literature, we choose to discuss the EROI under the 3 following perspectives:

- The physical EROI ($EROI_p$)
- The price based EROI ($EROI_s$)
- The socio-economic EROI ($EROI_{eco}$)

Each of these indicators are then extended and aggregated to a societal EROI, which studies the available net energy for societies, as a mean of answering the problematic of available energy.

A. The physical EROI

The physical EROI, not to be confused with energy efficiency, was the first indicator used to try and quantify the energy brought by a given resource (mainly fossil fuels) and was subsequently applied for energy conversion technologies. It is currently the most popular variant throughout the EROI literature. Consequently, illustrating the $EROI_p$ with numerical examples would not provide meaningful face values. These indicators are static in time and are dependant on the boundary chosen for the calculation.

1) Resource based EROI

Defined to measure the ease of obtaining fuels, it serves as a proxy to assess depletion versus technological change for a given resource. A declining $EROI_p$ would thus illustrate that difficulty of access is more important than improvements in the technologies required to get the

resource [25].

Assessing what has been said in the introduction, the $EROI_p$ for resources is defined as the ratio of the energy delivered to society to the energy required to get that energy. This definition implies that the $EROI_p$ can be estimated at different stages along the value chain between resource extraction and final use [16]. These boundaries will be explained below. The chosen stage directly affects the denominator of (1) as direct or indirect costs will or will not be integrated in the calculation. These boundaries can be clarified following Fig. 3, which represents the framework for the resource based $EROI_p$. Boundaries are directly associated with the considered supply chains affecting the embodied energy within the indicator.

Going along the extraction/transport chain, the $EROI_p$ is bounded at the point of delivery (POD) of a fuel, the point where the resource leaves the extraction facility. It can also be defined as the mine-mouth, point of extraction, well-head, standard EROI [26] or even primary EROI [23]. The $EROI_{p,POD}$ is thus calculated by dividing the energy available at this point by all the direct energy required to obtain this resource, defined as the embedded energy for delivery in Fig. 3. This indicator is the most used throughout the literature [19], [27], [28] as it enables direct comparisons between different energy vectors which offer the same service and thus represents the category with the strongest incentive for standardization [29]. Next is the $EROI_{p,POU}$, which integrates the required supply chains to transform and deliver the resource to a specific point of use (POU) -the final consumer- as resources at the primary stage have no direct societal application. As the processes of refining and transportation of resources are integrated, the energy costs to obtain these resources increase leading to a decrease of the EROI. The energy costs for transformation and delivery vary for different resources, see section III for further details. As seen in Fig. 3, we have $EROI_{p,POU} < EROI_{p,POD}$. Increasing the scope of the study allows to compare different energy vectors that offer the same end-use service: different thermal fuels for electricity production for example.

Further expansion of the EROI analysis can be done to attain the $EROI_{p,ext}$ which integrates energy costs related to the construction and maintenance of all the infrastructure

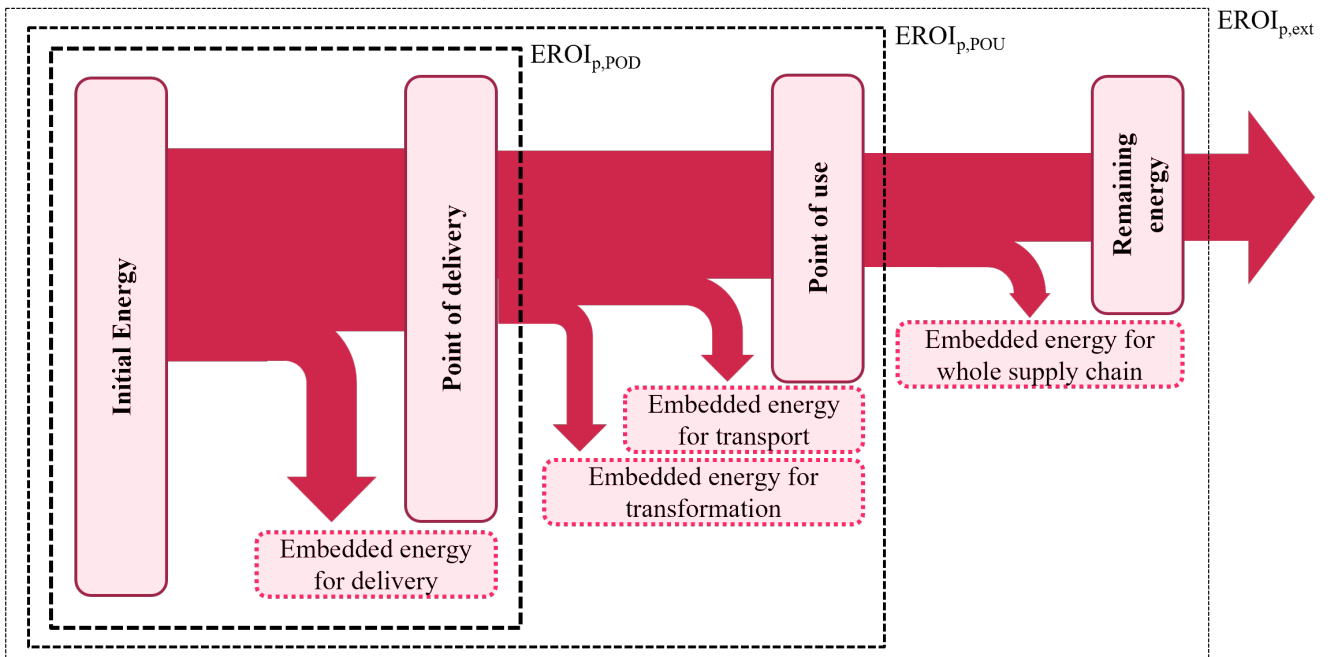

Fig. 3. Boundaries for the calculation of the physical EROI, for energy resources. The three defined boundaries are however usable for other applications other than resources of EROIs.

required to enable energy services for society, in other terms costs related to the utilization of the resource. This scope includes all the supply chains requiring indirect energy usage (e.g., exploration, labor, investments) to deliver the energy carrier [30] as defined in the Input/Output methodology. As an example, inclusion of energy costs to build all machinery and equipment for fossil fuel exploration would be included, or all energy costs to construct refineries for the oil sector. This boundary expansion would thus serve as proxy for a societal EROI.

2) Energy system EROI

Unlike the $EROI_p$ for energy carriers, the $EROI_p$ for energy systems represent the ratio of an energy service (e.g. electricity, heat) delivered by all energy costs throughout all pre-defined supply chains required to enable this service, for a given facility. The boundaries for energy systems EROIs are equivalent to those defined above for energy vectors [23], [31]–[33]. Backed by Fig. 4, the $EROI_{p,POD}$ encompasses energy inputs to build, operate, maintain, and decommission an energy conversion plant required. Its output is located at the exit of the energy system, like the point of delivery of an energy vector $EROI_{p,POD}$, in Fig. 3. This boundary enables quick assertions of technological improvements for a given facility. Following Fig. 4, calculating the $EROI_{p,POD}$ would be defined as following:

$$EROI_{p,POD} = (a) / \{(b) + (c) + (d)\} \quad (2)$$

As for the case of energy carriers, expanding the boundary of the EROI for energy systems to its final service is more interesting. Estimates are expanded to the point of use as it represents a more realistic approach by embedding the energy required in transformation and distribution. The $EROI_{p,POU}$ allows to compare energy systems providing the same final demand for the user. However, analogous to life cycle analysis (LCA), if energy systems offer the same final service, this boundary can be neglected for comparison only [34], such example would be transmission lines which are the same for a fossil power plant or a wind farm. It must however be noted that this argument increases the EROI of the energy system and could be misrepresenting reality. Finally, EROIs for energy systems can integrate all indirect energy costs required to deliver energy to a user using a similar approach to energy carriers, and thus be defined as $EROI_{p,ext}$ [32].

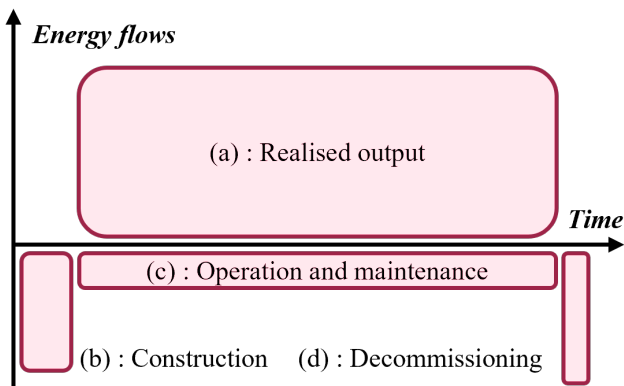

Fig. 4. Energy flows diagram for the calculation of the energy system point of use EROI

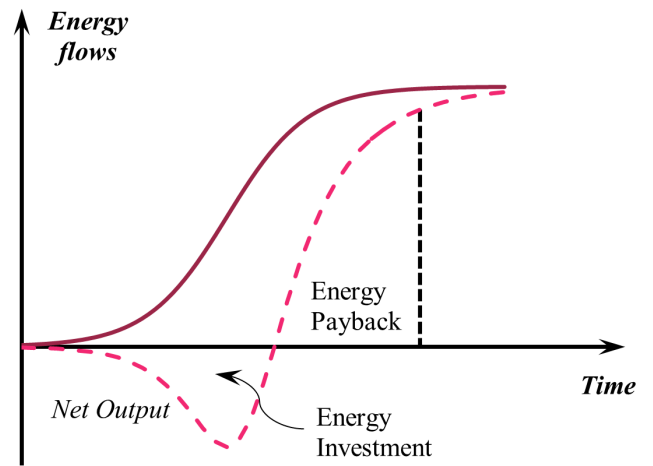

Fig. 5. Industry scale energy flows for calculation of net energy, inspired by Dale and Benson [35].

Nevertheless, what distinguishes energy systems EROIs from resource based ones is the selected timeframe when defining the scope of the EROI [36]. Calculating the $EROI_p$ of a power plant would include energy flows throughout the lifetime of the facility whereas the $EROI_p$ of a resource is defined on yearly basis with energy flows. This characteristic is crucial when comparing different EROIs. Enabling assertions requires expanding energy systems to a geographical or industrial scale. Industry levels of an energy conversion technology thus represent coherent scales of comparison as energy flows are directly accounted per year. Energy outflows of a given year are the realised output of previous energy investments. According to the type of industry, lagged energy outputs occur as these scales are simultaneously composed of overlapping projects. Looking at Fig. 5, the net output of energy flows is thus initially negative, as energy investments are required to develop such industry. This involves continuous construction, production, decommissioning etc. Thus, EROIs for energy systems integrate growth rates of the technology's industry [37].

The $EROI_p$ of an energy system allows to illustrate the progress of a given technology whether in its manufacturing or efficiency of energy conversion. An example can be given with material usage for silicon based photovoltaic devices, where silicon requirements fell from 16 gram per nominal Watt to around 3 grams per nominal Watt from 2004 to 2020 [38].

As discussed in this section, many of the stated $EROI_p$ are directly dependent on the scope selected for the estimation of the indicator. This means that aggregating EROIs with various scopes leads to a decrease on the quality of final indicator.

B. The price based EROI

Unfortunately, most of the data on costs of fossil fuels operations to determine the $EROI_p$ are in monetary, not energy terms. Reasons are fossil fuel companies not having the incentive to release such data to the public, or even ensure quality controls of it [14]. However, statistics such as oil & gas industry monetary expenditures for exploration, development, and production, whether global or regional are used. Methods to estimate historical EROIs for primary energy sources such as oil, gas and coal were developed using monetary data such as the energy intensity of an

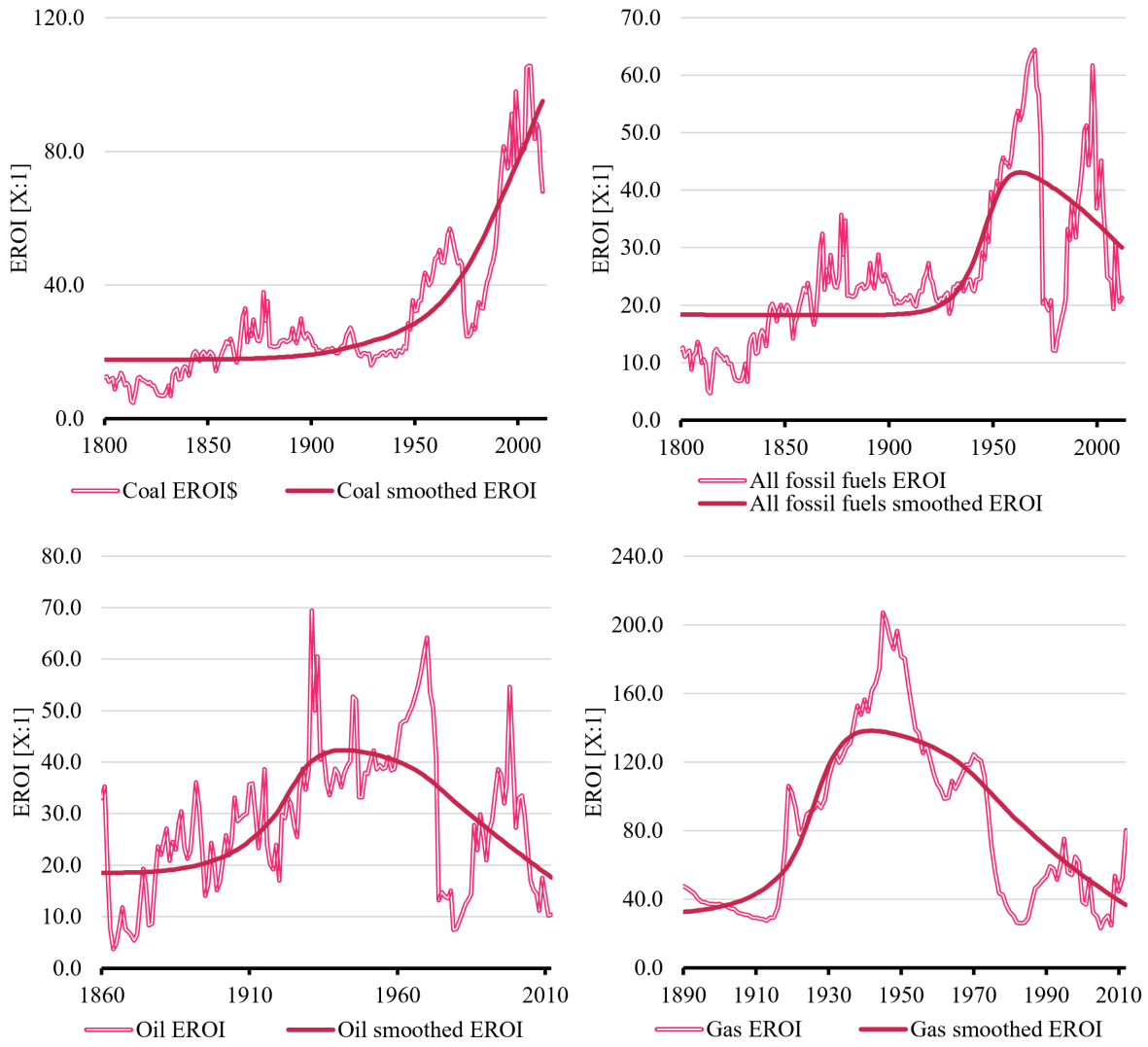

Fig. 6. Historical price based EROIs for coal, oil, gas and aggregated fossil fuels. Smoothed and original time series are shown. Data from *Court and Fizaine* [40].

economy, energy prices and monetary returns of investments [14], [39]–[41].

Looking at (3), for each given energy resource i , the estimation of the $EROI_s$ is given by dividing the energy consumption $E_{out,i}$ of the studied sector by the “input” energy. The denominator is defined as the product of the energy intensity $E_{l,i}$ by the energy expenditures $E_{\$,i}$ in that sector. Methods then differ throughout literature on the estimation of the expenditures. By using monetary costs, the $EROI_s$ can thus be defined as a proxy for the difficulty of extraction of a resource as well as technological improvements and serves as a parallel to the “real” $EROI_{p,POD}$ [41].

$$EROI_{s,i} = E_{out,i} / (E_{l,i} \cdot E_{\$,i}) \quad (3)$$

This calculation results in estimates of historical trends for EROIs which are mainly focused on fossil fuels. Reasons are their high share of global energy consumption (see Fig. 1), as well as increasing difficulty of extraction [42]. The calculation is usually done for a selected geographic location, although not specific to a type of energy carrier (e.g. shale oil, offshore oil, biofuels etc.) but rather as an aggregated EROI. The clustered indicator is to

study trends in energy returns and directly serves as a societal EROI. As stated in the introduction, it assesses whether there is a decline in net energy available to society.

Presenting some of the results from the literature, the volatility of energy prices directly reflects into estimates of the $EROI_s$, (Fig. 6), which fluctuate heavily. Oil shocks during the 1970s resulted in a steep decrease of global energy resource EROIs. Smoothing out volatility of the given global EROIs, to obtain an order of magnitude of the global EROIs, indicate an increasing $EROI_s$ for coal and decreasing $EROI_s$ for oil and gas [14], [41]. Regarding coal, the general trend is that of an increasing EROI going from 18 about in 1800 to about 95 in 2012. Peak coal EROI is estimated at 101 in 2023 [41]. These projections however directly depend on the hypotheses undertaken by the authors, which can significantly impact the result, and should not be taken at face value. Looking at fossil fuels in general, some large changes can be seen after the oil shocks, with a smoothed peak at around 43, EROI decreases and is projected to reach a value of 10 in 2080 [41]. These trends are justified by the fact that monetary costs to extract gas and oil increased faster than for coal paired with the fact that resource exploitation ratios are lower for coal [43] (i.e. the recovery potential of coal resource is higher than for gas and oil). The above-mentioned results could follow the narrative

of a decreasing EROI for society. It must however be stated that as proxy, the EROI_s uses primary energy as the output of energy delivered to society, thus not accounting for all supply chains until the end-user.

C. The socio-economic EROI

Yet, looking at the price based EROIs, all energy related monetary costs within an economy to deliver energy are not considered. This leads to the definition of socio-economic EROIs [4], expressed as energy expenditures as a share of GDP [40], [44], which expands the scope of monetary expenditures to the whole economy. Conversely, the EROI_{eco} is formally defined through (4), the GDP divided by energy expenditures within an economy to procure energy, where it is the inverse of energy expenditures as a share of GDP.

$$EROI_{eco} = GDP / \text{Energy expenditures} \quad (4)$$

The EROI_{eco} directly sums all energy flows that an economy is getting by quantifying all expenditures required to obtain these streams and can thus be affiliated as a societal EROI. While not aggregating physical flows but economy-wide monetary flows, the indicator can be seen as an economic surplus which allows societies to thrive [4]. Indeed, industrial societies stagnate when energy costs increase dramatically [45]. Backed by Fig. 8, these expenditures can affect the economy through maximum tolerable prices for energy. Expenditures are thus linked to the capital intensity of an energy technology and/or prices of resources. For US studies, it has been calculated those economic recessions occurred during instances when energy costs rose above 11% of GDP [44]. Indeed, these results being dependent on the energy intensity of a respective economy (i.e., defining how dependent an economy is to energy), the maximum expenditure frontier is different for each country. Hence, various spikes of different amplitudes can be noticed on Fig. 8. Most notable spikes are during the oil shocks of the 70s, with drastic increases in oil prices. It must however be noted that Fig. 7 represents a 10-year rolling average and serves as an illustration to represent energy expenditure spikes, and not an exceeded threshold, such as the previous example.

Recent results, as seen on Fig. 8, represent however an

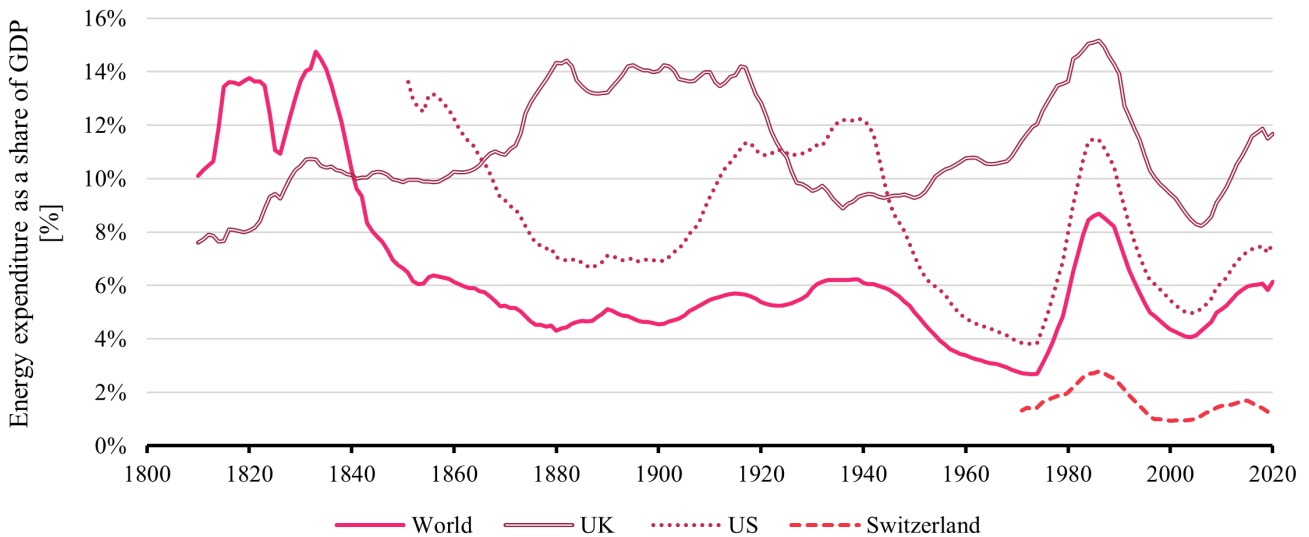

imperfect guide for the EROI of an economy and are not properly scaled to an energy-economic investment.

Calculations for energy expenditures are solely based on energy prices (e.g., oil, electricity production costs, gas). They thus fluctuate over the course of economic cycles, and spikes exist when energy crises occur. These variations do not represent evolutions related to the physical process of energy obtention either at a project-level or at an aggregate level [4]. As an example, a country 100% dependent on oil importations would be directly subject to commodity prices and the EROI_{eco} would not consider productive economic effort to obtain energy.

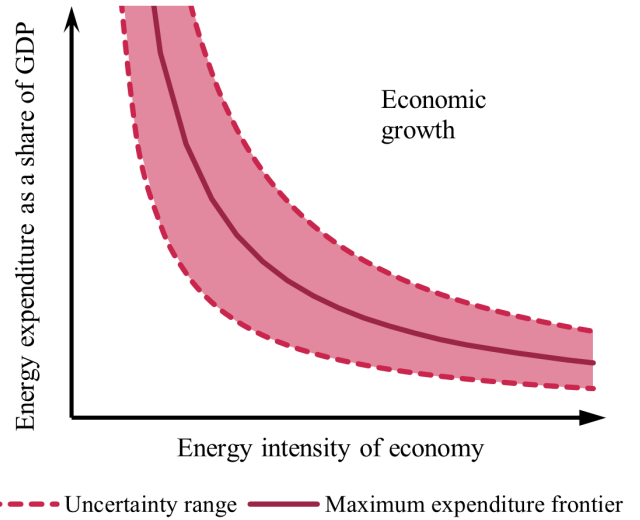

Fig. 8. Maximum expenditure frontier as a function of the energy intensity of an economy, when utilizing the socio-economic EROI for economic growth

Other means of developing the EROI_{eco} are based on the calculation of a national EROI [46], through physical and monetary data. This focus allows to study whether countries can provide sufficient social welfare and growth through the paradigm of a high societal EROI [47], such as the numbers presented in introduction.

This section can be concluded by opposing the EROI_p with the EROI_{eco} and EROI_s. Physical EROIs have the advantage of directly assessing the productivity and

performance of a technology or energy vector which contributes to society at various levels. It however remains a

Fig. 7. Energy expenditures as a share of GDP for the World, UK, US and Switzerland, 10 year rolling averages. Data from *Fizaine and Court* [43] for World, UK and US values. Switzerland values are calculated from *Fizaine and Court* method [43], data from *Swiss Federal Office of Energy* [47].

static indicator which could lead to potential wrong conclusions, as we will discuss in the following sections. Monetary EROIs, though not directly measuring energy related activities, enable a dynamic time series of net-energy provided to society, but remain at a primary level of the EROI, neglecting the remaining supply chain energy costs.

EROIs are calculated through various means (e.g. physical, price-based, socio-economic) using different boundaries (point-of-delivery, point-of-use, extended) for different geographical and time periods. This being stated, answering the defined problematic leads to inconsistencies and missuses of the EROI, given its complexity and validity within its scope defined. The following section will present why such consensus does not exist for the answer to our question.

III. EROIs AND THEIR CURRENT SITUATION

A. A defined framework for a defined goal, discrepancies regarding EROI estimates.

EROI estimation is vast, and its analysis requires defining what goal is desired when performing such task, similarly to LCA guidelines [34]. Indeed, a defined goal will offer a distinct set of boundaries when estimating an EROI, which can be applied for distinct reasons:

- Defining the viability of an energy conversion project in terms of energetic costs.
- Analysing the difficulty of extraction of a resource.
- Performing comparative assertions of energy technologies that serve a similar service.
- Calculating a minimum societal EROI to allow current societies to sustain, using a metabolism perspective.

Issues of scope thus arise when the function of the studied indicator is not well defined, or when goals shift during analysis [48]. Such example would be assessing the EROI of a renewable technology as a stated goal while integrating storage to compensate for variability of the technology [49]. This would generate a conflict of desired goal as in one hand, the viability of a technology is studied whereas on the other hand, its analysis integrates a societal EROI as goal (e.g., the required electricity for society). Such discrepancies would be reduced when integrating defined conventions [50] and frameworks [31].

The scope of the indicator's estimates represents the main source of misinterpretation of the EROIs, notably with the $EROI_p$, whether societal EROI is the end goal or not. As a first, a lack of explicit definitions of boundaries lead to various EROI values despite supposedly similar processes [51], most notable example being the case of corn-based ethanol [52]. Despite same feedstock and same technology of biofuel conversion, end results fluctuate [24]. This leads to inconsistencies when comparing various estimates of the EROI. Explicit boundaries are crucial to avoid spurious conclusions on energy availability. Such examples are using point of use EROIs from literature to directly assess the availability of energy to societies while neglecting all the subsequent elements to deliver usable energy, as seen in Fig. 3. Attempts have been made to correct global physical EROIs from point of extraction to the extended EROI, thus including all indirect energy costs, to assess the net energy available to societies [23], [32], [53].

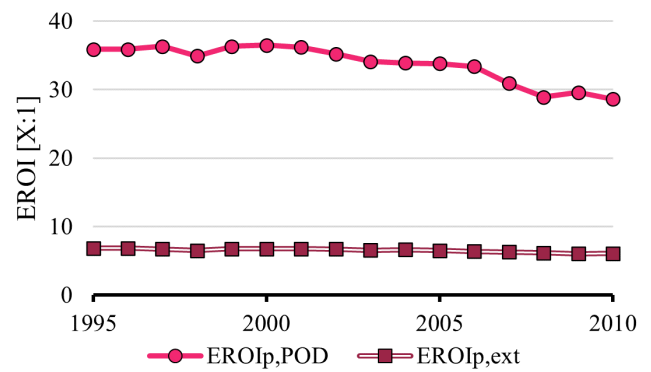

As an example, Fig. 9 illustrates this result as the Fig. 9. Historical evolution of global fossil fuels EROI at the point of delivery and extended level. Data from Brockway et al. [22]

correction reduced the EROI by 80% on average. Integrating all supply chains with their respective indirect costs also impacts the rate of decrease of the EROI. The point of extraction global EROI for fossil fuels decreased by 21% whereas the global fossil $EROI_{p,ext}$ saw a decrease of only 11%. In 2010, the extended EROI was capped at a value of 6, opposed to a value of 28 for the point of use EROI. Such extension of the scope was also applied to China's fossil fuel EROI. Through the input/output method, the $EROI_{p,ext}$ for fossil fuels declined from 11.01 to 5.26 between 1987 and 2012 [53]. Similarly, to fossil fuels, the expansion of boundaries has been established for current renewable technologies at a global average level [32]. Looking at wind offshore in Fig. 10 for example, integrating costs related to transmission cuts the EROI by half. Extending the boundary to include all indirect costs reduces wind offshore to an extended EROI of 2.9, for a global average. The same conclusion appears for renewable technologies, each subsequent boundary decreases the maximum attainable EROI. These global current estimations however mask many regional differences depending on the quality of the resource, such as grid quality, solar irradiation, or wind speed.

Furthermore, EROI calculations do not undertake any form of energy quality adjustments, such as differences between heat and electricity: there are methodological differences relating to the functional unit of the studied indicator [21]. This is directly linked to the resource or technology not offering the same end-use service: electricity offers much more end services and is easier to transport,

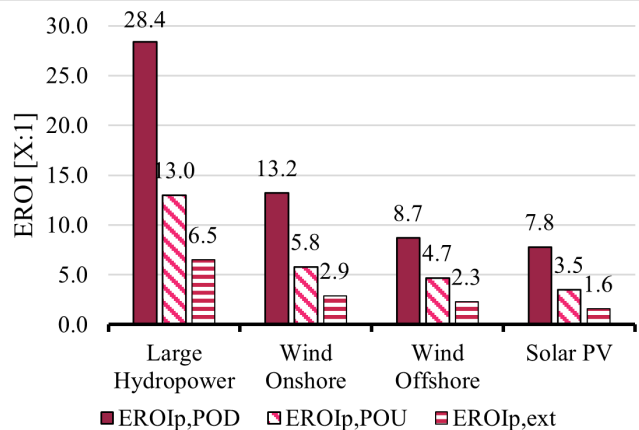

Fig. 10. EROI estimations of different energy systems at different defined boundaries. Data from de Castro and Capellán-Pérez [31].

whereas resources (from which electricity is mainly produced) can be easily stored [36]. Similarly, comparisons between an internal combustion engine and an electric vehicle allow to fully grasp the end service for societies, rather than oil versus electricity. Misinterpretations thus arise when comparing energy conversion technologies with energy resources. A notable issue is renewable technologies that are directly compared with fossil fuels EROIs from the point of extraction, which are solely adjusted by a thermal loss factor, neglecting other energy consumptions from their respective supply chains [19], [37]. This leads to misinterpretations of renewable technologies potentials for the energy transition and further ignores the need to shift away from fossil fuels.

Comparisons between EROIs, whether energy systems or energy resources, should ensure that all boundaries are thus extended to provide a common energy carrier (e.g., electricity, thermal fuel) without conversion and/or quality factors [21]. Furthermore, a specific basis for comparison should be held to define boundaries. These bases would address the intermittency of renewables, per say, thus adding energy investments for curtailment and energy storage, or increased transmission infrastructure.

B. Scopes of the EROI estimations, a critical element

As stated in section II, most EROIs for fossil fuels were directly calculated at the point of extraction. Such practice limits the usefulness of the $EROI_{p,POD}$ for comparison between energy resources as the net energy delivered to society is the crucial indicator. Comparing different energy vectors at this point of extraction is not relevant as they do not offer the same final service or must go through different processes between extraction and use. Comparisons are valid when all subsequent processes to obtain a usable energy vector are the same. A typical example would be the supply chain of oil: once extracted, the resource must undergo refinery. Required energy investments for refining of oil derived products are considerable and heavily reduce the maximum attainable EROI.

Looking at a case in point in Fig. 11, for oil supply in California, once adjusting for the subsequent refining processes, EROI values are much lower and illustrate a much flatter curve [54]. Furthermore, the decrease in EROI values is much less impressive. From 1955 to 2005, the $EROI_{p,POD}$ saw a decrease of 93% whereas $EROI_{p,POU}$ decreased by 52%. The stage of oil refinery requires the highest energy input [21] to deliver a usable energy product. Similarly, integrating subsequent supply chains of other thermal energy fuels such as coal, EROIs tend to decrease substantially. Looking at Fig. 12, recent studies for coal EROI illustrate a decreasing EROI when integrating all supply chains. The limiting factor here being transportation of coal [21].

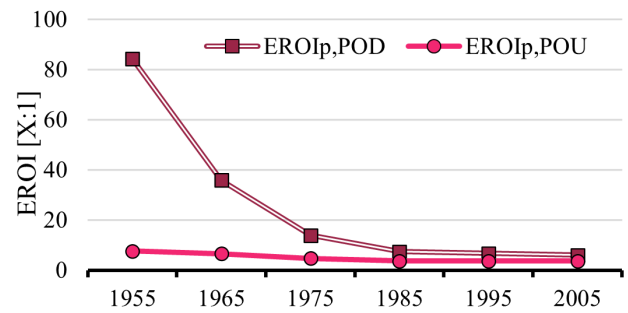

Fig. 11. Historical EROI estimates for domestic oil supply in California, data from Brandt [54].

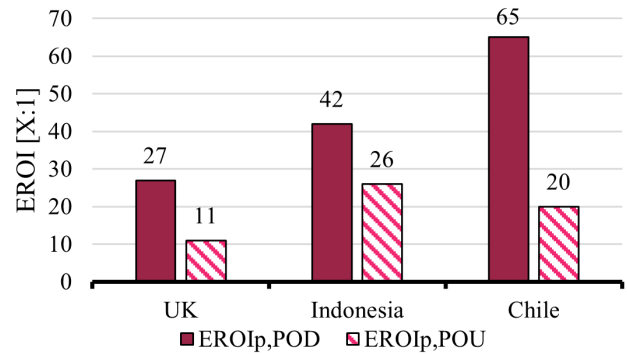

Fig. 12. EROI estimates for coal supply in the UK [55], Indonesia [56], and Chile [57]. Comparative assertion between the point of delivery EROI and point of use EROI, inspired from Rauei [21].

Thus, comparisons are valid when all subsequent processes to obtain a usable energy vector are the same. For example, comparing crude oil of different quality, extracted in different fields at a given time scale. Energy resources thus greatly differ in their actual usefulness at each level of their respective supply chain until the end-user. Conclusions of fossil fuels requiring more and more energy investments for extraction remain however valid [10], [19], with a declining $EROI_{p,POD}$ inversely related to an increase in drilling activities [58]. Fossil fuel industries do consume more and more energy to extract these resources [42]. These end results, amid their defined boundaries, can't imply minimum thresholds of energy requirements for societies as stated by some of the literature [16], [17].

Hence, using the $EROI_{p,POD}$ as an indicator for energy resource availability and ease of extraction is interesting as it enables comparison between types of resources. It should not however be used for societal application with aggregation of estimations.

C. Scales of the EROI

Having addressed the uncertainty of system boundaries when estimating EROIs, net energy analysis, especially when comparing with rapidly evolving renewable technologies [59], [60], is still limited by its static nature [61]. End-results become irrelevant as data used in the EROI literature quickly become outdated [62]. Indeed, innovations along the value chain, whether material or energy efficiency, of power plants reduce the energy requirements. Looking at silicon photovoltaic technologies, continuous industry improvements led to simultaneously enabling steady yearly efficiency gains and reduced material requirements [63]. This provokes inconsistencies when establishing forecasts of

future renewable EROIs if the potential to improve technologies through innovation is disregarded.

Looking at the $EROI_{p,POD}$ of modern renewable technologies (e.g., wind and solar), their EROI estimates have increased over time in the past. Wind turbines' point of delivery EROIs increased from 12 to 23 between 1990 and 2015 [61], an increase of 92%. Solar PV technologies had their EROIs at point of delivery increase from approximately 1 to around 9 between 1990 and 2015 [61], an increase of 800%. Furthermore, based on historic energetic experiences rates (e.g., historically decreasing energy investment costs and increasing energy outputs), their estimates are set to continuously increase by 2040 [61]. Mean values of approximately 15 and 28 for solar and wind respectively are set to be reached. By establishing a comparative assertion with coal-based power generation, from a net energy perspective, renewable technologies surpass fossil fuels at the point of delivery boundary. Other studies confirm this result at point of delivery with values averaged at 25.2 for wind technology in 2010 [64].

There is thus a constant technological progress occurring at the technology level which shouldn't be neglected when performing dynamic EROI calculations. However, for such results to be valid at a societal level, analysis of individual systems cannot be done. The extended EROI should be calculated, thus integrating all required infrastructure, to allow the same-energy service. Regarding added

infrastructure are usually not added in EROI literature when estimating societal EROIs [65].

Furthermore, structural scales (i.e., the differences between a facility and a sector) affect the EROI estimations, especially when looking at societal EROIs. Previously stated in section II, energy flows differ when studying an energy system (e.g., a specific wind turbine) opposed to a geographical or industrial scale (e.g., the wind sector). As current energy delivery pathways are based on annual energy flows, directly comparing them at a societal EROI with energy systems' EROIs is not consistent. As an example, going back to Fig. 4, if the year selected for comparison is within the construction period of the power facility, its EROI would simply be equal to 0.

Regarding the oil & gas sector, most EROI (whichever boundary selected) calculations were directly done at the industrial scale [25]. Nonetheless, energy system EROIs are rarely estimated at the industrial scale, except for a few cases [35], [66]. Thus, performing comparative assertions requires the distinction between the facility and the technology, especially when comparing renewables with the oil and gas sector. Integrating facility scale EROIs (at point of use) with growth rates of the given sector allows to establish an industry scale EROI, usually defined as PROI among scholars [35]. Here, the E letter of Energy is replaced by P for Power, as energy flows per year are studied.



infrastructure for total renewables systems, energy costs for

When accounting for the growth rate of the renewable industry, by looking at Fig 13, as energy investments are

Fig. 13. PROI of industry scale PV and wind technologies, as a function of EROI and industry growth rate. Figure from Carbajales-Dale [36].

required for the development of such technologies, the industry scale EROI (hereafter defined as PROI) is lower than the respective EROI of technologies, at point of use. Nevertheless, most technologies increased in PROI throughout years, and are currently net energy producers. Increased capacity of a technology leads to a higher PROI [35]. This is translated by renewables, at point of use, being net-energy producers. Illustrated by Fig 13, there is a continuous improvement of different renewable technologies, leading to higher PROIs. This suggests that EROI calculations, whichever boundary defined, should consider the non-steady state aspect of industrial sectors.

IV. IS A 1:1 TRANSITION TO RENEWABLES POSSIBLE?

Following the definitions of net energy ratios as well as their limits and realities when utilizing them, the discussion can thus arise to understand whether the upcoming energy transition towards a mostly renewable based energy system can solve the two stated challenges: meet climate goals while providing sufficient energy to society.

A. Understanding the transition with renewables

There is a need to understand the **transitory state** of current energy systems. Current renewables technologies still rely on fossil fuels, which offer declining EROIs. Thus, extended EROIs for renewables are based on current infrastructure with low EROIs which directly penalize them. This concept is key to understand the current low estimates, when integrating supply chains. For instance, building the necessary infrastructure to build and maintain renewables currently requires fossil fuel. Similarly, development of oil relied on the previously coal-based infrastructure to enable such transition [1]. On top of this current transition and reliance, the shift is made towards a system where losses are a lot lower due to higher electrification [18].

Following results from section III, integrating methods correctly when assessing renewable EROIs leads to higher end results directly benefiting such technologies. Furthermore, based on previously stated arguments, renewable technologies are not mature yet. Constant

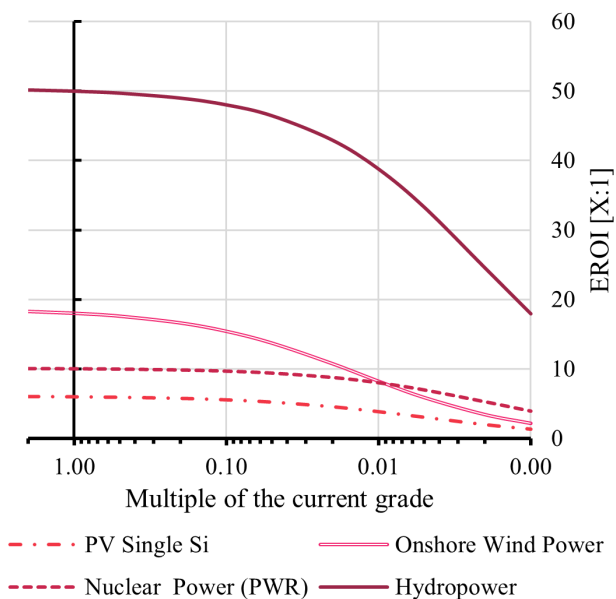

advances in efficiency, production and deployment promises increasing net-energy returns, whether at the facility or

industry scale. Such advances can already be seen in comparison to fossil fuels. A comparative assertion between fossil fuels with CCS and renewable technologies with inclusion of storage for point of delivery EROIs for electricity production, illustrate that with current technologies, renewables take the lead [67]. Utilizing fossil fuels should thus be towards the energy transition and deployment of future energy systems.

Nevertheless, renewable technologies are constrained by material usage and not energy scarcity. Consideration of the EROI in terms of quantity of resources must be integrated. A decrease of ore grade leads to an increase of energy costs of upstream mining activities. However, there is no risk of diminishing EROI for renewable and nuclear technologies, given the current state of technology, unless we attain a very low-grade quality of each consumed ore[68]. Nevertheless, if all ores are considered at once, there is a risk of an important decrease in EROIs, as seen in Fig 14. Furthermore, when integrating infrastructure material costs (i.e., to extend the boundary of the EROI), such as copper, lower ore grade can globally decrease renewable technology EROIs [69]. Globally decreasing ore grades have been observed for the past decades except it is not a clear sign of richest deposits being depleted [70], [71]. Furthermore, various levers could decrease this risk, such as higher recycling rates [68]. Material availability thus represent a long-term limit to societal development and do not affect the current energy transition. Behavioural changes as well as sufficiency objectives should, however, be integrated [72].

B. A small societal drop due to multiple factors?

When discussing a societal EROI, based on indications from section III, a risk of contraction can persist. High installation of renewable capacities, associated with their respective required infrastructure, would generate an unavoidable drop in societal EROI because of higher resource allocation. Based on the previously explained Fig. 5, given the current growth rate (i.e., capacity installation rate), there is currently a region where energy systems consume more than they produce. A debt of energy exists, thus a small societal drop. It should however be noted that this is due to a lag in energy production and represents a transitory and not steady state.

Furthermore, VRE technologies have their energetic performance (i.e., EROI) directly dependent on the implementation location. Such example would be implementation of mono-SI photovoltaic technologies. Requiring an $EROI_{p,POD}$ of 9 (with current technology performance) would limit the maximum spatial availability to 15% of the global potential, whereas an $EROI_{p,POD}$ of 5 would limit to 98% of global potential [73]. In terms of net-energy, surplus is directly dependant on the implementation of VRE technologies. This suggests that desiring a minimal EROI at point of delivery constrains available locations for installation and thus generates usage competition. Current planification for short and long term should prioritize such VRE investments to maximize energy outputs, increasing EROIs. Consequently, given the scale of renewables growth, implementing such technologies with low EROIs would contribute to a small drop in net available energy as energy paybacks would be considerably lagged investments. Minimizing this drop should thus induce portfolio diversification to a maximum to limit this constraint and

thus reach maximum facility scale EROIs, by limiting usage competition.

The previous elements are thus illustrated by simulations. When performing scenarios of a fast energy transition from fossil fuels to renewable technologies in the electricity sector, through integration of energy and material requirements, the shift generates a small drop. Some literature illustrates a transitory passage through a societal EROI of 3 to a steady state value of 5 by 2060 [33], or a value of 6 through 100% renewable technologies [74].

Furthermore, the variable aspect of renewable technologies, satisfying regional or global energy demand, would require additional energy investments through storage, interconnections to compensate the combination of such technologies [75].

Finally, renewable technology is based on capital expenditures, the shift is from a fuel-based economy to material-based economy, which shifts the scope of the study for short-term effects on EROI. Energy scarcity does not become the main limiting factor anymore. These effects constrain the EROI through capital availability [4]. Indeed, the transition to a renewable based system increases the rival usage of capital between energy and non-energy sectors, potentially enabling economic contractions during the shift [76]. The necessity to increase capital towards renewable investment and deployment might have a short-term effect on the EROI. The interesting proxy to use would thus be the socio-economic EROI as described in section II.

Combining these numerous arguments, a small societal drop has the potential to occur. The question to ask is whether this would pose a problem to current societies.

C. Is a low EROI really a problem?

Previous studies led to the conclusion that a decrease from a high EROI to low EROIs exists. The question of societies sustaining indefinitely with high net energy is questioned. However, when integrating all supply chains, to ensure a correct goal and scope, EROIs are capped at much lower values and their decrease is much less important. Consequently, the high EROI leading to society prosperity can be challenged. Besides, such a slower decrease is not critical. There is a need to look at when the energy requirements for extraction surpass the energy requirements for transformation and distribution, as seen in section III.

Thus, irrespective of the initial EROI at point of extraction, the subsequent energy investments along the supply chain severely constrain the maximum achievable EROI at point of use for oil (and indeed all fossil fuels). The question that arises is that is a high surplus of energy needed actually? Given the corrected numbers for EROIs. Furthermore, most EROIs historically are required at a high value to compensate such energy investments on subsequent process of fossil fuels value chains. Keeping these high (methodologically unfounded) EROIs stipulates that all these supply chains will exist throughout the transition. For example, electrification of the current energy system reshapes all energy infrastructures. Transitioning away from such needs would thus lower the “minimal” required EROI for societies to sustain. Utilizing previous minimal EROI values for future energy systems seems unfounded as global

Fig. 14. Energy system point of delivery EROI as a function of ore grade. Data from *Fizaine and Court* [67].

infrastructure transformations are underway.

Furthermore, energy required for societies is located at the end-use, such as work, heat, lighting etc. Such end goal must be assumed to have a consistent EROI calculation, comparing a thermal and electric engine per say. Looking at inefficiencies of the current system, most notably due to Carnot thermal limits, there is room for consequent improvements. Solving these efficiency issues would drastically reduce final energy demand. The EROI indicator might thus be biased as an assessment of minimum required EROI, and negatively influence renewable potential.

V. CONCLUSION

Net energy (hereafter EROI) is deemed a crucial scope of analysis for the energy transition as a policy tool [77]. Levels of energy productivity being assessed; energy resources and production technologies can be valued. This would thus promote renewable technologies with high efficiency and low energetic (or material inputs) and favour reindustrialization of specific countries with high energetic efficiency and low emissions. Deployment of renewables would thus be favoured in locations where meteorological conditions increase the studied indicator. Furthermore, if net energy analysis is to be used by policymakers as a proxy for future energy supply, it is crucial that assessments consider future performance of renewable technologies.

Considering the importance of the EROI for the energy transition, that to be useful as a tool, all estimations must be conducted at the appropriate system level, and within clearly defined and internally consistent spatial and temporal boundaries. Furthermore, the purpose of the estimation should be clearly defined to grasp the stakes of such calculation.

Correcting for inconsistencies of this domain, the premise of uncompetitive renewables against fossil fuels offering less energy to societies, from a net-energy perspective, seems unfounded. Currently, a transition is occurring where technologies are heavily evolving towards better outputs while shifting away from historical fossil fuel-based infrastructure. A transition is possible through global change in all energy systems for mitigation of climate change, with potential bumps during such pathway. Renewable technologies, accompanying the global energy system change, could thus offer the required energy services for society.

As such, given the criticality of climate change, and as renewable technologies currently still require primary energy investments of fossil origin, we argue that available energy resources, should be invested towards the energy transition.

ACKNOWLEDGMENT

The authors would like to thank Dr. Paul Brockway, Dr. Vincent Court, Dr. Florian Fizaine, and Dr. Marco Raugei, who provided the EROI data used in the figures.

REFERENCES

- [1] V. Smil, 'Energy in World History, Vaclav Smil. 1994. Westview Press, Boulder, CO. 352 pages. ISBN: 0-8133-1901-3 (hc); 0-8133-1902-1 (pb). \$44.95 (hc); \$19.95 (pb)', *Bull. Sci. Technol. Soc.*, vol.

- 15, no. 4, pp. 193–193, Aug. 1995, doi: 10.1177/027046769501500417.
- [2] G. De Temmerman, L. Trin, D. Chuard, and J.-B. Rudelle, ‘Powering the world: how much energy will humanity need?’, Mines ParisTech - Ecole des mines de Paris, Technical Report, Oct. 2021. Accessed: Mar. 24, 2022. [Online]. Available: <https://hal.archives-ouvertes.fr/hal-03524462>
- [3] H. T. Odum, ‘Energy, Ecology, and Economics’, *Ambio*, vol. 2, no. 6, pp. 220–227, 1973.
- [4] E. White and G. J. Kramer, ‘The Changing Meaning of Energy Return on Investment and the Implications for the Prospects of Post-fossil Civilization’, *One Earth*, vol. 1, no. 4, pp. 416–422, Dec. 2019, doi: 10.1016/j.oneear.2019.11.010.
- [5] L. Gagnon, ‘Civilisation and energy payback’, *Energy Policy*, vol. 36, no. 9, pp. 3317–3322, Sep. 2008, doi: 10.1016/j.enpol.2008.05.012.
- [6] H. Ritchie, M. Roser, and P. Rosado, ‘Energy’, *Our World Data*, 2020, [Online]. Available: <https://ourworldindata.org/energy>
- [7] R. Fouquet, ‘Heat, Power and Light’, Edward Elgar Publishing, Books, 2008. Accessed: Mar. 16, 2022. [Online]. Available: <https://econpapers.repec.org/bookchap/elgeebook/4061.htm>
- [8] D. B. Reynolds, ‘ENERGY GRADES AND ECONOMIC GROWTH’, *J. Energy Dev.*, vol. 19, no. 2, pp. 245–264, 1994.
- [9] L. Graefe, ‘The peak oil debate’, *Econ. Rev.*, vol. 94, 2009, Accessed: Mar. 16, 2022. [Online]. Available: <https://www.econstor.eu/handle/10419/57664>
- [10] D. J. Murphy, ‘The implications of the declining energy return on investment of oil production’, *Philos. Trans. R. Soc. Math. Phys. Eng. Sci.*, vol. 372, no. 2006, p. 20130126, Jan. 2014, doi: 10.1098/rsta.2013.0126.
- [11] C. W. Bullard, P. S. Penner, and D. A. Pilati, ‘Net energy analysis: Handbook for combining process and input-output analysis’, *Resour. Energy*, vol. 1, no. 3, pp. 267–313, 1978.
- [12] Moomaw, Burgherr, and Heath, ‘Annex II: Methodology. In IPCC Special Report on Renewable Energy Sources and Climate Change Mitigation’, IPCC, 2011.
- [13] C. a. S. Hall, C. J. Cleveland, and R. Kaufmann, *Energy and resource quality: the ecology of the economic process*. John Wiley and Sons, New York, NY, 1986. Accessed: Apr. 07, 2022. [Online]. Available: <https://www.osti.gov/biblio/6400055>
- [14] N. Gagnon, C. A. S. Hall, and L. Brinker, ‘A Preliminary Investigation of Energy Return on Energy Investment for Global Oil and Gas Production’, *Energies*, vol. 2, no. 3, Art. no. 3, Sep. 2009, doi: 10.3390/en20300490.
- [15] L. C. King and J. C. J. M. van den Bergh, ‘Implications of net energy-return-on-investment for a low-carbon energy transition’, *Nat. Energy*, vol. 3, p. 334, Mar. 2018, doi: 10.1038/s41560-018-0116-1.
- [16] C. A. S. Hall, S. Balogh, and D. J. R. Murphy, ‘What is the Minimum EROI that a Sustainable Society Must Have?’, *Energies*, vol. 2, no. 1, Art. no. 1, Mar. 2009, doi: 10.3390/en20100025.
- [17] J. G. Lambert, C. A. S. Hall, S. Balogh, A. Gupta, and M. Arnold, ‘Energy, EROI and quality of life’, *Energy Policy*, vol. 64, pp. 153–167, Jan. 2014, doi: 10.1016/j.enpol.2013.07.001.
- [18] IEA, ‘Net Zero by 2050 – Analysis’, IEA, 2021. <https://www.iea.org/reports/net-zero-by-2050> (accessed Mar. 16, 2022).
- [19] C. A. S. Hall, J. G. Lambert, and S. B. Balogh, ‘EROI of different fuels and the implications for society’, *Energy Policy*, vol. 64, pp. 141–152, Jan. 2014, doi: 10.1016/j.enpol.2013.05.049.
- [20] M. R. Sers and P. A. Victor, ‘The Energy-emissions Trap’, *Ecol. Econ.*, vol. 151, no. C, pp. 10–21, 2018.
- [21] M. Raugei, ‘Net energy analysis must not compare apples and oranges’, *Nat. Energy*, vol. 4, no. 2, Art. no. 2, Feb. 2019, doi: 10.1038/s41560-019-0327-0.
- [22] G. Palmer, ‘Renewables rise above fossil fuels’, *Nat. Energy*, vol. 4, no. 7, Art. no. 7, Jul. 2019, doi: 10.1038/s41560-019-0426-y.
- [23] P. E. Brockway, A. Owen, L. I. Brand-Correa, and L. Hardt, ‘Estimation of global final-stage energy-return-on-investment for fossil fuels with comparison to renewable energy sources’, *Nat. Energy*, vol. 4, no. 7, Art. no. 7, Jul. 2019, doi: 10.1038/s41560-019-0425-z.
- [24] R. L. Rana, M. Lombardi, P. Giungato, and C. Tricase, ‘Trends in Scientific Literature on Energy Return Ratio of Renewable Energy Sources for Supporting Policymakers’, *Adm. Sci.*, vol. 10, no. 2, Art. no. 2, Jun. 2020, doi: 10.3390/admsci10020021.
- [25] C. A. S. Hall, ‘EROI and Industrial Economies’, in *Energy Return on Investment: A Unifying Principle for Biology, Economics, and Sustainability*, C. A. S. Hall, Ed. Cham: Springer International Publishing, 2017, pp. 107–117. doi: 10.1007/978-3-319-47821-0_10.
- [26] D. J. Murphy and C. A. S. Hall, ‘Year in review--EROI or energy return on (energy) invested’, *Ann. N. Y. Acad. Sci.*, vol. 1185, pp. 102–118, Jan. 2010, doi: 10.1111/j.1749-6632.2009.05282.x.
- [27] C. J. Cleveland, R. Costanza, C. A. Hall, and R. Kaufmann, ‘Energy and the u.s. Economy: a biophysical perspective’, *Science*, vol. 225, no. 4665, pp. 890–897, Aug. 1984, doi: 10.1126/science.225.4665.890.
- [28] C. J. Cleveland, ‘Net energy from the extraction of oil and gas in the United States’, *Energy*, vol. 30, no. 5, pp. 769–782, Apr. 2005, doi: 10.1016/j.energy.2004.05.023.
- [29] D. J. Murphy, C. A. S. Hall, M. Dale, and C. Cleveland, ‘Order from Chaos: A Preliminary Protocol for Determining the EROI of Fuels’, *Sustainability*, vol. 3, no. 10, Art. no. 10, Oct. 2011, doi: 10.3390/su3101888.
- [30] S. Casler and S. Wilbur, ‘Energy input-output analysis: A simple guide’, *Resour. Energy*, vol. 6, no. 2, pp. 187–201, Jun. 1984, doi: 10.1016/0165-0572(84)90016-1.
- [31] D. J. Murphy, M. Carbajales-Dale, and D. Moeller, ‘Comparing Apples to Apples: Why the Net Energy

Analysis Community Needs to Adopt the Life-Cycle Analysis Framework', *Energies*, vol. 9, no. 11, Art. no. 11, Nov. 2016, doi: 10.3390/en9110917.

- [32] C. de Castro and I. Capellán-Pérez, 'Standard, Point of Use, and Extended Energy Return on Energy Invested (EROI) from Comprehensive Material Requirements of Present Global Wind, Solar, and Hydro Power Technologies', *Energies*, vol. 13, no. 12, Art. no. 12, Jan. 2020, doi: 10.3390/en13123036.
- [33] I. Capellán-Pérez, C. de Castro, and L. J. Miguel González, 'Dynamic Energy Return on Energy Investment (EROI) and material requirements in scenarios of global transition to renewable energies', *Energy Strategy Rev.*, vol. 26, p. 100399, Nov. 2019, doi: 10.1016/j.esr.2019.100399.
- [34] International Organization for Standardization, 'Environmental management — Life cycle assessment — Principles and framework (ISO 14040:2006)', *Environmental management — Life cycle assessment — Principles and framework*, 2006. <https://www.iso.org/cms/render/live/en/sites/isoorg/contents/data/standard/03/74/37456.html> (accessed Apr. 01, 2022).
- [35] M. Dale and S. M. Benson, 'Energy Balance of the Global Photovoltaic (PV) Industry - Is the PV Industry a Net Electricity Producer?', *Environ. Sci. Technol.*, vol. 47, no. 7, pp. 3482–3489, Apr. 2013, doi: 10.1021/es3038824.
- [36] M. Carbajales-Dale, 'When is EROI Not EROI?', *Biophys. Econ. Resour. Qual.*, vol. 4, no. 4, p. 16, Dec. 2019, doi: 10.1007/s41247-019-0065-8.
- [37] C. W. King, J. P. Maxwell, and A. Donovan, 'Comparing World Economic and Net Energy Metrics, Part 1: Single Technology and Commodity Perspective', *Energies*, vol. 8, no. 11, Art. no. 11, Nov. 2015, doi: 10.3390/en81112346.
- [38] S. Philipps and W. Warmuth, 'Photovoltaics Report', Fraunhofer ISE, Feb. 2022. Accessed: Apr. 04, 2022. [Online]. Available: <https://www.ise.fraunhofer.de/en/publications/studies/photovoltaics-report.html>
- [39] C. W. King and C. A. S. Hall, 'Relating Financial and Energy Return on Investment', *Sustainability*, vol. 3, no. 10, Art. no. 10, Oct. 2011, doi: 10.3390/su3101810.
- [40] C. W. King, J. P. Maxwell, and A. Donovan, 'Comparing World Economic and Net Energy Metrics, Part 2: Total Economy Expenditure Perspective', *Energies*, vol. 8, no. 11, Art. no. 11, Nov. 2015, doi: 10.3390/en81112347.
- [41] V. Court and F. Fizaine, 'Long-Term Estimates of the Energy-Return-on-Investment (EROI) of Coal, Oil, and Gas Global Productions', *Ecol. Econ.*, vol. 138, pp. 145–159, Aug. 2017, doi: 10.1016/j.ecolecon.2017.03.015.
- [42] L. Delannoy, P.-Y. Longaretti, D. J. Murphy, and E. Prados, 'Peak oil and the low-carbon energy transition: A net-energy perspective', *Appl. Energy*, vol. 304, p. 117843, Dec. 2021, doi: 10.1016/j.apenergy.2021.117843.
- [43] C. McGlade and P. Ekins, 'The geographical distribution of fossil fuels unused when limiting global warming to 2 °C', *Nature*, vol. 517, no. 7533, Art. no. 7533, Jan. 2015, doi: 10.1038/nature14016.
- [44] Fizaine and Court, 'Energy expenditure, economic growth, and the minimum EROI of society', *Energy Policy*, vol. 95, pp. 172–186, Aug. 2016, doi: 10.1016/j.enpol.2016.04.039.
- [45] J. D. Hamilton, 'Historical oil shocks', in *Routledge Handbook of Major Events in Economic History*, Routledge, 2013.
- [46] L. I. Brand-Correa, P. E. Brockway, C. L. Copeland, T. J. Foxon, A. Owen, and P. G. Taylor, 'Developing an Input-Output Based Method to Estimate a National-Level Energy Return on Investment (EROI)', *Energies*, vol. 10, no. 4, Art. no. 4, Apr. 2017, doi: 10.3390/en10040534.
- [47] C. A. S. Hall, 'The History, Future, and Implications of EROI for Society', in *Energy Return on Investment: A Unifying Principle for Biology, Economics, and Sustainability*, C. A. S. Hall, Ed. Cham: Springer International Publishing, 2017, pp. 145–169. doi: 10.1007/978-3-319-47821-0_12.
- [48] M. Carbajales-Dale, M. Raugei, V. Fthenakis, and C. Barnhart, 'Energy Return on Investment (EROI) of Solar PV: An Attempt at Reconciliation [Point of View]', *Proc. IEEE*, vol. 103, no. 7, pp. 995–999, Jul. 2015, doi: 10.1109/JPROC.2015.2438471.
- [49] D. Weißbach, G. Ruprecht, A. Huke, K. Czerski, S. Gottlieb, and A. Hussein, 'Energy intensities, EROIs (energy returned on invested), and energy payback times of electricity generating power plants', *Energy*, vol. 52, pp. 210–221, Apr. 2013, doi: 10.1016/j.energy.2013.01.029.
- [50] IEA, 'Methodological Guidelines on Net Energy Analysis of Photovoltaic Electricity, 2nd Ed.', *International Energy Agency, Photovoltaic Power Systems Programme*. <https://iea-pvps.org/key-topics/methodological-guidelines-on-net-energy-analysis-of-photovoltaic-electricity-2nd-edition/> (accessed Apr. 12, 2022).
- [51] K. Mulder and N. J. Hagens, 'Energy Return on Investment: Toward a Consistent Framework', *AMBIO J. Hum. Environ.*, vol. 37, no. 2, pp. 74–79, Mar. 2008, doi: 10.1579/0044-7447(2008)37[74:EROITA]2.0.CO;2.
- [52] C. A. S. Hall, 'Methods and Critiques for EROI Applied to Modern Fuels', in *Energy Return on Investment: A Unifying Principle for Biology, Economics, and Sustainability*, C. A. S. Hall, Ed. Cham: Springer International Publishing, 2017, pp. 119–143. doi: 10.1007/978-3-319-47821-0_11.
- [53] J. Feng, L. Feng, J. Wang, and C. W. King, 'Modeling the point of use EROI and its implications for economic growth in China', *Energy*, vol. 144, pp. 232–242, Feb. 2018, doi: 10.1016/j.energy.2017.11.061.
- [54] A. R. Brandt, 'Oil Depletion and the Energy Efficiency of Oil Production: The Case of California', *Sustainability*, vol. 3, no. 10, Art. no. 10, Oct. 2011, doi: 10.3390/su3101833.
- [55] M. Raugei and E. Leccisi, 'A comprehensive assessment of the energy performance of the full range of electricity generation technologies deployed

- in the United Kingdom', *Energy Policy*, vol. 90, pp. 46–59, Mar. 2016, doi: 10.1016/j.enpol.2015.12.011.
- [56] H. A. Aguirre-Villegas and C. H. Benson, 'Case history of environmental impacts of an Indonesian coal supply chain', *J. Clean. Prod.*, vol. 157, pp. 47–56, Jul. 2017, doi: 10.1016/j.jclepro.2017.03.232.
- [57] M. Raugei, E. Leccisi, V. Fthenakis, R. Escobar Moragas, and Y. Simsek, 'Net energy analysis and life cycle energy assessment of electricity supply in Chile: Present status and future scenarios', *Energy*, vol. 162, pp. 659–668, Nov. 2018, doi: 10.1016/j.energy.2018.08.051.
- [58] M. C. Guilford, C. A. S. Hall, P. O'Connor, and C. J. Cleveland, 'A New Long Term Assessment of Energy Return on Investment (EROI) for U.S. Oil and Gas Discovery and Production', *Sustainability*, vol. 3, no. 10, Art. no. 10, Oct. 2011, doi: 10.3390/su3101866.
- [59] O. Ellabban, H. Abu-Rub, and F. Blaabjerg, 'Renewable energy resources: Current status, future prospects and their enabling technology', *Renew. Sustain. Energy Rev.*, vol. 39, pp. 748–764, Nov. 2014, doi: 10.1016/j.rser.2014.07.113.
- [60] IEA, 'World Energy Outlook 2021', IEA, Paris, 2021. [Online]. Available: <https://www.iea.org/reports/world-energy-outlook-2021>
- [61] B. Steffen, D. Hischier, and T. S. Schmidt, 'Historical and projected improvements in net energy performance of power generation technologies', *Energy Environ. Sci.*, vol. 11, no. 12, pp. 3524–3530, Dec. 2018, doi: 10.1039/C8EE01231H.
- [62] M. Diesendorf and T. Wiedmann, 'Implications of Trends in Energy Return on Energy Invested (EROI) for Transitioning to Renewable Electricity', *Ecol. Econ.*, vol. 176, p. 106726, Oct. 2020, doi: 10.1016/j.ecolecon.2020.106726.
- [63] C. Ballif, F.-J. Haug, M. Boccard, P. J. Verlinden, and G. Hahn, 'Status and perspectives of crystalline silicon photovoltaics in research and industry', *Nat. Rev. Mater.*, pp. 1–20, Mar. 2022, doi: 10.1038/s41578-022-00423-2.
- [64] I. Kubiszewski, C. J. Cleveland, and P. K. Endres, 'Meta-analysis of net energy return for wind power systems', *Renew. Energy*, vol. 35, no. 1, pp. 218–225, Jan. 2010, doi: 10.1016/j.renene.2009.01.012.
- [65] W. F. Pickard, 'Energy return on energy invested (eroi): a quintessential but possibly inadequate metric for sustainability in a solar-powered world? [point of view]', *Proc. IEEE*, vol. 102, no. 8, pp. 1118–1122, Aug. 2014, doi: 10.1109/JPROC.2014.2332092.
- [66] M. Carbajales-Dale, C. J. Barnhart, and S. M. Benson, 'Can we afford storage? A dynamic net energy analysis of renewable electricity generation supported by energy storage', *Energy Environ. Sci.*, vol. 7, no. 5, pp. 1538–1544, Apr. 2014, doi: 10.1039/C3EE42125B.
- [67] S. Sgouridis, M. Carbajales-Dale, D. Csala, M. Chiesa, and U. Bardi, 'Comparative net energy analysis of renewable electricity and carbon capture and storage', *Nat. Energy*, vol. 4, no. 6, Art. no. 6, Jun. 2019, doi: 10.1038/s41560-019-0365-7.
- [68] F. Fizaine and V. Court, 'Renewable electricity producing technologies and metal depletion: A sensitivity analysis using the EROI', *Ecol. Econ.*, vol. 110, pp. 106–118, Feb. 2015, doi: 10.1016/j.ecolecon.2014.12.001.
- [69] J. H. M. Harmsen, A. L. Roes, and M. K. Patel, 'The impact of copper scarcity on the efficiency of 2050 global renewable energy scenarios', *Energy*, vol. 50, pp. 62–73, Feb. 2013, doi: 10.1016/j.energy.2012.12.006.
- [70] S. M. Jowitt, G. M. Mudd, and J. F. H. Thompson, 'Future availability of non-renewable metal resources and the influence of environmental, social, and governance conflicts on metal production', *Commun. Earth Environ.*, vol. 1, no. 1, Art. no. 1, Sep. 2020, doi: 10.1038/s43247-020-0011-0.
- [71] For full list of authors, see publisher's website., J. Lee, K. Awuah-Offei, and M. Moats, 'Reviewing the Material and Metal Security of Low-Carbon Energy Transitions', *Renew. Sustain. Energy Rev.*, vol. 124, May 2020, doi: 10.1016/j.rser.2020.109789.
- [72] F. De Rochette and G. De Temmerman, 'Fluxes, not stocks: The real challenges of metallic resources for the energy transition', Zenon Research, Paris, France, 2022. [Online]. Available: <https://www.zenon.ngo/report/fluxes-not-stocks-the-real-challenges-of-metallic-resources-for-the-energy-transition>
- [73] E. Dupont, R. Koppelaar, and H. Jeanmart, 'Global available solar energy under physical and energy return on investment constraints', *Appl. Energy*, vol. 257, p. 113968, Jan. 2020, doi: 10.1016/j.apenergy.2019.113968.
- [74] A. Fabre, 'Evolution of EROIs of electricity until 2050: Estimation and implications on prices', *Ecol. Econ.*, vol. 164, p. 106351, Oct. 2019, doi: 10.1016/j.ecolecon.2019.06.006.
- [75] M. Raugei, P. Fullana-i-Palmer, and V. Fthenakis, 'The energy return on energy investment (EROI) of photovoltaics: Methodology and comparisons with fossil fuel life cycles', *Energy Policy*, vol. 45, no. C, pp. 576–582, 2012.
- [76] J.-F. Fagnart, M. Germain, and B. Peeters, 'Can the Energy Transition Be Smooth? A General Equilibrium Approach to the EROEI', *Sustainability*, vol. 12, no. 3, Art. no. 3, Jan. 2020, doi: 10.3390/su12031176.
- [77] M. Carbajales-Dale, C. J. Barnhart, A. R. Brandt, and S. M. Benson, 'A better currency for investing in a sustainable future', *Nat. Clim. Change*, vol. 4, no. 7, Art. no. 7, Jul. 2014, doi: 10.1038/nclimate2285.