



**HAL**  
open science

## **NMR methods and devices for the characterization of flows and transfers in milli-channels**

Feryal Guerroudj, Laouès Guendouz, Jean-Marc Commenge, Rainier Hreiz, N. Louvet, Jérémy Bianchin, Jean-Christophe Perrin

### ► **To cite this version:**

Feryal Guerroudj, Laouès Guendouz, Jean-Marc Commenge, Rainier Hreiz, N. Louvet, et al.. NMR methods and devices for the characterization of flows and transfers in milli-channels. European Conference on Magnetic Resonance (EUROMAR 2022), Jul 2022, Utrecht, Netherlands. <hal-03774601>

**HAL Id: hal-03774601**

**<https://hal.science/hal-03774601v1>**

Submitted on 12 Sep 2022

**HAL** is a multi-disciplinary open access archive for the deposit and dissemination of scientific research documents, whether they are published or not. The documents may come from teaching and research institutions in France or abroad, or from public or private research centers.

L'archive ouverte pluridisciplinaire **HAL**, est destinée au dépôt et à la diffusion de documents scientifiques de niveau recherche, publiés ou non, émanant des établissements d'enseignement et de recherche français ou étrangers, des laboratoires publics ou privés.



HAL Authorization

# NMR methods and devices for the characterization of flows and transfers in milli-channels

F. Guerroudj<sup>\*1</sup>, L. Guendouz<sup>1</sup>, J. M. Commenge<sup>2</sup>, R. Hreiz<sup>2</sup>, N. Louvet<sup>1</sup>, J. Bianchin<sup>1</sup> and J.-C. Perrin<sup>1</sup>

<sup>1</sup> Université de Lorraine, CNRS, LEMTA, F-54000 Nancy, France

<sup>2</sup> Université de Lorraine, CNRS, Lab React & Genie Proc, F-54000 Nancy, France

\* [feryal.guerroudj@univ-lorraine.fr](mailto:feryal.guerroudj@univ-lorraine.fr)



## 1. Introduction

- Milli-fluidics is the technology of flows in channels with characteristic dimensions of a few hundred microns
- Reducing the dimensions of the systems affects the equilibrium of the forces and generates a specific behavior of the flow<sup>1</sup>
- Milli-fluidic systems are implemented in different fields such as synthesis chemistry, biology or process engineering<sup>2</sup>
- The geometrical complexity of the systems induces a limits the use of optical characterization methods
- NMR methods are adapted to such systems (geometries and materials)<sup>3</sup> provided that the measurement sensitivity is improved<sup>4,5</sup>

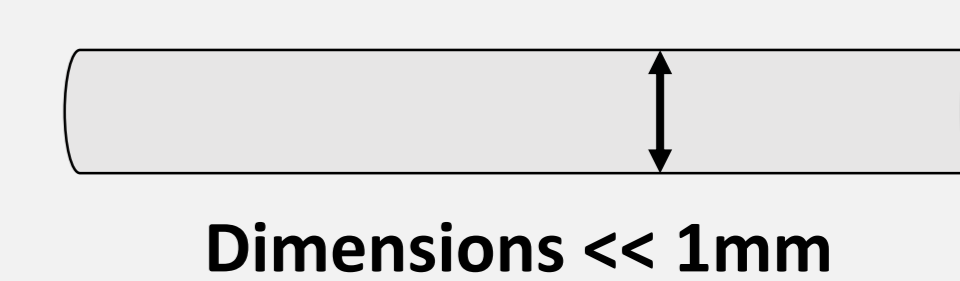

➤ **Approach: development of radiofrequency (RF) milli-coils<sup>6</sup> for emission and reception of the NMR signal**

**In this study**

- We developed adapted methods for the characterization of flows in milli-fluidic systems by NMR/MRI
  - Increase the sensitivity by developing RF coils
  - Optimize imaging parameters
- We applied these methods in two study cases:
  - Characterize the hydrodynamics in micro-mixer
  - Visualize a biofilm development in a capillary

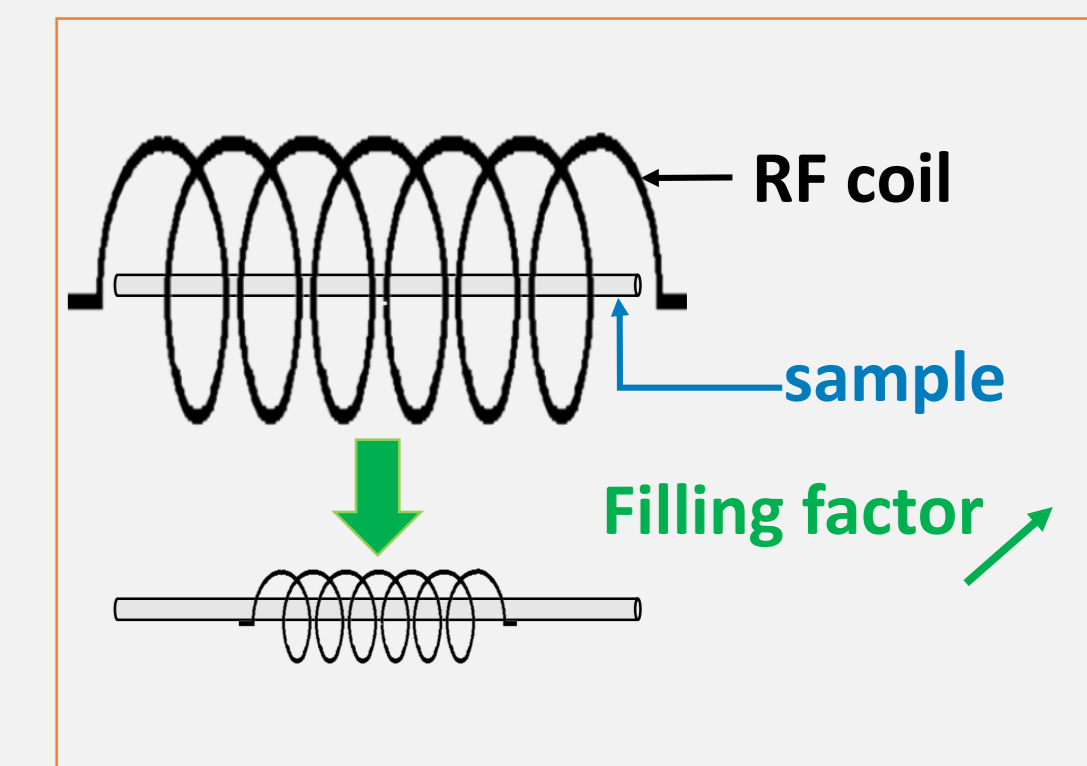

## 2. Materials and methods

### • Fabrication of RF milli-coils

Etching on DuPont™ Pyralux® AC substrate

Chosen geometry for application 3.a

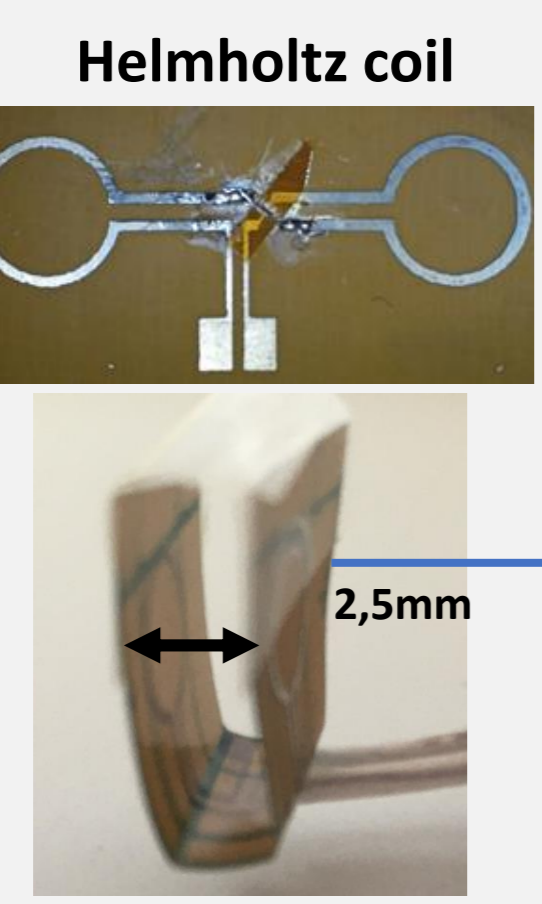
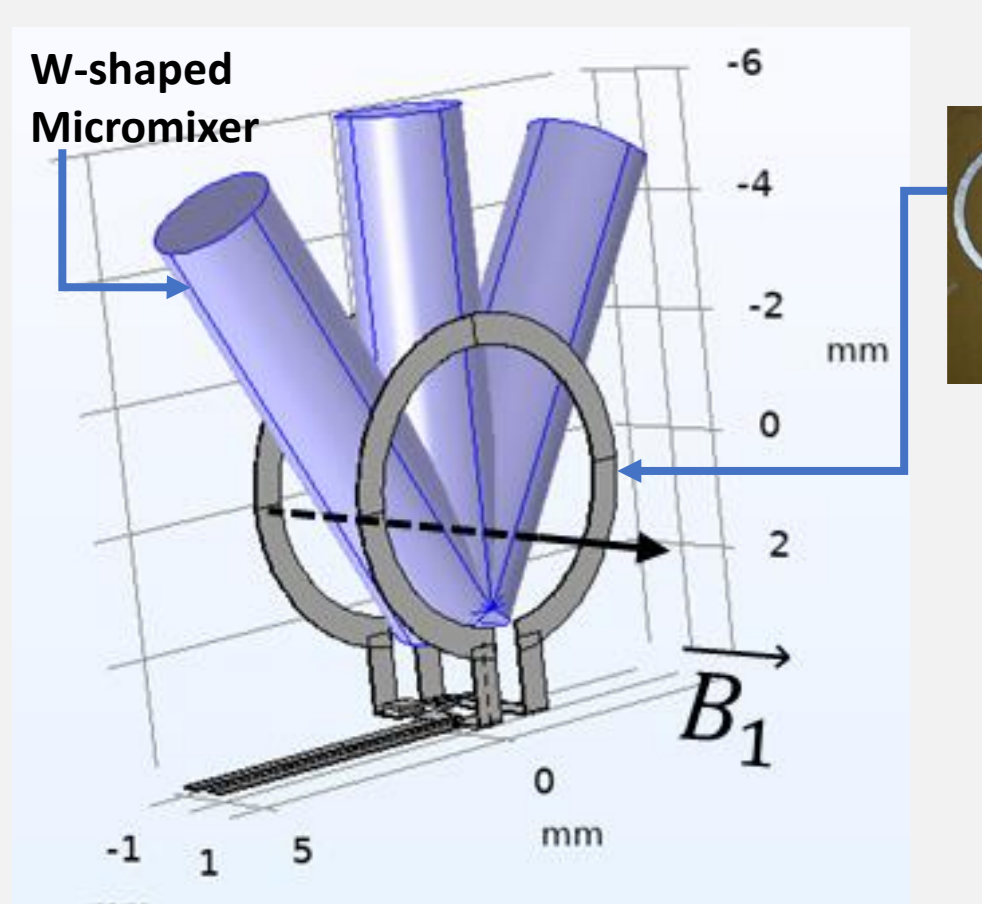

Electronics: tuning and matching

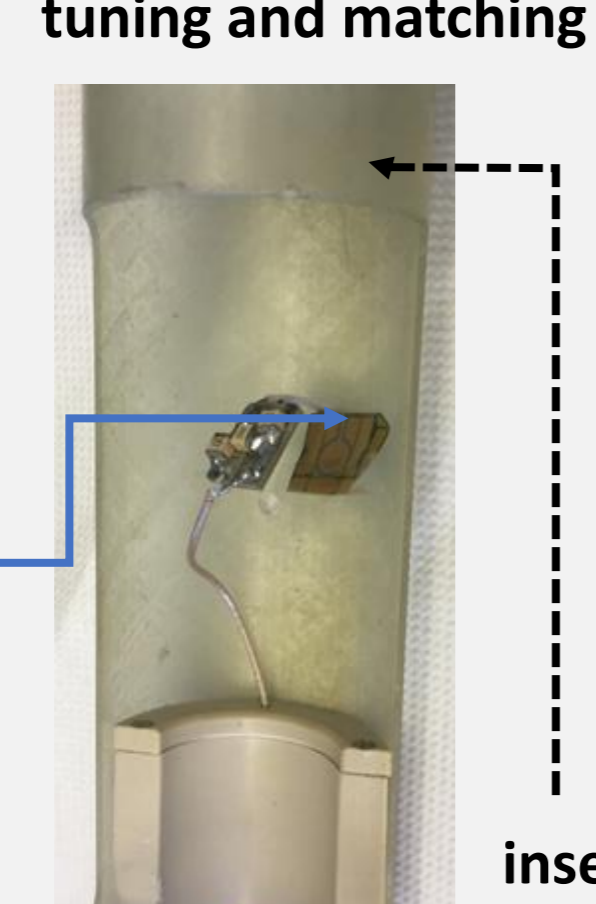

Chosen geometry for application 3.b

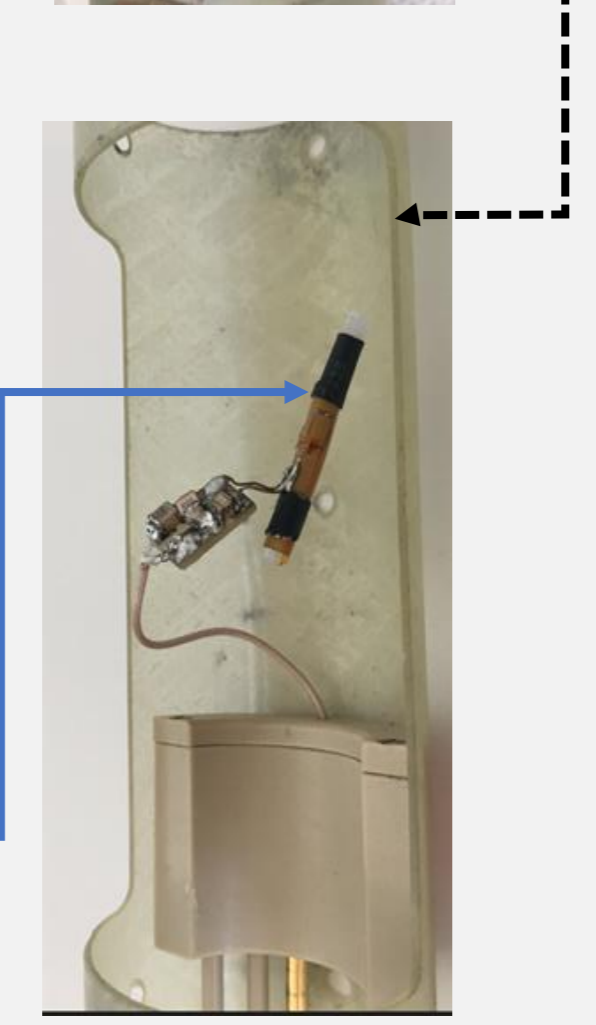
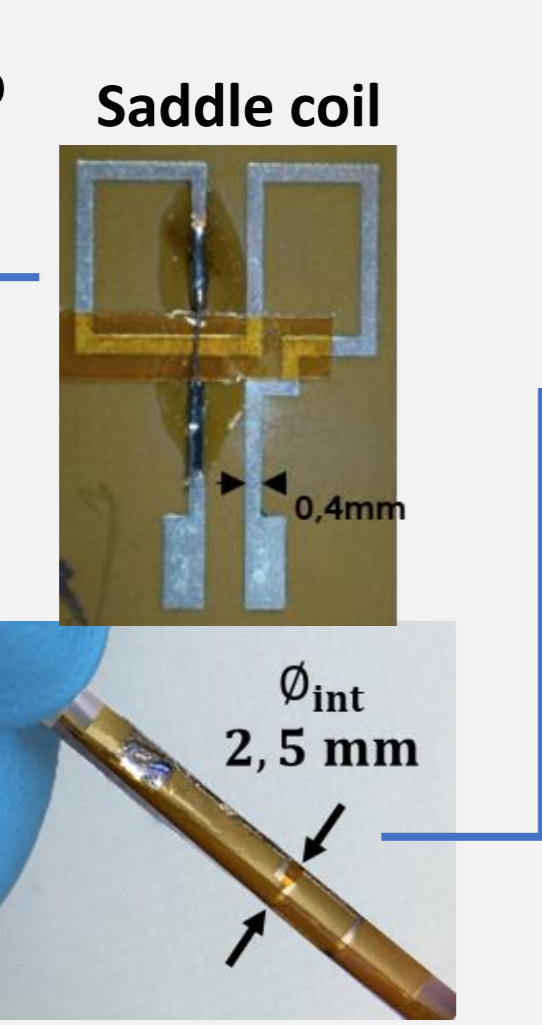
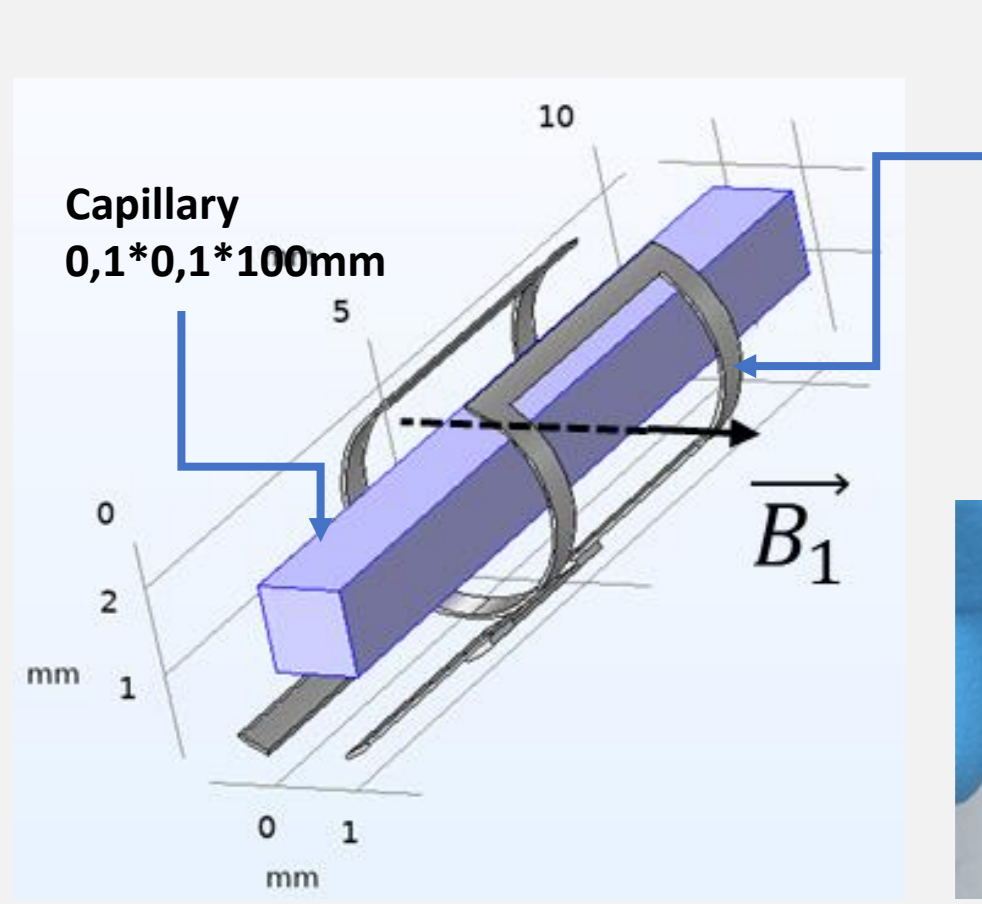

### • RF simulations on COMSOL Multiphysics®

Physics : Radiofrequency and electromagnetic wave  
Calculation: Mesh generated by the finite element method

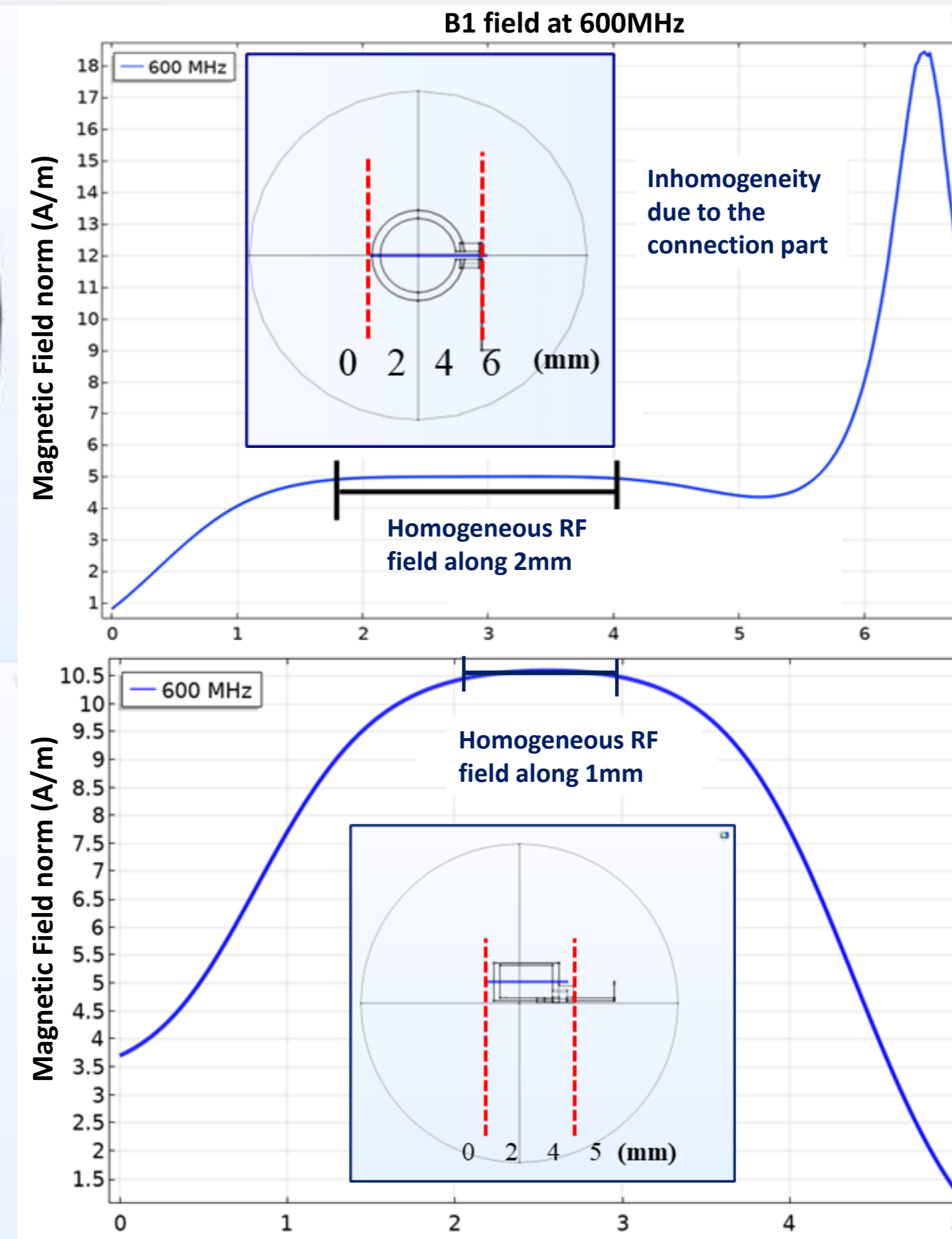
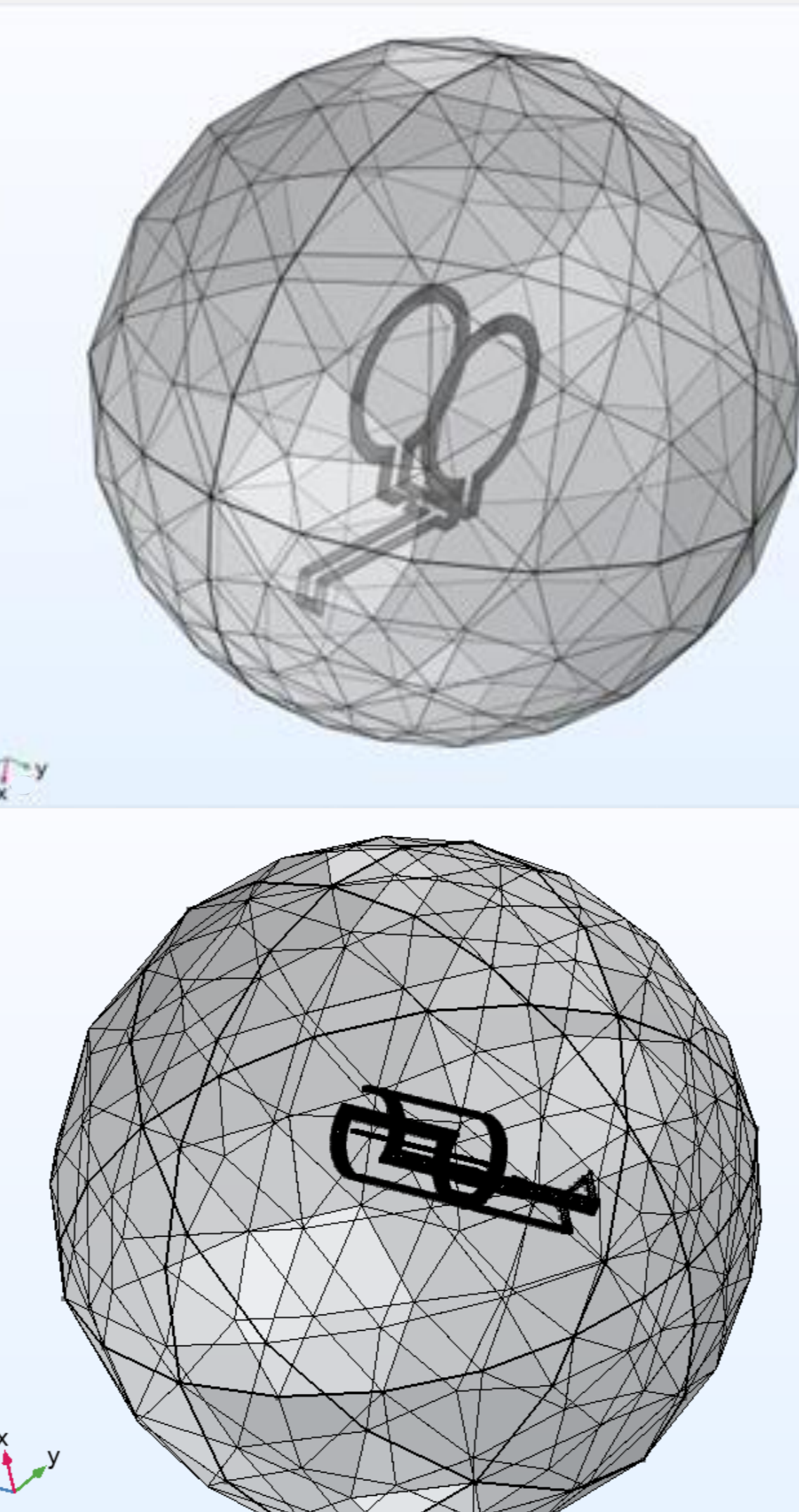

### • Qualification

Comparison measurements between a commercial probe (Bruker MicWB40 1H, 25mm ID) and the fabricated milli-coil



Sample: Capillary 0,9mm ID + CuSO<sub>4</sub> solution (T<sub>1</sub> = 100ms)

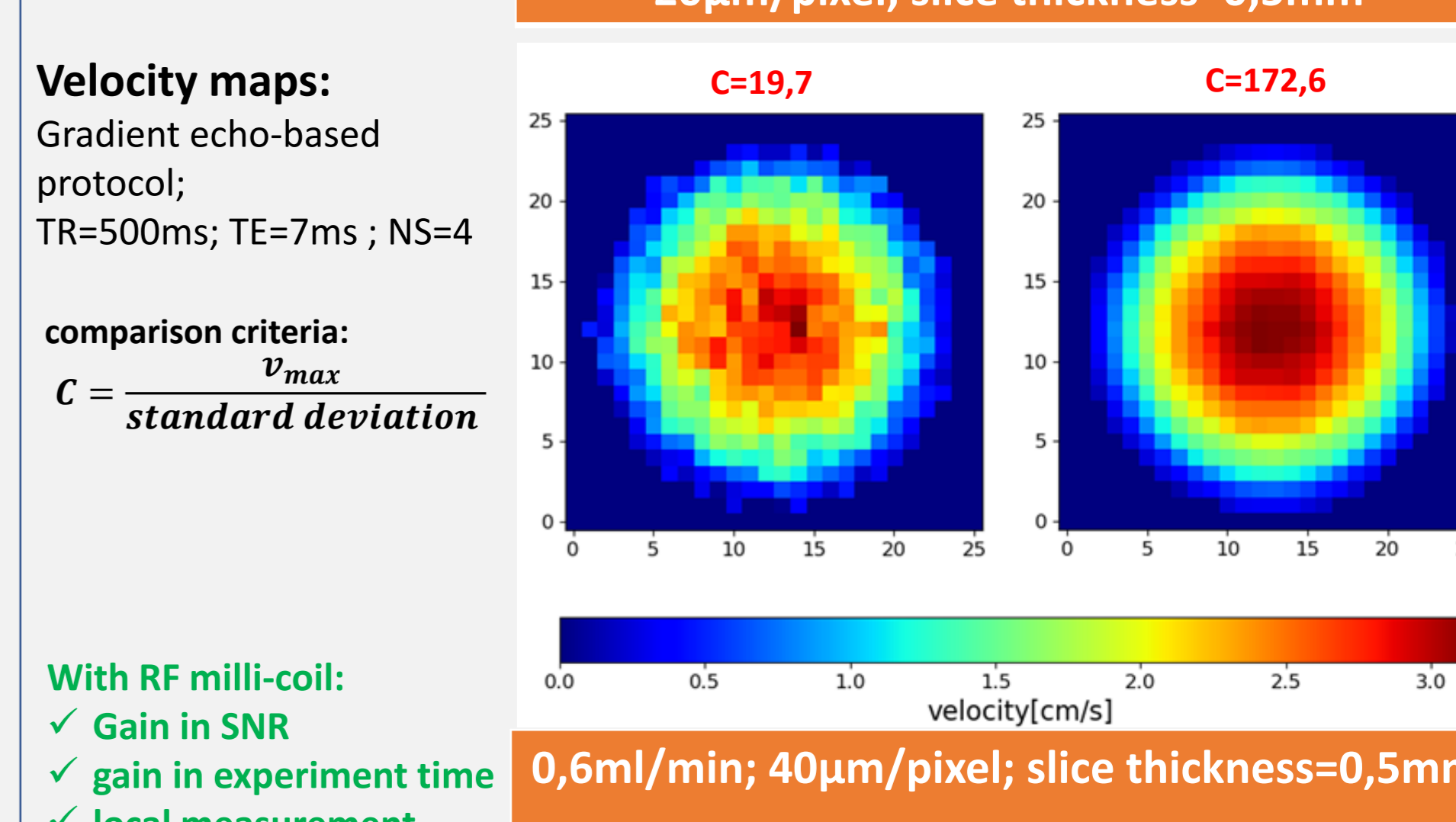
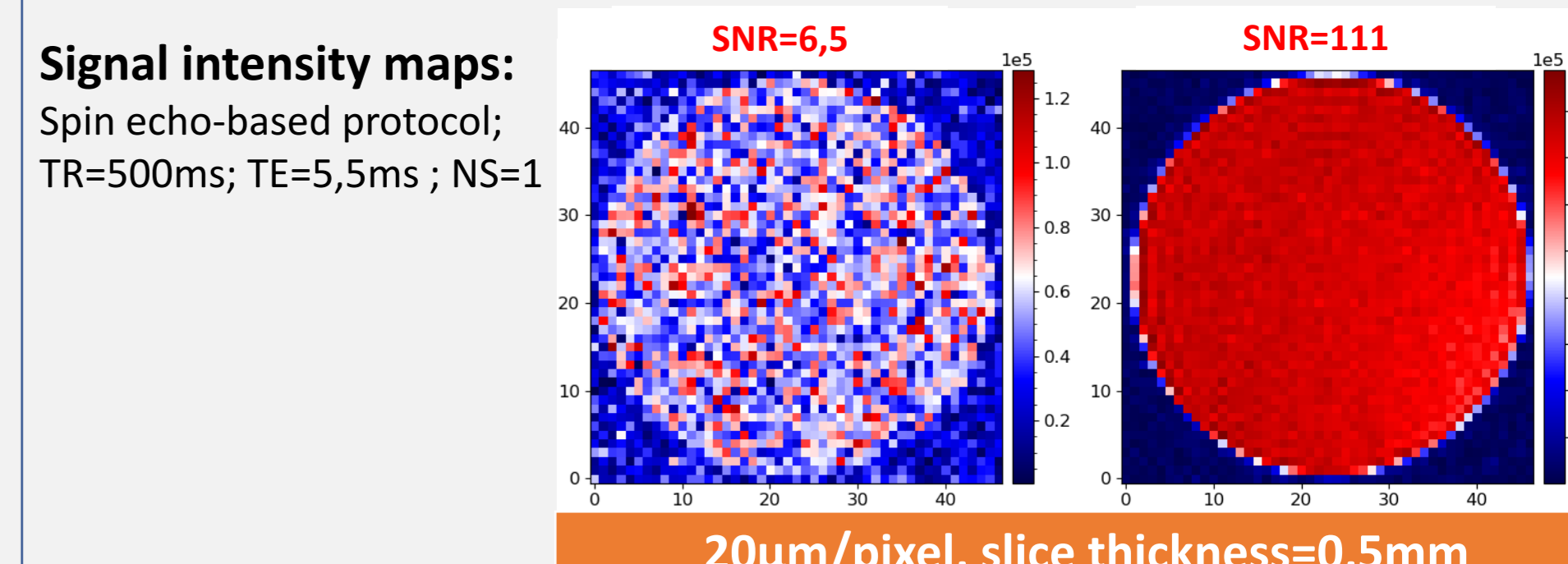

comparison criteria:  
 $C = \frac{v_{max}}{standard\ deviation}$

With RF milli-coil:  
✓ Gain in SNR  
✓ gain in experiment time  
✓ local measurement

## 3. Results

### a. MRI study of the hydrodynamics in micro-mixers

- Characterization of hydrodynamics instabilities in a W-shaped micromixer (Re per entry ~ 100 ) by a coupled approach :
  - ✓ MRI measurements
  - ✓ Numerical simulations<sup>7</sup> (CFD- Ansys Fluent)
- Comparison of the two approaches
- Validation of the numerical simulations

Fluid/entry	CuSO <sub>4</sub> solution (T <sub>1</sub> = 100ms)
Re/entry	60 to 170
Slice thickness	0,2mm
Resolution	24μm/pixel
MRI protocol	Gradient echo;; TE=5,5ms

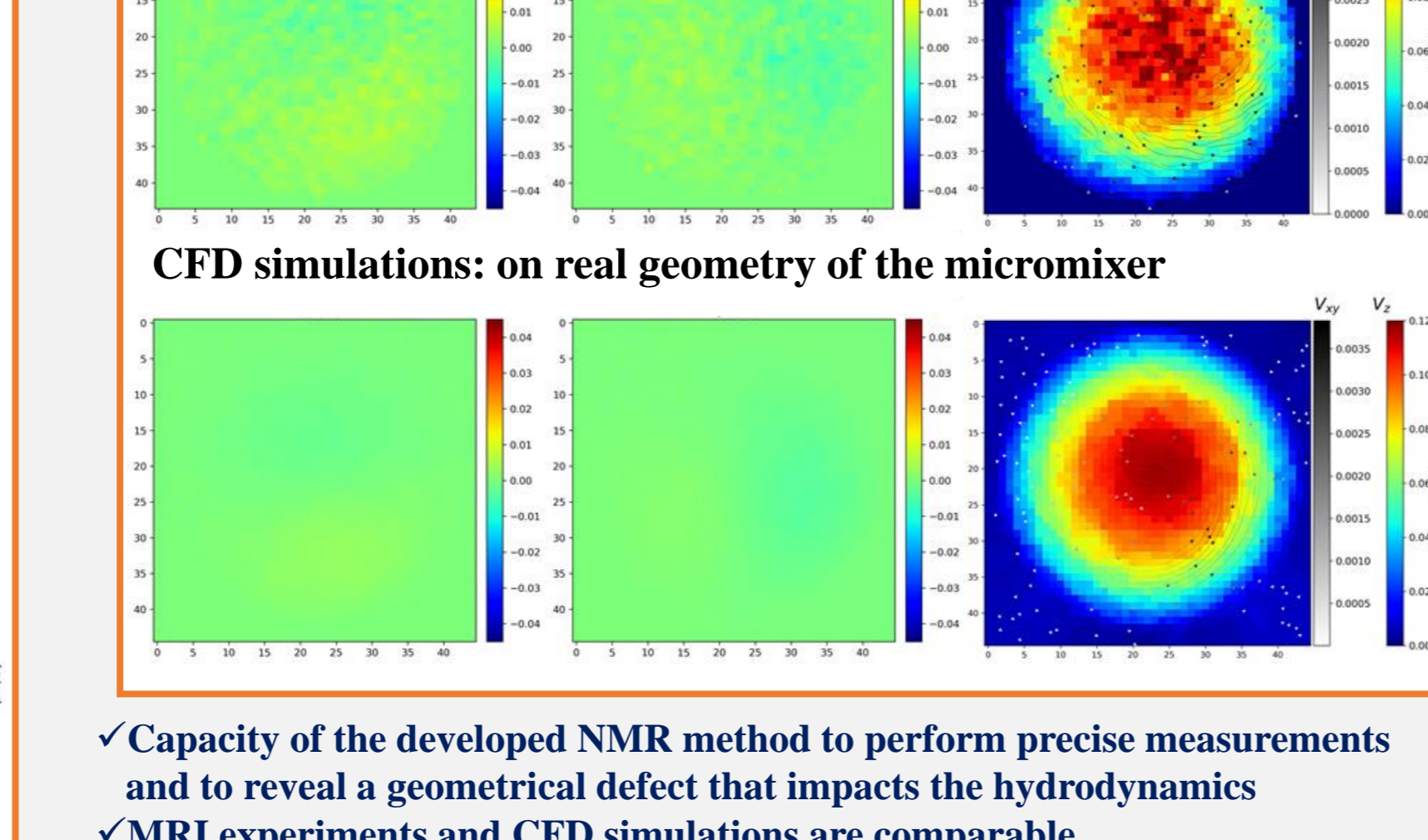
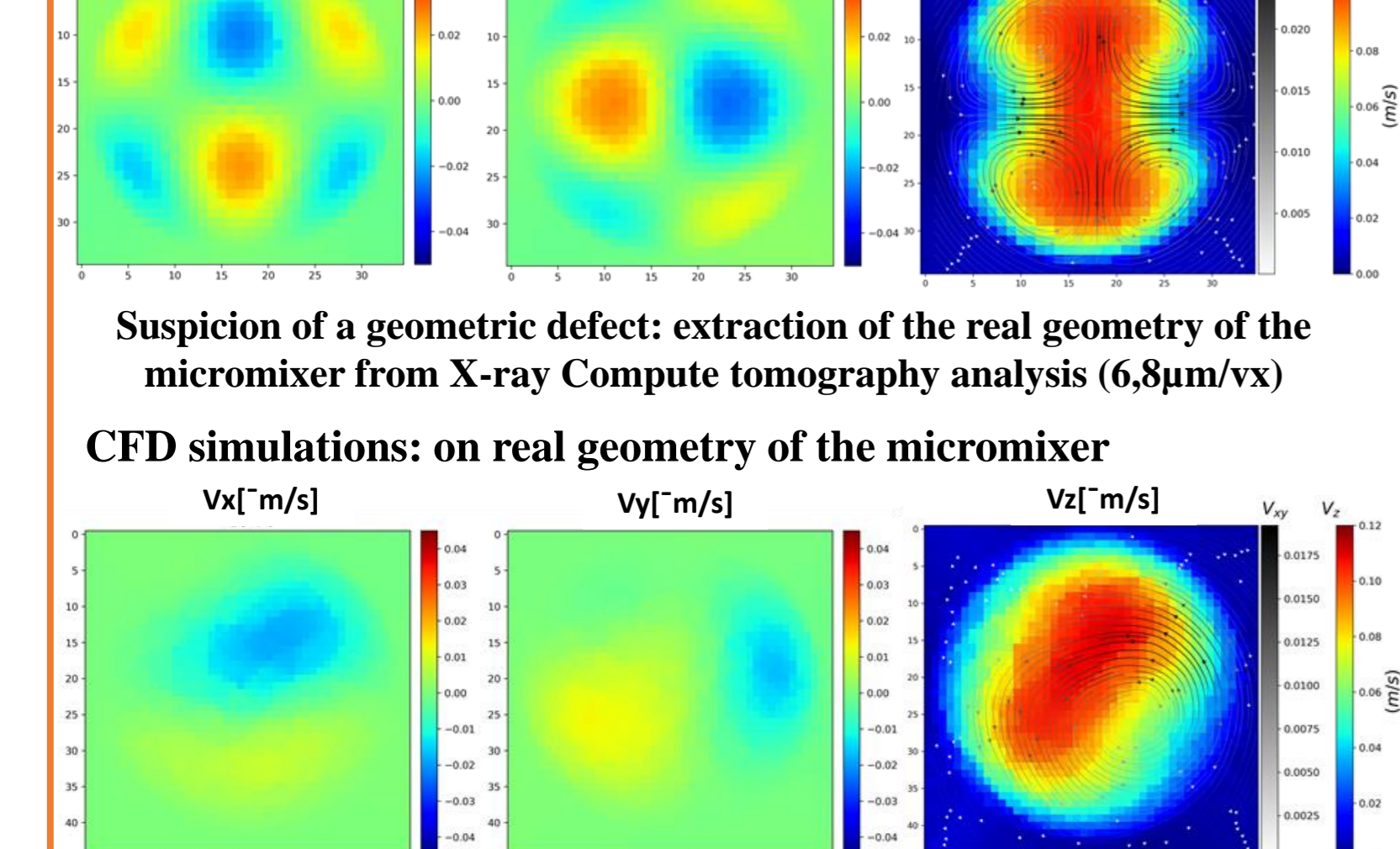
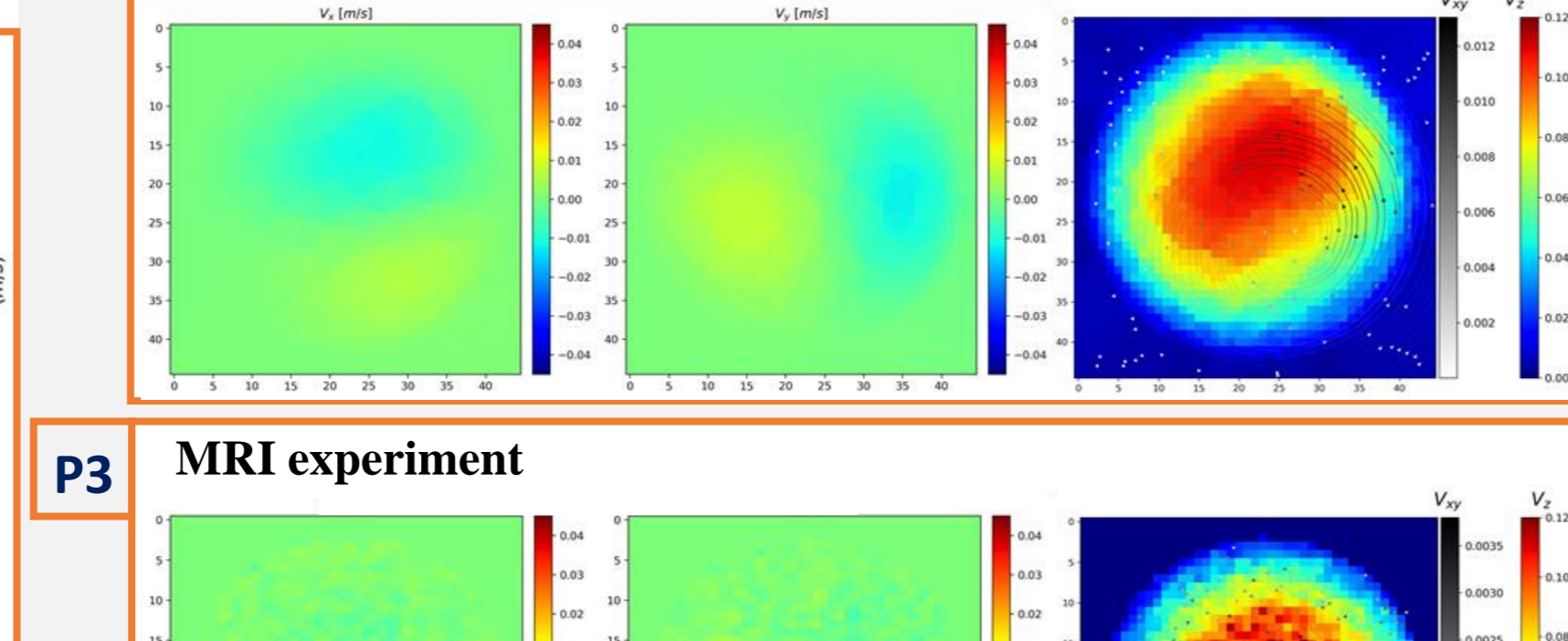
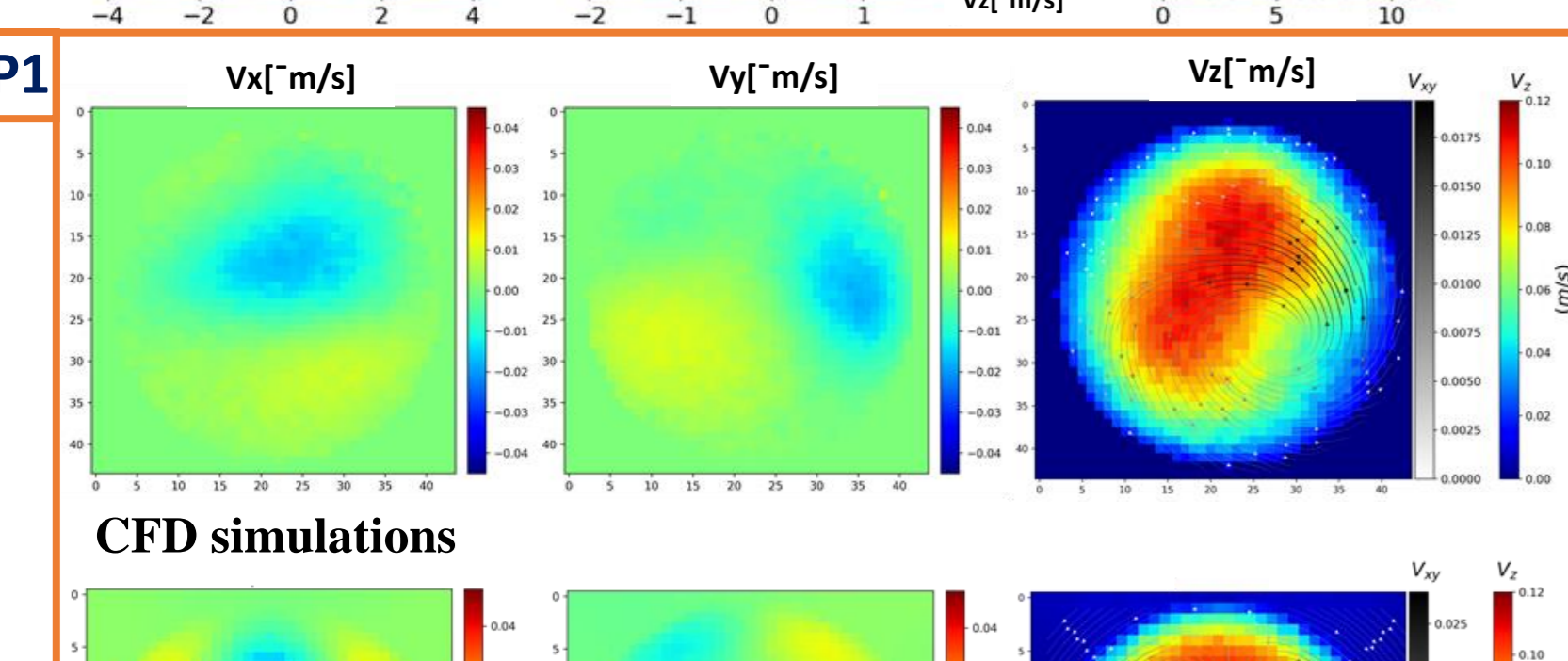
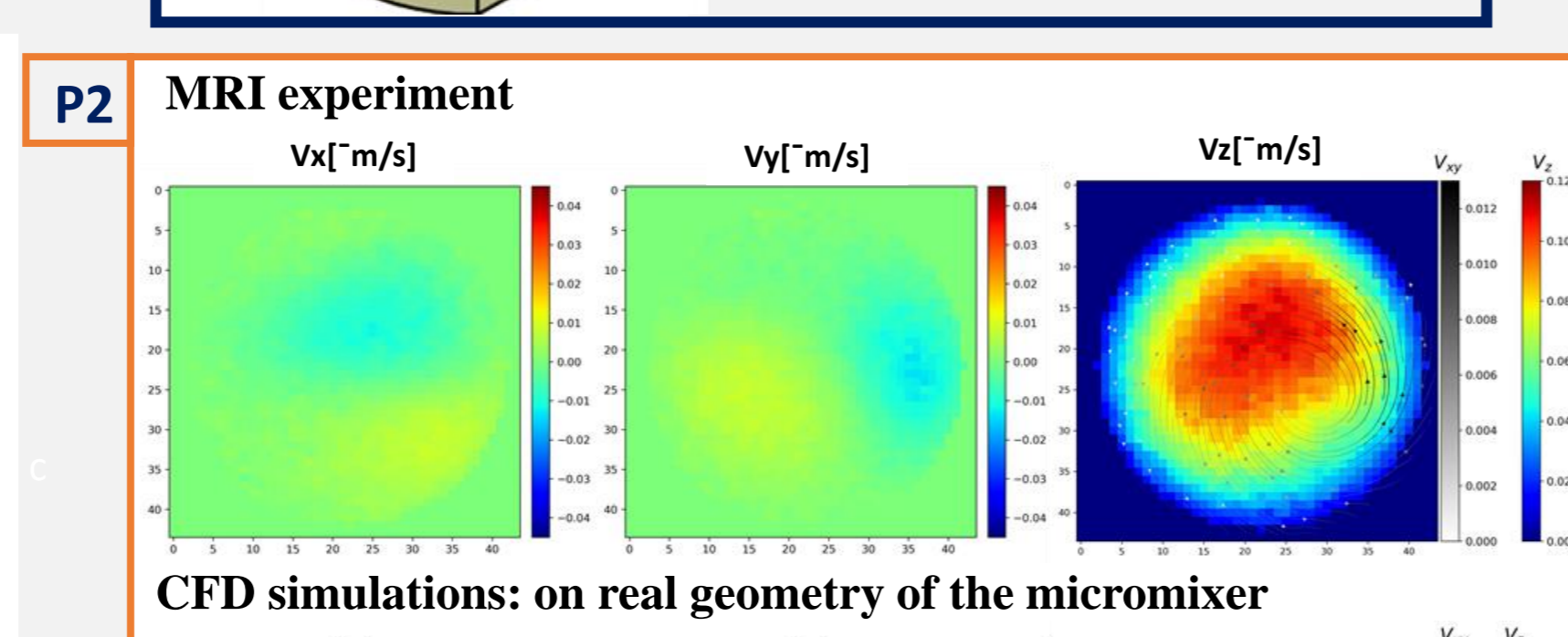
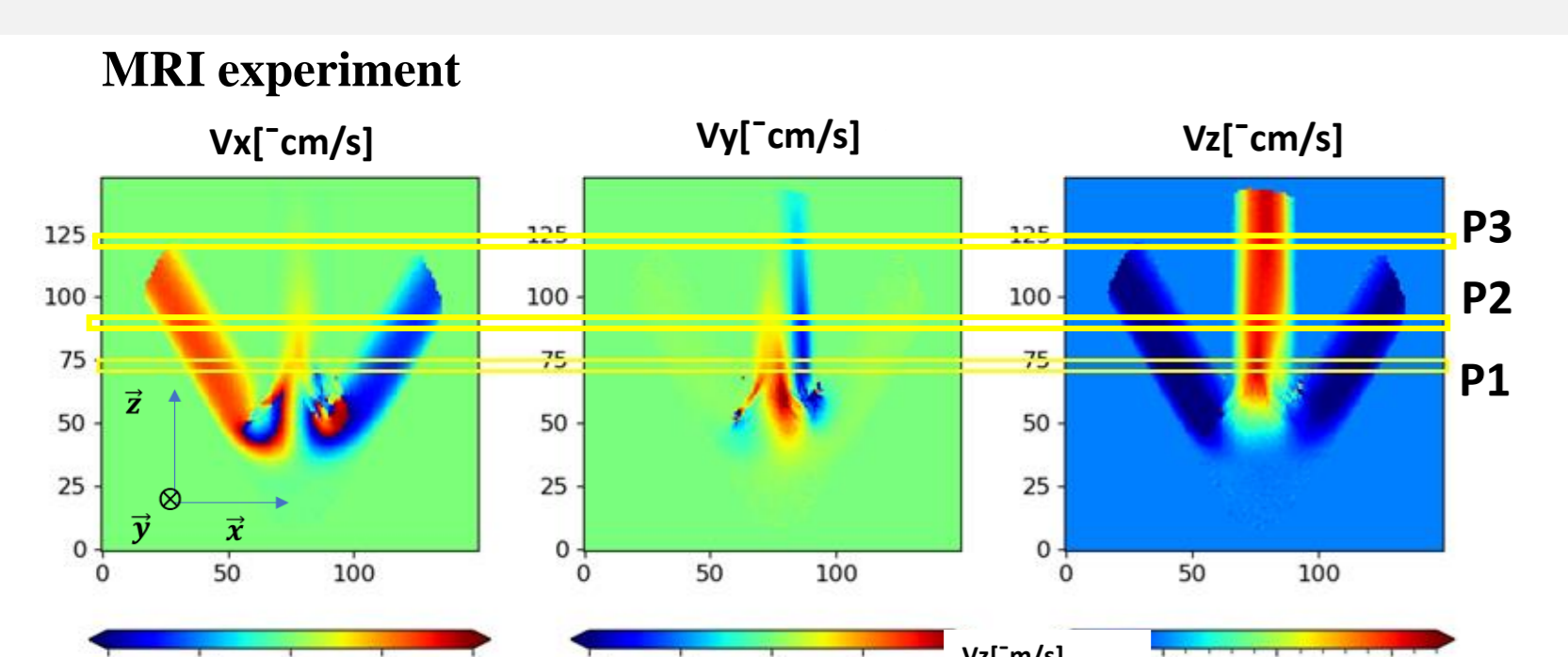

✓ Capacity of the developed NMR method to perform precise measurements and to reveal a geometrical defect that impacts the hydrodynamics  
✓ MRI experiments and CFD simulations are comparable

### b. MRI visualization of a biofilm development in a capillary

- perform a biofilm growth experiment in a capillary of submillimeter dimensions (pore model)
- MRI visualization of a biofilm and its impact on the hydrodynamics<sup>8,9</sup>

Protocol for biofilm culture:

- bacteria: shewanella oneidensis (soil model)
- adhesion stage: colonize the capillary with the bacterial culture during 4h at ambient temperature (flow 1.2ml/min, ; in closed-loop)
- biofilm culture stage: continuous feeding with nutrient solution (flow rate 1.2ml/min)

#### Longitudinal relaxation measurements

Spin echo; protocol RARE VTR; TE=10ms; 10 TR [100-10000ms]; RARE Factor=2; 2 averages; experiment time 40min

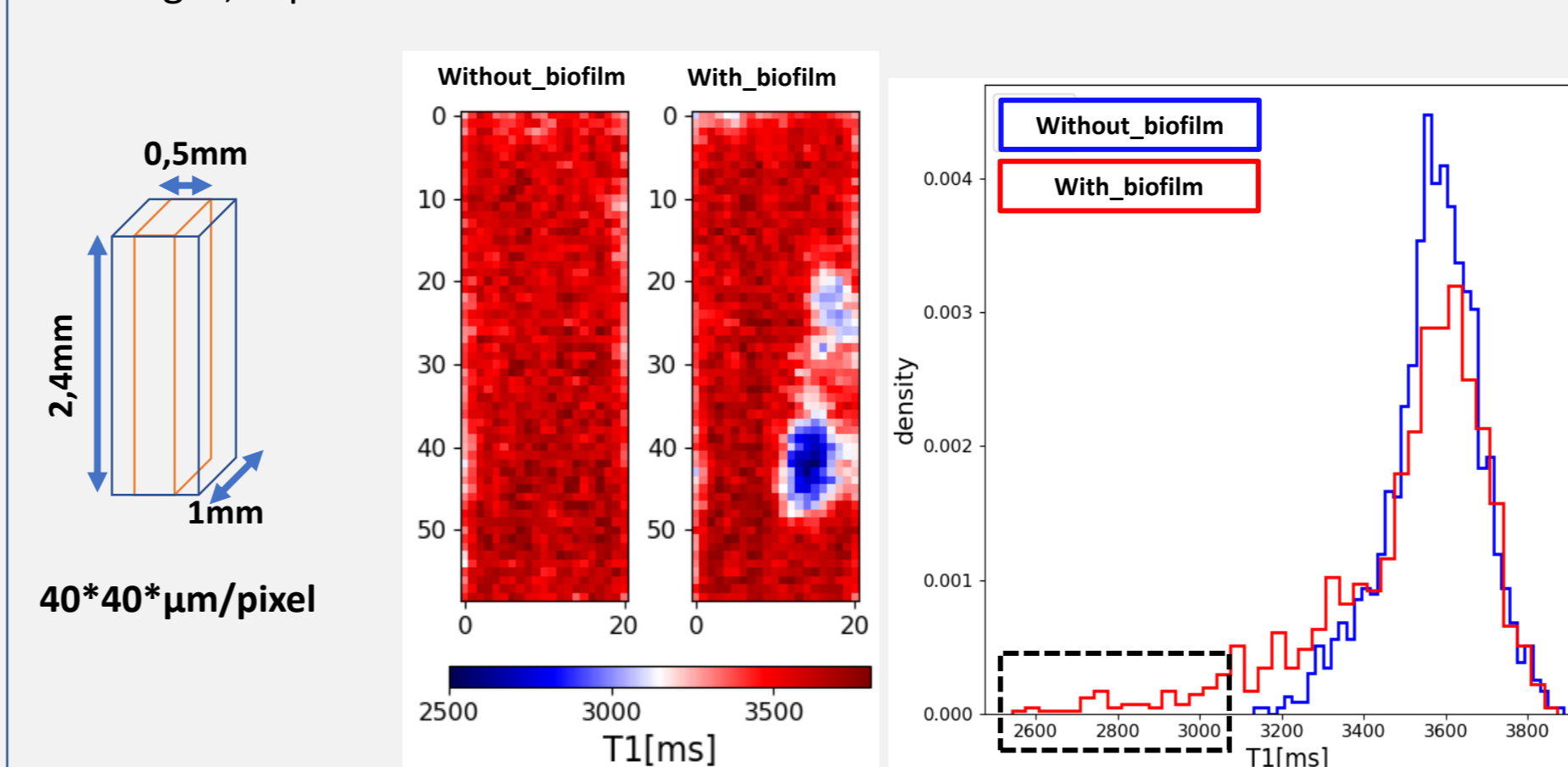

#### Velocity measurements

Gradient echo; TR=1000ms; TE=7ms; experiment time 6min

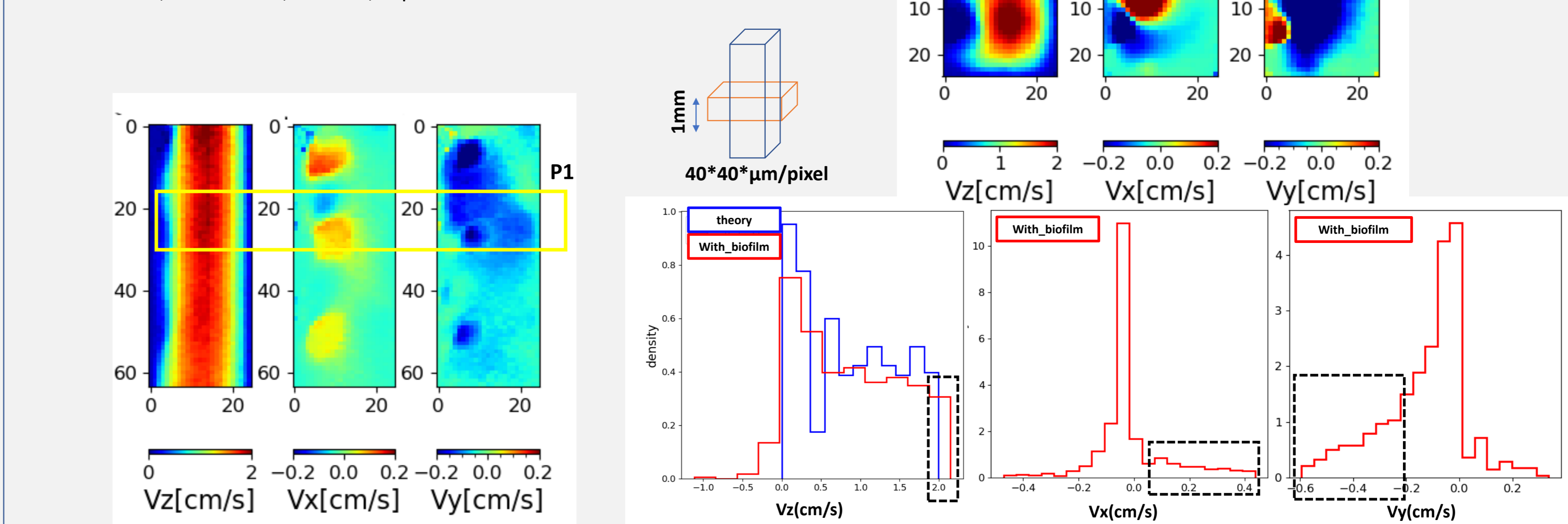

✓ Test of a biofilm growth experiment at the pore scale  
✓ Visualize by MRI a biofilm development and its impact on hydrodynamics

## 4. Conclusions

- We developed a MRI instrumentation and implemented milli-fluidic devices with simple, fast prototypes and low-cost materials
- We improved the signal to noise ratio by the development of RF milli-coils
- These methods perform precise measurements of milli-fluidic phenomena which allows the inspection of complex systems

(1) Chen, L.; Yang, C.; Xiao, Y.; Yan, X.; Hu, L.; Eggersdorfer, M.; Chen, D.; Weitz, D. A.; Ye, F. Millifluidics, Microfluidics, and Nanofluidics: Manipulating Fluids at Varying Length Scales. *Materials Today Nano* 2021, 16, 100136.  
(2) Miao, A.; Anderson, R. C., *Microsystem Technology in Chemistry and Life Science*; Springer: Berlin Heidelberg, 1998.  
(3) McDonnell, E. E.; Han, S.; Hilly, C.; Pierce, K. L.; Pines, A. NMR Analysis on Microfluidic Devices by Remote Detection. *Anal. Chem.* 2005, 77, 8109-8114.  
(4) Montinaro, E.; Grisi, M.; Letizia, M. C.; Pethö, L.; Gijjs, M. A. M.; Guidetti, R.; Michler, J.; Brugger, J.; Boero, G. 3D Printed Microchannels for Sub-NL NMR Spectroscopy. *PLoS ONE* 2018, 13 (5), e0192780.  
(5) Massin, C.; Vincent, F.; Homay, A.; Ehrmann, K.; Boero, G.; Besse, P.-A.; Daridon, A.; Verspoorte, E.; de Rooij, N. F.; Popovic, R. S. Planar Microcoil-Based Microfluidic NMR Probes. *Journal of Magnetic Resonance* 2003, 164 (2), 242-255.  
(6) Webb, A. G. Radiofrequency Microcoils for Magnetic Resonance Imaging and Spectroscopy. *Journal of Magnetic Resonance* 2013, 229, 55-66.  
(7) Engler, M.; Kockmann, N.; Kiefer, T.; Waiss, P. Numerical and Experimental Investigations on Liquid Mixing in Static Micromixers. *Chemical Engineering Journal* 2004, 101 (1-3), 315-322.  
(8) Herrling, M. P.; Lackner, S.; Nirschl, H.; Horn, H.; Guthausen, G. Recent NMR/MRI Studies of Biofilm Structures and Dynamics. In *Annual Reports on NMR Spectroscopy*; Elsevier, 2019; Vol. 97, pp 163-213.  
(9) Seymour, J. D.; Gage, J. P.; Codd, S. L.; Gerlach, R. Anomalous Fluid Transport in Porous Media Induced by Biofilm Growth. *Phys. Rev. Lett.* 2004, 93 (19), 198103.