



**HAL**  
open science

# Configuration of Guard Band and Offsets in Cyclic Queuing and Forwarding

Damien Guidolin–Pina, Marc Boyer, Jean-Yves Le Boudec

► **To cite this version:**

Damien Guidolin–Pina, Marc Boyer, Jean-Yves Le Boudec. Configuration of Guard Band and Offsets in Cyclic Queuing and Forwarding. *IEEE/ACM Transactions on Networking*, 2023, pp.1-10.1109/TNET.2023.3293050 . hal-03772877v2

**HAL Id: hal-03772877**

**<https://hal.science/hal-03772877v2>**

Submitted on 27 Jan 2023 (v2), last revised 21 Nov 2023 (v3)

**HAL** is a multi-disciplinary open access archive for the deposit and dissemination of scientific research documents, whether they are published or not. The documents may come from teaching and research institutions in France or abroad, or from public or private research centers.

L'archive ouverte pluridisciplinaire **HAL**, est destinée au dépôt et à la diffusion de documents scientifiques de niveau recherche, publiés ou non, émanant des établissements d'enseignement et de recherche français ou étrangers, des laboratoires publics ou privés.

# Configuration of Guard Band and Offsets in Cyclic Queuing and Forwarding

Damien Guidolin-Pina, *RealTime-at-Work*,  
Marc Boyer, *ONERA*,  
and Jean-Yves Le Boudec, *EPFL*

January 27, 2023

## Abstract

Cyclic Queuing and Forwarding (CQF) is a mechanism defined by IEEE TSN for providing low jitter in a deterministic network. CQF uses a common time cycle and two buffers per node output port: during one cycle incoming packets are stored in one buffer while packets in the other buffer are being transmitted; at the end of a cycle, the roles of the two buffers are exchanged. The cycle start times are determined by a time offset that may be different for every output buffer. A guard band at both cycle ends is devised in order to compensate for misalignment and timing inaccuracies. The proper operation of CQF requires that the guard band and the offsets are computed such that nodes are sufficiently time-aligned. First, we give necessary and sufficient conditions for this to be guaranteed. The sufficient conditions lend themselves to tractable computations and we show that they are close to optimal. Our conditions account for nonideal clocks and non-zero propagation times; we show that accounting for these two elements does matter. Second, we give a method for computing the minimal duration of the guard band, given prior choices of time offsets. Third, a judicious choice of time offsets can considerably decrease the required duration of the guard band: we give a practical algorithm, based on a Mixed Integer Linear Program, for computing offsets that minimize the guard band. We illustrate our results on several CQF network topologies with or without cyclic dependencies.

**Keywords**— TSN; CQF; Peristaltic Shaper; Cyclic Queuing and Forwarding.

## 1 Introduction

In order to offer a standard real-time data network, the IEEE Time Sensitive Networking working group has defined several extensions to Ethernet. Among others, Cyclic Queuing and Forwarding (CQF), previously known as “peristaltic shaper”, has been defined in order to offer guaranteed delay and limited jitter [1]. In short (see Section 2 for more details), CQF considers a common time cycle,  $T$ , and uses two queues per node output port to alternatively store or forward frames. It guarantees that the delay

experienced by a frame crossing  $h$  switches along its path is between  $(h - 1)T$  and  $(h + 1)T$ .

CQF has appealing characteristics: it is simple to implement, it offers a simple expression of the latency bound, it provides a limited delay jitter ( $2T$ ) [2] and can also easily handle cyclic dependencies (whereas other real-time mechanisms may require some attention in such cases, [3–5])

Nevertheless, it requires some time synchronization and alignment of cycles between switches [2]. Moreover a fraction of the cycle time is used by a “guard band”,  $S$ , (called “adjustment factor” in [1]), that absorbs the effects of imperfections in time synchronization and alignment, and during which the output port can not be used by CQF frames. To avoid this issue, several alternative strategies have been defined (cf. Section 7), but they all require at least a third queue, or even a fourth one. Furthermore, the cycle start times are determined by a time offset that may be different for every output buffer.

The use of CQF requires the choice of two network-wide parameters, the cycle time  $T$  and the guard band  $S$ , and of the values of all time offsets at output buffers. The cycle time is related to the flows characteristics, whereas the guard band and the time offsets are related to synchronization between switches. In this paper, we address the choice of time offsets and guard band.

We consider the clock error model from [6], which captures the effects of clock nonidealities in the context of deterministic networks (cf. Section 3). Then we provide:

- a formal characterization of CQF cycle alignment and guard band (Sections 3 and 4.1), where, unlike other studies, we do not assume that all cycle offsets are equal;
- two sufficient conditions to check if a guard band  $S$  is large enough (Section 4.1), one being a simplification of the other;
- a necessary condition (Section 4.2), which is used to show the quality of the sufficient conditions (Section 4.3);
- a method to compute the minimum value of the guard band, given some pre-specified values of time offsets (Theorem 2);
- three strategies to compute a common guard band and local time offsets (two analytic ones, and a third using a Mixed Integer Linear Program – MILP – in Section 5);
- an evaluation of the strategies on some synthetic benchmarks, in Section 6.

The experiments of Section 6 show that:

- clock nonideality cannot be neglected;
- the choice of the offsets may have a dramatic effect on the minimum guard band value.

## 2 Presentation of CQF

### 2.1 Alternating Cycles

Consider a node offering a CQF policy to a set of flows (a CQF class) on a given output port. Two queues, called “even” and “odd” are dedicated to this CQF class, as depicted in Figure 1. The CQF node has a periodic behaviour, with period  $T$  (called

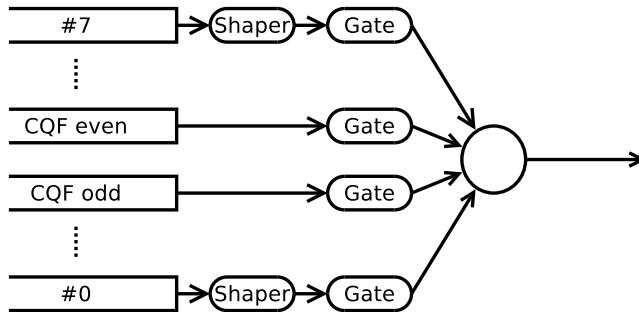

Figure 1: Queues of a bridge using CQF policy.

“cycle time”), which has the same value for all CQF nodes in the network. Let  $c(t)$  denote the value displayed at the clock of the node when the true time is  $t$  and let  $o$  be the time offset at this server. A time instant  $t$  is said to be in an “even” [resp. “odd”] cycle if  $\lfloor \frac{c(t)-o}{T} \rfloor$  is even [resp. odd]<sup>1</sup>. During an even cycle, the even queue is served and all received frames are stored in the odd queue. The frames stored in the odd queue will be forwarded in the next odd interval. The same holds, *mutatis mutandi*, with odd cycles.

The operation of CQF on an illustrative topology is shown in Figure 2. Under correct operation, CQF provides two guarantees: if a frame follows a path made of  $h$  hops, the end-to-end delay is in the range  $[(h-1)T, (h+1)T]$  and the delay-jitter is upper bounded by  $2T$  (for example, any frame of stream  $s_1$  experiences a delay in  $T$  and  $3T$ ). For correct operation, two conditions must be satisfied [7]. First, at every node, it must be possible to transmit in one cycle all frames received in the previous cycle. This requires that there is enough link capacity to support the rates of all sources and that the cycle duration is large enough to absorb the burstiness of all incoming flows in one cycle. This condition and the resulting minimum cycle length is studied in companion work and is outside the scope of this paper. Second, the cycles of consecutive nodes must be aligned such that all frames sent by a node when a buffer is open for transmission can be stored by the receiving node in a buffer that is open for reception. This condition is discussed in the next subsection.

## 2.2 Time-Aligned Nodes and Guard Band

In a CQF network, nodes are assumed to be time-synchronized. However, propagation times and switchover time (from switch input to switch output) are non zero and time synchronization is never perfect. To compensate for these effects, the standard introduced a guard band  $S$  at the beginning and at the end of each cycle as illustrated in Figure 3. The value of  $S$  is the same for all CQF nodes in the network.

The figure shows two frames,  $F$  and  $F'$ , sent by  $N_i$  to  $N_j$  with their emission time ( $E$  and  $E'$ ) and their propagation times ( $P$  and  $P'$ ). Here both cycles are not aligned. This can be by design (e.g. to compensate for propagation time) but can also occur due to clock imperfections.

The standard states that “ $S$  should be set to the sum of the errors or jitter values from all sources given in [a] list” and gives a list of sources of errors [1, §T.5.3]. In

<sup>1</sup>An expression such as  $\lfloor x \rfloor$  denotes the floor of  $x$ .

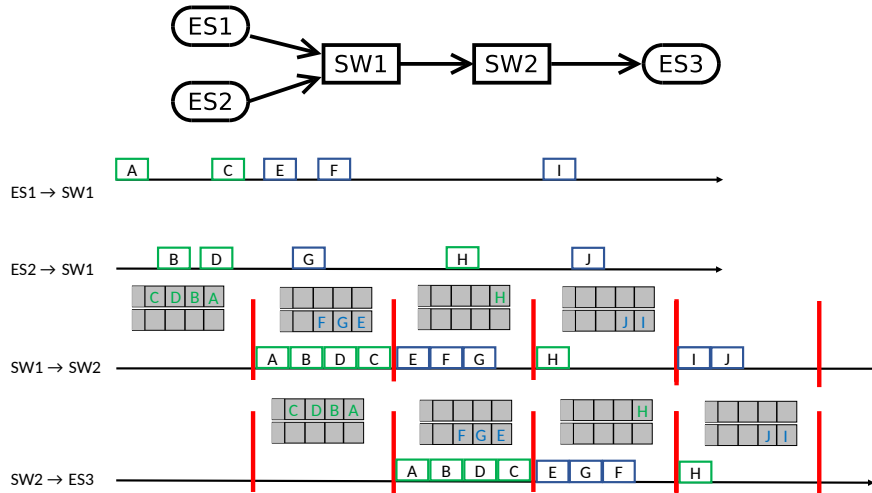

Figure 2: Operation of CQF on an illustrative topology.

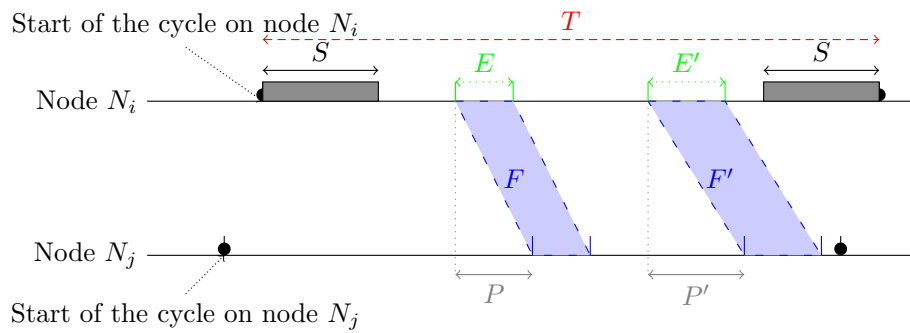

Figure 3: Illustration of the guard time  $S$ .

Section 4, we formally define what “Time-Aligned Nodes” means and give practical conditions to ensure that the time alignment holds. The conditions bear on the values of the guard band and the offsets. The guard band may result in a waste of capacity, hence it should be minimized. In Section 5 we give methods to compute offsets and guard band that minimize the guard band.

### 2.3 Other Aspects of CQF

The implementation of CQF relies on two mechanisms, the Per-Stream Filtering and Policing at input port (PSPF, [8]) and the Gate Control List at output port (GCL) defined in the “Enhancements for Scheduled Traffic” extension of the IEEE 802.1Q bridging standard [9]. PSPF has a time-driven table (also called GCL) which forwards the CQF frames from the input to the even or odd buffer on the output port. During an open interval, a queue has to compete with the other queues, using the static priority policy.

Then, the cycle time must account for higher priority flows and some limited interaction with lower priority flows to ensure that the frames received in the previous cycle can be forwarded in the current cycle. The conditions on the cycle time is out of the scope of this paper.

During the guard band, some higher or lower priority frames can be transmitted. Higher priority frames can be transmitted at any time, in or outside the guard band. Lower priority frame can start either during the guard band, or outside the guard band, once the current CQF queue is empty. When no preemption is implemented, the blocking factor is  $\frac{l_p^{\max}}{C}$  where  $l_p^{\max}$  is the maximal size of a lower priority packet and  $C$  the link bandwidth. If the preemption is implemented, and if the CQF queue is marked as “express” and the lower priority flow is “preemptable”, the blocking factor can be reduced to  $\frac{143 \times 8}{C}$  [10].

The standard also considers the case with several CQF classes having different cycle time and illustrates an example of interleaving in [1, Fig. T-5], presented also in [11]. Moreover, in wide area networks, some papers have proposed to extend CQF to more than 2 buffers. Such extensions are out of the scope of this paper.

## 3 System Model and Notation

We consider a network with a single CQF class with two buffers and  $n$  nodes  $N_1 \dots N_n$ . The CQF cycle time is  $T$ ; there is a guard band of duration  $S$  at the beginning of every cycle, and one of same duration at the end. The nominal values of  $T$  and  $S$  are identical at all nodes. In contrast, the links may have different bit rates  $R_{i,j}$ . Table 1 gathers the notation used throughout the paper.

Obviously, there must be enough time in one cycle to transmit the largest possible frame, i.e. we assume that

$$T - 2S \geq \max_{i,j} \bar{E}_{i,j}. \quad (1)$$

where  $\bar{E}_{i,j}$  is the transmission time of a frame of maximum size on the link from  $N_i$  to  $N_j$ . The same way,  $\underline{E}_{i,j}$  is the transmission time of a frame of minimum size on the link from  $N_i$  to  $N_j$ .

Every node has a local clock and all clocks are synchronized, using for example [12]. However, at the microsecond time scale, synchronization is not perfect and clock non idealities have to be taken into account. We use the following model, taken

from [6]. Let  $c_i(t)$  be the local time displayed by the clock of node  $N_i$  when the true time (international atomic time, TAI) is  $t$ . The nonideality of clock  $c_i$  can be characterized by the clock stability bound  $\rho_i \geq 1$ , the timing jitter bound  $\eta_i \geq 0$  and the synchronization error bound  $\Delta_i$ , such that displayed times satisfy:

$$\forall t, d \geq 0 : \frac{d - \eta_i}{\rho_i} \leq c_i(t + d) - c_i(t) \leq d\rho_i + \eta_i, \quad (2)$$

$$\forall t \geq 0 : |c_i(t) - t| \leq \Delta_i. \quad (3)$$

The former equation captures the effect of clock drift, jitter and wander on measurements of time intervals performed with the local clock. The latter equation captures the effect of the time synchronization protocol. In a TSN network synchronized with gPTP (generic PTP), the values are  $\rho_i = 1.0001$  [12, Annex B.1.1],  $\eta_i = 2\text{ns}$  [12, Annex B.1.3.1] and  $\Delta_i = 1\mu\text{s}$  [12, Section B.3]. The two equations above can be combined, which leads to the following bound on the measurements of time intervals (proof in Appendix B):

$$\max \left\{ \frac{d - 2\Delta_i}{\rho_i}, \frac{d - \eta_i}{\rho_i} \right\} \leq c_i(t + d) - c_i(t) \leq \min \left\{ d + 2\Delta_i, d\rho_i + \eta_i \right\} \quad (4)$$

Also note that we can always assume that  $2\Delta \geq \eta$  since otherwise we can replace  $\eta$  by  $2\Delta$  (Property 1 in Appendix C).

Node  $N_i$  uses a time offset  $o_i$ , at which the initial cycle begins. Consequently, the  $k$ th cycle starts at this node at true time  $t_k^i$  such that  $c_j(t_k^i) - o_j = kT$ . Thus, at true time  $t$ , node  $N_i$  is in the  $k$ th cycle with  $k = \left\lfloor \frac{c_j(t) - o_j}{T} \right\rfloor$ .

For a CQF frame  $F$  that travels from  $N_i$  to  $N_j$ , let  $t_{em}^F$  denote the instant at which node  $N_i$  finishes transmitting the last bit of  $F$ . Unless otherwise specified, all time instants are in true time. Then, node  $N_j$  receives the frame  $F$  and a classifier chooses in which queue the frame will be forwarded. Let  $t_{cl}^F$  denote the instant at which the frame  $F$  is forwarded to the queue  $Q_{j,b}$  of the node  $N_j$  with  $b = \left\lfloor \frac{c_j(t_{cl}^F) - o_j}{T} \right\rfloor \% 2$  (where  $\% 2$  denotes the remainder modulo 2). Note that the choice is done when the frame is totally received in the node  $N_j$ . The difference  $P_{i,j}^F = t_{cl}^F - t_{em}^F$  is the sum of the propagation time from  $N_i$  to  $N_j$  plus the time for ingress processing and is simply called “propagation” in the rest of the paper. Then, the frame is transmitted through the switch fabric and is written in the queue  $Q_{j,b}$ . Let  $t_{wr}^F$  denote the instant when the last bit of the frame  $F$  is written in the queue  $Q_{j,b}$  of node  $N_j$ . Note that the frame is written during the cycle  $\left\lfloor \frac{c_j(t_{wr}^F) - o_j}{T} \right\rfloor$ . The difference  $z_j^F = t_{wr}^F - t_{cl}^F$  is called the switching time. Figure 4 illustrates these definitions.

Following [1], we assume that the propagation time is not constant but has some bounded variability; this may correspond to variable decoding and processing times. Let  $\underline{P}_{i,j}, \overline{P}_{i,j}$  be lower and upper bounds on the propagation time from  $N_i$  to  $N_j$ . The difference  $\overline{P}_{i,j} - \underline{P}_{i,j}$  is a bound on the “propagation jitter”. Similarly, we assume that the switching time has some bounded variability and let  $\underline{z}_j, \overline{z}_j$  denote lower and upper bounds on the switching time at  $N_j$ .

In [13, § 4.11.3], it is specified that the “technological latency of the switch should be less than  $100 \mu\text{s}$ .” At the time of writing, a value of  $15\mu\text{s}$  seems acceptable.

Table 1: Notation

$\overline{E}_{i,j} = \frac{\overline{L}_{i,j}}{R_{i,j}}$	Max transmission time of CQF frame from $N_i$ to $N_j$
$\underline{E}_{i,j} = \frac{\underline{L}_{i,j}}{R_{i,j}}$	Min transmission time of CQF frame from $N_i$ to $N_j$
$k \in \mathbb{N}$	Index of a cycle
$\underline{L}_{i,j}, \overline{L}_{i,j}$	Min, max size of CQF frames from $N_i$ to $N_j$
$L_{i,j}^{\text{NPr}}$	Maximum size of high priority frame from $N_i$ to $N_j$
$N_i$	Node $i$
$o_i$	Time offset at node $i$
$\underline{P}_{i,j}, \overline{P}_{i,j}$	Lower and upper bounds on propagation time
$P$	Mean propagation time $P = \frac{1}{2} (\overline{P}_{i,j} + \underline{P}_{i,j})$
$p$	Propagation jitter parameter, $p = \frac{1}{2} (\overline{P}_{i,j} - \underline{P}_{i,j})$
$R_{i,j}$	Bit rate of link from $N_i$ to $N_j$
$S$	Duration of guard band at begin and end of cycle
$T$	Duration of cycle
$\underline{z}_j, \overline{z}_j$	Lower and upper bounds on switching time
$c_i(t)$	time displayed by clock of $N_i$ when true time is $t$
$\Delta_i$	clock synchronization error bound (e.g. $\Delta_i = 1\mu\text{s}$ )
$\rho_i \geq 1$	clock stability bound (e.g. $\rho_i = 1.0001$ )
$\eta_i \leq 2\Delta$	clock timing jitter bound (e.g. $\eta_i = 2\text{ns}$ )
$\lfloor x \rfloor$	floor of the real number $x$
$m\%2$	residual modulo 2 of the integer $m$
$\varepsilon$	a tolerance on the accuracy of floating-points
$\overline{S}$	a network-wide upper bound on $S$ , (15)
$\underline{S}$	a lower bound on $S^{o_i, o_j}$ , (16)
$S_{\text{thm1}}^{*o_i, o_j}, S_{\text{thm1}}^*$	minimum value of $S$ (at precision $\varepsilon$ ) that satisfies the sufficient condition in Theorem 1
$S_{\text{cor1}}^{*o_i, o_j}, S_{\text{cor1}}^*$	minimum value of $S$ (at precision $\varepsilon$ ) that satisfies the simpler sufficient condition in Corollary 1
$\underline{S}_{\text{cor1}}^{o_i, o_j}$	infimum of all values of $S$ that satisfy Corollary 1; may or may not be feasible and $0 \leq S_{\text{cor1}}^{*o_i, o_j} - \underline{S}_{\text{cor1}}^{o_i, o_j} \leq \varepsilon$
$S_{\text{thm3}}^{*o_i, o_j}, S_{\text{thm3}}^*$	minimum value of $S$ (at precision $\varepsilon$ ) that satisfies the necessary condition in Theorem 3
$I$	number of nodes
$\mathcal{L}$	set of links



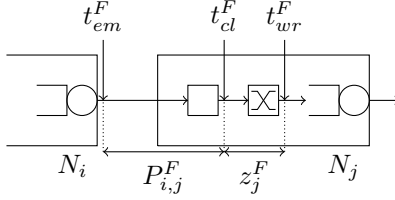

Figure 4: Significant times between 2 nodes  $N_i$  and  $N_j$ .

## 4 Conditions for Time Alignment

In this section we solve the issue of time alignment of nodes. This involves the offsets and the guard band. The main results of this section are Theorem 1 and Corollary 1, which give sufficient conditions for nodes to be time aligned; the latter is more tractable than the former and gives the basis of methods to compute offsets and minimal guard band that minimize the duration of the guard band in Section 5. We also show in Theorem 2 that the minimum value of the guard band for given offsets can be obtained by binary search. Ideally, we would like to have a necessary and sufficient condition, but this appears to be out of reach as it is difficult to quantify all possible behaviours; instead, we give a necessary condition and show that the difference with the sufficient condition is small. In the idealized case where clocks are perfect and switching latency is negligible, the conditions are identical.

### 4.1 Sufficient Conditions

We start by a formal definition of time alignment.

**Definition 1** (Time aligned nodes). *Consider a node  $N_i$  that has a link to a node  $N_j$ . We say that  $N_i$  and  $N_j$  are time-aligned if and only if, for any cycle index  $k$  at  $N_i$ , there exists a cycle index  $k'$  at  $N_j$  such that all frames sent by  $N_i$  in cycle  $k$  are forwarded by node  $N_j$  in cycle  $k'$  out of a single CQF buffer.*

Using the notation in Section 3, we have that a frame sent at time  $t$  to the node  $j$  is classified at time  $t_{cl}$  in the queue  $Q_{j,b}$  with  $b = \left\lfloor \frac{c_j(t_{cl}) - o_j}{T} \right\rfloor \% 2$  and received at time  $t_{wr}$  in this queue during the cycle  $k = \left\lfloor \frac{c_j(t_{wr}) - o_j}{T} \right\rfloor$ .

Consequently, Definition 1 is equivalent to saying that, for any two frames  $F, F'$  sent by  $N_i$  to  $N_j$  during one same cycle, they are classified in the same queue  $Q_{j,b}$ , with

$$b = \left\lfloor \frac{c_j(t_{cl}^F) - o_j}{T} \right\rfloor \% 2 = \left\lfloor \frac{c_j(t_{cl}^{F'}) - o_j}{T} \right\rfloor \% 2 \quad (5)$$

and they are received in the same cycle  $k$  with

$$k = \left\lfloor \frac{c_j(t_{wr}^F) - o_j}{T} \right\rfloor = \left\lfloor \frac{c_j(t_{wr}^{F'}) - o_j}{T} \right\rfloor \quad (6)$$

Using Equations (5) and (6), we obtain the following sufficient condition:

**Theorem 1** (Sufficient condition for node alignment). *Consider two nodes  $N_i, N_j$  such that  $N_i$  has a link to  $N_j$ . The parameters  $\eta_i, \eta_j, \rho_i, \rho_j, \Delta_i, \Delta_j, \underline{E}_{i,j}, o_i, o_j, S$  and  $T$  are as defined in section 3. Define  $U_{i,j}(S)$  and  $L_{i,j}(S)$  by*

$$L_{i,j}(S) = S + \underline{E}_{i,j} + \underline{P}_{i,j} + o_i - o_j - (\Delta_i + \Delta_j) - \widehat{l}_{i,j}(S) \quad (7)$$

with

$$\widehat{l}_{i,j}(S) = \min \begin{cases} (\underline{E}_{i,j} + S) \cdot (1 - \frac{1}{\rho_i}) + \frac{\eta_i}{\rho_i} + 2\Delta_j, \\ 2\Delta_i + 2\Delta_j, \\ (\underline{E}_{i,j} + S) \cdot (1 - \frac{1}{\rho_i \cdot \rho_j}) \\ \quad + \underline{P}_{i,j} \cdot (1 - \frac{1}{\rho_j}) + \frac{\eta_i}{\rho_i \cdot \rho_j} + \frac{\eta_j}{\rho_j}, \\ (\underline{E}_{i,j} + S + \underline{P}_{i,j}) \cdot (1 - \frac{1}{\rho_j}) + \frac{\eta_j}{\rho_j} + 2\Delta_i \cdot \frac{1}{\rho_j} \end{cases} \quad (8)$$

and

$$U_{i,j}(S) = T - S + \overline{P}_{i,j} + \overline{z}_j + o_i - o_j + \Delta_i + \Delta_j + \widehat{u}_{i,j}(S) \quad (9)$$

with

$$\widehat{u}_{i,j}(S) = \min \begin{cases} (T - S) \cdot (\rho_i - 1) + \eta_i + 2\Delta_j \\ 2\Delta_i + 2\Delta_j \\ (T - S) \cdot (\rho_i \cdot \rho_j - 1) + \eta_i \cdot \rho_j \\ \quad + (\overline{P}_{i,j} + \overline{z}_j) \cdot (\rho_j - 1) + \eta_j \\ (T - S + \overline{P}_{i,j} + \overline{z}_j) \cdot (\rho_j - 1) + \eta_j + 2\Delta_i \cdot \rho_j \end{cases} \quad (10)$$

If the parameters satisfy the condition

$$\left\lfloor \frac{U_{i,j}(S)}{T} \right\rfloor = \left\lfloor \frac{L_{i,j}(S)}{T} \right\rfloor \quad (11)$$

then, the two nodes  $N_i, N_j$  are time aligned and the difference between the emission and the reception cycles is constant, equal to

$$\delta^{i,j} = \left\lfloor \frac{U_{i,j}(S)}{T} \right\rfloor = \left\lfloor \frac{L_{i,j}(S)}{T} \right\rfloor \quad (12)$$

If all clocks are perfect, the values of  $L$  and  $U$  become

$$L_{i,j}(S) = S + \underline{E}_{i,j} + \underline{P}_{i,j} + o_i - o_j, \quad (13)$$

$$U_{i,j}(S) = T - S + \overline{P}_{i,j} + \overline{z}_j + o_i - o_j. \quad (14)$$

The condition (11) then expresses that the guard band  $S$  and the offsets  $o_i, o_j$  have to compensate the transmission, propagation and switching delays. With nonideal clocks, there are additional terms in  $L$  and  $U$ : the former term,  $\Delta_i + \Delta_j$ , captures the synchronization accuracy whereas the latter term, namely  $\widehat{l}$  or  $\widehat{u}$ , captures the effect of supplementary nonidealities. The values in the theorem then add some margin in order to account for clock nonidealities.

The term  $\delta^{i,j}$  represents the difference in cycle number. At first glance, one may expect, up to some normalisation, to always have  $\delta^{i,j} = 0$  *i.e.* a frame sent a cycle  $k$  is received at cycle  $k$ . But as will be shown in the experiments (Section 6, Figure 20), one may introduce some phase between the offsets to absorb the propagation time and reduce the guard band. When this strategy is used on a non feed-forward network (a network with cycles) with large propagation time (*i.e.* when the sum of the propagation times is more than half of the cycle time  $T$ ), some non null  $\delta^{i,j}$  will appear.

*Sketch of proof.* The proof consists in bounding the reception time of frames sent by the node  $N_i$  to the node  $N_j$  in one cycle. To this end, we consider two frames, the former being sent as early as possible and the latter as late as possible. Let  $t, t'$  be the respective reception instants. Since both have to be received in the same cycle, it implies  $\lfloor \frac{c_j(t) - o_j}{T} \rfloor = \lfloor \frac{c_j(t') - o_j}{T} \rfloor$  (where  $c_j$  is the clock of  $N_j$ ). Then, we use the conditions on clocks to compute a lower bound on the former expression and an upper bound on the latter.

The full proof is given in Appendix D.  $\square$

The values of  $L_{i,j}(S)$  and  $U_{i,j}(S)$  depend on  $S$  in a non linear way. In Section 5 we are interested in computing offsets that minimize  $S$ ; this non-linearity leads to MILPs with many binary variables, which quickly become intractable. This motivates us to derive from Theorem 1 the simpler sufficient condition in Corollary 1, which, as we show in Section 4.3, remains very close. To this end, first observe that, by (1), we must have

$$S \leq \bar{S} := \frac{T - \max_{i,j} \bar{E}_{i,j}}{2} \quad (15)$$

Second, we use the following lower bound:

**Property 1.** *Let*

$$\underline{S} := \max_{i,j} \left( \frac{\bar{P}_{i,j} + \bar{z}_j - \underline{P}_{i,j} - \underline{E}}{2} + \Delta_i + \Delta_j \right) \quad (16)$$

*If  $S$  satisfies the sufficient condition (11) in Theorem 1 for every pair  $i, j$ , then  $S > \underline{S}$ .*

*Proof.* The proof is given in Appendix E.  $\square$

This leads to the following, simpler, sufficient condition:

**Corollary 1** (Simpler Sufficient Condition for Node Alignment). *Theorem 1 continues to hold if we replace  $\hat{l}_{i,j}(S)$  and  $\hat{u}_{i,j}(S)$  by  $\hat{l}_{i,j}(\bar{S})$  and  $\hat{u}_{i,j}(\underline{S})$ , i.e. if we replace  $L_{i,j}(S), U_{i,j}(S)$  by*

$$L'_{i,j}(S) = S + \underline{E}_{i,j} + \underline{P}_{i,j} + o_i - o_j - (\Delta_i + \Delta_j) - \hat{l}_{i,j}(\bar{S}) \quad (17)$$

$$U'_{i,j}(S) = T - S + \bar{P}_{i,j} + \bar{z}_j + o_i - o_j + \Delta_i + \Delta_j + \hat{u}_{i,j}(\underline{S}) \quad (18)$$

*Proof.* The proof is given in Appendix F.  $\square$

Next, we study the set of values of the guard time  $S$  that, for given values of the offsets  $o_i, o_j$ , satisfy the sufficient condition in Theorem 1 or in Corollary 1. Specifically, we are interested in minimizing the value of  $S$  for given values of the offsets, which is given by the next theorem.

**Theorem 2.** *For given values of the offsets  $o_i, o_j$ , let  $\mathcal{S}_{\text{thm1}}^{o_i, o_j}$  be the set of values of  $S \in [0; \bar{S}]$  that satisfy the sufficient condition (11) in Theorem 1.*

- $\mathcal{S}_{\text{thm1}}^{o_i, o_j}$  is not empty if and only if  $\bar{S}$  satisfies (11);
- If  $\mathcal{S}_{\text{thm1}}^{o_i, o_j}$  is not empty then there exists some  $\underline{S}_{\text{thm1}}^{o_i, o_j} > 0$  such that

$$\mathcal{S}_{\text{thm1}}^{o_i, o_j} = (\underline{S}_{\text{thm1}}^{o_i, o_j}; \bar{S}]$$

$$\text{or } \mathcal{S}_{\text{thm1}}^{o_i, o_j} = [\underline{S}_{\text{thm1}}^{o_i, o_j}; \bar{S}].$$

- If  $\mathcal{S}_{\text{thm1}}^{o_i, o_j}$  is not empty, let  $S_{\text{thm1}}^{*o_i, o_j}$  be the smallest value of  $S \in \mathcal{S}_{\text{thm1}}^{o_i, o_j}$  obtained with binary search in the interval  $[0; \bar{S}]$  with precision  $\varepsilon$  (this requires  $\lceil \log_2 \frac{\bar{S}}{\varepsilon} \rceil$  steps). Then  $S_{\text{thm1}}^{*o_i, o_j}$  is an  $\varepsilon$ -over-approximation of  $\underline{S}_{\text{thm1}}^{o_i, o_j}$ . i.e.  $[S_{\text{thm1}}^{*o_i, o_j}; \bar{S}] \subset \mathcal{S}_{\text{thm1}}^{o_i, o_j}$  and  $S_{\text{thm1}}^{*o_i, o_j} - \underline{S}_{\text{thm1}}^{o_i, o_j} \leq \varepsilon$ .

The same holds mutatis mutandi with Corollary 1.

The proof is in Appendix G. The above theorem establishes that the set of feasible guard band durations is an interval, however, it may be closed or semi-closed, i.e., it is not certain that the infimum is feasible. This is because of the floor in (11), which leads to a discontinuous condition (see Lemma 8 in Appendix K for details). This means that, strictly speaking, there might not be a minimum value. In practice, however, we are interested in values expressed with some accuracy, say  $\varepsilon$  and the theorem means that, modulo a precision of  $\varepsilon$ , there is a minimum value  $S_{\text{thm1}}^{*o_i, o_j}$ , and any value above it and below  $\bar{S}$  is feasible. The same holds for the condition in Corollary 1, and since any  $S$  that satisfies Corollary 1 also satisfies Theorem 1, we always have  $S_{\text{thm1}}^{*o_i, o_j} \leq S_{\text{cor1}}^{*o_i, o_j}$ . Furthermore, we show numerically in Section 4.3 that the difference is small.

Last, the following property (proof in Appendix H) shows that the sufficient condition models the expected notion of slack: improving a clock can only reduce the value of the required guard band.

**Property 2.** Let  $S$  be a solution of Theorem 1 with two clock quality parameters  $(\rho_i, \eta_i, \Delta_i)$   $(\rho_j, \eta_j, \Delta_j)$  for some values of the offsets  $o_i, o_j$ . Then,  $S$  is also a solution with better clock quality parameters  $(\rho'_i, \eta'_i, \Delta'_i)$   $(\rho'_j, \eta'_j, \Delta'_j)$  for the same values of the offsets  $o_i, o_j$ . Here better means  $\rho'_i \leq \rho_i$ ,  $\eta'_i \leq \eta_i$ ,  $\Delta'_i \leq \Delta_i$ ,  $\rho'_j \leq \rho_j$ ,  $\eta'_j \leq \eta_j$ ,  $\Delta'_j \leq \Delta_j$ . The same holds mutatis mutandi with Corollary 1.

## 4.2 Necessary Condition

We now complement the sufficient condition in the previous section with a necessary condition. For readability, in this subsection we drop the dependency on  $i, j$  in  $U$  and  $L$  variables.

**Theorem 3** (Necessary condition for time alignment). Let  $N_i, N_j$  be two nodes with parameters  $\eta_i, \eta_j, \rho_i, \rho_j, \Delta_i, \Delta_j, \underline{E}_{i,j}, o_i, o_j, S$  as defined in section 3. Define  $X, s, \tilde{L}_\%, \tilde{L}_{\%s}, \tilde{U}_\%, \tilde{U}_{\%s}, \tilde{L}, \tilde{L}_s, \tilde{U}$  and  $\tilde{U}_s$  as follow:

$$X = \underline{P}_{i,j} - \Delta_i + o_i - o_j + \underline{E} + S \quad (19)$$

$$\tilde{L}_\% = X - \Delta_j \quad (20)$$

$$\tilde{L} = X - \Delta_j + \min \begin{cases} \underline{z}_j + 2\Delta_j, \\ \rho_j \cdot \underline{z}_j + \eta_j \end{cases} \quad (21)$$

$$\tilde{U}_\% = X + \quad (22)$$

$$\min \begin{cases} T - \underline{E} - 2S + \bar{P}_{i,j} - \underline{P}_{i,j} + \Delta_j + 2\Delta_i \\ (T - \underline{E} - 2S) \cdot \rho_i + \bar{P}_{i,j} - \underline{P}_{i,j} + \Delta_j \\ (T - \underline{E} - 2S + \bar{P}_{i,j} - \underline{P}_{i,j} + 2\Delta_i) \cdot \rho_j + \eta_j - \Delta_j \\ ((T - \underline{E} - 2S) \cdot \rho_i + \bar{P}_{i,j} - \underline{P}_{i,j}) \cdot \rho_j + \eta_j - \Delta_j \end{cases}$$



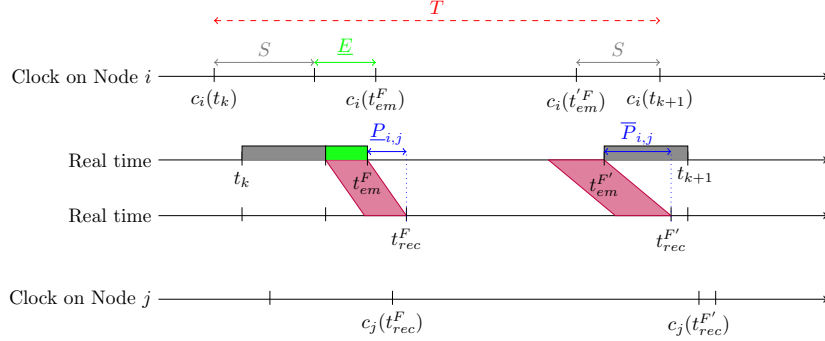

Figure 5: Illustration of Theorem 3.

For given values of the offsets  $o_i, o_j$ , let  $\mathcal{S}^{o_i, o_j}$  be the set of values of  $S$  that satisfy the exact but intractable conditions in (5), (6) and let  $\mathcal{S}_{\text{thm3}}^{o_i, o_j}$  be the set of values of  $S$  that satisfy the necessary condition of Theorem 3. It follows that

$$\mathcal{S}_{\text{thm3}}^{o_i, o_j} \subset \mathcal{S}^{o_i, o_j} \subset \mathcal{S}_{\text{thm1}}^{o_i, o_j} \subset \mathcal{S}_{\text{cor1}}^{o_i, o_j} \quad (36)$$

In the next section we will compare these sets. Note that, while  $\mathcal{S}_{\text{thm1}}^{o_i, o_j}$  and  $\mathcal{S}_{\text{cor1}}^{o_i, o_j}$  are intervals, it is not clear whether the same holds for  $\mathcal{S}_{\text{thm3}}^{o_i, o_j}$  and  $\mathcal{S}^{o_i, o_j}$ . However, let  $\underline{S}_{\text{thm3}}^{o_i, o_j} = \inf \mathcal{S}_{\text{thm3}}^{o_i, o_j}$ , which we numerically compute by brute force, thus obtaining an  $\varepsilon$ -lower approximation  $S_{\text{thm3}}^{*o_i, o_j}$ . It follows that the length of  $\mathcal{S}^{o_i, o_j} \setminus \mathcal{S}_{\text{thm1}}^{o_i, o_j}$  is upper bounded by  $S_{\text{thm1}}^{*o_i, o_j} - S_{\text{thm3}}^{*o_i, o_j}$ , which thus bounds the pessimism of the sufficient condition in Theorem 1 (and similarly with Corollary 1).

### 4.3 Comparing the Three Conditions

We have obtained two sufficient conditions (Theorem 1 and Corollary 1) and one necessary condition (Theorem 3). To evaluate the tightness of the sufficient conditions, we compute the values of  $S_{\text{thm1}}^{*o_i, o_j} - S_{\text{thm3}}^{*o_i, o_j}$  and  $S_{\text{cor1}}^{*o_i, o_j} - S_{\text{thm1}}^{*o_i, o_j}$  for different values of the offsets and other parameters taken randomly with a uniform distribution in the intervals shown in Table 2.

We take 100 000 configurations using these parameters and we compute  $S_{\text{thm1}}^{*o_i, o_j}$  and  $S_{\text{cor1}}^{*o_i, o_j}$  by binary search (with  $\varepsilon = \bar{S} \cdot 10^{-10}$ ) and  $S_{\text{thm3}}^{*o_i, o_j}$  by scanning all values between 0 and  $S_{\text{thm1}}^*$  with a step of 10 ns for each configuration. Note that for 3978 configurations there is no solution, i.e. the parameters don't allow to find any valid guard band value. We trace the histogram shown on Figure 6 of the difference between the values (see x label).

As we can see, the two sufficient conditions are close: The maximum difference between them is around  $0.2\mu\text{s}$  and the average difference is around  $0.05\mu\text{s}$ . Thus, the condition in Corollary 1 is satisfactory because it is easier to compute and quite close to Theorem 1.

Moreover, we see that the difference between the sufficient and the necessary condition is around  $0.1\mu\text{s}$  and the maximum difference is around  $4.5\mu\text{s}$ . However, on this set of configurations, only 26 values are greater than  $0.5\mu\text{s}$  (0.03% of the configurations, visible on the zoom of the left graph). Thus, we can consider that we are close enough to the true (intractable) solution by using the sufficient condition.

Table 2: Random Parameters ( $\mu\text{s}$ ) for Figure 6. Nodes  $i, j$  are fixed,  $o_i = 0$ ,  $\underline{P}_{i,j} = P - p$  and  $\overline{P}_{i,j} = P + p$ .

Random values (in $\mu\text{s}$ , except for $\rho$ , unitless)			
$P$	$p$	$\bar{z}_j$	$\underline{z}_j$
[0; 200]	[0.01; 0.1] * $P$	[0; 15]	[0; $\bar{z}$ ]
$o_j$	$\Delta$	$\rho$	$\eta$
[0; 1000]	[0; 1]	1 + [0; .0002]	[0; .002]

#### 4.4 Effect of Clock Nonidealities

The incorporation of clock nonidealities brings some complexity to the analysis. In this section we test whether such a modelling accuracy is really necessary. We consider a representative configuration as in Table 3 and consider the effect of the following three factors in the analysis: (1) propagation jitter  $2p$  and switching time  $\bar{z}$ ; (2) clock synchronization error  $\Delta$ ; (3) clock jitter and drift parameters  $\rho, \eta$ . This leads to the following four scenarios:

- 'Perfect': propagation jitter and switching times are null and clocks are perfect. This is the assumption done in most of the literature.
- 'Perfect clock, default other': propagation jitter and switching times are considered but clocks are perfect.
- 'Default': considers all elements described in this paper.
- 'Default, synchronization only': This captures the result of a simplified analysis that captures clock synchronization accuracy but ignores bounds on clock jitter and drift.

The resulting  $S^*$  are computed as in the previous section, and the results are shown in Table 3. We observe that, with the perfect configuration, all the resulting  $S^*$  are approximately equal to 0 (not exactly, due to the tolerance  $\varepsilon$ ). However, with the other scenarios, the resulting  $S^*$  are all non negligible and cause a loss of about 3-4 percent of the cycle time for this single configuration. Most of it comes from system delays (3%), and clock errors add another .5%. Last, ignoring clock drift and jitter bounds induces an increase in the guard band by .5% for the sufficient conditions and increases the gap between the necessary and the sufficient condition. Thus, the model including the clock drift and jitter bounds is significantly better than the one only considering the clock synchronization.

This suggests that we can't ignore the nonidealities; this is confirmed by the thorough experiments in Section 6.

## 5 Computing the guard band and the offsets

In the previous section we have shown that Corollary 1 obtains a quasi-optimal condition to decide whether some guard band value  $S$  is admissible and gives a method to test whether some feasible guard band exists at all. Furthermore, we have shown that there is an infimal value  $\underline{S}_{\text{cor1}}^{o_i, o_j}$ , for given values of time offsets  $o_i, o_j$ , which may or may not be admissible, but such that any value in the range  $(\underline{S}_{\text{cor1}}^{o_i, o_j}; \bar{S}]$  is admissible with

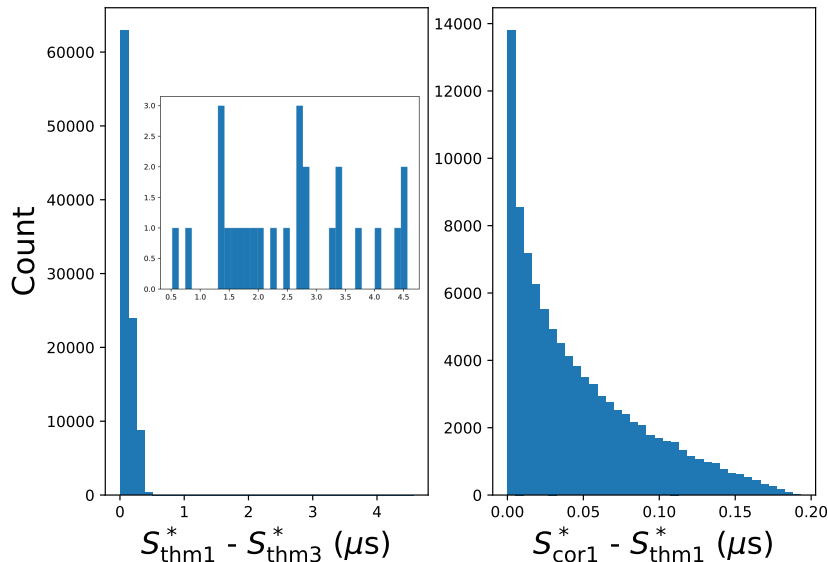

Figure 6: Histogram of the difference between the conditions.

respect to the constraints on link  $(i, j)$ . We have also given a method to compute an  $\varepsilon$  over-approximation,  $S_{\text{cor1}}^{*o_i, o_j}$ , of  $\underline{S}_{\text{cor1}}^{o_i, o_j}$ , which can be interpreted as a minimal guard band value, given offsets.

If the values of the offsets are imposed or given by some oracle, the infimal guard band is then equal to  $\max_{(i,j) \in \mathcal{L}} \underline{S}_{\text{cor1}}^{o_i, o_j}$ , since it must satisfy the constraints on every link. However, as we show below, the values of the time offsets largely influence the infimal guard band. Therefore, we are interested in solving

**Problem (P):**

$$\begin{aligned} & \text{minimize } \max_{(i,j) \in \mathcal{L}} \underline{S}_{\text{cor1}}^{o_i, o_j} \\ & \text{over } (o_i)_{i=1:I} \in [0; T]^I \end{aligned}$$

where, by convention,  $\underline{S}_{\text{cor1}}^{o_i, o_j} = +\infty$  if Corollary 1 gives no admissible guard band for these values of  $o_i, o_j$ . In the above,  $\mathcal{L}$  is the set of links and  $I$  is the number of nodes. If Problem (P) has a solution, say  $\underline{S}$ , then any  $S$  that satisfies  $\underline{S} < S \leq \bar{S}$  is a valid guard band.

We first give two simple heuristics that correspond to common practices; then we derive a MILP formulation of Problem (P).

## 5.1 Heuristics

Recall that the condition in Corollary 1 is:

$$\left\lfloor \frac{U'_{i,j}(S)}{T} \right\rfloor = \left\lfloor \frac{L'_{i,j}(S)}{T} \right\rfloor \quad (37)$$



Table 3: Effect of clock nonidealities. Nodes  $i, j$  are fixed,  $\underline{P}_{i,j} = P - p$  and  $\overline{P}_{i,j} = P + p$ .

Values for all scenarios.				
$T$	$P$	$\underline{z}_j$	$o_i$	$o_j$
1ms	100 $\mu$ s	0	0	100 $\mu$ s
$\underline{E}_{ij}$		$\overline{E}_{ij}$		
0.672 $\mu$ s		12.384 $\mu$ s		

	Perfect	Perfect clock, default other	Default	Default, synchronization only
$p$	0	0.5 $\mu$ s	0.5 $\mu$ s	0.5 $\mu$ s
$\overline{z}_j$	0	15 $\mu$ s	15 $\mu$ s	15 $\mu$ s
$\Delta$	0	0	1 $\mu$ s	1 $\mu$ s
$\rho$	1	1	1.0001	$+\infty$
$\eta$	0	0	2ns	$+\infty$
$S_{\text{cor1}}^*$	2.9e-8 $\mu$ s	15.5 $\mu$ s	17.7 $\mu$ s	21.5 $\mu$ s
$S_{\text{thm1}}^*$	2.9e-8 $\mu$ s	15.5 $\mu$ s	17.7 $\mu$ s	21.5 $\mu$ s
$S_{\text{thm3}}^*$	2.9e-8 $\mu$ s	15.5 $\mu$ s	17.5 $\mu$ s	17.5 $\mu$ s

where  $L'_{i,j}, U'_{i,j}$  are defined in (17) and (18)

### 5.1.1 Null offset

This solution consists in aligning all offsets, which, without loss of generality, can be written as  $o_i = o_j = 0$ . The condition in (37) becomes:

$$\begin{aligned}
 & \left\lfloor \frac{S + \underline{E}_{i,j} + \underline{P}_{i,j} - (\Delta_i + \Delta_j) - \widehat{l}_{i,j}(\overline{S})}{T} \right\rfloor \\
 &= \left\lfloor \frac{T - S + \overline{P}_{i,j} + \overline{z}_{i,j} + \Delta_i + \Delta_j + \widehat{u}_{i,j}(\underline{S})}{T} \right\rfloor
 \end{aligned} \tag{38}$$

The general case is complicated (see Appendix J), but can be considerably simplified when the cycle time is large compared to propagation and transmission. Specifically, consider the following condition, stating that the clock error term  $\widehat{l}_{i,j}$  is small with regards to emission, propagation and switching times, which also are smaller than the cycle time:

$$0 \leq \underline{E}_{i,j} + \underline{P}_{i,j} + \overline{P}_{i,j} + \overline{z}_{i,j} + \widehat{u}_{i,j}(\underline{S}) - \widehat{l}_{i,j}(\overline{S}) < T. \tag{39}$$

If this condition holds for every  $i, j$ , then the floor functions in (38) are null (see

Appendix J, (242)), implying

$$0 \leq S + \underline{E}_{i,j} + \underline{P}_{i,j} - (\Delta_i + \Delta_j) - \widehat{l}_{i,j}(\overline{S}) < T \quad (40)$$

$$0 \leq T - S + \overline{P}_{i,j} + \overline{z}_{i,j} + \Delta_i + \Delta_j + \widehat{u}_{i,j}(\underline{S}) < T. \quad (41)$$

Consequently,

$$S \geq (\Delta_i + \Delta_j) + \widehat{l}_{i,j}(\overline{S}) - \underline{E}_{i,j} - \underline{P}_{i,j} \quad (42)$$

$$S > \overline{P}_{i,j} + \overline{z}_{i,j} + \Delta_i + \Delta_j + \widehat{u}_{i,j}(\underline{S}) \quad (43)$$

However, since (39) holds, then

$$\overline{P}_{i,j} + \overline{z}_{i,j} + \widehat{u}_{i,j}(\underline{S}) \geq \widehat{l}_{i,j}(\overline{S}) - \underline{E}_{i,j} - \underline{P}_{i,j} \quad (44)$$

It follows that the infimum of  $S$  is

$$S_{\text{null}} = \max_{i,j} \left\{ \overline{P}_{i,j} + \overline{z}_{i,j} + \Delta_i + \Delta_j + \widehat{u}_{i,j}(\underline{S}) \right\}. \quad (45)$$

i.e., if (39) holds for every  $i, j$  and  $S_{\text{null}} < \overline{S}$ , then any  $S$  in  $(S_{\text{null}}; \overline{S}]$  is an admissible value for the guard band.

As expected, the guard band needs to absorb terms related to the clock imperfections  $(\Delta_i, \Delta_j, \widehat{u}_{i,j}(\underline{S}))$  but it also has to absorb the maximal propagation and maximal switching times  $(\overline{P}_{i,j}, \overline{z}_{i,j})$ .

In the general case (when (39) does not hold for some  $i, j$ ) the expression of  $S_{\text{null}}$  is more complicated and is given in Appendix J.

### 5.1.2 Absorbing the propagation with offsets

The standard suggests to set the guard band such that it compensates the “jitter in the propagation time”, whereas the expression in eq. (45) involves the propagation itself, not its jitter. This suggests another strategy, where the offsets are set to compensate the average propagation time.

Let  $P$  be the mid propagation time between the node  $i$  and the node  $j$ , and  $p_{i,j}$  the semi-variation, i.e.:

$$P_{i,j} = \frac{\underline{P}_{i,j} + \overline{P}_{i,j}}{2}, \quad p_{i,j} = P_{i,j} - \underline{P}_{i,j} = \overline{P}_{i,j} - P_{i,j}. \quad (46)$$

Assume that we can choose  $o_i$  and  $o_j$  such that

$$o_j = o_i + P_{i,j} \quad (47)$$

then the condition 37 becomes:

$$\begin{aligned} & \left| \frac{S + \underline{E}_{i,j} - p_{i,j} - (\Delta_i + \Delta_j) - \widehat{l}_{i,j}(\overline{S})}{T} \right| \\ &= \left| \frac{T - S + p_{i,j} + \overline{z}_{i,j} + \Delta_i + \Delta_j + \widehat{u}_{i,j}(\underline{S})}{T} \right| \end{aligned} \quad (48)$$

As Equation (1) is respected, we know that

$$S + \underline{E}_{i,j} - p_{i,j} - (\Delta_i + \Delta_j) - \widehat{l}_{i,j}(\overline{S}) \quad (49)$$

$$\leq \underline{E}_{i,j} + S \quad (50)$$

$$\leq T - S < T \text{ because } S > 0. \quad (51)$$

So, it comes  $\left\lfloor \frac{S + \underline{E}_{i,j} - p_{i,j} - (\Delta_i + \Delta_j) - \widehat{l}_{i,j}(\overline{S})}{T} \right\rfloor = 0$ . Consequently,

$$\left\lfloor \frac{T - S + p_{i,j} + \overline{z}_{i,j} + \Delta_i + \Delta_j + \widehat{u}_{i,j}(\underline{S})}{T} \right\rfloor = 0, \text{ thus}$$

$$T - S + p_{i,j} + \overline{z}_{i,j} + \Delta_i + \Delta_j + \widehat{u}_{i,j}(\underline{S}) < T \quad (52)$$

$$S > p_{i,j} + \overline{z}_{i,j} + \Delta_i + \Delta_j + \widehat{u}_{i,j}(\underline{S}). \quad (53)$$

It follows that the infimum of  $S$  is

$$S_{\text{prop}} = \max_{i,j} \left\{ \frac{\overline{P}_{i,j} - P_{i,j}}{2} + \overline{z}_{i,j} + \Delta_i + \Delta_j + \widehat{u}_{i,j}(\underline{S}) \right\}. \quad (54)$$

In other words, if for every link  $(i, j) : o_j = o_i + \frac{\overline{P}_{i,j} + P_{i,j}}{2}$ , and  $S_{\text{prop}} < \overline{S}$ , then any  $S$  in  $(S_{\text{prop}}; \overline{S}]$  is an admissible value for the guard band.

As expected, the guard band needs to absorb terms related to the clock imperfections  $(\Delta_i, \Delta_j, \widehat{u}(\underline{S}))$  but it also has to absorb the jitter of the propagation time and the maximal switching time.

However, having (47) simultaneously at all links  $i, j$  is not always possible, for example when a switch has several inputs or in case of cyclic dependency (in case of a ring).

### 5.1.3 Comparing the Two Heuristics

Observe that  $S_{\text{prop}} < S_{\text{null}}$ , i.e. setting the offsets to absorb the propagation time, when it is possible, always gives a smaller (i.e. better) guard band than when aligning all offsets. For a single pair of nodes, the difference is  $\frac{\overline{P}_{i,j} + P_{i,j}}{2}$  i.e. the median propagation delay. Considering a propagation speed being 60% of light speed, as in [14, N.6] (that is to say, 0.18m/ns) it takes  $0.11\mu\text{s}$  to cross a 20m cable, and in a Metropolitan Area Network (MAN), a 20km cable will have a transmission delay of 0.11ms. At 1Gb/s, 0.11ms is the transmission time of 110Kb of data.

The fact that  $S_{\text{prop}}$  can be significantly smaller than  $S_{\text{null}}$  indicates that the time offsets do have an important effect on the minimum guard band. However, the heuristic that leads to  $S_{\text{prop}}$  imposes strict constraints on the network topology, and is often not applicable. This motivates us to find a solution to Problem (P), i.e. to compute time offsets that minimize the guard band.

## 5.2 Using a MILP Solver

In this section we derive a method to solve Problem (P). First notice that, from (37), Problem (P) is equivalent to

$$\begin{aligned}
& \mathbf{Problem (P')}: \\
& \text{minimize} \\
& \text{over } S \in [0; \bar{S}], (o_i)_{i=1:I} \in [0; T]^I, \\
& \text{subject to } \left\lfloor \frac{U'_{i,j}(S)}{T} \right\rfloor = \left\lfloor \frac{L'_{i,j}(S)}{T} \right\rfloor, \forall (i,j) \in \mathcal{L}
\end{aligned}$$

(Note that, in the above,  $L'_{i,j}, U'_{i,j}$  depend on  $o_i, o_j$ .)

Because we always have  $L'_{i,j} \leq U'_{i,j}$ , the last condition is equivalent to

$$\left\lfloor \frac{L'_{i,j}(S)}{T} \right\rfloor \geq \left\lfloor \frac{U'_{i,j}(S)}{T} \right\rfloor, \quad (55)$$

which, by Property 3 in Appendix E, is equivalent to

$$\exists k_{i,j} \in \mathbb{Z}, k_{i,j} \leq \frac{L'_{i,j}(S)}{T} \text{ and } \frac{U'_{i,j}(S)}{T} < k_{i,j} + 1. \quad (56)$$

Therefore, Problem (P') is equivalent to

$$\begin{aligned}
& \mathbf{Problem (P'')}: \\
& \text{minimize } S \quad (57) \\
& \text{over } S \in [0; \bar{S}], (o_i)_{i=1:I} \in [0; T]^I, (k_{i,j})_{(i,j) \in \mathcal{L}} \in \mathbb{Z}^{\mathcal{L}} \\
& \text{subject to} \\
& k_{i,j} \leq \frac{L'_{i,j}(S)}{T}, \frac{U'_{i,j}(S)}{T} < k_{i,j} + 1, \forall (i,j) \in \mathcal{L}
\end{aligned}$$

Because of the strict inequality in its last condition, Problem (P'') is ill-posed (its infimum might not be attained) and cannot be solved as is by MILP solvers. To circumvent this, we replace it by the following MILP, in which the strict inequality is modified to an inclusive inequality, using the same tolerance  $\varepsilon$  as before:

$$\begin{aligned}
& \mathbf{Problem (P-MILP)}: \\
& \text{minimize } S \\
& \text{over } S \in [0; \bar{S}], (o_i)_{i=1:I} \in [0; T]^I, (k_{i,j})_{(i,j) \in \mathcal{L}} \in \mathbb{Z}^{\mathcal{L}} \\
& \text{subject to} \\
& k_{i,j} \leq \frac{L'_{i,j}(S)}{T}, \frac{U'_{i,j}(S)}{T} \leq k_{i,j} + 1 - \frac{\varepsilon}{T}, \forall (i,j) \in \mathcal{L}
\end{aligned}$$

The following theorem establishes that Problem (P-MILP) provides an  $\varepsilon$ -over-approximation of the infimum of Problem (P), as required.

**Theorem 4.** *Let  $S_{\text{MILP}}$  be the optimum value of  $S$  returned by Problem (P-MILP). It is an  $\varepsilon$ -over-approximation of the value  $\underline{S}$  returned by Problem (P), i.e.  $0 \leq S_{\text{MILP}} - \underline{S} \leq \varepsilon$ . Furthermore, the values of  $S_{\text{MILP}}$  and of the offsets returned by  $S_{\text{MILP}}$  are valid.*

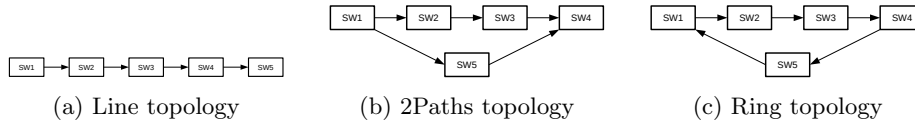

Figure 7: Three simple graphs

Table 4: Parameters used with the three topologies in Figure 7.

Constant values		
$T$	$\underline{E}$	$\epsilon$
0.001s	$6.72 * 10^{-7}$ s	$10^{-10}$

Perfect values					
$P$	$p$	$\bar{z}$	$\Delta$	$\rho$	$\eta$
0.05ms	0	0	0	1	0

Default values					
$P$	$p$	$\bar{z}$	$\Delta$	$\rho$	$\eta$
0.05ms	$0.5\mu$ s	$15\mu$ s	$1\mu$ s	1.0001	2 ns

The proof is in Appendix K.

It follows that we can use a MILP solver with Problem ( $P$ -MILP) and obtain the minimal value of the guard band  $S$  at precision  $\epsilon$ , together with the values of the offsets. Specifically, if Problem ( $P$ -MILP) is feasible, the returned value of  $S_{\text{MILP}}$  and of the offsets are valid and  $S_{\text{MILP}}$  is optimal at precision  $\epsilon$ . Note that for Problem ( $P$ ) it is not certain that the optimal value  $\underline{S}$  is valid because we don't know in general whether the infimum of Problem ( $P$ ) is attained; the last statement in the theorem recalls that such a complication may not happen with Problem ( $P$ -MILP).

## 6 Experiments

In the rest of this section, we apply the two heuristics and the MILP formulation to the three network topologies in Figure 7 and compare the corresponding optimal values of guard bands, namely,  $S_{\text{null}}$ ,  $S_{\text{prop}}$  and  $S_{\text{milp}}$ .

The parameters are described in Table 4. We vary the propagation time ( $P$ ), the jitter of the propagation ( $2p$ ), the upper bound of the switching time ( $\bar{z}$ ) and the parameters of the clocks ( $\Delta, \eta, \rho$ ). All nodes have the same parameters ( $\forall i, j, \underline{P}_{i,j} = P - p, \bar{P}_{i,j} = P + p, \Delta_i = \Delta, \eta_i = \eta, \rho_i = \rho$ ). The “perfect” values correspond to ideal clocks and negligible switching time. Except if mentioned otherwise, if a configuration is said “perfect” [resp. “default”], all parameters have the perfect [resp. default] values as in Table 4.

The time offsets are defined up to a common time shift, and we set  $o_1 = 0$  in all experiments.

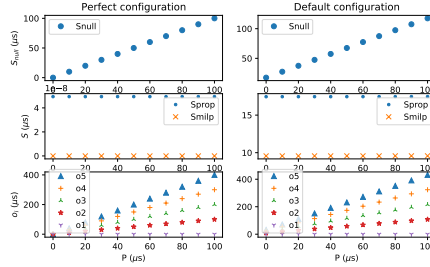

Figure 8: Exp L.1: Guard bands (upper panels) and optimal offsets (bottom panel) versus mean propagation time  $P$  (Line topology).

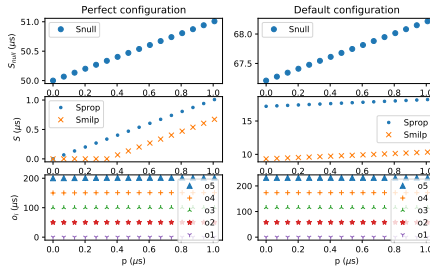

Figure 9: Exp L.2: Guard bands (upper panels) and optimal offsets (bottom panel) versus propagation jitter parameter  $p$  (Line topology).

## 6.1 Line

We start with the simple line illustrated in Figure 7a. Each experiment considers a perfect and a default configuration and varies one parameter. Figures 8 to 11 plot  $S_{\text{null}}$  (upper line),  $S_{\text{prop}}$  and  $S_{\text{milp}}$  (medium line) as well as the optimal offsets computed by the MILP (bottom line). The left row presents the perfect configuration, and the right row presents the default configuration.

- Experiment L.1, Figure 8: The propagation time  $P$  varies from 0 to 0.1ms by steps of  $10\mu\text{s}$ .

*Observations:* For the perfect configuration, the guard band with all null offsets  $S_{\text{null}}$  grows up linearly with the propagation time. In contrast, the guard bands computed by absorbing the propagation time or using the MILP are quasi null: the MILP computes null values, and the others return the tolerance  $\epsilon$ . The MILP computes the same offsets as the heuristics based on propagation absorption, setting  $o_{i+1} = o_i + P_{i+1,i}$ .

The introduction of non null jitters and imperfect clocks does not change the trends but increases the guard band values: the MILP computes a guard band  $S_{\text{milp}}$  around  $10\mu\text{s}$  whereas the propagation absorption heuristics computes  $S_{\text{prop}}$  around  $18\mu\text{s}$ . The offsets computed by the MILP are also slightly increased.

- Experiment L.2, Figure 9: The propagation jitter parameter  $p$  varies from 0 to 1.5 times  $\underline{E}$  by steps of 0.1.

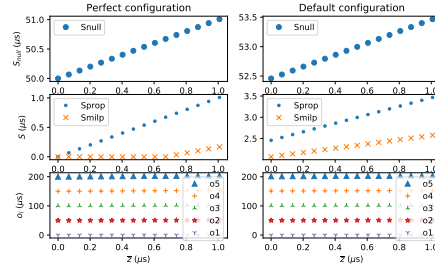

Figure 10: Exp L.3: Guard bands (upper panels) and optimal offsets (bottom panel) versus upper bound on switching delay  $\bar{z}$  (Line topology).

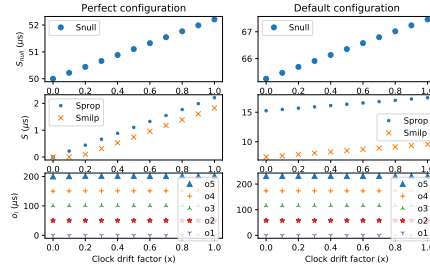

Figure 11: Exp L.4: Guard bands (upper panels) and optimal offsets (bottom panel) versus clock nonideality factor  $x$ , where  $\Delta = x\mu s$ ,  $\eta = 2xns$ ,  $\rho = 1+10^{-4}x$  (Line topology).

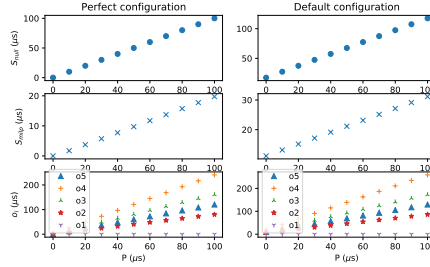

Figure 12: Exp F.1: Guard bands (upper panels) and optimal offsets (bottom panel) versus mean propagation time  $P$  (Feed-forward topology).

*Observations:* In the perfect configuration,  $S_{\text{null}}$  and  $S_{\text{prop}}$  increase linearly w.r.t. the semi-variation of the propagation  $p$ . When  $p \leq \frac{E}{2}$  the MILP solver finds a null guard band by setting  $o_{i+1} = o_i + P_{i+1,i} + p$ . But as shown by Prop. 1, if  $p > \frac{E}{2}$  which is equivalent to  $2p = \overline{P} - \overline{P} > \underline{E}$ ,  $S$  cannot be null. Then the MILP solver finds  $S = p - \frac{E}{2}$  and  $o_{i+1} = o_i + P + \frac{E}{2}$ .

For the default configuration, we also see a linear increase, but starting at higher values, as in experiment L.1.

- Experiment L.3, Figure 10: The switching time upper-bound  $\bar{z}$  varies from 0 to 1.5 times  $\underline{E}$  by steps of 0.1.

*Observations:* In the perfect configuration,  $S_{\text{null}}$  and  $S_{\text{prop}}$  increase linearly w.r.t. the maximal switching time  $\bar{z}$ . In the perfect configuration, as long as  $\bar{z} < \underline{E}$ , the MILP solver finds a null guard, by setting  $o_{i+1} = o_i + P_{i,j} + \bar{z}_j$ . But as shown by Prop. 1, if  $\bar{z} > \underline{E}$ ,  $S$  cannot be null. The choice of the offset still compensates the propagation, minus a compensation term  $o_{i+1} \approx o_i + P_{i,j} + \frac{E + \bar{z}}{2}$ .

In the default configuration, we also see a linear increase, but starting at higher values, as in experiment L.1. It appears that the slopes are not the same: the MILP solver uses the offsets values to absorb a part of the jitter.

- Experiment L.4, Figure 11: The clock quality depends on a parameter  $x$  and ranges from perfect ( $x = 0$ ) to default ( $x = 1$ ) by steps of 0.1 ( $\Delta = x\mu\text{s}$ ,  $\eta = 2x\text{ns}$ ,  $\rho = 1 + 10^{-4}x$ ).

*Observations:* Here, too, the guard band value increases linearly with same slope for all cases. The MILP solver sets  $o_{i+1} - o_i = P$  and uses the guard band value to absorb the clock imprecision. Clock nonideality adds several microseconds to the guard band but has little effect on the optimal offsets.

## 6.2 Feed-forward with two paths

We consider next the topology on Figure 7b, which has parallel paths. It follows that the propagation absorption heuristics cannot be applied: it is no longer possible to set the downstream offset as the sum of the upstream offset and the propagation time since SW4 has two upstream offsets. Therefore, in Figures 12 to 15 we compare only the values of  $S_{\text{null}}$  and  $S_{\text{milp}}$ . We vary the same factors as with the line topology.

- Experiment F.1, Figure 12: The propagation time  $P$  varies from 0 to 0.1ms by steps of  $10\mu\text{s}$ .



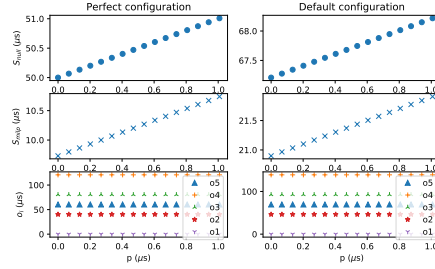

Figure 13: Exp F.2: Guard bands (upper panels) and optimal offsets (bottom panel) versus propagation jitter parameter  $p$  (Feed-forward topology).

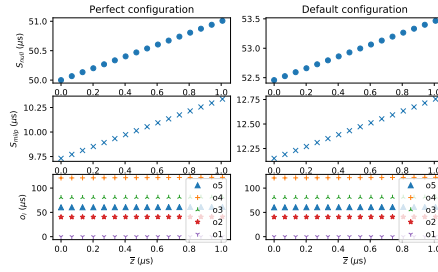

Figure 14: Exp F.3: Guard bands (upper panels) and optimal offsets (bottom panel) versus upper bound on switching delay  $z$  (Feed-forward topology).

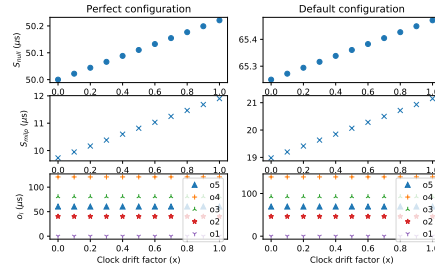

Figure 15: Exp F.4: Guard bands (upper panels) and optimal offsets (bottom panel) versus clock nonideality factor  $x$ , where  $\Delta = x\mu s$ ,  $\eta = 2xns$ ,  $\rho = 1+10^{-4}x$  (Feed-forward topology).

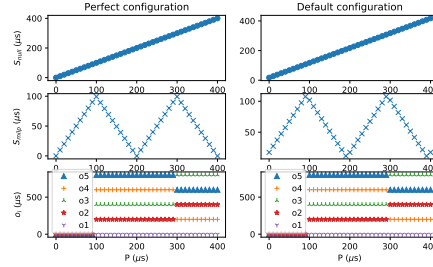

Figure 16: Exp R.1: Guard bands (upper panels) and optimal offsets (bottom panel) versus mean propagation time  $P$  (Ring topology).

*Observations:* In the perfect configuration, as with the line configuration,  $S_{\text{null}}$  increases as a linear function of  $P$ , from 0 to  $100\mu\text{s}$ . The optimal solution has  $o_{i+1} = o_i + P$  on the shortest path and distributes the offsets along the longest path. The guard band  $S_{\text{milp}}$  increases to absorb the difference, from 0 to  $20\mu\text{s}$ , and is 5 times less than with the null heuristic.

The default configuration has similar trends, but must compensate the clock imperfections.

- Experiment F.2, Figure 13: The propagation jitter parameter  $p$  varies from 0 to 1.5 times  $\underline{E}$  by steps of 0.1.

*Observations:* As with previous cases,  $S_{\text{null}}$  increases as a linear function of  $p$ . This is also the case for  $S_{\text{milp}}$ : the optimal solution uses the same strategy as in F.1, namely, the optimal offsets compensate the propagation difference between the two paths, and  $S$  is increased to absorb the propagation jitter.

- Experiment F.3, Figure 14: The switching time upper-bound  $\bar{z}$  varies from 0 to 1.5 times  $\underline{E}$  by steps of 0.1.

*Observations:* The results are very similar, except that the  $S_{\text{milp}}$  values are smaller (from  $22.25\mu\text{s}$  to  $23\mu\text{s}$ ).

- Experiment F.4, Figure 15: The clock quality depends on a parameter  $x$  and ranges from perfect ( $x = 0$ ) to default ( $x = 1$ ) by steps of 0.1 ( $\Delta = x\mu\text{s}$ ,  $\eta = 2x\text{ns}$ ,  $\rho = 1 + 10^{-4}x$ ).

*Observations :* The results are very similar to previous experiments. In particular, clock nonideality adds several microseconds to the guard band but has little effect on the optimal offsets.

### 6.3 Ring

Last, we consider the ring topology in Figure 7c, which is the simplest topology with cyclic dependencies. Here, too, the propagation absorption heuristics cannot be applied as it requires to set the downstream offset to the sum of the upstream offsets, leading to a circular condition that has no solution. Therefore, in Figures 16 to 19 we compare only the values of  $S_{\text{null}}$  and  $S_{\text{milp}}$ . We vary the same factors as with the line topology.

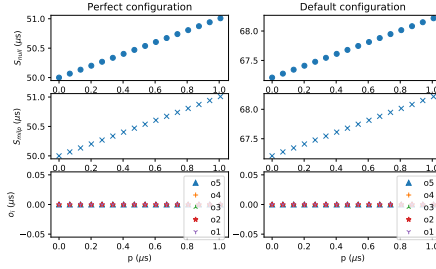

Figure 17: Exp R.2: Guard bands (upper panels) and optimal offsets (bottom panel) versus propagation jitter parameter  $p$  (Ring topology).

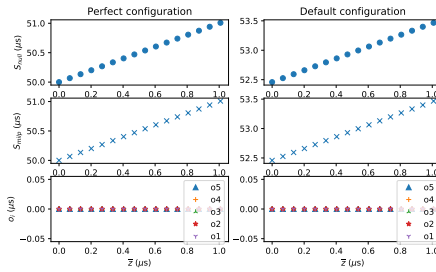

Figure 18: Exp R.3: Guard bands (upper panels) and optimal offsets (bottom panel) versus upper bound on switching delay  $\bar{z}$  (Ring topology).

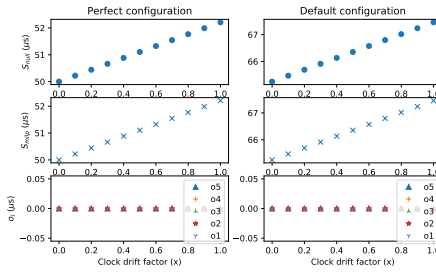

Figure 19: Exp R.4: Guard bands (upper panels) and optimal offsets (bottom panel) versus clock nonideality factor  $x$ , where  $\Delta = x\mu s$ ,  $\eta = 2xns$ ,  $\rho = 1+10^{-4}x$  (Ring topology).

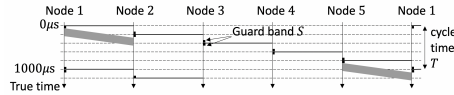

Figure 20: Ring topology: illustration of optimal offsets and guard band when the mean propagation time is  $P = 150\mu s$ , with otherwise default configuration. A frame sent by node 1 is received in the same cycle whereas a frame sent by node 5 is received in the next cycle.

- Experiment R.1, Figure 16: The propagation time  $P$  varies from 0 to 0.4ms by steps of  $10\mu s$ . The range, here, is increased to see the specific behaviour of  $S_{MILP}$ .

*Observations:* As with the previous experiments, the strategy based on null offsets creates a  $S_{null}$  that increases linearly to compensate the propagation time. When the propagation time is equal to 40% of the cycle time, 80% of the bandwidth is lost.

In contrast, the optimal value found by the MILP uses a different strategy. In the perfect configuration, when  $P \in [0; 100\mu s]$ , i.e. when  $5P \in [0; T/2]$ , the null offset is optimal and  $S_{null} = S_{milp}$ . This goes until  $5P = T/2$ , where 20% of the bandwidth is lost due to the guard band at the beginning and the end of each cycle. However, beyond this point, i.e. when  $5P \in (T/2; T]$ , the optimal solution sets  $o_{i+1} = o_i + T/5$ , i.e. the cycle time is uniformly distributed among the offsets and the guard band value decreases, down to the optimal case, when the total propagation time  $5P$  is equal to the cycle time  $T$ . Then when  $P$  increases beyond this value, the minimal guard band increases again and the process repeats. The loss of bandwidth oscillates between 0 and 20%, whereas with the null offset heuristic, it increases linearly well beyond 20% (up to a point where the null heuristic has no feasible guard band whereas the MILP solver always finds a solution.)

With the (realistic) default configuration, we see the same pattern but with some additional margin to account for the other non null parameters. It is enlightening to analyze the spatial distribution of offsets, as shown in Figure 20. Here the offsets are used to absorb the cycle time, and there is an index jump from node 5 to node 1, namely, a frame sent in cycle  $k_5$  at node 5 is received in cycle  $k_1 = k_5 + 1$  at node 1. A cycle jump does not occur when  $P \leq 100\mu s$  but always occurs beyond.

- Experiment R.2, Figure 17: The propagation jitter parameter  $p$  varies from 0 to 1.5 times  $\underline{E}$  by steps of 0.1. *Observations:* Like in previous experiments,  $S_{null}$  increases linearly to compensate the propagation jitter. The optimal solution also selects null offsets, because the sum of the propagation time is smaller than half of the period ( $5P \ll \frac{T}{2}$ ) and consequently  $S_{milp}$  also compensates the propagation jitter.
- Experiment R.3, Figure 18: The switching time upper-bound  $\bar{z}$  varies from 0 to 1.5 times  $\underline{E}$  by steps of 0.1. and  $P = 50\mu s$ . *Observations:* The results are very similar to the experiment R.2, but the guard bands are smaller in the default configuration.
- Experiment R.4, Figure 19: The clock quality depends on a parameter  $x$  and

ranges from perfect ( $x = 0$ ) to default ( $x = 1$ ) by steps of 0.1 ( $\Delta = x\mu s$ ,  $\eta = 2xns$ ,  $\rho = 1 + 10^{-4}x$ ).

*Observations:* The results are very similar to experiments R.2 and R.3. We also see that clock nonidealities add up to 15 microseconds to the guard band.

## Summary of Observations

A few lessons can be learnt from these experiments.

1. The choice of the offsets can dramatically reduce the guard band.
2. The nonideality parameters of clock, switching delay and propagation jitter affect the guard band; ignoring them leads to too small guard band.
3. In contrast, the values of the offsets are mainly influenced by topology and propagation latency, not significantly by other parameters.

## 6.4 Computing the Guard Band in Practice

We have presented 3 methods to compute the guard band:

- either setting null offsets in all nodes, and use the guard band value  $S_{\text{null}}$ , defined in eq. (45),
- or setting offsets in order to absorb the propagation time, and use the guard band value  $S_{\text{prop}}$ , defined in eq. (54),
- or use a MILP solver, presented in Problem (P-MILP).

The use of null offsets is the simplest, and can be used as long as the propagation time is small w.r.t. the cycle time (cf. (39)), but it will not give the best value since the guard band must absorb this propagation time (cf. Exp L.1, Exp F.1 and Exp R.1 presented respectively in Fig. 8, 12 and 16).

Setting offsets in order to absorb the propagation time allows to compensate this effect, but this is not possible for any topology (it is not possible if there exist two paths with different cumulated propagation times or if there are cyclic dependencies).

The last solution consist in using the MILP. One common drawback of MILP is the computation time. But thanks to its simplicity, the one presented in Problem (P-MILP) can be solved in a very short time. Each configuration presented in the experiment section is solved in less than 10ms (using `lp_solve` on a i5 /2.70GHz CPU, the `time` command returns 0.00). To challenge the computation time, we have enlarged the ring topology to consider rings from 5 to 50 nodes with step 5. Each MILP was solved in less than 80ms.

Last, there exists a minimal granularity associated with the GCL: `TickGranularity` [9, §8.6.9.4.16] and the method may compute a guard band  $S$  that is not a multiple of `TickGranularity`. But thanks to Thm. 2, if  $S$  is a solution of Thm. 1, then  $S_T = \text{TickGranularity} \left\lceil \frac{S}{\text{TickGranularity}} \right\rceil$  also is, as long as  $S_T \leq \bar{S}$ .

## 7 Related work

Several extensions of CQF have been proposed, like CQF 3-queues [15], Paternoster [16], Scalable Deterministic Forwarding (SDF, [17]) and Cycle Specified Queuing and Forwarding (CSQF, [18]). A global survey can be found in [2].

All these extensions have been designed to overcome some limitations of CQF, but it seems that all authors consider that all CQF nodes have to align their cycle time, i.e. have to share the same offset (cf. Section 5.1.1), whereas the standard does not explicitly state so.

Also note that all these extensions use 3 or even 4 queues, whereas Ethernet/TSN offers only 8 queues (or even less, depending on the implementation). Since a real-time network may have many types of traffic, each with specific requirements, the mapping from traffic types to only 8 TSN classes may become an issue [19].

While CQF offers bounded jitters ( $2T$ ), some flows requires very small jitters. For such flow, TSN allows to configure the GCLs to provide a Time-Triggered forwarding, commonly called Time Aware Shaping (TAS) [20, 21]. The Time-Aware Cyclic-Queuing (TACQ) proposes to integrate both a TAS-like mechanism and CQF on an output port by closing both CQF queues at start of cycle to allow low jitter flows to be forwarded [22]. To optimise the bandwidth usage, it would be natural to overlap this closing time and the guard band.

A comparison between CQF and CBS on an automotive use case is done by simulation in [23], but without any consideration on the guard band.

The computed bounds assume that each CQF buffer does not receive in one cycle more than what can be sent in the next cycle. The Injection Time Planning (ITP) mechanism computes the global cycle time and per-flow offsets for periodic flows in order to maximise the admissible load while satisfying this constraint [24]. The approach is generalised in [25] by adding in each End-System an “adapter” in charge of implementing the injection using a list of queues, and also by providing an online algorithm. It assumes that all offsets are equal, and the guard band only has to absorb the clock synchronization precision.

## 8 Conclusion

The expected behaviour of CQF requires some time alignments between cycles, using appropriate values of the guard band and the nodal offsets. We provided a mathematically proven method to effectively compute such values, while accounting for clock nonidealities and jitters. Illustrative case studies indicate that clock nonidealities have a non-negligible influence and should not be ignored.

## 9 Proofs

All the proofs are in the supplementary material. They can also be found in the appendix of [26].

## References

- [1] “IEEE Standard for Local and metropolitan area networks–Bridges and Bridged Networks–Amendment 29: Cyclic Queuing and Forwarding,” IEEE, IEEE Standard 802.1Qch, 2017.
- [2] A. Nasrallah, V. Balasubramanian, A. S. Thyagaturu, M. Reisslein, and H. El-Bakoury, “Cyclic queuing and forwarding for large scale deterministic networks: A survey,” *ArXiv*, vol. *abs/1905.08478*, 2019.
- [3] B. Jonsson, S. Perathoner, L. Thiele, and W. Yi, “Cyclic dependencies in modular performance analysis,” in *Proc. of the 8th Int. Conf on Embedded Software (EMSOFT’08)*. ACM Press, 2008, pp. 179–188. [Online]. Available: <http://doi.acm.org/10.1145/1450058.1450083>
- [4] D. Starobinski, M. Karpovsky, , and L. Zakrevski, “Application of Network Calculus to General Topologies using Turn-Prohibition,” in *Proceeding of the 21st Annual Joint Conference of the IEEE Computer and Communications Societies*, June 2002, pp. 411–421.
- [5] L. Thomas, J.-Y. Le Boudec, and A. Mifdaoui, “On Cyclic Dependencies and Regulators in Time-Sensitive Networks,” in *IEEE Real-Time Systems Symposium, RTSS 2019, Hong Kong, SAR, China, December 3-6, 2019*. IEEE, 2019, pp. 299–311. [Online]. Available: <https://doi.org/10.1109/RTSS46320.2019.00035>
- [6] L. Thomas and J.-Y. Le Boudec, “On time synchronization issues in time-sensitive networks with regulators and nonideal clocks,” *Proceedings of the ACM on Measurement and Analysis of Computing Systems*, vol. 4, no. 2, pp. 1–41, 2020.
- [7] A. Nasrallah, V. Balasubramanian, A. S. Thyagaturu, M. Reisslein, and H. El-Bakoury, “Cyclic queuing and forwarding for large scale deterministic networks: A survey,” *ArXiv*, vol. *abs/1905.08478*, 2019.
- [8] “IEEE standard for local and metropolitan area networks–bridges and bridged networks–amendment 28: Per-stream filtering and policing,” IEEE, Standard 802.1Qci, 2017.
- [9] “IEEE standard for local and metropolitan area networks–bridges and bridged networks–amendment 25: Enhancements for scheduled traffic,” IEEE, IEEE Standard 802.1Qbv, 2015.
- [10] D. Thiele and R. Ernst, “Formal worst-case performance analysis of time-sensitive ethernet with frame preemption,” in *2016 IEEE 21st International Conference on Emerging Technologies and Factory Automation (ETFA)*. IEEE, 2016, pp. 1–9.
- [11] N. Finn, “Mutiple Cyclic Queuing and Forwarding,” IEEE 802.1 Working Group, Tech. Rep. df-finn-multiple-CQF-0919-v01, September 2019. [Online]. Available: <https://www.ieee802.org/1/files/public/docs2019/df-finn-multiple-CQF-0919-v01.pdf>
- [12] “IEEE/ISO/IEC International Standard for Information technology–Telecommunications and information exchange between systems–Local and metropolitan area networks–Part 1AS:Timing and synchronization for time-sensitive applications in bridged local area networks, ISO/IEC/IEEE 8802-1AS:2021(E),” 2021.
- [13] AEEC, “ARINC 664 P7-1: Aircraft data network, part 7, avionics full-duplex switched ethernet network,” Airlines Electronic Engineering Committee, Tech. Rep., september 2009.

- [14] “IEEE standard for local and metropolitan area networks – bridges and bridged networks,” IEEE, IEEE Standard 802.1Q, 2018.
- [15] N. Finn, E. Mohammadpour, J. Zhang, and B. Varga, “RFC 9320 Deterministic Networking (Detnet) Bounded Latency,” 2022.
- [16] M. Seaman, “Paternoster policing and scheduling,” IEEE, Tech. Rep., May 2019, revision 2.1. [Online]. Available: <https://grouper.ieee.org/groups/802/1/files/public/docs2019/cr-seaman-paternoster-policing-scheduling-0519-v04.pdf>
- [17] L. Qiang, X. Geng, B. Liu, T. Eckert, L. Geng, and G. Li, “Large-Scale Deterministic IP Network,” IETF, Internet-Draft draft-qiang-detnet-large-scale-detnet-05, 2019. [Online]. Available: <https://datatracker.ietf.org/doc/html/draft-qiang-detnet-large-scale-detnet-05>
- [18] M. G. Chen, Gengn Xuesong, and Z. Li, “Segment Routing (SR) Based Bounded Latency,” IETF, Internet-Draft draft-chen-detnet-sr-based-bounded-latency-01, May 2019. [Online]. Available: <https://datatracker.ietf.org/doc/html/draft-chen-detnet-sr-based-bounded-latency-01>
- [19] “Time-Sensitive Networking Profile for Industrial Automation,” IEEE 802, Tech. Rep., 2021.
- [20] S. S. Craciunas, R. S. Oliver, M. Chmelfik, and W. Steiner, “Scheduling real-time communication in IEEE 802.1Qbv time sensitive networks,” in *Proceedings of the 24th International Conference on Real-Time Networks and Systems (RTNS’16)*, ser. RTNS’16. New York, NY, USA: Association for Computing Machinery, 2016, pp. 183–192. [Online]. Available: <https://doi.org/10.1145/2997465.2997470>
- [21] P.-J. Chaine and M. Boyer, “Shortening gate closing time to limit bandwidth waste when implementing Time-Triggered scheduling in TAS/TSN,” in *Proc. of the 15th Junior Researcher Workshop on Real-Time Computing*, Paris, France, 2022. [Online]. Available: [https://rtns2022.inria.fr/files/2022/06/proceedings\\_jrwrtc2022\\_final.pdf](https://rtns2022.inria.fr/files/2022/06/proceedings_jrwrtc2022_final.pdf)
- [22] Y. Huang, S. Wang, B. Wu, T. Huang, and Y. Liu, “TACQ: Enabling Zero-jitter for Cyclic-Queueing and Forwarding in Time-Sensitive Networks,” in *ICC 2021 - IEEE International Conference on Communications*, 2021, pp. 1–6.
- [23] L. Leonardi, L. L. Bello, and G. Patti, “Performance assessment of the IEEE 802.1Qch in an automotive scenario,” in *Proc. of the AEIT Int. Conf. of Electrical and Electronic Technologies for Automotive (AEIT AUTOMOTIVE)*, 2020, pp. 1–6.
- [24] J. Yan, W. Quan, X. Jiang, and Z. Sun, “Injection time planning: Making CQF practical in time-sensitive networking,” in *Proc. of the 39th IEEE Conference on Computer Communications (INFOCOM 2020)*, 2020, pp. 616–625.
- [25] W. Quan, J. Yan, X. Jiang, and Z. Sun, “On-line traffic scheduling optimization in IEEE 802.1 Qch based time-sensitive networks,” in *Proc. of the Int. Conf. on High Performance Computing and Communications; Int. Conf. on Smart City; 6th Int. Conf. on Data Science and Systems (HPCC/SmartCity/DSS)*. IEEE, 2020, pp. 369–376.
- [26] D. Guidolin-Pina, M. Boyer, and J.-Y. Le Boudec, “Configuration of Guard Band and Offsets in Cyclic Queueing and Forwarding,” Sep. 2022, working paper or preprint. [Online]. Available: <https://hal.science/hal-03772877>
- [27] J. Liebeherr *et al.*, “Duality of the max-plus and min-plus network calculus,” *Foundations and Trends® in Networking*, vol. 11, no. 3-4, pp. 139–282, 2017.



## Appendix

### A Details on implementation of CQF with PSFP and GCL

When a frame is fully received, it passes through several tests (such as CRC conformance, VLAN checking), and in particular, based on a stream id, it passes through some “filters”. The implementation of CQF consists in assigning an Internal Priority Value (IPV), defining in which queue of the output port it will be stored. The value depends on a time-driven table (“stream gate control list”). The table has a length “OperControlListLength” ( $L_s$  for short). Each entry  $i \in [0, L_s - 1]$  has a state duration “TimeInterval” ( $d_s(i)$  for short). The table has a total duration “OperCycleTime” ( $T_s$  for short), related with  $\sum_{i=0}^{L_s-1} d_s(i) = T_s$ , and a time origin “OperBaseTime” ( $O_s$  for short). For any  $i \in [0, L_s - 1]$ , let  $IPV(i)$  denotes the IPV of the  $i$ -th entry of the table. The time-based decisions are based on the clock value “CurrentTime”. We denote by  $c(t)$  the value CurrentTime at physical time  $t$ . Then, if a frame passes the PSFP filter at physical time  $t$ , it will be forwarded to the queue  $IPV(i)$  where  $i$  is the current index, *i.e.* such that  $\sum_{k=0}^{i-1} d_s(k) + iT_s \leq c(t) - O_s < \sum_{k=0}^i d_s(k) + iT_s$ , with  $k = \left\lceil \frac{c(t) - O_s}{T_s} \right\rceil$  the current cycle number. Note that there exists some delay between the output of the filtering and the arrival in this transmission queue, called in this paper “internal switching delay”, denoted with  $z$ .

A valid configuration of CQF consists in having a CQF cycle time  $T$  such that  $T_s$  is a multiple of  $2T$  (for sake of simplicity, we assume here that  $T_s = 2T$ ),  $L_s$  being even, and two dedicated queues  $q_1, q_2 \in [0, 7]$  such that  $i < n/2 \implies IPV(i) = q_1$  and  $i \geq n/2 \implies IPV(i) = q_2$ . During time intervals when  $c(t) - O_s \in [2kT, (2k+1)T)$ , called “even intervals” or “even cycle”,  $IPV(\cdot) = q_1$  and otherwise, in “odd intervals”,  $IPV(\cdot) = q_2$ .

The output port also has a discrete time-driven table, with its own “OperControlListLength”, “TimeInterval”, “OperControlListLength” and “OperBaseTime”, denoted with  $L_o, d_o, T_o$  and  $O_o$ , with the constraint that  $T_s = T_o$ , based on the same clock  $c$ . There is no IPV in this table, but a gate state, that determines if each queue is either open or closed. The standard states that “during even numbered cycles, queue 1 accumulates received frames from the Bridge’s reception Ports and does not transmit them” meaning that during even cycles, the gate of the queue 1 is closed, whereas the one of queue 2 is open, and conversely for odd cycles.

The standard clearly imposes that the input stream gate control list cycles  $T_s$  and the output port control list  $T_o$  are multiple of  $2T$ , and we can assume without loss of generality that  $T_s = T_o = 2T$ . But it does not state anything about their respective OperBaseTime,  $O_s$  and  $O_o$ . For simplicity, we will assume in this paper that all input ports and output ports of a given switch have the same OperBaseTime.

## B Proof of Equation (4)

*Proof.* The condition (3) can be also written  $t - \Delta \leq c(t) \leq t + \Delta$ , so by instantiating it twice

$$t + d - \Delta \leq c(t + d) \leq t + d + \Delta \quad (1)$$

$$\text{and } -t - \Delta \leq -c(t) \leq -t + \Delta \quad (2)$$

it comes  $d - 2\Delta \leq c(t + d) - c(t) \leq d + 2\Delta$ . □

## C Other Clock properties

**Property 1** (Clock properties). *Let  $\rho' \geq \rho \geq 1$ ,  $\eta' \geq \eta \geq 0$  and  $\Delta' \geq \Delta \geq 0$ .*

*If a clock  $c$  respects drift parameters  $(\rho, \eta)$ , and synchronization error  $\Delta$ , it also respects drift parameters  $(\rho', \eta')$ , and synchronization error  $\Delta'$ .*

*If a clock  $c$  respects drift parameters  $(\rho, \eta)$ , and synchronization error  $\Delta$ , and if  $2\Delta < \eta$ , then it also respects drift parameters  $(\rho, \Delta)$ .*

The first property ensures that if a clock has a certain quality, it also ensures a “weaker” quality.

The second property allows to assume without loss of generality that  $\eta \leq 2\Delta$ , in order to simplify the proofs.

*Proof.* Let  $\rho' \geq \rho \geq 1$ ,  $\eta' \geq \eta \geq 0$  and  $\Delta' \geq \Delta \geq 0$ .

Assume that the clock  $c$  respects drift parameters  $(\rho, \eta)$  and synchronization error  $\Delta$ . From the clock synchronization property (Equation 2) we have,  $\forall t \geq 0$ ,

$$|c(t) - t| \leq \Delta \leq \Delta'. \quad (3)$$

Then,  $\forall t, d \geq 0$ ,

$$\frac{d - \eta'}{\rho'} \leq \frac{d - \eta}{\rho} \leq c(t + d) - c(t) \leq d \cdot \rho + \eta \quad (4)$$

$$\leq d \cdot \rho' + \eta' \quad (5)$$

Consequently, it also respects drift parameters  $(\rho', \eta')$ , and synchronization error  $\Delta'$ .

Now assume that the clock  $c$  respects drift parameters  $(\rho, \eta)$ , synchronization error  $\Delta$  and  $\eta > 2\Delta$ . Thus

$$c(t+d) - c(t) \leq t+d+\Delta - (t-\Delta) \quad (6)$$

$$= d+2\Delta \quad (7)$$

$$\leq \rho \cdot d + 2\Delta \quad (8)$$

and also

$$c(t+d) - c(t) \geq \frac{d-2\Delta}{\rho} \quad (9)$$

Set  $\eta' = 2\Delta$ , then  $c$  respects drift parameters  $(\rho, \eta')$ , synchronization error  $\Delta$  and  $\eta' \leq 2\Delta$ .  $\square$

We will use the following notation in the proofs.

**Definition 1.** Let  $u, v, w, M$  be four reals. We define

$$\underline{\gamma}_{u,v,w}(M) = \max(M - 2w; \frac{M-v}{u}) \quad (10)$$

$$\bar{\gamma}_{u,v,w}(M) = \min(M + 2w; M \cdot u + v) \quad (11)$$

**Remark 1.** Let  $c$  a clock with drift parameters  $(\rho, \eta, \Delta)$  and  $(t, d) \in \mathbb{R}^+$ . Then,

$$\underline{\gamma}_{\rho,\eta,\Delta}(d) \leq c(t+d) - c(t) \leq \bar{\gamma}_{\rho,\eta,\Delta}(d) \quad (12)$$

**Property 2.** Let  $c$  a clock with drift parameters  $(\rho, \eta, \Delta)$  and  $M \in \mathbb{R}^+$ .

If  $M \leq c(t+d) - c(t)$  then  $\underline{\gamma}_{\rho,\eta,\Delta}(M) \leq d$ .

And if  $c(t+d) - c(t) \leq M$  then  $d \leq \bar{\gamma}_{\rho,\eta,\Delta}(M)$ .

*Proof.* Let  $c$  a clock with drift parameters  $(\rho, \eta, \Delta)$  and  $M \in \mathbb{R}^+$ .  $c$  respects the properties of the clock as defined in Equation 3 and Equation 2. Consequently,

$$\frac{d-\eta}{\rho} \leq c(t+d) - c(t) \leq d \cdot \rho + \eta \quad (13)$$

$$\& \quad (14)$$

$$d - 2\Delta \leq c(t+d) - c(t) \leq d + 2\Delta \quad (15)$$

If  $M \leq c(t+d) - c(t)$ , then

$$M \leq c(t+d) - c(t) \leq d \cdot \rho + \eta \quad (16)$$

$$\implies \frac{M-\eta}{\rho} \leq d \& \quad (17)$$

$$M \leq c(t+d) - c(t) \leq d + 2\Delta \quad (18)$$

$$\implies M - 2\Delta \leq d \quad (19)$$

Consequently,

$$\max\left(\frac{M-\eta}{\rho}; M - 2\Delta\right) = \underline{\gamma}_{\rho,\eta,\Delta}(M) \leq d \quad (20)$$

Similarly, if  $c(t+d) - c(t) \leq M$ , then

$$\frac{d-\eta}{\rho} \leq c(t+d) - c(t) \leq M \quad (21)$$

$$\implies d \leq M \cdot \rho + \eta \quad (22)$$

$$d - 2\Delta \leq c(t+d) - c(t) \leq M \quad (23)$$

$$\implies d \leq M + 2\Delta \quad (24)$$

Consequently,

$$d \leq \min(M \cdot \rho + \eta; M + 2\Delta) = \bar{\gamma}_{\rho, \eta, \Delta}(M) \quad (25)$$

□

## D Proof of Theorem 1 (Sufficient condition)

*Proof.* To ease expression manipulation, let  $\hat{E} = \underline{E} + S_b$  and  $\hat{T} = T - S_e$ . Also, in this proof, we drop the dependency on  $i, j$  in  $U$  and  $L$ .

Consider two frames  $F$  and  $F'$  sent by a node  $N_i$  to  $N_j$ ,  $F$  is sent before  $F'$ .

Assume that (11) holds. We will show that the nodes  $N_i$  and  $N_j$  satisfy Definition 1. Let  $t_{cl}^F, t_{wr}^F, t_{cl}^{F'}, t_{wr}^{F'}$  be the significant times of  $F$  and respectively  $F'$  as defined in Section 3, we have to show

$$\left\lfloor \frac{c_j(t_{cl}^F) - o_j}{T} \right\rfloor \% 2 = \left\lfloor \frac{c_j(t_{cl}^{F'}) - o_j}{T} \right\rfloor \% 2 \quad (26)$$

AND

$$\left\lfloor \frac{c_j(t_{wr}^F) - o_j}{T} \right\rfloor = \left\lfloor \frac{c_j(t_{wr}^{F'}) - o_j}{T} \right\rfloor \quad (27)$$

At this point, we have

$$\left\lfloor \frac{c_j(t_{cl}^F) - o_j}{T} \right\rfloor \leq \left\lfloor \frac{c_j(t_{cl}^{F'}) - o_j}{T} \right\rfloor \leq \left\lfloor \frac{c_j(t_{wr}^{F'}) - o_j}{T} \right\rfloor \quad (28)$$

$$\left\lfloor \frac{c_j(t_{cl}^F) - o_j}{T} \right\rfloor \leq \left\lfloor \frac{c_j(t_{wr}^F) - o_j}{T} \right\rfloor \leq \left\lfloor \frac{c_j(t_{wr}^{F'}) - o_j}{T} \right\rfloor \quad (29)$$

because  $F$  is sent before  $F'$  and the forwarding time is obviously earlier than the writing time. Let us first prove that  $\left\lfloor \frac{c_i(t_{cl}^F) - o_i}{T} \right\rfloor = \left\lfloor \frac{c_j(t_{wr}^{F'}) - o_j}{T} \right\rfloor$ .

1. Consider  $F$ : let  $t_{em}^F$  denote the instant when the node  $N_i$  sends the last bit of  $F$ ,  $E^F$  be the transmission time of  $F$  (the first bit being sent at time  $t_{sem}^F$  such that  $c_i(t_{em}^F) - c_i(t_{sem}^F) = E^F$ ). Let  $k$  be the cycle in which

this frame is sent. This cycle starts at time  $t_k$  such that  $c_i(t_k) - o_i = kT$  (cf. Section 3). During interval  $[t_k, t_{sem}^F)$ , other frames can be sent (higher priority ones, lower priority ones, or other CQF frames, as described in Section 2.3). But in any case,  $F$  starts its emission after the end of the opening guard band. Then

$$c_i(t_{em}^F) \geq E^F + S_b + c_i(t_k) \quad (30)$$

$$\iff c_i(t_{em}^F) - c_i(t_k) \geq \dot{E} \quad (31)$$

According to Property 2,

$$\implies \underline{\gamma}_{\rho_i, \eta_i, \Delta_i}(\dot{E}) \leq t_{em}^F - t_k \quad (32)$$

So,

$$t_{em}^F \geq t_k + \underline{\gamma}_{\rho_i, \eta_i, \Delta_i}(\dot{E}) \quad (33)$$

and  $t_{cl}^F$  denotes the instant when the frame is forwarded in the queue in  $N_j$ . So,

$$t_{em}^F + \underline{P}_{i,j} \leq t_{cl}^F \leq t_{em}^F + \bar{P}_{i,j}. \quad (34)$$

2. Consider  $F'$  : let  $t_{em}^{F'}$  denote the instant when the node  $N_i$  sends the last bit of  $F'$ . The frame is sent before the closing guard band, so

$$c_i(t_{em}^{F'}) - c_i(t_k) \leq T - S_e = \dot{T} \quad (35)$$

According to Proposition 2,

$$t_{em}^{F'} - t_k \leq \bar{\gamma}_{\rho_i, \eta_i, \Delta_i}(\dot{T}) \quad (36)$$

So,

$$t_{em}^{F'} \leq t_k + \bar{\gamma}_{\rho_i, \eta_i, \Delta_i}(\dot{T}) \quad (37)$$

and  $t_{cl}^{F'}$  denotes the instant when the frame is forwarded in the queue in  $N_j$ . So,

$$t_{em}^{F'} + \underline{P}_{i,j} \leq t_{cl}^{F'} \leq t_{em}^{F'} + \bar{P}_{i,j} \quad (38)$$

Finally,  $t_{wr}^{F'}$  denotes the instant when the frame is written in the queue in  $N_j$ ,

$$t_{cl}^{F'} + \underline{z}_j \leq t_{wr}^{F'} \leq t_{cl}^{F'} + \bar{z}_j \quad (39)$$

We can now combine (33), (34), (37) and (39) and obtain

$$t_{cl}^F \geq t_k + \underline{P}_{i,j} + \underline{\gamma}_{\rho_i, \eta_i, \Delta_i}(\dot{E}) \quad (40)$$

$$t_{wr}^{F'} \leq t_k + \bar{P}_{i,j} + \bar{z}_j + \bar{\gamma}_{\rho_i, \eta_i, \Delta_i}(\dot{T}) \quad (41)$$

The clock is increasing so

$$c_j(t_{cl}^F) \geq c_j\left(t_k + \underline{P}_{i,j} + \underline{\gamma}_{\rho_i, \eta_i, \Delta_i}(\dot{E})\right) \quad (42)$$

$$c_j(t_{wr}^{F'}) \leq c_j\left(t_k + \bar{P}_{i,j} + \bar{z}_j + \bar{\gamma}_{\rho_i, \eta_i, \Delta_i}(\dot{T})\right) \quad (43)$$

Due to clock drift, (4), we have :

$$\underline{\gamma}_{\rho_j, \eta_j, \Delta_j}(d) \leq c_j(t+d) - c_j(t) \leq \bar{\gamma}_{\rho_j, \eta_j, \Delta_j}(d) \quad (44)$$

$$c_j(t_k) + \underline{\gamma}_{\rho_j, \eta_j, \Delta_j}(d) \leq c_j(t_k+d) \leq c_j(t_k) + \bar{\gamma}_{\rho_j, \eta_j, \Delta_j}(d) \quad (45)$$

Also, we have a bound on clock error in (3),

$$-\Delta_j + t_k \leq c_j(t_k) \leq \Delta_j + t_k \quad (46)$$

$$-\Delta_i + c_i(t_k) \leq t_k \leq \Delta_i + c_i(t_k) \quad (47)$$

$$-\Delta_j - \Delta_i + c_i(t_k) \leq c_j(t_k) \leq \Delta_j + \Delta_i + c_i(t_k) \quad (48)$$

$$-\Delta_j - \Delta_i + k.T + o_i \leq c_j(t_k) \leq \Delta_j + \Delta_i + k.T + o_i \quad (49)$$

By (45) and (49)), we have

$$\begin{aligned} k.T - \Delta_j - \Delta_i + o_i + \underline{\gamma}_{\rho_j, \eta_j, \Delta_j}(d) &\leq c_j(t_k+d) \\ &\leq k.T + \Delta_j + \Delta_i + o_i + \bar{\gamma}_{\rho_j, \eta_j, \Delta_j}(d) \end{aligned} \quad (50)$$

From (40),  $t_{cl}^F \geq t_k + \dots$ , so we can apply the previous inequality to  $c_j(t_{cl}^F)$

$$c_j(t_{cl}^F) \geq \quad (51)$$

$$k \cdot T - \Delta_j - \Delta_i + o_i + \underline{\gamma}_{\rho_j, \eta_j, \Delta_j}(\underline{P}_{i,j} + \underline{\gamma}_{\rho_i, \eta_i, \Delta_i}(\dot{E})) \quad (52)$$

$$\begin{aligned} &= k \cdot T - \Delta_j - \Delta_i + o_i \\ &\quad + \max \begin{cases} (\dot{E} - \eta_i) \cdot \frac{1}{\rho_i} + \underline{P}_{i,j} - 2\Delta_j \\ \dot{E} - 2\Delta_i + \underline{P}_{i,j} - 2\Delta_j \\ ((\dot{E} - \eta_i) \cdot \frac{1}{\rho_i} + \underline{P}_{i,j} - \eta_j) \cdot \frac{1}{\rho_j} \\ (\dot{E} - 2\Delta_i + \underline{P}_{i,j} - \eta_j) \cdot \frac{1}{\rho_j} \end{cases} \quad (53) \end{aligned}$$

$$\begin{aligned} &= k \cdot T + \dot{E} + \underline{P}_{i,j} + o_i - \Delta_i - \Delta_j \\ &\quad - \min \begin{cases} \dot{E} \cdot (1 - \frac{1}{\rho_i}) + \frac{\eta_i}{\rho_i} + 2\Delta_j, \\ 2\Delta_i + 2\Delta_j, \\ \dot{E} \cdot (1 - \frac{1}{\rho_i \cdot \rho_j}) + \underline{P}_{i,j} \cdot (1 - \frac{1}{\rho_j}) + \frac{\eta_i}{\rho_i \cdot \rho_j} + \frac{\eta_j}{\rho_j}, \\ (\dot{E} + \underline{P}_{i,j}) \cdot (1 - \frac{1}{\rho_j}) + \frac{\eta_j}{\rho_j} + 2\Delta_i \cdot \frac{1}{\rho_j} \end{cases} \quad (54) \end{aligned}$$

$$= k \cdot T + L + o_j \quad (55)$$

Similarly,  $t_{wr}^{F'} \leq t_k + \dots$  and

$$c_j(t_{wr}^{F'}) \tag{56}$$

$$\leq \Delta_j + \Delta_i + k \cdot T + o_i \tag{57}$$

$$+ \bar{\gamma}_{\rho_j, \eta_j, \Delta_j} (\bar{P}_{i,j} + \bar{z}_j + \bar{\gamma}_{\rho_i, \eta_i, \Delta_i}(\dot{T}))$$

$$= \Delta_j + \Delta_i + k \cdot T + o_i$$

$$+ \min \begin{cases} \dot{T} \cdot \rho_i + \eta_i + \bar{P}_{i,j} + \bar{z}_j + 2\Delta_j \\ \dot{T} + 2\Delta_i + \bar{P}_{i,j} + \bar{z}_j + 2\Delta_j \\ \dot{T} \cdot \rho_i + \eta_i + \bar{P}_{i,j} + \bar{z}_j \cdot \rho_j + \eta_j \\ (\dot{T} + 2\Delta_i + \bar{P}_{i,j} + \bar{z}_j) \cdot \rho_j + \eta_j \end{cases} \tag{58}$$

$$= k \cdot T + \dot{T} + \bar{P}_{i,j} + \bar{z}_j + o_i + \Delta_i + \Delta_j$$

$$+ \min \begin{cases} \dot{T} \cdot (\rho_i - 1) + \eta_i + 2\Delta_j \\ 2\Delta_i + 2\Delta_j \\ \dot{T} \cdot (\rho_i \cdot \rho_j - 1) + \eta_i \cdot \rho_j + (\bar{P}_{i,j} + \bar{z}_j) \cdot (\rho_j - 1) + \eta_j \\ (\dot{T} + \bar{P}_{i,j} + \bar{z}_j) \cdot (\rho_j - 1) + \eta_j + 2\Delta_i \cdot \rho_j \end{cases} \tag{59}$$

$$= U + o_j + k \cdot T \tag{60}$$

From (28), we have

$$c_j(t_{cl}^F) \leq c_j(t_{wr}^{F'}) \tag{61}$$

From (51) to (55), we have

$$L + k \cdot T + o_j \leq c_j(t_{cl}^F) \tag{62}$$

From (56) to (60), we have

$$c_j(t_{wr}^{F'}) \leq U + k \cdot T + o_j \tag{63}$$

Consequently, as the integer part is also increasing, we have

$$k + \left\lfloor \frac{L}{T} \right\rfloor \leq \left\lfloor \frac{c_j(t_{rcl}^F) - o_j}{T} \right\rfloor \tag{64}$$

$$\leq \left\lfloor \frac{c_j(t_{wr}^{F'}) - o_j}{T} \right\rfloor \leq \left\lfloor \frac{U}{T} \right\rfloor + k \tag{65}$$

Since (11) is respected by hypothesis, it follows that  $\left\lfloor \frac{c_j(t_{cl}^F) - o_j}{T} \right\rfloor = \left\lfloor \frac{c_j(t_{wr}^{F'}) - o_j}{T} \right\rfloor$ .

Combining with (28) and (29), it follows that (26) and (27) hold, i.e., Definition 1 is satisfied. the two conditions in and the two nodes  $N_i$  and  $N_j$  are enough aligned.

Next, let  $\delta^{i,j} = \lfloor \frac{L}{T} \rfloor = \lfloor \frac{U}{T} \rfloor$ , so that

$$\left\lfloor \frac{c_j(t_{cl}^{F'}) - o_j}{T} \right\rfloor = \left\lfloor \frac{c_j(t_{wr}^{F'}) - o_j}{T} \right\rfloor = \delta_k + k \tag{66}$$

and the difference between the emission and the reception cycle is constant, equals to  $\delta^{i,j}$   $\square$

## E Proof of Property 1

We use the following property.

**Property 3.** *Let  $(a, b) \in \mathbb{R}$ , such that  $a \leq b$ . Then,*

$$(\exists k \in \mathbb{Z} \mid b < k \leq a + 1) \iff \lfloor a \rfloor = \lfloor b \rfloor \quad (67)$$

*Proof.* (1) Assume that  $\exists k \in \mathbb{Z} \mid b < k \leq a + 1$ . Thus  $k - 1 \leq a$ ; also, since  $a \leq b < k$  it comes  $a < k$ ; so,

$$k - 1 \leq a < k \quad (68)$$

by definition of the floor function,

$$\lfloor a \rfloor = k - 1 \quad (69)$$

Also, we have  $k - 1 \leq a \leq b$  and  $b < k$  So,

$$k - 1 \leq b < k \quad (70)$$

by definition of the floor function,

$$\lfloor b \rfloor = k - 1 \quad (71)$$

Consequently,  $\lfloor a \rfloor = \lfloor b \rfloor$ .

(2) Conversely, assume that  $\lfloor a \rfloor = \lfloor b \rfloor$  and let  $\lfloor a \rfloor = \lfloor b \rfloor = m$ ,  $m \in \mathbb{Z}$ . From the definition of the floor function, it follows that  $m \leq a$  and  $b < m + 1$ . Thus  $b < m + 1 \leq a + 1$ , i.e.  $\exists k \in \mathbb{Z} \mid b < k \leq a + 1$ .  $\square$

*Proof of Property 1.* Assume that  $S$  satisfies the condition in Theorem 1. Then, we have  $\lfloor \frac{L}{T} \rfloor = \lfloor \frac{U}{T} \rfloor$ . We know that  $\frac{L}{T} \leq \frac{U}{T}$ , so according to the Proposition 3, we have

$$\exists k \in \mathbb{Z} : U < k \cdot T \leq L + T \quad (72)$$

It follows that, necessarily,  $U < L + T$ . Therefore

$$\begin{aligned} T - S + \overline{P}_{i,j} + \overline{z}_{i,j} + o_i + o_j + \Delta_i + \Delta_j + \widehat{u}(S) \\ < S + \underline{E} + \underline{P}_{i,j} + o_i + o_j - \Delta_i - \Delta_j - \widehat{l}(S) + T \end{aligned} \quad (73)$$

and thus

$$\overline{P}_{i,j} - \underline{P}_{i,j} + \overline{z}_{i,j} - \underline{E} + 2(\Delta_i + \Delta_j) + \widehat{u}(S) + \widehat{l}(S) < 2S \quad (74)$$

$$S > \frac{\overline{P}_{i,j} - \underline{P}_{i,j} + \overline{z}_{i,j} - \underline{E} + \widehat{l}(S) + \widehat{u}(S)}{2} + \Delta_i + \Delta_j \quad (75)$$

$$\geq \frac{\overline{P}_{i,j} - \underline{P}_{i,j} + \overline{z}_{i,j} - \underline{E} + \widehat{l}(0) + \widehat{u}(\overline{S})}{2} + \Delta_i + \Delta_j \quad (76)$$

$$\geq \frac{\overline{P}_{i,j} - \underline{P}_{i,j} + \overline{z}_{i,j} - \underline{E}}{2} + \Delta_i + \Delta_j \quad (77)$$



because  $S \in [0, \bar{S}]$ ,  $\hat{l}$  is decreasing and  $\hat{u}$  is decreasing.  $\square$

Note that a slightly better lower bound can be found by using (76) instead of  $\underline{\underline{S}}^{i,j}$ . In this paper, we found that this did not bring significant improvements and was not worth the added complexity.

## F Proof of Corollary 1

*Proof.* In this proof, we drop the dependency on  $i, j$  in  $U$  and  $L$ .  $\hat{l}$  is increasing and  $\hat{u}$  is decreasing, thus

$$-\hat{l}(\bar{S}) \leq -\hat{l}(S) \text{ \& } \hat{u}(S) \leq \hat{u}(\underline{S}) \quad (78)$$

$$L'(S) \leq L(S) \text{ \& } U(S) \leq U'(S) \quad (79)$$

$$L'(S) \leq L(S) \leq U(S) \leq U'(S) \quad (80)$$

Consequently,

$$\left\lfloor \frac{L'}{T} \right\rfloor = \left\lfloor \frac{U'}{T} \right\rfloor \implies \left\lfloor \frac{L}{T} \right\rfloor = \left\lfloor \frac{U}{T} \right\rfloor \quad (81)$$

$\square$

## G Proof of Theorem 2

*Proof.* Let  $S$  be a solution of Theorem 1 for given parameters  $(o_i, o_j, P, p, \bar{z}, \rho, \eta, \Delta)$ . First, we prove that  $\forall s \in [S; \bar{S}]$ ,  $s$  is also a solution *i.e.*, the set of solution is an interval.

According to Property 3, the solution of Theorem 1 are

$$S \mid \exists k \in \mathbb{Z} \text{ such that } U(S, o_i, o_j) < k.T \leq L(S, o_i, o_j) + T \quad (82)$$

But,  $U$  is an decreasing function of  $S$  and  $L$  a increasing function of  $S$ . Consequently, for all  $s > S$ ,  $U(s) \leq U(S)$  and  $L(S) \leq L(s)$  and

$$\begin{aligned} U(s, o_i, o_j) &\leq U(S, o_i, o_j) < k.T \\ &\leq L(S, o_i, o_j) + T \leq L(s, o_i, o_j) + T \end{aligned} \quad (83)$$

Then, if  $S$  is a solution of Theorem 1, then  $s \geq S$  is also a solution and  $s$  is bounded by  $\bar{S}$ .

Then, let  $\mathcal{S}_{\text{thm1}}^{o_i, o_j}$  be the set of values of  $S \in [0, \bar{S}]$  that satisfy the sufficient condition (11) in Theorem 1.

- If  $\bar{S}$  satisfies (11),  $\mathcal{S}_{\text{thm1}}^{o_i, o_j}$  is obviously not empty because  $\bar{S} \in \mathcal{S}_{\text{thm1}}^{o_i, o_j}$ .
- If  $\mathcal{S}_{\text{thm1}}^{o_i, o_j}$  is not empty,  $\exists S \in \mathcal{S}_{\text{thm1}}^{o_i, o_j}$  and  $\forall s \geq S, S \in \mathcal{S}_{\text{thm1}}^{o_i, o_j}$ .  $\bar{S} \geq S$ , then  $\bar{S} \in \mathcal{S}_{\text{thm1}}^{o_i, o_j}$ .

- If  $\mathcal{S}_{\text{thm1}}^{o_i, o_j}$  is not empty, it is an interval. Then, it exists  $\underline{S}_{\text{thm1}}^{o_i, o_j}$ , the infimum value such that

$$\mathcal{S}_{\text{thm1}}^{o_i, o_j} = |\underline{S}_{\text{thm1}}^{o_i, o_j} ; \bar{S}| \quad (84)$$

where  $|$  means  $[$  or  $($ .

- By binary search, we can find  $S_{\text{thm1}}^{*o_i, o_j}$  the smallest value of  $S \in \mathcal{S}_{\text{thm1}}^{o_i, o_j}$  with precision  $\varepsilon$ . Then,

$$S_{\text{thm1}}^{*o_i, o_j} = \underline{S}_{\text{thm1}}^{o_i, o_j} + \varepsilon. \quad (85)$$

$S_{\text{thm1}}^{*o_i, o_j}$  is an  $\varepsilon$ -approximation of  $\underline{S}_{\text{thm1}}^{o_i, o_j}$ . Moreover,

$$|\underline{S}_{\text{thm1}}^{o_i, o_j} ; \bar{S}| = |\underline{S}_{\text{thm1}}^{o_i, o_j} ; S_{\text{thm1}}^{*o_i, o_j} \cup [S_{\text{thm1}}^{*o_i, o_j} ; \bar{S}] \quad (86)$$

$$= |\underline{S}_{\text{thm1}}^{o_i, o_j} ; \underline{S}_{\text{thm1}}^{o_i, o_j} + \varepsilon \cup [S_{\text{thm1}}^{*o_i, o_j} ; \bar{S}] \quad (87)$$

$|\underline{S}_{\text{thm1}}^{o_i, o_j} ; \underline{S}_{\text{thm1}}^{o_i, o_j} + \varepsilon|$  is of length  $\varepsilon$  hence  $[S_{\text{thm1}}^{*o_i, o_j} ; \bar{S}]$  is an  $\varepsilon$ -approximation of  $\mathcal{S}_{\text{thm1}}^{o_i, o_j}$ .

□

## H Proof of Property 2

*Proof.* Let  $(\rho_i, \eta_i, \Delta_i)$  be the clock quality parameters of a clock  $c$  and  $(\rho'_i, \eta'_i, \Delta'_i)$  the clock quality parameters of a clock  $c'$  better than  $c$ , where better means  $\rho'_i \leq \rho_i, \eta'_i \leq \eta_i, \Delta'_i \leq \Delta_i, \rho'_j \leq \rho_j, \eta'_j \leq \eta_j, \Delta'_j \leq \Delta_j$ . If  $c'$  respects the better clock quality parameters then  $\forall (t, d) \in \mathbb{R}^+$ ,

$$\frac{d - \eta_i}{\rho_i} \leq \frac{d - \eta'_i}{\rho'_i} \leq c(t + d) - c(t) \leq d \cdot \rho'_i + \eta'_i \leq d \cdot \rho_i + \eta_i \quad (88)$$

And  $\forall t \in \mathbb{R}^+$

$$|c'(t) - t| \leq \Delta'_i \leq \Delta_i \quad (89)$$

Consequently,  $c'$  respects also the clock quality parameters of  $c$ . □

## I Proof of Theorem 3 (Necessary condition)

As introduced in the sketch of proof, the principle of the proof is to build a valid trajectory with a first frame  $F$  sent by  $N_i$  just after the opening guard band, a second frame  $F'$  whose last bit is sent just before the closing guard band, and two clocks designed to maximize the distance between the values between of reception of these two frames.

The main complexity is to build the clock trajectories. To this end, we first build elementary clock patterns, next we combine them into two feasible adversary clock trajectories.

## I.1 Elementary Clock Patterns

We need the following technical result:

**Property 4.** *Let  $a, a'$  be two positive real numbers and  $b, b'$  be real numbers. For any  $x, y \in \mathbb{R}$ ,*

$$y = \min(ax + b, a'x + b') \iff x = \max\left(\frac{y - b}{a}, \frac{y - b'}{a'}\right) \quad (90)$$

*Proof.* Let  $F : \mathbb{R} \rightarrow \mathbb{R}$ ,  $x \mapsto ax + b$  and  $G : \mathbb{R} \rightarrow \mathbb{R}$ ,  $x \mapsto a'x + b'$ .  $F$ ,  $G$  and  $\min(F, G)$  are increasing, their upper-pseudo inverses are their regular inverses and, by [26, Theorem 10.3 (a)], the inverse of  $\min(F, G)$  is  $\max(F^{-1}, G^{-1})$ .  $\square$

We now introduce two elementary clock patterns, the former is fast then slow, the latter is slow then fast.

**Property 5** (Feasible Clock Patterns). *Let  $\rho \geq 1$ ,  $\eta \geq 0$  and  $\Delta \geq 0$ , such that  $\eta \leq 2\Delta$ : Define the functions  $e_{\rho, \eta, \Delta}, e'_{\rho, \eta, \Delta} : \mathbb{R} \rightarrow \mathbb{R}$  by*

$$e_{\rho, \eta, \Delta}(x) = \begin{cases} \max\{x - \Delta, \rho x + \Delta - \eta\} & \text{if } x < 0 \\ \max\{x - \Delta, \frac{x}{\rho} + \Delta\} & \text{if } x \geq 0 \end{cases} \quad (91)$$

$$e'_{\rho, \eta, \Delta}(x) = \begin{cases} \min\{x + \Delta, \frac{x}{\rho} - \Delta\} & \text{if } x < 0 \\ \min\{x + \Delta, \rho x - \Delta + \eta\} & \text{if } x \geq 0 \end{cases} \quad (92)$$

*Then, the functions  $e_{\rho, \eta, \Delta}, e'_{\rho, \eta, \Delta}$  respect the clock properties presented in (2) and (3).*

*Moreover, for any  $y < \Delta - \eta$  or  $y \geq \Delta$ , there exists a unique  $x$  such that  $e_{\rho, \eta, \Delta}(x) = y$ . In the following, it will be denoted by  $e_{\rho, \eta, \Delta}^{-1}(y)$ . Also, for any  $y \leq -\Delta$  or  $y > \eta - \Delta$ , there exists a unique  $x$  such that  $e'_{\rho, \eta, \Delta}(x) = y$ . In the following, it will be denoted by  $e'_{\rho, \eta, \Delta}{}^{-1}(y)$ . We have:*

$$e_{\rho, \eta, \Delta}^{-1}(y) = \begin{cases} \min\left\{y + \Delta, \frac{y - \Delta + \eta}{\rho}\right\} & \text{if } y < \Delta - \eta \\ \min\{y + \Delta, \rho(y - \Delta)\} & \text{if } y \geq \Delta - \eta \end{cases} \quad (93)$$

$$e'_{\rho, \eta, \Delta}{}^{-1}(y) = \begin{cases} \min\{y - \Delta, \rho(y + \Delta)\} & \text{if } y < -\Delta \\ \min\left\{y - \Delta, \frac{y + \Delta - \eta}{\rho}\right\} & \text{if } y \geq -\Delta + \eta \end{cases} \quad (94)$$

An illustration is provided in Figures 1 and 2.

*Proof that patterns respects clock conditions.* We need to show that the two clock patterns satisfy (2) and (3).

(i) Let us start with (3), i.e., we have to show that  $\forall t \in \mathbb{R}, |e_{\rho, \eta, \Delta}(t) - t| \leq \Delta$ .

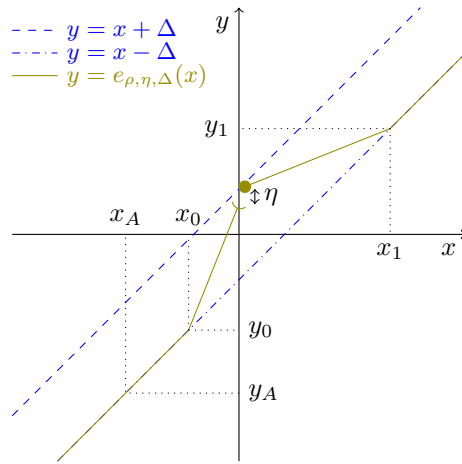

Figure 1: Clock pattern  $e_{\rho, \eta, \Delta}$  (fast then slow).

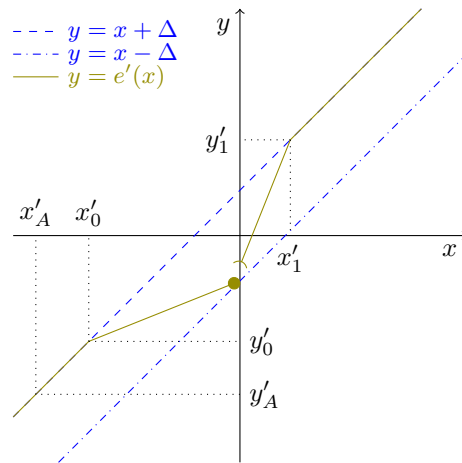

Figure 2: Clock pattern  $e'_{\rho, \eta, \Delta}$  (slow then fast).

	$t \leq x_0$	$x_0 \leq t \leq 0$	$0 \leq t \leq x_1$	$x_1 \leq t$
$t + d \leq x_0$	1	X	X	X
$x_0 \leq t + d \leq 0$	2	5	X	X
$0 \leq t + d \leq x_1$	3	6	8	X
$x_1 \leq t + d$	4	7	9	10

Table 1: Cases for item (ii).

1. If  $t \in \mathbb{R}^+$  :

$$e_{\rho,\eta,\Delta}(t) - t = \max \left\{ t - \Delta, \frac{t}{\rho} + \Delta \right\} - t \quad (95)$$

$$= \max \left\{ -\Delta, \left( \frac{1}{\rho} - 1 \right) \cdot t + \Delta \right\} \quad (96)$$

It follows that  $e_{\rho,\eta,\Delta}(t) - t \geq -\Delta$ . But  $\frac{1}{\rho} \leq 1$  and  $t \geq 0$  so  $(\frac{1}{\rho} - 1) \cdot t + \Delta \leq \Delta$  and thus  $e_{\rho,\eta,\Delta}(t) - t \leq \Delta$ .

2. If  $t \in \mathbb{R}^-$  :

$$e_{\rho,\eta,\Delta}(t) - t = \max \{ t - \Delta, t \cdot \rho + \Delta - \eta \} - t \quad (97)$$

$$= \max \{ -\Delta, t \cdot (\rho - 1) + \Delta - \eta \} \quad (98)$$

It follows that  $e_{\rho,\eta,\Delta}(t) - t \geq -\Delta$ . But,  $\rho \geq 1$ ,  $\eta \geq 0$  and  $t \leq 0$  so  $t \cdot (\rho - 1) + \Delta - \eta \leq \Delta$  and  $e_{\rho,\eta,\Delta}(t) - t \leq \Delta$ .

Thus  $\forall t \in \mathbb{R}, |e_{\rho,\eta,\Delta}(t) - t| \leq \Delta$ .

(ii) Let us now show that (3) holds for  $e_{\rho,\eta,\Delta}$ , i.e we have to show that, for all  $t, d \geq 0$ :

$$(d - \eta) \cdot \frac{1}{\rho} \leq e_{\rho,\eta,\Delta}(t + d) - e_{\rho,\eta,\Delta}(t) \leq d \cdot \rho + \eta$$

Let  $x_0 = \frac{2\Delta - \eta}{1 - \rho} < 0$  and  $x_1 = 2\Delta \cdot \frac{\rho}{\rho - 1} > 0$  (see Figure 1). We consider all possible cases, depending on the positions of  $t$  and  $t + d$  with respect to  $x_0$ , 0 and  $x_1$ . Since  $d \geq 0$ , we obtain 10 cases, numbered as in Table 1.

1. if  $t \in [-\infty; x_0]$  and  $t + d \in [-\infty; x_0]$  :

$$e_{\rho,\eta,\Delta}(t + d) - e_{\rho,\eta,\Delta}(t) \quad (99)$$

$$= t + d - \Delta - (t - \Delta) = d \quad (100)$$

Thus,  $(d - \eta) \cdot \frac{1}{\rho} \leq e_{\rho,\eta,\Delta}(t + d) - e_{\rho,\eta,\Delta}(t) \leq d \cdot \rho + \eta$

2. if  $t \in [-\infty; x_0]$  and  $t + d \in [x_0; 0]$  :

$$e_{\rho,\eta,\Delta}(t+d) - e_{\rho,\eta,\Delta}(t) \quad (101)$$

$$= e_{\rho,\eta,\Delta}(t+d) - e_{\rho,\eta,\Delta}(x_0) + e_{\rho,\eta,\Delta}(x_0) - e_{\rho,\eta,\Delta}(t) \quad (102)$$

$$= (t+d-x_0) \cdot \rho - (t-x_0) \quad (103)$$

$$= (\rho-1) \cdot t + d \cdot \rho + 2\Delta - \eta \quad (104)$$

But  $(t+d-x_0) \cdot \rho - (t-x_0) \geq \frac{(t+d-x_0)}{\rho} - \frac{(t-x_0)}{\rho} = \frac{d}{\rho} \geq \frac{d-\eta}{\rho}$  because  $t-x_0 \leq 0$  and  $\rho \geq 1, \eta \geq 0$ .

Also,  $(\rho-1) \cdot t + d \cdot \rho + 2\Delta - \eta \leq (\rho-1) \cdot x_0 + d \cdot \rho + 2\Delta - \eta = d \cdot \rho \leq d \cdot \rho + \eta$ .

Thus  $\frac{d-\eta}{\rho} \leq e_{\rho,\eta,\Delta}(t+d) - e_{\rho,\eta,\Delta}(t) \leq d \cdot \rho + \eta$

3. if  $t \in [-\infty; x_0]$  and  $t + d \in [0, x_1]$  :

$$e_{\rho,\eta,\Delta}(t+d) - e_{\rho,\eta,\Delta}(t) \quad (105)$$

$$= e_{\rho,\eta,\Delta}(t+d) - e_{\rho,\eta,\Delta}(x_0) + e_{\rho,\eta,\Delta}(x_0) - e_{\rho,\eta,\Delta}(t) \quad (106)$$

$$= (t+d-x_0) \cdot \frac{1}{\rho} - (t-x_0) \quad (107)$$

As previously,  $(t+d-x_0) \cdot \rho - (t-x_0) \geq \frac{d-\eta}{\rho}$  because  $t-x_0 \leq 0$  and  $\rho \geq 1, \eta \geq 0$ .

Then,  $(t+d-x_0) \cdot \rho - (t-x_0) \leq (t+d-x_0) \cdot \rho - (t-x_0) \cdot \rho = d \cdot \rho \leq d \cdot \rho + \eta$  because  $t-x_0 \leq 0$  and  $\rho \geq 1, \eta \geq 0$ .

Thus  $\frac{d-\eta}{\rho} \leq e_{\rho,\eta,\Delta}(t+d) - e_{\rho,\eta,\Delta}(t) \leq d \cdot \rho + \eta$

4. if  $t \in [-\infty; x_0]$  and  $t + d \in [x_1, +\infty]$  :

$$e_{\rho,\eta,\Delta}(t+d) - e_{\rho,\eta,\Delta}(t) \quad (108)$$

$$= t+d-\Delta - (t-\Delta) \quad (109)$$

$$= d \quad (110)$$

Thus  $(d-\eta) \cdot \frac{1}{\rho} \leq e_{\rho,\eta,\Delta}(t+d) - e_{\rho,\eta,\Delta}(t) \leq d \cdot \rho + \eta$

5. if  $t \in [x_0; 0]$  and  $t + d \in [x_0; 0]$  :

$$e_{\rho,\eta,\Delta}(t+d) - e_{\rho,\eta,\Delta}(t) \quad (111)$$

$$= (t+d) \cdot \rho + \Delta - \eta - (t \cdot \rho + \Delta - \eta) \quad (112)$$

$$= d \quad (113)$$

Thus,  $(d-\eta) \cdot \frac{1}{\rho} \leq e_{\rho,\eta,\Delta}(t+d) - e_{\rho,\eta,\Delta}(t) \leq d \cdot \rho + \eta$

6. if  $t \in [x_0; 0]$  and  $t + d \in [0, x_1]$  :

$$e_{\rho, \eta, \Delta}(t + d) - e_{\rho, \eta, \Delta}(t) \quad (114)$$

$$= e_{\rho, \eta, \Delta}(t + d) - e_{\rho, \eta, \Delta}(0) + e_{\rho, \eta, \Delta}(0) - e_{\rho, \eta, \Delta}(t) \quad (115)$$

$$= (t + d) \cdot \frac{1}{\rho} + \Delta - \Delta + \Delta - (t \cdot \rho + \Delta - \eta) \quad (116)$$

$$= (t + d) \cdot \frac{1}{\rho} - (t \cdot \rho - \eta) \quad (117)$$

$$= \left(\frac{1}{\rho} - \rho\right) \cdot t + d \cdot \frac{1}{\rho} + \eta \quad (118)$$

But  $\left(\frac{1}{\rho} - \rho\right) \cdot t + d \cdot \frac{1}{\rho} + \eta \geq d \cdot \frac{1}{\rho} + \eta \geq \frac{d - \eta}{\rho}$  because  $\frac{1}{\rho} - \rho \leq 0$  and  $t \geq x_0$ .

Also,  $(t + d) \cdot \frac{1}{\rho} - (t \cdot \rho - \eta) \leq (t + d) \cdot \rho - (t \cdot \rho - \eta) = d \cdot \rho + \eta$ .

Thus  $(d - \eta) \cdot \frac{1}{\rho} \leq e_{\rho, \eta, \Delta}(t + d) - e_{\rho, \eta, \Delta}(t) \leq d \cdot \rho + \eta$

7. if  $t \in [x_0; 0]$  and  $t + d \in [x_1, +\infty]$  :

$$e_{\rho, \eta, \Delta}(t + d) - e_{\rho, \eta, \Delta}(t) \quad (119)$$

$$e_{\rho, \eta, \Delta}(t + d) - e_{\rho, \eta, \Delta}(x_1) + e_{\rho, \eta, \Delta}(x_1) - e_{\rho, \eta, \Delta}(t) \quad (120)$$

$$= t + d - \Delta - (x_1 - \Delta) + \left(x_1 \cdot \frac{1}{\rho} + \Delta\right) - (t \cdot \rho + \Delta - \eta) \quad (121)$$

$$= t + d - x_1 - (t \cdot \rho - x_1 \cdot \frac{1}{\rho} - \eta) \quad (122)$$

$$= (1 - \rho) \cdot t + d - 2\Delta + \eta \quad (123)$$

But,  $(1 - \rho) \cdot t + d - 2\Delta + \eta \leq (1 - \rho) \cdot x_0 + d - 2\Delta + \eta = d \leq d \cdot \rho + \eta$  because  $t \geq x_1$  and  $1 - \rho \leq 0$ .

Also,  $t + d - x_1 - (t \cdot \rho - x_1 \cdot \frac{1}{\rho} - \eta) \geq (t + d - x_1) \cdot \frac{1}{\rho} - (t \cdot \frac{1}{\rho} - x_1 \cdot \frac{1}{\rho} - \eta \cdot \frac{1}{\rho}) = (d + \eta) \cdot \frac{1}{\rho} \geq (d - \eta) \cdot \frac{1}{\rho}$ .

Thus  $(d - \eta) \cdot \frac{1}{\rho} \leq e_{\rho, \eta, \Delta}(t + d) - e_{\rho, \eta, \Delta}(t) \leq d \cdot \rho + \eta$

8. if  $t \in [0, x_1]$  and  $t + d \in [0, x_1]$  :

$$e_{\rho, \eta, \Delta}(t + d) - e_{\rho, \eta, \Delta}(t) \quad (124)$$

$$= (t + d) \cdot \frac{1}{\rho} + \Delta - \left(t \cdot \frac{1}{\rho} + \Delta\right) \quad (125)$$

$$= d \quad (126)$$

Thus  $(d - \eta) \cdot \frac{1}{\rho} \leq e_{\rho, \eta, \Delta}(t + d) - e_{\rho, \eta, \Delta}(t) \leq d \cdot \rho + \eta$

9. if  $t \in [0, x_1]$  and  $t + d \in [x_1, +\infty]$  :

$$e_{\rho, \eta, \Delta}(t + d) - e_{\rho, \eta, \Delta}(t) \quad (127)$$

$$= e_{\rho, \eta, \Delta}(t + d) - e_{\rho, \eta, \Delta}(x_1) + e_{\rho, \eta, \Delta}(x_1) - e_{\rho, \eta, \Delta}(t) \quad (128)$$

$$= t + d - x_1 - (t - x_1) \cdot \frac{1}{\rho} \quad (129)$$

$$= \left(1 - \frac{1}{\rho}\right) \cdot t + d - 2\Delta \quad (130)$$

But,  $t + d - x_1 - (t - x_1) \cdot \frac{1}{\rho} \geq \frac{t+d-x_1}{\rho} - \frac{t-x_1}{\rho} = \frac{d}{\rho} \geq \frac{d-\eta}{\rho}$  because  $t + d - x_1 \geq 0$ .

Also,  $\left(1 - \frac{1}{\rho}\right) \cdot t + d - 2\Delta \leq \left(1 - \frac{1}{\rho}\right) \cdot x_1 + d - 2\Delta = d \leq d \cdot \rho + \eta$  because  $t \leq x_1 = 2\Delta \cdot \frac{\rho}{\rho-1}$ .

Thus  $(d - \eta) \cdot \frac{1}{\rho} \leq e_{\rho, \eta, \Delta}(t + d) - e_{\rho, \eta, \Delta}(t) \leq d \cdot \rho + \eta$

10. if  $t \in [x_1, +\infty]$  and  $t + d \in [x_1, +\infty]$  :

$$e_{\rho, \eta, \Delta}(t + d) - e_{\rho, \eta, \Delta}(t) \quad (131)$$

$$= t + d - \Delta - (t - \Delta) \quad (132)$$

$$= d \quad (133)$$

Thus  $(d - \eta) \cdot \frac{1}{\rho} \leq e_{\rho, \eta, \Delta}(t + d) - e_{\rho, \eta, \Delta}(t) \leq d \cdot \rho + \eta$

This shows that the clock pattern  $e_{\rho, \eta, \Delta}$  satisfies (3).

(iii) The proof is similar for the opposite clock  $e'_{\rho, \eta, \Delta}$ .

(iv) (93) and (94) follow from Prop. 4. □

## I.2 Feasible Clock Trajectories

We now show how to use the elementary clock pattern to construct clock patterns with specific constraints. The first ingredient is time shifting.

**Property 6** (Shifted Clock). *Let  $c$  be a clock respecting clock parameters  $(\rho, \eta, \Delta)$ . The function  $c'$  defined by  $c'(t) = c(t - t') + t'$  is also a clock and respects clock parameters  $(\rho, \eta, \Delta)$ .*

*Proof.* Since  $c'$  is obviously wide-sense increasing, all we need to prove is that  $c'$  respects (2) and (3).

$\forall t, d \geq 0,$

$$c'(t + d) - c'(t) = c(t - t' + d) + t' - c(t - t') - t' \quad (134)$$

$$= c(t - t' + d) - c(t - t') = c(x + d) - c(x) \quad (135)$$

with  $x = t - t'$  As  $c$  respects (2), we have :  $\frac{d-\eta}{\rho} \leq c(x + d) - c(x) = c'(t + d) - c'(t) \leq d \cdot \rho + \eta$  i.e.  $c'$  respects (2).



Next, for  $t \geq 0$ ,

$$c'(t) - t = c(t - t') - (t - t') \leq \Delta \quad (136)$$

by application of (3) to  $c$  and  $t - t'$ .  $\square$

We will apply time shifting to the elementary clock patterns in Prop. 5. More specifically, the application to  $e_{\rho, \eta, \Delta}$  leads to the following.

**Property 7** (Feasible Clock Trajectory). *Let  $\rho \geq 1$  and  $2\Delta \geq \eta \geq 0$ . For any  $A > \eta$ ,  $B, t_0 \geq 0$ , there exists a clock  $c$  that respects parameters  $\rho, \eta, \Delta$  in (2) and (3) and two time instants  $t_1, t_2$  such that*

$$c(t_1) - c(t_0) = A \quad (137)$$

$$c(t_2) - c(t_1) = B \quad (138)$$

Furthermore, we can take

$$c(t_0) = t_0 + \Delta - A - \min \left\{ 2\Delta - A, (\eta - A) \cdot \frac{1}{\rho} \right\} \quad (139)$$

$$t_1 = t_0 - \min \left\{ 2\Delta - A, (\eta - A) \cdot \frac{1}{\rho} \right\} \quad (140)$$

$$t_2 = t_1 + \min \{ 2\Delta + B, B \cdot \rho \} \quad (141)$$

*Proof.* We use the clock pattern  $e_{\rho, \eta, \Delta}$  in Prop. 5 and shift it using Prop. 6. Let

$$y_A = \Delta - A, \quad x_A = e_{\rho, \eta, \Delta}^{-1}(y_A) \quad (142)$$

$$y_B = \Delta + B \quad x_B = e_{\rho, \eta, \Delta}^{-1}(y_B) \quad (143)$$

$$t_1 = t_0 - x_A, \quad t_2 = t_1 + x_B \quad (144)$$

(since  $A > \eta$ ,  $x_A$  exists) and consider the clock defined by

$$c : t \mapsto e_{\rho, \eta, \Delta}(t - t_1) + t_1 \quad (145)$$

$$\text{Then, } c(t_0) = e_{\rho, \eta, \Delta}(t_0 - t_1) + t_1 \quad (146)$$

$$= e_{\rho, \eta, \Delta}(t_0 - (t_0 - x_A)) + (t_0 - x_A) \quad (147)$$

$$= e_{\rho, \eta, \Delta}(x_A) + t_0 - x_A \quad (148)$$

and since  $x_A = e_{\rho, \eta, \Delta}^{-1}(y_A)$

$$c(t_0) = y_A + t_0 - x_A = \Delta - A + t_0 - x_A \quad (149)$$

To expand the value of  $x_A$ , use eq. (93). Since  $A > \eta$ ,  $y_A < \Delta - \eta$  and

$$x_A = \min \left\{ y_A + \Delta, \frac{y_A - \Delta + \eta}{\rho} \right\} \quad (150)$$

$$= \min \left\{ 2\Delta - A, \frac{-A + \eta}{\rho} \right\} \quad (151)$$

To expand the value of  $x_B$ , use also eq. (93), but  $B \geq 0 \implies y_B \geq \Delta \geq \Delta - \eta$  and

$$x_B = \min \{y_B + \Delta, \rho(y_B - \Delta)\} \quad (152)$$

$$= \min \{2\Delta + B, \rho \cdot B\} \quad (153)$$

And we can verify

$$c(t_1) - c(t_0) = e_{\rho, \eta, \Delta}(0) - e_{\rho, \eta, \Delta}(x_A) = \Delta - y_A = A$$

$$c(t_1) = e_{\rho, \eta, \Delta}(0) + t_0 - x_A = \Delta + t_1$$

$$c(t_2) - c(t_1) = e_{\rho, \eta, \Delta}(x_B) - e_{\rho, \eta, \Delta}(0) = \Delta + B - \Delta = B$$

□

### I.3 Proof of Theorem 3

The proof of Theorem 3 consist in building specific clock trajectories. We first build one pair of clocks designed to catch the worst impact of  $\rho$  and  $\eta$ , which gives (29). Second, we build one pair of clocks for each value of  $s$  designed to catch the worst impact of  $\Delta$  and obtain (30). To ease expression manipulation, let

$$\dot{E} = \underline{E} + S, \quad \dot{T} = T - S. \quad (154)$$

*Proof of (29).* 1. *Considering scenarios with two frames sent in the first cycle.* Consider the first cycle of node  $N_i$ ,  $t_0$  its beginning, and let  $F$  and  $F'$  being two frames sent by  $N_i$  to  $N_j$  during this cycle,  $F$  being sent before  $F'$ . Let  $t_{cl}^F, t_{cl}^{F'}$  be the times when  $F$  and  $F'$  are forwarded to a queue of  $N_j$  and  $t_{wr}^F, t_{wr}^{F'}$  times when they are written in the queue of  $N_j$ . Since definition 1 is satisfied,  $F$  and  $F'$  are totally received by  $N_j$  in one cycle, denoted  $\delta_k$  and

$$\begin{aligned} \left\lfloor \frac{c_j(t_{wr}^F) - o_j}{T} \right\rfloor &= \left\lfloor \frac{c_j(t_{wr}^{F'}) - o_j}{T} \right\rfloor \\ \left\lfloor \frac{c_j(t_{cl}^F) - o_j}{T} \right\rfloor \% 2 &= \left\lfloor \frac{c_j(t_{cl}^{F'}) - o_j}{T} \right\rfloor \% 2. \end{aligned} \quad (155)$$

Let us now spread these values, by building clocks  $c_i, c_j$  on  $N_i, N_j$  and maximizing / minimizing propagation and switching times.

2. *Building the trajectory of  $c_i$ .* As  $\dot{E} \geq \eta_i$ ,  $\eta \leq 2\dot{\Delta}$  and  $\dot{T}, t_0 \geq 0$ , we can apply Property 7 with  $A = \dot{E}$ ,  $B = \dot{T} - \dot{E}$ , and note  $c_i$  this clock defined with two instants  $t_1$  and  $t_2$  such that  $c_i(t_1) - c_i(t_0) = \dot{E}$ ,  $c_i(t_2) - c_i(t_1) = \dot{T} - \dot{E}$ . These two instants,  $t_1, t_2$ , correspond respectively to the instant

when the node  $N_i$  sends the last bit of the first frame and the instant when the node  $N_i$  sends the last bit of the last frame. Property 7 leads to

$$t_{em}^F = t_1 \stackrel{(140)}{=} t_0 - \min \left\{ \begin{array}{l} 2\Delta_i - \dot{E} \\ (\eta_i - \dot{E}) \cdot \frac{1}{\rho} \end{array} \right. \quad (156)$$

$$t_{em}^{F'} = t_2 \stackrel{(140)}{=} t_1 + \min \left\{ \begin{array}{l} 2\Delta_i + (\dot{T} - \dot{E}) \\ \rho_i(\dot{T} - \dot{E}) \end{array} \right. \quad (157)$$

$$c(t_0) \stackrel{(139)}{=} t_0 + \Delta_i - \dot{E} - \min \left\{ \begin{array}{l} 2\Delta_i - \dot{E} \\ (\eta_i - \dot{E}) \cdot \frac{1}{\rho} \end{array} \right. \quad (158)$$

Since  $t_0$  is the start of the first cycle, we have  $c_i(t_0) - o_i = 0$ , leading to

$$t_0 = o_i - \Delta_i + \dot{E} + \min \left\{ \begin{array}{l} 2\Delta_i - \dot{E} \\ (\eta_i - \dot{E}) \cdot \frac{1}{\rho_i} \end{array} \right. \quad (159)$$

3. *Maximizing and minimizing propagation and switching times.* Assume that the propagation time is minimal for  $F$  and maximal for  $F'$ , we have :

$$t_{cl}^F = t_{em}^F + \underline{P}_{i,j} \quad (160)$$

$$t_{cl}^{F'} = t_{em}^{F'} + \overline{P}_{i,j} \quad (161)$$

Also assume that the switching time is minimal for  $F$  and maximal for  $F'$ , we have :

$$t_{wr}^F = t_{cl}^F + \underline{z}_j \quad (162)$$

$$t_{wr}^{F'} = t_{cl}^{F'} + \overline{z}_j \quad (163)$$

4. *Building the trajectory of  $c_j$ .* By Property 6, we can build  $c_j$  using  $e'_{\rho_j, \eta_j, \Delta_j}$ , set  $t' = t_{cl}^F$  and

$$c_j(t) = e'_{\rho_j, \eta_j, \Delta_j}(t - t_{cl}^F) + t_{cl}^F. \quad (164)$$

5. *Expressing  $t_{cl}^F$  as a function of known parameters*

$$t_{cl}^F = \underline{P}_{i,j} + t_0 - \min \left\{ \begin{array}{l} 2\Delta_i - \dot{E} \\ (\eta_i - \dot{E}) \cdot \frac{1}{\rho} \end{array} \right. \quad (165)$$

$$\stackrel{(159)}{=} \dot{E} + \underline{P}_{i,j} + o_i - \Delta_i \quad (166)$$

$$= X + o_j \quad (167)$$

6. Expressing the value of  $c_j(t_{cl}^F)$ .

$$c_j(t_{cl}^F) \quad (168)$$

$$\stackrel{(164)}{=} e'_{\rho_j, \eta_j, \Delta_j}(t_{cl}^F - t_{cl}^F) + t_{cl}^F \quad (169)$$

$$\stackrel{(167)}{=} e'_{\rho_j, \eta_j, \Delta_j}(t_{wr}^F - t_{cl}^F) + X + o_j \quad (170)$$

$$= e'_{\rho_j, \eta_j, \Delta_j}(0) + X + o_j \quad (171)$$

$$\stackrel{(92)}{=} X - \Delta_j + o_j \quad (172)$$

$$= \tilde{L}\% \quad (173)$$

7. Expressing the value of  $c_j(t_{cl}^{F'})$ .

$$c_j(t_{cl}^{F'}) \quad (174)$$

$$\stackrel{(164)}{=} e'_{\rho_j, \eta_j, \Delta_j}(t_{cl}^{F'} - t_{cl}^F) + t_{cl}^F \quad (175)$$

$$\stackrel{(167)}{=} e'_{\rho_j, \eta_j, \Delta_j}(t_{wr}^{F'} - t_{cl}^F) + X + o_j \quad (176)$$

$$(177)$$

$$\stackrel{(163)}{=} e'_{\rho_j, \eta_j, \Delta_j}(t_{cl}^{F'} + \bar{z}_j - t_{cl}^F) + X + o_j \quad (178)$$

$$\stackrel{(161)}{=} e'_{\rho_j, \eta_j, \Delta_j}(t_{em}^{F'} + \bar{P}_{i,j} - t_{cl}^F) + X + o_j \quad (179)$$

$$\stackrel{(160)}{=} e'_{\rho_j, \eta_j, \Delta_j}(t_{em}^{F'} + \bar{P}_{i,j} - t_{em}^F - \underline{P}_{i,j}) + X + o_j \quad (180)$$

$$\stackrel{(92)}{=} \min \left\{ (t_{em}^{F'} - t_{em}^F + \bar{P}_{i,j} - \underline{P}_{i,j}) + \Delta_j \right. \\ \left. \rho_j(t_{em}^{F'} - t_{em}^F + \bar{P}_{i,j} - \underline{P}_{i,j}) - \Delta_j + \eta_j \right. \\ \left. + X + o_j \right. \quad (181)$$

$$= X + o_j + \quad (182)$$

$$\min \left\{ \bar{P}_{i,j} - \underline{P}_{i,j} + \Delta_j + (t_{em}^{F'} - t_{em}^F) \right. \\ \left. \eta_j - \Delta_j + \rho_j(\bar{P}_{i,j} - \underline{P}_{i,j} + t_{em}^{F'} - t_{em}^F) \right.$$

From eq. (157),

$$t_{em}^{F'} - t_{em}^F = t_2 - t_1 = \min \left\{ 2\Delta_i + (\dot{T} - \dot{E}) \right. \\ \left. \rho_i(\dot{T} - \dot{E}) \right. \quad (183)$$

$$\stackrel{(154)}{=} \min \left\{ 2\Delta_i + (T - \underline{E} - 2S) \right. \\ \left. \rho_i(T - \underline{E} - 2S) \right. \quad (184)$$

$$(185)$$

Then, eq. (182) becomes

$$c_j(t_{cl}^{F'}) = X + o_j + \quad (186)$$

$$\min \begin{cases} \bar{P}_{i,j} - \underline{P}_{i,j} + \Delta_j + 2\Delta_i + T - \underline{E} - 2S \\ \bar{P}_{i,j} - \underline{P}_{i,j} + \Delta_j + \rho_i(T - \underline{E} - 2S) \\ \eta_j - \Delta_j + \rho_j(\bar{P}_{i,j} - \underline{P}_{i,j} + 2\Delta_i + T - \underline{E} - 2S) \\ \eta_j - \Delta_j + \rho_j(\bar{P}_{i,j} - \underline{P}_{i,j} + \rho_i(T - \underline{E} - 2S)) \end{cases} \\ = X + o_j + \tilde{U}_\% \quad (187)$$

8. *Expressing the value of  $c_j(t_{wr}^F)$ .*

$$c_j(t_{wr}^F) \quad (188)$$

$$\stackrel{(164)}{=} e'_{\rho_j, \eta_j, \Delta_j}(t_{wr}^F - t_{cl}^F) + t_{cl}^F \quad (189)$$

$$\stackrel{(167)}{=} e'_{\rho_j, \eta_j, \Delta_j}(t_{wr}^F - t_{cl}^F) + X + o_j \quad (190)$$

$$\stackrel{(162)}{=} e'_{\rho_j, \eta_j, \Delta_j}(\underline{z}_j) + X + o_j \quad (191)$$

$$\stackrel{(92)}{=} \min \begin{cases} \underline{z}_j + \Delta_j \\ \rho_j \cdot \underline{z}_j - \Delta_j + \eta_j \end{cases} + X + o_j \quad (192)$$

$$= o_j + \tilde{L} \quad (193)$$

9. *Expressing the value of  $c_j(t_{wr}^{F'})$ .*

$$c_j(t_{wr}^{F'}) \quad (194)$$

$$\stackrel{(164)}{=} e'_{\rho_j, \eta_j, \Delta_j}(t_{wr}^{F'} - t_{cl}^F) + t_{cl}^F \quad (195)$$

$$\stackrel{(167)}{=} e'_{\rho_j, \eta_j, \Delta_j}(t_{wr}^{F'} - t_{cl}^F) + X + o_j \quad (196)$$

$$\stackrel{(163)}{=} e'_{\rho_j, \eta_j, \Delta_j}(t_{cl}^{F'} + \bar{z}_j - t_{cl}^F) + X + o_j \quad (197)$$

$$\stackrel{(161)}{=} e'_{\rho_j, \eta_j, \Delta_j}(t_{em}^{F'} + \bar{P}_{i,j} + \bar{z}_j - t_{cl}^F) + X + o_j \quad (198)$$

$$\stackrel{(160)}{=} e'_{\rho_j, \eta_j, \Delta_j}(t_{em}^{F'} + \bar{P}_{i,j} + \bar{z}_j - t_{em}^F - \underline{P}_{i,j}) \\ + X + o_j \quad (199)$$

$$\stackrel{(92)}{=} \min \begin{cases} (t_{em}^{F'} - t_{em}^F + \bar{z}_j + \bar{P}_{i,j} - \underline{P}_{i,j}) + \Delta_j \\ \rho_j(t_{em}^{F'} - t_{em}^F + \bar{z}_j + \bar{P}_{i,j} - \underline{P}_{i,j}) - \Delta_j + \eta_j \end{cases} \\ + X + o_j \quad (200)$$

$$= X + o_j + \quad (201)$$

$$\min \begin{cases} \bar{z}_j + \bar{P}_{i,j} - \underline{P}_{i,j} + \Delta_j + (t_{em}^{F'} - t_{em}^F) \\ \eta_j - \Delta_j + \rho_j(\bar{z}_j + \bar{P}_{i,j} - \underline{P}_{i,j} + t_{em}^{F'} - t_{em}^F) \end{cases}$$

From eq. (157),

$$t_{em}^{F'} - t_{em}^F = t_2 - t_1 = \min \begin{cases} 2\Delta_i + (\dot{T} - \dot{E}) \\ \rho_i(\dot{T} - \dot{E}) \end{cases} \quad (202)$$

$$\stackrel{(154)}{=} \min \begin{cases} 2\Delta_i + (T - \underline{E} - 2S) \\ \rho_i(T - \underline{E} - 2S) \end{cases} \quad (203)$$

$$(204)$$

Then, eq. (201) becomes

$$\begin{aligned} c_j(t_{wr}^{F'}) &= X + o_j + & (205) \\ \min \begin{cases} \bar{z}_j + \bar{P}_{i,j} - \underline{P}_{i,j} + \Delta_j + 2\Delta_i + T - \underline{E} - 2S \\ \bar{z}_j + \bar{P}_{i,j} - \underline{P}_{i,j} + \Delta_j + \rho_i(T - \underline{E} - 2S) \\ \eta_j - \Delta_j + \rho_j(\bar{z}_j + \bar{P}_{i,j} - \underline{P}_{i,j} + 2\Delta_i + T - \underline{E} - 2S) \\ \eta_j - \Delta_j + \rho_j(\bar{z}_j + \bar{P}_{i,j} - \underline{P}_{i,j} + \rho_i(T - \underline{E} - 2S)) \end{cases} \\ &= X + o_j + \tilde{U} & (206) \end{aligned}$$

10. *Concluding from time alignment.* Combining with (155) we obtain (29).  $\square$

*Proof of (30).* Let  $s \in \{-1, 1\}$ .

1. *Considering scenarios with two frames sent in the first cycle.* This step is the same as the first step of the previous proof. According to Definition 1, we necessary satisfy

$$\begin{aligned} \left\lfloor \frac{c_j(t_{wr}^F) - o_j}{T} \right\rfloor &= \left\lfloor \frac{c_j(t_{wr}^{F'}) - o_j}{T} \right\rfloor \\ \left\lfloor \frac{c_j(t_{cl}^F) - o_j}{T} \right\rfloor \% 2 &= \left\lfloor \frac{c_j(t_{cl}^{F'}) - o_j}{T} \right\rfloor \% 2. \end{aligned} \quad (207)$$

Let now spread these values, by building clocks  $c_i, c_j$  on  $N_i, N_j$  and maximizing / minimizing propagation and switching times.

2. *Building the trajectory of  $c_i$*  Here, we take another clock for  $c_i$ :

$$c_i(t) = t + s \cdot \Delta_i \quad (208)$$

According to this expression and with  $c(t_k) = k \cdot T + o_i$ , we have

$$c_i(t_{em}^F) - c_i(t_k) = \dot{E} = t_{em}^F + s \cdot \Delta_i - (k \cdot T + o_i) \quad (209)$$

$$c_i(t_{em}^{F'}) - c_i(t_k) = \dot{T} = t_{em}^{F'} + s \cdot \Delta_i - (k \cdot T + o_i) \quad (210)$$

Then,

$$t_{em}^F = \dot{E} - s \cdot \Delta_i + k \cdot T + o_i \quad (211)$$

$$t_{em}^{F'} = \dot{T} - s \cdot \Delta_i + k \cdot T + o_i \quad (212)$$

3. *Maximizing and minimizing propagation and switching times.* Assume that the propagation time is minimal for  $F$  and maximal for  $F'$ , we have :

$$t_{cl}^F = t_{em}^F + \underline{P} = \dot{E} - s \cdot \Delta_i + k \cdot T + o_i + \underline{P} \quad (213)$$

$$t_{cl}^{F'} = t_{em}^{F'} + \bar{P} = \dot{T} - s \cdot \Delta_i + k \cdot T + o_i + \bar{P} \quad (214)$$

Also, assume that the switching time is minimal for  $F$  and maximal for  $F'$ , we have :

$$t_{wr}^F = t_{cl}^F + \underline{z}_j = \dot{E} - s \cdot \Delta_i + k \cdot T + o_i + \underline{P} + \underline{z} \quad (215)$$

$$t_{wr}^{F'} = t_{cl}^{F'} + \bar{z}_j = \dot{T} - s \cdot \Delta_i + k \cdot T + o_i + \bar{P} + \bar{z} \quad (216)$$

4. *Building the trajectory of  $c_j$ .* Here, we take another clock for  $c_j$ :

$$c_j(t) = t - s \cdot \Delta_j \quad (217)$$

5. *Expressing the value of  $c_j(t_{cl}^F)$ .*

$$c_j(t_{cl}^F) \quad (218)$$

$$\stackrel{(217)}{=} t_{cl}^F - s \cdot \Delta_j \quad (219)$$

$$\stackrel{(213)}{=} \dot{E} - s \cdot (\Delta_i + \Delta_j) + k \cdot T + o_i + \underline{P} \quad (220)$$

$$= \tilde{L}_{\%s} + o_j \quad (221)$$

6. *Expressing the value of  $c_j(t_{cl}^{F'})$ .*

$$c_j(t_{cl}^{F'}) \quad (222)$$

$$\stackrel{(217)}{=} t_{cl}^{F'} - s \cdot \Delta_j \quad (223)$$

$$\stackrel{(214)}{=} \dot{T} - s \cdot (\Delta_i + \Delta_j) + k \cdot T + o_i + \bar{P} \quad (224)$$

$$= \tilde{U}_{\%s} + o_j \quad (225)$$

7. *Expressing the value of  $c_j(t_{wr}^F)$ .*

$$c_j(t_{wr}^F) \quad (226)$$

$$\stackrel{(217)}{=} t_{wr}^F - s \cdot \Delta_j \quad (227)$$

$$\stackrel{(215)}{=} \dot{E} - s \cdot (\Delta_i + \Delta_j) + k \cdot T + o_i + \underline{P} + \underline{z} \quad (228)$$

$$= \tilde{L}_s + o_j \quad (229)$$

8. Expressing the value of  $c_j(t_{wr}^{F'})$ .

$$c_j(t_{wr}^F) \quad (230)$$

$$\stackrel{(217)}{=} t_{wr}^{F'} - s \cdot \Delta_j \quad (231)$$

$$\stackrel{(215)}{=} \dot{T} - s \cdot (\Delta_i + \Delta_j) + k \cdot T + o_i + \bar{P} + \bar{z} \quad (232)$$

$$= \tilde{U}_s + o_j \quad (233)$$

9. Concluding from time alignment. Combining with (155) we obtain (30)

□

## J Null Offset Heuristic, General Case

*Proof.* Let us start from the equation of the Corollary 1 with null offsets ( $o_i = o_j = 0$ ) and let  $k_{i,j} \in \mathbb{N}$  denote the floor part such that:

$$\begin{aligned} & \left\lfloor \frac{S_{i,j} + \underline{E}_{i,j} + \underline{P}_{i,j} - (\Delta_i + \Delta_j) - \widehat{l}_{i,j}(\bar{S}_{i,j})}{T} \right\rfloor \\ &= \left\lfloor \frac{T - S_{i,j} + \bar{P}_{i,j} + \bar{z}_{i,j} + \Delta_i + \Delta_j + \widehat{u}_{i,j}(\underline{S}_{i,j})}{T} \right\rfloor \\ &= k_{i,j} \end{aligned} \quad (234)$$

Then, according to the definition of the floor function, we have

$$\begin{cases} k_{i,j} \cdot T \leq S_{i,j} + \underline{E}_{i,j} + \underline{P}_{i,j} - (\Delta_i + \Delta_j) - \widehat{l}_{i,j}(\bar{S}_{i,j}) \\ < (k_{i,j} + 1) \cdot T \\ k_{i,j} \cdot T \leq T - S_{i,j} + \bar{P}_{i,j} + \bar{z}_{i,j} + \Delta_i + \Delta_j + \widehat{u}_{i,j}(\underline{S}_{i,j}) \\ < (k_{i,j} + 1) \cdot T \end{cases} \quad (235)$$

Thus

$$\begin{cases} k_{i,j} \cdot T - \underline{E}_{i,j} - \underline{P}_{i,j} + \Delta_i + \Delta_j + \widehat{l}_{i,j}(\bar{S}_{i,j}) \leq S_{i,j} \\ < (k_{i,j} + 1) \cdot T - \underline{E}_{i,j} - \underline{P}_{i,j} + \Delta_i + \Delta_j + \widehat{l}_{i,j}(\bar{S}_{i,j}) \\ -k_{i,j} \cdot T + \bar{P}_{i,j} + \bar{z}_{i,j} + \Delta_i + \Delta_j + \widehat{u}_{i,j}(\underline{S}_{i,j}) < S_{i,j} \\ \leq -(k_{i,j} - 1) \cdot T + \bar{P}_{i,j} + \bar{z}_{i,j} + \Delta_i + \Delta_j + \widehat{u}_{i,j}(\underline{S}_{i,j}) \end{cases} \quad (236)$$

Let

$$S_{\text{null}} = \max_{i,j} \max \begin{cases} -k_{i,j} \cdot T + \bar{P}_{i,j} + \bar{z}_{i,j} \\ + \Delta_i + \Delta_j + \widehat{u}_{i,j}(\underline{S}_{i,j}) + \epsilon \\ k_{i,j} \cdot T - \underline{E}_{i,j} - \underline{P}_{i,j} \\ + \Delta_i + \Delta_j + \widehat{l}_{i,j}(\bar{S}_{i,j}) \end{cases} \quad (237)$$



Consequently, if it exists  $\epsilon > 0$  such that  $S_{\text{null}} \leq \bar{S}$  then,  $S_{\text{null}}$  is an admissible value for the guard band.

We now express  $k_{i,j}$  from known parameters. From Equation 235, we necessary have:

$$\begin{cases} k_{i,j} \cdot T - \underline{E}_{i,j} - \underline{P}_{i,j} + \Delta_i + \Delta_j + \widehat{l}_{i,j}(\bar{S}_{i,j}) \\ \leq -(k_{i,j} - 1) \cdot T + \bar{P}_{i,j} + \bar{z}_{i,j} + \Delta_i + \Delta_j + \widehat{u}_{i,j}(\underline{S}_{i,j}) \\ -k_{i,j} \cdot T + \bar{P}_{i,j} + \bar{z}_{i,j} + \Delta_i + \Delta_j + \widehat{u}_{i,j}(\underline{S}_{i,j}) \\ < (k_{i,j} + 1) \cdot T - \underline{E}_{i,j} - \underline{P}_{i,j} + \Delta_i + \Delta_j + \widehat{l}_{i,j}(\bar{S}_{i,j}) \end{cases} \quad (238)$$

thus

$$\begin{cases} k_{i,j} \leq \frac{\underline{E}_{i,j} + \underline{P}_{i,j} + \bar{P}_{i,j} + \bar{z}_{i,j} + \widehat{u}_{i,j}(\underline{S}_{i,j}) - \widehat{l}_{i,j}(\bar{S}_{i,j}) + T}{2T} \\ k_{i,j} > \frac{\underline{E}_{i,j} + \underline{P}_{i,j} + \bar{P}_{i,j} + \bar{z}_{i,j} + \widehat{u}_{i,j}(\underline{S}_{i,j}) - \widehat{l}_{i,j}(\bar{S}_{i,j}) - T}{2T} \end{cases} \quad (239)$$

thus  $k_{i,j} =$

$$\left\lfloor \frac{\underline{E}_{i,j} + \underline{P}_{i,j} + \bar{P}_{i,j} + \bar{z}_{i,j} + \widehat{u}_{i,j}(\underline{S}_{i,j}) - \widehat{l}_{i,j}(\bar{S}_{i,j}) + T}{2T} \right\rfloor \quad (240)$$

because  $\lfloor a \rfloor = k \Leftrightarrow k \leq a < k + 1 \Leftrightarrow a - 1 < k \leq a$ .

Note that

$$\begin{aligned} k_{i,j} = 0 &\Leftrightarrow \\ -T &\leq \underline{E}_{i,j} + \underline{P}_{i,j} + \bar{P}_{i,j} + \bar{z}_{i,j} + \widehat{u}_{i,j}(\underline{S}_{i,j}) - \widehat{l}_{i,j}(\bar{S}_{i,j}) < T \end{aligned} \quad (241)$$

Consequently,

$$0 \leq \underline{E}_{i,j} + \underline{P}_{i,j} + \bar{P}_{i,j} + \bar{z}_{i,j} + \widehat{u}_{i,j}(\underline{S}_{i,j}) - \widehat{l}_{i,j}(\bar{S}_{i,j}) < T \quad (242)$$

thus  $k_{i,j} = 0$ . □

## K Proof of Theorem 4

We start with the following property, which gives  $\mathcal{S}_{\text{cor1}}^{o_i, o_j}$  and  $\underline{\mathcal{S}}_{\text{cor1}}^{o_i, o_j}$  in closed-form. Observe that  $U'_{i,j}$  and  $L'_{i,j}$  can be written as

$$U'_{i,j}(S) = -S + U_{i,j}^o \quad (243)$$

$$L'_{i,j}(S) = S + L_{i,j}^o \quad (244)$$

where  $U_{i,j}^o, L_{i,j}^o$  depend on  $o_i, o_j$  but not on  $S$ .

**Property 8.** Assume that the set  $\mathcal{S}_{\text{cor1}}^{o_i, o_j}$  of values of  $S$  that are admissible according to Corollary 1 applied to link  $(i, j)$  is not empty. Let  $k = \left\lfloor \frac{U'_{i,j}(\bar{S})}{T} \right\rfloor$ ,  $S'_{i,j} = U_{i,j}^o - (k+1)T$  and  $S''_{i,j} = L_{i,j}^o + kT$ . Then

- $\underline{S}_{\text{cor1}}^{o_i, o_j} = \max(S'_{i,j}, S''_{i,j})$ ,
- If  $S'_{i,j} < S''_{i,j}$  then  $\mathcal{S}_{\text{cor1}}^{o_i, o_j} = [S''_{i,j}, \bar{S}]$  else  $\mathcal{S}_{\text{cor1}}^{o_i, o_j} = (S'_{i,j}, \bar{S}]$ .

*Proof.* Since  $\mathcal{S}_{\text{cor1}}^{o_i, o_j}$  is non-empty, by Theorem 2, we know that  $\bar{S} \in \mathcal{S}_{\text{cor1}}^{o_i, o_j}$ . Thus

$$k = \left\lfloor \frac{U'_{i,j}(\bar{S})}{T} \right\rfloor = \left\lfloor \frac{L'_{i,j}(\bar{S})}{T} \right\rfloor \quad (245)$$

Combining with (243) and (244) we obtain that, for  $S \in [0, \bar{S}]$ :

$$\left\lfloor \frac{U'_{i,j}(S)}{T} \right\rfloor = k \Leftrightarrow S'_{i,j} < S \leq \bar{S} \quad (246)$$

and

$$\left\lfloor \frac{L'_{i,j}(S)}{T} \right\rfloor = k \Leftrightarrow S''_{i,j} \leq S \leq \bar{S} \quad (247)$$

Furthermore  $U'_{i,j}$  is decreasing and  $L'_{i,j}$  is decreasing thus

$$\left( \left\lfloor \frac{L'_{i,j}(S)}{T} \right\rfloor = \left\lfloor \frac{L'_{i,j}(S)}{T} \right\rfloor \right) \Leftrightarrow \left( \left\lfloor \frac{L'_{i,j}(S)}{T} \right\rfloor = \left\lfloor \frac{L'_{i,j}(S)}{T} \right\rfloor = k \right) \quad (248)$$

Therefore

$$\mathcal{S}_{\text{cor1}}^{o_i, o_j} = (S'_{i,j}, \bar{S}] \cap [S''_{i,j}, \bar{S}] \quad (249)$$

The two bullets of the property follow immediately.  $\square$

*Proof of Theorem 4.* Let  $\mathcal{S}_{i,j}^o$  be the set of  $S \in [0, \bar{S}]$  that satisfy the constraints corresponding to  $i, j$  in Problem  $P - \text{MILP}$ , i.e. such that

$$\exists k_{i,j} \in \mathbb{Z}, k_{i,j} \leq \frac{L'_{i,j}(S)}{T}, \frac{U'_{i,j}(S)}{T} \leq k_{i,j} + 1 - \frac{\varepsilon}{T} \quad (250)$$

and let

$$S_{i,j}^o = \min(\mathcal{S}_{i,j}^o) \quad (251)$$

It follows that

$$S_{\text{MILP}} = \min_{o \in [0, \bar{S}]^L} \max_{(i,j) \in \mathcal{L}} S_{i,j}^o \quad (252)$$

Observe that we also have

$$\underline{S} = \min_{o \in [0, \bar{S}]^L} \max_{(i,j) \in \mathcal{L}} \underline{S}_{\text{cor1}}^{o_i, o_j} \quad (253)$$

We now compare  $S_{i,j}^o$  to  $\underline{S}_{\text{cor1}}^{o_i, o_j}$ . With the same notation as in the proof of Lemma 8, we obtain

$$S_{i,j}^o = \max(S_{i,j}'', S_{i,j}' + \varepsilon) \quad (254)$$

Combining with the first bullet of Property 8, it follows that

$$\underline{S}_{\text{cor1}}^{o_i, o_j} \leq S_{i,j}^o \leq \underline{S}_{\text{cor1}}^{o_i, o_j} + \varepsilon \quad (255)$$

Using (252) and (253) we obtain

$$\underline{S} \leq S_{\text{MILP}} \leq \underline{S} + \varepsilon \quad (256)$$

□