



HAL
open science

Configuration of Guard Band and Offsets in Cyclic Queuing and Forwarding

Damien Guidolin-Pina, Marc Boyer, Jean-Yves Le Boudec

► **To cite this version:**

Damien Guidolin-Pina, Marc Boyer, Jean-Yves Le Boudec. Configuration of Guard Band and Offsets in Cyclic Queuing and Forwarding. 2022. hal-03772877v1

HAL Id: hal-03772877

<https://hal.science/hal-03772877v1>

Preprint submitted on 8 Sep 2022 (v1), last revised 21 Nov 2023 (v3)

HAL is a multi-disciplinary open access archive for the deposit and dissemination of scientific research documents, whether they are published or not. The documents may come from teaching and research institutions in France or abroad, or from public or private research centers.

L'archive ouverte pluridisciplinaire **HAL**, est destinée au dépôt et à la diffusion de documents scientifiques de niveau recherche, publiés ou non, émanant des établissements d'enseignement et de recherche français ou étrangers, des laboratoires publics ou privés.

Configuration of Guard Band and Offsets in Cyclic Queuing and Forwarding

Damien Guidolin–Pina, RealTime-at-Work, Marc Boyer, ONERA,
and Jean-Yves Le Boudec, EPFL

June 27, 2022

Abstract

Cyclic Queuing and Forwarding (CQF) is a mechanism defined by IEEE TSN for providing low-jitter in a deterministic network. CQF uses a common time cycle and two buffers per node output port: during one cycle incoming packets are stored in one buffer while packets in the other buffer are being transmitted; at the end of a cycle, the roles of the two buffers are exchanged. The cycle start-times are determined by a time offset that may be different for every output buffer. A guard band at both cycle-ends is foreseen in order to compensate for misalignment and timing inaccuracies. The proper operation of CQF requires that the guard band and the offsets are computed such that nodes are sufficiently time-aligned. First, we give necessary and sufficient conditions for this to be guaranteed. The sufficient conditions lend themselves to tractable computations and we show that they are close to optimal. Our conditions account for non-ideal clocks and non-zero propagation times; we show that accounting for these two elements does matter. Second, we give a method for computing the minimal duration of the guard band, given prior choices of time offsets. Third, a judicious choice of time offsets can considerably decrease the required duration of the guard band: we give a practical algorithm, based on a Mixed Integer Linear Program, for computing offsets that minimize the guard band. We illustrate our results on several CQF network topologies with or without cyclic dependencies.

Index terms— TSN; CQF; Peristaltic Shaper; Cyclic Queuing and Forwarding.

1 Introduction

In order to offer a standard real-time data network, the IEEE Time Sensitive Networking working group has defined several extensions to Ethernet. Among others, Cyclic Queuing and Forwarding (CQF), previously known as “peristaltic shaper”, has been defined in order to offer guaranteed delay and limited jitter [1]. In short (see Section 2 for more details), CQF considers a common time cycle,

T , and uses two queues per node output port to alternatively store or forward frames. It guarantees that the delay experienced by a frame crossing h switches along its path is between $(h - 1)T$ and $(h + 1)T$.

CQF has appealing characteristics: it is simple to implement, it offers a simple expression of the latency bound, it provides a limited delay jitter ($2T$) [2] and can also easily handle cyclic dependencies (whereas other real-time mechanisms may require some attention in such cases, [3–5])

Nevertheless, it requires some time synchronization and alignment of cycles between switches [2]. Moreover a fraction of the cycle time is used by a “guard band”, S , (called “adjustment factor” in [1]), which absorbs the effects of imperfections in time-synchronization and alignment. During the guard band, the output port can not be used by CQF frames (but may be used by lower priority flows, leading eventually to some one-frame blocking at start of cycle [6]). To avoid this synchronization effort, several alternative strategies have been defined (cf. Section 6), but they all require at least of third queue, or even of fourth one. Furthermore, the cycle start-times are determined by a time offset that may be different for every output buffer.

The use of CQF requires the choice of two network-wide parameters, the cycle time T and the guard band S , and of the values of all time offsets at output buffers. The cycle time is related to the flows characteristics, whereas the guard band and the time offsets are related to synchronization between switches. In this paper, we address the choice of time offsets and guard band.

We consider the clock error model from [7], which captures the effects of clock non idealities in the context of deterministic networks (cf. Section 3). Then we provide:

- a formal characterization of CQF cycle alignment and guard band (Sections 3 and 4.1), where, unlike other studies, we do not assume that all cycle offsets are equal;
- two sufficient conditions to check if a guard band S is large enough (Section 4.1), one being a simplification of the other;
- a necessary condition (Section 4.2), that is used to show the quality of the sufficient conditions (Section 4.3);
- a method to compute the minimum value of the guard band, given some pre-specified values of time offsets (Theorem 2);
- three strategies to compute a common guard band and local time offsets (two analytic ones, and a third using a Mixed Integer Linear Program – MILP – in Section 5);
- the evaluations of the strategies on some synthetic benchmarks, in Section 5.3.

These experiments show that:

- clock non-ideality cannot be neglected;
- the choice of the offsets may have a dramatic effect on the minimum guard band value.

2 Presentation of CQF

2.1 Alternating Cycles

Consider a node offering a CQF policy to a set of flows (a CQF class) on a given output port. Two queues, called “even” and “odd” are dedicated to this CQF class, as depicted in Figure 1. The CQF node has a periodic behaviour, with period T (called “cycle time”), which has the same value for all CQF nodes in the network. Let $c(t)$ denote the value displayed at the clock of the server when the true time is t and let o be the time offset at this server. A time instant t is said to be in an “even” [resp. “odd”] cycle if $\lfloor \frac{c(t)-o}{T} \rfloor$ is even [resp. odd]¹. During an even cycle, the even queue is served and all received frames are stored in the odd queue. The frames stored in the odd queue will be forwarded in the next odd interval. The same holds, mutatis mutandi, with odd cycles.

The operation of CQF on an illustrative topology is shown in Figure 2. Under correct operation, CQF provides two guarantees: if a frame follows a path made of h hops, the end-to-end delay is in the range $[(h-1)T, (h+1)T]$ and the delay-jitter is upper bounded by $2T$ (for example, any frame of stream s_1 experiments a delay in T and $3T$). For correct operation, two conditions must be satisfied [8]. First, at every node, it must be possible to transmit in one cycle all frames received in the previous cycle. This requires that there is enough link capacity to support the rates of all sources and that the cycle duration is large enough to absorb the burstiness of all incoming flows in one cycle. This condition and the resulting minimum cycle length is studied in companion work and is outside the scope of this paper. Second, the cycles of consecutive nodes must be aligned such that all frames sent by a node when a buffer is open for transmission can be stored by the receiving node in a buffer that is open for reception. This condition is discussed in the next subsection.

2.2 Time-Aligned Nodes and Guard Band

In a CQF network, nodes are assumed to be time-synchronized. However, propagation times and switchover time (from switch input to switch output) are non zero and time synchronization is never perfect. To compensate for these effects, the standard introduced a guard band S at the beginning and at the end of each cycle as illustrated in Figure 3. The value of S is the same for all CQF nodes in the network.

The figure shows two frames, F and F' , sent by N_i to N_j with their emission time (E and E') and their propagation times (P and P'). Here both cycles are

¹An expression such as $\lfloor x \rfloor$ denotes the floor of x .

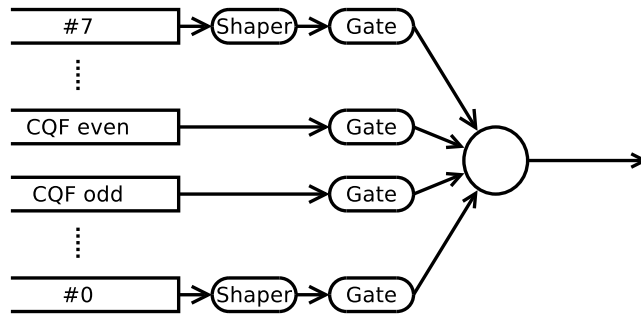

Figure 1: Queues of a bridge using CQF policy.

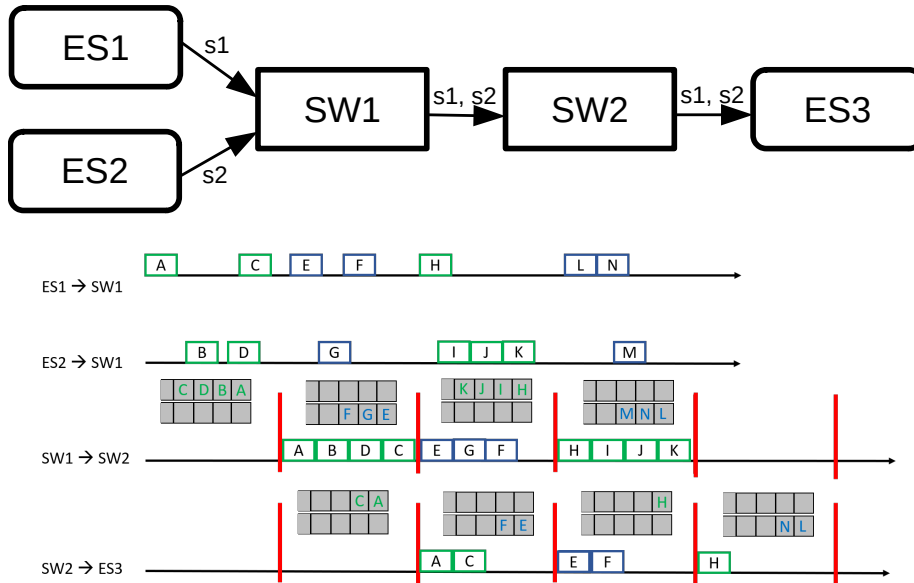

Figure 2: Operation of CQF on an illustrative topology.

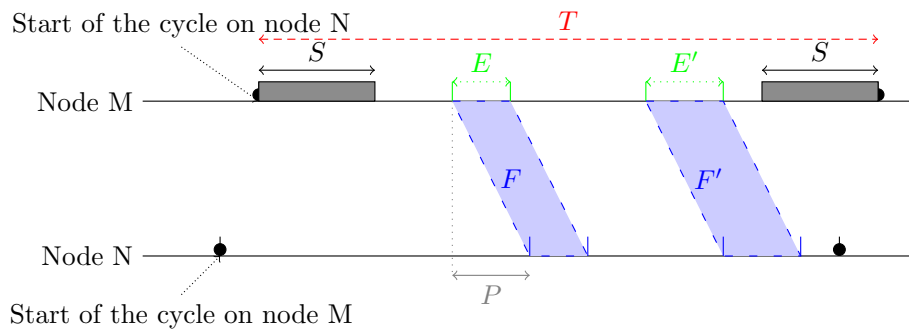

Figure 3: Illustration of the guard time S .

not aligned. This can be by design (e.g. to compensate for propagation time) but can also occur due to clock imperfections.

The standard states that “ S should be set to the sum of the errors or jitter values from all sources given in [a] list” and gives a list of sources of errors [1, §T.5.3]. In Section 4 we formally define what “Time-Aligned Nodes” mean and give practical conditions to ensure that it holds. The conditions bear on the values of the guard band and the offsets. The guard band may result in a waste of capacity, hence it should be minimized. In Section 5 we give methods to compute offsets and guard band that minimize the guard band.

2.3 Other Aspects of CQF

The implementation of CQF relies on two mechanisms, the Per-Stream Filtering and Policing at input port (PSPF, [9]) and the Gate Control List at output port (GCL) defined in the Enhancements for Scheduled Traffic [10]. The PSPF has a time-driven table (also called GCL) which forwards the CQF frames from the input to the even or odd buffer on the output port. During an open interval, a queue has to compete with the other queues, using the static priority policy. It means that the cycle time must account for higher priority flows and some limited interaction with lower priority flows.

The blocking due to the lower priority flow can be limited. At gate opening (at the end of the guard band), it may be possible that a lower priority frame is using the link, and the CQF frames have to wait the end of transmission, leading to a blocking factor $\frac{l_p^{\max}}{C}$ where l_p^{\max} is the maximal size of a lower priority packet and C the link bandwidth. If the CQF queue is marked as “express” and the lower priority flow is “preemptable”, the blocking factor can be reduced to $\frac{143 \times 8}{C}$ [11]. Since all CQF frames are sent back-to-back, this blocking factor is payed at most once per interval. The lower priority flows can then use the end of the CQF interval that is not used by the CQF frames.

The standard also considers the case with several CQF classes having different cycle time and illustrates an example of interleaving in [1, Fig. T-5]. Also, in wide area networks, some papers have proposed to extend CQF to more than 2 buffers. Such extensions are out of the scope of this paper.

3 System Model and Notation

We consider a network with a single CQF class with two buffers and n nodes $N_1 \dots N_n$. The CQF cycle time is T ; there is a guard band of duration S at the beginning of every cycle, and one of same duration at the end. The nominal values of T and S are identical at all nodes. In contrast, the links may have different bit rates $R_{i,j}$. Table 1 gathers the notation used throughout the paper.

Obviously, there must be enough time in one cycle to transmit the largest possible frame, i.e. we assume that

$$T - 2S \geq \max_{i,j} \bar{E}_{i,j}. \quad (1)$$

where $\overline{E}_{i,j}$ is the transmission time of a frame of maximum size on the link from N_i to N_j . The same way, $\underline{E}_{i,j}$ is the transmission time of a frame of minimum size on the link from N_i to N_j .

Every node has a local clock and all clocks are synchronized, using for example [12]. However, at the microsecond time scale, synchronization is not perfect and clock non idealities have to be taken into account. We use the following model, taken from [7]. Let $c_i(t)$ be the local time displayed by the clock of node N_i when the true time (international atomic time, TAI) is t . The non-ideality of clock c_i can be characterized by the clock stability bound $\rho_i \geq 1$, the timing jitter bound $\eta_i \geq 0$ and the synchronization error bound Δ_i , such that displayed times satisfy:

$$\forall t, d \geq 0 : \frac{d - \eta_i}{\rho_i} \leq c_i(t + d) - c_i(t) \leq d\rho_i + \eta_i, \quad (2)$$

$$\forall t \geq 0 : |c_i(t) - t| \leq \Delta_i. \quad (3)$$

The former equation captures the effect of clock drift, jitter and wander on measurements of time intervals performed with the local clock. The latter equation captures the effect of the time synchronization protocol. In a TSN network synchronized with gPTP (generic PTP), the values are $\rho_i = 1.0001$ [12, Annex B.1.1], $\eta_i = 2\text{ns}$ [12, Annex B.1.3.1] and $\Delta_i = 1\mu\text{s}$ [12, Section B.3]. The two equations above can be combined, which leads to the following bound on the measurements of time intervals (proof in Appendix B):

$$\max \left\{ \frac{d - 2\Delta_i}{\rho_i}, \frac{d - \eta_i}{\rho_i} \right\} \leq c_i(t + d) - c_i(t) \leq \min \left\{ d + 2\Delta_i, d\rho_i + \eta_i \right\} \quad (4)$$

Also note that we can always assume that $2\Delta \geq \eta$ since otherwise we can replace η by 2Δ (Property 3 in Appendix C).

Node N_i uses a time offset o_i , at which the initial cycle begins. Consequently, the k th cycle starts at this node at true time t_k^i such that $c_j(t_k^i) - o_j = kT$. Thus, at true time t , node N_i is in the k th cycle with $k = \lfloor \frac{c_j(t) - o_j}{T} \rfloor$.

For a CQF frame F that travels from N_i to N_j , let t_{em}^F denote the instant at which node N_i finishes transmitting the last bit of F . Unless otherwise specified, all time instants are in true time. Then, node N_j receives the frame F and a classifier chooses in which queue the frame will be forwarded. Let t_{cl}^F denote the instant at which the frame F is forwarded to the queue $Q_{j,b}$ of the node N_j with $b = \lfloor \frac{c_j(t_{cl}^F) - o_j}{T} \rfloor \% 2$ (where $\% 2$ denotes the remainder modulo 2). Note that the choice is done when the frame is totally received in the node N_j . The difference $P_{i,j}^F = t_{cl}^F - t_{em}^F$ is the sum of the propagation time from N_i to N_j plus the time for ingress processing and is simply called ‘‘propagation’’ in the rest of the paper. Then, the frame is transmitted through the switch fabric and is written in the queue $Q_{j,b}$. Let t_{wr}^F denote the instant when the last bit of the frame F is written in the queue $Q_{j,b}$ of node N_j . Note that the frame is written during the cycle $\lfloor \frac{c_j(t_{wr}^F) - o_j}{T} \rfloor$. The difference $z_j^F = t_{wr}^F - t_{cl}^F$ is called the switching time. Figure 4 illustrates these definitions.

Table 1: Notation

$\overline{E}_{i,j} = \frac{\overline{L}_{i,j}}{R_{i,j}}$	Max transmission time of CQF frame from N_i to N_j
$\underline{E}_{i,j} = \frac{\underline{L}_{i,j}}{R_{i,j}}$	Min transmission time of CQF frame from N_i to N_j
$k \in \mathbb{N}$	Index of a cycle
$\underline{L}_{i,j}, \overline{L}_{i,j}$	Min, max size of CQF frames from N_i to N_j
$L_{i,j}^{\text{NPr}}$	Maximum size of high priority frame from N_i to N_j
N_i	Node i
o_i	Time offset at node i
$\underline{P}_{i,j}, \overline{P}_{i,j}$	Lower and upper bounds on propagation time
P	Mean propagation time $P = \frac{1}{2} (\overline{P}_{i,j} + \underline{P}_{i,j})$
p	Propagation jitter parameter, $p = \frac{1}{2} (\overline{P}_{i,j} - \underline{P}_{i,j})$
$R_{i,j}$	Bit rate of link from N_i to N_j
S	Duration of guard band at begin and end of cycle
T	Duration of cycle
$\underline{z}_j, \overline{z}_j$	Lower and upper bounds on switching time
$c_i(t)$	time displayed by clock of N_i when true time is t
Δ_i	clock synchronization error bound (e.g. $\Delta_i = 1\mu\text{s}$)
$\rho_i \geq 1$	clock stability bound (e.g. $\rho_i = 1.0001$)
$\eta_i \leq 2\Delta$	clock timing jitter bound (e.g. $\eta_i = 2\text{ns}$)
$\lfloor x \rfloor$	floor of the real number x
$m\%2$	residual modulo 2 of the integer m
ε	a tolerance on the accuracy of floating-points
\overline{S}	a network-wide upper bound on S , (15)
\underline{S}	a lower bound on S^{o_i, o_j} , (16)
$S_{\text{thm1}}^{*o_i, o_j}, S_{\text{thm1}}^*$	minimum value of S (at precision ε) that satisfies the sufficient condition in Theorem 1
$S_{\text{cor1}}^{*o_i, o_j}, S_{\text{cor1}}^*$	minimum value of S (at precision ε) that satisfies the simpler sufficient condition in Coro 1
$\underline{S}_{\text{cor1}}^{o_i, o_j}$	infimum of all values of S that satisfy Coro 1; may or may not be feasible and $0 \leq S_{\text{cor1}}^{*o_i, o_j} - \underline{S}_{\text{cor1}}^{o_i, o_j} \leq \varepsilon$
$S_{\text{thm3}}^{*o_i, o_j}, S_{\text{thm3}}^*$	minimum value of S (at precision ε) that satisfies the necessary condition in Theorem 3
I	number of nodes
\mathcal{L}	set of links

Following [1], we assume that the propagation time is not constant but has some bounded variability; this may correspond to variable decoding and processing times. Let $\underline{P}_{i,j}, \overline{P}_{i,j}$ be lower and upper bounds on the propagation time from N_i to N_j . The difference $\overline{P}_{i,j} - \underline{P}_{i,j}$ is a bound on the “propagation jitter”. Similarly, we assume that the switching time has some bounded variability and let $\underline{z}_j, \overline{z}_j$ denote lower and upper bounds on the switching time at N_j .

In [13, § 4.11.3], it is specified that the “technological latency of the switch should be less than 100 μ s.” At the time of writing, a value of 15 μ s seems acceptable.

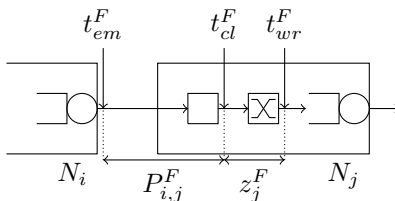

Figure 4: Significant times between 2 nodes N_i and N_j .

4 Conditions for Time Alignment

In this section we solve the issue of time alignment of nodes. This involves the offsets and the guard band. The main results of this section are Theorem 1 and Coro. 1, which give sufficient conditions for nodes to be time aligned; the latter is more tractable than the former and gives the basis of methods to compute offsets and minimal guard band that minimize the duration of the guard band in Section 5. We also show in Theorem 2 that the minimum value of the guard band for given offsets can be obtained by binary search. Ideally, we would like to have a necessary and sufficient condition, but this appears to be out of reach as it is difficult to quantify all possible behaviours; instead, we give a necessary condition and show that the difference with the sufficient condition is small. In the idealized case where clocks are perfect and switching latency is negligible, the conditions are identical.

4.1 Sufficient Conditions

We start by a formal definition of time alignment.

Definition 1 (Time aligned nodes). *Consider a node N_i that has a link to a node N_j . We say that N_i and N_j are time-aligned if and only if, for any cycle index k at N_i , there exists a cycle index k' at N_j such that all frames sent by N_i in cycle k are forwarded by node N_j in cycle k' out of a single CQF buffer.*

Using the notation in Section 3, this is equivalent to saying that, for any two frames F, F' sent by N_i to N_j during one same cycle, we have

$$\left\lfloor \frac{c_j(t_{cl}^F) - o_j}{T} \right\rfloor \% 2 = \left\lfloor \frac{c_j(t_{cl}^{F'}) - o_j}{T} \right\rfloor \% 2 \quad (5)$$

AND

$$\left\lfloor \frac{c_j(t_{wr}^F) - o_j}{T} \right\rfloor = \left\lfloor \frac{c_j(t_{wr}^{F'}) - o_j}{T} \right\rfloor \quad (6)$$

Using this definition, we obtain the following sufficient condition:

Theorem 1 (Sufficient condition for node alignment). *Consider two nodes N_i, N_j such that N_i has a link to N_j . The parameters $\eta_i, \eta_j, \rho_i, \rho_j, \Delta_i, \Delta_j, \underline{E}_{i,j}, o_i, o_j, S$ and T are as defined in section 3. Define $U_{i,j}(S)$ and $L_{i,j}(S)$ by*

$$L_{i,j}(S) = S + \underline{E}_{i,j} + \underline{P}_{i,j} + o_i - o_j - (\Delta_i + \Delta_j) - \widehat{l}_{i,j}(S) \quad (7)$$

with

$$\widehat{l}_{i,j}(S) = \min \begin{cases} (\underline{E}_{i,j} + S) \cdot (1 - \frac{1}{\rho_i}) + \frac{\eta_i}{\rho_i} + 2 \cdot \Delta_j, \\ 2 \cdot \Delta_i + 2 \cdot \Delta_j, \\ (\underline{E}_{i,j} + S) \cdot (1 - \frac{1}{\rho_i \cdot \rho_j}) \\ \quad + \underline{P}_{i,j} \cdot (1 - \frac{1}{\rho_j}) + \frac{\eta_i}{\rho_i \cdot \rho_j} + \frac{\eta_j}{\rho_j}, \\ (\underline{E}_{i,j} + S + \underline{P}_{i,j}) \cdot (1 - \frac{1}{\rho_j}) + \frac{\eta_j}{\rho_j} + 2 \cdot \Delta_i \cdot \frac{1}{\rho_j} \end{cases} \quad (8)$$

and

$$U_{i,j}(S) = T - S + \overline{P}_{i,j} + \overline{z}_j + o_i - o_j + \Delta_i + \Delta_j + \widehat{u}_{i,j}(S) \quad (9)$$

with

$$\widehat{u}_{i,j}(S) = \min \begin{cases} (T - S) \cdot (\rho_i - 1) + \eta_i + 2 \cdot \Delta_j \\ 2 \cdot \Delta_i + 2 \cdot \Delta_j \\ (T - S) \cdot (\rho_i \cdot \rho_j - 1) + \eta_i \cdot \rho_j \\ \quad + (\overline{P}_{i,j} + \overline{z}_j) \cdot (\rho_j - 1) + \eta_j \\ (T - S + \overline{P}_{i,j} + \overline{z}_j) \cdot (\rho_j - 1) + \eta_j + 2 \cdot \Delta_i \cdot \rho_j \end{cases} \quad (10)$$

If the parameters satisfy the condition

$$\left\lfloor \frac{U_{i,j}(S)}{T} \right\rfloor = \left\lfloor \frac{L_{i,j}(S)}{T} \right\rfloor \quad (11)$$

then, the two nodes N_i, N_j are time aligned and the difference between the emission and the reception cycles is constant, equal to

$$\delta^{i,j} = \left\lfloor \frac{U_{i,j}(S)}{T} \right\rfloor = \left\lfloor \frac{L_{i,j}(S)}{T} \right\rfloor \quad (12)$$

If all clocks are perfect, the values of L and U become

$$L_{i,j}(S) = S + \underline{E}_{i,j} + \underline{P}_{i,j} + o_i - o_j, \quad (13)$$

$$U_{i,j}(S) = T - S + \overline{P}_{i,j} + \overline{z}_j + o_i - o_j. \quad (14)$$

The condition (11) then expresses that the guard band S and the offsets o_i, o_j have to compensate the transmission, propagation and switching delays. With non-ideal clocks, there are additional terms in L and U : the former term, $\Delta_i + \Delta_j$, captures the synchronization accuracy whereas the latter term, namely \widehat{l} or \widehat{u} , captures the effect of supplementary non-idealities. The values in the theorem then add some margin in order to account for clock non-idealities.

The term $\delta^{i,j}$ represents the difference in cycle number. At first glance, one may expect, up to some normalisation, to always have $\delta^{i,j} = 0$ *i.e.* a frame sent a cycle k is received at cycle k . But as will be shown in the experiments (Section 5.3, Figure 20), one may introduce some phase between the offsets to absorb the propagation time and reduce the guard band. When this strategy is used on a non feed-forward network (a network with cycles) with large propagation time (*i.e.* when the sum of the propagation times is more than half of the cycle time T), some non null $\delta^{i,j}$ will appear.

Sketch of proof. The proof consists in bounding the reception time of frames sent by the node N_i to the node N_j in one cycle. To this end, we consider two frames, the former being sent as early as possible and the latter as late as possible. Let t, t' be the respective reception instants. Since both have to be received in the same cycle, it implies $\lfloor \frac{c_j(t) - o_j}{T} \rfloor = \lfloor \frac{c_j(t') - o_j}{T} \rfloor$ (where c_j is the clock of N_j). Then, we use the conditions on clocks to compute a lower bound on the former expression and an upper bound on the latter. \square

The full proof is given in Appendix D.

The values of $L_{i,j}(S)$ and $U_{i,j}(S)$ depend on S in a non linear way. In Section 5 we are interested in computing offsets that minimize S ; this non-linearity leads to MILPs with many binary variables, which quickly become intractable. This motivates us to derive from Theorem 1 the simpler sufficient condition in Coro. 1, which, as we show in Section 4.3, remains very close. To this end, first observe that, by (1), we must have

$$S \leq \overline{S} := \frac{T - \max_{i,j} \overline{E}_{i,j}}{2} \quad (15)$$

Second, we use the following lower bound:

Property 1. *Let*

$$\underline{S} := \max_{i,j} \left(\frac{\overline{P}_{i,j} + \overline{z}_j - \underline{P}_{i,j} - \underline{E}}{2} + \Delta_i + \Delta_j \right) \quad (16)$$

If S satisfies the sufficient condition (11) in Theorem 1 for every pair i, j , then $S > \underline{S}$.

Proof. The proof is given in Appendix E. \square

This leads to the following, simpler, sufficient condition:

Corollary 1 (Simpler Sufficient Condition for Node Alignment). *Theorem 1 continues to hold if we replace $\widehat{l}_{i,j}(S)$ and $\widehat{u}_{i,j}(S)$ by $\widehat{l}_{i,j}(\overline{S})$ and $\widehat{u}_{i,j}(\underline{S})$, i.e. if we replace $L_{i,j}(S), U_{i,j}(S)$ by*

$$L'_{i,j}(S) = S + \underline{E}_{i,j} + \underline{P}_{i,j} + o_i - o_j - (\Delta_i + \Delta_j) - \widehat{l}_{i,j}(\overline{S}) \quad (17)$$

$$U'_{i,j}(S) = T - S + \overline{P}_{i,j} + \overline{z}_j + o_i - o_j + \Delta_i + \Delta_j + \widehat{u}_{i,j}(\underline{S}) \quad (18)$$

Proof. The proof is given in Appendix F. \square

Next, we study the set of values of the guard time S that, for given values of the offsets o_i, o_j , satisfy the sufficient condition in Theorem 1 or in Coro. 1. Specifically, we are interested in minimizing the value of S for given values of the offsets, which is given by the next theorem.

Theorem 2. *For given values of the offsets o_i, o_j , let $\mathcal{S}_{\text{thm1}}^{o_i, o_j}$ be the set of values of $S \in [0, \overline{S}]$ that satisfy the sufficient condition (11) in Theorem 1.*

- $\mathcal{S}_{\text{thm1}}^{o_i, o_j}$ is not empty if and only if \overline{S} satisfies (11);
- If $\mathcal{S}_{\text{thm1}}^{o_i, o_j}$ is not empty then there exists some $\underline{S}_{\text{thm1}}^{o_i, o_j} > 0$ such that

$$\mathcal{S}_{\text{thm1}}^{o_i, o_j} = (\underline{S}_{\text{thm1}}^{o_i, o_j}; \overline{S}]$$

or

$$\mathcal{S}_{\text{thm1}}^{o_i, o_j} = [\underline{S}_{\text{thm1}}^{o_i, o_j}; \overline{S}].$$

- If $\mathcal{S}_{\text{thm1}}^{o_i, o_j}$ is not empty, let $S_{\text{thm1}}^{*o_i, o_j}$ be the smallest value of $S \in \mathcal{S}_{\text{thm1}}^{o_i, o_j}$ obtained with binary search in the interval $[0, \overline{S}]$ with precision ε (this requires $\lceil \log_2 \frac{\overline{S}}{\varepsilon} \rceil$ steps). Then $S_{\text{thm1}}^{*o_i, o_j}$ is an ε -over-approximation of $\underline{S}_{\text{thm1}}^{o_i, o_j}$. i.e. $[S_{\text{thm1}}^{*o_i, o_j}; \overline{S}] \subset \mathcal{S}_{\text{thm1}}^{o_i, o_j}$ and $S_{\text{thm1}}^{*o_i, o_j} - \underline{S}_{\text{thm1}}^{o_i, o_j} \leq \varepsilon$.

The same holds mutatis mutandi with Corollary 1.

The proof is in Appendix G. The above theorem establishes that the set of feasible guard band durations is an interval, however, it may be closed or semi-closed, i.e., it is not certain that the infimum is feasible. This is because of the floor in (11), which leads to a discontinuous condition (see Lemma 10 in Appendix K for details). This means that, strictly speaking, there might not be a minimum value. In practice, however, we are interested in values expressed with some accuracy, say ε and the theorem means that, modulo a precision of ε , there is a minimum value $S_{\text{thm1}}^{*o_i, o_j}$, and any value above it and below \overline{S} is feasible. The same holds for the condition in Corollary 1, and since any S that satisfies Corollary 1 also satisfies Theorem 1, we always have $S_{\text{thm1}}^{*o_i, o_j} \leq S_{\text{cor1}}^{*o_i, o_j}$. Furthermore, we show numerically in Section 4.3 that the difference is small.

Last, the following property (proof in Appendix H) shows that the sufficient condition models the expected notion of slack: improving a clock can only reduce the value of the required guard band.

If the two nodes N_i, N_j are time aligned for any valid clock trajectory and any valid frame pattern and $\eta \leq \underline{E}_{i,j}$, then :

$$\left\lfloor \frac{\tilde{U}}{T} \right\rfloor = \left\lfloor \frac{\tilde{L}}{T} \right\rfloor \quad (29)$$

$$\text{and } \left\lfloor \frac{\tilde{U}_{\%}}{T} \right\rfloor \% 2 = \left\lfloor \frac{\tilde{L}_{\%}}{T} \right\rfloor \% 2 \quad (30)$$

$$\text{and } \left\lfloor \frac{\tilde{U}_s}{T} \right\rfloor = \left\lfloor \frac{\tilde{L}_s}{T} \right\rfloor \quad (31)$$

$$\text{and } \left\lfloor \frac{\tilde{U}_{\%s}}{T} \right\rfloor \% 2 = \left\lfloor \frac{\tilde{L}_{\%s}}{T} \right\rfloor \% 2 \quad (32)$$

and the difference between the emission and the reception cycle is constant, equal to $\delta^{i,j}$ with

$$\delta^{i,j} = \left\lfloor \frac{\tilde{U}}{T} \right\rfloor - \left\lfloor \frac{\tilde{L}}{T} \right\rfloor \quad (33)$$

An illustration of the Theorem 3 is provided in Figure 5. When clocks are perfect, the values become

$$\tilde{L}_{\%} = \tilde{L}_{\%s} = S + \underline{E}_{i,j} + \underline{P}_{i,j} + o_i - o_j = L \quad (34)$$

$$\tilde{U}_{\%} = \tilde{U}_{\%s} = T - S + \bar{P}_{i,j} + o_i - o_j = U - \bar{z}_j \quad (35)$$

$$\tilde{L} = \tilde{L}_s = S + \underline{E}_{i,j} + \underline{P}_{i,j} + z_j + o_i - o_j = L + z_j \quad (36)$$

$$\tilde{U} = \tilde{U}_s = T - S + \bar{P}_{i,j} + \bar{z}_j + o_i - o_j = U. \quad (37)$$

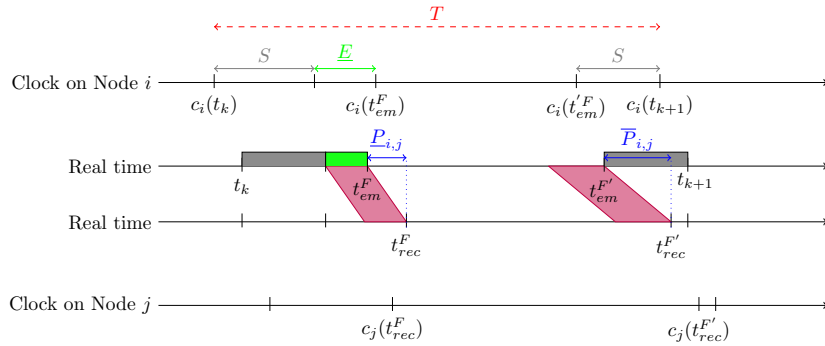

Figure 5: Illustration of Theorem 3.

Sketch of proof: The proof uses adversarial frame emission patterns as well as clock behaviours. It consists in sending a first frame F in the first cycle of N_i

as soon as possible, just after the opening guard band, and a second frame F' as late as possible, just before the closing guard band. In the proof, t_0 denotes the instant when the first cycle starts (*i.e.* $c_i(t_0) - o_i = 0$), and t_1 is the instant when the last bit of F is sent (*i.e.* $c_i(t_1) = c_i(t_0) + S + \underline{E}$), and t_2 the instant when the last bit of F' is sent (*i.e.* $c_i(t_2) = c_i(t_0) + T - S$). Let $t_{rec}^F, t_{rec}^{F'}$ denote the reception instants of F and F' . In order to maximize the difference between $c_j(t_{rec}^F)$ and $c_j(t_{rec}^{F'})$, while satisfying the set of constraints, we consider that the clock c_i run as fast as possible on $[t_0, t_1]$ and as slowly as possible on $[t_1, t_0 + T]$ while the clock c_j runs as fast as possible from t_{rec}^F , as illustrated in Figure 5. \square

The full proof is given in Appendix I.

For given values of the offsets o_i, o_j , let \mathcal{S}^{o_i, o_j} be the set of values of S that satisfy the exact but intractable conditions in (5), (6) and let $\mathcal{S}_{\text{thm3}}^{o_i, o_j}$ be the set of values of S that satisfy the necessary condition of Theorem 3. It follows that

$$\mathcal{S}_{\text{thm3}}^{o_i, o_j} \subset \mathcal{S}^{o_i, o_j} \subset \mathcal{S}_{\text{thm1}}^{o_i, o_j} \subset \mathcal{S}_{\text{cor1}}^{o_i, o_j} \quad (38)$$

In the next section we will compare these sets. Note that, while $\mathcal{S}_{\text{thm1}}^{o_i, o_j}$ and $\mathcal{S}_{\text{cor1}}^{o_i, o_j}$ are intervals, it is not clear whether the same holds for $\mathcal{S}_{\text{thm3}}^{o_i, o_j}$ and \mathcal{S}^{o_i, o_j} . However, let $\underline{\mathcal{S}}_{\text{thm3}}^{o_i, o_j} = \inf \mathcal{S}_{\text{thm3}}^{o_i, o_j}$, which we numerically compute by brute force, thus obtaining an ε -lower approximation $\mathcal{S}_{\text{thm3}}^{*o_i, o_j}$. It follows that the length of $\mathcal{S}^{o_i, o_j} \setminus \mathcal{S}_{\text{thm1}}^{o_i, o_j}$ is upper bounded by $\mathcal{S}_{\text{thm1}}^{*o_i, o_j} - \mathcal{S}_{\text{thm3}}^{*o_i, o_j}$, which thus bounds the pessimism of the sufficient condition in Theorem 1 (and similarly with Corollary 1)

4.3 Comparing the Three Conditions

We have obtained two sufficient conditions (Theorem 1 and Corollary 1) and one necessary condition (Theorem 3). To evaluate the tightness of the sufficient conditions, we compute the values of $\mathcal{S}_{\text{thm1}}^{*o_i, o_j} - \mathcal{S}_{\text{thm3}}^{*o_i, o_j}$ and $\mathcal{S}_{\text{cor1}}^{*o_i, o_j} - \mathcal{S}_{\text{thm1}}^{*o_i, o_j}$ for random values of the offsets and other parameters, as represented in Table 2.

We draw 100 000 configurations and take $\varepsilon = \bar{S}.10^{-10}$. We obtain $\mathcal{S}_{\text{thm1}}^{*o_i, o_j}$ and $\mathcal{S}_{\text{cor1}}^{*o_i, o_j}$ by binary search and $\mathcal{S}_{\text{thm3}}^{*o_i, o_j}$ by scanning all values between 0 and $\mathcal{S}_{\text{thm1}}^*$ with a step of 10 ns. Note that for 4231 configurations there is no solution, *i.e.* the parameters don't allow to find any valid guard band value. The results are shown on Figure 6.

As we can see, the two sufficient conditions are close: The maximum difference between them is around $0.2\mu\text{s}$ and the average difference is around $0.05\mu\text{s}$. Thus, the condition in Corollary 1 is satisfactory because it is easier to compute and quite close to Theorem 1.

Moreover, we see that the difference between the sufficient and the necessary condition is around $0.1\mu\text{s}$ and the maximum difference is around $6\mu\text{s}$. However, on this set of configurations, only 9 values are greater than $1\mu\text{s}$ (0.01% of the configurations). Thus, we can consider that we are close enough to the true (intractable) solution by using the sufficient condition.

Table 2: Random Parameters (μs) for Figure 6. Nodes i, j are fixed, $o_i = 0$, $\underline{P}_{i,j} = P - p$ and $\overline{P}_{i,j} = P + p$.

Random values (in μs , except for ρ , unitless)			
P	p	\bar{z}_j	\underline{z}_j
[0; 200]	[0.01; 0.1] * P	[0; 15]	[0; \bar{z}]
o_j	Δ	ρ	η
[0; 1000]	[0; 1]	$1 + [0; .0002]$	[0; .002]

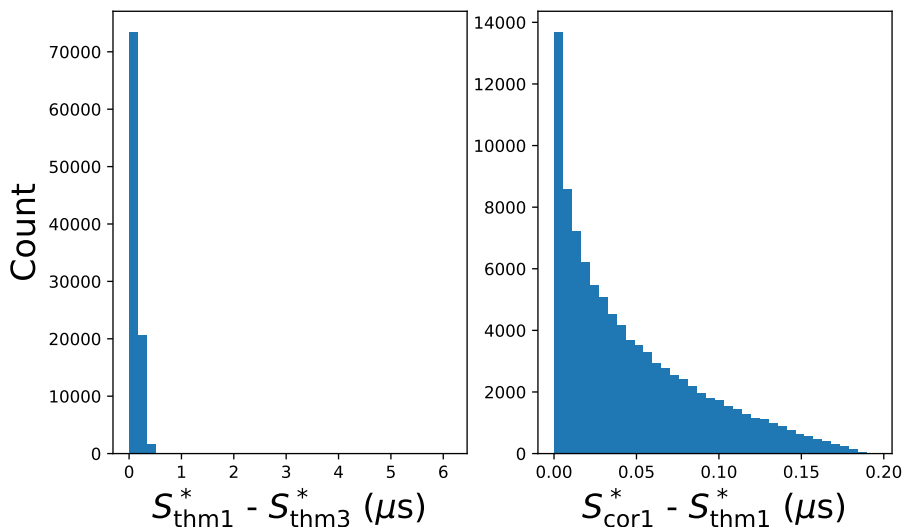

Figure 6: Histogram of the difference between the conditions.

4.4 Effect of Clock Non Idealities

The incorporation of clock non idealities brings some complexity to the analysis. In this section we test whether such a modelling accuracy is really necessary. We consider a representative configuration as in Table 3 and consider the effect of the following three factors in the analysis: (1) propagation jitter $2p$ and switching time \bar{z} ; (2) clock synchronization error Δ ; (3) clock jitter and drift parameters ρ, η . This leads to the following four scenarios:

- 'Perfect': propagation jitter and switching times are null and clocks are perfect. This is the assumption done in most of the literature.
- 'Perfect clock, default other': propagation jitter and switching times are considered but clocks are perfect.
- 'Default': considers all elements described in this paper.

Table 3: Effect of clock non-idealities. Nodes i, j are fixed, $\underline{P}_{i,j} = P - p$ and $\overline{P}_{i,j} = P + p$.

Values for all scenarios.				
T	P	\underline{z}_j	o_i	o_j
1ms	100 μ s	0	0	100 μ s
\underline{E}_{ij}		\overline{E}_{ij}		
0.672 μ s		12.384 μ s		

	Perfect	Perfect clock, default other	Default	Default, synchro- nization only
p	0	0.5 μ s	0.5 μ s	0.5 μ s
\overline{z}_j	0	15 μ s	15 μ s	15 μ s
Δ	0	0	1 μ s	1 μ s
ρ	1	1	1.0001	$+\infty$
η	0	0	2ns	$+\infty$
S_{cor1}^*	2.9e-8 μ s	15.5 μ s	17.7 μ s	21.5 μ s
S_{thm1}^*	2.9e-8 μ s	15.5 μ s	17.7 μ s	21.5 μ s
S_{thm3}^*	2.9e-8 μ s	15.5 μ s	17.5 μ s	17.5 μ s

- 'Default, synchronization only': This captures the result of a simplified analysis that captures clock synchronization accuracy but ignores bounds on clock jitter and drift.

The resulting S^* are computed as in the previous section, and the results are shown in Table 3. We observe that, with the perfect configuration, all the resulting S^* are approximately equal to 0 (not exactly, due to the tolerance ε). However, with the other scenarios, the resulting S^* are all non negligible and cause a loss of about 3-4 percent of the cycle time for this single configuration. Most of it comes from system delays (3%), and clock errors add another .5%. Last, ignoring clock drift and jitter bounds induces an increase in the guard band by .5% for the sufficient conditions and increases the gap between the necessary and the sufficient condition. Thus, the model including the clock drift and jitter bounds is significantly better than the one only considering the clock synchronization.

This suggests that we can't ignore the non idealities; this is confirmed by the thorough experiments in Section 5.3.

5 Computing the guard band and the offsets

In the previous section we have shown that Corollary 1 obtains a quasi-optimal condition to decide whether some guard band value S is admissible and gives a method to test whether some feasible guard band exists at all. Furthermore, we have shown that there is an infimal value $\underline{S}_{\text{cor1}}^{o_i, o_j}$, for given values of time offsets o_i, o_j , which may or may not be admissible, but such that any value in the range $(\underline{S}_{\text{cor1}}^{o_i, o_j}, \bar{S}]$ is admissible with respect to the constraints on link (i, j) . We have also given a method to compute an ε over-approximation, $S_{\text{cor1}}^{*o_i, o_j}$, of $\underline{S}_{\text{cor1}}^{o_i, o_j}$, which can be interpreted as a minimal guard band value, given offsets.

If the values of the offsets are imposed or given by some oracle, the infimal guard band is then equal to $\max_{(i,j) \in \mathcal{L}} \underline{S}_{\text{cor1}}^{o_i, o_j}$, since it must satisfy the constraints on every link. However, as we show below, the values of the time offsets largely influence the infimal guardband. Therefore, we are interested in solving

$$\begin{aligned} & \mathbf{Problem (P):} \\ & \text{minimize } \max_{(i,j) \in \mathcal{L}} \underline{S}_{\text{cor1}}^{o_i, o_j} \\ & \text{over } (o_i)_{i=1:I} \in [0; T]^I \end{aligned}$$

where, by convention, $\underline{S}_{\text{cor1}}^{o_i, o_j} = +\infty$ if Corollary 1 gives no admissible guardband for these values of o_i, o_j . In the above, \mathcal{L} is the set of links and I is the number of nodes. If Problem (P) has a solution, say \underline{S} , then any S that satisfies $\underline{S} < S \leq \bar{S}$ is a valid guard band.

We first give two simple, heuristics that correspond to common practices; then we derive a MILP formulation of Problem (P).

5.1 Heuristics

Recall that the condition in Corollary 1 is:

$$\left\lfloor \frac{U'_{i,j}(S)}{T} \right\rfloor = \left\lfloor \frac{L'_{i,j}(S)}{T} \right\rfloor \quad (39)$$

where $L'_{i,j}, U'_{i,j}$ are defined in (17) and (18)

5.1.1 Null offset

This solution consists in aligning all offsets, which, without loss of generality, can be written as $o_i = o_j = 0$. The condition in (39) becomes:

$$\begin{aligned} & \left\lfloor \frac{S + \underline{E}_{i,j} + \underline{P}_{i,j} - (\Delta_i + \Delta_j) - \widehat{l}_{i,j}(\bar{S})}{T} \right\rfloor \\ & = \left\lfloor \frac{T - S + \bar{P}_{i,j} + \bar{z}_{i,j} + \Delta_i + \Delta_j + \widehat{u}_{i,j}(\underline{S})}{T} \right\rfloor \end{aligned} \quad (40)$$

The general case is complicated (see Appendix J), but can be considerably simplified when the cycle time is large compared to propagation and transmission. Specifically, consider the following condition, stating that the clock error term $\hat{l}_{i,j}$ is small with regards to emission, propagation and switching times, that also are smaller than the cycle time:

$$0 \leq \underline{E}_{i,j} + \underline{P}_{i,j} + \overline{P}_{i,j} + \overline{z}_{i,j} + \hat{u}_{i,j}(\underline{S}) - \hat{l}_{i,j}(\overline{S}) < T. \quad (41)$$

If this condition holds for every i, j , then the floor functions in (40) are null (see Appendix J, (300)), implying

$$0 \leq S + \underline{E}_{i,j} + \underline{P}_{i,j} - (\Delta_i + \Delta_j) - \hat{l}_{i,j}(\overline{S}) < T \quad (42)$$

$$0 \leq T - S + \overline{P}_{i,j} + \overline{z}_{i,j} + \Delta_i + \Delta_j + \hat{u}_{i,j}(\underline{S}) < T. \quad (43)$$

Consequently,

$$S \geq (\Delta_i + \Delta_j) + \hat{l}_{i,j}(\overline{S}) - \underline{E}_{i,j} - \underline{P}_{i,j} \quad (44)$$

$$S > \overline{P}_{i,j} + \overline{z}_{i,j} + \Delta_i + \Delta_j + \hat{u}_{i,j}(\underline{S}) \quad (45)$$

However, since (41) holds, then

$$\overline{P}_{i,j} + \overline{z}_{i,j} + \hat{u}_{i,j}(\underline{S}) \geq \hat{l}_{i,j}(\overline{S}) - \underline{E}_{i,j} - \underline{P}_{i,j} \quad (46)$$

It follows that the infimum of S is

$$S_{\text{null}} = \max_{i,j} \{ \overline{P}_{i,j} + \overline{z}_{i,j} + \Delta_i + \Delta_j + \hat{u}_{i,j}(\underline{S}) \}. \quad (47)$$

i.e., if (41) holds for every i, j and $S_{\text{null}} < \overline{S}$, then any S in $(S_{\text{null}}, \overline{S}]$ is an admissible value for the guard band.

As expected, the guard band needs to absorb terms related to the clock imperfections $(\Delta_i, \Delta_j, \hat{u}_{i,j}(\underline{S}))$ but it also has to absorb the maximal propagation and maximal switching times $(\overline{P}_{i,j}, \overline{z}_{i,j})$.

In the general case (when (41) does not hold for some i, j) the expression of S_{null} is more complicated and is given in Appendix J.

5.1.2 Absorbing the propagation with offsets

The standard suggests to set the guard band such that it compensates the “jitter in the propagation time”, whereas the expression in eq. (47) involves the propagation itself, not its jitter. This suggests another strategy, where the offsets are set to compensate the average propagation time.

Let P be the mid propagation time between the node i and the node j , and $p_{i,j}$ the semi-variation, i.e.:

$$P_{i,j} = \frac{\underline{P}_{i,j} + \overline{P}_{i,j}}{2}, \quad p_{i,j} = P_{i,j} - \underline{P}_{i,j} = \overline{P}_{i,j} - P_{i,j}. \quad (48)$$

Assume that we can choose o_i and o_j such that

$$o_j = o_i + P_{i,j} \quad (49)$$

then the condition 39 becomes:

$$\begin{aligned} & \left| \frac{S + \underline{E}_{i,j} - p_{i,j} - (\Delta_i + \Delta_j) - \widehat{l}_{i,j}(\overline{S})}{T} \right| \\ &= \left| \frac{T - S + p_{i,j} + \overline{z}_{i,j} + \Delta_i + \Delta_j + \widehat{u}_{i,j}(\underline{S})}{T} \right| \end{aligned} \quad (50)$$

As Equation (1) is respected, we know that

$$S + \underline{E}_{i,j} - p_{i,j} - (\Delta_i + \Delta_j) - \widehat{l}_{i,j}(\overline{S}) \quad (51)$$

$$\leq \underline{E}_{i,j} + S \quad (52)$$

$$\leq T - S < T \text{ because } S > 0. \quad (53)$$

So, it comes $\left| \frac{S + \underline{E}_{i,j} - p_{i,j} - (\Delta_i + \Delta_j) - \widehat{l}_{i,j}(\overline{S})}{T} \right| = 0$. Consequently, $\left| \frac{T - S + p_{i,j} + \overline{z}_{i,j} + \Delta_i + \Delta_j + \widehat{u}_{i,j}(\underline{S})}{T} \right| = 0$, thus

$$T - S + p_{i,j} + \overline{z}_{i,j} + \Delta_i + \Delta_j + \widehat{u}_{i,j}(\underline{S}) < T \quad (54)$$

$$S > p_{i,j} + \overline{z}_{i,j} + \Delta_i + \Delta_j + \widehat{u}_{i,j}(\underline{S}). \quad (55)$$

It follows that the infimum of S is

$$S_{\text{prop}} = \max_{i,j} \left\{ \frac{\overline{P}_{i,j} - \underline{P}_{i,j}}{2} + \overline{z}_{i,j} + \Delta_i + \Delta_j + \widehat{u}_{i,j}(\underline{S}) \right\}. \quad (56)$$

In other words, if for every link $(i, j) : o_j = o_i + \frac{\overline{P}_{i,j} + \underline{P}_{i,j}}{2}$, and $S_{\text{prop}} < \overline{S}$, then any S in $(S_{\text{prop}}, \overline{S}]$ is an admissible value for the guard band.

As expected, the guard band needs to absorb terms related to the clock imperfections $(\Delta_i, \Delta_j, \widehat{u}(\underline{S}))$ but it also has to absorb the jitter of the propagation time and the maximal switching time.

However, having (49) simultaneously at all links i, j is not always possible, for example when a switch has several inputs (as switch SW4 in Figure 2) or in case of cyclic dependency (in case of a ring).

5.1.3 Comparing the Two Heuristics

Observe that $S_{\text{prop}} < S_{\text{null}}$, i.e. setting the offsets to absorb the propagation time, when it is possible, always gives a smaller (i.e. better) guard band than when aligning all offsets. For a single pair of nodes, the difference is $\frac{\overline{P}_{i,j} + \underline{P}_{i,j}}{2}$ i.e. the median propagation delay. Considering a propagation speed being 60% of light speed, as in [14, N.6] (that is to say, 0.18m/ns) it takes 0.11 μ s to cross

a 20m cable, and in a Metropolitan Area Network (MAN), a 20km cable will have a transmission delay of 0.11ms. At 1Gb/s, 0.11ms is the transmission time of 110Kb of data.

The fact that S_{prop} can be significantly smaller than S_{null} indicates that the time offsets do have an important effect on the minimum guard band. However, the heuristic that leads to S_{prop} imposes strict constraints on the network topology, and is often not applicable. This motivates us to find a solution to Problem (P), i.e. to compute time offsets that minimize the guard band.

5.2 Using a MILP Solver

In this section we derive a method to solve Problem (P). First notice that, from (39), Problem (P) is equivalent to

$$\begin{aligned} & \mathbf{Problem (P')}: \\ & \text{minimize} \\ & \text{over } S \in [0, \bar{S}], (o_i)_{i=1:I} \in [0; T]^I, \\ & \text{subject to } \left\lfloor \frac{U'_{i,j}(S)}{T} \right\rfloor = \left\lfloor \frac{L'_{i,j}(S)}{T} \right\rfloor, \forall (i, j) \in \mathcal{L} \end{aligned}$$

(Note that, in the above, $L'_{i,j}, U'_{i,j}$ depend on o_i, o_j .)

Because we always have $L'_{i,j} \leq U'_{i,j}$, the last condition is equivalent to

$$\left\lfloor \frac{L'_{i,j}(S)}{T} \right\rfloor \geq \left\lfloor \frac{U'_{i,j}(S)}{T} \right\rfloor, \quad (57)$$

which, by Property 5 in Appendix E, is equivalent to

$$\exists k_{i,j} \in \mathbb{Z}, k_{i,j} \leq \frac{L'_{i,j}(S)}{T} \text{ and } \frac{U'_{i,j}(S)}{T} < k_{i,j} + 1. \quad (58)$$

Therefore, Problem (P') is equivalent to

$$\begin{aligned} & \mathbf{Problem (P'')}: \\ & \text{minimize } S \quad (59) \\ & \text{over } S \in [0, \bar{S}], (o_i)_{i=1:I} \in [0; T]^I, (k_{i,j})_{(i,j) \in \mathcal{L}} \in \mathbb{Z}^{\mathcal{L}} \\ & \text{subject to} \\ & k_{i,j} \leq \frac{L'_{i,j}(S)}{T}, \frac{U'_{i,j}(S)}{T} < k_{i,j} + 1, \forall (i, j) \in \mathcal{L} \end{aligned}$$

Because of the strict inequality in its last condition, Problem (P'') is ill-posed (its infimum might not be attained) and cannot be solved as is by MILP solvers. To circumvent this, we replace it by the following MILP, in which the strict inequality is modified to an inclusive inequality, using the same tolerance ε as

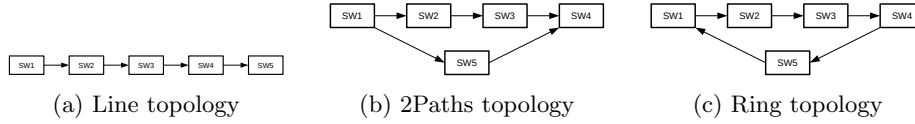

Figure 7: Three simple graphs

before:

Problem (P -MILP):

minimize S

over $S \in [0, \bar{S}]$, $(o_i)_{i=1:I} \in [0; T]^I$, $(k_{i,j})_{(i,j) \in \mathcal{L}} \in \mathbb{Z}^{\mathcal{L}}$

subject to

$$k_{i,j} \leq \frac{L'_{i,j}(S)}{T}, \quad \frac{U'_{i,j}(S)}{T} \leq k_{i,j} + 1 - \frac{\varepsilon}{T}, \quad \forall (i,j) \in \mathcal{L}$$

The following theorem establishes that Problem (P -MILP) provides an ε -over-approximation of the infimum of Problem (P), as required.

Theorem 4. *Let S_{MILP} be the optimum value of S returned by Problem (P -MILP). It is an ε -over-approximation of the value \underline{S} returned by Problem (P), i.e. $0 \leq S_{\text{MILP}} - \underline{S} \leq \varepsilon$. Furthermore, the values of S_{MILP} and of the offsets returned by S_{MILP} are valid.*

The proof is in Appendix K. It follows that we can use a MILP solver with Problem (P -MILP) and obtain the minimal value of the guard band S at precision ε , together with the values of the offsets. Specifically, if Problem (P -MILP) is feasible, the returned value of S_{MILP} and of the offsets are valid and S_{MILP} is optimal at precision ε . Note that for Problem (P) it is not certain that the optimal value \underline{S} is valid because we don't know in general whether the infimum of Problem (P) is attained; the last statement in the theorem recalls such a complication may not happen with Problem (P -MILP).

5.3 Experiments

In the rest of this section, we apply the two heuristics and the MILP formulation to the three network topologies in Figure 7 and compare the corresponding optimal values of guard bands, namely, S_{null} , S_{prop} and S_{milp} .

The parameters are described in Table 4. We vary the propagation time (P), the jitter of the propagation ($2p$), the upper bound of the switching time (\bar{z}) and the parameters of the clocks (Δ, η, ρ). All nodes have the same parameters ($\forall i, j, \underline{P}_{i,j} = P - p, \bar{P}_{i,j} = P + p, \Delta_i = \Delta, \eta_i = \eta, \rho_i = \rho$). The “perfect” correspond to ideal clocks and negligible switching time. Except if mentioned otherwise, if a configuration is said “perfect” [resp. “default”], all parameters have the perfect resp. [default] values as in Table 4.

The time offsets are defined up to a common time shift, and we set $o_1 = 0$ in all experiments.

Table 4: Parameters used with the three topologies in Figure 7.

Constant values					
T	\underline{E}	ϵ			
0.001s	$6,72 * 10^{-7}$ s	10^{-10}			

Perfect values					
P	p	\bar{z}	Δ	ρ	η
0.1ms (0.05ms for the ring)	0	0	0	1	0

Default values					
P	p	\bar{z}	Δ	ρ	η
0.1ms (0.05ms for the ring)	0.5μ s	15μ s	1μ s	1.0001	2 ns

5.3.1 Line

We start with the simple line illustrated in Figure 7a. Each experiment considers a perfect and a default configuration and varies one parameter. Figures 8 to 11 plot S_{null} (upper line), S_{prop} and S_{milp} (medium line) as well as the optimal offsets computed by the MILP (bottom line). The left row presents the perfect configuration, and the right row presents the default configuration.

- Experiment L.1, Figure 8: The propagation time P varies from 0 to 0.1ms by steps of 10μ s.

Observations: For the perfect configuration, the guard band with all null offsets S_{null} grows up linearly with the propagation time. In contrast, the guard bands computed by absorbing the propagation time or using the MILP are quasi null: the MILP computes null values, and the others return the tolerance ϵ . The MILP computes the same offsets as the heuristics based on propagation absorption, setting $o_{i+1} = o_i + P_{i+1,i}$.

The introduction of non null jitters and imperfect clocks does not change the trends but increases the guard band values: the MILP computes a guard band S_{milp} around 10μ s whereas the propagation absorption heuristics computes S_{prop} around 18μ s. The offsets computed by the MILP are also slightly increased.

- Experiment L.2, Figure 9: The propagation jitter parameter p varies from 0 to 1.5 times \underline{E} by steps of 0.1.

Observations: In the perfect configuration, S_{null} and S_{prop} increase linearly w.r.t. the semi-variation of the propagation p . When $p \leq \frac{\underline{E}}{2}$ the MILP solver finds a null guard band by setting $o_{i+1} = o_i + P_{i+1,i} + p$. But as shown by Prop. 1, if $p > \frac{\underline{E}}{2}$ which is equivalent to $2p = \bar{P} - \bar{P} > \underline{E}$, S cannot be null. Then the MILP solver finds $S = p - \frac{\underline{E}}{2}$ and $o_{i+1} = o_i + P + \frac{\underline{E}}{2}$.

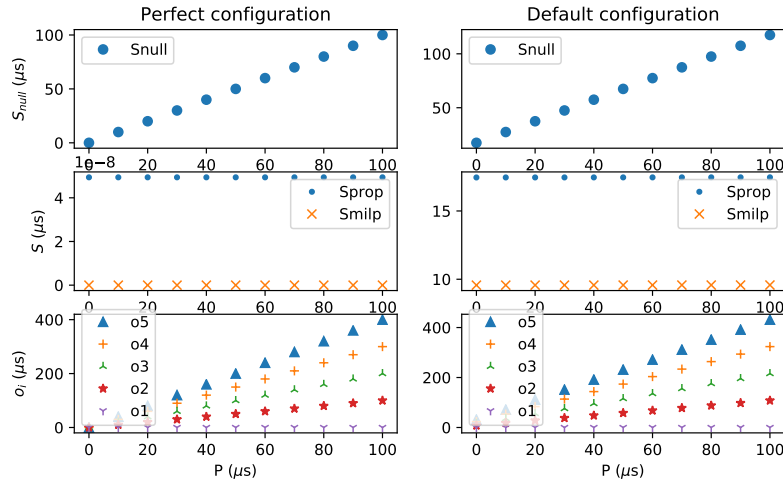

Figure 8: Exp L.1: Guard bands (upper panels) and optimal offsets (bottom panel) versus mean propagation time P (Line topology).

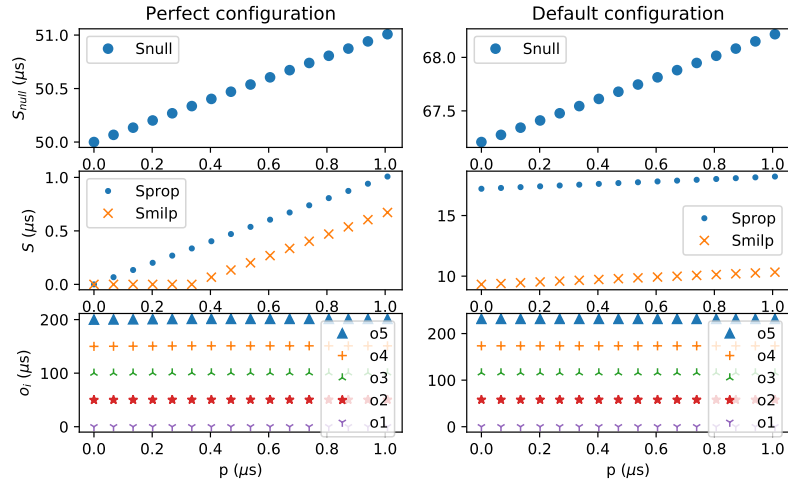

Figure 9: Exp L.2: Guard bands (upper panels) and optimal offsets (bottom panel) versus propagation jitter parameter p (Line topology).

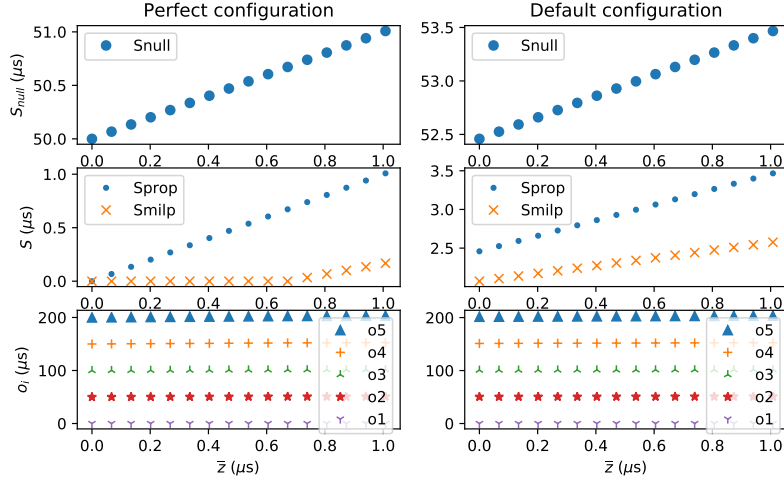

Figure 10: Exp L.3: Guard bands (upper panels) and optimal offsets (bottom panel) versus upper bound on switching delay \bar{z} (Line topology).

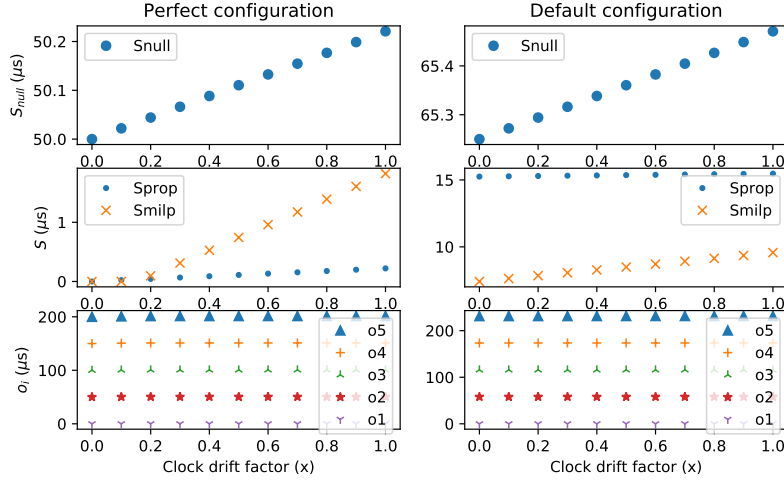

Figure 11: Exp L.4: Guard bands (upper panels) and optimal offsets (bottom panel) versus clock non-ideality factor x , where $\Delta = x\mu\text{s}$, $\eta = 2xns$, $\rho = 1 + 10^{-4}x$ (Line topology).

For the default configuration, we also see a linear increase, but starting at higher values, as in experiment L.1.

- Experiment L.3, Figure 10: The switching time upper-bound \bar{z} varies from 0 to 1.5 times \underline{E} by steps of 0.1.

Observations: In the perfect configuration, S_{null} and S_{prop} increase linearly w.r.t. the maximal switching time \bar{z} . In the perfect configuration, as long as $\bar{z} < \underline{E}$, the MILP solver finds a null guard, by setting $o_{i+1} = o_i + P_{i,j} + \bar{z}_j$. But as shown by Prop. 1, if $\bar{z} > \underline{E}$, S cannot be null. The choice of the offset still compensates the propagation, minus a compensation term $o_{i+1} \approx o_i + P_{i,j} + \frac{\underline{E} + \bar{z}}{2}$.

In the default configuration, we also see a linear increase, but starting at higher values, as in experiment L.1. It appears that the slopes are not the same: the MILP solver uses the offsets values to absorb a part of the jitter.

- Experiment L.4, Figure 11: The clock quality depends on a parameter x and ranges from perfect ($x = 0$) to default ($x = 1$) by steps of 0.1 ($\Delta = x\mu\text{s}$, $\eta = 2x\text{ns}$, $\rho = 1 + 10^{-4}x$).

Observations: Here, too, the guard band value increases linearly with same slope for all cases. The MILP solver sets $o_{i+1} - o_i = P$ and uses the guard band value to absorb the clock imprecision. Clock non-ideality adds several microseconds to the guard band but has little effect on the optimal offsets.

5.3.2 Feed-forward with two paths

We consider next the topology on Figure 7b, which has parallel paths. It follows that the propagation absorption heuristics cannot be applied: it is no more possible to set the downstream offset as the sum of the upstream offset and the propagation time since SW4 has two upstream offsets. Therefore, in Figures 12 to 15 we compare only the values of S_{null} and S_{milp} . We vary the same factors as with the line topology.

- Experiment F.1, Figure 12: The propagation time P varies from 0 to 0.1ms by steps of $10\mu\text{s}$.

Observations: In the perfect configuration, as with the line configuration, S_{null} increases as a linear function of P , from 0 to $100\mu\text{s}$. The optimal solution has $o_{i+1} = o_i + P$ on the shortest path and distributes the offsets along the longest path. The guard band S_{milp} increases to absorb the difference, from 0 to $20\mu\text{s}$, and is 5 times less than with the null heuristic. The default configuration has similar trends, but must compensate the clock imperfections.

- Experiment F.2, Figure 13: The propagation jitter parameter p varies from 0 to 1.5 times \underline{E} by steps of 0.1.

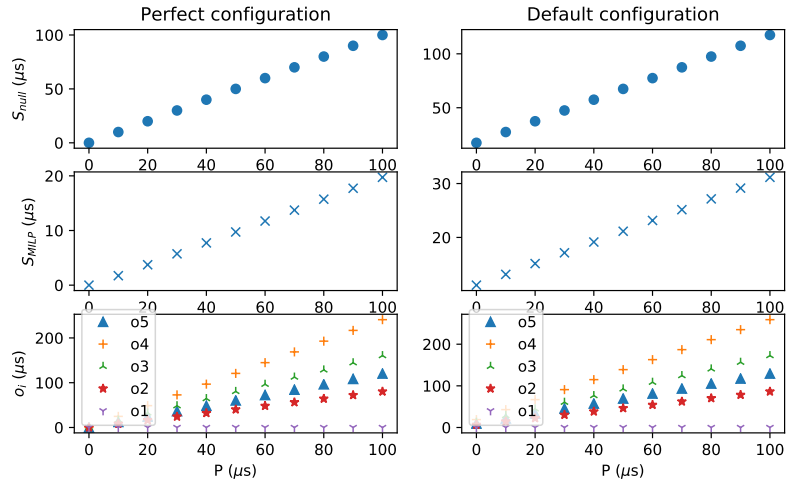

Figure 12: Exp F.1: Guard bands (upper panels) and optimal offsets (bottom panel) versus mean propagation time P (Feed-forward topology).

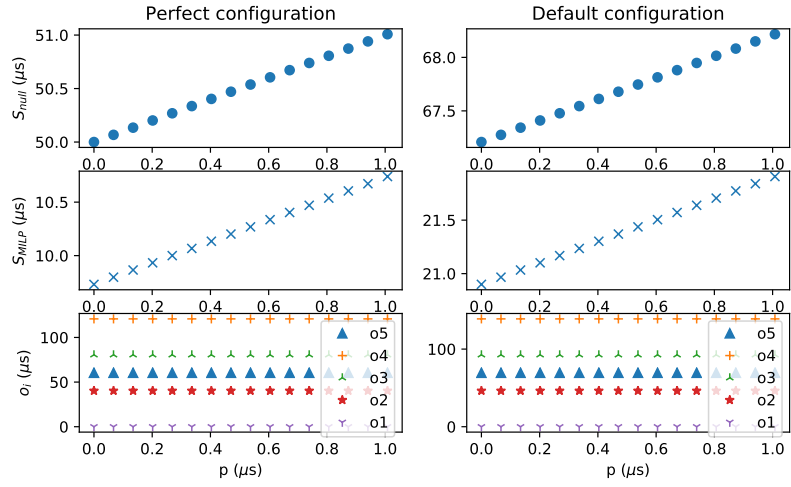

Figure 13: Exp F.2: Guard bands (upper panels) and optimal offsets (bottom panel) versus propagation jitter parameter p (Feed-forward topology).

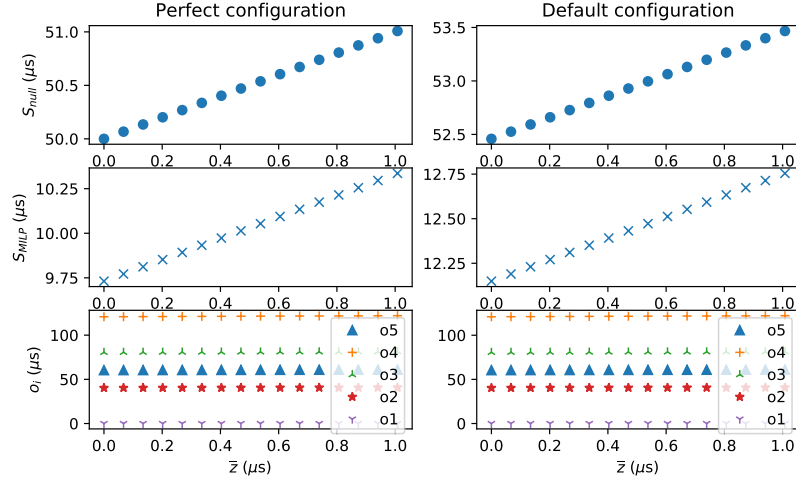

Figure 14: Exp F.3: Guard bands (upper panels) and optimal offsets (bottom panel) versus upper bound on switching delay \bar{z} (Feed-forward topology).

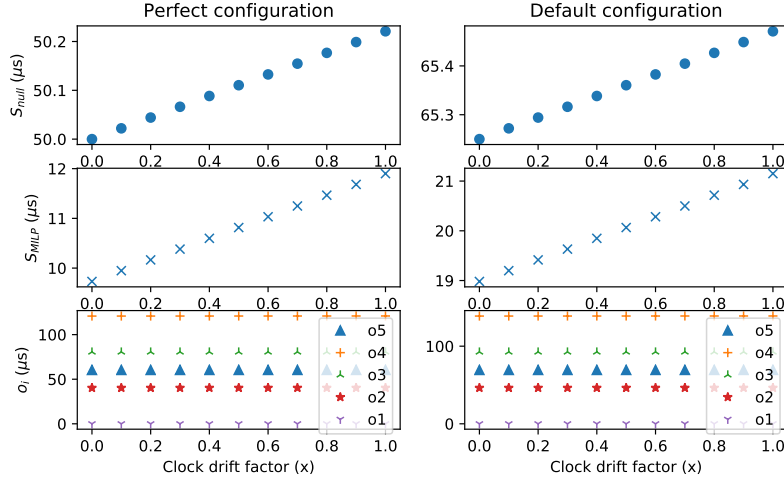

Figure 15: Exp F.4: Guard bands (upper panels) and optimal offsets (bottom panel) versus clock non-ideality factor x , where $\Delta = x\mu\text{s}$, $\eta = 2x\text{ns}$, $\rho = 1 + 10^{-4}x$ (Feed-forward topology).

Observations: As with previous cases, S_{null} increases as a linear function of p . This is also the case for S_{milp} : the optimal solution uses the same strategy as in F.1, namely, the optimal offsets compensate the propagation difference between the two paths, and S is increased to absorb the propagation jitter.

- Experiment F.3, Figure 14: The switching time upper-bound \bar{z} varies from 0 to 1.5 times \underline{E} by steps of 0.1.

Observations: The results are very similar, except that the S_{milp} values are smaller (from $22.25\mu\text{s}$ to $23\mu\text{s}$).

- Experiment F.4, Figure 15: The clock quality depends on a parameter x and ranges from perfect ($x = 0$) to default ($x = 1$) by steps of 0.1 ($\Delta = x\mu\text{s}$, $\eta = 2x\text{ns}$, $\rho = 1 + 10^{-4}x$).

Observations : The results are very similar to previous experiments. In particular, clock non-ideality adds several microseconds to the guard band but has little effect on the optimal offsets.

5.3.3 Ring

Last, we consider the ring topology in Figure 7c, which is the simplest topology with cyclic dependencies. Here, too, the propagation absorption heuristics cannot be applied as it requires to set the downstream offset to the sum of the upstream offsets, leading to a circular condition that has no solution. Therefore, in Figures 16 to 19 we compare only the values of S_{null} and S_{milp} . We vary the same factors as with the line topology.

- Experiment R.1, Figure 16: The propagation time P varies from 0 to 0.1ms by steps of $10\mu\text{s}$.

Observations: As with the previous experiments, the strategy based on null offsets creates a S_{null} that increases linearly to compensate the propagation time. When the propagation time is equal to 40% of the cycle time, 80% of the bandwidth is lost.

In contrast, the optimal value found by the MILP uses a different strategy. In the perfect configuration, when $P \in [0, 100\mu\text{s}]$, i.e. when $5P \in [0, T/2]$, the null offset is optimal and $S_{\text{null}} = S_{\text{milp}}$. This goes until $5P = T/2$, where 20% of the bandwidth is lost due to the guard band at the beginning and the end of each cycle. However, beyond this point, i.e. when $5P \in (T/2, T]$, the optimal solution sets $o_{i+1} = o_i + T/5$, i.e. the cycle time is uniformly distributed among the offsets and the guard band value decreases, down to the optimal case, when the total propagation time $5P$ is equal to the cycle time T . Then when P increases beyond this value, the minimal guard band increases again and the process repeats. The loss of bandwidth oscillates between 0 and 20%, whereas with the null offset heuristic, it increases linearly well beyond 20% (up to a point where the

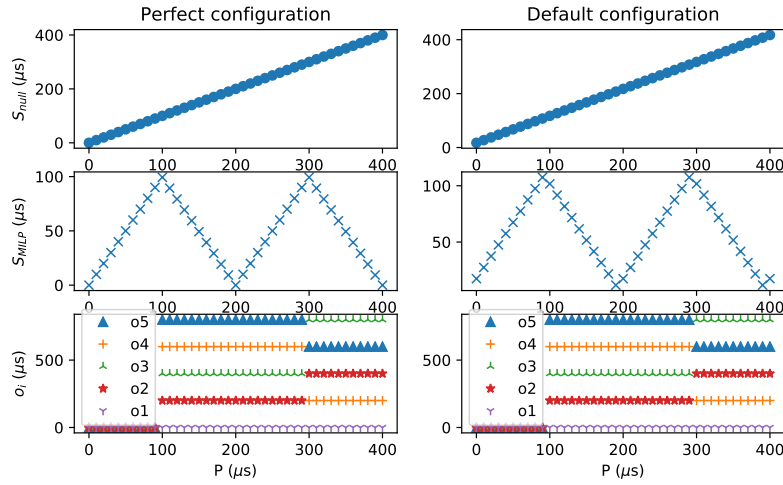

Figure 16: Exp R.1: Guard bands (upper panels) and optimal offsets (bottom panel) versus mean propagation time P (Ring topology).

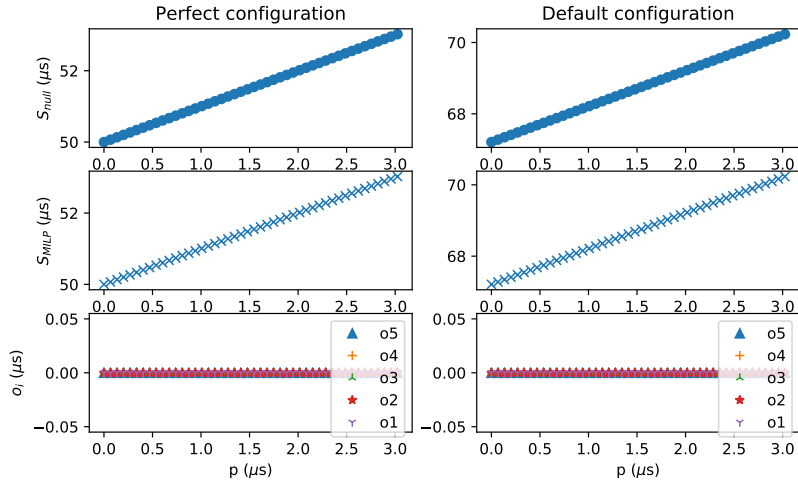

Figure 17: Exp R.2: Guard bands (upper panels) and optimal offsets (bottom panel) versus propagation jitter parameter p (Ring topology).

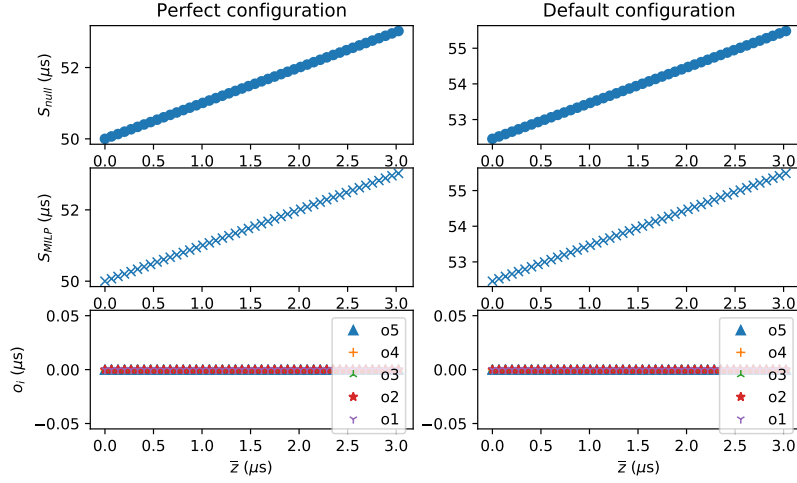

Figure 18: Exp R.3: Guard bands (upper panels) and optimal offsets (bottom panel) versus upper bound on switching delay \bar{z} (Ring topology).

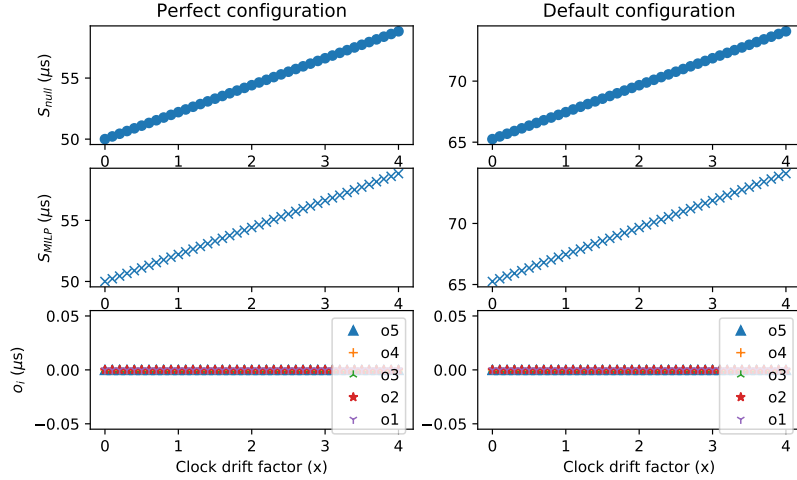

Figure 19: Exp R.4: Guard bands (upper panels) and optimal offsets (bottom panel) versus clock non-ideality factor x , where $\Delta = x\mu\text{s}$, $\eta = 2xns$, $\rho = 1 + 10^{-4}x$ (Ring topology).

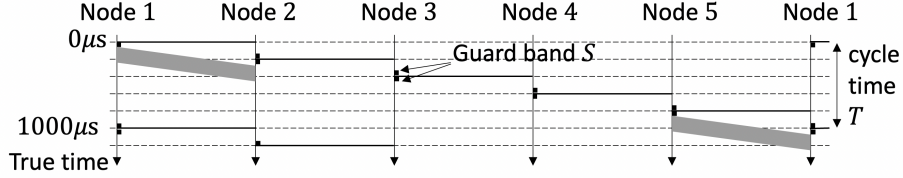

Figure 20: Ring topology: illustration of optimal offsets and guard band when the mean propagation time is $P = 150\mu s$, with otherwise default configuration. A frame sent by node 1 is received in the same cycle whereas a frame sent by node 5 is received in the next cycle.

null heuristic has no feasible guard band whereas the MILP solver always finds a solution.)

With the (realistic) default configuration, we see the same pattern but with some additional margin to account for the other non null parameters. It is enlightening to analyze the spatial distribution of offsets, as shown in Figure 20. Here the offsets are used to absorb the cycle time, and there is an index jump from node 5 to node 1, namely, a frame sent in cycle k_5 at node 5 is received in cycle $k_1 = k_5 + 1$ at node 1. A cycle jump does not occur when $P \leq 100\mu s$ but always occurs beyond.

- Experiment R.2, Figure 17: The propagation jitter parameter p varies from 0 to 1.5 times \underline{E} by steps of 0.1. *Observations:* Like in previous experiments, S_{null} increases linearly to compensate the propagation jitter. The optimal solution also selects null offsets, because the sum of the propagation time is smaller than half of the period ($5P \ll \frac{T}{2}$) and consequently S_{milp} also compensates the propagation jitter.
- Experiment R.3, Figure 18: The switching time upper-bound \bar{z} varies from 0 to 1.5 times \underline{E} by steps of 0.1. and $P = 50\mu s$.
Observations: The results are very similar to the experiment R.2, but the guard bands are smaller in the default configuration.
- Experiment R.4, Figure 19: The clock quality depends on a parameter x and ranges from perfect ($x = 0$) to default ($x = 1$) by steps of 0.1 ($\Delta = x\mu s$, $\eta = 2xns$, $\rho = 1 + 10^{-4}x$).
Observations: The results are very similar to experiments R.2 and R.3. We also see that clock non idealities add up to 15 microseconds to the guard band.

5.3.4 Summary of Observations.

A few lessons can be learnt from these experiments.

1. The choice of the offsets can dramatically reduce the guard band.

2. The non ideality parameters of clock, switching delay and propagation jitter affect the guardband; ignoring them leads to too small guardband.
3. In contrast, the values of the offsets are mainly influenced by topology and propagation latency, not significantly by other parameters.

5.4 Computing the Guard Band in Practice

We have presented 3 methods to compute the guard band:

- either setting null offsets in all nodes, and use the guard band value S_{null} , defined in eq. (47),
- or setting offsets in order to absorb the propagation time, and use the guard band value S_{prop} , defined in eq. (56),
- or use a MILP solver, presented in Problem (P-MILP).

The use of null offsets is the simplest, and can be used as long as the propagation time is small w.r.t. the cycle time (cf. (41)), but it will not give the best value since the guard band must absorb this propagation time (cf. Exp L.1, Exp F.1 and Exp R.1 presented respectively in Fig. 8, 12 and 16).

Setting offsets in order to absorb the propagation time allows to compensate this effect, but this is not possible for any topology (it is not possible if there exists two paths with different cumulated propagation times or if there are cyclic dependencies).

The last solution consist in using the MILP. One common drawback of MILP is the computation time. But thanks to its simplicity, the one presented in Problem (P-MILP) can be solved in a very short time. Each configuration presented in the experiment section in solved in less than 10ms (using `lp_solve` on a i5 /2.70GHz CPU, the `time` command return 0.00). To challenge the computation time, we have enlarged the ring topology to consider rings from 5 to 50 nodes with step 5. Each MILP was solved in less than 80ms.

Last, there exists a minimal granularity associated to the GCL: `TickGranularity` [10, §8.6.9.4.16] and the method may compute a guard band S that is not a multiple of `TickGranularity`. But thanks to Thm. 2, if S is a solution of Thm. 1, then $S_T = \text{TickGranularity} \left\lceil \frac{S}{\text{TickGranularity}} \right\rceil$ also is, as long as $S_T \leq \bar{S}$.

6 Related work

Several extensions of CQF have been proposed, like CQF 3-queues [15], Pater-noster [16], Scalable Deterministic Forwarding (SDF, [17]) and Cycle Specified Queuing and Forwarding (CSQF, [18]). A global survey can be found in [2].

All these extensions have been designed to overcome some limitations of CQF, but it seems that all authors consider that all CQF nodes have to align

their cycle time, i.e. have to share the same offset (cf. Section 5.1.1), whereas the standard does not explicitly states so.

Also note that all these extensions use 3 or even 4 queues, whereas Ethernet/TSN offers only 8 queues (or even less, depending on the implementation). Since a real-time network may have many types of traffic, each with specific requirements, the mapping from traffic types to only 8 TSN classes may become an issue [19].

A comparison between CQF and CBS on an automotive use case is done by simulation in [20], but without any consideration on the guard band.

The computed bounds assume that each CQF does not receive in once cycle more that what can be send in the next cycle. The Injection Time Planning (ITP) mechanism computes the global cycle time and a per-flow offsets for periodic flows in order to maximise the admissible load while satisfying this constraint [21]. The approach is generalised in [22] by adding in each End-System an “adapter” in charge of implementing the injection using a list of queues, and also by providing an online algorithms. It assumes that all offsets are equals, and the guard band only has to absorb the clock synchronization precision.

7 Conclusion

A lot of extensions of CQF have been defined to avoid the cost of the CQF guard band and the associated synchronisation effort, at the expense of the use of a third queue (or even of fourth queue). This paper allow an accurate evaluation of the cost of this guard band.

References

- [1] “IEEE Standard for Local and metropolitan area networks–Bridges and Bridged Networks–Amendment 29: Cyclic Queuing and Forwarding,” IEEE, IEEE Standard 802.1Qch, 2017.
- [2] A. Nasrallah, V. Balasubramanian, A. S. Thyagaturu, M. Reisslein, and H. ElBakoury, “Cyclic queuing and forwarding for large scale deterministic networks: A survey,” *ArXiv, vol. abs/1905.08478*, 2019.
- [3] B. Jonsson, S. Perathoner, L. Thiele, and W. Yi, “Cyclic dependencies in modular performance analysis,” in *Proc. of the 8th Int. Conf on Embedded Software (EMSOFT’08)*. ACM Press, 2008, pp. 179–188. [Online]. Available: <http://doi.acm.org/10.1145/1450058.1450083>
- [4] D. Starobinski, M. Karpovsky, , and L. Zakrevski, “Application of network calculus to general topologies using turn-prohibition,” in *Proceeding of the 21st Annual Joint Conference of the IEEE Computer and Communications Societies*, June 2002, pp. 411–421.

- [5] L. Thomas, J.-Y. Le Boudec, and A. Mifdaoui, “On cyclic dependencies and regulators in time-sensitive networks,” in *IEEE Real-Time Systems Symposium, RTSS 2019, Hong Kong, SAR, China, December 3-6, 2019*. IEEE, 2019, pp. 299–311. [Online]. Available: <https://doi.org/10.1109/RTSS46320.2019.00035>
- [6] D. Thiele, R. Ernst, and J. Diemer, “Formal worst-case timing analysis of ethernet tsn’s time-aware and peristaltic shapers,” in *2015 IEEE Vehicular Networking Conference (VNC)*, 2015, pp. 251–258.
- [7] L. Thomas and J.-Y. Le Boudec, “On time synchronization issues in time-sensitive networks with regulators and nonideal clocks,” *Proceedings of the ACM on Measurement and Analysis of Computing Systems*, vol. 4, no. 2, pp. 1–41, 2020.
- [8] A. Nasrallah, V. Balasubramanian, A. S. Thyagaturu, M. Reisslein, and H. ElBakoury, “Cyclic queuing and forwarding for large scale deterministic networks: A survey,” *ArXiv*, vol. *abs/1905.08478*, 2019.
- [9] “Ieee standard for local and metropolitan area networks—bridges and bridged networks—amendment 28: Per-stream filtering and policing,” IEEE, Standard 802.1Qci, 2017.
- [10] “IEEE standard for local and metropolitan area networks—bridges and bridged networks—amendment 25: Enhancements for scheduled traffic,” IEEE, IEEE Standard 802.1Qbv, 2015.
- [11] D. Thiele and R. Ernst, “Formal worst-case performance analysis of time-sensitive ethernet with frame preemption,” in *2016 IEEE 21st International Conference on Emerging Technologies and Factory Automation (ETFA)*. IEEE, 2016, pp. 1–9.
- [12] “IEEE/ISO/IEC International Standard for Information technology—Telecommunications and information exchange between systems—Local and metropolitan area networks—Part 1AS:Timing and synchronization for time-sensitive applications in bridged local area networks, ISO/IEC/IEEE 8802-1AS:2021(E),” 2021.
- [13] AEEC, “ARINC 664 P7-1: Aircraft data network, part 7, avionics full-duplex switched ethernet network,” Airlines Electronic Engineering Committee, Tech. Rep., september 2009.
- [14] “IEEE standard for local and metropolitan area networks – bridges and bridged networks,” IEEE, IEEE Standard 802.1Q, 2018.
- [15] N. Finn, J.-Y. Le Boudec, E. Mohammadpour, J. Zhang, J. Farkas, and B. Varga, “Detnet bounded latency-02,” <https://www.ietf.org/proceedings/103/slides/slides-103-detnet-07-detnet-bounded-latency-02.pdf>, Bangkok, November 8th 2018.

- [16] M. Seaman, “Paternoster policing and scheduling,” IEEE, Tech. Rep., May 2019, revision 2.1. [Online]. Available: <https://grouper.ieee.org/groups/802/1/files/public/docs2019/cr-seaman-paternoster-policing-scheduling-0519-v04.pdf>
- [17] L. Qiang, X. Geng, B. Liu, T. Eckert, L. Geng, and G. Li, “Large-scale deterministic ip network,” IETF, Internet-Draft draft-qiang-detnet-large-scale-detnet-05, 2019. [Online]. Available: <https://datatracker.ietf.org/doc/html/draft-qiang-detnet-large-scale-detnet-05>
- [18] M. G. Chen, G. Xuesong, and Z. Li, “Segment routing (sr) based bounded latency,” IETF, Internet-Draft draft-chen-detnet-sr-based-bounded-latency-01, May 2019. [Online]. Available: <https://datatracker.ietf.org/doc/html/draft-chen-detnet-sr-based-bounded-latency-01>
- [19] “Time-sensitive networking profile for industrial automation,” IEEE 802, Tech. Rep., 2021.
- [20] L. Leonardi, L. L. Bello, and G. Patti, “Performance assessment of the IEEE 802.1Qch in an automotive scenario,” in *Proc. of the AEIT Int. Conf. of Electrical and Electronic Technologies for Automotive (AEIT AUTOMOTIVE)*, 2020, pp. 1–6.
- [21] J. Yan, W. Quan, X. Jiang, and Z. Sun, “Injection time planning: Making cqf practical in time-sensitive networking,” in *Proc. of the 39th IEEE Conference on Computer Communications (INFOCOM 2020)*, 2020, pp. 616–625.
- [22] W. Quan, J. Yan, X. Jiang, and Z. Sun, “On-line traffic scheduling optimization in ieee 802.1 qch based time-sensitive networks,” in *Proc. of the Int. Conf. on High Performance Computing and Communications; Int. Conf. on Smart City; 6th Int. Conf. on Data Science and Systems (HPCC/SmartCity/DSS)*. IEEE, 2020, pp. 369–376.

A Details on implementation of CQF with PSFP and GCL

When a frame is fully received, it passes through several tests (such as CRC conformance, VLAN checking), and in particular, based on a stream id, it passes through some “filters”. The implementation of CQF consists in assigning an Internal Priority Value (IPV), defining in which queue of the output port it will be stored. The value depends on a time-driven table (“stream gate control list”). The table has a length “OperControlListLength” (L_s for short). Each entry $i \in [0, L_s - 1]$ has a state duration “TimeInterval” ($d_s(i)$ for short). The table has a total duration “OperCycleTime” (T_s for short), related with $\sum_{i=0}^{L_s-1} d_s(i) = T_s$, and a time origin “OperBaseTime” (O_s for short). For any $i \in [0, L_s - 1]$, let $IPV(i)$ denotes the IPV of the i -th entry of the table. The time-based decisions are based on the clock value “CurrentTime”. We denote by $c(t)$ the value CurrentTime at physical time t . Then, if a frame passes the PSFP filter at physical time t , it will be forwarded to the queue $IPV(i)$ where i is the current index, *i.e.* such that $\sum_{k=0}^{i-1} d_s(k) + kT_s \leq c(t) - O_s < \sum_{k=0}^i d_s(k) + kT_s$, with $k = \left\lceil \frac{c(t) - O_s}{T_s} \right\rceil$ the current cycle number. Note that there exists some delay between the output of the filtering and the arrival in this transmission queue, called in this paper “internal switching delay”, denoted with z .

A valid configuration of CQF consists in having a CQF cycle time T such that T_s is a multiple of $2T$ (for sake of simplicity, we assume here that $T_s = 2T$), L_s being even, and two dedicated queues $q_1, q_2 \in [0, 7]$ such that $i < n/2 \implies IPV(i) = q_1$ and $i \geq n/2 \implies IPV(i) = q_2$. During time intervals when $c(t) - O_s \in [2kT, (2k+1)T)$, called “even intervals” or “even cycle”, $IPV(\cdot) = q_1$ and otherwise, in “odd intervals”, $IPV(\cdot) = q_2$.

The output port also has a discrete time-driven table, with its own “OperControlListLength”, “TimeInterval”, “OperControlListLength” and “OperBaseTime”, denoted with L_o, d_o, T_o and O_o , with the constraint that $T_s = T_o$, based on the same clock c . There is no IPV in this table, but a gate state, that determines if each queue is either open or closed. The standard states that “during even numbered cycles, queue 1 accumulates received frames from the Bridge’s reception Ports and does not transmit them” meaning that during even cycles, the gate of the queue 1 is closed, whereas the one of queue 2 is open, and conversely for odd cycles.

The standard clearly imposes that the input stream gate control list cycles T_s and the output port control list T_o are multiple of $2T$, and we can assume without loss of generality that $T_s = T_o = 2T$. But it does not state anything about their respective OperBaseTime, O_s and O_o . For simplicity, we will assume in this paper that all input ports and output ports of a given switch have the same OperBaseTime.

B Proof of Equation (4)

Proof. The condition (3) can be also written $t - \Delta \leq c(t) \leq t + \Delta$, so by instantiating it twice

$$t + d - \Delta \leq c(t + d) \leq t + d + \Delta \quad (60)$$

$$\text{and } -t - \Delta \leq -c(t) \leq -t + \Delta \quad (61)$$

it comes $d - 2\Delta \leq c(t + d) - c(t) \leq d + 2\Delta$. \square

C Other Clock properties

Property 3 (Clock properties). *Let $\rho' \geq \rho \geq 1$, $\eta' \geq \eta \geq 0$ and $\Delta' \geq \Delta \geq 0$.*

If a clock c respects drift parameters (ρ, η) , and synchronization error Δ , it also respects drift parameters (ρ', η') , and synchronization error Δ' .

If a clock c respects drift parameters (ρ, η) , and synchronization error Δ , and if $2\Delta < \eta$, then it also respects drift parameters (ρ, Δ) .

The first property ensures that if a clock has a certain quality, it also ensures a “weaker” quality.

The second property allows to assume without loss of generality that $\eta \leq 2\Delta$, in order to simplify the proofs.

Proof. Let $\rho' \geq \rho \geq 1$, $\eta' \geq \eta \geq 0$ and $\Delta' \geq \Delta \geq 0$.

Assume that the clock c respects drift parameters (ρ, η) and synchronization error Δ . From the clock synchronization property (Equation 2) we have, $\forall t \geq 0$,

$$|c(t) - t| \leq \Delta \leq \Delta'. \quad (62)$$

Then, $\forall t, d \geq 0$,

$$\frac{d - \eta'}{\rho'} \leq \frac{d - \eta}{\rho} \leq c(t + d) - c(t) \leq d \cdot \rho + \eta \quad (63)$$

$$\leq d \cdot \rho' + \eta' \quad (64)$$

Consequently, it also respects drift parameters (ρ', η') , and synchronization error Δ' .

Now assume that the clock c respects drift parameters (ρ, η) , synchronization error Δ and $\eta > 2\Delta$. Thus

$$c(t + d) - c(t) \leq t + d + \Delta - (t - \Delta) \quad (65)$$

$$= d + 2\Delta \quad (66)$$

$$\leq \rho d + 2\Delta \quad (67)$$

and also

$$c(t + d) - c(t) \geq \frac{d - 2\Delta}{\rho} \quad (68)$$

Set $\eta' = 2\Delta$, then c respects drift parameters (ρ, η') , synchronization error Δ and $\eta' \leq 2\Delta$. \square

We will use the following notation in the proofs.

Definition 2. Let u, v, w, M be four reals. We define

$$\underline{\gamma}_{u,v,w}(M) = \max(M - 2.w; \frac{M - v}{u}) \quad (69)$$

$$\bar{\gamma}_{u,v,w}(M) = \min(M + 2.w; M.u + v) \quad (70)$$

Remark 1. Let c a clock with drift parameters (ρ, η, Δ) and $(t, d) \in \mathbb{R}^+$. Then,

$$\underline{\gamma}_{\rho,\eta,\Delta}(d) \leq c(t + d) - c(t) \leq \bar{\gamma}_{\rho,\eta,\Delta}(d) \quad (71)$$

Property 4. Let c a clock with drift parameters (ρ, η, Δ) and $M \in \mathbb{R}^+$.

If $M \leq c(t + d) - c(t)$ then $\underline{\gamma}_{\rho,\eta,\Delta}(M) \leq d$.

And if $c(t + d) - c(t) \leq M$ then $d \leq \bar{\gamma}_{\rho,\eta,\Delta}(M)$.

Proof. Let c a clock with drift parameters (ρ, η, Δ) and $M \in \mathbb{R}^+$. c respects the properties of the clock as defined in Equation 3 and Equation 2. Consequently,

$$\frac{d - \eta}{\rho} \leq c(t + d) - c(t) \leq d.\rho + \eta \quad (72)$$

$$\& \quad (73)$$

$$d - 2.\Delta \leq c(t + d) - c(t) \leq d + 2.\Delta \quad (74)$$

If $M \leq c(t + d) - c(t)$, then

$$M \leq c(t + d) - c(t) \leq d.\rho + \eta \quad (75)$$

$$\implies \frac{M - \eta}{\rho} \leq d \& \quad (76)$$

$$M \leq c(t + d) - c(t) \leq d + 2.\Delta \quad (77)$$

$$\implies M - 2.\Delta \leq d \quad (78)$$

Consequently,

$$\max(\frac{M - \eta}{\rho}; M - 2.\Delta) = \underline{\gamma}_{\rho,\eta,\Delta}(M) \leq d \quad (79)$$

Similarily, if $c(t + d) - c(t) \leq M$, then

$$\frac{d - \eta}{\rho} \leq c(t + d) - c(t) \leq M \quad (80)$$

$$\implies d \leq M.\rho + \eta \& \quad (81)$$

$$d - 2.\Delta \leq c(t + d) - c(t) \leq M \quad (82)$$

$$\implies d \leq M + 2.\Delta \quad (83)$$

Consequently,

$$d \leq \min(M.\rho + \eta; M + 2.\Delta) = \bar{\gamma}_{\rho,\eta,\Delta}(M) \quad (84)$$

□

D Proof of Theorem 1 (Sufficient condition)

Proof. To ease expression manipulation, let $\dot{E} = \underline{E} + S_b$ and $\dot{T} = T - S_e$. Also, in this proof, we drop the dependency on i, j in U and L .

Consider two frames F and F' sent by a node N_i to N_j , F is sent before F' .

Assume that (11) holds. We will show that the nodes N_i and N_j satisfy Definition 1. Let $t_{cl}^F, t_{wr}^F, t_{cl}^{F'}, t_{wr}^{F'}$ be the significant times of F and respectively F' as defined in Section 3, we have to show

$$\left\lfloor \frac{c_j(t_{cl}^F) - o_j}{T} \right\rfloor \% 2 = \left\lfloor \frac{c_j(t_{cl}^{F'}) - o_j}{T} \right\rfloor \% 2 \quad (85)$$

AND

$$\left\lfloor \frac{c_j(t_{wr}^F) - o_j}{T} \right\rfloor = \left\lfloor \frac{c_j(t_{wr}^{F'}) - o_j}{T} \right\rfloor \quad (86)$$

At this point, we have

$$\left\lfloor \frac{c_j(t_{cl}^F) - o_j}{T} \right\rfloor \leq \left\lfloor \frac{c_j(t_{cl}^{F'}) - o_j}{T} \right\rfloor \leq \left\lfloor \frac{c_j(t_{wr}^{F'}) - o_j}{T} \right\rfloor \quad (87)$$

$$\left\lfloor \frac{c_j(t_{cl}^F) - o_j}{T} \right\rfloor \leq \left\lfloor \frac{c_j(t_{wr}^F) - o_j}{T} \right\rfloor \leq \left\lfloor \frac{c_j(t_{wr}^{F'}) - o_j}{T} \right\rfloor \quad (88)$$

because F is sent before F' and the forwarding time is obviously earlier than the writing time. Let us first prove that $\left\lfloor \frac{c_j(t_{cl}^F) - o_j}{T} \right\rfloor = \left\lfloor \frac{c_j(t_{wr}^{F'}) - o_j}{T} \right\rfloor$.

1. Consider F : let t_{em}^F denote the instant when the node N_i sends the last bit of F . Let k be the cycle in which this frame is sent. The frame is sent after the opening guard band, so

$$c_i(t_{em}^F) - c_i(t_k) \geq E^F + S_b = \dot{E} \quad (89)$$

According to Property 4,

$$\gamma_{\rho_i, \eta_i, \Delta_i}(\dot{E}) \leq t_{em}^F - t_k \quad (90)$$

So,

$$t_{em}^F \geq t_k + \gamma_{\rho_i, \eta_i, \Delta_i}(\dot{E}) \quad (91)$$

and t_{cl}^F denotes the instant when the frame is forwarded in the queue in N_j . So,

$$t_{em}^F + \underline{P}_{i,j} \leq t_{cl}^F \leq t_{em}^F + \bar{P}_{i,j}. \quad (92)$$

2. Consider F' : let $t_{em}^{F'}$ denote the instant when the node N_i sends the last bit of F' . The frame is sent before the closing guard band, so

$$c_i(t_{em}^{F'}) - c_i(t_k) \leq T - S_e = \dot{T} \quad (93)$$

According to Proposition 4,

$$t_{em}^{F'} - t_k \leq \bar{\gamma}_{\rho_i, \eta_i, \Delta_i}(\dot{T}) \quad (94)$$

So,

$$t_{em}^{F'} \leq t_k + \bar{\gamma}_{\rho_i, \eta_i, \Delta_i}(\dot{T}) \quad (95)$$

and $t_{cl}^{F'}$ denotes the instant when the frame is forwarded in the queue in N_j . So,

$$t_{em}^{F'} + \underline{P}_{i,j} \leq t_{cl}^{F'} \leq t_{em}^{F'} + \bar{P}_{i,j} \quad (96)$$

Finally, $t_{wr}^{F'}$ denotes the instant when the frame is written in the queue in N_j ,

$$t_{cl}^{F'} + \bar{z}_j \leq t_{wr}^{F'} \leq t_{cl}^{F'} + \underline{z}_j \quad (97)$$

We can now combine (91), (92), (95) and (97) and obtain

$$t_{cl}^F \geq t_k + \underline{P}_{i,j} + \underline{\gamma}_{\rho_i, \eta_i, \Delta_i}(\dot{E}) \quad (98)$$

$$t_{wr}^{F'} \leq t_k + \bar{P}_{i,j} + \bar{z}_j + \bar{\gamma}_{\rho_i, \eta_i, \Delta_i}(\dot{T}) \quad (99)$$

The clock is increasing so

$$c_j(t_{cl}^F) \geq c_j\left(t_k + \underline{P}_{i,j} + \underline{\gamma}_{\rho_i, \eta_i, \Delta_i}(\dot{E})\right) \quad (100)$$

$$c_j(t_{wr}^{F'}) \leq c_j\left(t_k + \bar{P}_{i,j} + \bar{z}_j + \bar{\gamma}_{\rho_i, \eta_i, \Delta_i}(\dot{T})\right) \quad (101)$$

Due to clock drift, (4), we have :

$$\underline{\gamma}_{\rho_j, \eta_j, \Delta_j}(d) \leq c_j(t+d) - c_j(t) \leq \bar{\gamma}_{\rho_j, \eta_j, \Delta_j}(d) \quad (102)$$

$$c_j(t_k) + \underline{\gamma}_{\rho_j, \eta_j, \Delta_j}(d) \leq c_j(t_k + d) \leq c_j(t_k) + \bar{\gamma}_{\rho_j, \eta_j, \Delta_j}(d) \quad (103)$$

Also, we have a bound on clock error in (3),

$$-\Delta_j + t_k \leq c_j(t_k) \leq \Delta_j + t_k \quad (104)$$

$$-\Delta_i + c_i(t_k) \leq t_k \leq \Delta_i + c_i(t_k) \quad (105)$$

$$-\Delta_j - \Delta_i + c_i(t_k) \leq c_j(t_k) \leq \Delta_j + \Delta_i + c_i(t_k) \quad (106)$$

$$-\Delta_j - \Delta_i + k.T + o_i \leq c_j(t_k) \leq \Delta_j + \Delta_i + k.T + o_i \quad (107)$$

By (103) and (107)), we have

$$\begin{aligned} k.T - \Delta_j - \Delta_i + o_i + \underline{\gamma}_{\rho_j, \eta_j, \Delta_j}(d) &\leq c_j(t_k + d) \\ &\leq k.T + \Delta_j + \Delta_i + o_i + \bar{\gamma}_{\rho_j, \eta_j, \Delta_j}(d) \end{aligned} \quad (108)$$

From (98), $t_{cl}^F \geq t_k + \dots$, so we can apply the previous inequality to $c_j(t_{cl}^F)$

$$c_j(t_{cl}^F) \geq \quad (109)$$

$$k.T - \Delta_j - \Delta_i + o_i + \underline{\gamma}_{\rho_j, \eta_j, \Delta_j}(\underline{P}_{i,j} + \underline{\gamma}_{\rho_i, \eta_i, \Delta_i}(\dot{E})) \quad (110)$$

$$\begin{aligned} &= k.T - \Delta_j - \Delta_i + o_i \\ &\quad + \max \begin{cases} (\dot{E} - \eta_i) \cdot \frac{1}{\rho_i} + \underline{P}_{i,j} - 2.\Delta_j \\ \dot{E} - 2.\Delta_i + \underline{P}_{i,j} - 2.\Delta_j \\ ((\dot{E} - \eta_i) \cdot \frac{1}{\rho_i} + \underline{P}_{i,j} - \eta_j) \cdot \frac{1}{\rho_j} \\ (\dot{E} - 2.\Delta_i + \underline{P}_{i,j} - \eta_j) \cdot \frac{1}{\rho_j} \end{cases} \quad (111) \end{aligned}$$

$$\begin{aligned} &= k.T + \dot{E} + \underline{P}_{i,j} + o_i - \Delta_i - \Delta_j \\ &\quad - \min \begin{cases} \dot{E} \cdot (1 - \frac{1}{\rho_i}) + \frac{\eta_i}{\rho_i} + 2.\Delta_j, \\ 2.\Delta_i + 2.\Delta_j, \\ \dot{E} \cdot (1 - \frac{1}{\rho_i \cdot \rho_j}) + \underline{P}_{i,j} \cdot (1 - \frac{1}{\rho_j}) + \frac{\eta_i}{\rho_i \cdot \rho_j} + \frac{\eta_j}{\rho_j}, \\ (\dot{E} + \underline{P}_{i,j}) \cdot (1 - \frac{1}{\rho_j}) + \frac{\eta_j}{\rho_j} + 2.\Delta_i \cdot \frac{1}{\rho_j} \end{cases} \quad (112) \end{aligned}$$

$$= k.T + L + o_j \quad (113)$$

Similarly, $t_{wr}^{F'} \leq t_k + \dots$ and

$$c_j(t_{wr}^{F'}) \quad (114)$$

$$\leq \Delta_j + \Delta_i + k.T + o_i \quad (115)$$

$$+ \bar{\gamma}_{\rho_j, \eta_j, \Delta_j}(\bar{P}_{i,j} + \bar{z}_j + \bar{\gamma}_{\rho_i, \eta_i, \Delta_i}(\dot{T}))$$

$$\begin{aligned} &= \Delta_j + \Delta_i + k.T + o_i \\ &\quad + \min \begin{cases} \dot{T} \cdot \rho_i + \eta_i + \bar{P}_{i,j} + \bar{z}_j + 2.\Delta_j \\ \dot{T} + 2.\Delta_i + \bar{P}_{i,j} + \bar{z}_j + 2.\Delta_j \\ \dot{T} \cdot \rho_i + \eta_i + \bar{P}_{i,j} + \bar{z}_j \cdot \rho_j + \eta_j \\ (\dot{T} + 2.\Delta_i + \bar{P}_{i,j} + \bar{z}_j) \cdot \rho_j + \eta_j \end{cases} \quad (116) \end{aligned}$$

$$\begin{aligned} &= k.T + \dot{T} + \bar{P}_{i,j} + \bar{z}_j + o_i + \Delta_i + \Delta_j \\ &\quad + \min \begin{cases} \dot{T} \cdot (\rho_i - 1) + \eta_i + 2.\Delta_j \\ 2.\Delta_i + 2.\Delta_j \\ \dot{T} \cdot (\rho_i \cdot \rho_j - 1) + \eta_i \cdot \rho_j + (\bar{P}_{i,j} + \bar{z}_j) \cdot (\rho_j - 1) + \eta_j \\ (\dot{T} + \bar{P}_{i,j} + \bar{z}_j) \cdot (\rho_j - 1) + \eta_j + 2.\Delta_i \cdot \rho_j \end{cases} \quad (117) \end{aligned}$$

$$= U + o_j + k.T \quad (118)$$

From (87), we have

$$c_j(t_{cl}^F) \leq c_j(t_{wr}^{F'}) \quad (119)$$

From (109) to (113), we have

$$L + k.T + o_j \leq c_j(t_{cl}^F) \quad (120)$$

From (114) to (118), we have

$$c_j(t_{wr}^{F'}) \leq U + k.T + o_j \quad (121)$$

Consequently, as the integer part is also increasing, we have

$$k + \left\lfloor \frac{L}{T} \right\rfloor \leq \left\lfloor \frac{c_j(t_{rcl}^F) - o_j}{T} \right\rfloor \quad (122)$$

$$\leq \left\lfloor \frac{c_j(t_{wr}^{F'}) - o_j}{T} \right\rfloor \leq \left\lfloor \frac{U}{T} \right\rfloor + k \quad (123)$$

Since (11) is respected by hypothesis, it follows that $\left\lfloor \frac{c_j(t_{cl}^F) - o_j}{T} \right\rfloor = \left\lfloor \frac{c_j(t_{wr}^{F'}) - o_j}{T} \right\rfloor$.

Combining with (87) and (88), it follows that (85) and (86) hold, i.e., Definition 1 is satisfied. the two conditions in and the two nodes N_i and N_j are enough aligned.

Next, let $\delta^{i,j} = \left\lfloor \frac{L}{T} \right\rfloor = \left\lfloor \frac{U}{T} \right\rfloor$, so that

$$\left\lfloor \frac{c_j(t_{cl}^{F'}) - o_j}{T} \right\rfloor = \left\lfloor \frac{c_j(t_{wr}^{F'}) - o_j}{T} \right\rfloor = \delta_k + k \quad (124)$$

and the difference between the emission and the reception cycle is constant, equals to $\delta^{i,j}$ \square

E Proof of Property 1

We use the following property.

Property 5. *Let $(a, b) \in \mathbb{R}$, such that $a \leq b$. Then,*

$$(\exists k \in \mathbb{Z} \mid b < k \leq a + 1) \iff \lfloor a \rfloor = \lfloor b \rfloor \quad (125)$$

Proof. (1) Assume that $\exists k \in \mathbb{Z} \mid b < k \leq a + 1$. Thus $k - 1 \leq a$; also, since $a \leq b < k$ it comes $a < k$; so,

$$k - 1 \leq a < k \quad (126)$$

by definition of the floor function,

$$\lfloor a \rfloor = k - 1 \quad (127)$$

Also, we have $k - 1 \leq a \leq b$ and $b < k$ So,

$$k - 1 \leq b < k \quad (128)$$

by definition of the floor function,

$$\lfloor b \rfloor = k - 1 \quad (129)$$

Consequently, $\lfloor a \rfloor = \lfloor b \rfloor$.

(2) Conversely, assume that $\lfloor a \rfloor = \lfloor b \rfloor$ and let $\lfloor a \rfloor = \lfloor b \rfloor = m$, $m \in \mathbb{Z}$. From the definition of the floor function, it follows that $m \leq a$ and $b < m + 1$. Thus $b < m + 1 \leq a + 1$, i.e. $\exists k \in \mathbb{Z} \mid b < k \leq a + 1$. \square

Proof of Property 1. Assume that S satisfies the condition in Theorem 1. Then, we have $\lfloor \frac{L}{T} \rfloor = \lfloor \frac{U}{T} \rfloor$. We know that $\frac{L}{T} \leq \frac{U}{T}$, so according to the Proposition 5, we have

$$\exists k \in \mathbb{Z} : U < k.T \leq L + T \quad (130)$$

It follows that, necessarily, $U < L + T$. Therefore

$$\begin{aligned} T - S + \bar{P}_{i,j} + \bar{z}_{i,j} + o_i + o_j + \Delta_i + \Delta_j + \hat{u}(S) \\ < S + \underline{E} + \underline{P}_{i,j} + o_i + o_j - \Delta_i - \Delta_j - \hat{l}(S) + T \end{aligned} \quad (131)$$

and thus

$$\bar{P}_{i,j} - \underline{P}_{i,j} + \bar{z}_{i,j} - \underline{E} + 2.(\Delta_i + \Delta_j) + \hat{u}(S) + \hat{l}(S) < 2.S \quad (132)$$

$$S > \frac{\bar{P}_{i,j} - \underline{P}_{i,j} + \bar{z}_{i,j} - \underline{E} + \hat{l}(S) + \hat{u}(S)}{2} + \Delta_i + \Delta_j \quad (133)$$

$$\geq \frac{\bar{P}_{i,j} - \underline{P}_{i,j} + \bar{z}_{i,j} - \underline{E} + \hat{l}(0) + \hat{u}(\bar{S})}{2} + \Delta_i + \Delta_j \quad (134)$$

$$\geq \frac{\bar{P}_{i,j} - \underline{P}_{i,j} + \bar{z}_{i,j} - \underline{E}}{2} + \Delta_i + \Delta_j \quad (135)$$

because $S \in [0, \bar{S}]$, \hat{l} is decreasing and \hat{u} is decreasing. \square

Note that a slightly better lower bound can be found by using (134) instead of $\underline{S}^{i,j}$. In this paper, we found that this did not bring significant improvements and was not worth the added complexity.

F Proof of Corollary 1

Proof. In this proof, we drop the dependency on i, j in U and L . \hat{l} is increasing and \hat{u} is decreasing, thus

$$-\hat{l}(\bar{S}) \leq -\hat{l}(S) \text{ \& } \hat{u}(S) \leq \hat{u}(\underline{S}) \quad (136)$$

$$L'(S) \leq L(S) \text{ \& } U(S) \leq U'(S) \quad (137)$$

$$L'(S) \leq L(S) \leq U(S) \leq U'(S) \quad (138)$$

Consequently,

$$\left\lfloor \frac{L'}{T} \right\rfloor = \left\lfloor \frac{U'}{T} \right\rfloor \implies \left\lfloor \frac{L}{T} \right\rfloor = \left\lfloor \frac{U}{T} \right\rfloor \quad (139)$$

\square

G Proof of Theorem 2

Proof. Let S be a solution of Theorem 1 for given parameters $(o_i, o_j, P, p, \bar{z}, \rho, \eta, \Delta)$. First, we prove that $\forall s \in [S ; \bar{S}]$, s is also a solution *i.e.*, the set of solution is an interval.

According to Property 5, the solution of Theorem 1 are

$$S \mid \exists k \in \mathbb{Z} \text{ such that } U(S, o_i, o_j) < k.T \leq L(S, o_i, o_j) + T \quad (140)$$

But, U is an decreasing function of S and L a increasing function of S . Consequently, for all $s > S$, $U(s) \leq U(S)$ and $L(S) \leq L(s)$ and

$$\begin{aligned} U(s, o_i, o_j) &\leq U(S, o_i, o_j) < k.T \\ &\leq L(S, o_i, o_j) + T \leq L(s, o_i, o_j) + T \end{aligned} \quad (141)$$

Then, if S is a solution of Theorem 1, then $s \geq S$ is also a solution and s is bounded by \bar{S} .

Then, let $\mathcal{S}_{\text{thm1}}^{o_i, o_j}$ be the set of values of $S \in [0, \bar{S}]$ that satisfy the sufficient condition (11) in Theorem 1.

- If \bar{S} satisfies (11), $\mathcal{S}_{\text{thm1}}^{o_i, o_j}$ is obviously not empty because $\bar{S} \in \mathcal{S}_{\text{thm1}}^{o_i, o_j}$.
- If $\mathcal{S}_{\text{thm1}}^{o_i, o_j}$ is not empty, $\exists S \in \mathcal{S}_{\text{thm1}}^{o_i, o_j}$ and $\forall s \geq S, S \in \mathcal{S}_{\text{thm1}}^{o_i, o_j}$. $\bar{S} \geq S$, then $\bar{S} \in \mathcal{S}_{\text{thm1}}^{o_i, o_j}$.
- If $\mathcal{S}_{\text{thm1}}^{o_i, o_j}$ is not empty, it is an interval. Then, it exists $\underline{S}_{\text{thm1}}^{o_i, o_j}$, the infimum value such that

$$\mathcal{S}_{\text{thm1}}^{o_i, o_j} = \lfloor \underline{S}_{\text{thm1}}^{o_i, o_j} ; \bar{S} \rfloor \quad (142)$$

where \lfloor means $[$ or $($.

- By binary search, we can find $S_{\text{thm1}}^{*o_i, o_j}$ the smallest value of $S \in \mathcal{S}_{\text{thm1}}^{o_i, o_j}$ with precision ε . Then,

$$S_{\text{thm1}}^{*o_i, o_j} = \underline{S}_{\text{thm1}}^{o_i, o_j} + \varepsilon. \quad (143)$$

$S_{\text{thm1}}^{*o_i, o_j}$ is an ε -approximation of $\underline{S}_{\text{thm1}}^{o_i, o_j}$. Moreover,

$$\lfloor \underline{S}_{\text{thm1}}^{o_i, o_j} ; \bar{S} \rfloor = \lfloor \underline{S}_{\text{thm1}}^{o_i, o_j} ; S_{\text{thm1}}^{*o_i, o_j} \cup [S_{\text{thm1}}^{*o_i, o_j} ; \bar{S}] \rfloor \quad (144)$$

$$= \lfloor \underline{S}_{\text{thm1}}^{o_i, o_j} ; \underline{S}_{\text{thm1}}^{o_i, o_j} + \varepsilon \cup [S_{\text{thm1}}^{*o_i, o_j} ; \bar{S}] \rfloor \quad (145)$$

$\lfloor \underline{S}_{\text{thm1}}^{o_i, o_j} ; \underline{S}_{\text{thm1}}^{o_i, o_j} + \varepsilon \rfloor$ is of length ε hence $\lfloor S_{\text{thm1}}^{*o_i, o_j} ; \bar{S} \rfloor$ is an ε -approximation of $\mathcal{S}_{\text{thm1}}^{o_i, o_j}$.

□

H Proof of Property 2

Proof. Let $(\rho_i, \eta_i, \Delta_i)$ be the clock quality parameters of a clock c and $(\rho'_i, \eta'_i, \Delta'_i)$ the clock quality parameters of a clock c' better than c , where better means $\rho'_i \leq \rho_i, \eta'_i \leq \eta_i, \Delta'_i \leq \Delta_i, \rho'_j \leq \rho_j, \eta'_j \leq \eta_j, \Delta'_j \leq \Delta_j$. If c' respects the better clock quality parameters then $\forall (t, d) \in \mathbb{R}^+$,

$$\frac{d - \eta_i}{\rho_i} \leq \frac{d - \eta'_i}{\rho'_i} \leq c(t + d) - c(t) \leq d \cdot \rho'_i + \eta'_i \leq d \cdot \rho_i + \eta_i \quad (146)$$

And $\forall t \in \mathbb{R}^+$

$$|c'(t) - t| \leq \Delta'_i \leq \Delta_i \quad (147)$$

Consequently, c' respects also the clock quality parameters of c . \square

I Proof of Theorem 3 (Necessary condition)

As introduced in the sketch of proof, the principle of the proof is to build an adversarial behaviour, with a first frame F sent by N_i just after the opening guard band, a second frame F' whose last bit is sent just before the closing guard band, and two clocks designed to maximize the distance between the values between of reception of these two frames, while of course respecting the constraints.

The main complexity is to build the clock trajectories. To this end, we first build elementary clock patterns, next we combine them into two feasible adversary clock trajectories.

I.1 Elementary Clock Patterns

We need the following technical result:

Property 6. *Let a, a' be two positive real numbers and b, b' be real numbers. For any $x, y \in \mathbb{R}$,*

$$y = \min(ax + b, a'x + b') \iff x = \max\left(\frac{y - b}{a}, \frac{y - b'}{a'}\right) \quad (148)$$

Proof. Let $F : \mathbb{R} \rightarrow \mathbb{R}, x \mapsto ax + b$ and $G : \mathbb{R} \rightarrow \mathbb{R}, x \mapsto a'x + b'$. F, G and $\min(F, G)$ are increasing, their upper-pseudo inverses are their regular inverses and, by [1, Theorem 10.3 (a)], the inverse of $\min(F, G)$ is $\max(F^{-1}, G^{-1})$. \square

We now introduce two elementary clock patterns, the former is fast then slow, the latter is slow then fast.

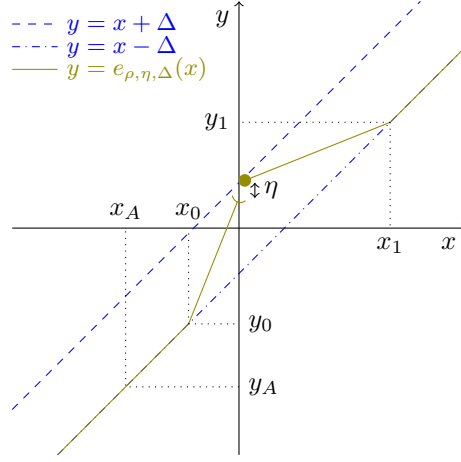

Figure 21: Clock pattern $e_{\rho, \eta, \Delta}$ (fast then slow).

Property 7 (Feasible Clock Patterns). *Let $\rho \geq 1$, $\eta \geq 0$ and $\Delta \geq 0$, such that $\eta \leq 2\Delta$: Define the functions $e_{\rho, \eta, \Delta}, e'_{\rho, \eta, \Delta} : \mathbb{R} \rightarrow \mathbb{R}$ by*

$$e_{\rho, \eta, \Delta}(x) = \begin{cases} \max\{x - \Delta, \rho x + \Delta - \eta\} & \text{if } x < 0 \\ \max\{x - \Delta, \frac{x}{\rho} + \Delta\} & \text{if } x \geq 0 \end{cases} \quad (149)$$

$$e'_{\rho, \eta, \Delta}(x) = \begin{cases} \min\{x + \Delta, \frac{x}{\rho} - \Delta\} & \text{if } x < 0 \\ \min\{x + \Delta, \rho x - \Delta + \eta\} & \text{if } x \geq 0 \end{cases} \quad (150)$$

Then, the functions $e_{\rho, \eta, \Delta}, e'_{\rho, \eta, \Delta}$ respect the clock properties presented in (2) and (3).

Moreover, for any $y < \Delta - \eta$ or $y \geq \Delta$, there exists a unique x such that $e_{\rho, \eta, \Delta}(x) = y$. In the following, it will be denoted by $e_{\rho, \eta, \Delta}^{-1}(y)$. Also, for any $y \leq -\Delta$ or $y > \eta - \Delta$, there exists a unique x such that $e'_{\rho, \eta, \Delta}(x) = y$. In the following, it will be denoted by $e'_{\rho, \eta, \Delta}{}^{-1}(y)$. We have:

$$e_{\rho, \eta, \Delta}^{-1}(y) = \begin{cases} \min\left\{y + \Delta, \frac{y - \Delta + \eta}{\rho}\right\} & \text{if } y < \Delta - \eta \\ \min\{y + \Delta, \rho(y - \Delta)\} & \text{if } y \geq \Delta - \eta \end{cases} \quad (151)$$

$$e'_{\rho, \eta, \Delta}{}^{-1}(y) = \begin{cases} \min\{y - \Delta, \rho(y + \Delta)\} & \text{if } y < -\Delta \\ \min\left\{y - \Delta, \frac{y + \Delta - \eta}{\rho}\right\} & \text{if } y \geq -\Delta + \eta \end{cases} \quad (152)$$

An illustration is provided in Figures 21 and 22.

Proof that patterns respects clock conditions. We need to show that the two clock patterns satisfy (2) and (3).

(i) Let us start with (3), i.e., we have to show that $\forall t \in \mathbb{R}, |e_{\rho, \eta, \Delta}(t) - t| \leq \Delta$.

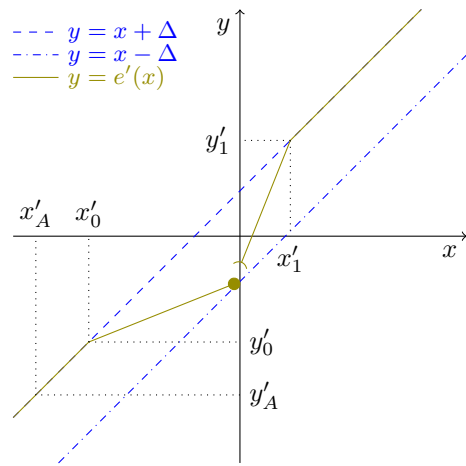

Figure 22: Clock pattern $e'_{\rho,\eta,\Delta}$ (slow then fast).

	$t \leq x_0$	$x_0 \leq t \leq 0$	$0 \leq t \leq x_1$	$x_1 \leq t$
$t + d \leq x_0$	1	X	X	X
$x_0 \leq t + d \leq 0$	2	5	X	X
$0 \leq t + d \leq x_1$	3	6	8	X
$x_1 \leq t + d$	4	7	9	10

Table 5: Cases for item (ii).

1. If $t \in \mathbb{R}^+$:

$$e_{\rho,\eta,\Delta}(t) - t = \max \left\{ t - \Delta, \frac{t}{\rho} + \Delta \right\} - t \quad (153)$$

$$= \max \left\{ -\Delta, \left(\frac{1}{\rho} - 1 \right) \cdot t + \Delta \right\} \quad (154)$$

It follows that $e_{\rho,\eta,\Delta}(t) - t \geq -\Delta$. But $\frac{1}{\rho} \leq 1$ and $t \geq 0$ so $(\frac{1}{\rho} - 1) \cdot t + \Delta \leq \Delta$ and thus $e_{\rho,\eta,\Delta}(t) - t \leq \Delta$.

2. If $t \in \mathbb{R}^-$:

$$e_{\rho,\eta,\Delta}(t) - t = \max \{ t - \Delta, t \cdot \rho + \Delta - \eta \} - t \quad (155)$$

$$= \max \{ -\Delta, t \cdot (\rho - 1) + \Delta - \eta \} \quad (156)$$

It follows that $e_{\rho,\eta,\Delta}(t) - t \geq -\Delta$. But, $\rho \geq 1$, $\eta \geq 0$ and $t \leq 0$ so $t \cdot (\rho - 1) + \Delta - \eta \leq \Delta$ and $e_{\rho,\eta,\Delta}(t) - t \leq \Delta$.

Thus $\forall t \in \mathbb{R}, |e_{\rho,\eta,\Delta}(t) - t| \leq \Delta$.

(ii) Let us now show that (3) holds for $e_{\rho,\eta,\Delta}$, i.e we have to show that, for all $t, d \geq 0$:

$$(d - \eta) \cdot \frac{1}{\rho} \leq e_{\rho,\eta,\Delta}(t + d) - e_{\rho,\eta,\Delta}(t) \leq d \cdot \rho + \eta$$

Let $x_0 = \frac{2 \cdot \Delta - \eta}{1 - \rho} < 0$ and $x_1 = 2 \cdot \Delta \cdot \frac{\rho}{\rho - 1} > 0$ (see Figure 21). We consider all possible cases, depending on the positions of t and $t + d$ with respect to x_0 , 0 and x_1 . Since $d \geq 0$, we obtain 10 cases, numbered as in Table 5.

1. if $t \in [-\infty; x_0]$ and $t + d \in [-\infty; x_0]$:

$$e_{\rho,\eta,\Delta}(t + d) - e_{\rho,\eta,\Delta}(t) \quad (157)$$

$$= t + d - \Delta - (t - \Delta) = d \quad (158)$$

Thus, $(d - \eta) \cdot \frac{1}{\rho} \leq e_{\rho,\eta,\Delta}(t + d) - e_{\rho,\eta,\Delta}(t) \leq d \cdot \rho + \eta$

2. if $t \in [-\infty; x_0]$ and $t + d \in [x_0; 0]$:

$$e_{\rho,\eta,\Delta}(t+d) - e_{\rho,\eta,\Delta}(t) \quad (159)$$

$$= e_{\rho,\eta,\Delta}(t+d) - e_{\rho,\eta,\Delta}(x_0) + e_{\rho,\eta,\Delta}(x_0) - e_{\rho,\eta,\Delta}(t) \quad (160)$$

$$= (t+d-x_0).\rho - (t-x_0) \quad (161)$$

$$= (\rho-1).t + d.\rho + 2.\Delta - \eta \quad (162)$$

But $(t+d-x_0).\rho - (t-x_0) \geq \frac{(t+d-x_0)}{\rho} - \frac{(t-x_0)}{\rho} = \frac{d}{\rho} \geq \frac{d-\eta}{\rho}$ because $t-x_0 \leq 0$ and $\rho \geq 1, \eta \geq 0$.

Also, $(\rho-1).t + d.\rho + 2.\Delta - \eta \leq (\rho-1).x_0 + d.\rho + 2.\Delta - \eta = d.\rho \leq d.\rho + \eta$.

Thus $\frac{d-\eta}{\rho} \leq e_{\rho,\eta,\Delta}(t+d) - e_{\rho,\eta,\Delta}(t) \leq d.\rho + \eta$

3. if $t \in [-\infty; x_0]$ and $t + d \in [0, x_1]$:

$$e_{\rho,\eta,\Delta}(t+d) - e_{\rho,\eta,\Delta}(t) \quad (163)$$

$$= e_{\rho,\eta,\Delta}(t+d) - e_{\rho,\eta,\Delta}(x_0) + e_{\rho,\eta,\Delta}(x_0) - e_{\rho,\eta,\Delta}(t) \quad (164)$$

$$= (t+d-x_0).\frac{1}{\rho} - (t-x_0) \quad (165)$$

As previously, $(t+d-x_0).\rho - (t-x_0) \geq \frac{d-\eta}{\rho}$ because $t-x_0 \leq 0$ and $\rho \geq 1, \eta \geq 0$.

Then, $(t+d-x_0).\rho - (t-x_0) \leq (t+d-x_0).\rho - (t-x_0).\rho = d.\rho \leq d.\rho + \eta$ because $t-x_0 \leq 0$ and $\rho \geq 1, \eta \geq 0$.

Thus $\frac{d-\eta}{\rho} \leq e_{\rho,\eta,\Delta}(t+d) - e_{\rho,\eta,\Delta}(t) \leq d.\rho + \eta$

4. if $t \in [-\infty; x_0]$ and $t + d \in [x_1, +\infty]$:

$$e_{\rho,\eta,\Delta}(t+d) - e_{\rho,\eta,\Delta}(t) \quad (166)$$

$$= t+d-\Delta - (t-\Delta) \quad (167)$$

$$= d \quad (168)$$

Thus $(d-\eta).\frac{1}{\rho} \leq e_{\rho,\eta,\Delta}(t+d) - e_{\rho,\eta,\Delta}(t) \leq d.\rho + \eta$

5. if $t \in [x_0; 0]$ and $t + d \in [x_0; 0]$:

$$e_{\rho,\eta,\Delta}(t+d) - e_{\rho,\eta,\Delta}(t) \quad (169)$$

$$= (t+d).\rho + \Delta - \eta - (t.\rho + \Delta - \eta) \quad (170)$$

$$= d \quad (171)$$

Thus, $(d-\eta).\frac{1}{\rho} \leq e_{\rho,\eta,\Delta}(t+d) - e_{\rho,\eta,\Delta}(t) \leq d.\rho + \eta$

6. if $t \in [x_0; 0]$ and $t + d \in [0, x_1]$:

$$e_{\rho, \eta, \Delta}(t + d) - e_{\rho, \eta, \Delta}(t) \quad (172)$$

$$= e_{\rho, \eta, \Delta}(t + d) - e_{\rho, \eta, \Delta}(0) + e_{\rho, \eta, \Delta}(0) - e_{\rho, \eta, \Delta}(t) \quad (173)$$

$$= (t + d) \cdot \frac{1}{\rho} + \Delta - \Delta + \Delta - (t \cdot \rho + \Delta - \eta) \quad (174)$$

$$= (t + d) \cdot \frac{1}{\rho} - (t \cdot \rho - \eta) \quad (175)$$

$$= \left(\frac{1}{\rho} - \rho\right) \cdot t + d \cdot \frac{1}{\rho} + \eta \quad (176)$$

But $\left(\frac{1}{\rho} - \rho\right) \cdot t + d \cdot \frac{1}{\rho} + \eta \geq d \cdot \frac{1}{\rho} + \eta \geq \frac{d - \eta}{\rho}$ because $\frac{1}{\rho} - \rho \leq 0$ and $t \geq x_0$.

Also, $(t + d) \cdot \frac{1}{\rho} - (t \cdot \rho - \eta) \leq (t + d) \cdot \rho - (t \cdot \rho - \eta) = d \cdot \rho + \eta$.

Thus $(d - \eta) \cdot \frac{1}{\rho} \leq e_{\rho, \eta, \Delta}(t + d) - e_{\rho, \eta, \Delta}(t) \leq d \cdot \rho + \eta$

7. if $t \in [x_0; 0]$ and $t + d \in [x_1, +\infty]$:

$$e_{\rho, \eta, \Delta}(t + d) - e_{\rho, \eta, \Delta}(t) \quad (177)$$

$$e_{\rho, \eta, \Delta}(t + d) - e_{\rho, \eta, \Delta}(x_1) + e_{\rho, \eta, \Delta}(x_1) - e_{\rho, \eta, \Delta}(t) \quad (178)$$

$$= t + d - \Delta - (x_1 - \Delta) + \left(x_1 \cdot \frac{1}{\rho} + \Delta\right) - (t \cdot \rho + \Delta - \eta) \quad (179)$$

$$= t + d - x_1 - \left(t \cdot \rho - x_1 \cdot \frac{1}{\rho} - \eta\right) \quad (180)$$

$$= (1 - \rho) \cdot t + d - 2 \cdot \Delta + \eta \quad (181)$$

But, $(1 - \rho) \cdot t + d - 2 \cdot \Delta + \eta \leq (1 - \rho) \cdot x_0 + d - 2 \cdot \Delta + \eta = d \leq d \cdot \rho + \eta$ because $t \geq x_1$ and $1 - \rho \leq 0$.

Also, $t + d - x_1 - \left(t \cdot \rho - x_1 \cdot \frac{1}{\rho} - \eta\right) \geq (t + d - x_1) \cdot \frac{1}{\rho} - \left(t \cdot \frac{1}{\rho} - x_1 \cdot \frac{1}{\rho} - \eta \cdot \frac{1}{\rho}\right) = (d + \eta) \cdot \frac{1}{\rho} \geq (d - \eta) \cdot \frac{1}{\rho}$.

Thus $(d - \eta) \cdot \frac{1}{\rho} \leq e_{\rho, \eta, \Delta}(t + d) - e_{\rho, \eta, \Delta}(t) \leq d \cdot \rho + \eta$

8. if $t \in [0, x_1]$ and $t + d \in [0, x_1]$:

$$e_{\rho, \eta, \Delta}(t + d) - e_{\rho, \eta, \Delta}(t) \quad (182)$$

$$= (t + d) \cdot \frac{1}{\rho} + \Delta - \left(t \cdot \frac{1}{\rho} + \Delta\right) \quad (183)$$

$$= d \quad (184)$$

Thus $(d - \eta) \cdot \frac{1}{\rho} \leq e_{\rho, \eta, \Delta}(t + d) - e_{\rho, \eta, \Delta}(t) \leq d \cdot \rho + \eta$

9. if $t \in [0, x_1]$ and $t + d \in [x_1, +\infty]$:

$$e_{\rho, \eta, \Delta}(t + d) - e_{\rho, \eta, \Delta}(t) \quad (185)$$

$$= e_{\rho, \eta, \Delta}(t + d) - e_{\rho, \eta, \Delta}(x_1) + e_{\rho, \eta, \Delta}(x_1) - e_{\rho, \eta, \Delta}(t) \quad (186)$$

$$= t + d - x_1 - (t - x_1) \cdot \frac{1}{\rho} \quad (187)$$

$$= \left(1 - \frac{1}{\rho}\right) \cdot t + d - 2 \cdot \Delta \quad (188)$$

But, $t + d - x_1 - (t - x_1) \cdot \frac{1}{\rho} \geq \frac{t + d - x_1}{\rho} - \frac{t - x_1}{\rho} = \frac{d}{\rho} \geq \frac{d - \eta}{\rho}$ because $t + d - x_1 \geq 0$.

Also, $\left(1 - \frac{1}{\rho}\right) \cdot t + d - 2 \cdot \Delta \leq \left(1 - \frac{1}{\rho}\right) \cdot x_1 + d - 2 \cdot \Delta = d \leq d \cdot \rho + \eta$ because $t \leq x_1 = 2 \cdot \Delta \cdot \frac{\rho}{\rho - 1}$.

Thus $(d - \eta) \cdot \frac{1}{\rho} \leq e_{\rho, \eta, \Delta}(t + d) - e_{\rho, \eta, \Delta}(t) \leq d \cdot \rho + \eta$

10. if $t \in [x_1, +\infty]$ and $t + d \in [x_1, +\infty]$:

$$e_{\rho, \eta, \Delta}(t + d) - e_{\rho, \eta, \Delta}(t) \quad (189)$$

$$= t + d - \Delta - (t - \Delta) \quad (190)$$

$$= d \quad (191)$$

Thus $(d - \eta) \cdot \frac{1}{\rho} \leq e_{\rho, \eta, \Delta}(t + d) - e_{\rho, \eta, \Delta}(t) \leq d \cdot \rho + \eta$

This shows that the clock pattern $e_{\rho, \eta, \Delta}$ satisfies (3).

(iii) The proof is similar for the opposite clock $e'_{\rho, \eta, \Delta}$.

(iv) (151) and (152) follow from Prop. 6. □

I.2 Feasible Clock Trajectories

We now show how to use the elementary clock pattern to construct clock patterns with specific constraints. The first ingredient is time shifting.

Property 8 (Shifted Clock). *Let c be a clock respecting clock parameters (ρ, η, Δ) . The function c' defined by $c'(t) = c(t - t') + t'$ is also a clock and respects clock parameters (ρ, η, Δ) .*

Proof. Since c' is obviously wide-sense increasing, all we need to prove is that c' respects (2) and (3).

$\forall t, d \geq 0$,

$$c'(t + d) - c'(t) = c(t - t' + d) + t' - c(t - t') - t' \quad (192)$$

$$= c(t - t' + d) - c(t - t') = c(x + d) - c(x) \quad (193)$$

with $x = t - t'$. As c respects (2), we have : $\frac{d - \eta}{\rho} \leq c(x + d) - c(x) = c'(t + d) - c'(t) \leq d \cdot \rho + \eta$ i.e. c' respects (2).

Next, for $t \geq 0$,

$$c'(t) - t = c(t - t') - (t - t') \leq \Delta \quad (194)$$

by application of (3) to c and $t - t'$. □

We will apply time shifting to the elementary clock patterns in Prop. 7. More specifically, the application to $e_{\rho,\eta,\Delta}$ leads to the following.

Property 9 (Feasible Clock Trajectory). *Let $\rho \geq 1$ and $2\Delta \geq \eta \geq 0$. For any $A > \eta$, $B, t_0 \geq 0$, there exists a clock c that respects parameters ρ, η, Δ in (2) and (3) and two time instants t_1, t_2 such that*

$$c(t_1) - c(t_0) = A \quad (195)$$

$$c(t_2) - c(t_1) = B \quad (196)$$

Furthermore, we can take

$$c(t_0) = t_0 + \Delta - A - \min \left\{ 2\Delta - A, (\eta - A) \cdot \frac{1}{\rho} \right\} \quad (197)$$

$$t_1 = t_0 - \min \left\{ 2\Delta - A, (\eta - A) \cdot \frac{1}{\rho} \right\} \quad (198)$$

$$t_2 = t_1 + \min \{ 2\Delta + B, B \cdot \rho \} \quad (199)$$

Proof. We use the clock pattern $e_{\rho,\eta,\Delta}$ in Prop. 7 and shift it using using Property 8. Let

$$y_A = \Delta - A, \quad x_A = e_{\rho,\eta,\Delta}^{-1}(y_A) \quad (200)$$

$$y_B = \Delta + B \quad x_B = e_{\rho,\eta,\Delta}^{-1}(y_B) \quad (201)$$

$$t_1 = t_0 - x_A, \quad t_2 = t_1 + x_B \quad (202)$$

(since $A > \eta$, x_A exists) and consider the clock defined by

$$c : t \mapsto e_{\rho,\eta,\Delta}(t - t_1) + t_1 \quad (203)$$

$$\text{Then, } c(t_0) = e_{\rho,\eta,\Delta}(t_0 - t_1) + t_1 \quad (204)$$

$$= e_{\rho,\eta,\Delta}(t_0 - (t_0 - x_A)) + (t_0 - x_A) \quad (205)$$

$$= e_{\rho,\eta,\Delta}(x_A) + t_0 - x_A \quad (206)$$

and since $x_A = e_{\rho,\eta,\Delta}^{-1}(y_A)$

$$c(t_0) = y_A + t_0 - x_A = \Delta - A + t_0 - x_A \quad (207)$$

To expand the value of x_A , use eq. (151). Since $A > \eta$, $y_A < \Delta - \eta$ and

$$x_A = \min \left\{ y_A + \Delta, \frac{y_A - \Delta + \eta}{\rho} \right\} \quad (208)$$

$$= \min \left\{ 2\Delta - A, \frac{-A + \eta}{\rho} \right\} \quad (209)$$

To expand the value of x_B , use also eq. (151), but $B \geq 0 \implies y_B \geq \Delta \geq \Delta - \eta$ and

$$x_B = \min \{ y_B + \Delta, \rho(y_B - \Delta) \} \quad (210)$$

$$= \min \{ 2\Delta + B, \rho \cdot B \} \quad (211)$$

And we can verify

$$\begin{aligned}
c(t_1) - c(t_0) &= e_{\rho,\eta,\Delta}(0) - e_{\rho,\eta,\Delta}(x_A) = \Delta - y_A = A \\
c(t_1) &= e_{\rho,\eta,\Delta}(0) + t_0 - x_A = \Delta + t_1 \\
c(t_2) - c(t_1) &= e_{\rho,\eta,\Delta}(x_B) - e_{\rho,\eta,\Delta}(0) = \Delta + B - \Delta = B
\end{aligned}$$

□

I.3 Proof of Theorem 3

The proof of Theorem 3 consist in building specific clock trajectories. We first build one pair of clocks designed to catch the worst impact of ρ and η , which gives (29) and (30). Second, we build one pair of clocks for each value of s designed to catch the worst impact of Δ and obtain (31) and (32). To ease expression manipulation, let

$$\dot{E} = \underline{E} + S, \quad \dot{T} = T - S. \quad (212)$$

Proof of (29) and (30). 1. *Considering scenarios with two frames sent in the first cycle.* Consider the first cycle of node N_i , t_0 its beginning, and let F and F' being two frames sent by N_i to N_j during this cycle, F being sent before F' . Let $t_{cl}^F, t_{cl}^{F'}$ be the times when F and F' are forwarded to a queue of N_j and $t_{wr}^F, t_{wr}^{F'}$ times when they are written in the queue of N_j . Since definition 1 is satisfied, F and F' are totally received by N_j in one cycle, denoted δ_k and

$$\begin{aligned}
\left\lfloor \frac{c_j(t_{wr}^F) - o_j}{T} \right\rfloor &= \left\lfloor \frac{c_j(t_{wr}^{F'}) - o_j}{T} \right\rfloor \\
\left\lfloor \frac{c_j(t_{cl}^F) - o_j}{T} \right\rfloor \% 2 &= \left\lfloor \frac{c_j(t_{cl}^{F'}) - o_j}{T} \right\rfloor \% 2.
\end{aligned} \quad (213)$$

Let us now spread these values, by building clocks c_i, c_j on N_i, N_j and maximizing / minimizing propagation and switching times.

2. *Building the trajectory of c_i .* As $\dot{E} \geq \eta_i, \eta \leq 2\dot{\Delta}$ and $\dot{T}, t_0 \geq 0$, we can apply Property 9 with $A = \dot{E}, B = \dot{T} - \dot{E}$, and note c_i this clock defined with two instants t_1 and t_2 such that $c_i(t_1) - c_i(t_0) = \dot{E}, c_i(t_2) - c_i(t_1) = \dot{T} - \dot{E}$. These two instants, t_1, t_2 , correspond respectively to the instant when the node N_i sends the last bit of the first frame and the instant

when the node N_i sends the last bit of the last frame. Property 9 leads to

$$t_{em}^F = t_1 \stackrel{(198)}{=} t_0 - \min \left\{ \begin{array}{l} 2.\Delta_i - \dot{E} \\ (\eta_i - \dot{E}).\frac{1}{\rho} \end{array} \right. \quad (214)$$

$$t_{em}^{F'} = t_2 \stackrel{(198)}{=} t_1 + \min \left\{ \begin{array}{l} 2.\Delta_i + (\dot{T} - \dot{E}) \\ \rho_i(\dot{T} - \dot{E}) \end{array} \right. \quad (215)$$

$$c(t_0) \stackrel{(197)}{=} t_0 + \Delta_i - \dot{E} - \min \left\{ \begin{array}{l} 2.\Delta_i - \dot{E} \\ (\eta_i - \dot{E}).\frac{1}{\rho} \end{array} \right. \quad (216)$$

Since t_0 is the start of the first cycle, we have $c_i(t_0) - o_i = 0$, leading to

$$t_0 = o_i - \Delta_i + \dot{E} + \min \left\{ \begin{array}{l} 2.\Delta_i - \dot{E} \\ (\eta_i - \dot{E}).\frac{1}{\rho_i} \end{array} \right. \quad (217)$$

3. *Maximizing and minimizing propagation and switching times.* Assume that the propagation time is minimal for F and maximal for F' , we have :

$$t_{cl}^F = t_{em}^F + \underline{P}_{i,j} \quad (218)$$

$$t_{cl}^{F'} = t_{em}^{F'} + \overline{P}_{i,j} \quad (219)$$

Also assume that the switching time is minimal for F and maximal for F' , we have :

$$t_{wr}^F = t_{cl}^F + \underline{z}_j \quad (220)$$

$$t_{wr}^{F'} = t_{cl}^{F'} + \overline{z}_j \quad (221)$$

4. *Building the trajectory of c_j .* By Property 8, we can build c_j using $e'_{\rho_j, \eta_j, \Delta_j}$, set $t' = t_{cl}^F$ and

$$c_j(t) = e'_{\rho_j, \eta_j, \Delta_j}(t - t_{cl}^F) + t_{cl}^F. \quad (222)$$

5. *Expressing t_{cl}^F as a function of known parameters*

$$t_{cl}^F = \underline{P}_{i,j} + t_0 - \min \left\{ \begin{array}{l} 2.\Delta_i - \dot{E} \\ (\eta_i - \dot{E}).\frac{1}{\rho} \end{array} \right. \quad (223)$$

$$\stackrel{(217)}{=} \dot{E} + \underline{P}_{i,j} + o_i - \Delta_i \quad (224)$$

$$= X + o_j \quad (225)$$

6. Expressing the value of $c_j(t_{cl}^F)$.

$$c_j(t_{cl}^F) \quad (226)$$

$$\stackrel{(222)}{=} e'_{\rho_j, \eta_j, \Delta_j}(t_{cl}^F - t_{cl}^F) + t_{cl}^F \quad (227)$$

$$\stackrel{(225)}{=} e'_{\rho_j, \eta_j, \Delta_j}(t_{wr}^F - t_{cl}^F) + X + o_j \quad (228)$$

$$= e'_{\rho_j, \eta_j, \Delta_j}(0) + X + o_j \quad (229)$$

$$\stackrel{(150)}{=} X - \Delta_j + o_j \quad (230)$$

$$= \tilde{L}\% \quad (231)$$

7. Expressing the value of $c_j(t_{cl}^{F'})$.

$$c_j(t_{cl}^{F'}) \quad (232)$$

$$\stackrel{(222)}{=} e'_{\rho_j, \eta_j, \Delta_j}(t_{cl}^{F'} - t_{cl}^F) + t_{cl}^F \quad (233)$$

$$\stackrel{(225)}{=} e'_{\rho_j, \eta_j, \Delta_j}(t_{wr}^{F'} - t_{cl}^F) + X + o_j \quad (234)$$

$$(235)$$

$$\stackrel{(221)}{=} e'_{\rho_j, \eta_j, \Delta_j}(t_{cl}^{F'} + \bar{z}_j - t_{cl}^F) + X + o_j \quad (236)$$

$$\stackrel{(219)}{=} e'_{\rho_j, \eta_j, \Delta_j}(t_{em}^{F'} + \bar{P}_{i,j} - t_{cl}^F) + X + o_j \quad (237)$$

$$\stackrel{(218)}{=} e'_{\rho_j, \eta_j, \Delta_j}(t_{em}^{F'} + \bar{P}_{i,j} - t_{em}^F - \underline{P}_{i,j}) + X + o_j \quad (238)$$

$$\stackrel{(150)}{=} \min \left\{ (t_{em}^{F'} - t_{em}^F + \bar{P}_{i,j} - \underline{P}_{i,j}) + \Delta_j \right. \\ \left. \rho_j(t_{em}^{F'} - t_{em}^F + \bar{P}_{i,j} - \underline{P}_{i,j}) - \Delta_j + \eta_j \right. \\ \left. + X + o_j \right. \quad (239)$$

$$= X + o_j + \quad (240)$$

$$\min \left\{ \bar{P}_{i,j} - \underline{P}_{i,j} + \Delta_j + (t_{em}^{F'} - t_{em}^F) \right. \\ \left. \eta_j - \Delta_j + \rho_j(\bar{P}_{i,j} - \underline{P}_{i,j} + t_{em}^{F'} - t_{em}^F) \right.$$

From eq. (215),

$$t_{em}^{F'} - t_{em}^F = t_2 - t_1 = \min \left\{ 2\Delta_i + (\dot{T} - \dot{E}) \right. \\ \left. \rho_i(\dot{T} - \dot{E}) \right. \quad (241)$$

$$\stackrel{(212)}{=} \min \left\{ 2\Delta_i + (T - \underline{E} - 2S) \right. \\ \left. \rho_i(T - \underline{E} - 2S) \right. \quad (242)$$

$$(243)$$

Then, eq. (240) becomes

$$c_j(t_{cl}^{F'}) = X + o_j + \quad (244)$$

$$\min \begin{cases} \bar{P}_{i,j} - \underline{P}_{i,j} + \Delta_j + 2.\Delta_i + T - \underline{E} - 2S \\ \bar{P}_{i,j} - \underline{P}_{i,j} + \Delta_j + \rho_i(T - \underline{E} - 2S) \\ \eta_j - \Delta_j + \rho_j(\bar{P}_{i,j} - \underline{P}_{i,j} + 2.\Delta_i + T - \underline{E} - 2S) \\ \eta_j - \Delta_j + \rho_j(\bar{P}_{i,j} - \underline{P}_{i,j} + \rho_i(T - \underline{E} - 2S)) \end{cases} \\ = X + o_j + \tilde{U}_\% \quad (245)$$

8. Expressing the value of $c_j(t_{wr}^F)$.

$$c_j(t_{wr}^F) \quad (246)$$

$$\stackrel{(222)}{=} e'_{\rho_j, \eta_j, \Delta_j}(t_{wr}^F - t_{cl}^F) + t_{cl}^F \quad (247)$$

$$\stackrel{(225)}{=} e'_{\rho_j, \eta_j, \Delta_j}(t_{wr}^F - t_{cl}^F) + X + o_j \quad (248)$$

$$\stackrel{(220)}{=} e'_{\rho_j, \eta_j, \Delta_j}(\underline{z}_j) + X + o_j \quad (249)$$

$$\stackrel{(150)}{=} \min \begin{cases} \underline{z}_j + \Delta_j \\ \rho_j \cdot \underline{z}_j - \Delta_j + \eta_j \end{cases} + X + o_j \quad (250)$$

$$= o_j + \tilde{L} \quad (251)$$

9. Expressing the value of $c_j(t_{wr}^{F'})$.

$$c_j(t_{wr}^{F'}) \quad (252)$$

$$\stackrel{(222)}{=} e'_{\rho_j, \eta_j, \Delta_j}(t_{wr}^{F'} - t_{cl}^F) + t_{cl}^F \quad (253)$$

$$\stackrel{(225)}{=} e'_{\rho_j, \eta_j, \Delta_j}(t_{wr}^{F'} - t_{cl}^F) + X + o_j \quad (254)$$

$$\stackrel{(221)}{=} e'_{\rho_j, \eta_j, \Delta_j}(t_{cl}^{F'} + \bar{z}_j - t_{cl}^F) + X + o_j \quad (255)$$

$$\stackrel{(219)}{=} e'_{\rho_j, \eta_j, \Delta_j}(t_{em}^{F'} + \bar{P}_{i,j} + \bar{z}_j - t_{cl}^F) + X + o_j \quad (256)$$

$$\stackrel{(218)}{=} e'_{\rho_j, \eta_j, \Delta_j}(t_{em}^{F'} + \bar{P}_{i,j} + \bar{z}_j - t_{em}^F - \underline{P}_{i,j}) \\ + X + o_j \quad (257)$$

$$\stackrel{(150)}{=} \min \begin{cases} (t_{em}^{F'} - t_{em}^F + \bar{z}_j + \bar{P}_{i,j} - \underline{P}_{i,j}) + \Delta_j \\ \rho_j(t_{em}^{F'} - t_{em}^F + \bar{z}_j + \bar{P}_{i,j} - \underline{P}_{i,j}) - \Delta_j + \eta_j \end{cases} \\ + X + o_j \quad (258)$$

$$= X + o_j + \quad (259)$$

$$\min \begin{cases} \bar{z}_j + \bar{P}_{i,j} - \underline{P}_{i,j} + \Delta_j + (t_{em}^{F'} - t_{em}^F) \\ \eta_j - \Delta_j + \rho_j(\bar{z}_j + \bar{P}_{i,j} - \underline{P}_{i,j} + t_{em}^{F'} - t_{em}^F) \end{cases}$$

From eq. (215),

$$t_{em}^{F'} - t_{em}^F = t_2 - t_1 = \min \begin{cases} 2.\Delta_i + (\dot{T} - \dot{E}) \\ \rho_i(\dot{T} - \dot{E}) \end{cases} \quad (260)$$

$$\stackrel{(212)}{=} \min \begin{cases} 2.\Delta_i + (T - \underline{E} - 2S) \\ \rho_i(T - \underline{E} - 2S) \end{cases} \quad (261)$$

$$(262)$$

Then, eq. (259) becomes

$$c_j(t_{wr}^{F'}) = X + o_j + \quad (263)$$

$$\min \begin{cases} \bar{z}_j + \bar{P}_{i,j} - \underline{P}_{i,j} + \Delta_j + 2.\Delta_i + T - \underline{E} - 2S \\ \bar{z}_j + \bar{P}_{i,j} - \underline{P}_{i,j} + \Delta_j + \rho_i(T - \underline{E} - 2S) \\ \eta_j - \Delta_j + \rho_j(\bar{z}_j + \bar{P}_{i,j} - \underline{P}_{i,j} + 2.\Delta_i + T - \underline{E} - 2S) \\ \eta_j - \Delta_j + \rho_j(\bar{z}_j + \bar{P}_{i,j} - \underline{P}_{i,j} + \rho_i(T - \underline{E} - 2S)) \end{cases} \\ = X + o_j + \tilde{U} \quad (264)$$

10. *Concluding from time alignment.* Combining with (213) we obtain (29) and (30). □

Proof of (31) and (32). Let $s \in \{-1, 1\}$.

1. *Considering scenarios with two frames sent in the first cycle.* This step is the same as the first step of the previous proof. According to Definition 1, we necessary satisfy

$$\left\lfloor \frac{c_j(t_{wr}^F) - o_j}{T} \right\rfloor = \left\lfloor \frac{c_j(t_{wr}^{F'}) - o_j}{T} \right\rfloor \quad (265)$$

$$\left\lfloor \frac{c_j(t_{cl}^F) - o_j}{T} \right\rfloor \% 2 = \left\lfloor \frac{c_j(t_{cl}^{F'}) - o_j}{T} \right\rfloor \% 2.$$

Let now spread these values, by building clocks c_i, c_j on N_i, N_j and maximizing / minimizing propagation and switching times.

2. *Building the trajectory of c_i* Here, we take another clock for c_i :

$$c_i(t) = t + s.\Delta_i \quad (266)$$

According to this expression and with $c(t_k) = k.T + o_i$, we have

$$c_i(t_{em}^F) - c_i(t_k) = \dot{E} = t_{em}^F + s.\Delta_i - (k.T + o_i) \quad (267)$$

$$c_i(t_{em}^{F'}) - c_i(t_k) = \dot{T} = t_{em}^{F'} + s.\Delta_i - (k.T + o_i) \quad (268)$$

Then,

$$t_{em}^F = \dot{E} - s.\Delta_i + k.T + o_i \quad (269)$$

$$t_{em}^{F'} = \dot{T} - s.\Delta_i + k.T + o_i \quad (270)$$

3. *Maximizing and minimizing propagation and switching times.* Assume that the propagation time is minimal for F and maximal for F' , we have :

$$t_{cl}^F = t_{em}^F + \underline{P} = \dot{E} - s.\Delta_i + k.T + o_i + \underline{P} \quad (271)$$

$$t_{cl}^{F'} = t_{em}^{F'} + \overline{P} = \dot{T} - s.\Delta_i + k.T + o_i + \overline{P} \quad (272)$$

Also, assume that the switching time is minimal for F and maximal for F' , we have :

$$t_{wr}^F = t_{cl}^F + \underline{z}_j = \dot{E} - s.\Delta_i + k.T + o_i + \underline{P} + \underline{z} \quad (273)$$

$$t_{wr}^{F'} = t_{cl}^{F'} + \overline{z}_j = \dot{T} - s.\Delta_i + k.T + o_i + \overline{P} + \overline{z} \quad (274)$$

4. *Building the trajectory of c_j .* Here, we take another clock for c_j :

$$c_j(t) = t - s.\Delta_j \quad (275)$$

5. *Expressing the value of $c_j(t_{cl}^F)$.*

$$c_j(t_{cl}^F) \quad (276)$$

$$\stackrel{(275)}{=} t_{cl}^F - s.\Delta_j \quad (277)$$

$$\stackrel{(271)}{=} \dot{E} - s.(\Delta_i + \Delta_j) + k.T + o_i + \underline{P} \quad (278)$$

$$= \tilde{L}_{\%s} + o_j \quad (279)$$

6. *Expressing the value of $c_j(t_{cl}^{F'})$.*

$$c_j(t_{cl}^{F'}) \quad (280)$$

$$\stackrel{(275)}{=} t_{cl}^{F'} - s.\Delta_j \quad (281)$$

$$\stackrel{(272)}{=} \dot{T} - s.(\Delta_i + \Delta_j) + k.T + o_i + \overline{P} \quad (282)$$

$$= \tilde{U}_{\%s} + o_j \quad (283)$$

7. *Expressing the value of $c_j(t_{wr}^F)$.*

$$c_j(t_{wr}^F) \quad (284)$$

$$\stackrel{(275)}{=} t_{wr}^F - s.\Delta_j \quad (285)$$

$$\stackrel{(273)}{=} \dot{E} - s.(\Delta_i + \Delta_j) + k.T + o_i + \underline{P} + \underline{z} \quad (286)$$

$$= \tilde{L}_s + o_j \quad (287)$$

8. Expressing the value of $c_j(t_{wr}^{F'})$.

$$c_j(t_{wr}^F) \quad (288)$$

$$\stackrel{(275)}{=} t_{wr}^{F'} - s.\Delta_j \quad (289)$$

$$\stackrel{(273)}{=} \dot{T} - s.(\Delta_i + \Delta_j) + k.T + o_i + \bar{P} + \bar{z} \quad (290)$$

$$= \tilde{U}_s + o_j \quad (291)$$

9. Concluding from time alignment. Combining with (213) we obtain (31) and (32)

□

J Null Offset Heuristic, General Case

Proof. Let us start from the equation of the Corollary 1 with null offsets ($o_i = o_j = 0$) and let $k_{i,j} \in \mathbb{N}$ denote the floor part such that:

$$\begin{aligned} & \left\lfloor \frac{S_{i,j} + \underline{E}_{i,j} + \underline{P}_{i,j} - (\Delta_i + \Delta_j) - \widehat{l}_{i,j}(\bar{S}_{i,j})}{T} \right\rfloor \\ &= \left\lfloor \frac{T - S_{i,j} + \bar{P}_{i,j} + \bar{z}_{i,j} + \Delta_i + \Delta_j + \widehat{u}_{i,j}(\underline{S}_{i,j})}{T} \right\rfloor \\ &= k_{i,j} \end{aligned} \quad (292)$$

Then, according to the definition of the floor function, we have

$$\begin{cases} k_{i,j}.T \leq S_{i,j} + \underline{E}_{i,j} + \underline{P}_{i,j} - (\Delta_i + \Delta_j) - \widehat{l}_{i,j}(\bar{S}_{i,j}) \\ < (k_{i,j} + 1).T \\ k_{i,j}.T \leq T - S_{i,j} + \bar{P}_{i,j} + \bar{z}_{i,j} + \Delta_i + \Delta_j + \widehat{u}_{i,j}(\underline{S}_{i,j}) \\ < (k_{i,j} + 1).T \end{cases} \quad (293)$$

Thus

$$\begin{cases} k_{i,j}.T - \underline{E}_{i,j} - \underline{P}_{i,j} + \Delta_i + \Delta_j + \widehat{l}_{i,j}(\bar{S}_{i,j}) \leq S_{i,j} \\ < (k_{i,j} + 1).T - \underline{E}_{i,j} - \underline{P}_{i,j} + \Delta_i + \Delta_j + \widehat{l}_{i,j}(\bar{S}_{i,j}) \\ -k_{i,j}.T + \bar{P}_{i,j} + \bar{z}_{i,j} + \Delta_i + \Delta_j + \widehat{u}_{i,j}(\underline{S}_{i,j}) < S_{i,j} \\ \leq -(k_{i,j} - 1).T + \bar{P}_{i,j} + \bar{z}_{i,j} + \Delta_i + \Delta_j + \widehat{u}_{i,j}(\underline{S}_{i,j}) \end{cases} \quad (294)$$

Let

$$S_{\text{null}} = \max_{i,j} \max \begin{cases} -k_{i,j}.T + \bar{P}_{i,j} + \bar{z}_{i,j} \\ + \Delta_i + \Delta_j + \widehat{u}_{i,j}(\underline{S}_{i,j}) + \epsilon \\ k_{i,j}.T - \underline{E}_{i,j} - \underline{P}_{i,j} \\ + \Delta_i + \Delta_j + \widehat{l}_{i,j}(\bar{S}_{i,j}) \end{cases} \quad (295)$$

Consequently, if it exists $\epsilon > 0$ such that $S_{\text{null}} \leq \bar{S}$ then, S_{null} is an admissible value for the guard band.

We now express $k_{i,j}$ from known parameters. From Equation 293, we necessary have:

$$\begin{cases} k_{i,j}.T - \underline{E}_{i,j} - \underline{P}_{i,j} + \Delta_i + \Delta_j + \widehat{l}_{i,j}(\bar{S}_{i,j}) \\ \leq -(k_{i,j} - 1).T + \bar{P}_{i,j} + \bar{z}_{i,j} + \Delta_i + \Delta_j + \widehat{u}_{i,j}(\underline{S}_{i,j}) \\ -k_{i,j}.T + \bar{P}_{i,j} + \bar{z}_{i,j} + \Delta_i + \Delta_j + \widehat{u}_{i,j}(\underline{S}_{i,j}) \\ < (k_{i,j} + 1).T - \underline{E}_{i,j} - \underline{P}_{i,j} + \Delta_i + \Delta_j + \widehat{l}_{i,j}(\bar{S}_{i,j}) \end{cases} \quad (296)$$

thus

$$\begin{cases} k_{i,j} \leq \frac{\underline{E}_{i,j} + \underline{P}_{i,j} + \bar{P}_{i,j} + \bar{z}_{i,j} + \widehat{u}_{i,j}(\underline{S}_{i,j}) - \widehat{l}_{i,j}(\bar{S}_{i,j}) + T}{2.T} \\ k_{i,j} > \frac{\underline{E}_{i,j} + \underline{P}_{i,j} + \bar{P}_{i,j} + \bar{z}_{i,j} + \widehat{u}_{i,j}(\underline{S}_{i,j}) - \widehat{l}_{i,j}(\bar{S}_{i,j}) - T}{2.T} \end{cases} \quad (297)$$

thus $k_{i,j} =$

$$\left\lfloor \frac{\underline{E}_{i,j} + \underline{P}_{i,j} + \bar{P}_{i,j} + \bar{z}_{i,j} + \widehat{u}_{i,j}(\underline{S}_{i,j}) - \widehat{l}_{i,j}(\bar{S}_{i,j}) + T}{2.T} \right\rfloor \quad (298)$$

because $\lfloor a \rfloor = k \Leftrightarrow k \leq a < k + 1 \Leftrightarrow a - 1 < k \leq a$.

Note that

$$\begin{aligned} k_{i,j} = 0 &\Leftrightarrow \\ -T &\leq \underline{E}_{i,j} + \underline{P}_{i,j} + \bar{P}_{i,j} + \bar{z}_{i,j} + \widehat{u}_{i,j}(\underline{S}_{i,j}) - \widehat{l}_{i,j}(\bar{S}_{i,j}) < T \end{aligned} \quad (299)$$

Consequently,

$$0 \leq \underline{E}_{i,j} + \underline{P}_{i,j} + \bar{P}_{i,j} + \bar{z}_{i,j} + \widehat{u}_{i,j}(\underline{S}_{i,j}) - \widehat{l}_{i,j}(\bar{S}_{i,j}) < T \quad (300)$$

thus $k_{i,j} = 0$. \square

K Proof of Theorem 4

We start with the following property, which gives $\mathcal{S}_{\text{cor1}}^{o_i, o_j}$ and $\underline{\mathcal{S}}_{\text{cor1}}^{o_i, o_j}$ in closed-form. Observe that $U'_{i,j}$ and $L'_{i,j}$ can be written as

$$U'_{i,j}(S) = -S + U_{i,j}^o \quad (301)$$

$$L'_{i,j}(S) = S + L_{i,j}^o \quad (302)$$

where $U_{i,j}^o, L_{i,j}^o$ depend on o_i, o_j but not on S .

Property 10. Assume that the set $\mathcal{S}_{\text{cor1}}^{o_i, o_j}$ of values of S that are admissible according to Corollary 1 applied to link (i, j) is not empty. Let $k = \left\lfloor \frac{U'_{i,j}(\bar{S})}{T} \right\rfloor$, $S'_{i,j} = U_{i,j}^o - (k+1)T$ and $S''_{i,j} = L_{i,j}^o + kT$. Then

- $\underline{S}_{\text{cor1}}^{o_i, o_j} = \max(S'_{i,j}, S''_{i,j})$,
- If $S'_{i,j} < S''_{i,j}$ then $\mathcal{S}_{\text{cor1}}^{o_i, o_j} = [S''_{i,j}, \bar{S}]$ else $\mathcal{S}_{\text{cor1}}^{o_i, o_j} = (S'_{i,j}, \bar{S}]$.

Proof. Since $\mathcal{S}_{\text{cor1}}^{o_i, o_j}$ is non-empty, by Theorem 2, we know that $\bar{S} \in \mathcal{S}_{\text{cor1}}^{o_i, o_j}$. Thus

$$k = \left\lfloor \frac{U'_{i,j}(\bar{S})}{T} \right\rfloor = \left\lfloor \frac{L'_{i,j}(\bar{S})}{T} \right\rfloor \quad (303)$$

Combining with (301) and (302) we obtain that, for $S \in [0, \bar{S}]$:

$$\left\lfloor \frac{U'_{i,j}(S)}{T} \right\rfloor = k \Leftrightarrow S'_{i,j} < S \leq \bar{S} \quad (304)$$

and

$$\left\lfloor \frac{L'_{i,j}(S)}{T} \right\rfloor = k \Leftrightarrow S''_{i,j} \leq S \leq \bar{S} \quad (305)$$

Furthermore $U'_{i,j}$ is decreasing and $L'_{i,j}$ is decreasing thus

$$\left(\left\lfloor \frac{L'_{i,j}(S)}{T} \right\rfloor = \left\lfloor \frac{L'_{i,j}(S)}{T} \right\rfloor \right) \Leftrightarrow \left(\left\lfloor \frac{L'_{i,j}(S)}{T} \right\rfloor = \left\lfloor \frac{L'_{i,j}(S)}{T} \right\rfloor = k \right) \quad (306)$$

Therefore

$$\mathcal{S}_{\text{cor1}}^{o_i, o_j} = (S'_{i,j}, \bar{S}] \cap [S''_{i,j}, \bar{S}] \quad (307)$$

The two bullets of the property follow immediately. \square

Proof of Theorem 4. Let $\mathcal{S}_{i,j}^o$ be the set of $S \in [0, \bar{S}]$ that satisfy the constraints corresponding to i, j in Problem $P - \text{MILP}$, i.e. such that

$$\exists k_{i,j} \in \mathbb{Z}, k_{i,j} \leq \frac{L'_{i,j}(S)}{T}, \frac{U'_{i,j}(S)}{T} \leq k_{i,j} + 1 - \frac{\varepsilon}{T} \quad (308)$$

and let

$$S_{i,j}^o = \min(\mathcal{S}_{i,j}^o) \quad (309)$$

It follows that

$$S_{\text{MILP}} = \min_{o \in [0, \bar{S}]^L} \max_{(i,j) \in \mathcal{L}} S_{i,j}^o \quad (310)$$

Observe that we also have

$$\underline{S} = \min_{o \in [0, \bar{S}]^L} \max_{(i,j) \in \mathcal{L}} \underline{S}_{\text{cor1}}^{o_i, o_j} \quad (311)$$

We now compare $S_{i,j}^o$ to $\underline{S}_{\text{cor1}}^{o_i, o_j}$. With the same notation as in the proof of Lemma 10, we obtain

$$S_{i,j}^o = \max(S_{i,j}'', S_{i,j}' + \varepsilon) \quad (312)$$

Combining with the first bullet of Property 10, it follows that

$$\underline{S}_{\text{cor1}}^{o_i, o_j} \leq S_{i,j}^o \leq \underline{S}_{\text{cor1}}^{o_i, o_j} + \varepsilon \quad (313)$$

Using (310) and (311) we obtain

$$\underline{S} \leq S_{\text{MILP}} \leq \underline{S} + \varepsilon \quad (314)$$

□